



NATIONAL AERONAUTICS AND SPACE ADMINISTRATION

FINAL

# \* APOLLO 12 LUNAR SURFACE OPERATIONS PLAN

PREPARED BY

LUNAR SURFACE OPERATIONS OFFICE  
MISSION OPERATIONS BRANCH  
FLIGHT CREW SUPPORT DIVISION

OCTOBER 23, 1969



MANNED SPACECRAFT CENTER  
HOUSTON, TEXAS

INDEXING DATA

DATE	OPR	#	T	PGM	SUBJECT	SIGNATOR	LOC
10-23-69	MSC	00	R	AP0	*	ROBERTS	079-14

HSI-209398

FINAL EDITION

APOLLO 12

LUNAR SURFACE OPERATIONS PLAN

OCTOBER 23, 1969

Prepared by: *Joe H. Roberts*  
J. H. Roberts  
Lunar Surface Operations Office

Approved by: *Raymond J. Zedekar*  
R. J. Zedekar  
Lunar Surface Operations Office

*Helmut Kuehnel*  
H. A. Kuehnel  
Chief, Mission Operations Branch

*C. H. Woodling*  
C. H. Woodling  
Assistant Chief for Crew Training

*W. J. North*  
W. J. North  
Chief, Flight Crew Support Division

*Donald K. Slayton*  
Donald K. Slayton  
Director of Flight Crew Operations

APOLLO 12

LUNAR SURFACE OPERATIONS PLAN

(FINAL EDITION)

PREFACE

This document has been prepared by the Flight Crew Support Division, Flight Crew Operations Directorate, Manned Spacecraft Center, Houston, Texas. The information contained within this document represents the Lunar Surface Operations Plan for Apollo 12, the second planned lunar landing mission.

This is the final edition of the Apollo 12 Lunar Surface Operations Plan. The plan is under the configuration control of the Crew Procedures Control Board (CPCB) and all proposed changes to this document should be submitted to the CPCB via a Crew Procedures Change Request. Changes and comments to the document should be directed to J. H. Roberts, Lunar Surface Operations Office, FCSD.

## CONTENTS

	Page
Preface	
List of Figures and Tables	
1.0 INTRODUCTION	1
2.0 MISSION PLAN	2
2.1 Mission Purpose	2
2.2 Mission Description	2
2.3 Summary of Mission Requirements	5
2.3.1 Introduction	5
2.3.2 Mission Objectives and Experiments	6
3.0 NOMINAL LUNAR SURFACE EXTRAVEHICULAR ACTIVITY	7
3.1 Lunar Surface Stay	7
3.2 Extravehicular Activity	7
3.2.1 EVA 1 Timeline Description and Rationale	7
3.2.2 EVA 1 Detailed Procedures	31
3.2.3 EVA 2 Timeline Description and Rationale	52
3.2.4 EVA 2 Detailed Procedures	66
4.0 CONTINGENCY PLANS	82
4.1 Description and Rationale	82
4.2 Contingent EVA 1 and EVA 2 - One Man	83
4.2.1 Description and Rationale	83
4.3 Contingent EVA 1 - Minimum Time, One Man	98
4.3.1 Description and Rationale	98
4.4 Timeline Guide	103
4.4.1 Description and Rationale	103
5.0 APPENDIX	
5.1 Abbreviations	115
5.2 Lunar Surface Operational Constraints	117
5.2.1 Introduction	117
5.2.2 Constraints Classification	117
5.2.2.1 Constraint Categories	117
5.2.2.2 Violation Classification	118
5.2.3 Mission Operations Constraints	118
5.2.4 Lunar Surface Operations Constraints	118
5.2.5 Equipment Operation Constraints	120
5.2.6 Equipment Design Constraints	124
5.2.7 General Constraints	124
5.3 ALSEP and Scientific Equipment Contingency Procedures	125
5.4 Nominal Lunar Surface EVA Metabolic Profiles	149
5.4.1 Introduction	149
5.4.2 EVA 1	149
5.4.3 EVA 2	154
5.5 References	159

## FIGURES

Figure Number	Title	Page
3-1	Color TV Field Of View From Tripod	10
3-1a	TV Field Of View From MESA (Black & White TV)	8
3-2	Probable Areas For EVA 1 Lunar Surface Activity	13
3-3	Summary Timeline - Nominal Lunar Surface EVA 1	14
3-4	Nominal Timeline - Lunar Surface EVA 1	15
3-5	Four Hour Nominal Timeline - Lunar Surface EVA 1	26
3-6	Summary Timeline - Nominal Lunar Surface EVA 2	54
3-7	Nominal Timeline - Lunar Surface EVA 2	55
3-8	LMP Contrast Chart Photos	69
3-9	CDR Polarizing Filter Photos	71
3-10	Surveyor Investigation Activities	75
4-1	Summary Timeline - Contingency EVA 1 - One Man	84
4-2	One Man Contingency Timeline - Lunar Surface EVA 1	85
4-3	Four Hour One Man Contingency Timeline - Lunar Surface EVA 1	91
4-4	Summary Timeline - Contingency EVA 2 - One Man	93
4-5	One Man Contingency Timeline - Lunar Surface EVA 2	94
4-6	Summary Timeline - Contingent EVA 1, Minimum Time - One Man	99
4-7	One Man Contingency Timeline - Minimum Time Lunar Surface EVA	100
4-8	Timeline A - Contingency 30 Minute EVA Closeout	109
4-9	Timeline B - Contingency 42 Minute EVA Closeout	111
4-10	Timeline C - Contingency Rapid (13 Minute) EVA Closeout	114

		Page
	TABLES	
3-1	Performance Margins For LM Communications	111
4-1	Timeline Guide	104

SECTION 1.0

INTRODUCTION

## 1.0 INTRODUCTION

This final edition of the Lunar Surface Operations Plan defines crew/equipment interfaces and final flight planning and crew activities for lunar surface EVA operations during the second manned lunar landing mission.

This plan delineates how the lunar surface operational and scientific objectives for the second manned lunar landing mission will be accomplished through pre-mission timelining and procedures definition. Although the primary concern of this document is the lunar surface EVA operational aspects of the mission, interface relationships are presented to provide clarity and continuity to the overall mission plan.

The nominal plan is for two two-man lunar excursions. The planned durations will be three hours and thirty minutes each or upon reaching a pre-determined red line on one of the PLSS consumables. The red line is defined as having either a 30 minute supply of oxygen or a 30 minute supply of feedwater remaining after repressurization. The battery is not considered to be a constraint on the lunar surface time for this mission. Based on an estimation of each crewman's BTU expenditure to accomplish his respective EVA tasks, a PLSS expendable red line should not be reached during either EVA. The Commander is expected to expend approximately 4081 BTU's which will leave a 719 BTU PLSS reserve or approximately 31 minutes Lunar surface time for the first EVA, and expend 4235 BTU's with a 565 BTU reserve or 24 minutes for the second EVA. (Metabolic profiles are presented in the Appendix, Section 5.4).

In addition to the nominal EVA 1 and EVA 2 timelines and extension of these nominal timelines to 4 hours, the plan presents six contingent timelines for the lunar EVA. Three of the contingent timelines are for one man EVA's, two complete EVA 1 and EVA 2 and one minimum time (50 minute) EVA 1. The other three are for contracted EVA close-out times of 42 minutes, 30 minutes and 13 minutes.

The plan presents two forms of timelines. One is a horizontal summary form. The other is in a one minute time incremented vertical format.

Detailed procedures are included for the nominal lunar EVA's, 1 and 2. For the contingent EVA's, the timelines present the procedures in sufficient detail that, with an understanding or reference to the nominal procedures, separate procedures are unnecessary.



SECTION 2.0

MISSION PLAN

## 2.0 MISSION PLAN

### 2.1 Mission Purpose

The primary purpose of the Apollo 12 mission is to investigate the lunar surface environment, to obtain lunar material samples, to emplace ALSEP I and to enhance the capability for manned lunar exploration. A secondary objective is to examine the Surveyor III spacecraft and collect selected Surveyor III site samples.

### 2.2 Mission Description

This section provides a brief summary of the major events for a November 14, 1969 launch date.

The countdown will allow a launch using flight azimuth limits of 72 to 96 degrees with a window opening at TBD (HR:MIN:SEC) for a duration of TBD. The launch vehicle will place the spacecraft with three crewmen aboard into a 100 NM circular earth parking orbit. Launch vehicle and spacecraft checkout will be accomplished in this orbit.

#### Translunar Injection (TLI):

The launch vehicle S-IVB stage will be reignited during the second revolution of the earth parking orbit. The nominal injection shall provide a free return to earth.

#### Translunar Coast:

CSM Transposition/Docking and LM/CSM Separation from the S-IVB will be achieved within two hours after TLI. An evasive maneuver will be performed by the S-IVB after LM ejection.

The SPS may be utilized to depart from a free return trajectory within the limits of the DPS to return the CSM/LM to safe entry conditions.

#### Lunar Orbit Insertion:

The SPS will be used to insert the spacecraft into lunar orbit. Following the initial insertion burn, the spacecraft orbit will be approximately 60 by 170 NM. A second burn will be made to circularize the orbit at 60 NM.

### Lunar Module Descent:

Two astronauts will enter the LM and perform LM checkout. The CSM will be separated from the LM using the SM RCS. The LM DPS will be used for the descent to the surface. Landing point redesignation may be exercised during descent at the crew's discretion to land near the Surveyor III spacecraft.

For the November 14 launch, the lunar landing will be at site 7 (previously designated Surveyor III) located at 2.94° South, 23.34° West. At the time of landing, the sun elevation referenced to local horizontal at the landing site will be between 5 and 13 degrees.

### Lunar Surface Operations:

The stay time on the lunar surface will not exceed 32 hours. After checkout of the LM to assess its launch capability, the LM will be depressurized to allow egress to the surface. The nominal plan will provide for two periods of approximately three hours and thirty minutes each for simultaneous EVA by both astronauts. The radius of operations is constrained to be within the limits imposed by the purge capability of the oxygen purge system. The planned lunar surface activities will include the following major items in order of priority:

- 1) Photography through the LM cabin window.
- 2) Contingency sample
- 3) EVA evaluation
- 4) LM inspection
- 5) Deployment of experiments
- 6) Selected sample collection
- 7) Lunar field geology

Television transmission will be provided as early as practicable during the EVA period.

Photography will be employed throughout the EVA to document the activities and observations.

### Lunar Module Ascent:

Powered ascent will be accomplished using the APS and insertion conditions will be such that the LM will be in a 9 by 45 NM elliptical orbit. The powered ascent will nominally be coplanar as a result of the CSM executing the appropriate plane change maneuver during the LM lunar stay. Subsequent LM maneuvers will be made using the LM RCS.

After docking, both LM crewmen will transfer to the CSM with the lunar surface samples and the exposed film. The LM will be jettisoned by the CSM using the SM RCS.

Transearch Injection:

The SPS will be used to boost the CSM out of lunar orbit. The nominal return flight will not exceed 110 hours and the return inclination will not exceed 40 degrees (relative to the earth's equator).

Entry and Recovery:

Prior to atmospheric entry the CM will be separated from the SM using the SM RCS. The nominal range from 400,000 feet altitude to touchdown will be 1250 NM.

Earth touchdown will be in the Pacific within +35 degrees latitude and will occur within 11 days after launch from earth.

Post Landing Operations:

Following splashdown, the crew will egress the CM after the flotation collar has been attached, don Biological Isolation Garments, transfer to the recovery ship by helicopter and immediately enter the Mobile Quarantine Facility (MQF). They will be transported in the MQF to the Lunar Receiving Laboratory (LRL) at MSC. The CM, sample return containers, film, tapes and astronaut logs will also be transported to the LRL.

In order to minimize the risk of contamination of the earth's biosphere by lunar material, quarantine measures will be enforced. The crew will be quarantined for approximately 21 days after liftoff from the lunar surface. In addition, the CM will be quarantined after splashdown. Termination of the CM quarantine period will depend on the results of the lunar sample analysis and observations of the crew.

## 2.3 Summary of Mission Requirements

### 2.3.1 Introduction

The following information is from the "Mission Requirements SA-507/CSM-108/LM-6 H-1 type mission, Lunar Landing", dated July 18, 1969 (Revised September 16, 1969).

The following primary mission objectives have been assigned to this mission by the Office of Manned Space Flight (OMSF)

- 1) Perform selenological inspection, survey and sampling in a mare area.
- 2) Deploy ALSEP consistent with a seismic net.
- 3) Develop techniques for a point landing capability.
- 4) Develop man's capability to work in the lunar environment.

The following experiments have been assigned to this mission by OMSF (Reference 1).

- 1) S-059 Lunar Field Geology
- 2) S-031 Passive Seismic Experiment
- 3) S-034 Lunar Surface Magnetometer Experiment
- 4) S-035 Solar Wind Spectrometer Experiment
- 5) S-036 Suprathermal Ion Detector Experiment
- 6) S-058 Cold Cathode Ion Gauge Experiment
- 7) M-515 Lunar Dust Detector Experiment (Approval by OMSF is pending)
- 8) S-080 Solar Wind Composition
- 9) T-029 Pilot Describing Function
- 10) S-158 Lunar Multispectral Photography Experiment (Approval by OMSF is pending)

Experiments 2) through 7) are part of the ALSEP I package.

Detailed objectives have been derived from the OMSF assigned primary objectives, placed in order of priority, and detailed to the extent necessary for mission planning. All of the detailed objectives are in support of the primary mission objectives with the exception of secondary objectives Surveyor III Investigation, Photographic Coverage and Television Coverage.

Experiments are detailed and assigned priority only in the event that they require crew action or otherwise impact the mission time-line. Passive experiment(s) such as T-029 (Pilot Describing Function) will not appear in the priority list.

SECTION 3.0

NOMINAL LUNAR EVA

### 2.3.2 Mission Objectives and Experiments

The detailed objectives and experiments are listed below in their order of priority. These priorities should be used for real time mission planning.

The Photographic Coverage and Television Coverage objectives will be performed in conjunction with several of the other objectives. The associated operations will take place at various points in the timeline. Hence, these two objectives cannot be assigned any specific priority in the list below and are therefore included at the end.

<u>Priority</u>		<u>Detailed Objectives and Experiments</u>
1	A.	Contingency Sample Collection
2	B.	Lunar Surface EVA Operations
3	ALSEP I	Apollo Lunar Surface Experiments Package
4	F.	Selected Sample Collection
5	C.	PLSS Recharge
6	S-059	Lunar Field Geology
7	G.	Photographs of Candidate Exploration Sites
8	H.	Lunar Surface Characteristics
9	I.	Lunar Environment Visibility
10	J.	Landed LM Location
11	S-080	Solar Wind Composition
12	S-158	Lunar Multispectral Photography
13	N.	Surveyor III Investigation
-	L.	Photographic Coverage
-	M.	Television Coverage

### 3.0 NOMINAL LUNAR SURFACE EXTRAVEHICULAR ACTIVITY

#### 3.1 Lunar Surface Stay

The nominal plan is for two crewmen, the Commander (CDR) and the Lunar Module Pilot (LMP), to remain on the lunar surface for approximately 31.5 hours. During this time, the crew will accomplish postlanding and pre-ascent procedures and two periods of extravehicular activity (EVA). There will be one rest period of approximately 9 hours between EVA's and several eat periods.

#### 3.2 Extravehicular Activity

##### 3.2.1 EVA 1 Timeline Description and Rationale

The first EVA period is designed to maximize the return of scientific and operational data. However, the timeline permits rest periods and a gradual increase in task complexity with simple tasks initially for crew acclimation and PLSS-EMU data analysis.

There will be two major areas of evaluation during EVA 1. The first area is comprehensive crew familiarization and evaluation of EVA capability and the lunar environment. The investigation will be a methodical approach which will enhance the accomplishment of both EVA's as well as provide further astronaut and equipment capability (in addition to Apollo 11 experience) for future lunar surface exploration. The second area is the collection of operational and scientific data, provided mainly by the deployment of the ALSEP. The analysis of this data will increase our understanding of the lunar surface as well as assist in the update of future equipment designs.

The following is a narrative description of the CDR and LMP activities during EVA 1. See Figures 3-3, 3-4, and 3-5 for detailed timeline data.

The CDR will descend to the surface first, with the LMP remaining inside the LM ascent stage to monitor the CDR's surface activity and the LM systems in the depressurized state, and to assist the CDR in equipment transfer bag (ETB) transfers. The CDR will conduct several preliminary tasks on the lunar surface. He will determine his ability to operate in the lunar environment, collect a contingency lunar sample and check the LM and the lunar surface conditions which affect the accomplishment of the EVA tasks. In addition to the TV coverage, (See Figure 3-1a) and still photo-



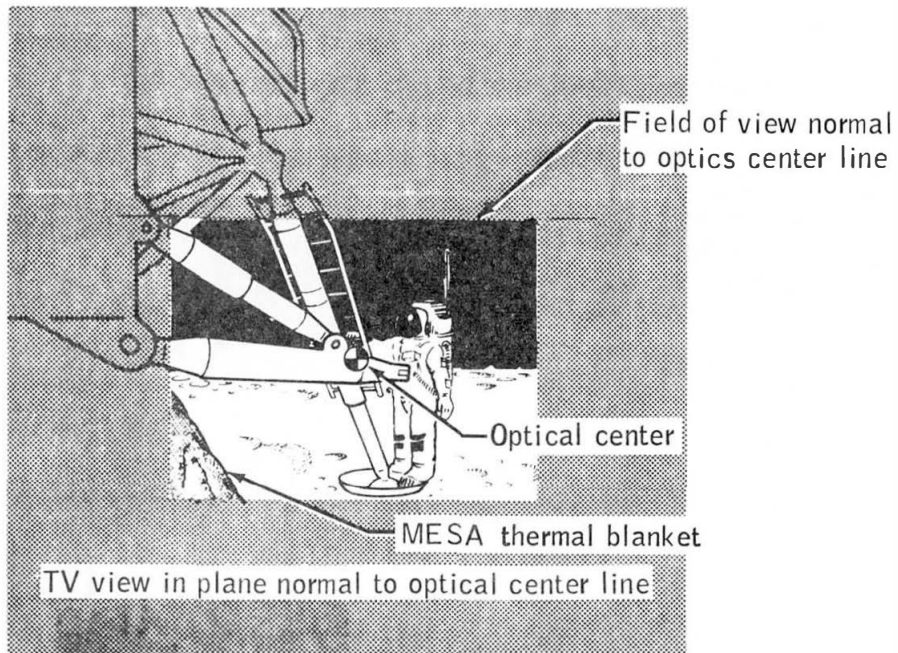
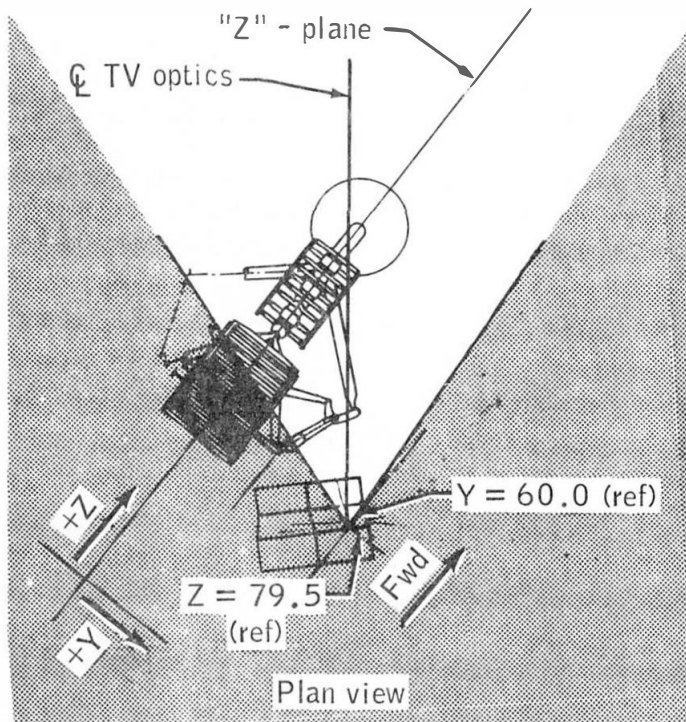

Figure 3-1a TV (Black & White) field of view from MESA.

graphs, the LMP will visually observe and obtain sequence camera (data acquisition) coverage to supplement the documentation of the CDR activity. After this initial familiarization activity, the CDR will remove the thermal cover from the modularized equipment storage assembly (MESA) and erect the MESA table. He will attach the ETB to the MESA table and remove and place its contents on the MESA table. He will then remove the PLSS batteries and LiOH canisters from the MESA and pack them and the contingency sample in the ETB. After attaching the ETB to the lunar equipment conveyor (LEC) he will transfer it into the LM with the LMP's assistance. The LMP will stow the ETB contents in the LM and pack the 70mm cameras in the ETB for transfer to the lunar surface. The CDR will attach the ETB to the MESA and remove his 70mm camera and photo the LMP's egress from the LM.

With only one crewman on the surface during the first few minutes of the EVA, a more effective PLSS telemetry data analysis can be conducted. The real time use rate for the PLSS consumables will be compared with the predicted rate to determine the PLSS capability for EVA continuation.

The LMP will egress from the LM approximately 29 minutes after the CDR. He will spend a few minutes in familiarization and evaluation of his capability or limitations to conduct further operations in the lunar environment. After this short period, he will remove the TV camera and tripod from the MESA and position it to view the MESA and S-Band antenna deployment area (See Figure 3-1). The CDR will remove the S-Band antenna from the LM descent stage, after his photography of the LMP, and deploy and align it on the lunar surface.

While the CDR finishes deploying the S-Band antenna, the LMP will deploy the Solar Wind Composition (SWC) experiment. After the CDR deploys the S-Band antenna, he and the LMP will unstow and deploy the U. S. flag in view of the TV camera. The LMP will then begin his LM inspection and photography activity by repositioning the TV to view the LM Scientific Equipment Bay (SEQ Bay) and traverse clockwise around the LM for his inspection. The CDR will place the Apollo Lunar Surface Close-up Camera (ALSCC) on the surface in the sunlight and begin his panorama photography in front of the LM. He will also traverse clockwise around the LM and end up, with the LMP, in front of the SEQ Bay.

The CDR will remove Apollo Lunar Surface Equipment Package (ALSEP) package #1 from the SEQ Bay, and the LMP will remove package #2, position it for Radioisotope Thermoelectric Generator (RTG) fueling and remove the Apollo Lunar Hand Tool Carrier (ALHTC).

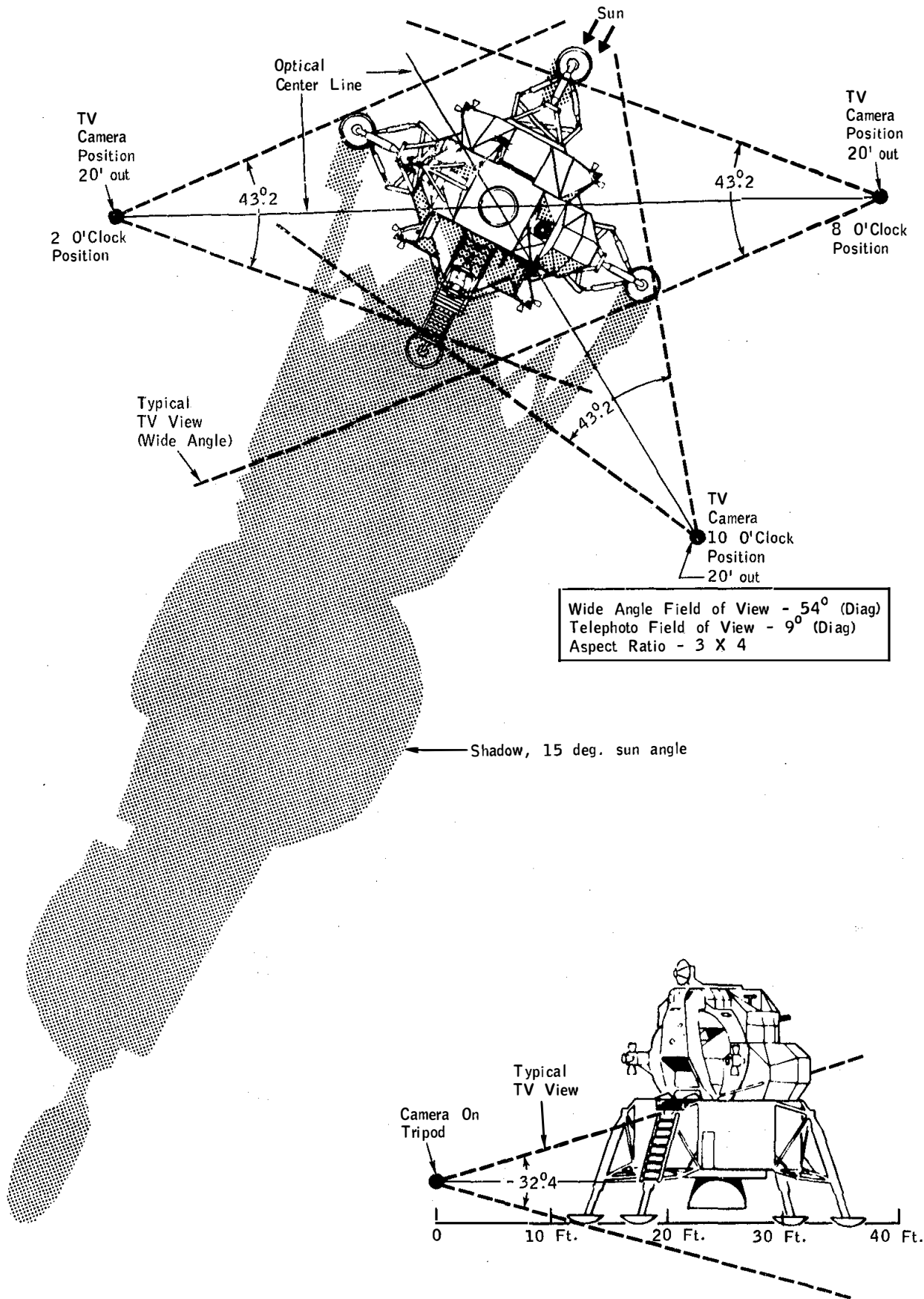

FIGURE 3-1 - COLOR TV FIELD OF VIEW FROM TRIPOD

TABLE 3-1

## PERFORMANCE MARGINS FOR LM COMMUNICATIONS\*

(FM Mode - High Power)

	85' MSFN STATION		210' MARS STATION	
	<u>NOMINAL</u>	<u>WORST CASE</u>	<u>NOMINAL</u>	<u>WORST CASE</u>
<u>Erectable Antenna</u>				
51.2 kbps Telemetry**	+ 8.8 dB	+ 6.8 dB	+16.8 dB	+14.8 dB
EVA Voice (dual)	+ 9.2	+ 7.2	+17.2	+15.2
EVA EKG & PLSS Data (dual)	+ 3.8	+ 1.8	+11.8	+ 9.8
Television (B&W)	+ 9.7	+ 7.7	+17.7	+15.7
1.6 kbps Telemetry**	+17.4	+15.4	+25.4	+23.4
EVA Voice (dual)	+ 9.2	+ 7.2	+17.2	+15.2
EVA EKG & PLSS Data (dual)	+ 3.8	+ 1.8	+11.8	+ 9.8
Television (B&W)	+ 9.7	+ 7.7	+17.7	+15.7
<u>Steerable Antenna</u>				
51.2 kbps Telemetry**	+ 0.7	- 1.5	+ 8.7	+ 6.5
EVA Voice (dual)	+ 1.1	- 1.1	+ 9.1	+ 6.9
EVA EKG & PLSS Data (dual)	- 4.3	- 6.5	+ 3.7	+ 1.5
Television (B&W)	+ 1.6	- 0.6	+ 9.6	+ 7.4
1.6 kbps Telemetry**	+ 9.3	+ 7.1	+17.3	+15.1
EVA Voice (dual)	+ 1.1	- 1.1	+ 9.1	+ 6.9
EVA EKG & PLSS Data (dual)	- 4.3	- 6.5	+ 3.7	+ 1.5
Television (B&W)	+ 1.6	- 0.6	+ 9.6	+ 7.4

\* Based on measured LM-5 data and MSC test data on new (1969) Motorola FM demodulator. The MSC tests were conducted in the ISD Electronic Systems Test Facility (on one unit).

\*\* For a BER of  $10^{-4}$ .

The LMP will then deploy the RTG fuel cask mounted beside the SEQ Bay, remove the RTG fuel element and fuel the RTG. While the LMP is fueling the RTG, the CDR will tip ALSEP package #1, remove the Superthermal Ion Detector Experiment (SIDE) subpallet and position the ALHTC near the MESA. After fueling the RTG the LMP will attach the carry bar to both ALSEP packages. Then the CDR and LMP will traverse to the ALSEP deployment site, approximately 300 feet west of the LM. The CDR will reposition the TV to view the ALSEP site as he begins his traverse (See Figure 3-2). The LMP will carry both ALSEP packages, the CDR will carry the SIDE subpallet and the tongs.

After deploying and photographing the ALSEP, the CDR and LMP will return to the LM collecting selected geological samples. These samples will be stowed in bags attached to the side of their EMU. On return to the LM, the CDR will remove his camera, place the Sample Return Container (SRC) #1 on the MESA and unstow its contents. The LMP will reposition the TV to view the MESA and remove his side bag for stowage in the SRC. He will then obtain a core tube geological sample, photograph it, and place it in the SRC. The CDR will pack the side bags with their geological samples in the SRC and close and seal the SRC.

After cleaning his EMU, the LMP will ingress the LM and perform a brief LM systems and communications check. He will then assist the CDR with the transfer of the ETB (containing both 70mm cameras) and the SRC #1 into the LM. After these equipment transfers, the CDR will remove SRC #2 from the MESA and stow it on the +Y footpad in the sunlight. He will then clean his EMU and ingress the LM, terminating EVA 1.

A GO-NO GO for extension of EVA 1 to 4 hours will be given the crew on their return to the LM from deploying the ALSEP. This decision will be based on PLSS consumables data. The additional 30 minutes will be utilized to perform a small documented geological sample collection period (See Figures 3-3 and 3-5). Upon return to the LM, the CDR will unstow and pack the SRC #1 as previously mentioned, however, he will not close and seal it. The LMP will obtain a core tube sample as previously mentioned and upon completion of this task, he will load the lunar hand tools in the ALHTC. The CDR will carry the tongs and the LMP will carry the ALHTC. The LMP will also reposition the TV to view the sample collection area. The technique for collecting the documented samples is discussed in the next section on EVA 2 (See Figure 3-6). Upon completion of this sample collection period, the crewmen will return to the LM, the LMP will begin his EVA termination and ingress the LM, and the CDR will pack the documented samples in the SRC and close it out. The remainder of the EVA, the LEC transfers and the CDR EVA termination, will be as previously mentioned in the 3.5 hour EVA period above.

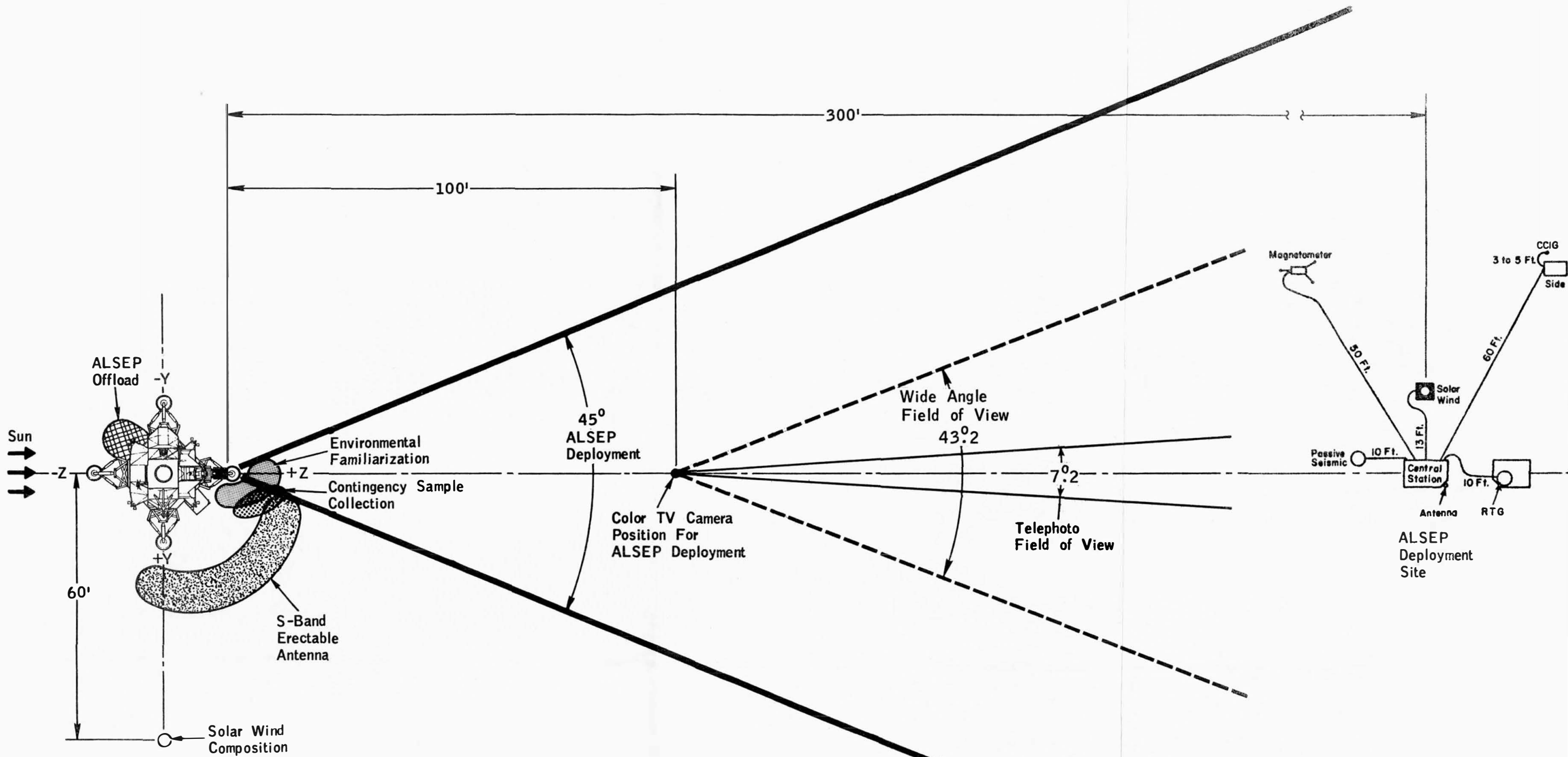

NOTE: The Selected Geological Sample collection will be obtained on the Return Traverse from the ALSEP Deployment Site.

Scale 0 5' 10' 15' 20'

FIGURE 3-2 - PROBABLE AREAS FOR EVA 1 LUNAR SURFACE ACTIVITY

FIGURE 3-3 APOLLO 12 SUMMARY TIMELINE  
NOMINAL LUNAR SURFACE EVA 1

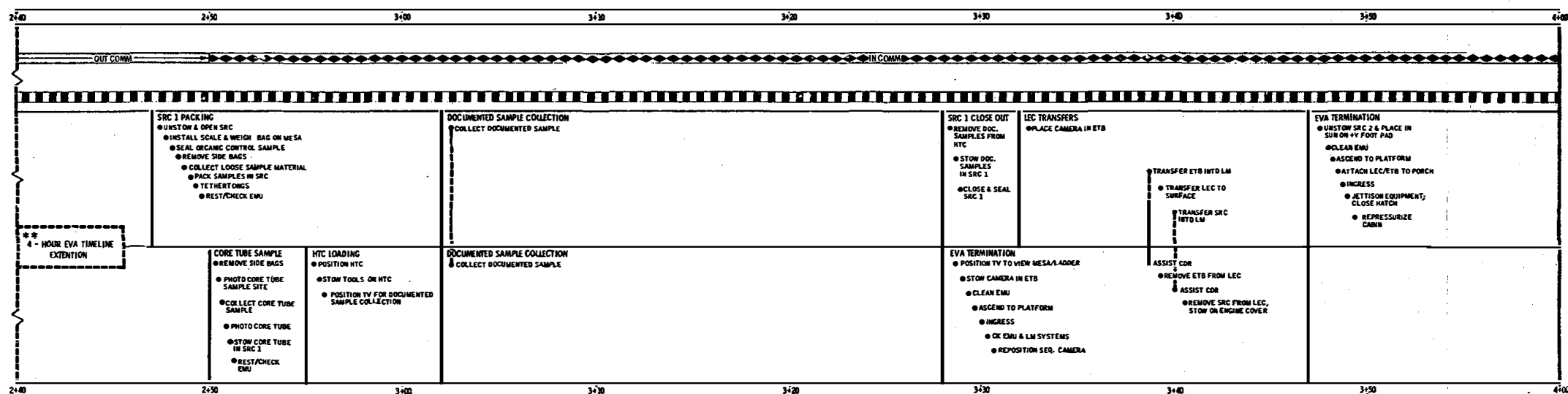
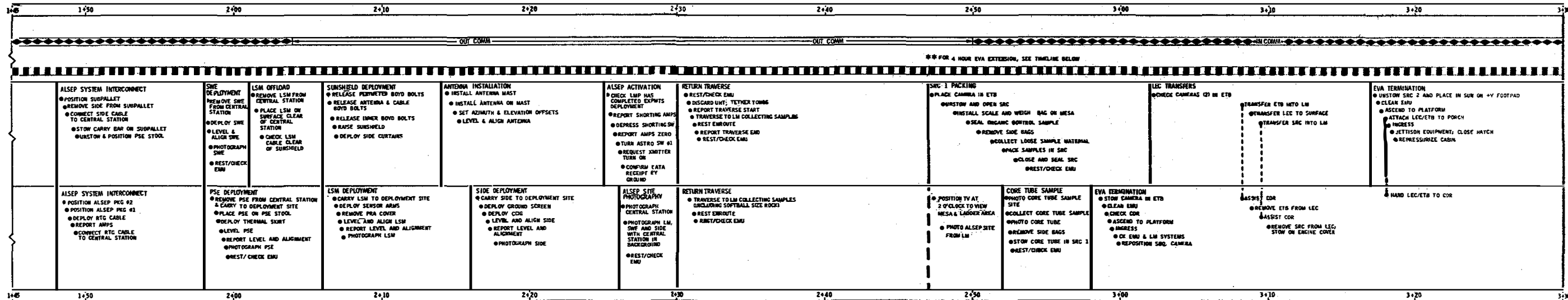
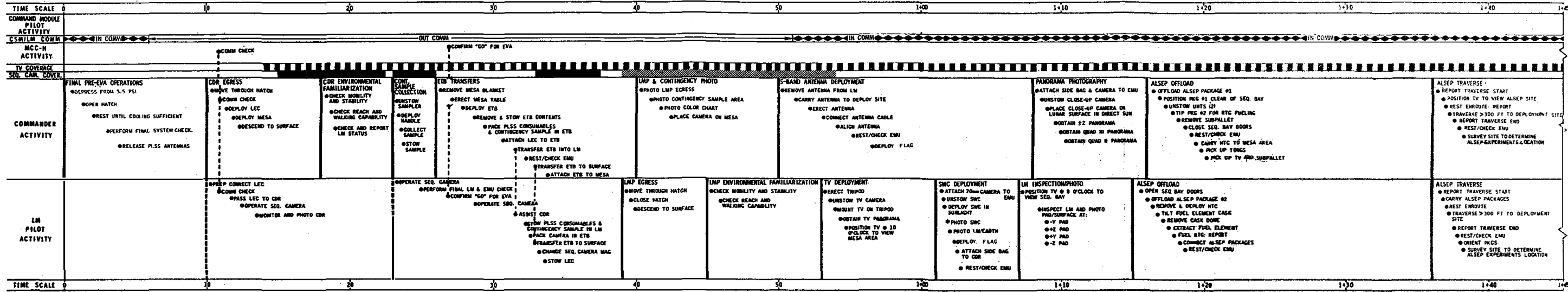

**LEGEND**

- EVENT LINE
- SEPARATES MAG. BLOCKS OF ACTIVITY
- COORDINATED TASKS
- SEQUENCE CAMERA COVERAGE
  - 1 FRAME/SEC
  - 12 FRAME/SEC
  - NO COVERAGE
- TV COVERAGE
  - COVERAGE
  - NO COVERAGE

NOTE: ACTIVITY TIMES WITHIN AN EVENT NOT FIXED.

NAME	INITIAL	ORIGIN	NATIONAL AERONAUTICS & SPACE ADMINISTRATION
T. W. MONTGOMERY	TW	1968	HOUSTON, TEXAS
APOLLO 12 SUMMARY TIMELINE			
NOMINAL LUNAR SURFACE EVA 1			
FIGURE 3-3			
DR. W. N. HALL	GC		BASIC OCTOBER 69

FIGURE 3-4  
 APOLLO TWELVE  
 MISSION H-1  
**NOMINAL TIMELINE**  
**LUNAR SURFACE EVA 1**

**CDR ACTIVITIES**

**LMP ACTIVITIES**

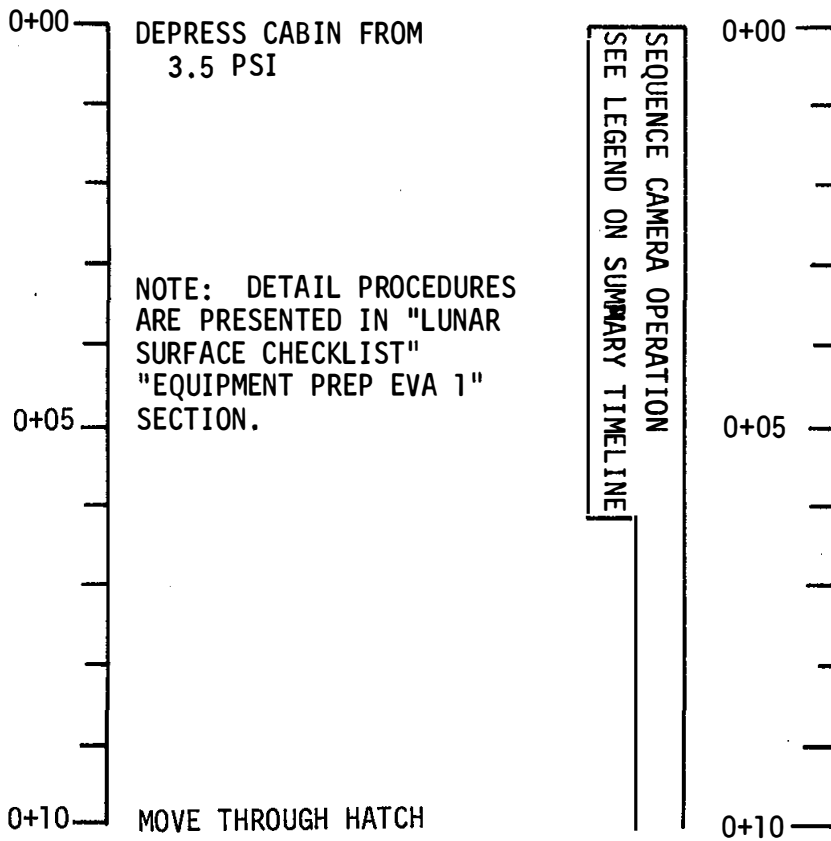



## CDR ACTIVITIES

## LMP ACTIVITIES

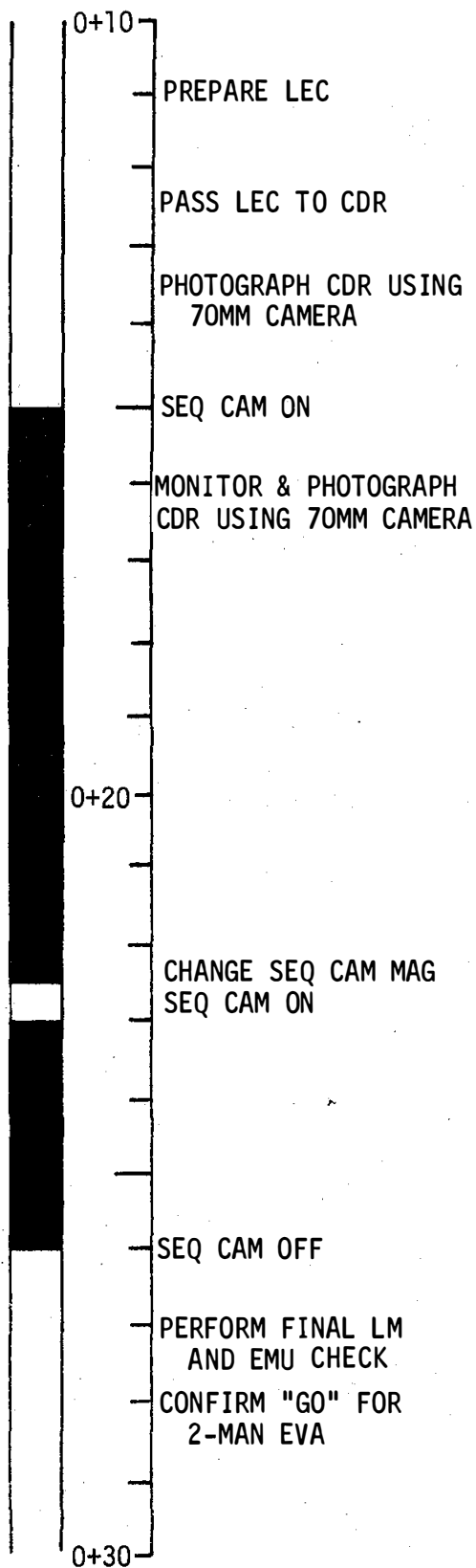
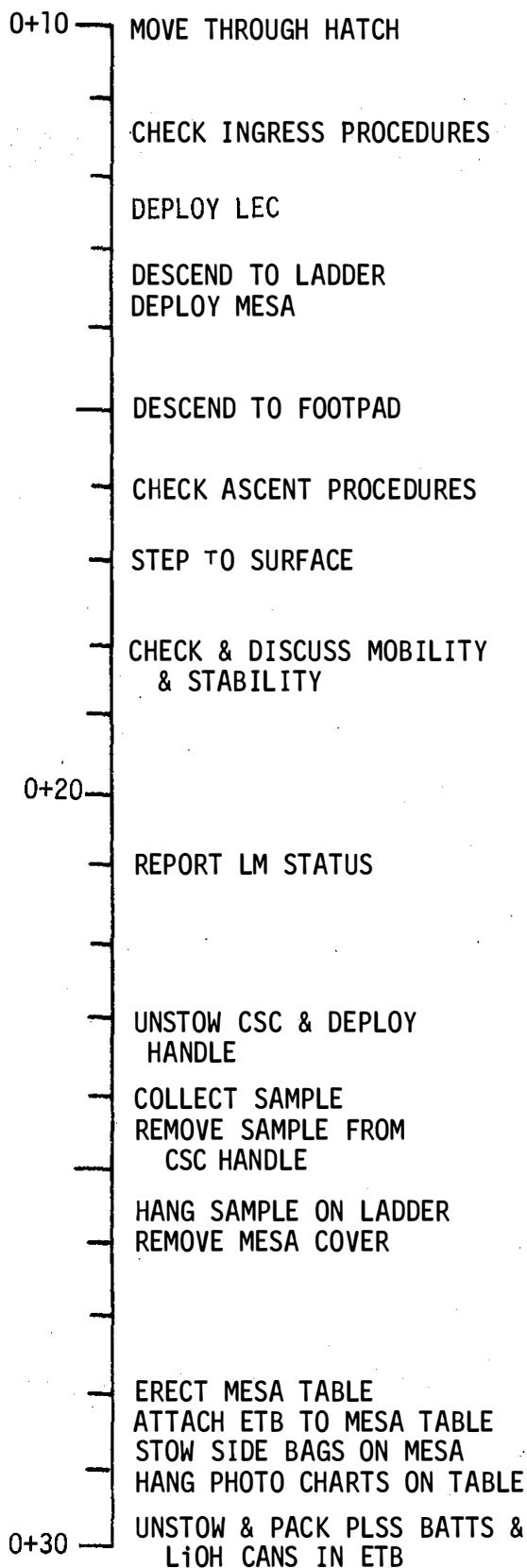

## CDR ACTIVITIES

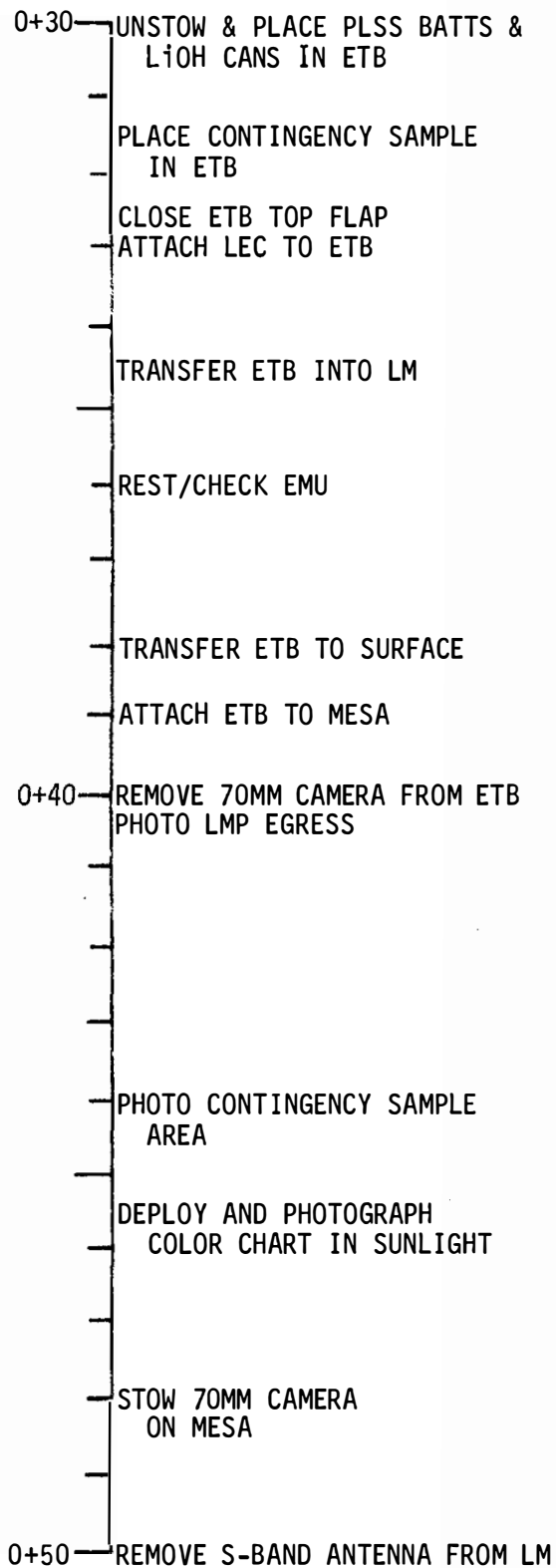

## LMP ACTIVITIES

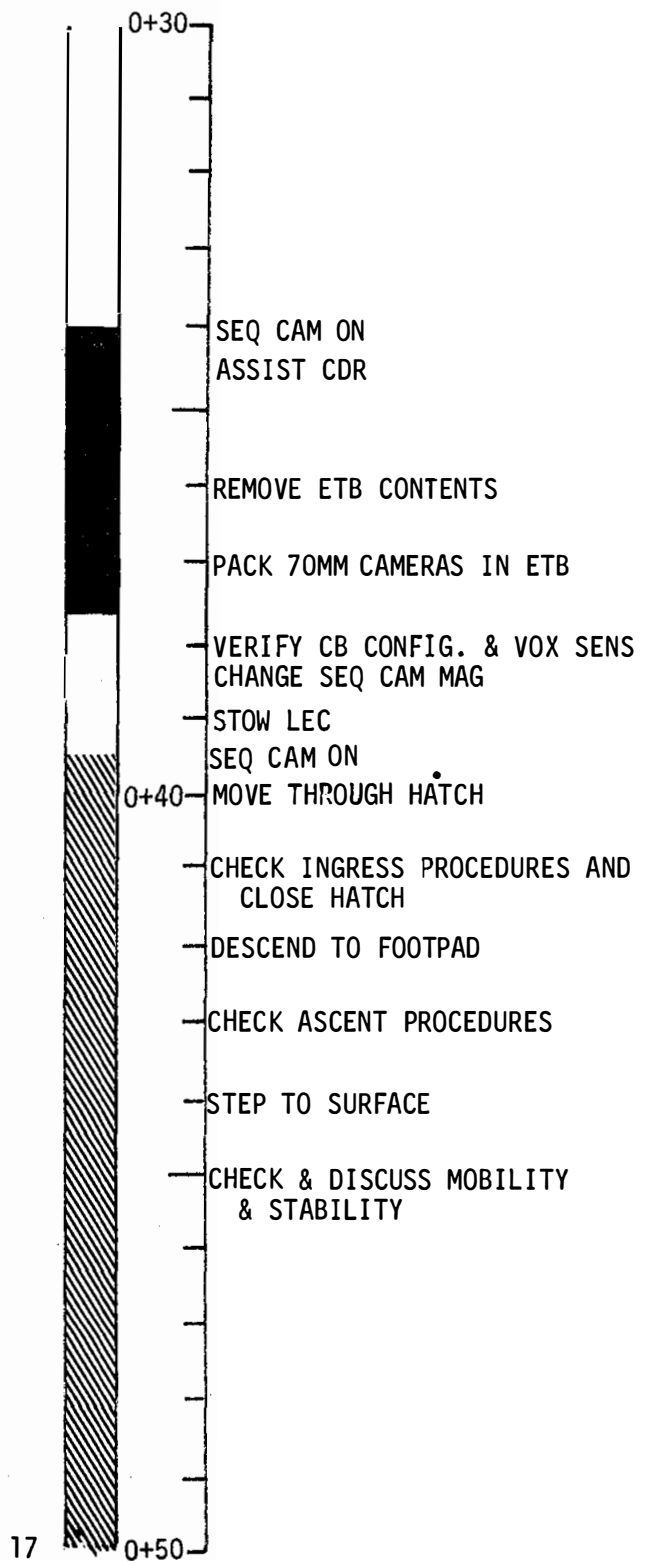

## CDR ACTIVITIES

- 0+50
- REMOVE S-BAND ANTENNA FROM LM
  - CARRY ANTENNA TO DEPLOY SITE
  - PLACE AND ORIENT ANTENNA
  - REMOVE TOP CAP
  - DEPLOY MAST SECTIONS
  - EXTEND LEGS
  - CHECK ANTENNA ORIENTATION
  - DEPLOY LEGS
  - REMOVE & DISCARD COVER
  - LIFT ANTENNA
  - REMOVE AND DISCARD LIFT BAR AND RIB PROTECTOR
  - UNSTOW TRIGGER AND DEPLOY REFLECTOR
  - UNSTOW AND ATTACH CABLE
- 1+00
- ROUGH ALIGN ANTENNA
  - FINE ALIGN ANTENNA
  - PULL FLAG SHROUD COVER PIP PIN
  - REMOVE SHROUD & THERMAL COVER
  - PULL FLAG STOWAGE PIP PIN & REMOVE FLAG
  - CARRY FLAG TO DEPLOY SITE
  - INSERT LOWER POLE INTO SURFACE
  - EXTEND HORIZ SHAFT OUT & UP
  - INSERT UPPER SHAFT INTO LOWER SHAFT
  - ATTACH SIDE BAG TO LMP
  - ATTACH 70MM CAMERA TO EMU
  - UNSTOW ALSCC & PLACE IN SUNLIGHT
  - OBTAIN +Z PANORAMA
- 1+10

## LMP ACTIVITIES

- 0+50
- UNSTOW & ERECT TV TRIPOD
  - UNSTOW & MOUNT TV CAMERA ON TRIPOD
  - UNSTOW TV CABLE
  - CARRY TV TO 20'/10 O'CLOCK TO VIEW S-BAND & FLAG
  - OBTAIN TV PANORAMA & SPECIAL INTEREST VIEWS
  - POINT TV AT S-BAND & FLAG AREA
  - ATTACH 70MM CAMERA TO EMU
  - UNSTOW SWC
  - CARRY SWC TO DEPLOYMENT SITE
  - EXTEND STAFF & DEPLOY FOIL
- 1+00
- IMPLANT STAFF IN SURFACE
  - PHOTOGRAPH SWC
  - PHOTOGRAPH LM/EARTH
  - REMOVE HAMMER FROM MESA
  - MOVE TO DEPLOY SITE
  - DRIVE LOWER SHAFT INTO SURFACE
  - PHOTOGRAPH CDR
  - STOW HAMMER ON MESA
  - ATTACH SIDE BAG TO CDR
  - REPOSITION TV TO 20'/8 O'CLOCK TO VIEW SEQ BAY
- 1+10
- PHOTOGRAPH -Y FOOTPAD
  - INSPECT QUAD I

## CDR ACTIVITIES

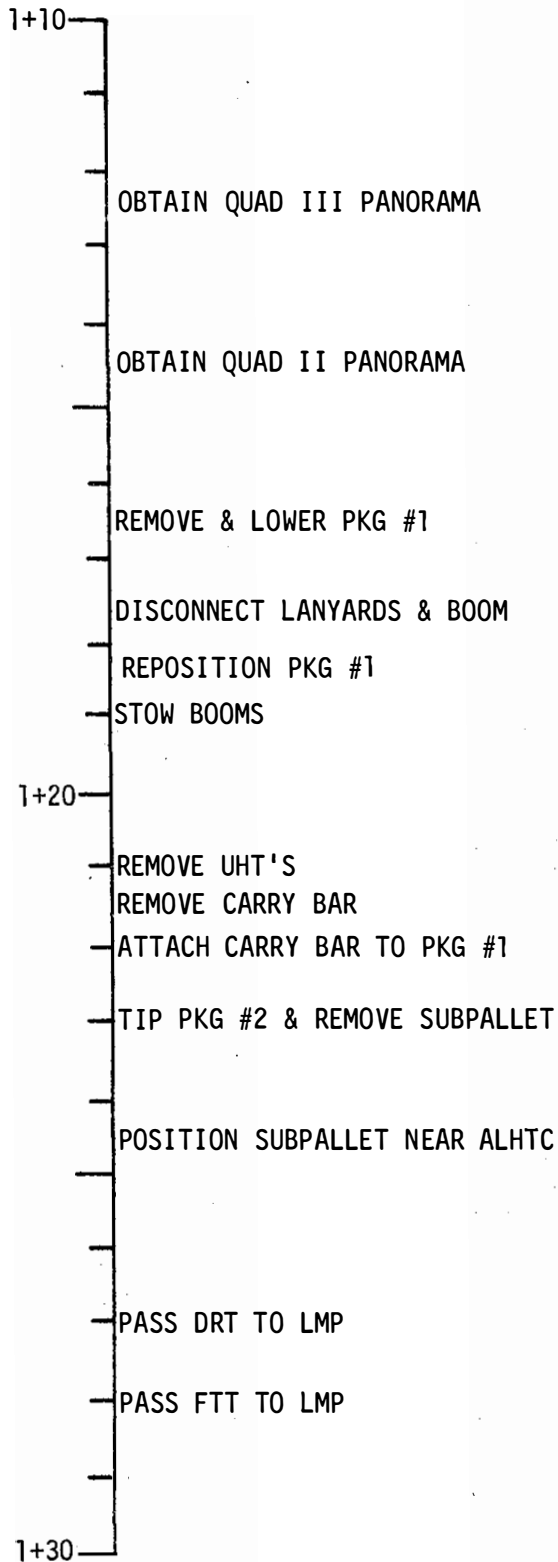

## LMP ACTIVITIES

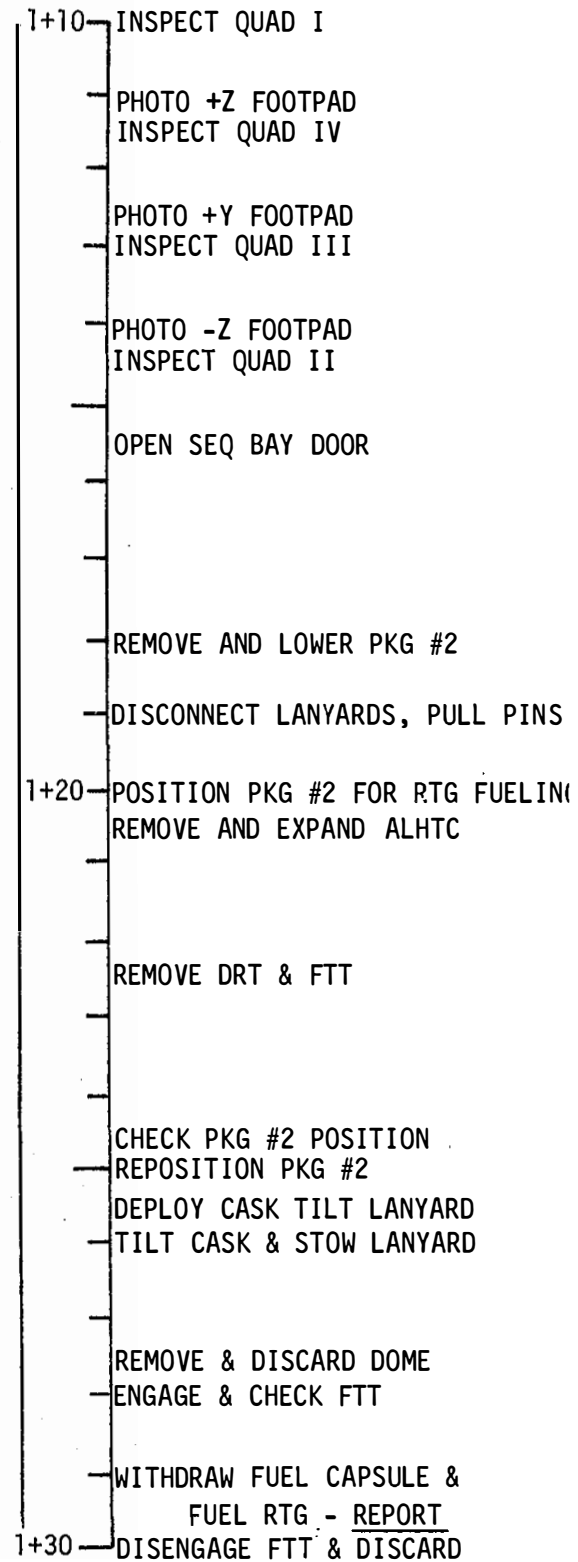

## CDR ACTIVITIES

1+30  
CLOSE SEQ BAY DOORS

CARRY ALHTC TO MESA AREA

UNSTOW & TETHER TONGS

RETURN TO QUAD II

CARRY SUBPALLET TO DEPLOYMENT SITE. CARRY & POSITION TV CAMERA TO VIEW SITE. REPORT START OF TRAVERSE AND REST STOPS ENROUTE.

1+40

REPORT COMPLETION OF TRAVERSE SURVEY SITE TO DETERMINE ALSEP EXPERIMENTS LOCATION

POSITION SUBPALLET

1+50  
RELEASE SIDE B. BOLTS

## LMP ACTIVITIES

1+30  
REST/CHECK EMU

ROTATE PKG #2 TETHER UHT

RELOCATE PKG #2 TO PKG #1  
CONNECT PKG #2 TO  
CARRY BAR

CARRY ALSEP PKGS TO DEPLOYMENT SITE

NOTE: REST ENROUTE

1+40

SURVEY SITE TO DETERMINE ALSEP EXPERIMENTS LOCATION

POSITION ALSEP PKGS

1+50  
DISENGAGE BAR FROM PKG #2

## CDR ACTIVITIES

- 1+50
- LIFT SIDE FROM SUBPALLET
- REMOVE SIDE CABLE REEL
- CARRY SIDE NEAR C/S
- DEPLOY LEGS AND PLACE SIDE ON SURFACE
- STOW TONGS ON SUBPALLET & TETHER UHT
- RETRIEVE SIDE CABLE CONNECTOR
- CARRY CONNECTOR TO C/S
- CONNECT SIDE TO C/S
- RELOCATE BAR TO SUBPALLET
- RETRIEVE PSE STOOL
- IMPLACE PSE STOOL
- RELEASE SWE BOYD BOLTS
- CARRY SWE TO DEPLOYMENT SITE
- 2+00
- PLACE SWE ON SURFACE, LEVEL AND ALIGN
- PHOTOGRAPH SWE
- RELEASE LSM BOYD BOLTS
- REMOVE TIE DOWN & DISCARD
- LIFT LSM FROM C/S
- PLACE LSM ON SURFACE
- CHECK LSM CABLE FREE OF SUNSHIELD
- START FRONT CENTER AND RELEASE BOYD BOLTS CLOCKWISE-
- DEPLOY ANTENNA CABLE
- RELEASE TWO INTER BOYD BOLTS
- 2+10

## LMP ACTIVITIES

- 1+50
- REPOSITION PKG #1 AND BAR
- TILT PKG #2
- RELEASE RTG CABLE BOYD BOLTS
- DEPLOY CABLE-DISCARD REEL
- REPORT AMPS & CONNECT CABLE
- TILT PKG #1
- ALIGN PKG #1
- RELEASE PSE BOYD BOLTS
- REMOVE PSE-CARRY TO PSE STOOL
- 2+00
- REMOVE GIRDLE-PLACE PSE ON STOOL
- DEPLOY THERMAL SKIRT
- LEVEL PSE
- REPORT LEVEL AND ALIGNMENT
- PHOTOGRAPH PSE
- REST/CHECK EMU
- CARRY LSM TO DEPLOY SITE
- REMOVE BRACKET & DEPLOY LEGS
- ALIGN LSM & PLACE ON SURFACE
- REMOVE FOAM COLLAR
- DEPLOY SENSOR ARMS
- 2+10

## CDR ACTIVITIES

2+10— RELEASE CENTER BOYD BOLT &  
RAISE SUNSHIELD

— REMOVE CURTAIN COVERS & DISCARD

— CHECK CURTAINS PROPERTY DEPLOYED

— RETRIEVE & INSTALL  
ANTENNA MAST

— RELEASE GIMBAL BOYD BOLTS  
REMOVE GIMBAL FROM SUBPALLET

— REMOVE HOUSING COVER  
INSTALL GIMBAL ON MAST

— REMOVE HOUSING & DISCARD  
INSTALL ANTENNA

— CHECK C/S ALIGNMENT  
ENTER AZIMUTH OFFSET

— ENTER ELEVATION OFFSET  
LEVEL ANTENNA

2+20—

— ALIGN ANTENNA

— CHECK ANTENNA LEVEL  
AND ALIGNED

— CHECK EMU

— CHECK LMP READY FOR  
ALSEP ACTIVATION

— REPORT SHORTING SW AMPS  
DEPRESS SHORTING SWITCH

— CHECK SHORTING SW AMPS ZERO  
TURN ASTRO SWITCH #1 ON

— REQUEST TRANSMITTER  
TURN ON

— CONFIRM RECEIPT OF  
DATA BY GROUND

— DISCARD UHT/TETHER TONGS

2+30— RETURN TO LM COLLECTING  
SAMPLES ENROUTE

## LMP ACTIVITIES

2+10— REMOVE PRA COVER

— CK PRA CLEAR OF PIECES & DOORS OPEN  
ALIGN & LEVEL LSM

— REPORT LEVEL AND ALIGNMENT

— PHOTOGRAPH LSM  
RETURN TO C/S

— REST CK EMU

— CARRY SIDE TO DEPLOY SITE

— PLACE SIDE ON GROUND SCREEN  
REMOVE & IMPLACE GROUND SCREEN

— REMOVE CCIG

2+20— PLACE SIDE ON GROUND SCREEN

— IMPLACE CCIG

— LEVEL AND ALIGN SIDE

— REPORT LEVEL & ALIGNMENT  
PHOTOGRAPH SIDE & CCIG  
RETURN TO C/S

— REST CHECK EMU

— PHOTOGRAPH ALSEP  
DEPLOYMENT SITE

2+30— RETURN TO LM COLLECTING  
SAMPLES ENROUTE

## CDR ACTIVITIES

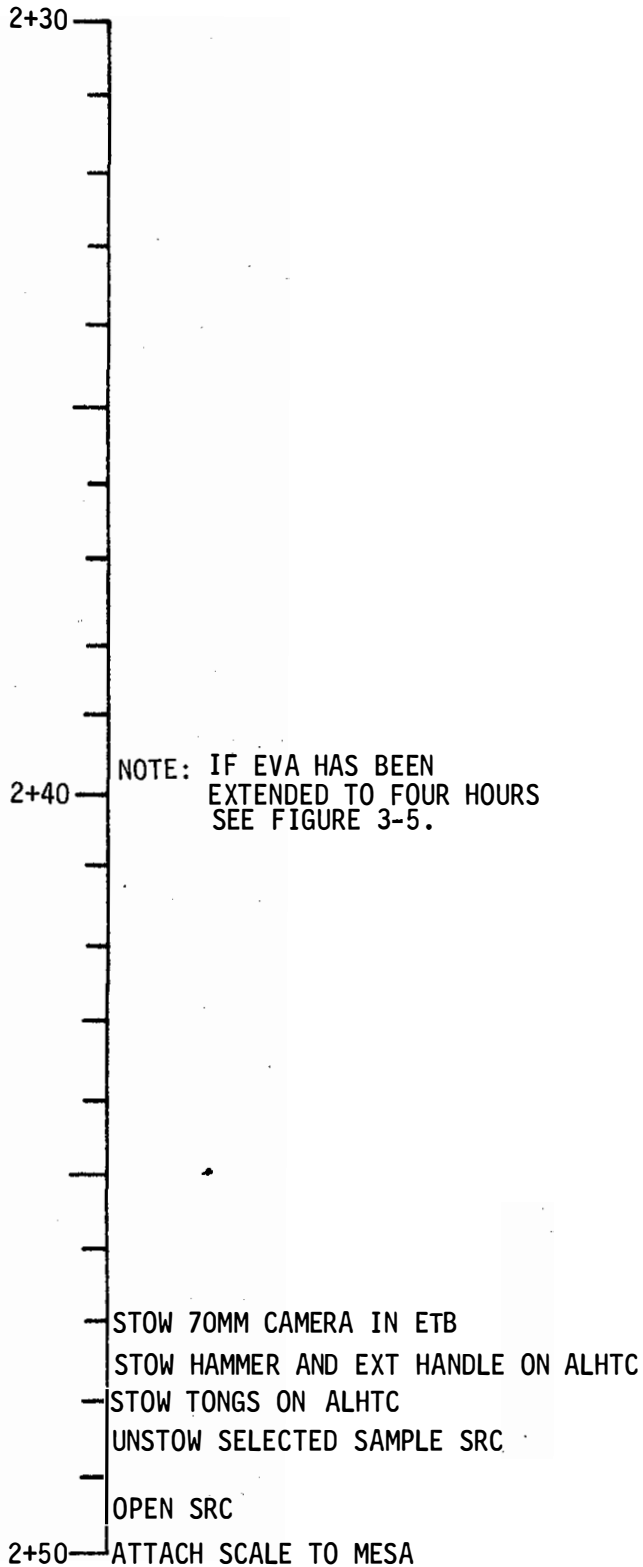

## LMP ACTIVITIES

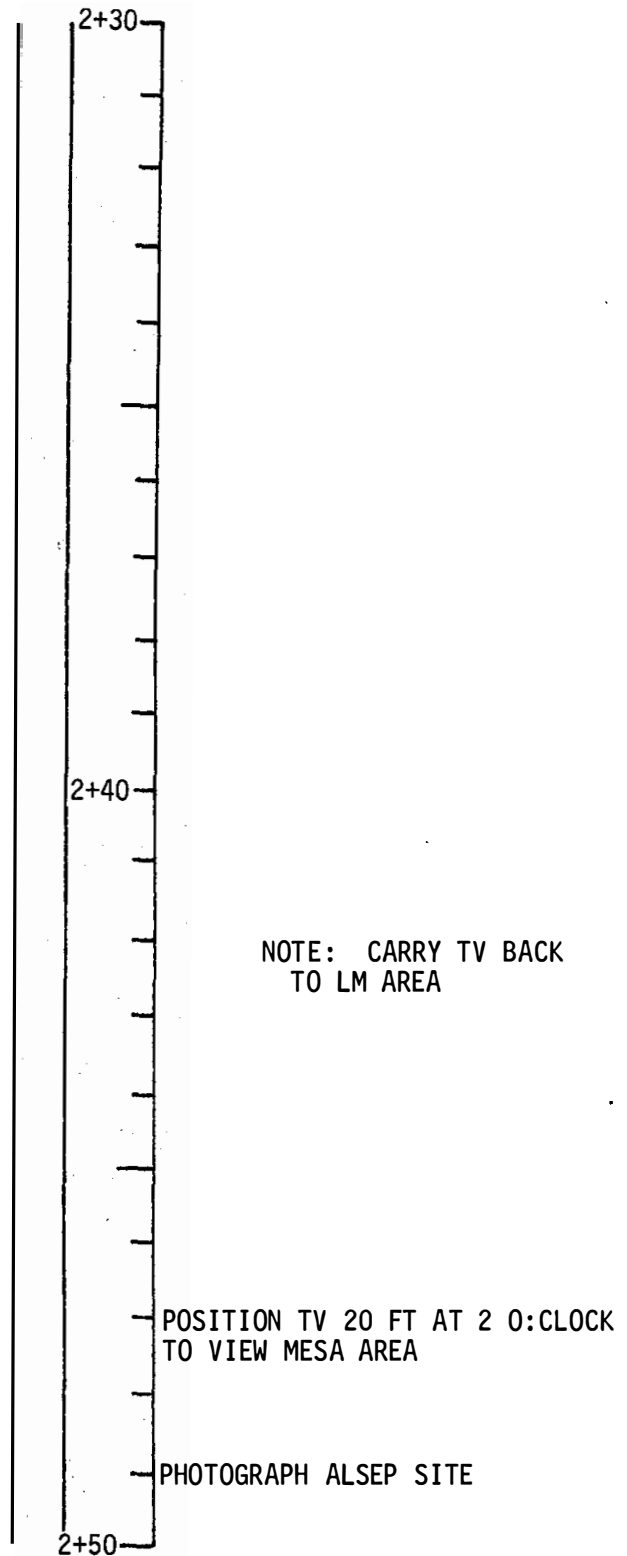



## CDR ACTIVITIES

2+50 ATTACH SCALE TO MESA  
STOW FLAT BAG DISPENSER ON ALHTC  
STOW CORE TUBE ON ALHTC  
SEAL ORGANIC CONTROL SAMPLE  
REMOVE SIDE BAGS  
ATTACH ONE SIDE BAG TO SCALE  
FINISH FILLING BAG WITH  
LOOSE MATERIAL  
CLOSE BAG & PLACE IN SRC  
REMOVE SIDE BAG  
ATTACH SECOND SIDE BAG TO SCALE  
CHECK WEIGHT OF BAG  
CLOSE BAG & PLACE IN SRC  
3+00 PACK AND SEAL SRC  
CLOSE ETB TOP FLAP  
REST/CHECK EMU  
COMM CHECK  
TRANSFER ETB INTO LM  
REST/CHECK EMU  
3+10

## LMP ACTIVITIES

2+50 REMOVE SIDE BAGS  
ASSEMBLE CORE TUBE AND  
HANDLE  
COLLECT CORE TUBE SAMPLE  
CAP SAMPLE AND REMOVE  
HANDLE  
STOW SAMPLE IN SRC  
REMOVE CDR SIDE BAG  
ASSIST CDR WITH SAMPLE  
COLLECTION  
STOW 70MM IN ETB  
CLEAN EMU AND CHECK  
CDR EMU  
3+00 ASCEND TO PLATFORM  
INGRESS  
CK EMU & LM SYSTEMS  
SWITCH TO ERECTABLE S-BAND  
COMM CHECK  
ASSIST CDR  
REMOVE ETB FROM LEC  
3 10

## CDR ACTIVITIES

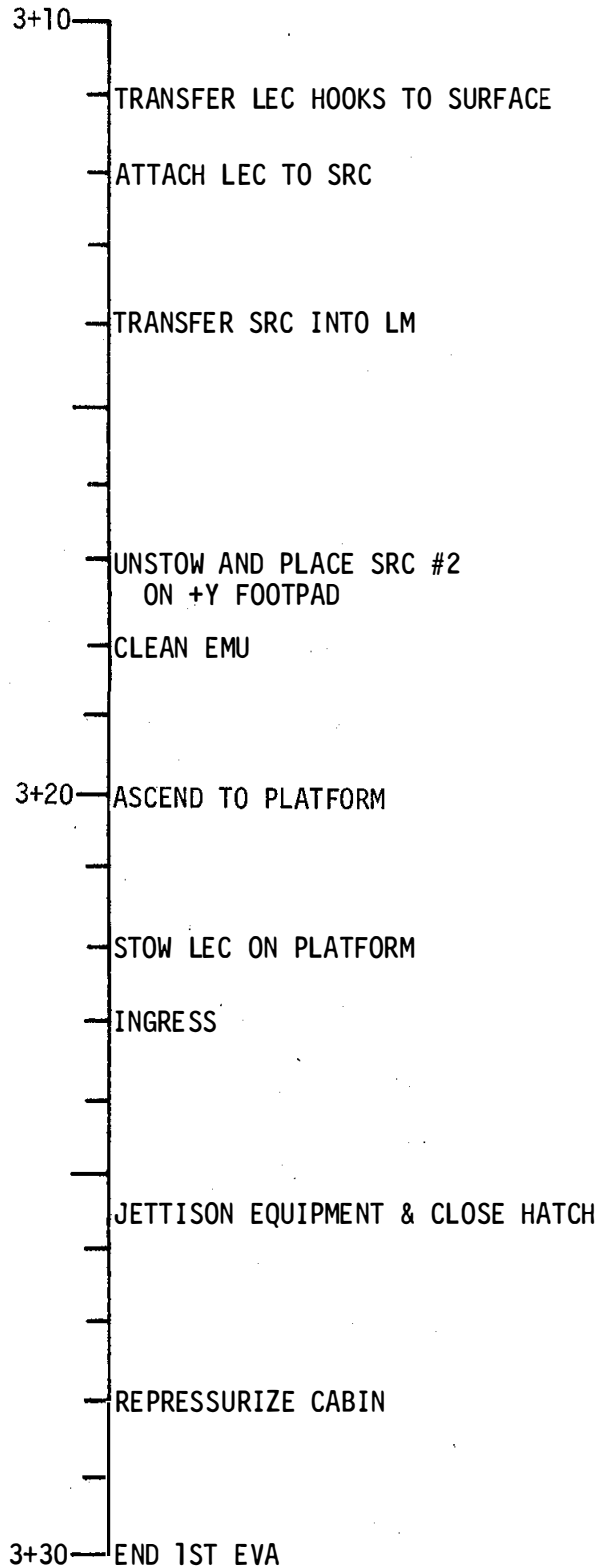

## LM ACTIVITIES

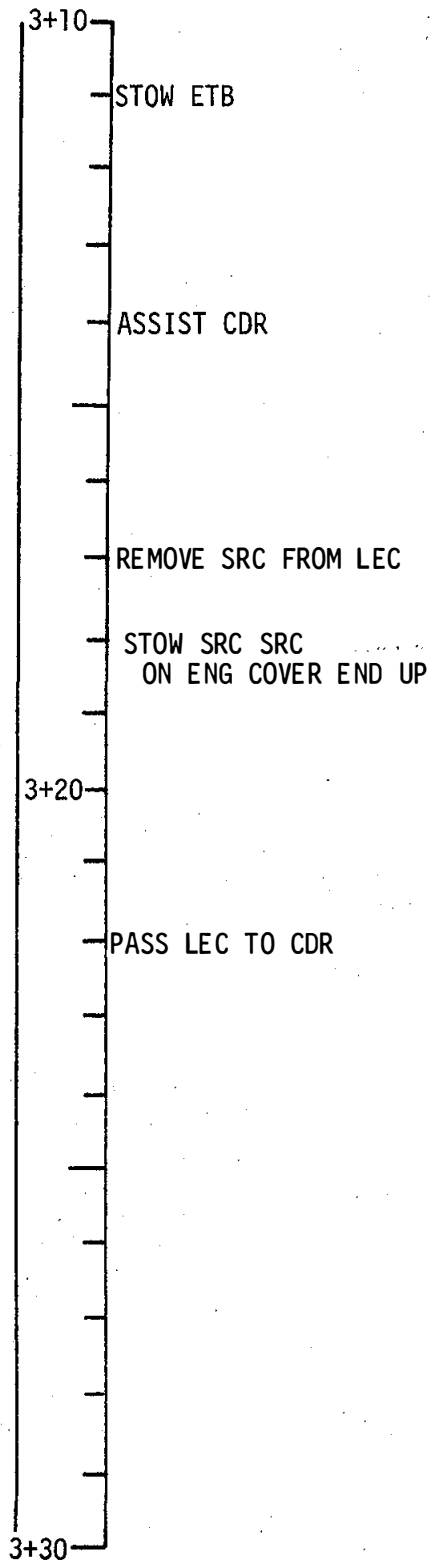

FIGURE 3-5

APOLLO TWELVE  
MISSION H-1

# FOUR HOUR NOMINAL TIMELINE LUNAR SURFACE EVA ONE

(SEE FIGURE 3-4 FOR FIRST PART OF TIMELINE)

## CDR ACTIVITIES

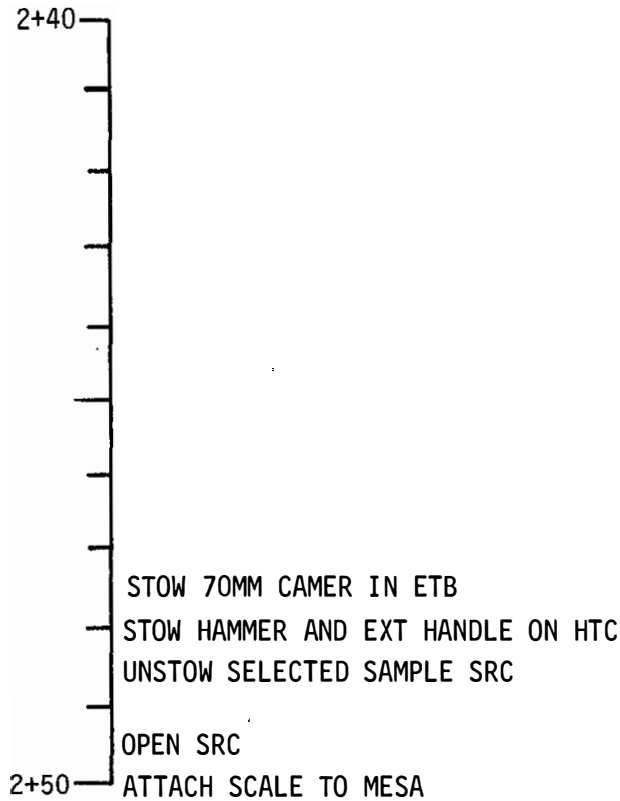

## LMP ACTIVITIES

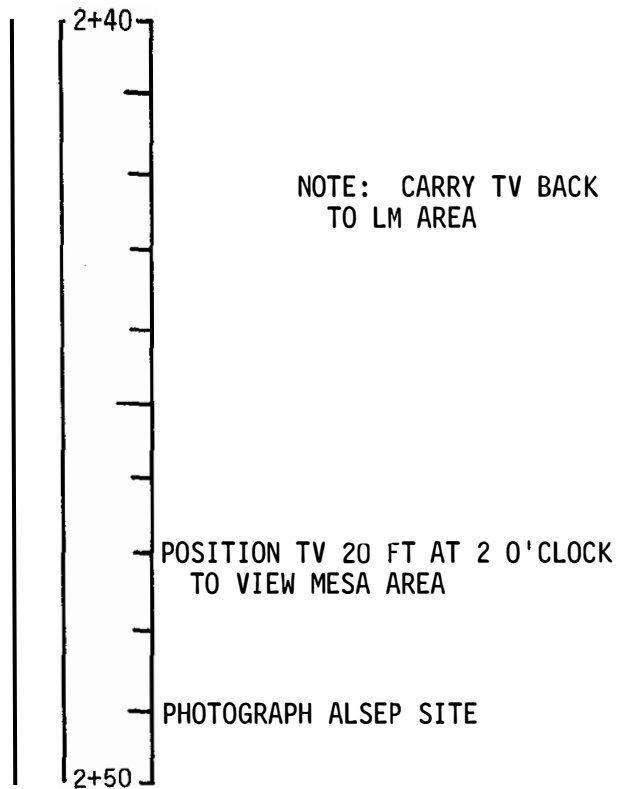

## CDR ACTIVITIES

2+50 — ATTACH SCALE TO MESA  
STOW FLAT BAG DISPENSER ON HTC  
— STOW CORE TUBE ON HTC  
— SEAL ORGANIC CONTROL SAMPLE  
— REMOVE LMP SIDE BAG  
ATTACH SIDE BAG TO SCALE  
— FINISH FILLING BAG WITH  
LOOSE MATERIAL  
— CLOSE BAG & PLACE IN SRC  
— REMOVE SIDE BAG  
— ATTACH SECOND SIDE BAG TO SCALE  
— CHECK WEIGHT OF BAG  
CLOSE BAG AND PLACE IN SRC  
  
3+00 — ATTACH 70MM CAMERA TO EMU  
GEOLOGY TRAVERSE:  
CDR CARRY  
• GNOMON  
• SMALL SCOOP  
• 70MM CAMERA  
TYPICAL DOCUMENTED  
SAMPLE COLLECTION  
— PLACE GNOMON UP SUN  
PHOTO SAMPLE CROSS SUN  
— COLLECT & PLACE  
SAMPLE IN BAG  
  
3+10 —

## LMP ACTIVITIES

2+50 — REMOVE SIDE BAG  
— ASSEMBLE CORE TUBE AND  
HANDLE  
— COLLECT CORE TUBE SAMPLE  
— CAP SAMPLE AND REMOVE  
HANDLE  
— STOW SAMPLE IN SRC  
REMOVE CDR SIDE BAG  
— ASSEMBLE SMALL SCOOP  
AND HANDLE  
— UNSTOW & PLACE GNOMON  
ON ALHTC  
— REPOSITION TV TO VIEW  
GEOLOGY TRAVERSE  
  
3+00 — GEOLOGY TRAVERSE  
LMP CARRY  
• ALHTC  
• 70MM CAMERA  
  
— PLACE ALHTC  
  
— PHOTO SAMPLE DOWN SUN  
DEPLOY & HOLD FLAT  
SAMPLE BAG  
— DESCRIBE & STOW SAMPLE  
PHOTO SITE DOWN SUN  
  
3+10 —

## CDR ACTIVITIES

3+10 — GEOLOGY TRAVERSE  
(CONTINUED)

TRENCH SITE  
SAMPLE COLLECTION

— AT FARTHEST POINT FROM  
THE LM COLLECT TWO SAMPLES  
OF SUBSURFACE MATERIAL

— PLACE GNOMON UP SUN  
PHOTO SITE CROSS SUN  
— DIG TRENCH ALONG SUNLINE

— FILL SAMPLE BAGS WITH  
SUBSURFACE MATERIAL

3+20 —

— STOW 70MM CAMERA IN ETB  
— STOW TONGS ON HTC  
— TRANSFER SAMPLES INTO SRC

3+30 —

## LMP ACTIVITIES

3+10 — GEOLOGY TRAVERSE  
(CONTINUED)

— PLACE ALHTC  
PHOTO SITE DOWN SUN  
— DEPLOY AND HOLD FLAT  
SAMPLE BAGS

— STOW SAMPLES IN ALHTC  
PHOTO SITE DOWN SUN

3+20 —

— REPOSITION TV TO 20 FT AT  
2:0:CLOCK TO VIEW MESA/LADDER

— STOW 70MM CAMERA IN ETB

— CLEAN EMU AND CHECK  
CDR EMU

3+30 —

## CDR ACTIVITIES

3+30 — PACK AND SEAL SRC  
— CLOSE ETB TOP FLAP  
— REST/CHECK EMU  
— COMM CHECK  
— TRANSFER ETB INTO LM  
— REST/CHECK EMU  
3+40 — TRANSFER LEC HOOKS TO SURFACE  
— ATTACH LEC TO SRC  
— TRANSFER SRC INTO LM  
— UNSTOW AND PLACE SRC #2  
— ON +Y FOOTPAD  
— CLEAN EMU  
3+50 — ASCEND TO PLATFORM

## LMP ACTIVITIES

3+30 — ASCEND TO PLATFORM  
— INGRESS  
— CK EMU & LM SYSTEMS  
— SWITCH TO ERECTABLE S-BAND  
— COMM CHECK  
— ASSIST CDR  
— REMOVE ETB FROM LEC  
3+40 — STOW ETB  
— ASSIST CDR  
— REMOVE SRC FROM LEC  
— STOW SRC  
— ON ENG COVER END UP  
3+50 —

## CDR ACTIVITIES

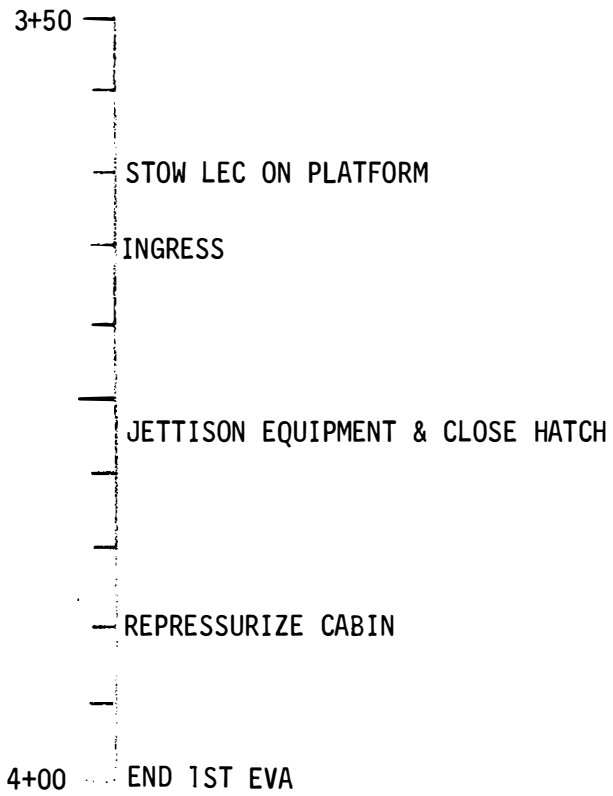

## LMP ACTIVITIES

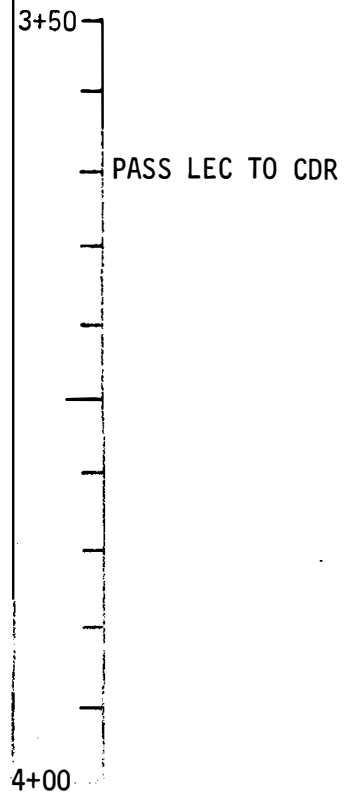

### 3.2.2 EVA 1 Detailed Procedures

#### CDR ACTIVITIES

##### 0+00 FINAL PRE-EVA OPERATIONS

NOTE: Detail procedures for the first ten minutes are presented in the "LUNAR SURFACE CHECK-LIST."

##### 0+10 CDR EGRESS

Move through the hatch to a position on the platform

Check procedures for ingress by ingressing until the PLSS/OPS has entered the hatch

Accept the LEC from the LMP then egress to the platform and deploy the LEC on the MESA side of the platform. Deploy sufficient length of the LEC so that it can be reached from the surface.

Descend to a position on the ladder to deploy the MESA

Pull pip pin safety wire, then pull the MESA deployment D-ring with the left hand, check the MESA has deployed and restow the D-ring. (If the MESA did not deploy after descending to the surface, use the manual deployment lanyard located on the left side of the MESA to pull the MESA from its stowage cavity).

Notify the LMP and descend the ladder to the footpad. Check pad-to-ladder ascent procedures

Step to surface

NOTE: The astronauts will periodically check the EMU and report oxygen and suit pressure

#### LMP ACTIVITIES

##### 0+00 FINAL PRE-EVA OPERATIONS

NOTE: Detail procedures for the first ten minutes are presented in the "LUNAR SURFACE CHECK-LIST."

Remove the LEC from stowage. Attach LEC hook to the overhead handhold and deploy a short length of the LEC strap

Pass the end of the LEC strap to the CDR

Photograph the CDR, using the 70mm camera, as he descends from the platform to the ladder and deploys the MESA.

Turn the sequence camera on at 12 fps and photograph the CDR as he descends to the footpad and accomplishes his environmental familiarization.



CDR ACTIVITIES

LMP ACTIVITIES

0+18 CDR ENVIRONMENTAL FAMILIARIZATION

Near the +Z foot pad in view of the sequence camera check and discuss the following:

- a. Mobility and stability
- b. CG shift-forward, back and side
- c. Downward reach capability
- d. Arm motion effects on stability
- e. Walking, balance, boot penetration, surface traction, soil scattering characteristics and soil adhesion

Check and report on the status of the LM specific items to be noted are:

- a. LM attitude
- b. Ground clearance
- c. Footpad/Surface interaction
- d. DPS Exhaust effects

0+23 CONTINGENCY SAMPLE COLLECTION

Remove the CSC from thigh pocket, deploy the CSC handle and extend the sample bag by pulling on the strap on bottom of bag.

In view of the sequence camera collect the surface material from an undisturbed area.

Pull locking plug from under handle release lever, depress lever, then separate handle from bag assembly. Discard handle under LM and detach bag from lip assembly. Discard lip assembly under LM.

Change the sequence camera magazine when the first magazine is exhausted.

Turn the sequence camera on at 12 fps and photograph the CDR as he collects the contingency sample.

## CDR ACTIVITIES

Roll and fold the top of the sample bag then temporarily stow the sample on a ladder rung.

### 0+26 ETB TRANSFERS

Adjust the MESA height, if necessary, by pulling upward on the adjustment strap. Remove the MESA thermal blanket by releasing the velcro strap around the TV lens and opening the blanket along the velcro seams.

Release the MESA table velcro tie-down straps, unfold and rotate the table to a proper height, and secure the table at that height by engaging the velcro adjustment strap.

Unstow and place the ETB on the MESA table. Remove the two side bags from the ETB and stow them temporarily on the MESA. Remove the photometric color chart and three contrast charts from the ETB and hang them on the front left corner of the MESA table.

Unstow and place in the ETB:

- a. Two PLSS Batteries
- b. Two PLSS LiOH Canisters
- c. The Contingency Sample

Close the ETB top flap

Retrieve and attach the LEC to the ETB

Lift the ETB clear of the MESA table and carry it to a position in front of the ladder. Guide the ETB with the LEC strap as the LMP pulls the ETB into the LM cabin.

## LMP ACTIVITIES

Turn the sequence camera off after the CDR has collected the contingency sample

Make a final check of the EMU and LM systems

Confirm with MCC that you have a GO to egress the LM

Turn the sequence camera on when the CDR walks into view with the ETB

Transfer the ETB into the LM cabin by pulling the LEC strap through the overhead pulley

## CDR ACTIVITIES

Rest and check the EMU while the LMP prepares to transfer the 70mm cameras to the surface.

Transfer the ETB to the surface

Attach the ETB to the right side of the MESA.

### 0+40 LMP AND CONTINGENCY PHOTOGRAPHY

Remove one 70mm camera from the ETB

Move to a position in front of the LM and photograph the LMP as he egresses and descends to the surface.

Photograph the area from where the contingency sample was taken

Remove the photographic color chart from the MESA table. Place the chart on the surface in the sunlight. Photograph the chart, cross sun and down sun, using the 70mm camera.

Stow the 70mm camera on the MESA

## LMP ACTIVITIES

Remove the LiOH canisters, batteries and contingency sample from the ETB. Then place inside the ETB the two 70mm cameras. Notify the CDR the ETB is ready for transfer to the surface

Check the LM circuit breakers are properly configured and the VOX sensitivity on the RCU is turned to maximum.

Change the sequence camera magazine. Disconnect the LEC from the overhead handhold and stow it. Turn the sequence camera on at 6 fps and leave the camera pointing to the S-band antenna deployment site.

### 0+40 LMP EGRESS

Move through the hatch to a position on the platform

Check procedures for ingress by ingressing until the PLSS/OPS has entered the hatch. Egress and close the hatch.

Descend to the footpad and check pad-to-ladder ascent procedures.

### 0+45 LMP ENVIRONMENTAL FAMILIARIZATION

In view of the sequence camera check and discuss the following:

- a. Mobility and stability
- b. CG shift-forward, back and side
- c. Down reach capability
- d. Arm motion effects on stability
- e. Walking (balance, boot penetration, surface traction, soil scattering characteristics and soil adhesion)

## CDR ACTIVITIES

### 0+50 S-BAND ANTENNA DEPLOYMENT

Transfer antenna to deployment site:

- a. Walk to antenna stowage position (Quad I)
- b. Remove thermal shield
- c. Remove Velcro straps and pull to release pins at base of antenna
- d. Grasp antenna by deployment "shimmy" bar and folded lift handle
- e. Pull antenna out and down by lift handle to clear LM structure
- f. Hold antenna by deployment bar and deploy folded lift handle by pulling handle out of stowage detent and down to locked position
- g. Rotate antenna to horizontal position and carry the antenna to the deployment site by the shimmy bar  
(NOTE: The site to be used should provide a clear view of Earth and be approximately 20 feet from the MESA).
- h. Place the antenna down with the bottom antenna handle resting on the surface and the orientation arrow on top cap pointing to Earth.

Remove top cap:

- a. Release each of the three leg clamps by rotating them out and down
- b. Depress the three leg tips and push them radially outward to free the antenna top cap
- c. Discard metal top cap and foam piece in area away from the LM

## LMP ACTIVITIES

### 0+50 TV DEPLOYMENT

Unstow and erect the TV tripod

- a. Release two snap tie-down straps
- b. Lift the tripod from the MESA
- c. Deploy the tripod legs and extend the center shaft
- d. Set the tripod on the surface near the MESA

Unstow and mount the TV camera on the tripod.

- a. Release the cable connector snap tie-down strap
- b. Release lens tie-down snap straps
- c. Release the end snap on the camera tiedown snap strap
- d. Using pip pin cable, pull the two top pip pins to open the camera stowage container
- e. Open and rotate the top half of the camera stowage container forward and down.
- f. Release the second snap on the camera tie-down snap strap
- g. Deploy the TV camera handle
- h. Lift the camera from the stowage container and lift the TV cable free of the MESA.
- i. Insert the TV camera handle in the adapter ring on top of the TV tripod and tighten the ring

Pull the TV cable from its stowage cavity on the right side of the MESA.

Carry the TV to a position 20 feet at 10 o'clock.

## CDR ACTIVITIES

Raise antenna mast:

- a. While holding the antenna vertical, grasp antenna horn top plate and raise the first section of the antenna feed support.  
(Insure the first section only is deploying by applying a 2-finger pressure on outer mast section. The outer section has orange stripes).  
CAUTION: Do not touch helix element when extending feed assembly
- b. Check first section fully deployed and locked in detent
- c. Extend the second antenna feed support section in the same manner as the first. Check the second section fully extended and locked in detent.

Deploy tripod:

- a. Extend antenna legs by placing 2 fingers about the leg section and applying force against loops on either side of leg. Continue to extend each leg section to the proper length, i.e., the proper paint ring and lock with clamps. Check adequacy of each leg lock
- b. Check antenna points toward earth by arrow on rib programmer
- c. Move around to the right into the antenna lifting position by the shimmy bar
- d. Pull each of three Velcro leg retention straps and let the legs fall outward to a horizontal position on the surface

## LMP ACTIVITIES

Obtain a TV panorama of the LM landing site and obtain a view of any features of special interest in the area.

Place the TV camera on the surface viewing the S-Band antenna and MESA areas.

### 0+56 SWC DEPLOYMENT

Remove the 70mm camera from the ETB and attach the camera to the RCU

Release the two SWC tie-down snap straps and lift the SWC from the MESA

Carry the SWC to the deployment site 60 feet from the LM in Quad IV

Deploy SWC:

- a. Extend each section of staff until it locks. (red band should be visible) Apply a compressing force to each section to check sections locked
- b. Extend shade cylinder and rotate toward red side of pivot point, i.e., red to red
- c. Extend foil shade and hook to lower portion of staff
- d. Press staff into surface with foil normal to sun (side marked SUN to SUN)

Photograph the SWC down sun and cross sun with LM in the background.

Obtain photographs of the LM/Earth

## CDR ACTIVITIES

- e. Remove thermal covering from antenna and discard away from LM
- f. Lift the antenna from the surface using both hands on the shimmy bar until the antenna is high enough to permit the crewmember to grasp the lift handle
- g. While holding the antenna aloft with one hand, grasp lift handle with other hand
- h. Lift the antenna to the high detent position
- i. Check each leg locked securely in detent by holding the antenna aloft with one hand and pushing outboard on the legs individually
- j. Set antenna on surface
- k. Release pull pin fastener at base of shimmy bar. Pull deployment bar down and away from antenna
- l. Discard bar in the area away from the LM
- m. Firmly implant each leg into surface

### Open antenna reflector:

- a. Remove rib tip protector and allow it to slide down antenna leg to surface
- b. Uncoil antenna reflector release cable from around antenna. Hold cable taut and in straight line to plunger
- c. Remove release trigger guard pin and discard in area away from LM
- d. Grasp an antenna leg with free hand and position self at arms length from leg
- e. With head down, squeeze release trigger to deploy antenna dish.

## LMP ACTIVITIES

## CDR ACTIVITIES

## LMP ACTIVITIES

### Attach antenna cable:

- a. Walk to front of MESA
- b. Release antenna cable connector by pulling Velcro tab and snap free
- c. Grasp cable connector and pass the connector under the MESA support strap
- d. With cable connector in hand, walk to the left of the antenna
- e. Walk past the antenna and deploy the cable completely (until black and white striped section visible)
- f. Walk to antenna
- g. Connect antenna cable by mating the two connector parts - turning the outer part clockwise as viewed from cable end

### Rough align antenna:

- a. Move around antenna leg to rough antenna alignment position
- b. Press each leg into surface.
- c. Unstow alignment crank by pushing down and away on crank handle
- d. Uncoil crank cable by passing crank around and behind the antenna base
- e. Rough align antenna in pitch (CCW rotation of the handle pitches the antenna down)
- f. Rough align antenna in azimuth. Pull antenna crank out from housing then rotate handcrank to change antenna azimuth

CDR ACTIVITIES

LMP ACTIVITIES

Fine align antenna:

- a. Check antenna alignment by sighting along antenna mast and using optical alignment sight
- b. Fine align antenna, as required, by using remote control crank-handle "in" for pitch and "out" for azimuth

1+01 FLAG DEPLOYMENT

Remove the flag from stowage on the side of the LM ladder

- a. Pull flag shroud cover pip pin
- b. Remove shroud and thermal cover
- c. Pull flag stowage pip pin
- d. Lift the flag from its stowage location

Walk to the deployment site  
Push the lower section of the flag staff into the surface.

Deploy the horizontal shaft by first extending then rotating the shaft so it is perpendicular to the flag staff.

After the LMP has driven the lower section into the surface, insert the upper section of the flag staff into the lower section.

1+06 PANORAMA PHOTOGRAPHY

Retrieve a side bag from the MESA and attach the bag to the hard point on the left side of the LMP's EMU.

Retrieve the 70mm camera from the MESA and attach the camera to the RCU.

Remove the ALSCC from the MESA and place in sunlight near the +Y footpad.

FLAG DEPLOYMENT

Remove the hammer from stowage by releasing the two tie-down snap straps and lifting the hammer from its MESA stowage location.

Using the hammer drive the lower section of the Flag staff into the surface.

Photograph the CDR as he deploys the Flag.

Stow the hammer on the MESA.

1+06 LM INSPECTION AND PHOTOGRAPHY

Retrieve a side bag from the MESA and attach the bag to the hard point on the left side of the CDR's EMU.

Reposition the TV camera to a position 20 feet at 8 o'clock to view the SEQ bay area.



## CDR ACTIVITIES

Walk to a position 20 feet at 12 o'clock and take a set of panorama photographs. The set will consist of 12 photographs at 30-degree intervals.

Walk to a position 20 feet at 4 o'clock and take another set of panorama photographs.

Walk to a position 20 feet at 8 o'clock and take the third set of panorama photographs.

### 1+16 ALSEP OFFLOAD

Remove package No. 1

- a. Retrieve package No. 1 deployment lanyard.
- b. Walk 10 feet from LM deploying lanyard.
- c. Pull white section of lanyard to unlock and pull package No. 1 from the SEQ. Bay. Insure boom is extended fully.
- d. Lower package No. 1 to lunar surface by alternately pulling and releasing the black & white section of lanyard.

## LMP ACTIVITIES

In stereo, photograph the -Y footpad/surface.

Inspect Quad I of the LM.

In stereo, photograph the +Z footpad/surface.

Inspect Quad IV of the LM.

In stereo, photograph the +Y footpad/surface.

Inspect Quad IV of the LM.

In stereo, photograph the -Z footpad/surface.

Inspect Quad II of the LM.

### 1+16 ALSEP OFFLOAD Open SEQ bay doors

- a. Remove thermal shielding covering door lanyard.
- b. Retrieve door lanyard and walk 10 feet from LM deploying lanyard.
- c. Pull white section of lanyard until SEQ and astronaut doors open fully.
- d. Stow lanyard on -Z gear struts.

#### CDR ACTIVITIES

- e. Walk to package No. 1
- f. Disconnect deployment lanyard from package No. 1
- g. Pull boom cable release D-ring.
- h. Place lanyard behind Package No. 1.
- i. Remove boom attachment assembly from package No. 1 by pulling pip pin. Discard assembly and pin under LM.
- j. Remove package No. 1 to a position clear of the SEQ. bay working area.

#### LMP ACTIVITIES

##### Remove Package No. 2

- a. Retrieve package No. 2 deployment lanyard.
- b. Walk 10 feet from LM deploying lanyard.
- c. Pull white section of lanyard to unlock and pull package No. 2 from the SEQ bay. Insure boom is extended fully.
- d. Lower package No. 2 to Lunar Surface by alternately pulling and releasing black/white section of lanyard.
- e. Walk to package No. 2.
- f. Disconnect deployment lanyard from package No. 2.
- g. Pull boom cable release D-ring.
- h. Place lanyard behind package No. 2.
- i. Pull pip pins to release ALHT carrier (2) boom attachment assembly (1) subpallet (1) universal, handling tools (1), and dome removal tool (1).
- j. Remove boom attachment assembly and discard under LM.
- k. Reposition package No. 2 near the fuel cask for RTG fueling.

## CDR ACTIVITIES

Stow package No. 2 boom by pulling black/white boom stowage lanyard until boom is fully retracted.

Stow package No. 1 boom by pulling black/white boom stowage lanyard until boom is fully retracted.

Strip package No. 2

- a. Remove one UHT and stow in package No. 2 UHT socket.
- b. Remove other UHT and tether.
- c. Remove tool stowage bracket.
- d. Remove and mate mask/carry box sections.
- e. Install antenna mask/carry bar on package No. 1.

Tip package No. 2 to fueling position

Release two subpallet Boyd bolts

Remove subpallet from package No. 2 and place on surface clear of fuel cask area.

Retrieve DRT from ALHT carrier

## LMP ACTIVITIES

Remove ALHT Carrier

- a. Remove and discard green pins, lanyards and D-Rings.
- b. Lift ALHT carrier from package No. 2.
- c. Expand ALHT carrier.
- d. Unfold legs to the fully deployed detent positions.
- e. Pull apex leg out to the fully deployed detent position.
- f. Remove the green safety clip from the ALHT carrier underside.
- g. Remove the gold pins.
- h. Unfold ALHT carrier.

Remove DRT and FTT from package No. 2 and stow in ALHT carrier.

Fuel RTG

- a. Retrieve cask lanyard from astronaut safety door.
- b. Walk 10 feet from fuel cask deploying cask lanyard.
- c. Pull lanyard to cut left uplock pin, dome spline and cut right uplock pin.
- d. Tilt cask down into position for fuel element removal.
- e. Stow lanyard on -Y gear strut.

## CDR ACTIVITIES

Pass DRT to LMP

Retrieve and open FTT.

Transfer FTT to LMP

Close SEQ bay doors

- a. Retrieve SEQ door lanyard
- b. Pull black/white section of lanyard until SEQ. and astronaut safety doors are fully closed.
- c. Discard lanyard under LM.

Carry ALHTC to MESA area

Retrieve & tether tongs

Return to SEQ bay area

Pick up TV camera & subpallet

## LMP ACTIVITIES

f. Receive DRT from CDR.

g. Mate DRT with dome locking mechanism and pull outward on DRT to insure it is locked in place.

h. Press inward on DRT and rotate dome locking mechanism 150° clockwise.

i. Remove dome and discard DRT/dome.

j. Receive FTT from CDR.

k. Insert FTT fingers into fuel capsule head.

l. Engage FTT fingers in fuel capsule head by rotating knob clockwise.

m. Withdraw fuel capsule from fuel cask.

n. Turn to Package No. 2.

o. Lower fuel capsule into Radioisotope Thermoelectric Generator (RTG)

p. Report RTG fueled.

q. Disengage FTT fingers from fuel capsule head by counter-rotation of knob.

r. Discard FTT.

Tilt package to carry orientation.

Remove UHT from package No. 2 and tether.

Carry package No. 2 to package No. 1.

Connect package No. 2 to carry bar/package No. 1.

CDR ACTIVITIES

1+36 ALSEP TRAVERSE

Report start of traverse.

Carry TV camera and subpallet to a position 100 feet West of the LM. Orient TV to view ALSEP site.

Complete traverse to ALSEP site a minimum of 300 feet West of the LM.

Report rest stops

Report end of traverse

Survey ALSEP site to determine experiments location.

1+48 ALSEP SYSTEM INTERCONNECT

Position subpallet on surface South of package No. 2

Connect side of package No. 1

- a. Use UHT to release four Boyd bolts on SIDE/CCIG.
- b. Engage UHT in SIDE/CCIG carry socket
- c. Use UHT to remove SIDE/CCIG from subpallet.
- d. Remove left, front guide.
- e. Pull SIDE/CCIG cable reel from cavity and drop reel to surface.
- f. Pull lanyard to remove leg-release pull pin and dust cover safety pin.
- g. Lower SIDE/CCIG to lunar surface.
- h. Stow tongs on subpallet.
- i. Use UHT to remove pull pin on SIDE/CCIG cable cradle and retrieve SIDE/CCIG connector from cable cradle.

LMP ACTIVITIES

1+36 ALSEP TRAVERSE

Carry the ALSEP package to the ALSEP deployment site.

1+48 ALSEP SYSTEM INTERCONNECT

Position ALSEP packages on surface with package No. 2 in the final deployment position.

Connect RTG to package No. 1.

- a. Disengage carry bar from Package No. 2.
- b. Lift Package No. 1 and emplace approximately 10 feet from Package No. 2 on E-W axis.
- c. Return to Package No. 2.
- d. Use stowed UHT as a handle to rotate Package No. 2 to the deployed position and align on E-W axis.
- e. Use UHT to release three Boyd bolts on RTG cable reel.
- f. Engage UHT in RTG cable reel carry socket.
- g. Use UHT to remove RTG cable reel from Package No. 2 and walk to Package No. 1, deploying power cable.
- h. Remove shorting switch pull pin and discard.

CDR ACTIVITIES

- j. Walk to Package No. 1.
- k. Remove SIDE/CCIG connector dust cover and discard.
- l. Remove Central Station connector dust cover and discard.
- m. Mate SIDE/CCIG cable to Central Station.

Disengage carry bar from Package No. 1.

Stow antenna mast/carry bar on Subpallet taper fitting.

Deploy PSE stool

- a. Use UHT to remove pull pin on PSE leveling stool and discard pull pin.
- b. Remove PSE leveling stool from Subpallet.

Place PSE stool on surface in position for PSE Deployment.

1+58 SWE DEPLOYMENT  
Deploy SWE

- a. Use UHT to release four Boyd bolts on SWS.
- b. Engage UHT in SWS carry socket.
- c. Use UHT to remove SWS from sunshield and carry SWS 13 feet from Central Station.
- d. Extend four leveling legs to locked position.
- e. Emplace SWS on lunar surface and align by observing shadow cast on sensor head.

LMP ACTIVITIES

- i. Grasp shorting switch assembly.
- j. Disengage UHT from RTG cable reel and discard cable reel.
- k. Report ammeter reading.
- l. Remove shorting switch assembly dust cover and discard.
- m. Remove Central Station connector dust cover and discard.
- n. Mate power cable to Central Station and lock.

Emplace Package No. 1

- a. Engage UHT in Package No. 1 UHT socket.
- b. Use UHT as a handle to rotate Package No. 1 to the deployed position and align on E-W axis.

1+58 PSE DEPLOYMENT  
Deploy PSE

- a. Use UHT to release four Boyd bolts on PSE.
- b. Engage UHT in PSE carry socket.
- c. Use UHT to remove PSE from Sunshield and carry PSE to leveling stool.
- d. Remove PSE girdle and discard.
- e. Emplace PSE on leveling stool and align.

CDR ACTIVITIES

- f. Check thermal door open and facing away from central station.
- g. Photograph SWE

2+01 LSM OFFLOAD

Offload LSM from central station

- a. Use UHT to release two boyd bolts on LSM.
- b. Pull handle of upper support bracket fully upward, and then forward.
- c. Continue to lift upper support bracket/brace assembly clear of LSM and discard.
- d. Grasp lift-off handle, pull fully upward, and remove LSM from sunshield.
- e. Carry LSM approximately 10 feet toward the LSM deployment site.
- f. Retrieve carry handle and rotate LSM to vertical position.
- g. Place LSM on surface.

2+06 SUNSHIELD DEPLOYMENT

Release sunshield Boyd bolts

- a. Release Boyd bolts on forward-left edge of central station.
- b. Release Boyd bolt on SIDE connector housing and insure housing falls free from central station.
- c. Release Boyd bolts on west side of central station.
- d. Use UHT to remove antenna cable restraint and deploy cable.
- e. Release Boyd bolt on left antenna stowage bracket.

LMP ACTIVITIES

- f. Use UHT to deploy thermal shroud.
- g. Use UHT to level PSE.
- h. Report Alignment.
- i. Photograph deployed PSE.

2+06 LSM DEPLOYMENT

Deploy LSM

- a. Carry LSM to deployment site 50 feet from central station.
- b. Grasp carry handle and rotate LSM to vertical position.
- c. Grasp handle of lower half of upper support bracket, remove bracket from LSM and discard.
- d. Deploy three lunar support legs.
- e. Rotate LSM so color-coded Z-lunar support leg is oriented eastward and lower LSM to lunar surface.

#### CDR ACTIVITIES

- f. Release Boyd bolts on back side of central station.
- g. Release Boyd bolt on right antenna stowage bracket.
- h. Release Boyd bolts on right side of central station.
- i. Release Boyd bolts on right-front side of central station.
- j. Walk to a position behind the central station.
- k. Visually check sunshield clear to extend
- l. Release two interior Boyd bolts.
- m. Use UHT to restrain sunshield and release center Boyd bolt.
- n. Control sunshield extension with UHT.
- o. Complete sunshield deployment using manual assist.
- p. Remove three sunshield curtain covers and discard.
- q. Check proper deployment of side curtains.

#### LMP ACTIVITIES

- f. Use UHT to remove and discard foam packing.
- g. Use UHT to extend Y-sensor arm.
- h. Use UHT to extend Z-sensor arm.
- i. Use UHT to extend X-sensor arm.
- j. Retrieve PRA cover lanyard D-ring.
- k. Pull PRA cover from LSM and discard.
- l. Check LSM free of packing materials and pieces.
- m. Check PRA thermal doors open.
- n. Align LSM by grasping nearest boom and rotating LSM until gnomon dot shadow is centered on shadow graph.
- o. Observing bubble level, use UHT to level LSM.
- p. Report alignment to within 1° of azimuth orientation.
- q. Photograph deployed LSM.

#### 2+14 ANTENNA INSTALLATION Assemble Antenna

- a. Retrieve antenna mast from Sub-pallet.
- b. Install antenna mast on Central Station.



## CDR ACTIVITIES

- c. Return to subpallet and release antenna mechanism housing Boyd bolts.
- d. Engage UHT in aiming mechanism housing carry socket.
- e. Use UHT to lift aiming mechanism housing from subpallet.
- f. Remove cover from aiming mechanism housing and discard.
- g. Install aiming mechanism on antenna mast.
- h. Disengage UHT from aiming mechanism housing.
- i. Remove aiming mechanism housing and packaging and discard.
- j. Rotate antenna tie-down brackets retrieve antenna and install on aiming mechanism.

### Orient Antenna

- a. Check Central Station alignment.
- b. Enter azimuth offset.
- c. Enter elevation offset.
- d. Observing bubble lever, adjust leveling knobs.
- e. Observing sun compass adjust alignment knob.
- f. Recheck Antenna level and aligned.

## LMP ACTIVITIES

### 2+16 SIDE DEPLOYMENT Deploy SIDE/CCIG

- a. Engage UHT in SIDE/CCIG carry socket.
- b. Carry SIDE/CCIG to deployment site approximately 55 feet from Central Station.
- c. Place SIDE/CCIG on surface.
- d. Engage UHT in ground screen socket, rotate clockwise, and lift ground screen from tube.
- e. Check ground screen cable deployment.
- f. Emplace ground screen on lunar surface.
- g. Use UHT to release CCIG cover Deutsch fastener.
- h. Engage UHT in SIDE/CCIG carry socket and lift SIDE/CCIG from surface.
- i. Remove CCIG cover assembly and discard.
- j. Use lanyard to remove CCIG from stowage cavity.
- k. Emplace SIDE on ground screen with respect to subearth point. Use lanyard to lower CCIG to lunar surface.
- l. Orient CCIG orifice and release cable.
- m. Level SIDE and align by observing shadow cast on side of experiment.

CDR ACTIVITIES

2+25 ALSEP ACTIVATION  
Confirm with LMP that SIDE deployment has been completed.

Report shorting switch current

Depress shorting switch REPORT

Check the shorting switch did open by observing the shorting switch current is reading zero.

Engage UHT in astronaut switch No. 1 and turn the switch clockwise.

Request transmitter turn on from ground.

Confirm receipt of data by ground.

Discard UHT

Retrieve and tether tongs.

2+30 RETURN TRAVERSE  
Discard UHT

Retrieve tongs from subpallet and tether tongs to EMU

Return to the LM collecting selected samples enroute.

Report start and end of traverse

2+47 SRC #1 PACKING  
Remove and stow 70mm camera in ETB

Stow hammer and extension handle on ALHTC

Stow tongs on ALHTC

Unstow SRC #1 from MESA and place SRC on MESA table. Attach SRC retaining clips to SRC.

Release latches and open SRC #1

LMP ACTIVITIES TOA #10

Photograph deployed SIDE and CCIG.

Return to Central Station

2+26 ALSEP SITE PHOTOGRAPHY

Photograph Central Station

Photograph the LM with the Central Station in foreground

Photograph SWE

Photograph SIDE

2+30 RETURN TRAVERSE

Return to the LM collecting selected samples enroute.

Pick up TV camera enroute and carry the camera back to the MESA area.

Position TV camera 20 feet from LM at 2 o'clock to view MESA area.

Photograph ALSEP site from LM area.

## CDR ACTIVITIES

Attach scale to MESA

Stow flat bag dispenser on ALHTC

Stow core tube and cap on ALHTC

Seal organic control sample

Remove side bags. Temporarily stow one in SRC and attach other to scale

Scoop loose material into side bag on scale until specified weight or volume is reached.

Close and place bag in SRC

Attach second side bag to scale

Check weight of side bag

Close and place bag in SRC

Pack and seal SRC

Check two 70mm cameras are inside ETB then close ETB top flap.

Rest and check EMU

## LMP ACTIVITIES

Remove side bags.

2+52 CORE TUBE SAMPLE  
Retrieve and assemble core tube and extension handle.

Drive the core tube into the surface.

Withdraw the core tube.

Stow the hammer on the ALHTC.

Retrieve and attach cap to core tube.

Remove and stow extension handle on ALHTC.

Place core tube in SRC.

Assist CDR if required.

2+58 EVA TERMINATION  
Stow 70mm camera in ETB.

Clean EMU and check all surface equipment has been removed from CDR's EMU.

Ascend to platform.

Ingress the LM.

Check the EMU and LM systems.

Move the S-BAND ANT switch to LUNAR STAY.

## CDR ACTIVITIES

Perform a communications check with ground.

Remove the ETB from stowage on the MESA

Carry the ETB to a position in front of the LM.

Transfer the ETB into the LM cabin.

Rest and check the EMU.

Transfer the ETB hooks back to the surface

Attach the LEC to the SRC

Release the SRC restraint clips and lift the SRC from the MESA table.

Carry the SRC to a position in front of the LM

Transfer the SRC into the LM cabin

### 3+17 EVA TERMINATION

Remove from stowage and place SRC #2 in the +Y footpad in the sunlight.

Clean the EMU of loose material.

Ascend to the platform.

Pull the LEC from the LM cabin and stow the LEC on the LM platform.

Ingress the LM.

Jettison equipment and close the LM hatch

Repressurize cabin.

End of 1st EVA.

## LMP ACTIVITIES

Perform a communications check with ground and the CDR.

Assist the CDR in transferring the ETB.

Remove the ETB from the LEC.

Stow the ETB on the engine cover.

Assist the CDR in transferring the SRC.

Remove the SRC from the ETB.

Stow the SRC on the Engine cover.

Pass the LEC to the CDR.

### 3.2.3 EVA 2 Timeline Description and Rationale

The second EVA is designed to perform a detailed lunar geology field experiment to obtain a better understanding of the nature and origin of the lunar maria, and the processes which have modified the mare surfaces through the study of lunar topographic features and the collection of documented lunar material samples. Additionally, if the distance between the LM landing site and the Surveyor III is within the traverse constraints of the EMU's, this EVA will obtain data from the Surveyor III on the effects of prolonged exposure to radiation, thermal cycling, vacuum environment and micrometeorites as related to the Surveyor III spacecraft.

The following is a narrative description of the CDR and LMP activities during EVA 2. See Figures 3-6 and 3-7 for detailed timeline data.

EVA 2 will begin approximately 15 hours after the end of EVA 1. The CDR will egress first, with the LMP remaining in the LM to assist with the ETB transfer (70mm cameras) to the surface. After the ETB transfer, the LMP will descend to the surface and the CDR will begin to remove the lunar hand tools from the MESA and stow them on the Apollo Lunar Hand Tool Carrier (ALHTC). He will also retrieve SRC #2 from the LM footpad, place it on the MESA table and unstow its contents. While the CDR is performing this activity, the LMP will attach the Surveyor parts bag to CDR's PLSS and stow cutting tool in the bag, photograph the contrast charts on the surface (See Figure 3-8) and position the TV to view the geology traverse.

The geology traverse area will be largely determined by the Surveyor III location. The crew will perform a lunar field geology experiment enroute to the Surveyor III collecting documented lunar material samples. Both crewmen will participate in collecting a lunar environment sample of lunar surface material; core samples (2) of lunar material; describing, photographing and collecting lunar geologic samples for return to earth; collecting a gas analysis sample of lunar surface material; and studying and describing field relationships of all accessible types of lunar topographic features.

The CDR and LMP will descend into the crater containing the Surveyor III and collect samples of lunar material including lunar bedrock, layered rock and rounded rocks in ray patterns. The LMP, will obtain photographs (See Figure 3-10) of lunar material in the vicinity of and deposited on the Surveyor III spacecraft as well as several photos of the Surveyor spacecraft equipment. The CDR will read the LMP's checklist during the LMP's

photography and then cut the TV camera, a piece of the TV camera electrical cable and a polished aluminum tube from the Surveyor using the cutting tool. The LMP will assist the CDR in the cutting task and will stow the equipment in the Surveyor parts bag on the CDR's PLSS. In addition, if feasible and safe, the CDR and LMP will collect pieces of glass from the Surveyor III spacecraft mirrors and report on the extent of debonding.

After completing the Surveyor III site activities, the crewmen will return to the LM collecting further geologic samples, as time permits. The LMP will reposition the TV to view the MESA and ladder, and when he and the CDR arrive at the LM he will remove the Surveyor parts bag from the CDR's PLSS and place it in the +Z footpad to await later transfer into the LM. Additionally, the LMP will remove and place his 70mm camera in the ETB and place his side bag (containing the Surveyor site geologic samples) on the MESA. The CDR, on returning to the MESA area, will remove his 70mm camera and place it in the ETB along with the LMP's camera magazine (color). He will also stow the Surveyor site geological samples in the SRC #2 while he is at the MESA. He will then retrieve the SWC, go back to the MESA, remove the SWC foil and pack it in SRC #2. The last items to be packed in SRC #2 are the documented geological samples collected in the ALHTC. The CDR will remove these samples from the ALHTC, pack them in the SRC and close and seal it. While the CDR is closing out the SRC, the LMP will retrieve the ALSCC and obtain close-up photos of lunar surface features. On completion of this task, he will remove the ALSCC film cassette and place it in the ETB.

The LMP will clean his EMU after completing the stereo close-up photography and ingress the LM and perform a brief LM systems check. Meanwhile, the CDR will attach the ETB to the LEC, and with LMP assistance, transfer the ETB, SRC #2 and the Surveyor parts bags into the LM, performing three separate LEC transfers.

Upon completion of the third LEC transfer, the CDR will clean his EMU and pull the LEC from the LM and discard it. He will then ingress the LM, ending the second EVA.

A GO-NO GO for extension of EVA 2 to 4 hours will be given the crew during their return traverse prior to their reaching the LM. The additional 30 minutes will be utilized to obtain additional geological samples from the lunar surface (See Figures 3-6 and 3-7). The technique for collecting these samples will be the same as previously mentioned at the beginning of EVA 2 during the geology traverse. The close out of the EVA, upon return of the crew to the LM, will be the same as previously mentioned in the 3.5 hour EVA period above.

FIGURE 3-6 APOLLO 12 SUMMARY TIMELINE  
NOMINAL LUNAR SURFACE EVA 2

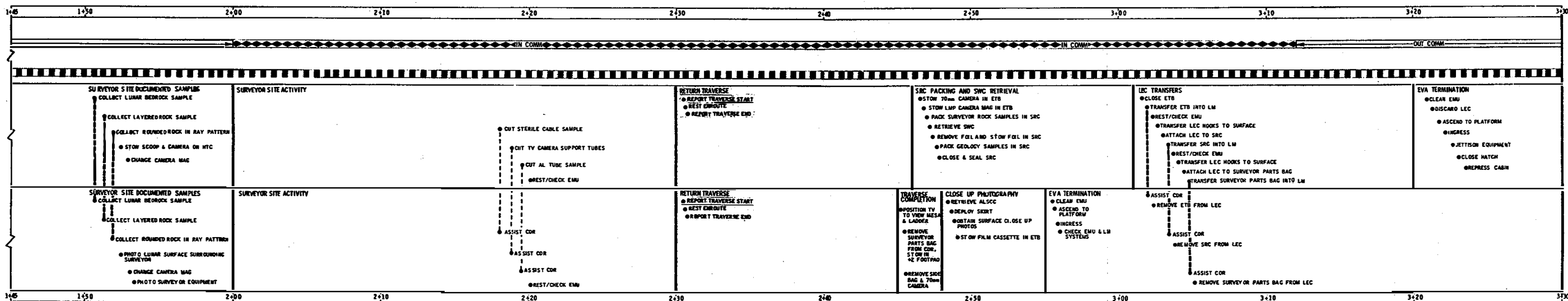
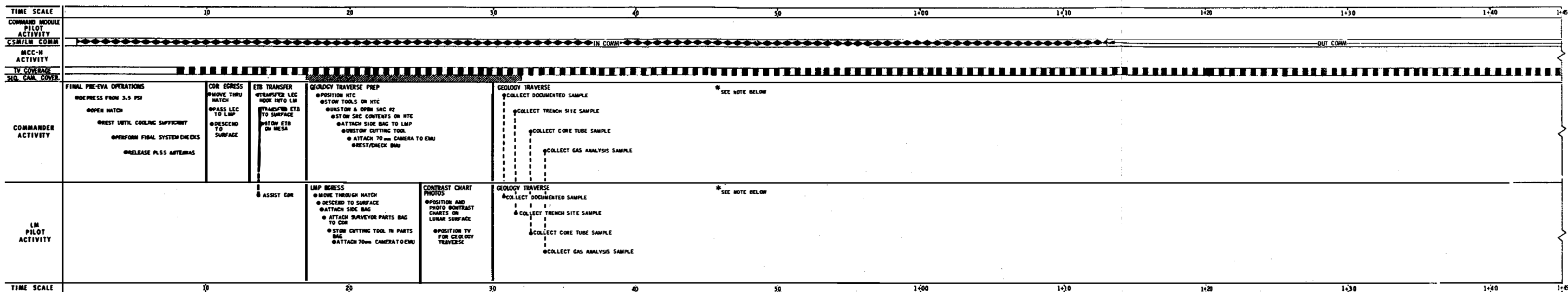

\* NOTE: IN THE EVENT AN EXTENSION OF THE EVA TO 4.0 HOURS IS DESIRED, THE ADDITIONAL 30 MINUTES WILL BE ADDED TO THE "GEOLOGY TRAVERSE" TIME BLOCK ABOVE.

**LEGEND**

- EVENT LINE: A vertical line with a horizontal bar at the top.
- SEPARATES MAJOR BLOCKS OF ACTIVITY: A vertical line with a horizontal bar at the top.
- COORDINATED TASKS: A vertical line with a horizontal bar at the top.
- SEQUENCE CAMERA COVERAGE: A shaded area with diagonal lines, labeled "FRAMES/SEC".
- NO COVERAGE: An unshaded area, labeled "NO COVERAGE".
- TV COVERAGE: A shaded area with horizontal lines, labeled "COVERAGE".
- NO COVERAGE: An unshaded area, labeled "NO COVERAGE".

NOTE: ACTIVITY TIMES WITHIN AN EVENT NOT FIXED.

NAME	INITIAL	ORIGIN	NATIONAL AERONAUTICS & SPACE ADMINISTRATION
T. MONTGOMERY	J.S.	LSOO	MANAGED SPACECRAFT CENTER - HOUSTON, TEXAS
DR/W: NDAH		GC	

APOLLO 12 SUMMARY TIMELINE  
NOMINAL LUNAR SURFACE EVA 2  
FIGURE 3-6  
BASIC OCTOBER '69

FIGURE 3-7  
APOLLO TWELVE  
MISSION H-1

# NOMINAL TIMELINE LUNAR SURFACE EVA 2

## CDR ACTIVITIES

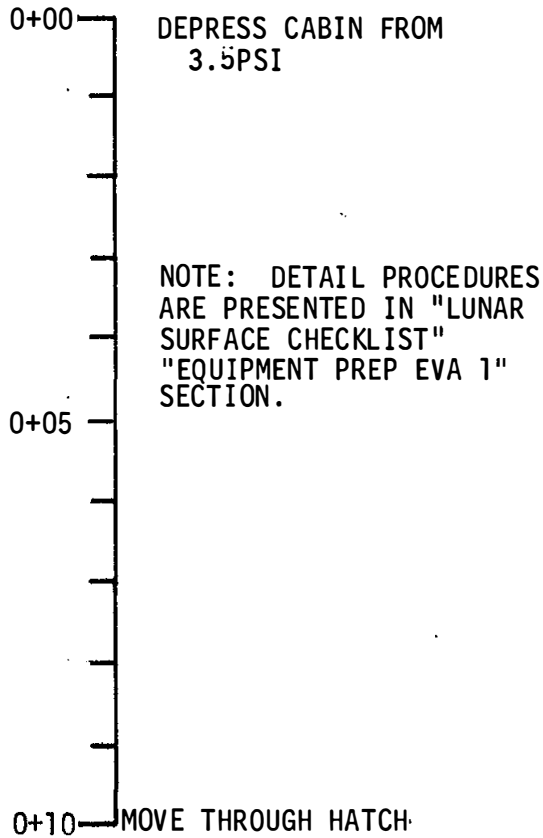

## LMP ACTIVITIES

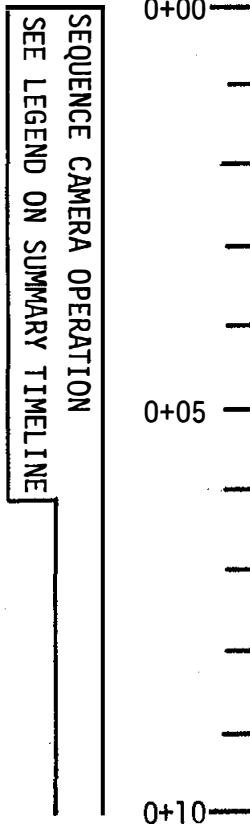



## CDR ACTIVITIES

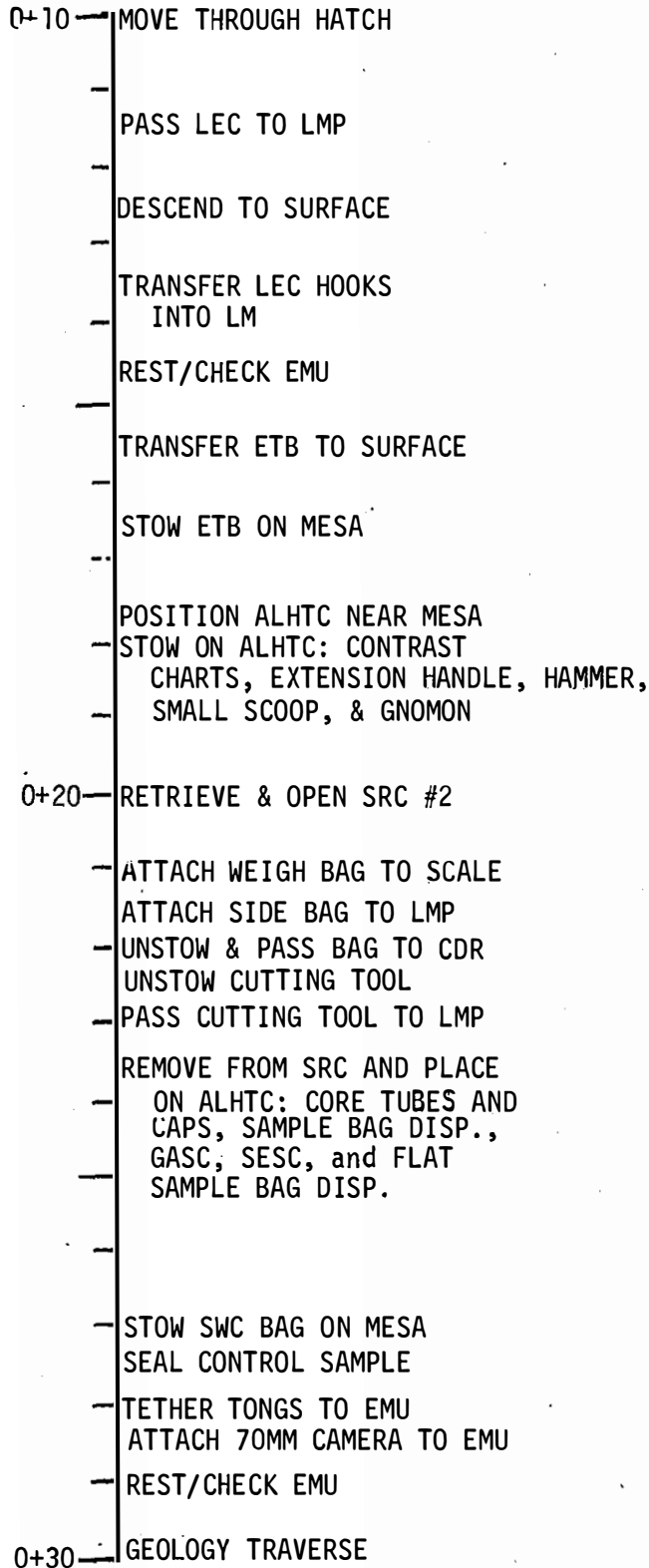

## LMP ACTIVITIES

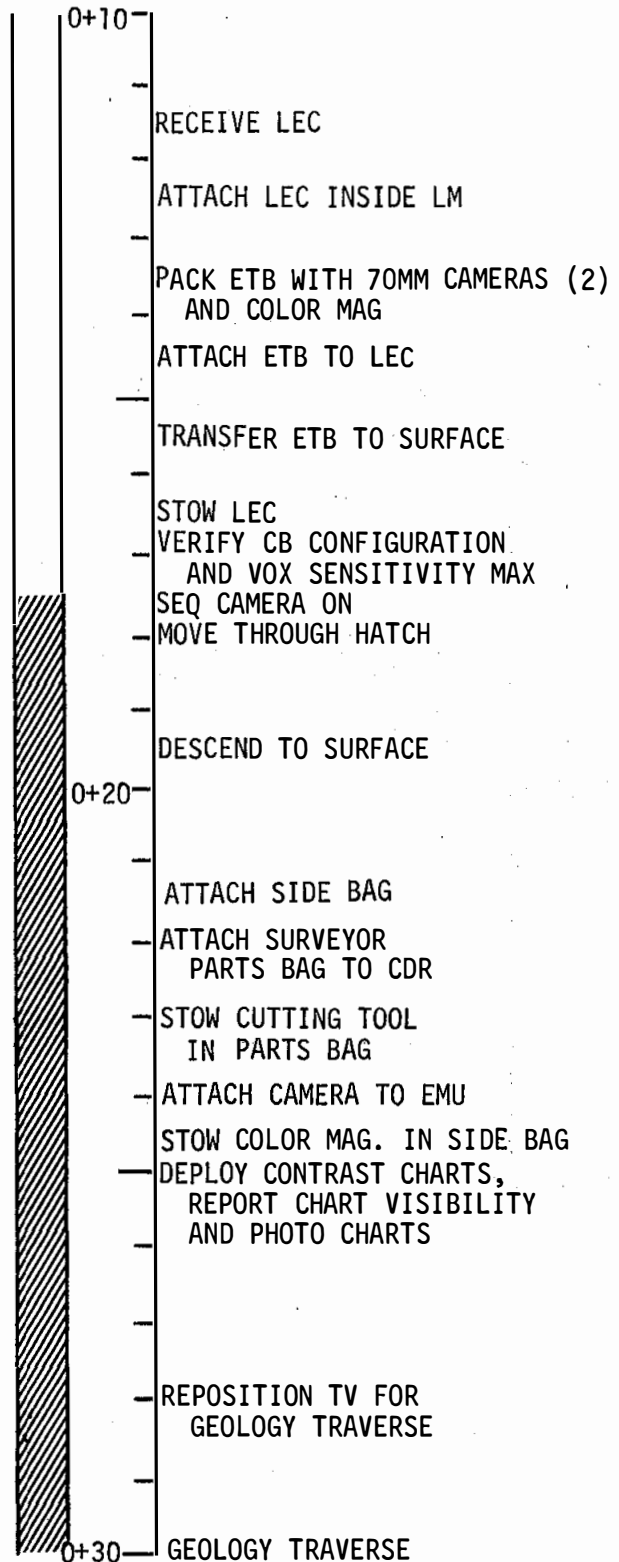

## CDR ACTIVITIES

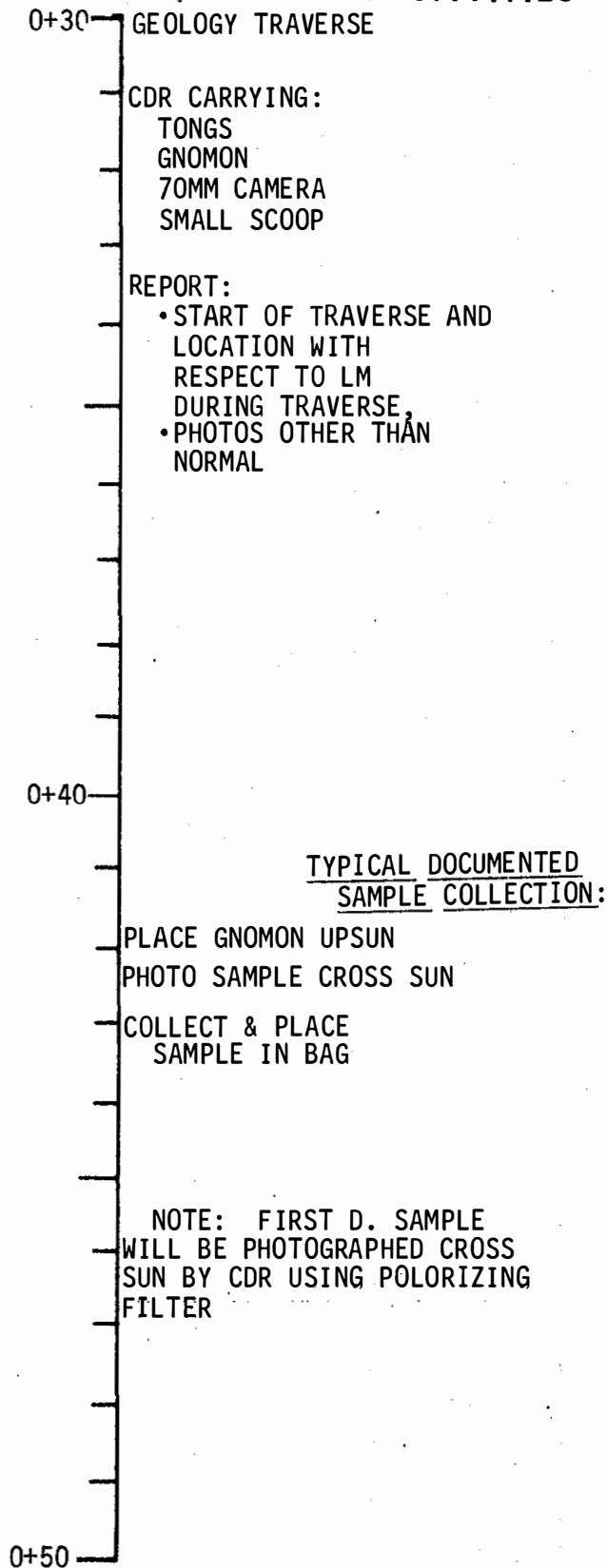

## LMP ACTIVITIES

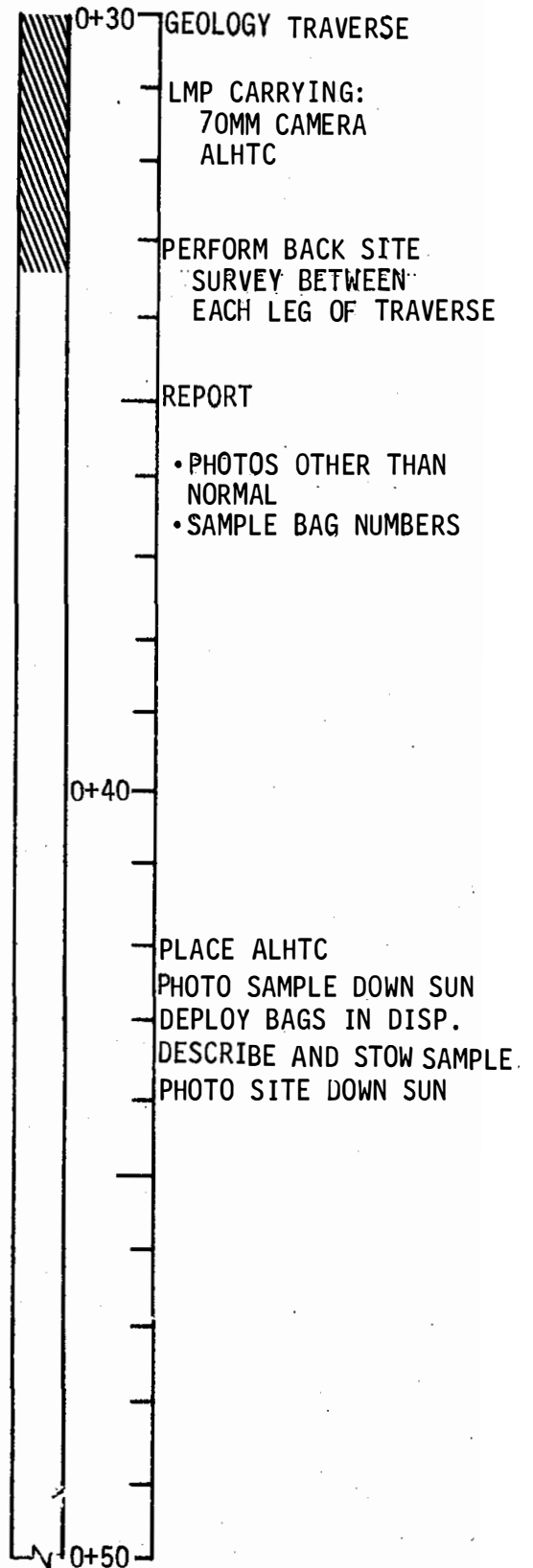

## CDR ACTIVITIES

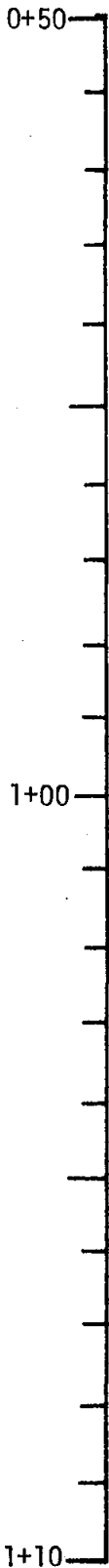

GEOLOGY TRAVERSE  
(CONTINUED)

TYPICAL CORE TUBE  
SAMPLE COLLECTION:

PLACE GNOMON UPSUN  
PHOTO SITE CROSS SUN

## LMP ACTIVITIES

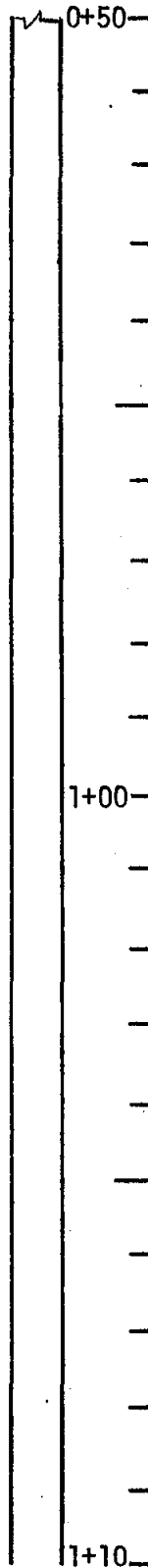

GEOLOGY TRAVERSE  
(CONTINUED)

PLACE ALHTC  
PHOTO SITE DOWN SUN  
ASSEMBLE CORE TUBE/HANDLE  
REMOVE HAMMER FROM ALHTC  
DRIVE TUBE INTO SURFACE  
PHOTO CORE TUBE DOWN SUN  
PULL CORE TUBE FROM SURFACE  
STOW HAMMER ON ALHTC  
CAP CORE TUBE

REMOVE & STOW HANDLE  
STOW SAMPLE IN ALHTC

## CDR ACTIVITIES

1+10

GEOLOGY TRAVERSE  
(CONTINUED)

SAMPLING AT SURFACE  
TRENCH SITE:

PLACE GNOMON UPSUN  
PHOTO SITE CROSS SUN  
DIG TRENCH ALONG SUNLINE

FILL SESC WITH SUB-  
SURFACE MATERIAL

REMOVE SCOOP FROM EXTENSION HANDLE

ASSEMBLE CORE TUBE AND  
EXTENSION HANDLE

1+20

PASS CORE TUBE TO LMP

1+30

## LMP ACTIVITIES

1+10

GEOLOGY TRAVERSE  
(CONTINUED)

PLACE ALHTC  
PHOTO SITE DOWN SUN  
RETRIEVE SESC FROM ALHTC  
OPEN SESC  
HOLD SESC FOR FILLING

REMOVE SEAL PROTECTOR  
AND SEAL SESC  
STOW SESC IN HTC

1+20

PHOTO TRENCH DOWN SUN  
REMOVE HAMMER FROM ALHTC  
DRIVE TUBE IN TRENCH

PHOTO TUBE DOWN SUN  
PULL TUBE FROM SURFACE  
STOW HAMMER ON ALHTC  
CAP CORE TUBE

REMOVE & STOW HANDLE  
STOW SAMPLE IN ALHTC

1+30

## CDR ACTIVITIES

1+30 GEOLOGY TRAVERSE  
(CONTINUED)

GAS ANALYSIS SAMPLE  
COLLECTION

PLACE GNOMON UPSUN  
PHOTO SAMPLE CROSS SUN  
COLLECT SAMPLE USING  
TONGS  
PLACE SAMPLE IN  
CONTAINER

1+40

NOTE: THE LAST THREE DOCUMENTED  
SAMPLES ON THIS TRAVERSE  
LEG WILL BE FROM SURVEYOR  
SITE.

1. LUNAR BEDROCK
2. LAYERED ROCK
3. ROUNDED ROCK FROM  
RAY PATTERN

"THE CREW MAY ELECT TO LEAVE  
THE ALHTC ON THE CRATER RIM  
AND COLLECT ABOVE SAMPLES  
IN LMP SIDE BAG

2+00 SURVEYOR SITE ACTIVITIES

## LMP ACTIVITIES

1+30 GEOLOGY TRAVERSE  
(CONTINUED)

PLACE ALHTC  
PHOTO SAMPLE DOWN SUN  
RETRIEVE CONTAINER FROM ALHTC  
OPEN GASC  
HOLD GASC FOR SAMPLE

REMOVE SEAL PROTECTOR  
CLOSE AND SEAL GASC  
STOW SAMPLE IN ALHTC

1+40

2+00 SURVEY SITE ACTIVITIES

## CDR ACTIVITIES

2+00 STOW SCOOP & 70MM CAMERA  
ON ALHTC  
ASSIST LMP IN CHANGING  
FILM MAGAZINE  
WALK TO SURVEYOR SITE  
  
READ LMP CHECKLIST  
  
2+10 WALK TO TV CAMERA AREA  
  
CUT STERILE CABLE SAMPLE  
CUT TWO TV CAMERA  
SUPPORT TUBES  
CUT ALUMINUM TUBE  
SAMPLE  
2+20

## LMP ACTIVITIES

2+00 REMOVE B&W MAG FROM 70MM  
CAMERA  
INSTALL COLOR MAG ON 70MM  
CAMERA  
WALK TO SURVEYOR SITE  
  
PHOTOGRAPH BAY A  
PHOTO SECTOR C  
STEREO PHOTO AREA 2  
STEREO PHOTO AREA 1  
DISTURB AREA 1  
STEREO PHOTO AREA 1  
PHOTO VERNIER ENGINE #2  
PHOTO COMPARTMENT A  
PHOTO KLYSTRON POWER SUPPLY  
WIPE TOP AND PHOTO PWR SUPPLY  
  
2+10 PHOTO BAY B  
PHOTO SOLAR ARRAY  
PHOTO FOOT PAD #3  
STEREO PHOTO AREA 3  
PHOTO TV MIRROR  
WIPE AND PHOTO TV MIRROR  
UNSTOW AND PASS CUTTING  
TOOL TO CDR  
UNSTOW AND OPEN SESC  
REMOVE SEAL PROTECTOR  
CATCH SAMPLE IN SESC  
CLOSE AND SEAL SESC  
STOW SESC IN PARTS BAG  
CATCH ALUMINUM TUBE  
SAMPLE  
2+20 STOW SAMPLE IN PARTS BAG

## CDR ACTIVITIES

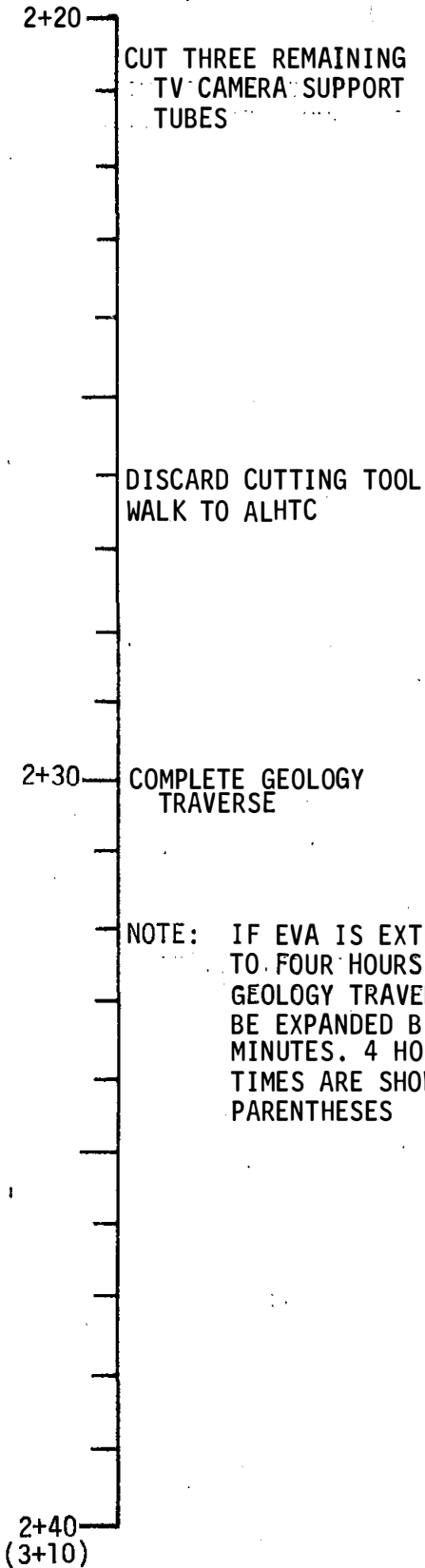

## LMP ACTIVITIES

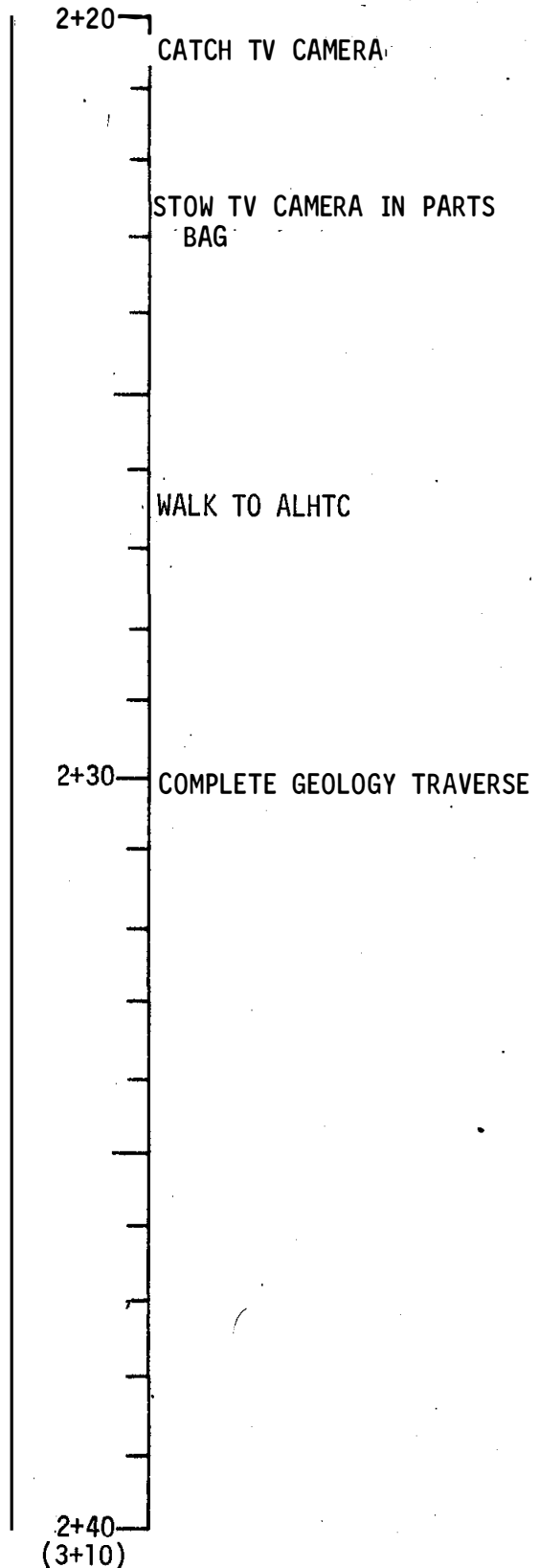

## CDR ACTIVITIES

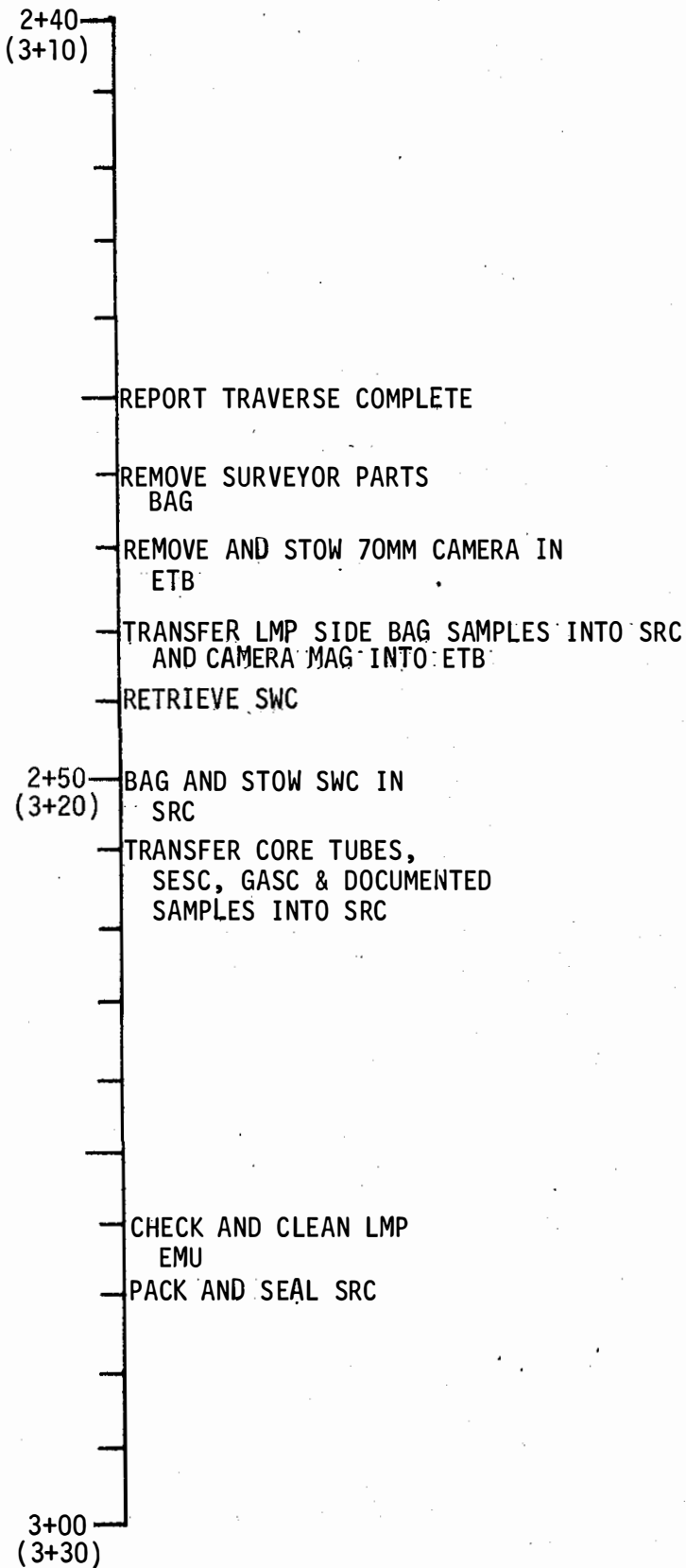

## LMP ACTIVITIES

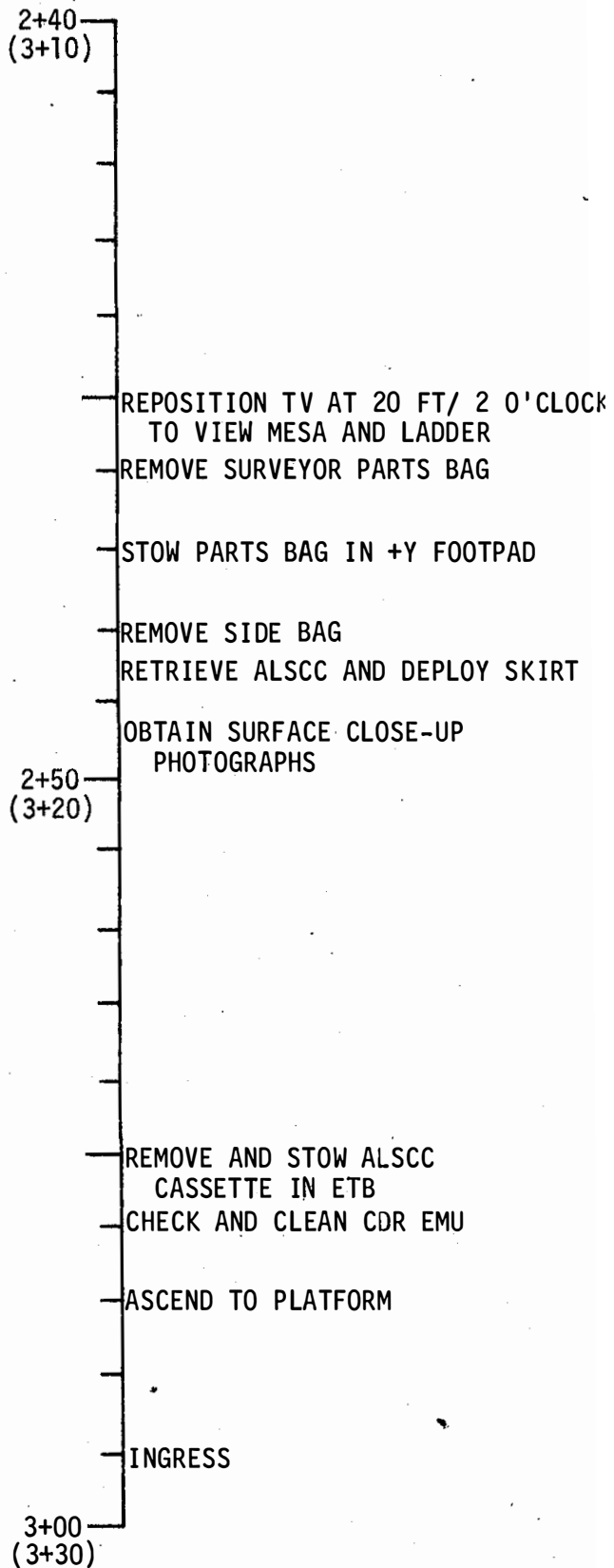



## CDR ACTIVITIES

3+00  
(3+30)

- CLOSE ETB TOP FLAP
- TRANSFER ETB INTO LM
- REST/CHECK EMU
- TRANSFER LEC HOOKS TO SURFACE
- ATTACH LEC TO SRC
- TRANSFER SRC INTO LM

3+10  
(3+40)

- REST/CHECK EMU
- TRANSFER LEC HOOKS TO SURFACE
- POSITION PARTS BAG ON MESA TABLE
- ATTACH LEC TO PARTS BAG
- TRANSFER PARTS BAG INTO LM

3+20  
(3+50)

- CLEAN EMU

## LMP ACTIVITIES

3+00  
(3+30)

- CHECK EMU AND LM SYSTEMS
- ASSIST CDR
- REMOVE ETB FROM LEC
- STOW ETB

3+10  
(3+40)

- ASSIST CDR
- REMOVE SRC FROM LEC
- STOW SRC

3+20  
(3+50)

- ASSIST CDR
- REMOVE PARTS BAG FROM LEC

## CDR ACTIVITIES

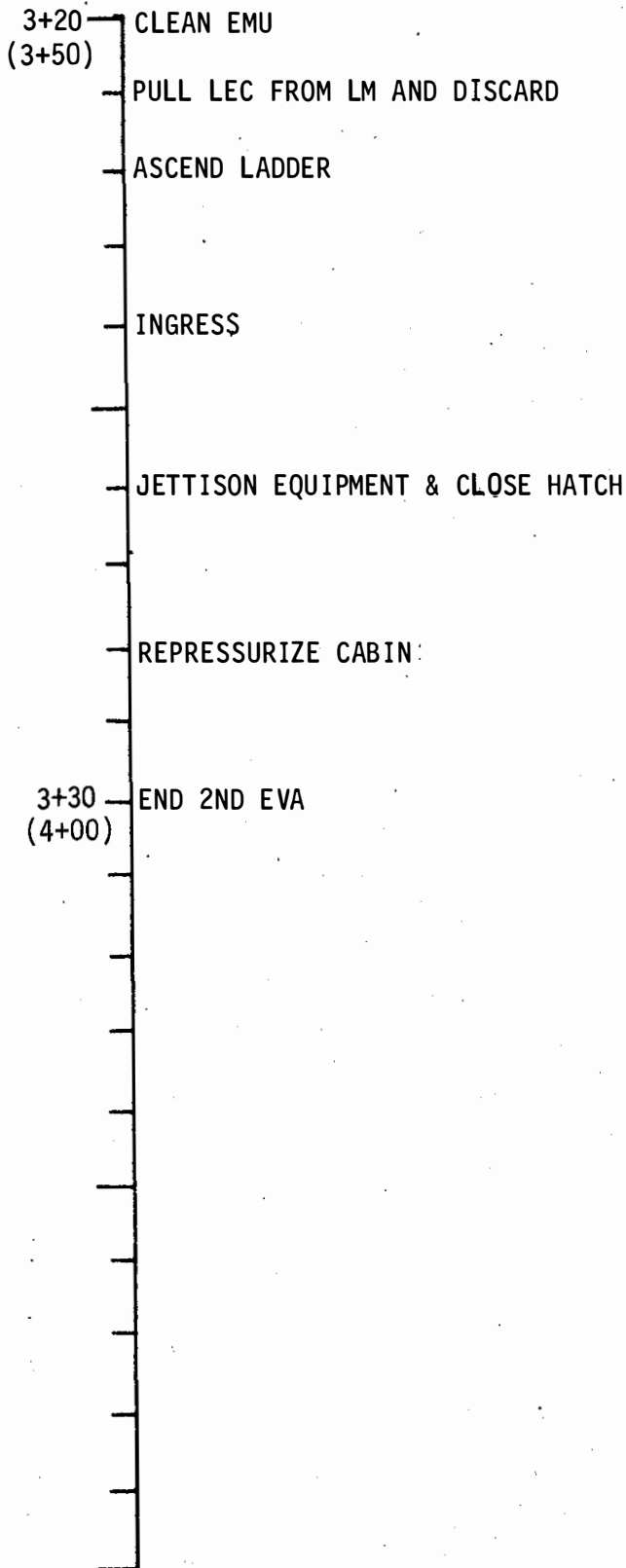

## LMP ACTIVITIES

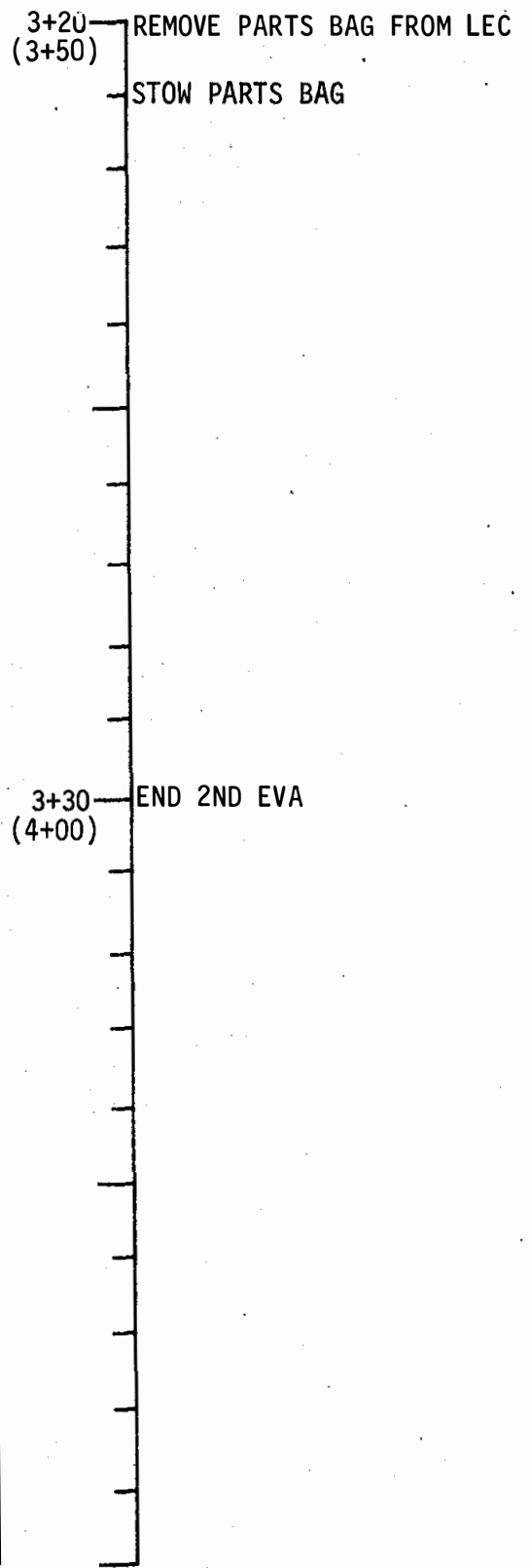

### 3.2.4 EVA 2 Detailed Procedures

#### CDR ACTIVITIES

##### 0+00 FINAL PREP-EVA OPERATIONS

NOTE: Detail procedures for the first ten minutes are presented in the "LUNAR SURFACE CHECKLIST."

##### 0+10 CDR EGRESS

Move through the hatch to a position on the platform

Retrieve the LEC then pass it into the cabin to the LMP

Descend the LM ladder to the surface

##### 0+13 ETB TRANSFER

Retrieve the LEC strap and transfer the LEC hooks into the LM cabin

Transfer the ETB to the surface

Stow the ETB on right side of MESA

##### 0+17 GEOLOGY TRAVERSE PREP

Position the ALHTC near the MESA

Stow on the ALHTC:

- a. Contrast charts (3)
- b. Extension handle
- c. Hammer
- d. Small scoop
- e. Gnomon

Retrieve and open SRC #2

- a. Retrieve SRC #2 from +Y footpad
- b. Position SRC on MESA table
- c. Attach retaining clips to SRC
- d. Release latches and open SRC

#### LMP ACTIVITIES

Receive the LEC from the CDR

Attach the LEC to the overhead handhold

Check the ETB contains two 70mm cameras and one 70mm color magazine

Attach the ETB to the LEC

Assist CDR

Disconnect the LEC from the overhead handhold & stow it.

Check the LM circuit breakers are properly configured and the VOX sensitivity on the RCU is turned to maximum

Turn sequence camera on at 6 FPS and leave the camera pointing to site where the contrast charts will be deployed.

##### 0+18 LMP EGRESS

Move through the hatch and descend the ladder to the surface

## CDR ACTIVITIES

Attach weigh bag to scale

Attach side bag to LMP

Unstow surveyor parts bag

- a. Pull pip pin to release retaining bar
- b. Move retaining bar from over surveyor parts bag
- c. Grasp loop on top of bag and lift parts bag from MESA stowage
- d. Pass parts bag to LMP

Unstow the surveyor cutting tool

- a. Pull two pip pins
- b. Pull handle retaining clip from cutting tool
- c. Lift cutting tool from stowage on the MESA

## LMP ACTIVITIES

Attach the LMP side bag

Attach surveyor parts bag to CDR'S PLSS

- a. Remove the two snap straps from around the parts bag and discard
- b. Unroll the parts bag, catching the crew safety line as the bag unrolls
- c. Temporarily stow the safety line on the MESA
- d. Attach the upper-left support strap to the left side of the OPS
- e. Attach the lower-left support strap to the left side of the PLSS
- f. Center the parts bag on the CDR'S PLSS
- g. Attach the upper-right support strap to the right side of the OPS

## CDR ACTIVITIES

Pass cutting tool to LMP

Remove from SRC #2 and place on the ALHTC:

- a. Core tubes and caps
- b. Sample bag dispenser
- c. Gas Analysis Sample Container (GASC)
- d. Special Environmental Sample Container (SESC)
- e. Flat sample bag dispenser

Stow SWC bag on MESA

Seal the organic control sample

Tether tongs to the EMU

Attach 70mm camera to EMU

## LMP ACTIVITIES

- h. Attach the lower-right support strap to the right side of the PLSS
- i. Tighten right side support straps

Stow cutting tool in Surveyor scoop pocket on surveyor parts bag

Connect cutting tool retaining strap and tighten strap

Remove the 70mm camera, without polarizing filter, and attach the camera to the RCU

Remove the 70mm color magazine from the ETB and stow the magazine in the side bag. Retrieve the safety tether & stow in side bag

### 0+25 CONTRAST CHART PHOTOGRAPHS

Accomplish the contrast chart visibility experiment. See Figure 3-8.

- a. Remove the contrast charts from the ALHTC
- b. Deploy one chart in the shadow of a crater, report the visibility reading and photograph the chart up sun.
- c. Deploy another chart on the illuminated side of a crater, report the visibility reading and photograph the chart down sun
- d. Deploy the third chart on a level surface in the sunlight, report the visibility reading and photograph the chart cross sun

Reposition the TV camera for the geology traverse.

CONTRAST CHART PHOTOS

• REPORT-CHART VISIBILITY

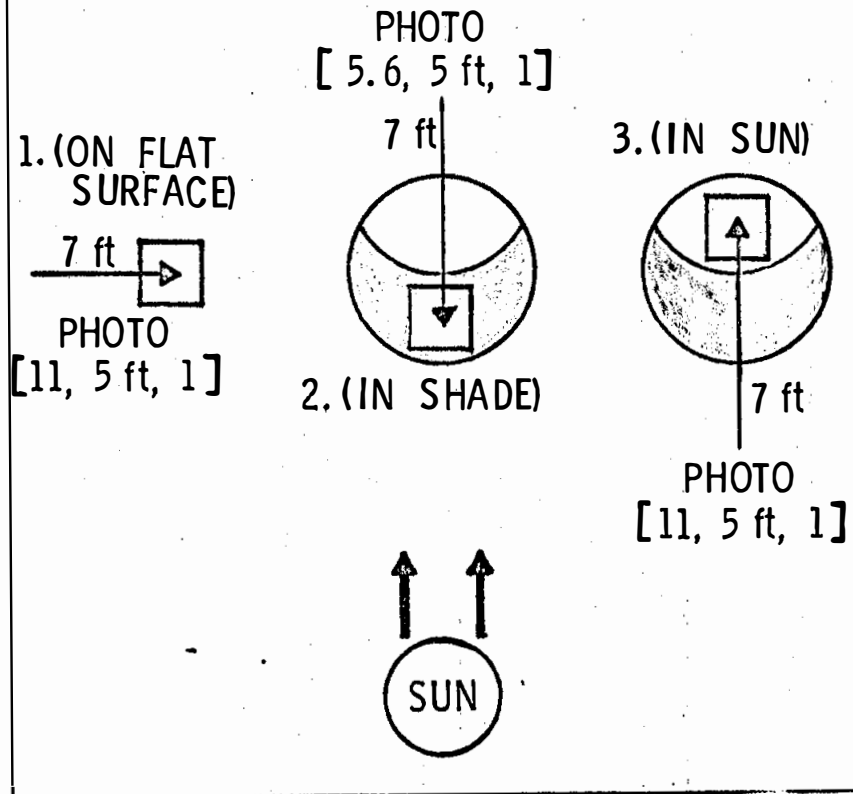

FIGURE 3-8 LMP CONTRAST CHART PHOTOS

## CDR ACTIVITIES

### 0+30 GEOLOGY TRAVERSE

Carry tongs, gnomon, 70mm camera and small scoop on traverse

Report the start of the traverse, the crew's location with respect to the LM during the traverse, and photographs taken that are not required.

The first documented sample will be photographed using a polarizing filter on the CDR's 70mm camera. See Figure 3-9.

## LMP ACTIVITIES

### 0+30 GEOLOGY TRAVERSE

Carry ALHTC and 70mm camera on traverse

During the traverse report the photographs taken that are not required and the sample bag numbers as the samples are taken

Perform backsite survey between each leg of the traverse:

- a. Photograph surface cross sun in both directions
- b. Photograph the LM

### TYPICAL DOCUMENTED SAMPLE COLLECTION

Place gnomon up sun of sample

Photograph the sample cross sun in stereo

Collect and place the sample in the sample bag

Place the ALHTC on the surface

Photograph the sample down sun

Deploy the sample bag in the bag dispenser

Describe and stow the sample in the ALHTC

Photograph the sample site down sun

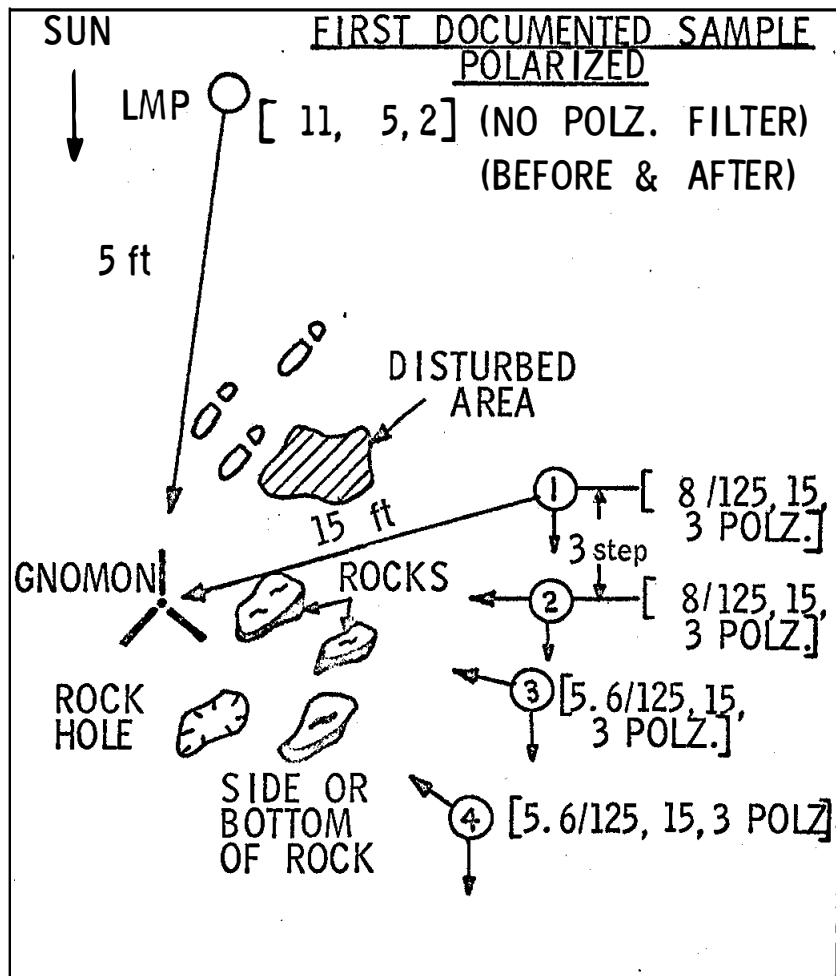

**FIGURE 3-9 CDR POLARIZING FILTER PHOTOS**



CDR ACTIVITIES

LMP ACTIVITIES

TYPICAL CORE TUBE SAMPLE COLLECTION

Place gnomon up sun of core tube  
sample site

Photograph the core tube site  
cross sun in stereo

Place ALHTC on the surface

Photograph the core tube site  
down sun

Assemble the core tube and  
extension handle

Remove the hammer from the ALHTC

Drive the core tube into the  
surface

Photograph the core tube in the  
surface down sun

Pull the core tube from the sur-  
face

Stow the hammer on the ALHTC

Remove the core tube bit and  
attach the core tube cap

Detach the extension handle from  
the core tube and stow the handle  
and core tube on the ALHTC.

TRENCH SITE SAMPLE COLLECTION

(These samples will be taken at the most distant point in the traverse  
from the LM)

Place gnomon up sun of trench  
site

Photograph the trench site cross  
sun in stereo

Dig the trench along the sunline

Fill the SESC with subsurface  
material

Place ALHTC on surface

Photograph the trench site down  
sun

Retrieve SESC from the ALHTC

Remove the SESC lid

Hold the SESC for CDR

### CDR ACTIVITIES

Remove scoop from extension handle and stow scoop on ALHTC

Assemble the core tube and extension handle

Pass core tube to LMP

### LMP ACTIVITIES

Remove the seal protector from the SESC

Close and seal the SESC

Stow the SESC on the ALHTC

Photograph the trench down sun

Retrieve hammer from ALHTC

Drive core tube into trench

Photograph the core tube down sun

Pull the core tube from the surface

Stow the hammer on the ALHTC

Remove the core tube bit and attach the core tube cap.

Detach the extension handle from the core tube and stow the handle and core tube on the ALHTC

### GAS ANALYSIS SAMPLE COLLECTION

Place gnomon up sun of sample

Photograph the sample cross sun in stereo

Collect sample using tongs

Place sample in GASC

Place ALHTC on surface

Photograph sample down sun

Retrieve GASC from ALHTC

Remove cover from GASC

Hold GASC for CDR

Remove the seal protector from the GASC

Close and seal the GASC

Stow GASC on the ALHTC

## CDR ACTIVITIES

NOTE: The last three documented samples on this section of the traverse will be taken from the Surveyor III crater. The three samples will be of:

- a. Lunar bedrock
- b. Layered rock
- c. Rounded rock from a ray pattern

The crew may elect to leave the ALHTC on the crater rim and collect the above samples in the LMP side bag

### 2+00 SURVEYOR SITE ACTIVITIES

Stow the scoop and 70mm camera on the ALHTC

Remove the color magazine from the LMP side bag and pass it to the LMP

Assist the LMP install the color magazine

Walk to Surveyor III spacecraft

Read the LMP checklist

## LMP ACTIVITIES

### 2+00 SURVEYOR SITE ACTIVITIES

Remove the black and white film magazine from the 70mm camera and stow the magazine in the side bag

Install the color magazine on the 70mm camera

Walk to Surveyor III Spacecraft

Photograph the Spacecraft on surface as the CDR reads the checklist. See figure 3-10.

- a. Photograph Bay A
- b. Photograph the surface, sector C, that was viewed by the surveyor TV camera.
- c. Photograph the scoop imprint area in stereo
- d. Photograph footpad 2 imprint area in stereo
- e. With the lunar boots, scuff the surface near the footpad 2 imprints

FIGURE 3-10 SURVEYOR INVESTIGATION ACTIVITIES

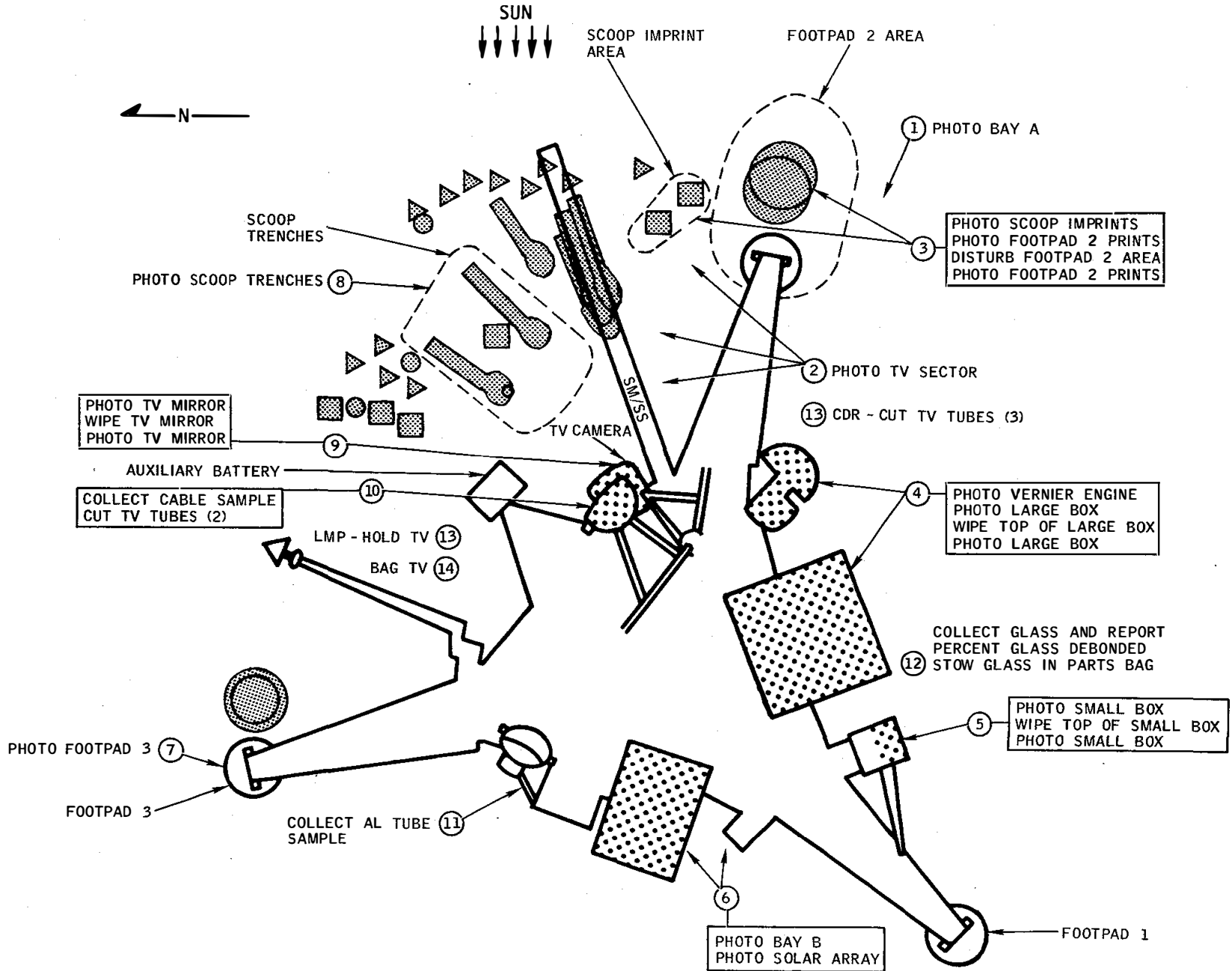

CDR ACTIVITIES

LMP ACTIVITIES

- f. Photograph vernier engine in Bay A
- h. Photograph compartment, large box, in Bag A
- i. If it appears safe to do so, wipe top of compartment A
- j. Photograph compartment A.
- k. Photograph Klystron power supply.
- l. Wipe top of Klystron power supply
- m. Photograph top of Klystron power supply
- n. Photograph Bay B
- o. Photograph solar array.
- p. Photograph footpad 3
- q. Photograph scoop trenches in stereo
- r. Photograph TV camera mirror
- s. Wipe the TV camera mirror
- t. Photograph TV camera mirror

Accept the cutting tool from the LMP

Remove cutting tool from the surveyor parts bag on the back of CDR'S PLSS and pass tool to CDR

Remove the SESC from the pocket in the parts bag

Open the SESC and remove the seal protector

Cut a length of TV cable approximately 4 inches, from the spacecraft

Catch the cable sample in the SESC

Cut two TV camera support tubes

Stow the SESC in the pocket provided on the parts bag

## CDR ACTIVITIES

Cut a sample of aluminum tube, approximately six inches in length, from bag B of the spacecraft

Cut the three remaining TV camera support tubes

### 2+30 RETURN TRAVERSE

Report start and end of the traverse

### 2+45 SRC PACKING AND SRC RETRIEVAL

Remove surveyor parts bag

Remove and stow 70mm camera in ETB

Remove LMP's side bag, empty geology samples, if any, into SRC and stow 70mm mag in ETB

## LMP ACTIVITIES

Catch the aluminum tube with the EVA glove as the CDR cuts the tube

Stow the tube sample in the pocket provided on the parts bag

If it appears safe to do so, collect a sample of glass from the top of compartment A. Estimate the percentage of the glass that has debonded.

Stow the glass sample in the pocket provided on the parts bag

Walk to sector C and catch the TV camera as the CDR cuts the three remaining TV camera support tubes

Stow the TV camera in the parts bag.

### 2+30 RETURN TRAVERSE

### 2+45 TRAVERSE COMPLETION

Reposition the TV camera to 20 feet at 8 o'clock to view the MESA and ladder

Remove surveyor parts bag from CDR'S PLSS

- a. Release the snaps on the four support straps
- b. Place the parts bag in the +Y footpad.

Remove side bag

Retrieve ALSCC from the vicinity of the +Y footpad and deploy the ALSCC skirt

## CDR ACTIVITIES

### Recover SWC:

- a. Move to SWC
- b. Withdraw staff from surface
- c. Roll up foil
- d. Rotate foil roller to detach position and remove from staff
- e. Carry SWC foil to MESA
- f. Insert foil into SWC bag
- g. Roll and fold bag
- h. Place SWC foil into SRC

### Remove from the ALHTC and place in the SRC:

- a. Core tubes
- b. SESC
- c. GASC
- d. Documented samples

## LMP ACTIVITIES

### In general the camera operation is:

- a. Estimate position of object plane relative to camera bearing surface
- b. Position camera over object (Describe object and location)
- c. If object is below ALSCC bearing surface depress skirt until object is within focus plane
- d. If object is above bearing surface tilt camera back until object is within focus plane
- e. Activate trigger located on handle grip
- f. Read and report frame counter
- g. Observe cycle completion by light on handle

### Obtain photographs of the following

- a. Unexpected features on the surface
- b. Glassy features
- c. Rock-soil junctions both on the up hill and down hill side of the rocks
- d. Undisturbed surface both on level and slope surfaces
- e. Rock surface
- f. Foot prints and LM footpads
- g. Surface material adhering to the boots, craters, LM, etc.
- h. Clumps of material

## CDR ACTIVITIES

Check all surface equipment has been removed from LMP's EMU

Clean EMU

Pack and seal SRC

- a. Pack wire mesh in SRC to take up void space
- b. Remove spacer (seal protector) from lower part of SRC. (Use caution to keep seal clean. Do not touch seal. If an O-ring is loose, pull from SRC and discard)
- c. Rotate the top closed with a strap latch handle
- d. Seal the SRC by rotating the two strap latch handles downward to the locked position

Check the ETB contains two 70mm cameras, one 70mm magazine, and the ALSCC film cassette. Close ETB top flap.

## LMP ACTIVITIES

Take three extra frames to secure last photograph taken

Remove cassette from ALSCC

- a. Pull two red lanyards to release cover
- b. Pull cover from over cassette
- c. Activate film cutting lever
- d. Activate cassette release lever
- e. Lift cassette from ALSCC
- f. Discard ALSCC under LM

Stow ALSCC cassette in ETB

### 2+56 EVA TERMINATION

Check all surface equipment has been removed from CDR'S EMU

Clean EMU

Ascend to platform

Ingress the LM

Check the EMU and LM systems



## CDR ACTIVITIES

Remove the ETB from stowage on the MESA

Carry the ETB to a position in front of the LM

Transfer the ETB into the LM cabin

Rest and check EMU

Transfer the ETB hooks back to the surface

Attach the LEC to the SRC

Release the SRC retaining clips and lift the SRC from the MESA table

Carry the SRC to a position in front of the LM

Transfer the SRC into the LM cabin

Rest and check EMU

Transfer the LEC hooks to the surface

Retrieve and position the surveyor parts bag on the MESA table

Attach the LEC to the parts bag

Carry the parts bag to a position in front of the LM

Transfer the parts bag into the LM cabin

3+20 EVA TERMINATION  
Clean the EMU of surface material

Pull the LEC from the LM cabin and discard

## LMP ACTIVITIES

Assist the CDR in transferring the ETB

Remove the ETB from the LEC

Stow the ETB on the engine cover

Assist the CDR in transferring the SRC

Remove the SRC from the LEC

Stow the SRC on the engine cover

Assist the CDR in transferring the parts bag

Remove the parts bag from the LEC

Stow the parts bag

CDR ACTIVITIES

Ascend the LM ladder to the  
platform

Ingress the LM

Jettison equipment & close door

Repressurize the LM cabin

End 2nd EVA

LMP ACTIVITIES

SECTION 4.0

CONTINGENT PLANS

## 4.0 CONTINGENT PLANS

### 4.1 Description and Rationale

In lunar manned operations it is expected that the EVA timeline will vary a small amount due to the new environment as well as small changes that occur in equipment operation. If the activity timeline or equipment operation changes sufficiently that the flexibility of the timeline or equipment cannot compensate to accomplish the planned activities, a contingency plan must be used to continue the EVA.

This section is devoted to pre-mission variations in EVA timeline and contingency EVA planning. The procedures to resolve unexpected equipment operation or malfunction are found in detail in Appendix 5.3.

Since it is not possible to define specific plans for every possible contingency, real time resolution of problems and timeline planning must be depended on during the mission using a pre-mission developed timeline guide. The exception to this rule is predefined possible contingencies in which time is too short to respond to a problem and continue through the EVA expediently. The pre-mission timelines provided in this section that could fall in this category are one man-EVA 1, one man-EVA 2, minimum time EVA and EVA termination timelines used in conjunction with the Timeline Guide. The Timeline Guide as presented in Table 4-1 divides the non-nominal conditions into three areas:

- Time remaining at the completion of the 3+30 activity.
- Insufficient time for planned activities.
- Time cut short by an EMU or LM system problem.

It is expected that the guidelines provided under these categories will provide a base from which the mission EVA timelines may be modified as required to conduct the EVA's effectively.

## 4.2 Contingent EVA 1 and EVA 2 - One Man

### 4.2.1 Description and Rationale

A possibility exists due to certain equipment malfunctions that only one crewman will be able to egress the LM and perform EVA tasks. One possibility might be the failure of one PLSS to check out; another might be a LM subsystem malfunction which required continuous monitoring.

The following contingency timelines are based on the assumption that the nominal EVA period of 3.5 hours will be available. Extensions to the timelines are also provided in the event a GO for EVA extension to 4 hours is given.

The one-man timelines of EVA 1 and EVA 2 presented here can be accomplished by either crewman. While one crewman is on the surface accomplishing the EVA tasks the other crewman will read the surface activities checklist to the crewman on the surface and photograph his surface activity using the sequence and 70mm cameras.

The Contingency EVA 1 - One Man timeline (See Figures 4-1, 4-2, and 4-3) allows for complete deployment of the ALSEP experiments. Tasks deleted from the Nominal EVA 1 (two man) timeline are: Panorama Photography, SWC Deployment, LM Inspection/Photo, Selected Geological Samples (including core tube) and unpacking of SRC 1 at the end of the EVA. Extension of the EVA to 4.0 hours will allow selected geological sample collection, packing these samples in SRC 1 and transfer of SRC 1 into the LM.

The Contingency EVA 2 - One Man timeline (See Figures 4-4 and 4-5) allows for performing a complete lunar field geology experiment. Surveyor III Site activities are deleted, with the exception of possible photography of the Surveyor III from the crater rim if it is close enough to the LM. Stereo close-up and contrast chart photography will be included. Extension of the EVA to 4.0 hours will allow more time to be added to the lunar field geology portion of the EVA.

# FIGURE 4-1 APOLLO 12 SUMMARY TIMELINE

## CONTINGENCY TIMELINE EVA 1-ONE MAN

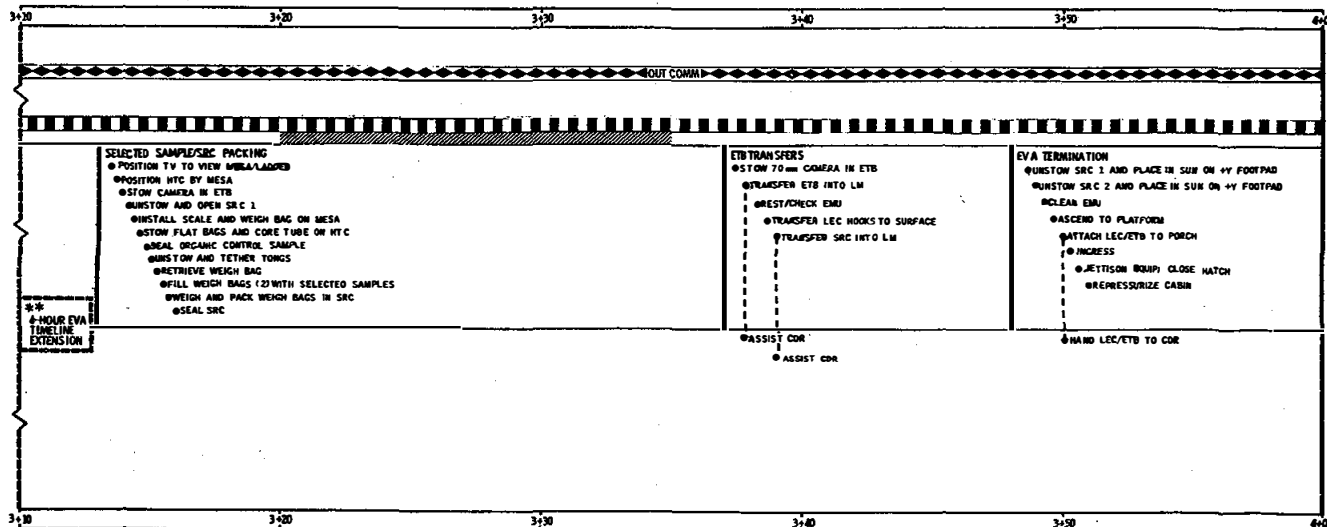
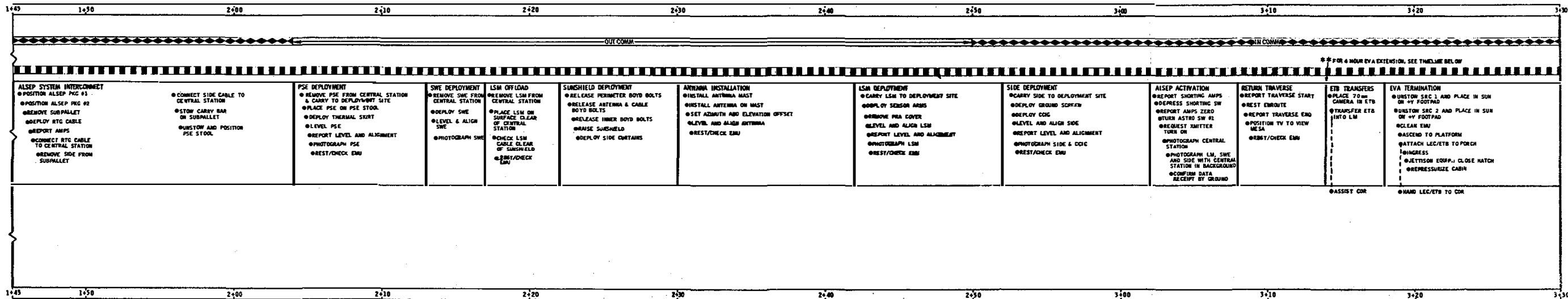
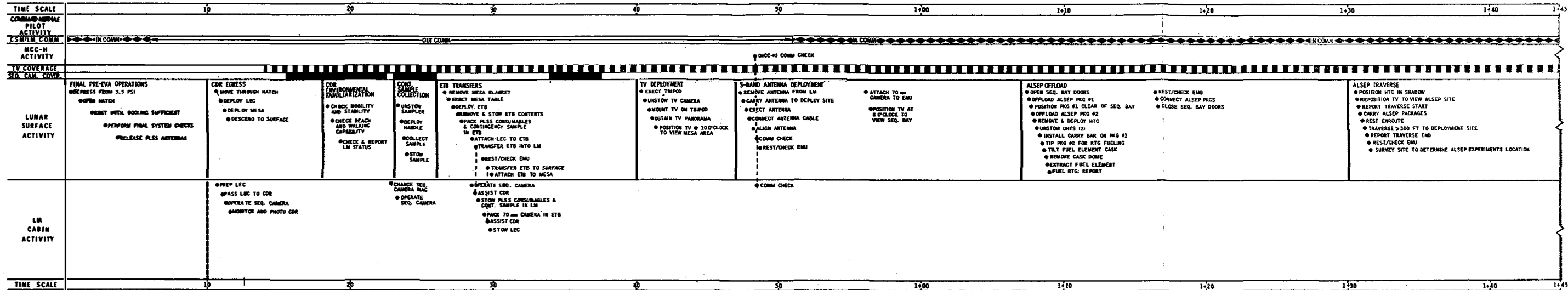

**LEGEND**

EVENT LINE  
SEPARATES MAJOR BLOCKS OF ACTIVITY

COORDINATE TASKS

SEQUENCE CAMERA COVERAGE

- 6 FRAMES/SEC
- 12 FRAMES/SEC
- NO COVERAGE

TV COVERAGE

- COVERAGE
- NO COVERAGE

NOTE: ACTIVITY TIMES WITHIN AN EVENT NOT FIXED.

NAME	INITIAL	ORGN	NATIONAL AERONAUTICS & SPACE ADMINISTRATION
T. MONTGOMERY		LS00	MANAGED SPACEFLIGHT CENTER - HOLISTON, TEXAS
			APOLLO 12 SUMMARY TIMELINE
			CONTINGENCY EVA 1 - ONE MAN
			FIGURE 4-1
DR. W. ROHM		CE	BASIC OCTOBER 69

FIGURE 4-2  
APOLLO TWELVE  
MISSION H-1

# ONE MAN CONTINGENCY TIMELINE

## LUNAR SURFACE EVA ONE

### SURFACE ACTIVITIES

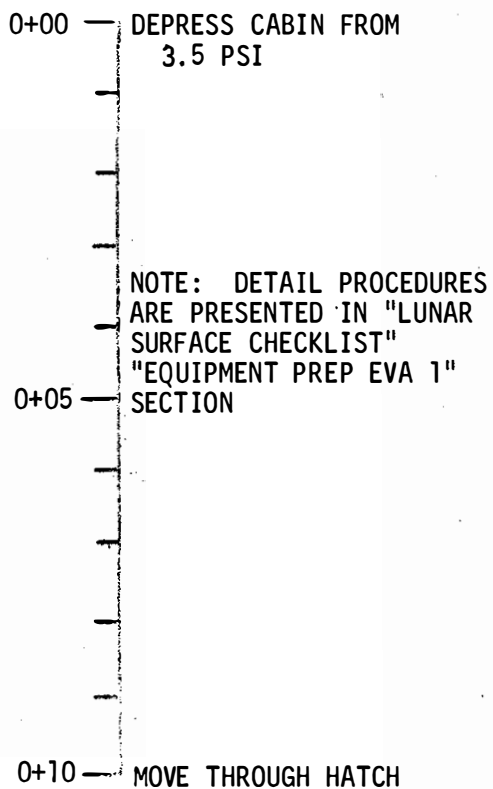

### SURFACE ACTIVITIES

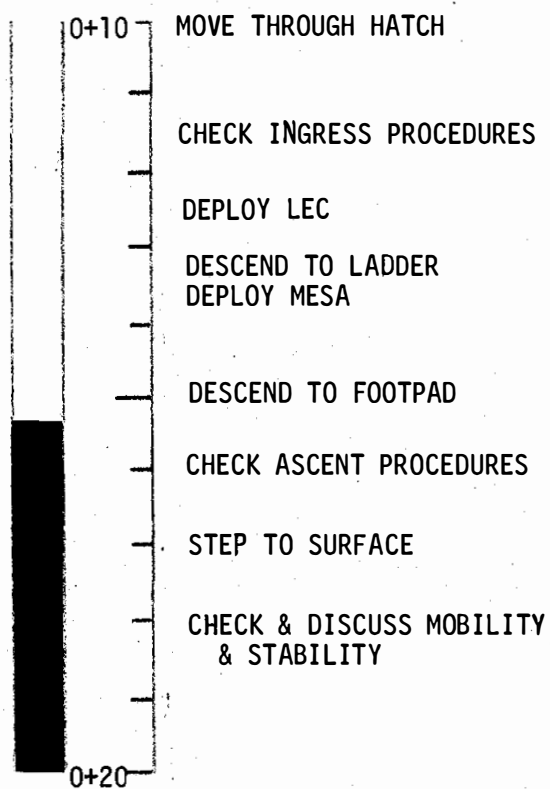

## SURFACE ACTIVITIES

0+20

- REPORT LM STATUS
- UNSTOW CSC & DEPLOY HANDLE
- COLLECT SAMPLE  
REMOVE SAMPLE FROM CSC
- HANG SAMPLE ON LADDER  
REMOVE MESA COVER
- ERECT MESA TABLE  
ATTACH ETB TO MESA TABLE  
STOW SIDE BAGS ON MESA  
HANG PHOTO CHARTS ON TABLE
- 0+30 UNSTOW & PLACE PLSS BATTS & LiOH CANS IN ETB
- PLACE CONTINGENCY SAMPLE IN ETB
- CLOSE ETB TOP FLAP  
ATTACH LEC TO ETB
- TRANSFER ETB INTO LM
- REST/CHECK EMU
- TRANSFER ETB TO SURFACE
- ATTACH ETB TO MESA
- 0+40 UNSTOW & ERECT TV TRIPOD

## SURFACE ACTIVITIES

0+40

- UNSTOW & ERECT TV TRIPOD
- UNSTOW & MOUNT TV CAMERA ON TRIPOD
- UNSTOW TV CABLE
- CARRY TV TO 20'/10 O'CLOCK
- OBTAIN TV PANORAMA & SPECIAL INTEREST VIEWS
- POINT TV AT S-BAND/MESA AREA  
REMOVE S-BAND ANTENNA FROM LM
- CARRY ANTENNA TO DEPLOY SITE
- 0+50 PLACE & ORIENT ANTENNA  
REMOVE TOP CAP
- DEPLOY MAST SECTION
- EXTEND LEGS
- CHECK ANTENNA ORIENTATION  
DEPLOY LEGS
- REMOVE & DISCARD COVER  
LIFT ANTENNA
- REMOVE & DISCARD LIFT BAR & RIB PROTECTOR
- UNSTOW TRIGGER & DEPLOY REFLECTOR
- UNSTOW & ATTACH CABLE
- 1+00



## SURFACE ACTIVITIES

1+00 — ROUGH ALIGN ANTENNA

— FINE ALIGN ANTENNA

— REQUEST ANTENNA SWITCHING  
COMMUNICATIONS CHECK

— ATTACH 70MM CAMERA TO EMU

— REPOSITION TV TO 20 FT AT  
8 O'CLOCK TO VIEW SEQ BAY

— OPEN SEQ BAY DOOR

— REMOVE & LOWER PKG #1

1+10 — DISCONNECT LANYARDS & BOOM  
REPOSITION PKG #1

— REMOVE & LOWER PKG #2

— DISCONNECT LANYARDS & BOOM,  
PULL PINS AND DISCARD

— POSITION PKG #2 FOR RTG FUELING  
REMOVE AND EXPAND ALHTC

— PLACE ALHT NEAR FUEL CASK  
REMOVE UHT'S-TETHER ONE  
STOW OTHER ON PKG #2

— REMOVE CARRY BAR  
ATTACH CARRY BAR TO  
PKG #1

— REMOVE DRT & FTT, STOW  
IN ALHTC

1+20 — TIP PKG #2

## SURFACE ACTIVITIES

1+20 — TIP PKG #2  
DEPLOY CASK TILT LANYARD  
TILT CASK & STOW LANYARD

— REMOVE AND DISCARD DOME

— ENGAGE AND CHECK FTT

— WITHDRAW FUEL CAPSULE &  
FUEL RTG - REPORT

— DISENGAGE FTT & DISCARD  
ROTATE PKG #2

— REPOSITION PKG #2 NEAR PKG 1  
CONNECT PKG #2 TO  
CARRY BAR

— STOW ALSEP OFFLOAD BOOMS

1+30 — CLOSE SEQ BAY DOOR

— POSITION ALHTC IN  
SHADOW

— REPOSITION TV TO  
VIEW ALSEP SITE

— CARRY ALSEP PKGS TO  
DEPLOYMENT SITE  
REPORT START OF  
TRAVERSE AND REST  
STOPS ENROUTE

1+40 —

## SURFACE ACTIVITIES

1+40

REPORT COMPLETION OF TRAVERSE  
SURVEY SITE TO DETERMINE  
ALSEP EXPERIMENTS LOCATION

POSITION ALSEP PKGS

DISENGAGE BAR FROM PKG #2

REPOSITION PKG #1 AND BAR

TILT PKG #2

REMOVE SUBPALLET FROM  
PKG #2  
PLACE SUBPALLET ON SURFACE  
RELEASE RTG CABLE BOYD BOLTS

1+50

DEPLOY CABLE - DISCARD REEL

REPORT AMPS AND CONNECT CABLE

REMOVE & STOW CARRY BAR  
ON SUBPALLET

RELEASE SIDE BOYD BOLTS

LIFT SIDE FROM SUBPALLET  
REMOVE SIDE CABLE REEL

DEPLOY LEGS & PLACE  
SIDE ON SURFACE

RETRIEVE SIDE CABLE CONNECTOR

2+00 — CARRY CONNECTOR TO C/S

## SURFACE ACTIVITIES

2+00

CARRY CONNECTOR TO C/S  
CONNECT SIDE TO C/S

TILT C/S INTO FINAL POSITION

ALIGN C/S

RETRIEVE PSE STOOL  
IMPLACE PSE STOOL

RELEASE PSE BOYD BOLTS

REMOVE PSE - CARRY TO  
PSE STOOL

REMOVE GIRDLE - PLACE PSE  
ON STOOL

DEPLOY THERMAL SKIRT

LEVEL PSE

2+10

REPORT LEVEL & ALIGNMENT  
PHOTOGRAPH PSE

RELEASE SWE BOYD BOLTS  
CARRY SWE TO DEPLOYMENT SITE

PLACE SWE ON SURFACE

LEVEL AND ALIGN SWE  
PHOTOGRAPH SWE

RELEASE LSM BOYD BOLTS

REMOVE TIE-DOWN & DISCARD

LIFT LSM FROM C/S

PLACE LSM ON SURFACE

2+20

## SURFACE ACTIVITIES

- 2+20
- CHECK LSM CABLE FREE OF SUNSHIELD
  - START FRONT CENTER AND RELEASE C/S BOYDBOLTS CLOCKWISE  
DEPLOY ANTENNA CABLE
  - RELEASE TWO INTER BOYD BOLTS
  - RELEASE CENTER BOYD BOLT AND RAISE SUNSHIELD
  - REMOVE CURTAIN COVERS & DISCARD
  - CHECK CURTAINS PROPERLY DEPLOYED
- 2+30
- RETRIEVE AND INSTALL ANTENNA MAST
  - RELEASE GIMBAL BOYD BOLTS  
REMOVE GIMBAL FROM SUBPALLET
  - REMOVE GIMBAL BOTTOM COVER  
INSTALL GIMBAL ON MAST
  - REMOVE GIMBAL TOP COVER  
INSTALL ANTENNA
  - CHECK C/S ALIGNMENT  
ENTER AZIMUTH OFFSET
  - ENTER ELEVATION OFFSET  
LEVEL ANTENNA
  - ALIGN ANTENNA
  - CHECK ANTENNA LEVEL AND ALIGNED
- 2+40

## SURFACE ACTIVITIES

- 2+40
- CARRY LSM TO DEPLOY SITE
  - REMOVE BRACKET & DEPLOY LEGS  
ALIGN LSM & PLACE ON SURFACE
  - REMOVE FOAM COLLAR  
DEPLOY SENSOR ARMS
  - REMOVE PRA COVER
  - CK PRA CLEAR OF PIECES & DOORS OPEN  
ALIGN & LEVEL LSM
  - REPORT LEVEL AND ALIGNMENT
- 2+50
- PHOTOGRAPH LSM
  - RETURN TO C/S
  - CARRY SIDE TO DEPLOY SITE
  - PLACE SIDE ON GROUND SCREEN  
REMOVE & IMPLACE GROUND SCREEN
  - REMOVE CCIG
  - PLACE SIDE ON GROUND SCREEN  
IMPLACE CCIG
  - LEVEL AND ALIGN SIDE
  - REPORT LEVEL & ALIGNMENT  
PHOTOGRAPH SIDE & CCIG
- 3+00

## SURFACE ACTIVITIES

3+00 RETURN TO C/S

REPORT SHORTING SW AMPS  
DEPRESS SHORTING SWITCH  
CHECK SHORTING SW AMPS ZERO  
TURN ASTRO SWITCH #1 ON (CW)  
REQUEST TRANSMITTER TURN ON  
PHOTOGRAPH ALSEP DEPLOYMENT  
SITE

CONFIRM RECEIPT OF DATA  
BY GROUND

RETURN TO LM

3+10 NOTE: IF EVA HAS BEEN  
EXTENDED TO FOUR HOURS  
SEE FIGURE 4-3

REPOSITION TV TO 20 FT AT  
2 O'CLOCK TO VIEW MESA/LADDER

STOW 70MM CAMERA IN ETB

CLOSE ETB TOP FLAP

TRANSFER ETB INTO LM

CLEAN EMU

3+20

## SURFACE ACTIVITIES

3+20 ASCEND TO PLATFORM

STOW LEC ON PLATFORM

INGRESS

JETTISON EQUIPMENT &  
CLOSE HATCH

REPRESSURIZE CABIN

3+30 END 1st EVA

FIGURE 4-3  
APOLLO TWELVE  
MISSION H-1

FOUR HOUR  
ONE MAN  
CONTINGENCY TIMELINE  
LUNAR SURFACE EVA ONE

(SEE FIGURE 4-2 FOR FIRST PART OF TIMELINE)

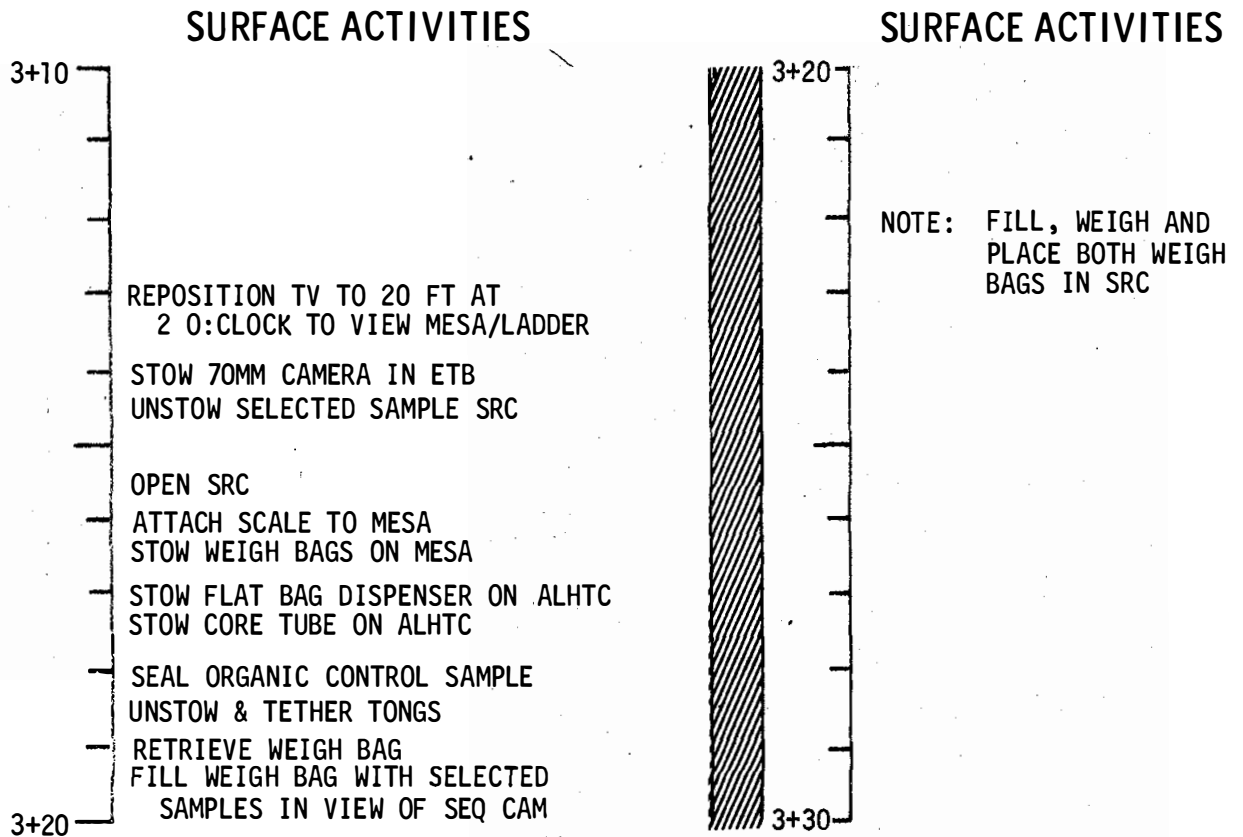

## SURFACE ACTIVITIES

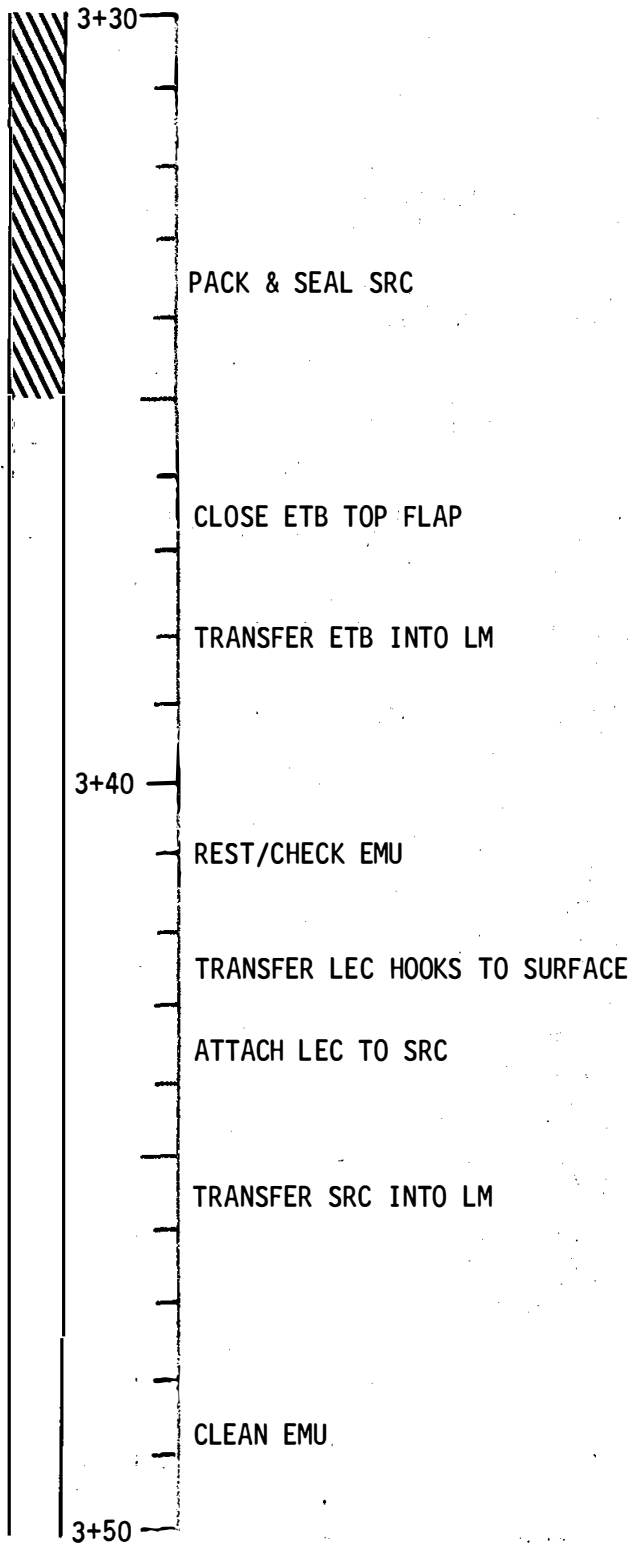

## SURFACE ACTIVITIES

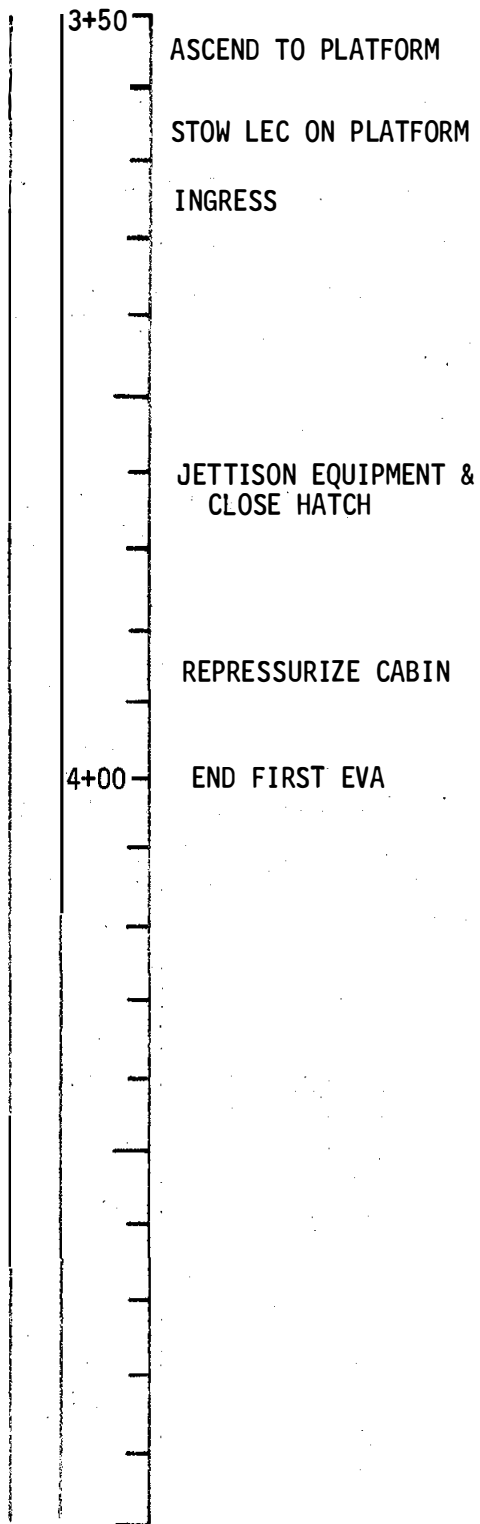

# FIGURE 4-4 APOLLO 12 SUMMARY TIMELINE CONTINGENCY TIMELINE EVA 2-ONE MAN

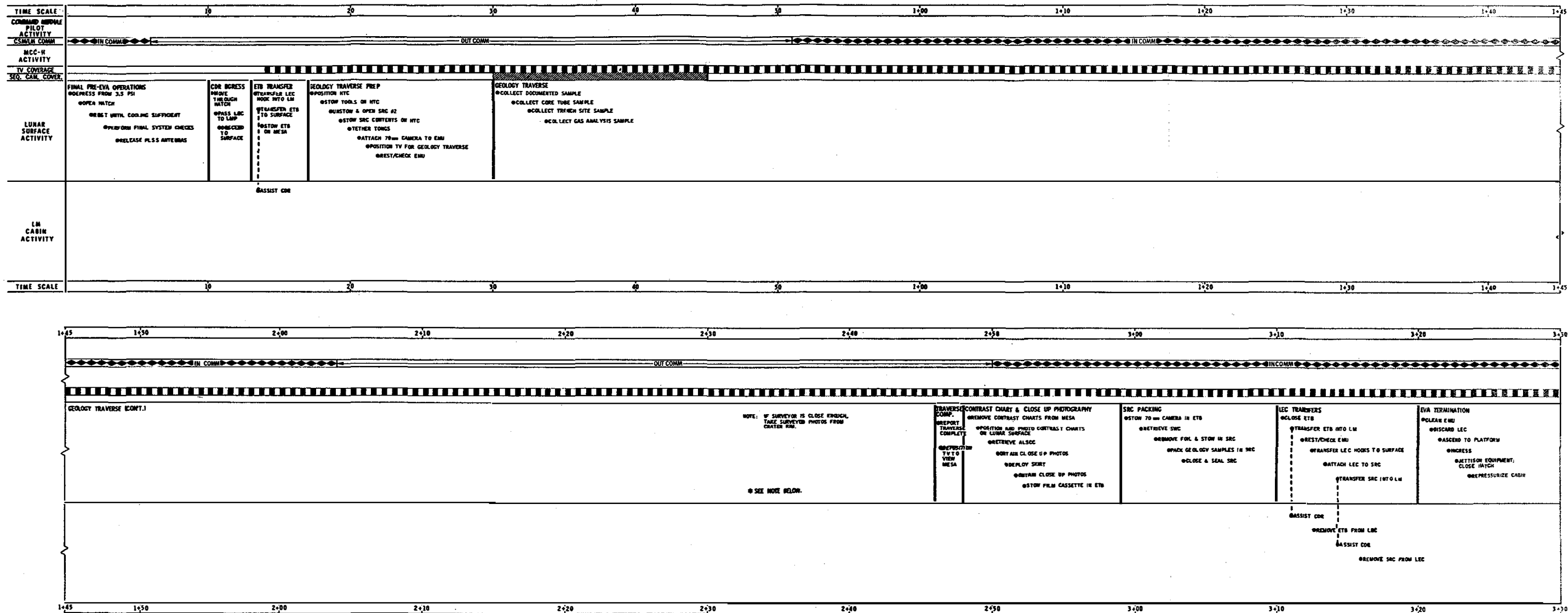

\*NOTE: FOR 4 HOUR EVA EXTENSION, "GEOLOGY TRAVERSE" TIME BLOCK WILL BE EXTENDED BY 30 MINUTES. THEREFORE, "TRAVERSE COMPLETION" TIME BLOCK WILL BEGIN AT 3:16.

**LEGEND**

**EVENT LINE**  
 SEPARATES MAJOR BLOCKS OF ACTIVITY.

**COORDINATED TASKS**

**SEQUENCE CAMERA COVERAGE**  
 6 FRAMES/SEC  
 NO COVERAGE

**TV COVERAGE**  
 NO COVERAGE

**NOTE:**  
 ACTIVITY TIMES WITHIN AN EVENT NOT FIXED.

NAME	T. MONTGOMERY	ORIGIN	NATIONAL AERONAUTICS & SPACE ADMINISTRATION MONTGOMERY AIRCRAFT CENTER - HOUSTON, TEXAS
DATE			
FIGURE 4-4			
APOLLO 12 SUMMARY TIMELINE CONTINGENCY EVA 2 - ONE MAN			
BASIC			

FIGURE 4-5  
 APOLLO TWELVE  
 MISSION H-1

# ONE MAN CONTINGENCY TIMELINE LUNAR SURFACE EVA TWO (FIRST EVA ACCOMPLISHED AS PLANNED)

## SURFACE ACTIVITIES

SEQUENCE CAMERA OPERATION  
 SEE LEGEND ON SUMMARY TIMELINE



0+00 DEPRESS CABIN FROM 3.5 PSI

NOTE: DETAIL PROCEDURES  
 ARE PRESENTED IN  
 "LUNAR SURFACE CHECKLIST"

0+10 MOVE THROUGH HATCH

## SURFACE ACTIVITIES



0+10 MOVE THROUGH HATCH

PASS LEC INTO LM CABIN

DESCEND TO SURFACE

TRANSFER LEC HOOKS INTO  
 LM CABIN

REST/CHECK EMU

TRANSFER ETB TO SURFACE

STOW ETB ON MESA

POSITION HTC NEAR MESA  
 STOW ON HTC: EXTENSION  
 HANDLE, HAMMER, SMALL  
 SCOOP, AND GNOMON

0+20 RETRIEVE AND OPEN SRC #2



## SURFACE ACTIVITIES

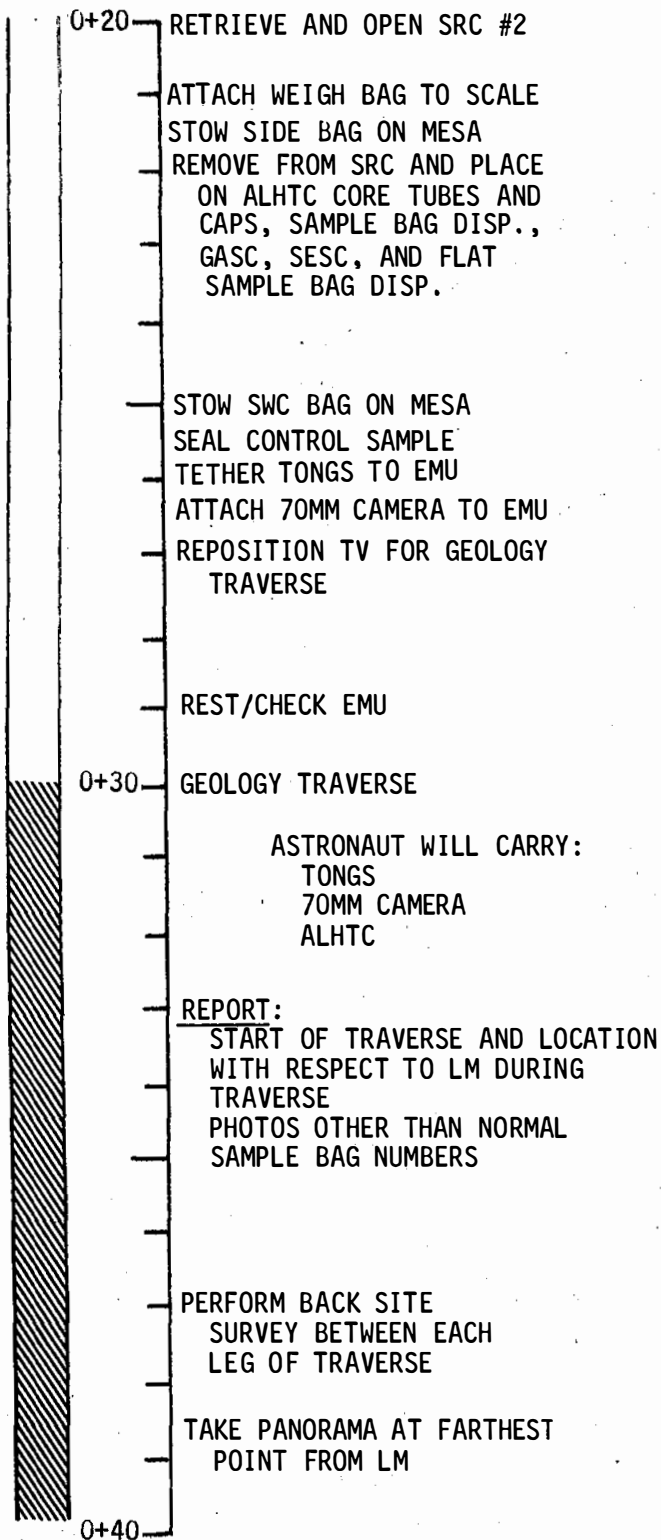

## SURFACE ACTIVITIES

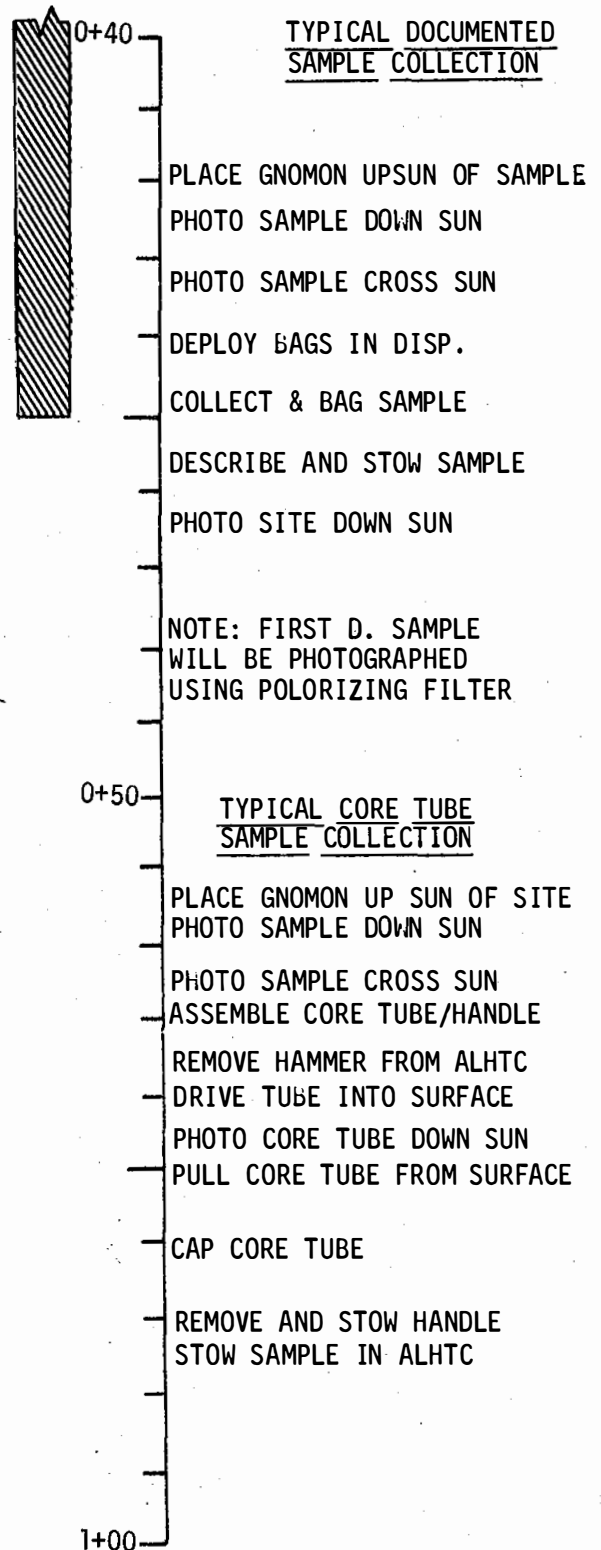

## SURFACE ACTIVITIES

- SAMPLING AT SURFACE TRENCH SITE
- 1+00 PLACE GNOMON UPSUN
  - PHOTO SITE DOWN SUN
  - PHOTO SITE CROSS SUN
  - DIG TRENCH ALONG SUNLINE
  - RETRIEVE SESC FROM ALHTC
  - OPEN SESC
  - FILL SESC WITH SUBSURFACE MATERIAL
  - REMOVE SEAL PROTECTOR AND SEAL SESC
  - STOW SESC IN ALHTC
  - PHOTO TRENCH DOWN SUN
  - REMOVE SCOOP FROM HANDLE
  - ASSEMBLE CORE TUBE AND EXTENSION HANDLE
  - 1+10 REMOVE HAMMER FROM ALHTC
  - DRIVE TUBE IN TRENCH
  - PHOTO CORE TUBE DOWN SUN
  - PULL TUBE FROM SURFACE
  - STOW HAMMER ON ALHTC
  - CAP CORE TUBE
  - REMOVE AND STOW HANDLE
  - STOW SAMPLE IN ALHTC
  - 1+20

## SURFACE ACTIVITIES

- GAS ANALYSIS SAMPLE COLLECTION
- 1+20 PLACE GNOMON UP SUN
  - PHOTO SAMPLE DOWN SUN
  - PHOTO SAMPLE CROSS SUN
  - RETRIEVE GASC FROM ALHTC
  - OPEN GASC
  - COLLECT SAMPLE IN GASC
  - REMOVE SEAL PROTECTOR A AND SEAL GASC
  - STOW SAMPLE IN ALHTC
  - NOTE: FOR 4 HOUR EVA EXTENSION, THE GEOLOGY TRAVERSE WILL BE EXTENDED BY 30 MINUTES. 4 HOUR EVA TIMES ARE SHOWN IN PARENTHESES ( ).
  - 2+40 (3+10) REPORT TRAVERSE COMPLETE
  - REPOSITION TV TO VIEW MESA
  - RETRIEVE CONTRAST CHARTS FROM MESA TABLE
  - DEPLOY CONTRAST CHARTS,
  - 2+50 (3+20) REPORT CHART VISIBILITY AND PHOTO CHARTS

## SURFACE ACTIVITIES

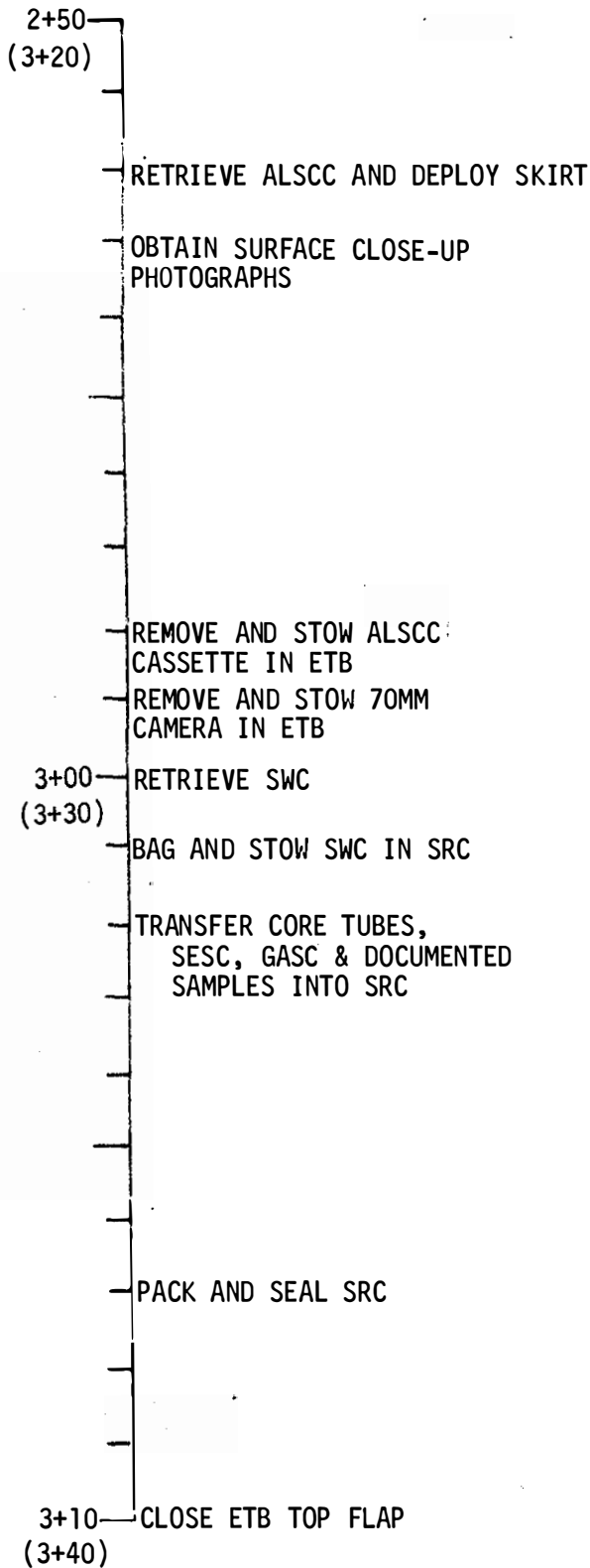

## SURFACE ACTIVITIES

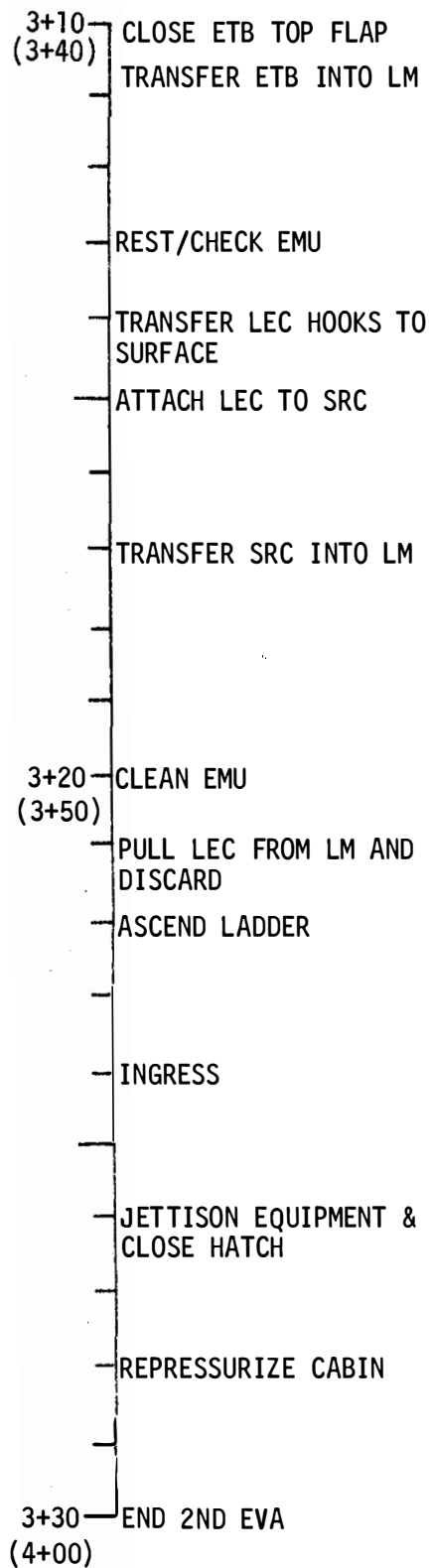

### 4.3 Contingent EVA 1 - Minimum Time, One Man

#### 4.3.1 Description and Rationale

For various reasons, on a lunar landing mission only a very limited time may be available to accomplish one EVA. For such a situation the choice of objectives are, first, those with the highest priority and, secondly, those which can be accomplished in a short period of time and do not require the accomplishment of a previous task. The timeline (See Figure 4-6 and 4-7) presented here, referred to as the Contingent EVA 1 Minimum-Time, One-Man EVA, fits the above guidelines by providing for the implementation of the highest priority and basic objective of documenting the character of the landing site. This is done by collecting a surface sample (contingency sample) and describing as well as photographing the lunar surface texture and topography.

In this contingent EVA, for the environmental familiarization, the crewman will spend only enough time to assure himself that he can safely proceed with the EVA. After the contingency sample collection he will continue to become more adapted to the new environment as he conducts a limited EVA evaluation. Primarily, this EVA evaluation will involve a brief investigation to determine his general capabilities or limitations for conducting EVA tasks within the lunar environment. Photographs taken during this evaluation will be a postflight aid to the crewman's recall and the documentation of this activity. A limited site description, with very brief comments and several documentary photographs, can be made of the surface to the horizon. To conclude the surface activity the crewman will take a photographic panorama and possibly a few additional photographs of documentary value.

In conclusion, it should be mentioned that the crewman's surface activity will be confined mainly to an area where he can be monitored by the crewman inside the LM. Practically all of the activity can be documented with the sequence camera, and, if the communications capability exists, with the TV.

FIGURE 4-6  
 APOLLO 12  
 SUMMARY TIMELINE  
 CONTINGENT EVA 1

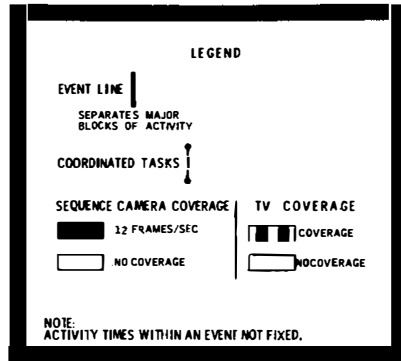

MINIMUM TIME,  
 ONE MAN

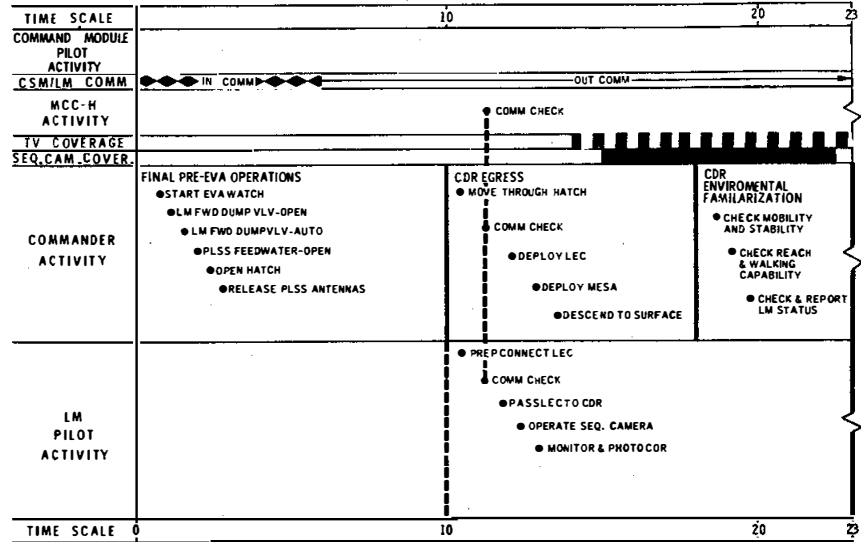

66

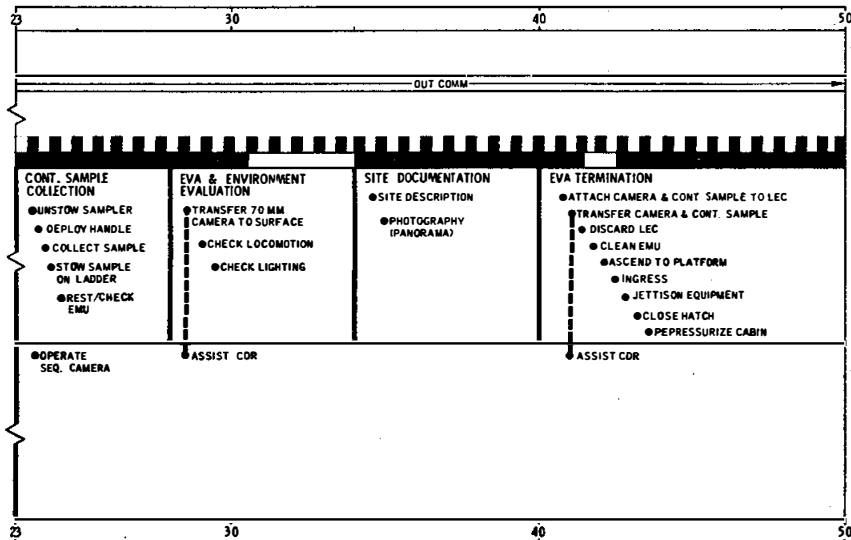

NAME	INITIAL	ORIGIN	NATIONAL AERONAUTICS & SPACE ADMINISTRATION
T. MONTGOMERY		LSOO	MANNEED SPACECRAFT CENTER HOUSTON, TEXAS
W. NDAM		GE	

APOLLO 12 SUMMARY TIMELINE  
 CONTINGENT EVA 1, MINIMUM TIME,  
 ONE MAN  
 FIGURE 4-6 BASIC OCT. 1969

FIGURE 4-7  
APOLLO TWELVE  
MISSION H-1

# ONE MAN CONTINGENCY TIMELINE MINIMUM TIME LUNAR SURFACE EVA

## CDR ACTIVITIES

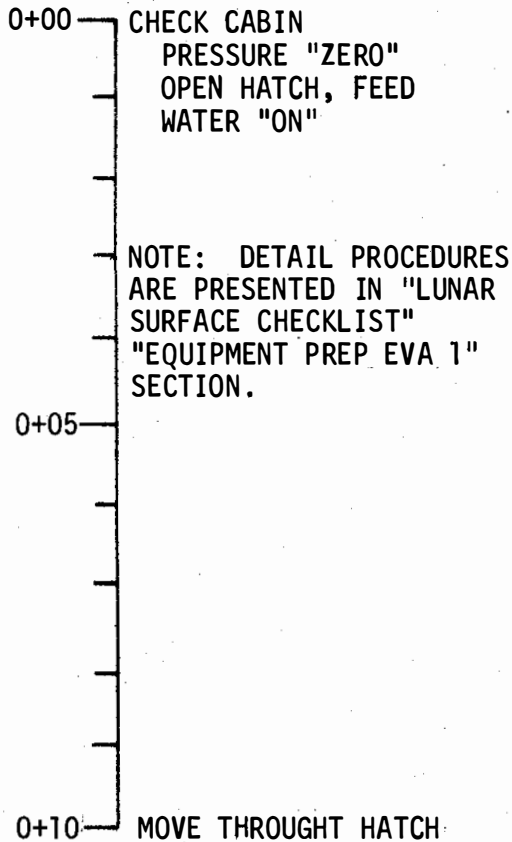

## LMP ACTIVITIES

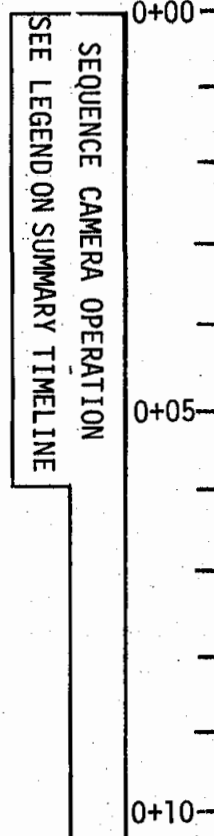

# CDR ACTIVITIES

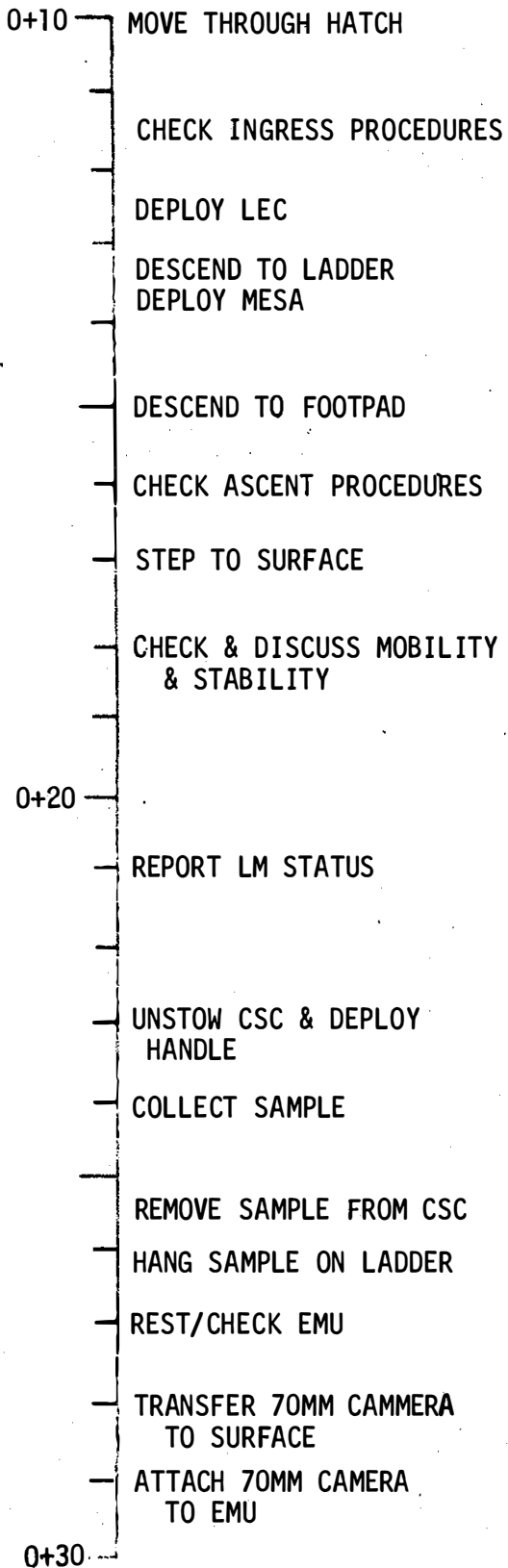

# LMP ACTIVITIES

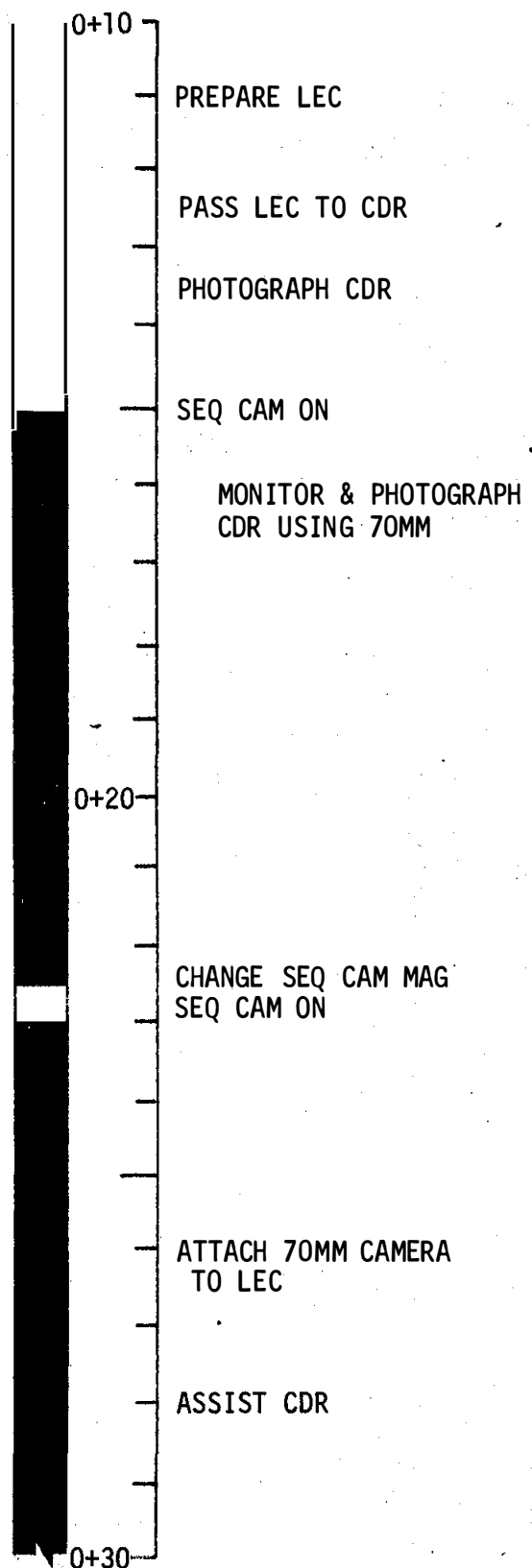

## CDR ACTIVITIES

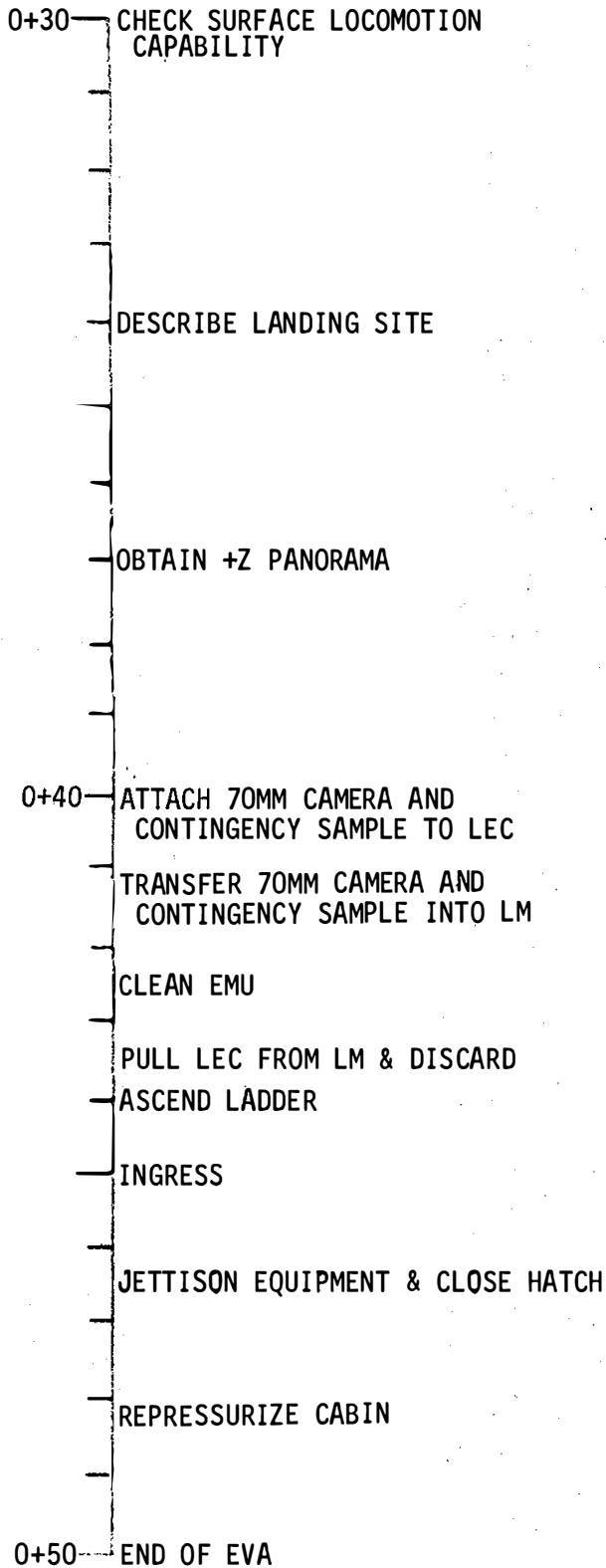

## LMP ACTIVITIES

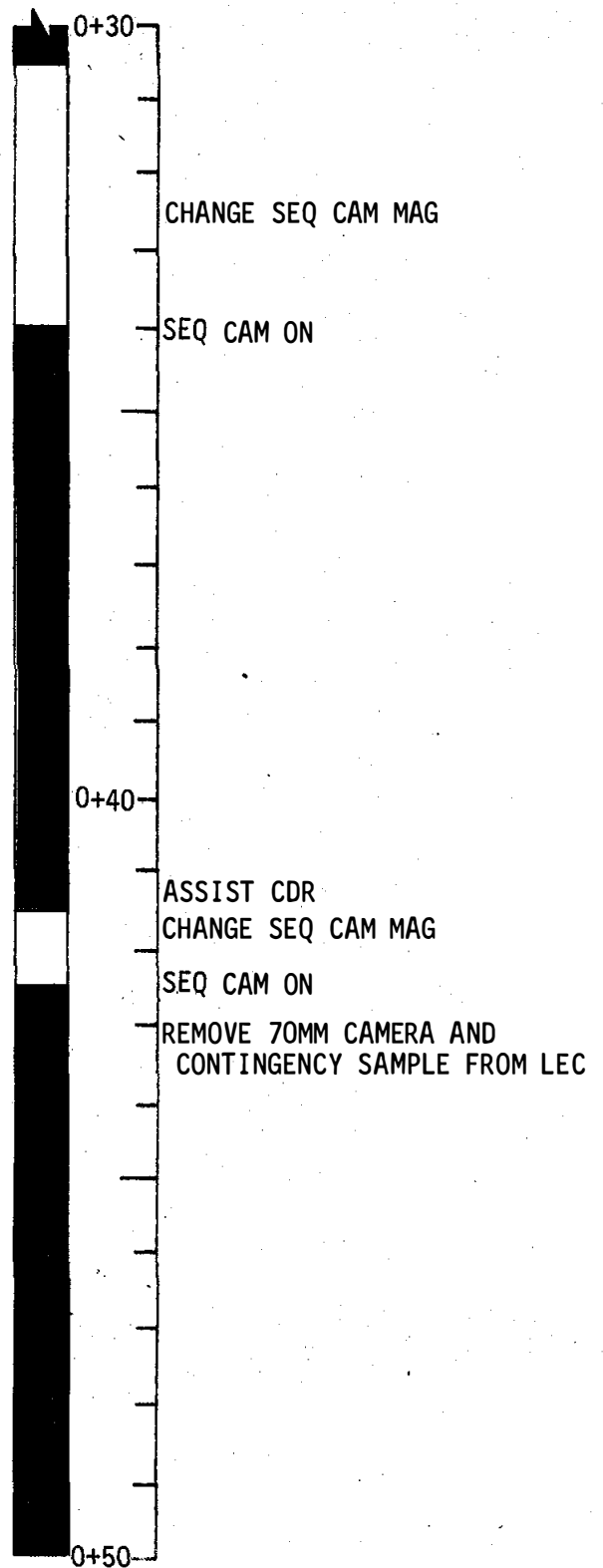



## 4.4 Timeline Guide

### 4.4.1 Description and Rationale

The Timeline Guide (Table 4-1) has been defined in as general terms as possible to indicate the possible variations in time for an activity, and in activity sequence. The activity performance times are either incremental or in minus time from the end of the EVA so that the variation in EVA length will not affect these data. The information presented under the three non-nominal conditions will be discussed in the following paragraphs in the order of table presentation.

1. Time remaining at the completion of the 3+30 activity:  
The Nominal EVA 1 Summary Timeline (Figure 3-3) has timelined the activity for the possible 30 minute extension of EVA 1 to 4 hours. The activity planned for all available time over 10 minutes is documented sampling. The Timeline Guide has defined the utilization of up to 50 minutes in employing the 15 sample bag dispenser and lunar hand tools in a short geology traverse. Included in the sampling is a subsurface organic bagged sample collected if 5 minutes or more is available. The time of 50 minutes could be accumulated from the extension of EVA to greater than 3+30 and/or more rapid accomplishment of the nominal 3+30 activities. In EVA 2 any excess time would be allotted to the geology experiment which could consist of a 30 minute extension to the EVA, and 30 minutes available from the Surveyor III activity if the site could not be visited.
2. Insufficient time for planned activities:  
The maximum pre-designated loss in EVA time was set at 1 hour and 2 minutes from the nominal as a pessimistic arbitrary number. This amount of time required over the nominal allows the crewmen to stop their activity at an ALSEP hold point (hold with no harm to ALSEP) as does the next two designated points each 16 minutes apart. If the ALSEP deployment is not completed on the first EVA the deployment is continued in the first portion of the EVA 2 and the selected sample collection is conducted at the end.

TABLE 4-1

## TIMELINE GUIDE

CONDITION	MINUS TIME TO END OF EVA	AMOUNT OF TIME IN EXCESS OF 3+30 ACTIVITY	ACTIVITY	INCREMENTAL TIME (APPROX.) MINUTES	AFFECT ON 2ND EVA ACTIVITY	INCREMENTAL TIME (MIN.)
Time remaining at the comple- tion of the 3+30 activity EVA - 1	- (1+22) to - (0+43)	+50 to +11	Extend or shorten "Documented Sample Collection" as shown in 4-hour EVA extension (Nominal 26 minutes)			
			1. Perform the following tasks:  Documented bagged samples (14 bags available)  Organic bagged sample (sub- surface at max. distance from LM)  Stereo closeup camera photo- graphy may be selected in real-time as a task but photos limited to 1st EVA. (Camera batteries depleted by 2nd EVA).	3 per sample  5  10 sec. per photo	1. No affect	
EVA -2	-(-+42) to -(0+37)	+10 to +05	2. Obtain the organic bagged sam- ple (subsurface at same dis- tance from LM)	5	2. No affect	
		+60 to 0	1. All available time above that required for the nominal time- line tasks will be used in the geology experiment (documented sampling) including that time available if the Surveyor III site cannot be visited.	3 per smpl.		

TABLE 4-1 (CON'T.)

CONDITION	TIME REQUIRED OVER NOMINAL	REQUIRED CLOSE-OUT TIME	ACTIVITY	INCREMENTAL TIME (APPROX.) MINUTES	AFFECT ON 2ND EVA ACTIVITY	INCREMENTAL TIME (MIN.)
Insufficient time for planned activities EVA - 1	1+02	0+30	1. Discontinue AISEP deployment after AISEP System Interconnect hold point. (occurs nominally at 1+58) <u>Close-out (0+30) Timeline A*</u> a. Return to LM b. Transfer Equipment c. EVA Termination	6 12 12	1. At 0+30 in the nominal time the crew returns to the AISEP site with the AIHT. a. Complete AISEP deployment b. Conduct geology traverse c. Surveyor Activity-Pictures only d. Return traverse to the LM and pack SRC e. Collect selected sample and pack SRC f. Transfer SRC's and ETB g. Nominal EVA Termination	8  32 58* 10  20 22  18 12
	0+46	0+30	2. Discontinue AISEP deployment after sunshield deployment hold point. (Occurs nominally at 2+14) <u>Close-Out (0+30) Timeline A</u> Same as 1 above		2. Same as 1 above except the time for a and b change to: a. Complete AISEP deployment b. Conduct geology traverse (the samples at the Surveyor site should be collected within the time designated in B.)	16 74*
	0+30 to 0+19	0+30	3. Discontinue nominal EVA activity at AISEP deployment completion (occurs nominally 2+30) <u>Close-Out (0+30) Timeline A</u>  Same as 1 above, however any time available above 30 min. up to 11 minutes would be used in collecting selected samples which would be left at the MESA and be packed and transferred in the 2nd EVA.  *Close-out timelines A,B, & C follow this figure.		3. The nominal 2nd EVA would be interrupted at the completion of sealing SRC #2 (nominally 2+58), to collect, pack and transfer the selected smpl. All activity would be moved forward 28-18 minutes that came before this and after the start of the geology traverse. a. Collect the selected sample b. Prepare, pack, & seal SRC #1 c. Transfer SRC #1	10-0 12 6

TABLE 4-1 (CON'T.)

CONDITION	TIME REQUIRED OVER NOMINAL	REQUIRED CLOSE-OUT TIME	ACTIVITY	INCREMENTAL TIME (APPROX.) MINUTES	AFFECT ON 2ND EVA ACTIVITY	INCREMENTAL TIME (MIN.)
EVA -2	0+18 to 0+09	0+42	4. Collect selected sample on an 8-17 min. return traverse to the LM depending on the available time and complete EVA close out as follows: <u>Close-Out Timeline B</u> a. Return to LM b. Pack SRC 1 (Col. coretube) c. Transfer ETB & SRC 1 d. Terminate EVA	8-17 10 12 12	In this instance the geology traverse would be reduced to between 62 and 72 minutes which includes the surveyor area samples. "a" above is variable between 10 and 0 minutes depending on the number of samples collected in the 1st EVA. d. Geology Traverse  4. No Affect	62-72*
	0+08 to 0+00 ➤ 0+30		5. Nominal EVA with the return to the LM varying from 9-17 min. depending on available time.  1. Any loss of EVA time less than 30 min. from the 3+30 base will be subtracted from the geology traverse time, leaving all other activities nominal.		5. No Affect	*Based on 3+30 EVA - add all time over 3+30 to these numbers.

TABLE 4-1 (CON'T.)

CONDITION	TIME REQUIRED OVER NOMINAL	REQUIRED CLOSE-OUT TIME	ACTIVITY	INCREMENTAL TIME (APPROX.) MINUTES	AFFECT ON 2ND EVA ACTIVITY	INCREMENTAL TIME (MIN.)
	< 0+30		<p>2. For a loss of greater than 30 minutes from a base of 3+30 total, the surveyor activity will be limited to photography with a time limit of 10 min. The remaining loss of time will be subtracted from the geology traverse.</p>			
<p>Time cut short by EMU or LM system problem. EVA-1</p>	Anytime		<p>1. If an immediate EVA closeout is required Timeline C of 13 minutes plus the time required to travel to the LM will be used.</p> <p>2. If time is available above the required 13 min. plus travel time to LM, the activity to be conducted will depend on the EVA breakpoint and therefore no attempt will be made to pre-plan every possible case. If, however, a 2nd EVA is feasible operational considerations will take highest priority to (1) secure 2nd EVA capability (trans. PLSS Batteries, and LiOH cannisters,)(2) insure survival of equip. until the 2nd EVA (complete ALSEP activity to prescribed hold-point-see ALSEP constraints; protect SRC's and ALSCC thermally.</p>		<p>1. In the case of an early termination of EVA 1, EVA 2 will be re-defined depending on the break point of activity in the 1st EVA during the interim between EVA's on the basis of crew and equipment status.</p> <p>2. Same as 1 above.</p>	

Three EVA close-out timelines are provided to support these contingency guidelines. Figure 4-8 a 30 minute close-out (Timeline A) is used when there is not enough time to collect, pack and transfer the selected sample which requires a minimum of 42 minutes (Figure 4-9 - 42 minute EVA close-out - Timeline B). The third close-out timeline - Figure 4-10 (Timeline C) defines the minimum required time of 13 minutes for the crew to ingress the LM for any emergency. If for any reason in EVA 2, a loss of more than 30 minutes is indicated, the Surveyor III activity will be reduced to photographs only and the geology traverse reduced by the remainder of time or by any amount less than 30 minutes.

3. Time cut short by EMU or LM system problem:  
If the nature of the problem permits, the crew will insure an EVA 2 capability and survival through the period between EVA's of the equipment to be used in EVA 2. The minimum expected crew ingress time is 13 minutes from the foot of the ladder (Timeline C). Real-time consideration of crew activity will be necessary using previous guidelines if more time than 13 minutes plus traverse time to the LM is available.

# TIMELINE A

## CONTINGENCY 30 MINUTE EVA CLOSE-OUT

### CDR ACTIVITIES

### LMP ACTIVITIES

-30 RETURN TO LM

STOW 70MM CAMERA IN ETB  
STOW TONGS ON HTC

REMOVE SIDE BAG

UNSTOW AND PLACE SRC #1 AND 2  
IN +Y FOOTPAD

-20

CLOSE ETB TOP FLAP  
ATTACH LEC TO ETB

TRANSFER ETB INTO LM

REST/CHECK EMU

CLEAN EMU

-10

-30 RETURN TO LM

POSITION TV ENROUTE TO LM  
TO VIEW MESA AREA

PHOTOGRAPH ALSEP SITE

STOW 70MM IN ETB  
REMOVE SIDE BAG

CLEAN EMU

ASCEND TO PLATFORM

-20

INGRESS

CK EMU & LM SYSTEMS

ASSIST CDR

REMOVE ETB FROM LEC

STOW ETB

SWITCH TO ERECTABLE ANTENNA FOR  
COMM. CHECK

-10

## CDR ACTIVITIES

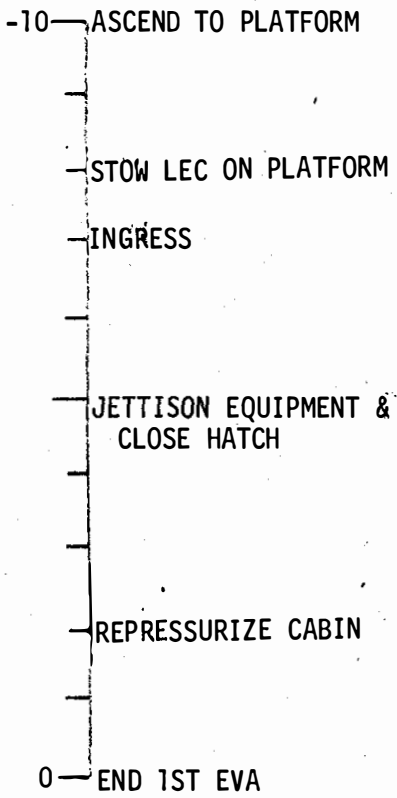

## LMP ACTIVITIES

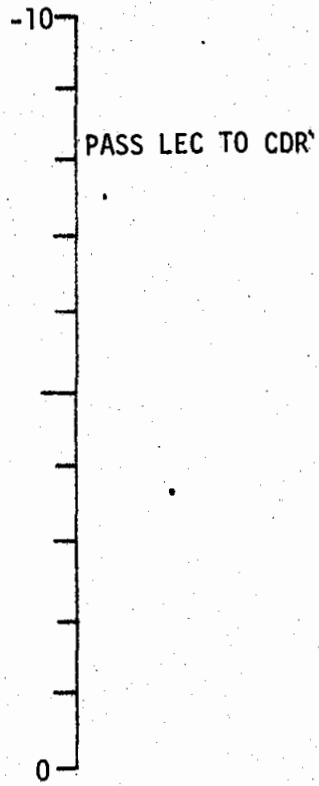



FIGURE 4-9

# TIMELINE B

## CONTINGENCY 42 MINUTE EVA CLOSE-OUT

### CDR ACTIVITIES

### LMP ACTIVITIES

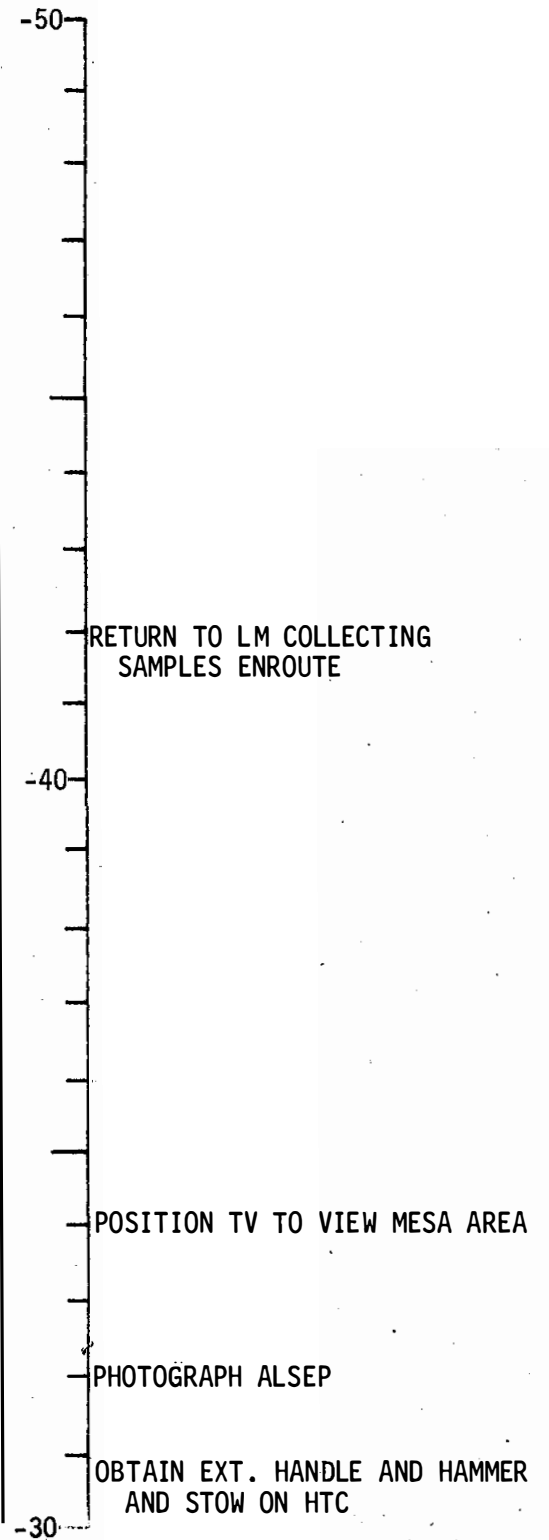
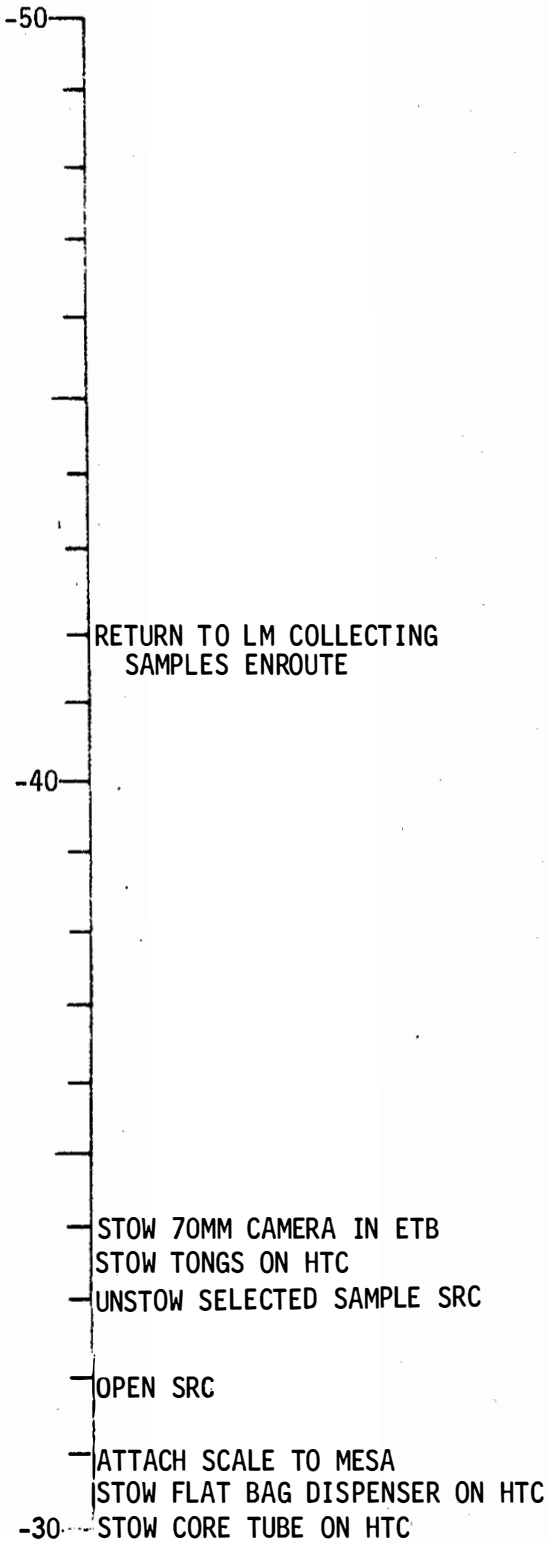

## CDR ACTIVITIES

-30 STOW CORE TUBE ON HTC  
SEAL ORGANIC CONTROL SAMPLE

REMOVE SIDE BAGS  
FINISH FILLING BAG WITH LOOSE MAT.

PACK AND SEAL SRC

CLOSE ETB TOP FLAP & HOOKUP LEC.

UNSTOW AND PLACE SRC 2 ON +Y FOOTPAD

REST/CHECK EMU

-20 TRANSFER ETB INTO LM

REST/CHECK EMU

TRANSFER LEC HOOKS TO SURFACE

ATTACH LEC TO SRC

TRANSFER SRC INTO LM

CLEAN EMU

-10 ASCEND TO PLATFORM

## LMP ACTIVITIES

-30 REMOVE SIDE BAGS  
ASSEMBLE CORE TUBE AND HANDLE  
COLLECT CORE TUBE SAMPLE

CAP SAMPLE AND REMOVE HANDLE  
STOW SAMPLE IN SRC  
STOW 70MM IN ETB  
CLEAN EMU

ASCEND TO PLATFORM

INGRESS

CK. EMU & LM SYSTEMS

-20 ASSIST CDR

REMOVE ETB FROM LEC & STOW

ASSIST CDR

REMOVE SRC FROM LEC & STOW  
SWITCH TO ERECTABLE ANTENNA  
FOR COMM. CHECK

-10

## CDR ACTIVITIES

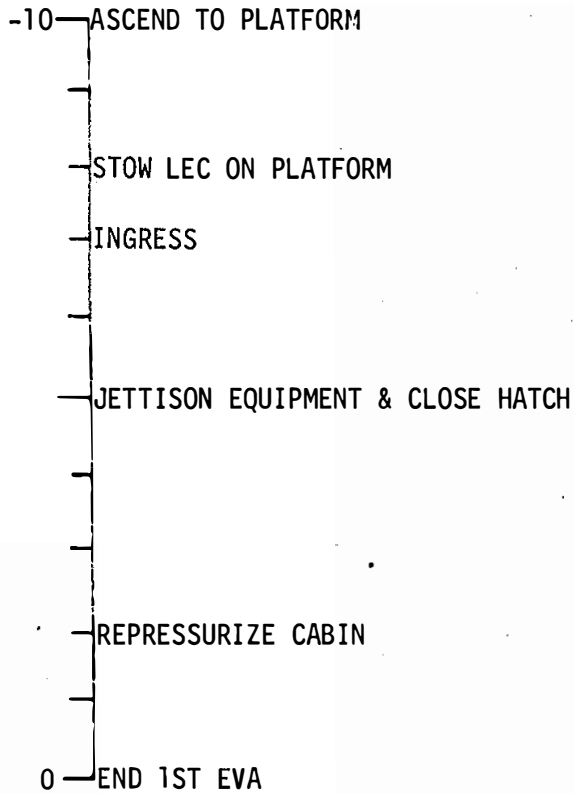

## LMP ACTIVITIES

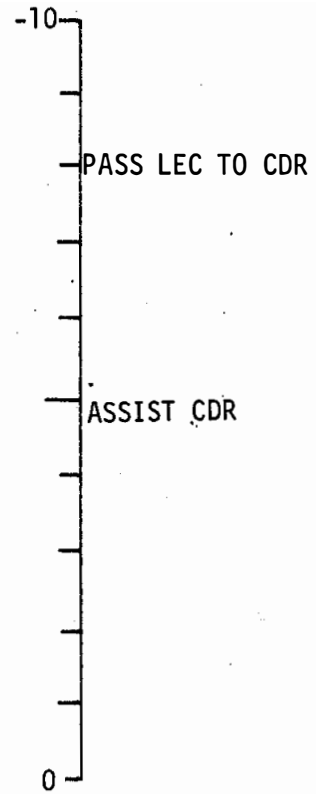
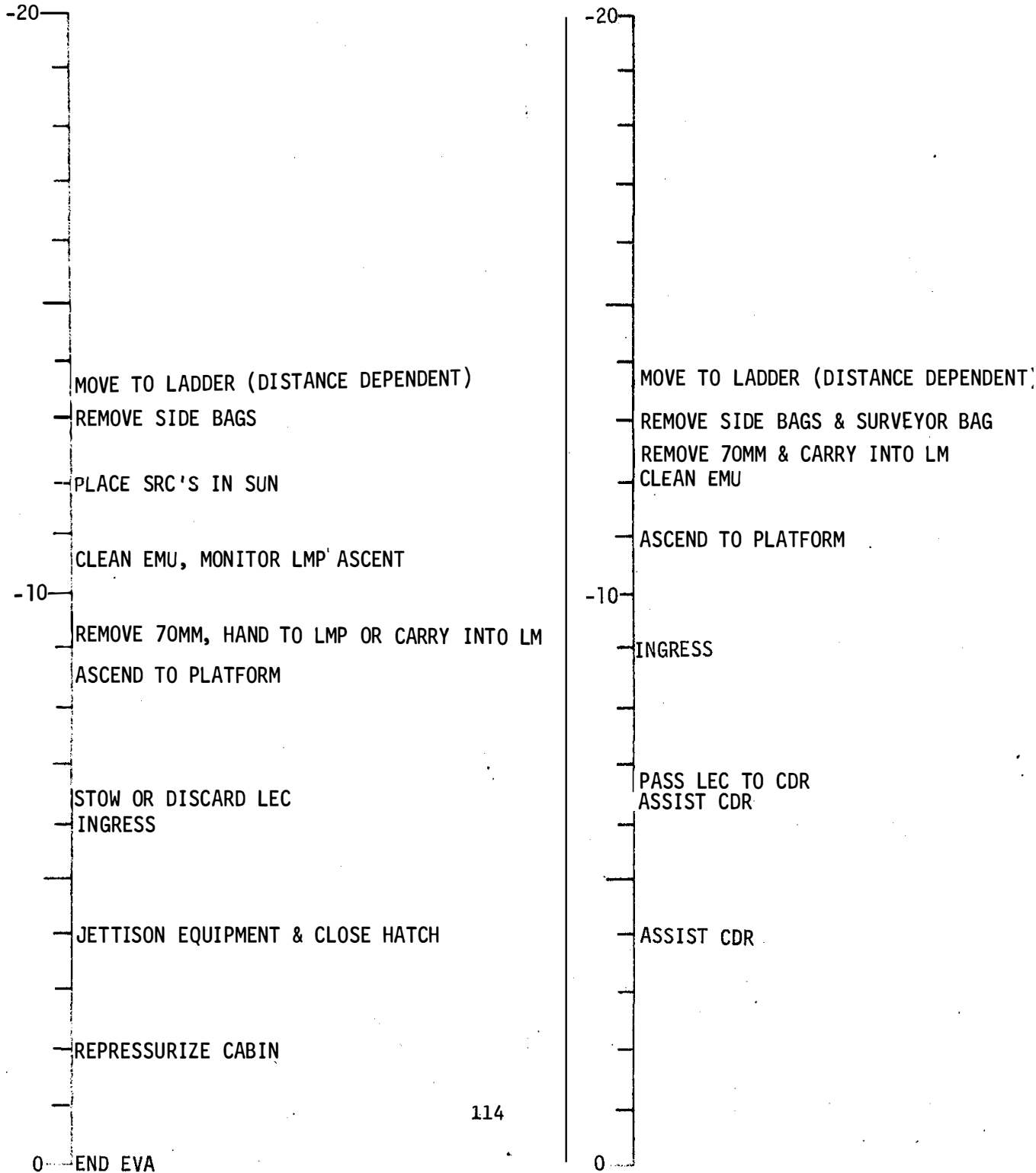

FIGURE 4-10

# TIMELINE C

## CONTINGENCY RAPID (13 MINUTE) EVA CLOSE-OUT



SECTION 5.0

APPENDIX

## 5.1 ABBREVIATIONS

ASC	ALSEP Central Station
ALHT	Apollo Lunar Handtool(s)
ALHTC	Apollo Lunar Hand Tool Carrier
ALSCC	Apollo Lunar Surface Close-Up Camera
ALSEP	Apollo Lunar Surface Experiments Package
A/S	Ascent Stage
BS	Bulk Sample
BTU	British Thermal Unit
CCIG	Cold Cathode Ion Gauge (Experiment)
CCW	Counterclockwise
CDR	Commander
CM	Command Module
CS	Contingency Sample
CSC	Contingency Sample Container
CSM	Command and Service Modules
CW	Clockwise
DD	Dust Detector (Experiment)
DPS	Descent Propulsion System
DRT	Dome Removal Tool
DS	Documented Sample
D/S	Descent Stage
ECS	Environmental Control System
EMU	Extravehicular Mobility Unit
ETB	Equipment Transfer Bag
EVA	Extravehicular Activity
FR	Frame Rate (Sequence Camera)
FTT	Fuel Transfer Tool
ITMG	Integrated Thermal-Meteoroid Garment
LD	Lunar Day (TV Lens)
LEC	Lunar Equipment Conveyor
LHSSC	Left Hand Side Stowage Compartment
LM	Lunar Module
LMP	Lunar Module Pilot
LRL	Lunar Receiving Laboratory
MCC-H	Mission Control Center - Houston
ME	Magnetometer (Experiment)
MESA	Modularized Equipment Stowage Assembly (Descent Stage)
MSFN	Manned Spaceflight Network
OPS	Oxygen Purge System
PLSS	Portable Life Support System
PSE	Passive Seismic Experiment
PSEP	Passive Seismic Experiment Package
RCS	Reaction Control System
RTG	Radioisotope Thermoelectric Generator
SC	Sequence Camera
S/C	Spacecraft
SEQ	Scientific Equipment (Bay) (Descent Stage)
SIDE	Suprathermal Ion Detector (Experiment)

SRC Sample Return Container  
SWC Solar Wind Composition (Experiment S-080)  
SWS Solar Wind Spectrometer (Experiment S-035)  
TV Television  
UHT Universal Handling Tool  
WA WSide Angle (TV Lens)

## 5.2 Lunar Surface Operational Constraints

### 5.2.1 Introduction

The lunar surface operational constraints presented in this section are restricted to the flight crew operational constraints which are concerned with lunar surface extravehicular activity. The constraints presented here are further restricted to the lunar surface EVA constraints for the second Lunar landing mission. Excluded are spacecraft constraints except where those constraints have a direct bearing on the crew members during the EVA operations.

By definition, a lunar surface constraint is any limitation imposed on lunar equipment design, operational procedure or sequence, etc. due to an equipment, human or environmental characteristic.

### 5.2.2 Constraint Classification

The constraints are divided into five different categories. The activity or equipment being constrained determines the category of the constraint. The constraints which fall into two or more categories are classified as GENERAL.

Each constraint is also identified according to the impact on the mission that a violation of the constraint would produce. Only the direct results of the constraint violation are considered in determining the violation classification. Multiple malfunctions and the different possible contingencies are not considered. The constraints violation classification is enclosed in parentheses following the constraint.

#### 5.2.2.1 Constraint Categories

##### Mission Operations:

Constraints on mission operations that are necessary due to considerations of a lunar surface activity.

##### Lunar Surface Operations:

Constraints on lunar surface operations that are necessary due to equipment design and/or the lunar environment.

##### Equipment Operation:

Constraints on equipment operation that are necessary due to the equipment design.



General:

Constraints that apply to two or more phases of the Apollo lunar landing mission.

5.2.2.2 Violation Classification

Critical:

A constraint that is necessary to prevent a compromise of mission safety. A violation of a critical constraint would jeopardize the safety of the crew or equipment essential to the completion of the mission.

Major:

A constraint that is necessary to prevent the compromise of the mission requirement.

Minor:

A constraint that cannot be classified as CRITICAL or MAJOR but is necessary to optimize lunar surface activities.

5.2.3 Mission Operations Constraints - None

5.2.4 Lunar Surface Operations Constraints

Spacecraft Attitude:

Lunar surface EVA operations will not be conducted when the angle of the LM X-axis with the local gravity vector exceeds 15°. This attitude may arise from the combination of all factors such as asymmetric compression of the landing gear struts and terrain conditions. (CRITICAL) (Provisional, documentation to substantiate is unavailable)

Landing Site Slope:

The maximum topographical slope on which lunar surface EVA operations will be conducted will be that which the astronaut can safely negotiate unassisted. This is presently established as 15°. (CRITICAL) (Reference: Unpublished report of test "Crewman Capability Investigation", by Dr. D. L. Lind, Astronaut, Partial Gravity Simulator, Building 5, MSC, November 8, 1968.)

### LM Forward (+Z) Hatch Operations:

The forward hatch may be left fully open during the EVA (up to 3 hours) provided: (CRITICAL) (GAEC LM Engineering Memorandum LMO-510-1201, April 24, 1969)

- 1) The cabin temperature, GF 1641T, must be between 60°F and 90°F at the beginning of the EVA, and
- 2) The sun vector is outside a 65° cone about the +Z axis.

Otherwise, the limit is:

- 1) 15 minutes for hatch fully open or
- 2) For the duration of the EVA provided the door is no more than 3 inches from the closed position, using the door snubber device for control.

### Forward Contamination Control:

Fecal bags and other human wastes will be processed with a disinfectant and double-bagged prior to jettisoning. It is preferred that these be returned to earth by transferring to the CSM. As alternatives the wastes will be stowed in the descent stage if possible. Otherwise, it will be left on the lunar surface. (MINOR)

### Extravehicular Communications System:

The first crewman to the lunar surface will operate in the relay mode. For two-man EVA operations the dual mode is nominal. (MAJOR) (Reference: NASA, Land, C.K., "Performance Analysis of The Extravehicular Communication System", MSC Internal Note EB-R-68-14, May 16, 1969.)

The PLSS antenna will be operated in the unstowed position after egress to preclude damage to the receiver. (MAJOR) (Reference: NASA, Minutes of the Configuration Control Board Meeting, Agenda Item 7, May 9, 1969.)

The fully unstowed PLSS antenna physically interferes with the S-band erectable antenna reflector during alignment operations. (MAJOR) (Reference: Slight, J. B., "S-band Erectable Antenna/EMU Physical Interference Test," Memorandum EC 64-111, July 20, 1967.)

### OPS Metabolic Capability:

The maximum heat removal of the Oxygen Purge System (OPS) is about 950 BTU/HR average over the period in which the man is storing 300 BTU. The heat removal capacity of the OPS is 475 BTU's. (CRITICAL). (Reference: Zieglschmid, J. F. M.D.; Results Eighth Lunar Surface Operations Planning Meeting; June 7, 1968).

### ALSEP Offloading

The ALSEP cannot be removed from the SEQ bay during the first excursion and deployed during the second excursion due to thermal considerations of the ALSEP equipment. (MAJOR) (Reference: Greider, H. R.; Sixth Lunar Surface Operations Planning Meeting, April 12, 1968).

### LiOH Cannister

The ECS LiOH cannister must be replaced when the CO<sub>2</sub> partial pressure reaches 7.6 mm of Mercury. Therefore, it must be unstowed from the descent stage and returned to the cabin during the first excursion. (CRITICAL) (Reference: LED-500-19, GAEC; Universal Mission Module Data Book; October 15, 1969).

### SEQ Bay

The Scientific Equipment Bay doors must be closed immediately after the ALSEP is removed from the bay in order to maintain LM thermal control. (CRITICAL) (Reference: Discussion Between: GAEC Engineers and Lunar Surface Operations Office Engineers; July 25, 1967).

### PLSS Battery

The PLSS battery must be replaced subsequent to the first EVA and prior to the second EVA. Therefore, it must be unstowed from the descent stage and returned to the cabin during the first excursion. (CRITICAL) (Reference: CF32-9M-276; Lunar Surface Operations Office; Twentieth Lunar Surface Operations Planning Meeting, September 12, 1969).

## 5.2.5 Equipment Operation Constraints

### Still Camera (Hasselblad):

Film Environment - The film magazine should not be exposed to vacuum conditions for periods in excess of 3 hours. The film temperature must be maintained in the range of 50-100°F. (MAJOR)

Sequence (Data Acquisition) Camera:

Magazine Temperature - The film magazine limits 120°F as indicated by temperature gage on side of magazine (MAJOR) (Ref: NASA R. Gerlach in Minutes Third Meeting Lunar Surface Operations Planning Meeting, 1/19/68).

Television Camera:

- 1) The Operating Environment Temperature Range is 0 to 100°F (MAJOR) (Reference: NASA, P. Coan in Minutes First Meeting Lunar Surface Operations Planning Meeting, November 17, 1967, also applies to items 2,3 below).
- 2) In all operations the radiating surface of the TV camera body must face in direction of deep space. (MAJOR)
- 3) The TV camera lens must not be pointed into the sun to avoid damage to vidicon tube screen. (MAJOR)

S-Band Erectable Antenna:

- 1) Line of Sight: The antenna requires unobstructed line of sight of the earth, free of any blockage of spacecraft elements or terrain. (CRITICAL) (Reference -NASA, S. Kelley, Minutes Second Lunar Surface Operations Planning Meeting, January 1, 1968; also applies to items 2 and 3 below).
- 2) Antenna Stability: The maximum equivalent pitch down reflector angle for tripod stability is 60°. This includes the actual pitch of the reflector to account for site location, correction for earth-moon undulations and terrain slope. The tripod design limit to terrain slope which can be manually compensated by tripod adjustment is 5°. (CRITICAL)
- 3) Cable Length: The antenna cable length outside the MESA is 30 feet. However, the usable length is determined after allowance is made to permit some lay of cable on surface to avoid pull on the antenna. The effective radius to deploy the antenna is then approximately 20 feet. (MINOR)

## Apollo Lunar Surface Experiments Package (ALSEP)

The ALSEP will be deployed 300 feet from the LM on the Z-axis in a Southwesterly direction. The 300 foot distance to the emplacement area is the result of a trade-off in comparing the necessity of ALSEP deployment out of the LM accent blast area with the constraints of keeping the crewman within the time and distance limitations dictated by the PLSS oxygen curve to assume a safe return to the LM. The walk to the deployment area is timed to prevent excess RTG warmup and thereby avoid thermal problems for the crewman. (MAJOR) (Reference: Weatherred, C. J.; Bendix Aerospace Systems Division; Letter - BX P.O 1726-68-970-1918, May 8, 1968).

### 1) ALSEP Hold Points

The following list of hold points is provided. The sequence of the ALSEP deployment may be stopped after the completion of any one of the hold points, to be continued at some later time by going to the next series of tasks. (MAJOR) (Reference: Clayton, J. F.; Bendix Aerospace; Letter October 27, 1967).

- 1a) Remove Packages #1 and #2; close SEQ bay door; emplace ALSEP packages with experiments in and facing the sun.
- 1b) Tilt fuel cask; dome not removed.
- 1c) Tilt fuel cask; remove dome, do not defuel.
- 1d) Fuel RTG; carry ALSEP to deployment site; remove ALHT (if necessary) and subpallet from Package no. 2; carry Package No. 1 to implace site (do not deploy); interconnect RTG cable (do not actuate switch).
- 1e) Deploy Package No. 1 as well as package No. 2; release and remove experiments; raise sunshield; deploy PSE and SWS (IF DESIRED).
- 1f) Deploy experiments and complete ALSEP tasks. A hold point exists after each experiment is deployed.

### 2) ALSEP Deployment

The ALSEP is deployed a minimum of 300 feet from the LM. The individual experiment constraints are as follows: (The Central Station/Package No. 1 is used as a reference with an imaginary clock superimposed on its top so that 12 o'clock falls on the back of the package). (MAJOR)

- 2a) RTG - The RTG is deployed at 9 o'clock from the central station at a distance of about 10 feet. The two packages are on an east-west line.
- 2b) PSE - The Passive Seismic Experiment is deployed at 3 o'clock from the central station at a distance of about 10 feet. It may be aligned ( $\pm 20^\circ$  of East) in one of two orientations on an east-west line. Its reference azimuth must be read and reported to MCC-H. The instrument must be leveled to  $\pm 5^\circ$ .
- 2c) LSM - The Lunar Surface Magnetometer is deployed at 4 to 5 o'clock from the central station at a distance of about 50 feet. It must be leveled to  $\pm 3^\circ$  and aligned to  $\pm 3^\circ$  pointing to the east in accordance with its markings. It must be removed as far as possible from the SIDE and the central station.
- 2d) SWE - Solar Wind Experiment is deployed at 6 o'clock from the central station at a distance of about 13 feet. The experiment is self-leveling but must be aligned to  $\pm 5^\circ$  on an east-west line with the Parabolic Reflector Assembly (PRA) pointing away from the central station.
- 2e) SIDE - The Suprathermal Ion Detector Experiment is deployed at 8 o'clock from the central station at a distance of 60 feet. The experiment must be leveled to  $\pm 5^\circ$  and aligned on an east-west line to  $\pm 5^\circ$  with its alignment arrow pointing toward the sub-earth point.
- 2f) CCIG - The Cold Cathode Ion Guage is connected to the SIDE. It is removed from the SIDE and placed 3-5 feet away with its orifice pointing away from the central station, the LM, and all other experiments and  $\pm 20^\circ$  of a north-south line.
- 2g) ALSEP Central Station - The central station must be leveled to  $\pm 2.5^\circ$  and aligned on a east-west line to  $\pm 1^\circ$ . Closed or contained sides of the central station must face east-west.
- 2h) ALSEP Antenna - The antenna is attached to the ALSEP central station and the antenna must be leveled to  $\pm 0.25^\circ$  and aligned on an east-west line to  $\pm 0.25^\circ$ .

## 5.2.6 Equipment Design Constraints

### Reach Limits:

- 1) The low reach limit to manually extract ALSEP packages from the SEQ bay is governed by the interference of the opened bay door. A minimum height for the opened door is 50 inches above the standing surface. (MAJOR)  
(Reference: NASA, Unpublished report "Lunar Surface Equipment Tests", Test Crewmen Dr. D. L. Lind and H. H. Schmitt, May 31, 1967; also 2 and 3 below).
- 2) The high reach limit to "push button" while wearing A5L suit is 76 inches. (MAJOR)
- 3) The high reach limit to "reach handle" while wearing A5L suit is 74 inches. (MAJOR)

### Astronaut Pull Force:

- 1) The maximum two-hand pull force that can be applied by a free standing astronaut in an A6L suit is 27 pounds. (MAJOR) (Reference: NASA Unpublished Report "Crew Capabilities of Suited Astronaut Operating in Partial Gravity Simulator", Test Crewman Dr. D. L. Lind, Test Conductor C. Klabosh, November 8, 1968; also 2 below).
- 2) The maximum one-hand pull force that can be applied by a free standing astronaut in an A6L suit is 17 pounds. (MAJOR)

## 5.2.7 General Constraints

### Skin Heat:

The maximum tolerable heat flow to a crewman's skin through suit contact is 18 BTU/FT minute. The pain threshold for heat applied to any part of the body is 113°F. (CRITICAL)

### Body Heat Storage:

The amount of heat that can be planned for a crewmember to store in his body during Oxygen Purge System (OPS) operations is 300 BTU. (CRITICAL)

### 5.3 ALSEP and Scientific Equipment Contingency Procedures

The following contingency procedures for Apollo 12 scientific and ALSEP equipment malfunctions were prepared by the Lunar Surface Project Office. These procedures are included as baseline planning data and are organized to cover equipment used in the following EVA functions:

	<u>PAGE</u>
5.3.1 - MESA DEPLOYMENT	126
5.3.2 - CONTINGENCY SAMPLE CONTAINER	126
5.3.3 - MESA AND RELATED EQUIPMENT	126
5.3.4 - SOLAR WIND COMPOSITION EXPERIMENT	128
5.3.5 - ALSEP OFFLOAD	129
5.3.6 - ALSEP PREP FOR TRAVERSE	135
5.3.7 - RTG FUELING	137
5.3.8 - ALSEP DEPLOYMENT	139
5.3.9 - APOLLO LUNAR SURFACE CLOSE-UP CAMERA	147



### 5.3.1 MESA DEPLOYMENT

- A. MESA release, "D" Ring will not release.
  - 1. Verify safety wire pip pin is removed.
  - 2. Attempt to free D Ring by exerting side loads on ring.
  - 3. Attempt to reach cable from D-ring to MESA. Pull on this cable with hand exerting side loads.
  
- B. "D" Ring releases, MESA does not deploy.
  - 1. Try repeated pulls on "D" Ring.
  - 2. Manually deploy MESA from surface with lanyard.
  - 3. One crewman pull on MESA lanyard while other crewman pulls "D" Ring.
  - 4. Abandon MESA.
  
- C. MESA fails to stop and hits lunar surface (lanyard breaks).
  - 1. Attempt to block up MESA with available rocks or SRC (on end).
  - 2. Attempt to tie up MESA if lanyard available.

### 5.3.2 CONTINGENCY SAMPLE CONTAINER (CSC)

- A. Handle comes off CSC before sampling, container falls on lunar surface.
  - 1. Attempt to retrieve with handle.
  
- B. Handle will not come off CSC after sampling
  - 1. Remove clip.
  - 2. If handle is stuck bend sampler handle toward cup ring until bag retaining pin is free of cup ring (approximately 90°) and remove bag.

### 5.3.3 MESA AND RELATED EQUIPMENT

- A. SRC table will not remain in proper position.
  - 1. Attempt to set on struts.
  - 2. Get assistance from other crewman to hold SRC during filling or to hold table.

- B. Unable to erect Gnomon/broken leg
  - 1. Place the gnomon at the first station indicated in the mission plan. Take the photographs for color reference indicated at that station and omit the gnomon afterwards.
  
- C. Spring scale inoperative for measuring
  - 1. Use the spring scale as a hook. Fill the weigh bag to the upper level.
  
- D. Unable to attach extension handle to scoop.
  - 1. Hit locking collar with hammer and attempt to free locking mechanism.
  
- E. Unable to attach sample bag to scale (torn bag).
  - 1. Use teflon hand hold strap and hang on scale or table.
  - 2. Hold in one hand, scoop with other.
  - 3. Obtain assistance from other crewman to hold bag during filling operation.
  
- F. Unable to open SRC
  - 1. Hit corners of SRC lid with hammer and attempt to pull lid free.
  - 2. Use second SRC.
  
- G. Unable to latch SRC
  - 1. Check that spacer has been removed. If not, remove.
  - 2. Open and look for interference.
    - (a) Relocate item, shake or pat to settle loaded weigh bag. If "O" ring out of groove, pull out and discard.
    - (b) Remove excess packing material or sample and repack.
  - 3. If no apparent interference, close and engage other strap latch. If this latch will rotate to within 30° of being closed, place other hand on back of box to permit application of maximum closing pressure by a muscular squeezing action.

- (a) If this strap latches, try first latch again in the same manner.
- (b) If the second latch will not latch, bring it back to earth with 1 latch closed.
- (c) If still cannot latch at least one side, abandon SRC.

H. Unable to transfer SRC (or film magazine) via LEC

1. Use LEC as a tether, attach SRC and pull it up from hatch.
2. If possible climb ladder while holding SRC.

I. SRC Seal Area Dirty

1. Bang on end and back or brush with glove to dislodge gross dirt.
2. Close and latch.

J. Unable to open or seal Gas Analysis Sample Container (GASC) or Lunar Environmental Sample Container (LESC)

1. Unable to open - hit rotation handle with hammer or bang against LM.
2. Unable to seal - check/remove both seal protectors. Check/free lanyard if impeding proper lid manipulation.
3. If unable to close; abandon.

K. Unable to tether documented sample collection bags (torn bag)

1. Tether by putting teflon hand hold in tether hook snap and then hooking on hard point of suit.

5.3.4 SOLAR WIND COMPOSITION EXPERIMENT

A. Pole will not go into surface.

1. Lean against LM facing sun.

B. Pole partially extended.

1. If pole is half or more normal length, continue experiment anyway.
2. Remove foil and use F.2. below.

- C. Reel not removable. No foil exposed to solar radiation.
  - 1. Highly unlikely. Discard experiment.
- D. Foil torn during extension.
  - 1. Continue experiment anyway.
- E. Foil comes off reel.
  - 1. Hang foil on pole by lanyard.
- F. Foil reel comes off poles.
  - 1. Reconnect to pole.
  - 2. Hang foil on LM structure facing most available solar radiation.
- G. Unable to re-roll foil by spring.
  - 1. Roll by hand or fold as conveniently as possible for crewman.
- H. No SWC Bag available.
  - 1. Continue experiment anyway. Bag not mandatory.
- I. No SRC Available.
  - 1. Remove foil from roller. Return foil in LM in bag preferably. If no bag available return as is. Stow with contingency sample in LM and CSM.
- J. Deployment selection alternatives.
  - 1. In full sunlight at least 6 feet from any shadow.

#### 5.3.5 ALSEP OFFLOAD

##### Open SEQ bay door:

- a. Remove thermal cover from door lanyard.
- b. Retrieve lanyard from right side of SEQ bay (remove lower velcro strap).

- c. Move to position clear of door.
- d. Pull white portion of lanyard to raise door.

A. SEQ BAY DOOR LANYARDS UNUSABLE

1. Lanyard free from cable, pull cable.
2. Lanyard melted fused to inconel - if unable to break free with hand pull, use hammer to free and pull cable (Step 1).

B. SEQ BAY DOORS WILL NOT OPEN

1. No cable movement (worst case) pry open astronaut protection door and fail mechanism. (Step II) Pull on lanyard again. (Step III) Use hammer to chop hole in main door inconel shield at center patch. (Step IV) Hook hammer behind cable and pull to release latch and open door while latch is pulled (Step V) Continue to open door upward.
2. With small cable movement - doors are unlatched and can be opened manually.

C. SEQ BAY DOOR PARTIALLY OPEN AND JAM

1. Continue pulling on lanyard. Get assistance to aid manually in raising door.
2. Discontinue lanyard use and manually raise door.
  - e. Temporarily stow lanyard on strut.
  - f. If Quad II is in a low attitude, connect folded doors with velcro strap.

Remove Package 1:

- a. Retrieve boom lanyard from package (handle).
- b. Move to position clear of package (approximately 10 feet).
- c. Pull white portion of lanyard to unlock and move package from SEQ bay to fully extended boom position.

D. PACKAGE UNLATCHING MECHANISM WILL NOT FUNCTION

1. If lanyard pulls loose or mechanism jams, use hammer claw to pry outward from structure on right-hand link of latching mechanism forcing latch over center and releasing packages.

E. PACKAGE WILL NOT SLIDE ON RAILS

1. Get assistance from second crewman.

F. BOOM WILL NOT DEPLOY

1. Release hockey stick at boom interface and manually deploy package.

G. BOOM PARTIALLY DEPLOYED AND PACKAGE SWINGING FREE OR RATCHET FAILS.

1. Package partially deployed still in bay on rails - support package and use manual deployment mode.
2. Ratchet fails - use two-man deployment: one supports, the other pulls pin on hockey stick.
  - d. Pull black and white striped portion of lanyard to lower package to surface.
  - e. Release white portion of lanyard from base of package.

H. WHITE PORTION OF DEPLOYMENT LANYARD WILL NOT RELEASE FROM BASE OF PACKAGE

1. Grasp release latch at base of package and twist in upward motion to break lug free of structure.
2. Use bolt cutters to snip lanyard.
3. Cut lanyard with hammer against LM or rock to break or tear lanyard (webbing loose).
  - f. Pull small lanyard (velcroed to handle) on package to release boom cable and lanyards. Reattach lanyard to velcro.

I. PIN JAMMED OR LANYARD BREAKS

1. Attempt to pull pin at pin interface.
2. Remove entire hockey stick by removing pull pin at carry handle.
  - g. Move Package clear of SEQ bay.
  - h. Pull black and white striped lanyard to retract boom (or push boom back with hand.)

J. BOOM DOES NOT RETRACT

1. Attempt retraction by both crewmen working simultaneously, one pulling the lanyard and the second pushing on boom (if within reach).
2. Apply side loads on the boom with the hammer while second crewman pulls lanyard.

Remove Package 2:

- a. Retrieve boom lanyard from package (handle).
- b. Move to position clear of package (approximately 10 feet).
- c. Pull white portion of lanyard to unlock and move package from SEQ bay to fully extended boom position.

K. PACKAGE LATCHING MECHANISM WILL NOT FUNCTION

If lanyard pulls loose or mechanism jams, use hammer to pry outward from structure on right-hand link of latching mechanism forcing latch over center and releasing packages.

L. PACKAGE WILL NOT SLIDE ON RAILS

Get assistance from second crewman.

M. BOOM WILL NOT DEPLOY

Release hockey stick and manually deploy package.

N. BOOM PARTIALLY DEPLOYED AND PACKAGE SWINGING FREE OR RATCHET FAILS.

1. Package partially deployed still in bay on rails-support package and use manual deployment mode.
2. Ratchet fails - use two-man deployment: one supports, other pulls pin on hockey stick.
  - d. Pull black and white striped portion of lanyard to lower package to surface.
  - e. Release white portion of lanyard from base of package.

O. WHITE PORTION OF DEPLOYMENT LANYARD WILL NOT RELEASE FROM BASE OF PACKAGE

1. Grasp release latch at base of package and twist in an effort to break the latch or the slot.
2. Use bolt cutters to snip lanyard.
3. Cut lanyard with hammer against LM or rock to break or tear lanyard (webbing) loose.
  - f. Pull small lanyard (velcroed to handle) on package to release boom cable and lanyards. Reattach lanyard to velcro.

P. PIN JAMMED OR LANYARD BREAKS

1. Attempt to pull pin at pin interface.
2. Remove entire hockey stick by removing pull pin at carry handle interface.
  - g. Move package clear.
  - h. Pull black and white striped lanyard to retract boom (or push boom back with hand).

Q. BOOM DOES NOT RETRACT

1. Attempt retraction by both crewmen working simultaneously one pulling the lanyard and the second pushing on the boom (if within reach).
2. Apply side loads on the boom with the hammer white second crewman pulls lanyard.

Manual Package Removal

Remove Package 1:

- a. Retrieve pull pin at bottom of package to release hockey stick from boom.

R. PIN JAMMED OR LANYARD BREAKS

1. Attempt to pull pin at pin interface.
2. Remove package on boom.
3. Remove entire "hockey stick" via pull pin at carry handle interface after boom removal.
  - b. Remove deployment lanyard from package and pull white portion to unlock package from bay.

S. PACKAGE LATCHING MECHANISM WILL NOT FUNCTION

If lanyard pulls loose or mechanism jams, pry outward from structure on right-hand link of latching mechanism forcing latch over center and releasing packages.

T. WHITE PORTION OF DEPLOYMENT LANYARD WILL NOT RELEASE FROM BASE OF PACKAGE

1. Grasp release latch at base of package and twist in upward motion to break lug free of structure.
2. Use bolt cutters to snip lanyard.



3. Cut lanyard with hammer against LM or rock to break or tear lanyard (webbing) loose.
  - c. Move deployment lanyard to slide clear of package.
  - d. Manually pull package clear of SEQ bay.
  - e. Set package on surface clear of bay area.

Remove Package 2:

- a. Pull small lanyard, at top or bottom of package, to release hockey stick from boom.

U. PIN JAMMED OR LANYARD BREAKS

1. Attempt to pull pin at pin interface.
2. Remove package on boom.
3. Remove entire hockey stick by removing pull pin at carry handle interface and carry package to site with carry handle, after boom removal.
  - b. Remove deployment lanyard from package and pull white portion to unlock package from bay.

V. PACKAGE LATCHING MECHANISM WILL NOT FUNCTION

If lanyard pulls loose or mechanics jams, use hammer claw to pry outward from structure on right-hand link of latching mechanism forcing latch over center and releasing packages.

- c. Release white portion of lanyard from base of package.

W. WHITE PORTION OF DEPLOYMENT LANYARD WILL NOT RELEASE FROM BASE OF PACKAGE

1. Grasp release latch as base of package and twist in an effort to break the latch or the slot.
2. Use bolt cutters to snip lanyard.
3. Cut lanyard with lanyard against LM or rock.
  - d. Move deployment lanyard to side clear of package.
  - e. Manually pull package clear of SEQ bay.

### 5.3.6 ALSEP PREP FOR TRAVERSE

#### A. PULL PINS JAM AT PALLET/HTC

1. Apply additional force while rotating pin with the aid of the second crewman.
2. Use MESA hammer to pry pin free.
3. Remove all accessible tools, stow on MESA and deploy subpackage #2 with HTC attached.

#### B. QUARTER TURN FASTENERS JAM OR WILL NOT RELEASE

1. Apply additional force while rotating 1/4 turn pins with the aid of second crewman.
2. Use MESA hammer to rotate or break fasterers.
3. Remove all accessible tools, stow on MESA and deploy subpackage 2 with HTC attached.

#### C. LEGS AND CARRIER WILL NOT EXTEND AND LOCK

1. Apply additional force with the aid of second crewman.

#### D. HAND TOOL CARRIER WILL NOT OPEN TO DEPLOYED POSITION

1. Apply additional force with MESA hammer.
2. Request aid of second crewman.

#### E. SUBPALLET PULL PIN JAMS

1. Apply additional force with MESA hammer.

#### F. FORWARD TOOL SUPPORT PULL PIN JAMS

1. Apply additional force with MESA hammer.
2. Remove third and fourth pull pin and bend/break the tool support or at least bend to a point where the DRT, FTT and masts can be removed. All four pieces must be used to prevent an ALSEP abort.
3. Use bolt cutter to free bracket from pallet.

G. UHT PULL PIN JAMS

1. Apply additional force with MESA hammer.
2. Remove entire front tool bracket assembly from pallet and apply side loading to DRT's while pulling pins.
3. Use bolt cutter to cut UHT's away from the bracket.

NOTE

UHT's cannot be used if they remain attached to the forward tool bracket, due to trigger clearance.

H. DRT PULL PIN JAMS

1. Apply additional force with MESA hammer.
2. Remove entire front tool bracket assembly from pallet and apply side loading to DRT's while pulling pins.
3. Use bolt cutter to cut bracket.
4. Attempt removal of the dome with the forward tool bracket attached. Limited hand hold and reduced vision will result from using this technique.

I. TOOLS DO NOT ENGAGE IN STOWAGE/CARRY SOCKETS

1. (LMP) stow in alternate socket on PSE, SWE.
2. (CDR), SIDE or aiming mechanism socket may be used as an alternate carry socket.
3. LMP/CDR use teather hook to secure UHT's.

J. ANTENNA MAST SECTIONS DO NOT LOCK IN POSITION AFTER ENGAGED AND ROTATED

1. Separate mast sections, examine for obstructions, clean or dislodge spring by knocking masts together and reconnect.
2. Re-engage and carry in normal mode. - check out

K. CARRY BAR WILL NOT ENGAGE IN "KEY HOLE" SOCKET

1. Ensure flange on carry bar is free of debris; if not, clean by impact or with gloved hand.
2. Ensure "keyhold" socket is clean; if not, clean with available MESA tools or UHT.
3. If one or both sockets are unusable, LMP carry sub-pallet 1 and 2 in suitcase mode with the CDR carrying subpallet and carry bar.

L. BOYD BOLT DOES NOT RELEASE

1. Visually check (if possible) to see if bolt is released and not loose/raised due to side loading.
2. Visually check hex head on UHT. If broken, use second tool. In a case where the second tool breaks, with bolts remaining to be released, abandon ALSEP mission.
3. Insert UHT and apply downward pressure on center spline. Use hammer if necessary. Turn CCW to release.
4. If spline is depressed and bolt will not rotate, apply CW rotation and turn back CCW.
5. Leave subpallet on subpackage #2.

M. SUBPALLET BINDS ON PALLET AND WILL NOT COME OFF IN NORMAL MANNER USING UHT.

1. Ensure the front portion of the subpallet has been raised (3/8") to clear the mounting stud.
2. Apply side loads with UHT using a two handed grip.
3. Assist the forward movement of the subpallet with the lunar boot making sure the mounting stud is clear.
4. With the second crewman's help, manually aid in removal by using the back support structure as an additional lever.

5.3.7 RTG FUELING

A. RTG LANYARD BREAKS OR PULLS AWAY FROM CAM LEVER

1. Use MESA tools hammer/extension as hook and pull forward in cam lever to release.

B. CAM LEVER FAILS TO RELEASE THE UPPER TRUNNION AFTER LEVER IS FULLY DEPLOYED.

1. Use hammer/extension as hook on astronaut guard to break free at trunnions.

C. CASK WILL NOT ROTATE WITH LANYARD

1. Verify upper trunnion release by attaching extension to MESA hammer, hook on astronaut guard, and ensure that the cask is free of the upper trunnion.

2. Request aid of the second crewman (CDR) to apply downward force on the guard while the LMP attempts to rotate with the lanyard.
3. Continue to apply force to fail gear box if required, CDR may use hammer to apply additional force.

D. ENGAGING MECHANISM ON DRT DOES NOT LOCK DUE TO MECHANICAL FAILURE

1. Apply forward pressure and rotate, attempting to remove dome with side loading on the DRT.
2. Caution should be exercised in this operation.
3. Remove DRT and attempt removal of dome with MESA tools; e.g., hammer and tongs, with second crewman assisting.

E. ENGAGEMENT FINGERS DO NOT EXPAND (INOPERATIVE).

1. Request aid of second crewman to apply additional force to FTT knob.
2. Apply impact pressure on knob by knocking on the LM landing gear.

F. FTT WILL NOT RELEASE FROM CAPSULE AND REMAINS LOCKED

1. Apply additional force to release knob
2. Leave FTT in place on the fueled RTG and while LMP carries subpallet #2 in barbell mode, the CDR will monitor the RTG/capsule.
3. The RTG cable may be used to "drag" the pallet away from the LM approximately 300 ft. if the crew feels the task is within their safety margin.

Close SEQ bay door: (If opened manually, close manually)

- a. Retrieve door lanyard.
- b. Move to position clear of door.
- c. Pull black and white stripe portion of lanyard until door is close.

G. SEQ BAY DOOR WILL NOT LOWER

1. Attempt to close manually.

H. SEQ BAY DOORS PARTIALLY CLOSED

1. Attempt to close manually.
  - d. Discard lanyard.

I. CARRY BAR FLANGE WILL NOT ENGAGE IN KEYHOLE

1. Ensure flange on carry bar is free of debris; if not, clean by impact or with gloved hand.
2. Ensure "keyhold" socket is clean; if not, clean with available MESA tools or UHT.
  - e. If one or both sockets are unusable, LMP carry SP 1 and SP 2 in suitcase mode with the CDR carrying subpallet and carry bar.

5.3.8 ALSEP DEPLOYMENT

A. CARRY BAR BINDS IN KEYHOLE SOCKET ON SUBPACKAGE #2

1. Ensure trigger release is operable.
2. If trigger is released, apply additional downward pressure while applying side loads to subpackage #2.
3. Request aid of CDR to lift subpackage #1.
4. Break off Mast Section.
5. Emplace subpackage #2 with antenna mast section attached burying the one section as far as possible into the lunar surface.
6. Attempt rough alignment with aiming mechanism mounted on sunshield.

B. CARRY BAR BINDS IN KEYHOLE SOCKET ON SUBPALLET #1

1. Ensure trigger release is operable.
2. If trigger is released, apply additional downward pressure while applying side loads to subpackage.
3. Request aid of CDR to lift subpackage.

NOTE

With mast attached to subpackage #1, emplacement may be difficult, or impossible, in varying lunar surfaces.

4. Break off mast section as last resort to allow for proper emplacement, i.e., level orientation.

- C. CABLE REEL FALLS TO THE LUNAR SURFACE WHEN FINAL BOYD BOLT (BB) IS REMOVED
1. Retrieve cable reel with UHT handle, determine tempilable temperature. If under 250°F, grasp reel assembly, connect UHT, and continue deployment.
  2. If tempilable indicates temperature over 250°F, request the aid of the second crewman, (CDR) retrieve reel with UHT, lay reel, assemble on subpallet #1, secure with UHT and continue.
- D. CABLE REEL BB CANNOT BE RELEASED
1. Use boyd bolt procedure (page 11).
  2. If procedure fails to release bolts: tilt package on carry handle side, and utilize UHT to unwind cable manually to expose shorting plug.
  3. With the aid of the second crewman, release pull pin and tie down.
  4. Lower package to lunar surface.
- E. SHORTING PLUG PULL PIN DOES NOT RELEASE
1. Apply additional force with hammer.
  2. Lower subpackage #2 to lunar surface and apply force with hammer.
  3. With pick end of hammer, tear away retainer assembly.
- F. SHORTING SWITCH CONNECTOR FAILS TO ENGAGE AND LOCK TO C/S
1. Check switch connector for proper orientation.
  2. Check both connectors for debris on pins or C/S receptacle.
  3. Depress outer flange of switch connector to ensure proper function (1/4" sliding action)
  4. Reconnect applying additional downward pressure on the flange assembly with the CDR helping to provide additional stability. (CDR can aid by holding PLSS).
- G. CONNECTOR RETAINER PULL PIN DOES NOT RELEASE
1. Attempt release by pushing down on fastener before pulling up, using UHT.
  2. Stand on pallet and apply additional force.

H. CABLE REEL DOES NOT DEPLOY FROM EXPERIMENT STOWAGE CAVITY

1. Check to see if BB and cup are free; if not, remove manually.
2. Grasp the reel and remove manually.
3. Use second UHT handle to aid in extracting the reel.
4. Deploy as much cable as possible which tends to force the reel out.
5. Deploy experiments as far from ALSEP in the preferred direction as possible.

I. SIDE CONNECTOR FALLS TO SURFACE

1. Retrieve connector with UHT handle in pull ring on lanyard.
2. Retrieve connector by lifting cable and working hand along cable to connector.
3. Ensure connector is free of foreign particles.

J. ONE LEG BREAKS OFF WHILE EMPLACING THE EXPERIMENT PRIOR TO INTERCONNECT

1. Prop up experiment with rock or other lunar debris.
2. While lowering experiment, fold under remaining legs and leave on surface.
3. Break off remaining legs and emplace experiment directly on the surface.

K. CONNECTOR FAILS TO ENGAGE

1. Check connectors on cable and central station for foreign material and bent pins.
2. Remove or shake out debris.
3. Ensure outer flange is free to travel to the lock position.
4. Attempt to reconnect checking visual indicator (orange ring).

L. CONNECTOR ENGAGES BUT FALLS OFF WHEN PACKAGE IS ROTATED

1. Return package to vertical position, retrieve cable (as above), check for foreign matter and remate connectors.
2. Ensure locking mechanism is fully forward and orange ring is visible.

M. PULL PIN DOES NOT RELEASE

1. Apply additional pressure downward on push/pull pin in an attempt to free the balls.
2. Use MESA tools (hammer) to pry retaining latch off the subpallet.



N. PSE STOOL TURNS UPSIDE DOWN WHILE EMPLACING ON LUNAR SURFACE

1. Using UHT, turn stool over to proper "upright" position ensuring that the stool is in a level area, using boot to level surface if necessary.

O. BOYD BOLTS DO NOT RELEASE ON PSE MOUNTS

1. Procedure as described for first Boyd Bolt on page 137 (subpallet).
2. Leave experiment on sunshield.
3. With UHT, tear away or deploy cable from cable reel.

P. EXPERIMENT FALLS OFF UHT DUE TO ACCIDENTAL TRIGGERING

1. Using UHT, retrieve cable and gently lift experiment with cable. Secure mounting lug (tab) with hand and attempt to re-engage UHT in socket.
2. If UHT engagement fails, pull shroud pin, discard shroud/skirt assembly and emplace experiment manually using gnomon.

NOTE

At 1/6 gravity the skirt should not unfold and cause interference.

Q. EXPERIMENT FALLS OFF STOOL WHILE LEVELING AFTER SKIRT FULLY DEPLOYED

1. Retrieve experiment with UHT handle hooked into gnomon opening and lift experiment.
2. Grasp thermal skirt and raise to a position to observe stool.
3. Lower experiment on stool.

R. UHT PUNCTURES THERMAL SHROUD DURING LEVELING SEQUENCE

1. Remove UHT from puncture and attempt to cover the opening if the hole remains.

S. LUNAR DEBRIS DEGRADES READABILITY OF BUBBLE LEVELING INDICATOR AND ALIGNMENT INDEX ON SHROUD

1. Level by using the local surface area as a reference (PSE shadow).

2. Ensure ample picture coverage is obtained to verify experiment orientation

T. BOYD BOLT(S) DO NOT RELEASE ON SWE MOUNTS

1. Visually check (if possible) to see if bolt is released and not loose/raised due to side loading.
2. Visually check hex head on UHT. If broken, use second tool. In a case where the second tool breaks, with bolts remaining to be released, abandon ALSEP mission.
3. Insert UHT and apply downward pressure on center spline. Use hammer if necessary.
4. Turn CCW to release.
5. If spline is depressed and bolt will not rotate, apply CW rotation and turn back CCW.
6. Leave experiment on sunshield.
7. Deploy cable manually using UHT handle.

U. EXPERIMENT FALLS OFF C/S TO THE SURFACE DURING UHT MANAGEMENT OR THROUGH ACCIDENTAL TRIGGER RELEASE DURING CARRY MODE

1. Retrieve experiment with UHT handle by hooking the lip of the handle through the "A" frame leg. Grasp the experiment by the top part of the leg and slide the hand up to the bottom of the thermal plate and engage the UHT to the socket.
2. Retrieve by securing cable and lifting SW with cable.

V. LEGS ARE NOT FULLY EXTENDED AND EXPERIMENT COLLAPSES WHEN DEPLOYED ON THE LUNAR SURFACE

1. Retrieve experiment with UHT handle by hooking the lip of the handle through the "A" frame leg. Grasp the experiment by the top part of the leg and slide the hand up to the bottom of the thermal plate and engage the UHT to the socket.
2. Extend legs to positive lock position.
3. If leg lock mechanism is damaged, emplace experiment on a local rock or debris to provide the best possible leveling.

W. ACCIDENTAL RELEASE OF SENSOR DUST COVERS

1. No corrective action.

X. BOYD BOLTS DO NOT RELEASE

1. Visually check (if possible) to see if bolt is released and not loose/raised due to side loading.
2. Visually check hex head on UHT. If broken, use second tool. In a case where the second tool breaks, with bolts remaining to be released, abandon ALSEP mission.
3. Insert UHT and apply downward pressure on center spline; use hammer if necessary. Turn CCW to release.
4. If spline is depressed and bolt will not rotate, apply CW rotation and turn back CCW.
5. Cut off mounting lugs at BB/experiment standoff interface.

Y. UPPER SUPPORT BRACKET HANDLE DOES NOT DEPLOY

1. Use the UHT to pry the handle into the upright position for grasping.
2. Apply tension to the center lanyard with glove or UHT to release "pip pin" at EGFU. If successful, apply tension to other two lanyards to release "A" frame swing brackets from EGFU. The forward bar bracket upper and lower sections can be separated later after removal from S/P 1.

Z. LSM WILL NOT RELEASE FROM ITS MOUNTING PINS

1. If center lanyard is untied or broken, there is no means of unlocking from the mounting pins. If lanyard is intact, pry under EGFU handle to effect unlocking. If unlocked, but binding on mounting pins, attempt to pry under rear of EGFU with UHT.

AA. LEGS WILL NOT DEPLOY

1. If spring-loaded legs do not self-deploy after removal of forward bracket, assist their deployment by hand.
2. If attempts at leg deployment are futile and/or any leg is damaged, attempt to deploy LSM in a level state using whatever means at hand, including a rock under a corner. As a last resort, lay the EGFU flush on the lunar surface and attempt leveling.

BB. ASTRONAUT ACCIDENTALLY POKES HOLE IN TOP OF SUNSHIELD WITH UHT WHILE LEVELING

1. If a ragged gash, attempt to smooth thermal surface with UHT. If a true puncture, report and proceed.

CC. ASTRONAUT TIPS LSM OVER ON BOOMS

1. Grasp uppermost boom and put LSM upright.

DD. LEVELING INDICATOR DEGRADED AND UNREADABLE

1. Level by eye.

EE. BOYD BOLT(S) FAIL TO RELEASE

1. Visually check (if possible) to see if bolt is released and not loose/raised due to side loading.
2. Visually check hex head on second tool. In a case where the second tool breaks with bolts remaining to be released, abandon ALSEP mission.
3. Insert UHT and apply downward pressure on center spline. Use hammer if necessary. Turn CCW to release.
4. If spline is depressed and bolt will not rotate, apply CW rotation and turn back CCW.
5. Advance to the next series of boyd bolts and return.

FF. RF ANTENNA CABLE REEL LANYARD BREAKS

1. Use handle of UHT to engage (hook) restraint and bend/break restraint off the sunshield.
2. Deploy cable using UHT.

GG. SUNSHIELD FAILS TO RAISE AFTER ALL BOYD BOLTS ARE RELEASED

1. Engage UHT in temporary stowage socket and raise sunshield manually with UHT as lever arm.
2. Check to see if curtain covers are jammed.

HH. ANTENNA MAST BINDS ON SUBPALLET TAPER FITTING LIFTING SUBPALLET

1. Stand on subpallet and rotate mast while applying additional lifting force on lower half.

II. ANTENNA MAST MOUNT ON C/S COVERED WITH LUNAR DEBRIS

1. Clear area with lunar boot.
2. Raise subpackage with sunshield to clear mount and lower surface

JJ. AIMING MECHANISM FALLS OUT OF HOUSING ON LUNAR SURFACE

1. Retrieve mechanism with UHT handle and shake debris off, clean taper fitting with glove.

KK. CREWMAN DOES NOT FULLY SEAT ANTENNA INTO MECHANISM

1. Apply additional downward force.
2. Ensure cable outlet is properly oriented.

LL. GROUND SCREEN WILL NOT DISENGAGE FROM UHT W/TRIGGER DURING SCREEN DEPLOYMENT

1. Manually remove screen from UHT.
2. Deploy screen manually and drop on the lunar surface as flat as possible.
3. If UHT will not disengage, leave it on the screen and continue deployment using second UHT.

MM. SIDE FALLS OVER WHILE EMPLACING EXPERIMENT

1. Attempt to pick up experiment by cable after retrieving cable with UHT.
2. Grasp experiment at reel housing and reinsert UHT.
3. Clean experiment with thermal glove or through impact.

NN. CCIG CANNOT BE ORIENTED AWAY FROM LM OR C/S

1. Orient north or south with as clear a view as possible. (Orifice perpendicular to E-W)

OO. SIDE LEG BREAKS

1. Prop up experiment with rock or other lunar debris.
2. While lowering experiment, fold under remaining legs and leave on surface.
3. Break off remaining legs and emplace experiment directly on the surface.

PP. DUST COVER RELEASES WHEN PULL PIN IS REMOVED, OR WHILE REMOVING CCIG

1. Attempt to relatch cover.
2. Deploy with cover open.

QQ. SHORTING SWITCH DEPRESSES AND GAGE SHOWS NO DROP IN AMPERAGE

1. Apply additional pressure.
2. Using UHT as a cane for stability and with the aid of second crewman, attempt to kneel down on one knee by the connector and pry cable connector/shorting switch free of C/S.
3. Remove shorting switch, discard, and connect cable connector directly to C/S fitting, using the same technique as in #2 and #3 above.

NOTE

Failure to interconnect the cable to C/S and have an indication of power to the C/S would not affect the crewmen's task at this point. The next action would be by MSFN and report of downlink verification to the crew.

RR. DOWNLINK VERIFICATION TO MSFN (NEGATIVE)

1. Continue photos of SIDE and ALSEP array deployed on surface (+10 min)
2. Request downlink "turn-on" verification from MSFN.
3. Turn astronaut switch number 2 and number 3.
4. Request downlink "turn-on" verification from MSFN.
5. Check alignment of antenna, bubble level.
6. Check RF cable connection for mechanical damage (visually).

5.3.9 APOLLO LUNAR SURFACE CLOSE-UP CAMERA

- A. Cycle light does not come on after depressing trigger on first exposure.

Determine if red scale marks on camera top skirt are visible, indicating skirt is fully deployed. If marks are not visible depress camera skirt and release, noting if both latches are released. (NOTE: Occasionally the last skirt retaining latch released will catch in a secondary mode and not permit the skirt to fully extend and enable the camera.)

- B. Cycle light does not come on after depressing trigger first time and red scale marks on camera skirt are visible.

Depress the black safety switch located to the left of the handle extension pole base and push camera down until skirt is fully retracted and then release. Repeat two times. Repeat exposure noting if flash discharges and cycle light comes on. If flash

discharges and cycle light does not come on, cycle light has failed but camera is still operative. Continue photography allowing 10 seconds between exposures. If flash does not discharge discard camera.

C. Cycle light remains on for more than 10 seconds.

If cycle light goes off within 25 seconds continue photography. If cycle light does not go off after 25 seconds, remove cassette, if more than three pictures have been taken, and discard camera.

D. Film attached to supply roll when take-up cassette is removed from camera.

Rotate film cutter until it detents. Grasp film and cut by pulling it back against cutter blade. Stow cassette.

## 5.4 Nominal Lunar Surface EVA Metabolic Profiles

### 5.4.1 Introduction

The following metabolic profiles were derived under the direction of G. F. Humbert, M.D., Chief of Environmental Medicine, and give the current estimates of the work loads to be experienced by the Commander and Lunar Module Pilot during both Apollo 12 Lunar Surface EVA'S. The estimates are based on Gemini EVA's crew training exercises and Apollo 11 EVA.

The profiles represent estimates of the work load and as such are subject to revision as further data becomes available. The data is given for crew member for both EVA 1 and EVA 2.

### 5.4.2 EVA 1

The CDR's BTU output for the three hour and thirty minute timeline is estimated to be 4081 BTU with a mean rate of 1166 BTU/Hour. The estimate for the LMP is 3996 BTU with a mean rate of 1142 BTU/Hour for the same time period.



APOLLO 12 EVA I CDR METABOLIC PREDICTIONS

<u>ACTIVITY</u>	<u>MINUTES</u>	<u>PREDICTED RATE (Btu/Hr.)</u>	<u>TOTAL</u>	<u>CUMMULATIVE Btu</u>
Pre-EVA Operations	10	800	133	133
Egress	7	1200	140	273
Environmental Familiarization	6	1000	100	373
CSC	3	800	40	413
ETB Packing	7	1200	140	553
ETB Transfer	7	1400	163	716
Photo	10	1000	167	883
S-Band Deployment	20	1300	433	1316
Photo	8	1000	133	1449
ALSEP Off Load	10	1200	200	1649
RTG Fueling	5	1000	83	1732
ALSEP Traverse Preparation	6	1200	120	1852
ALSEP Traverse	10	1200	200	2052
ALSEP Site Survey	5	1200	100	2152
ALSEP System Interconnect	10	1200	200	2352
SWE Deploy	4	1200	80	2432
LSM Off Load	4	1200	80	2512
Sunshield Deploy	8	1200	160	2672
Antenna Installation	11	1200	220	2892
ALSEP Activation	5	1200	100	2992
Return Traverse	6	1200	120	3112
Selected Sample Collection	20	1100	367	3479
ETB Pack and Transfer	9	1300	195	3674
Selected Sample Transfer	8	1400	187	3861
EVA Termination	<u>11</u>	1200	220	4081
	210 minutes	150		

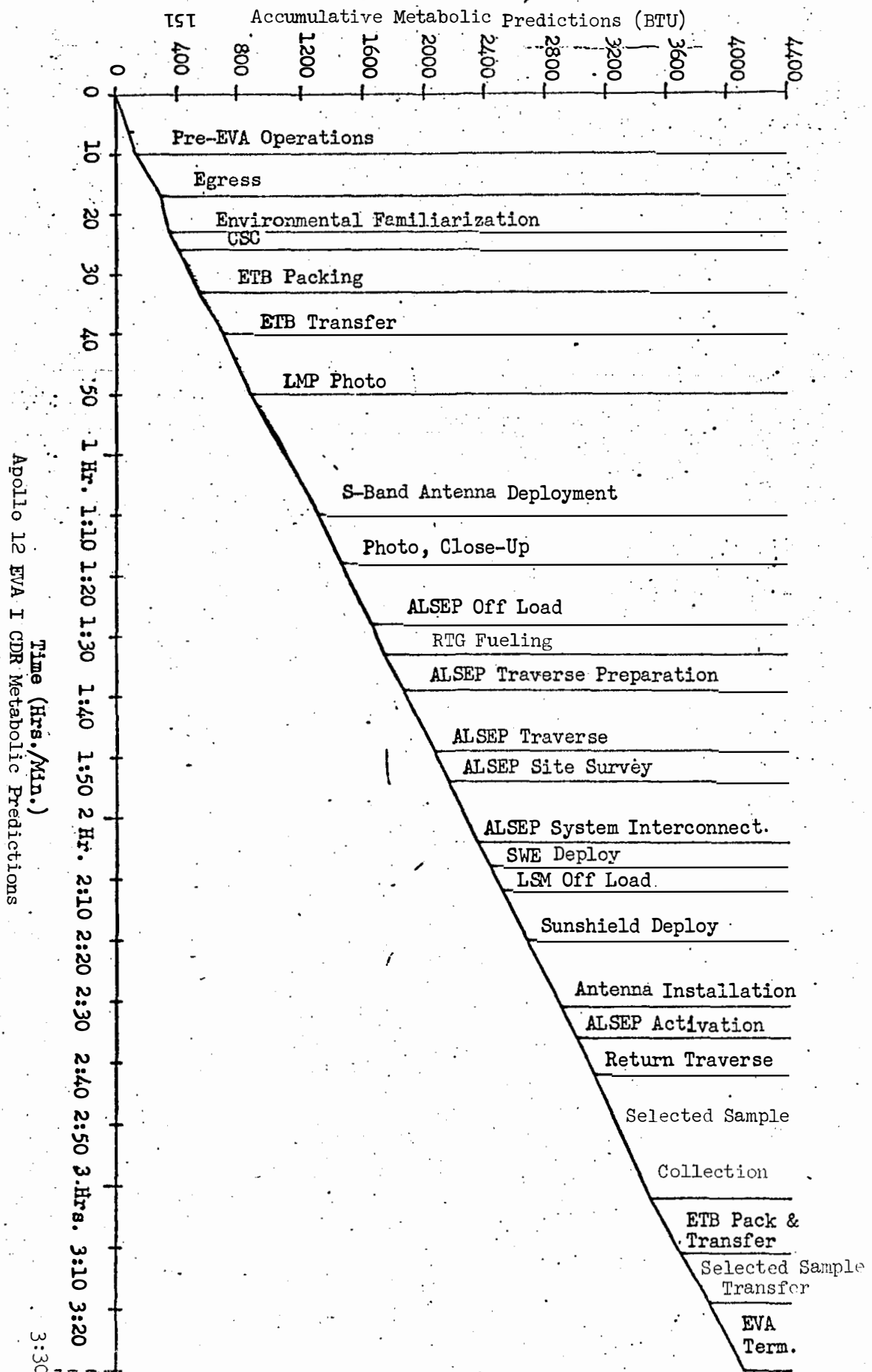

APOLLO 12 EVA I LMP METABOLIC PREDICTIONS

<u>ACTIVITY</u>	<u>MINUTES</u>	<u>PREDICTED RATE (Btu/Hr.)</u>	<u>TOTAL</u>	<u>CUMMULATIVE Btu</u>
Pre-EVA Operations	39	1100	715	715
LMP Egress	6	1200	120	835
LMP Environmental Famil.	8	1000	133	968
TV Deployment	10	1000	183	1151
SWC Deploy	5	1200	100	1251
LM Inspection	10	1000	167	1418
ALSEP Off Load	10	1200	200	1618
RTG Fueling	6	1200	120	1738
ALSEP Traverse Preparation	5	1200	100	1838
ALSEP Traverse	10	1200	200	2038
ALSEP Site Survey	5	1200	100	2138
ALSEP System Interconnect	10	1200	200	2338
PSE Deploy	8	1200	160	2498
LSM Deploy	10	1200	200	2698
SIDE Deploy	10	1200	200	2898
ALSEP Site Photo	4	900	60	2958
Return Traverse	6	1200	120	3078
TV Reposition	3	1000	50	3128
Selected Sample Collection	6	1400	140	3268
Core Tube Sample	9	1100	165	3433
EVA Termination	8	1200	160	3593
Post-EVA Operations	<u>22</u>	1100	403	3996

210 minutes

Mean = 1142

Accumulative Metabolic Predictions (BTU)

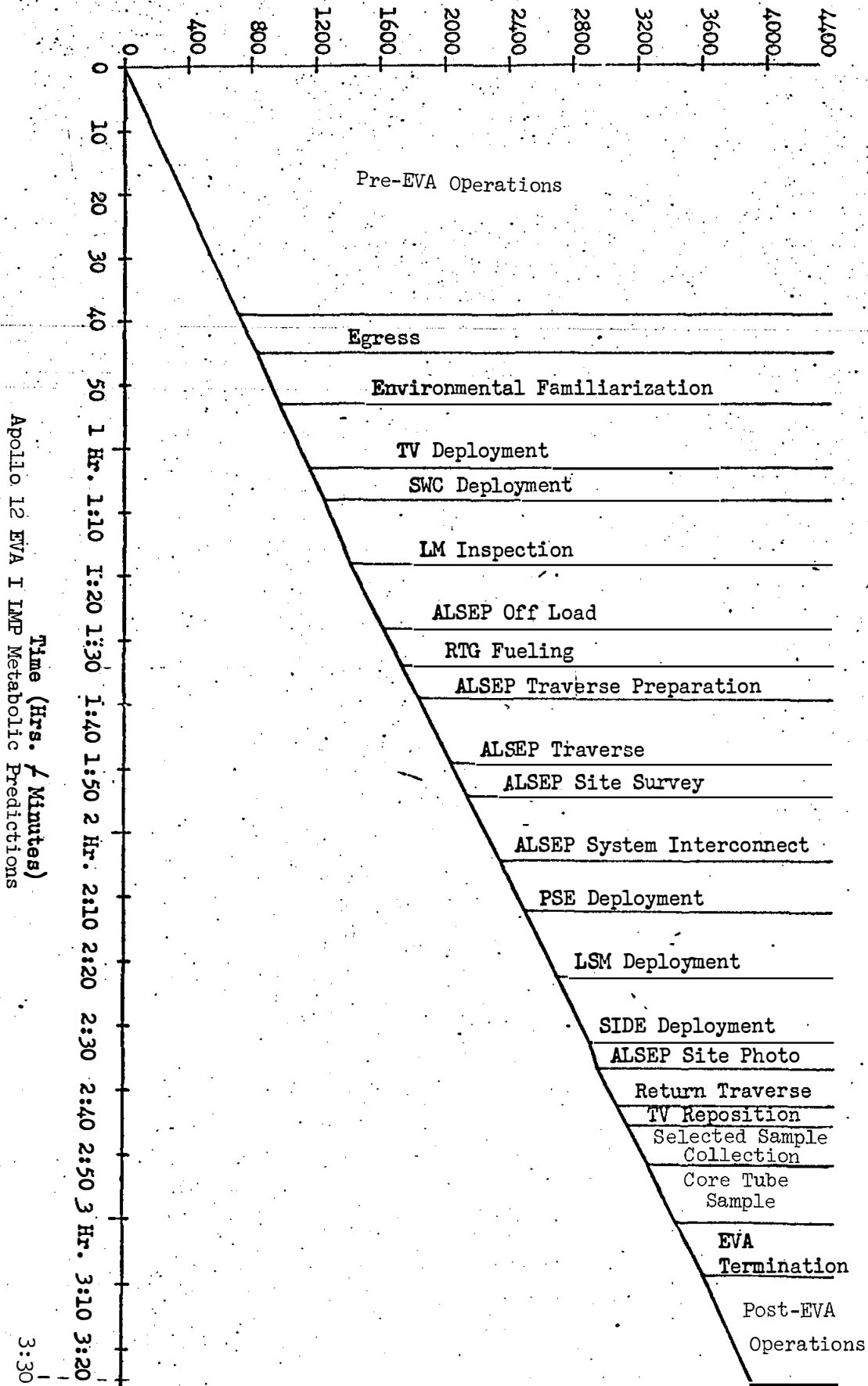

Apollo 12 EVA I IMP Metabolic Predictions

Time (Hrs. / Minutes)

#### 5.4.3 EVA 2

The metabolic output of the CDR is predicted to be 4235 BTU with a mean rate of 1210 BTU/Hour for the three hour and thirty minute EVA.

The LMP is expected to produce 3970 BTU with a mean rate of 1134 BTU/Hour for the same time period.

APOLLO 12 EVA II CDR METABOLIC PREDICTIONS

<u>ACTIVITY</u>	<u>TIME(Mins.)</u>	<u>PREDICTED RATE (Btu/Hr.)</u>	<u>TOTAL</u>	<u>CUMULATIVE TOTAL</u>
Pre-EVA Operations	10	800	133	133
Egress	5	1300	108	241
Prepare for Traverse	15	1000	250	491
Geological Traverse	90	1200	1800	2291
Surveyor Site Activities	25	1200	500	2791
Complete Geological Traverse	17	1200	340	3131
Prepare & Transfer Equipment	38	1400	887	4018
Ingress	10	1300	217	4235
	<u>210</u>		<u>4235</u>	

Mean = 1210

APOLLO 12 EVA II CDR  
METABOLIC PREDICTIONS

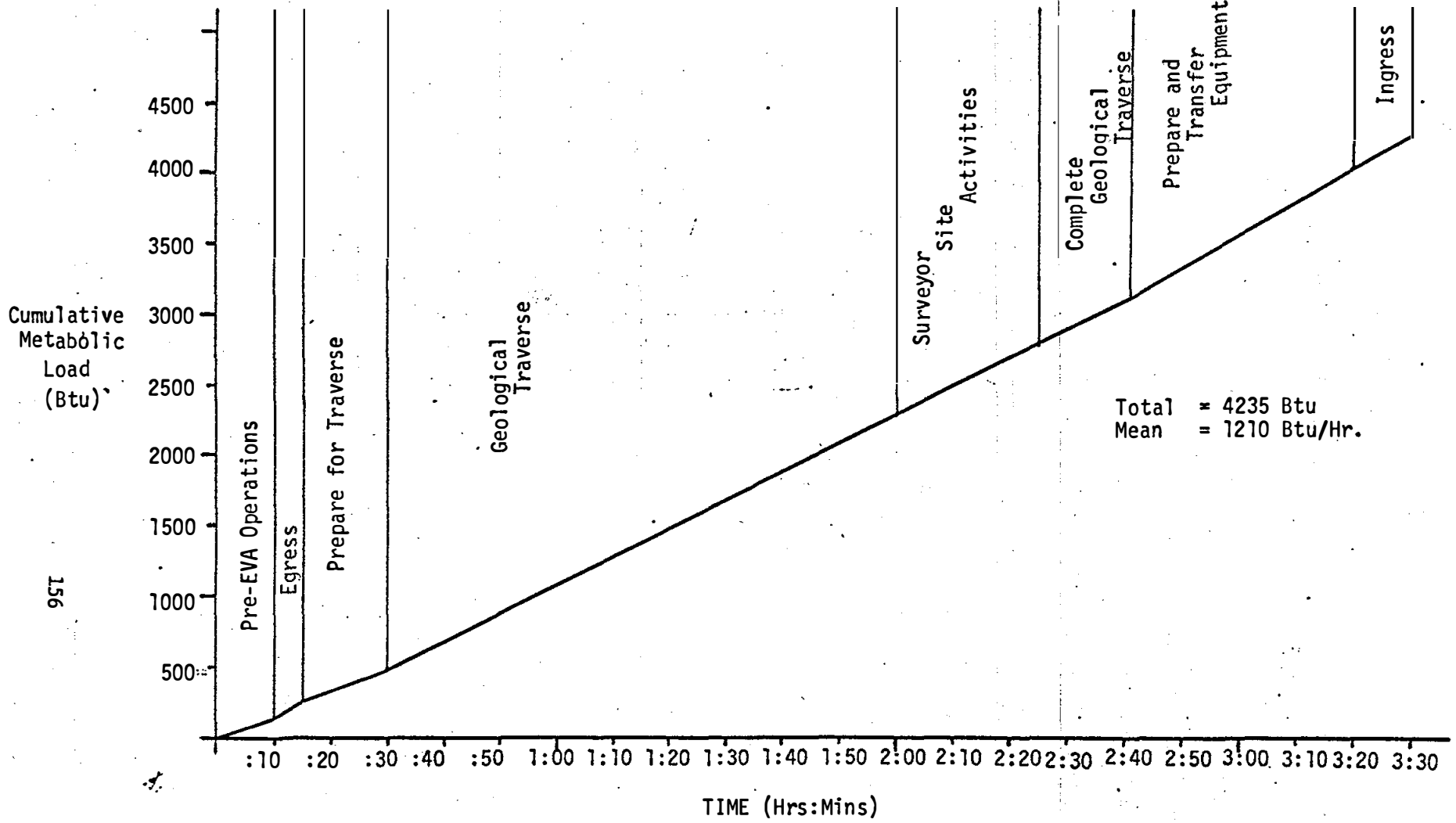

APOLLO 12 EVA II LMP METABOLIC  
PREDICTIONS

<u>ACTIVITY</u>	<u>TIME (Minutes)</u>	<u>PREDICTED RATE (Btu/Hr.)</u>	<u>TOTAL (Btu)</u>	<u>CUMULATIVE (Btu)</u>
Pre-EVA Operations	18	800	240	240
Egress	3	1300	65	305
Prepare for Traverse	9	1000	150	455
Geological Traverse	90	1200	1800	2255
Surveyor Site Activities	25	1200	500	2755
Complete Geological Traverse	17	1200	340	3095
Equipment Stowage and Photography	11	1000	183	3278
Ingress	4	1300	87	3365
Assist CDR	33	1100	605	3970
	210		3970	

Mean = 1134 Btu/Hr.



APOLLO 12 EVA II LMP  
METABOLIC PREDICTIONS

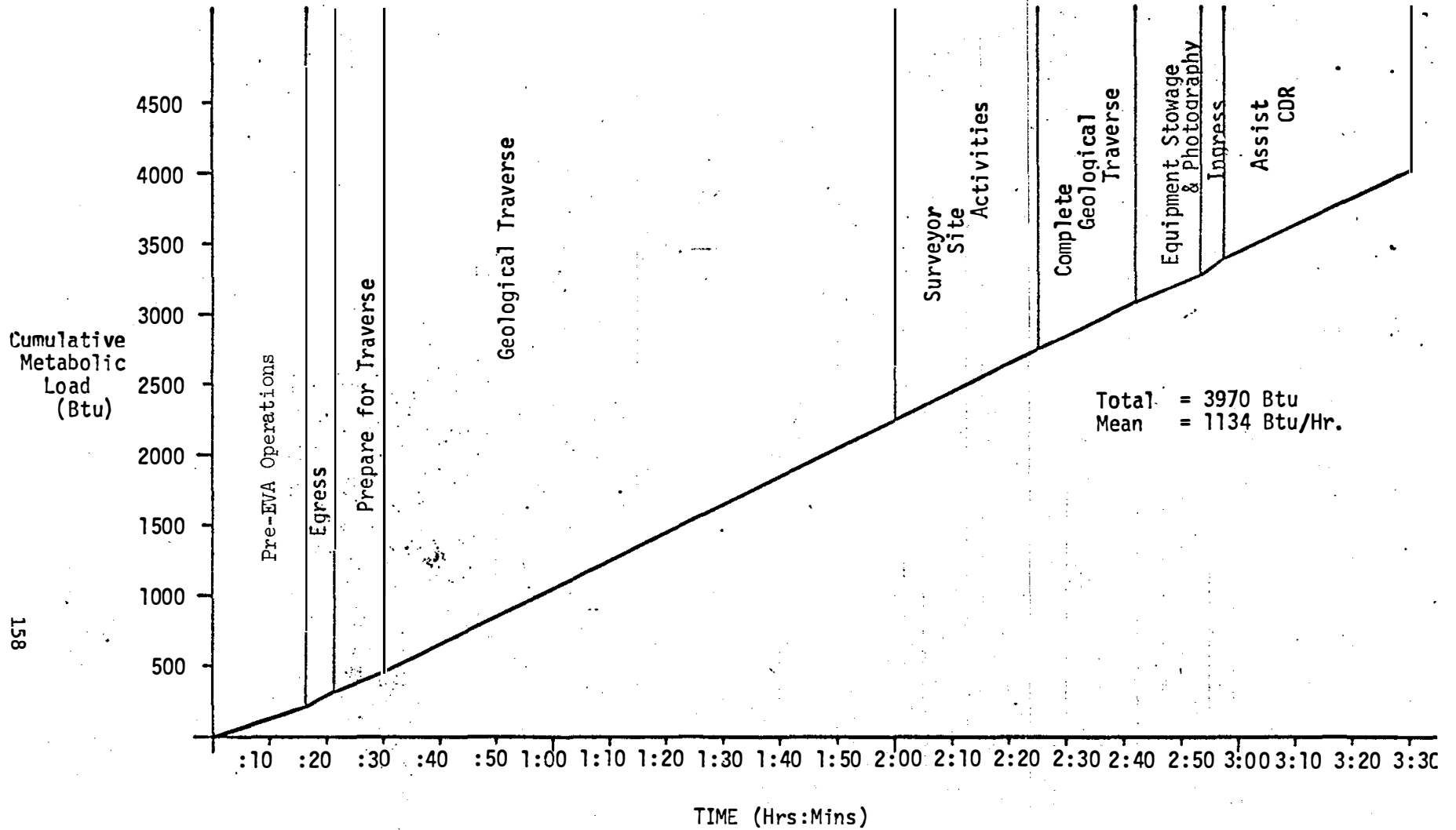

## 5.5 REFERENCES

- (1) Lunar Surface Project Office; Apollo Lunar Surface Experiments Mission Requirements Plan - ALSEP/LGC Array A Mission - September, 1969.
- (2) Systems Engineering Division, ASPO; Mission Requirements SA-507/CSM-108/LM-6 H-1 Type Mission, Lunar Landing, July 18, 1969 (Revision A, October 1, 1969).
- (3) Lunar Surface Project Office; Flight System Familiarization Manual; The Bendix Corporation Aerospace Systems Division, August 1, 1967 (Revised April 15, 1969).
- (4) Boeing Life Sciences and Technology Division; Apollo 12 EVA I Metabolic Predictions, Ltr. 6.1.4-1-2-72-127, August 12, 1969.
- (5) Boeing Life Sciences and Technology Division; Apollo 12 EVA II Metabolic Predictions, Ltr. 6.1.4-1-2972-135, October 6, 1969.
- (6) Flight Crew Support Division - EVA Branch; Lunar Surface Checklist; Baseline Edition, October 7, 1969.
- (7) Flight Planning Branch-FCSD; Final Flight Plan Apollo 12; AS-507/CSM-108/LM-6, October 15, 1969.
- (8) Mission Operations Branch-FCSD; Photographic and TV Procedures Plan, Apollo 12, October 20, 1969.