

# MATCHING NiP ON Be-38Al FOR LOW TEMP MIRRORS



**PEREGRINE**

PRECISION ENGINEERED  
PRODUCTS SINCE 1994

**SBIR DATA RIGHTS:** Contract No. NNX14CM30P, Contractor Name: The Peregrine Falcon Corporation; Contractor Address: 1051 Serpentine Lane, Suite 100, Pleasanton, CA 94566. Expiration of SBIR Data Rights Period: *June 12, 2019*. The Government's rights to use, modify, reproduce, release, perform, display, or disclose technical data or computer software marked with this legend are restricted during the period shown as provided in paragraph (b) (4) of the Rights in Noncommercial Technical Data and computer Software—Small Business Innovative Research (SBIR) Program clause shown above. Any reproduction of technical data, computer software, or portions thereof marked with this legend must also reproduce the markings.

**Resulting in an athermal method to fabricate low cost, low risk and high quality, large lightweight aperture primary mirrors and assemblies within a manageable timeframe.**



This method to provide low cost, low risk and high quality, lightweight aperture primary mirrors and assemblies relies upon converging three elements...

1. Be-38Al (Lightweight & Stiff Substrate)
2. Electroless Nickel (An Amorphous Surface)
3. Single Point Diamond Turning (Optical Surface)

(Be-38Al & NiP have similar CTE's. Adjusting the phosphorous content of the electroless nickel batch can match the nickel plating to the Be-38Al substrate down to cryogenic temperatures).

# Be-38Al

(Highly Characterized Material – Initial Use 1964)

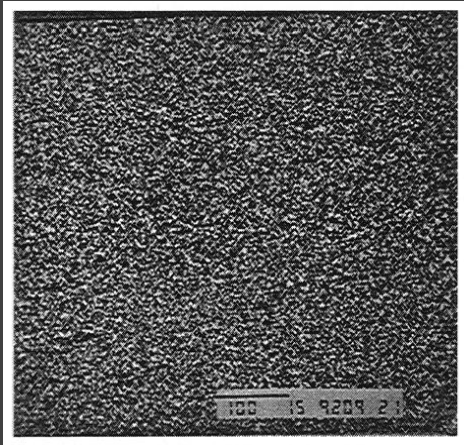

- Low cost substitute for beryllium. (Density 1.85 gm/cc Be; 2.1 gm/cc Be-38Al)
- Be-38Al is a powdered metallurgy material. Each particle of spherical powder is 62% beryllium / 38% aluminum.

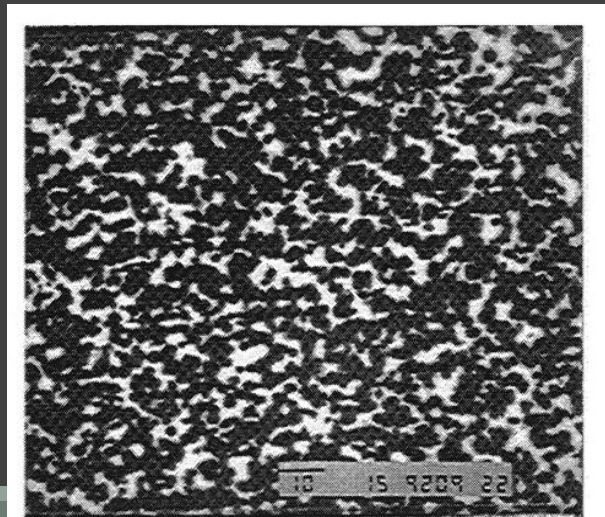

Beryllium is a brittle material, like other optical materials, which requires heavier wall thicknesses than what designs dictate.

Be-38Al has improved toughness allowing thinner wall sections to be fabricated, resulting in a substrate weight similar to beryllium.



# Electroless Nickel

(A Highly Characterized Process – Developed in 1942)

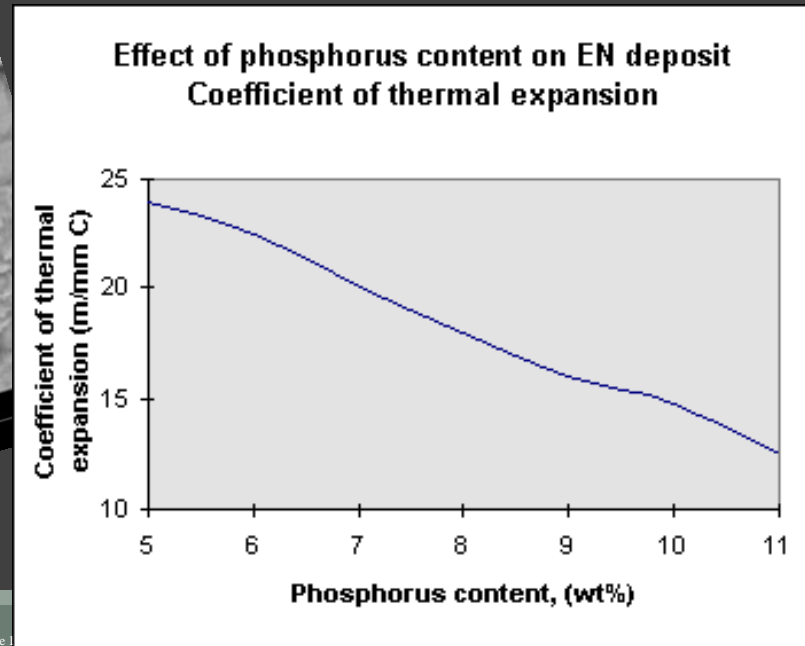
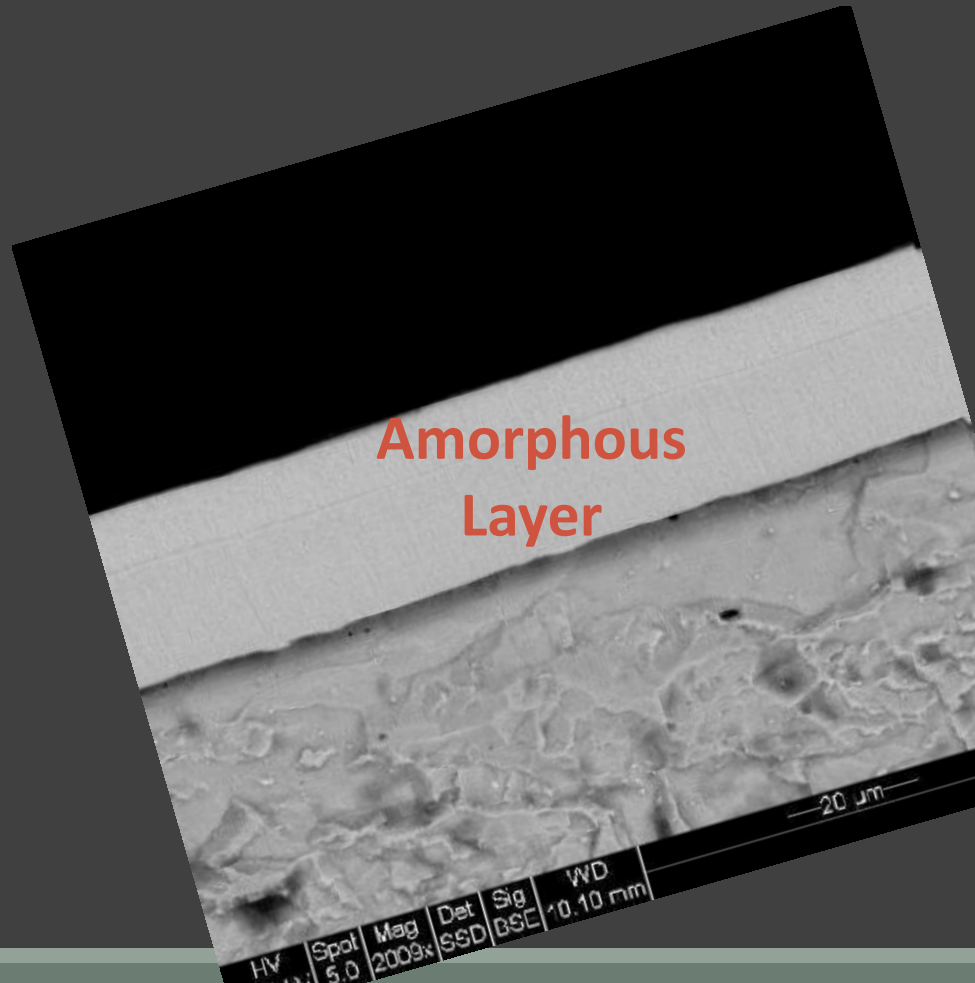

- An autocatalytic process that uniformly deposits and replicates the receiving surface.
- It is amorphous layer, leading to the term “metal glass.”
- Highly machinable.

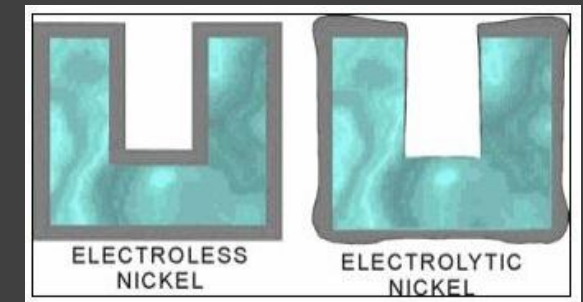

# Single Point Diamond Turning (A Maturing Turning Process)

- Surface Figure < 10 nm
- Surface Roughness < 5 nm
- A manageable process, single point diamond turning, after setup, will take days on very large surfaces to produce. This is compared to years for conventional grinding and polishing.
- No roll off on edges of the mirror provides full use of the optical surface potentially yielding zero straight light.
- Initial single point contact needs more support than the continuous cut, allowing for the substrate to be so designed.

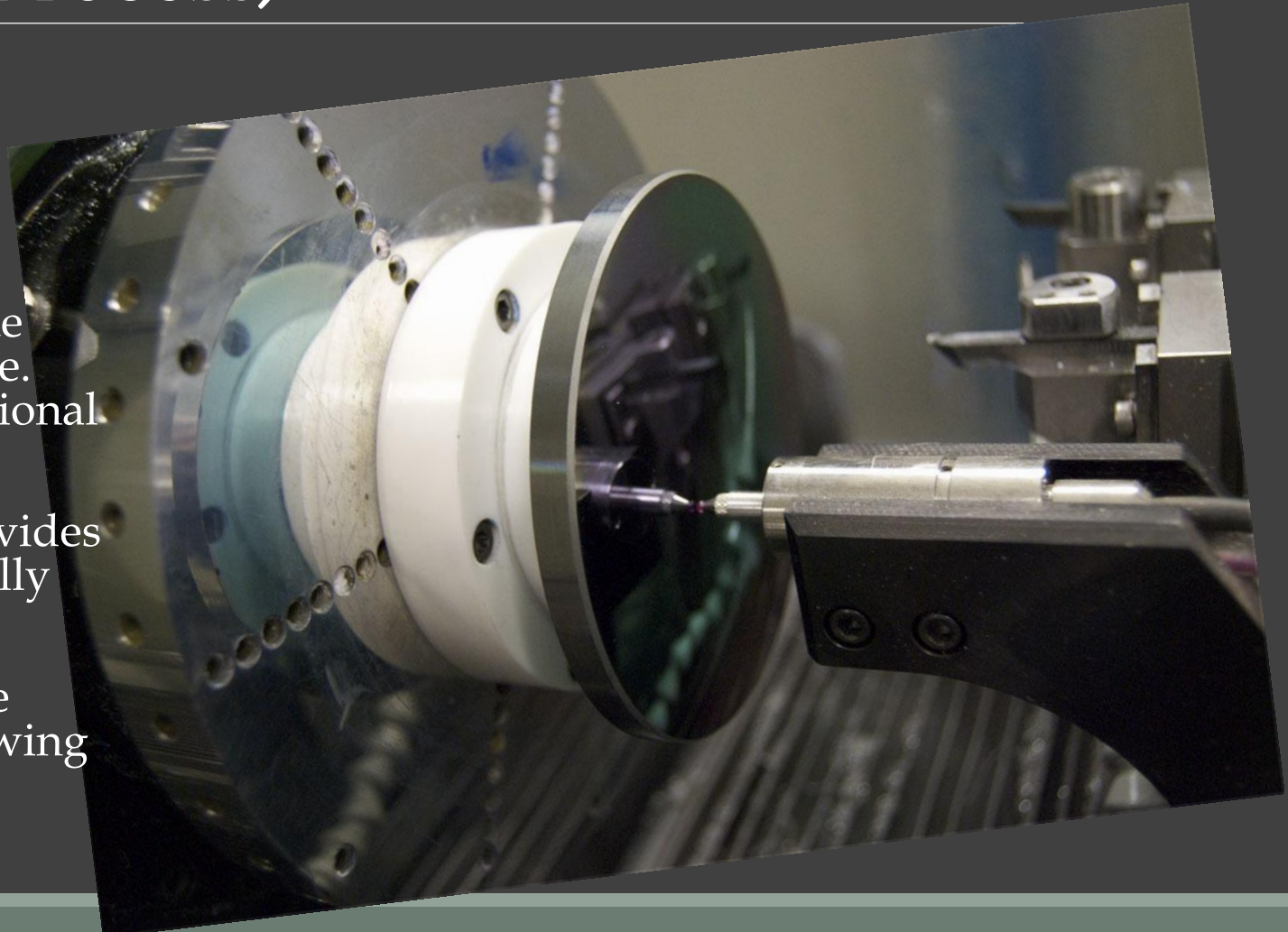



# Current Status of this Phase I SBIR

---

- **Eight [8] substrates, 110 mm diameter, have been designed and machined, stress relieved and thermally stabilized.**
- **NiP plating completed; range of approximately 7 – 11% phosphorous.**
- **Single point diamond turning, beginning.**
- **NASA to test figure at room temperature and then cryogenic temperature.**



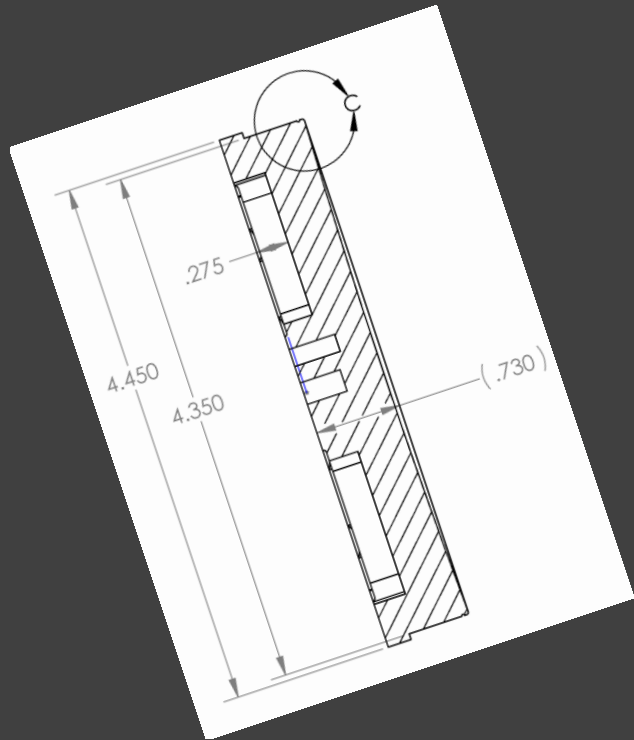

# SUBSTRATES

**SBIR DATA RIGHTS:** Contract No. NNX14CM30P, Contractor Name: The Peregrine Falcon Corporation; Contractor Address: 1051 Serpentine Lane, Suite 100, Pleasanton, CA 94566, Expiration of SBIR Data Rights Period: June 12, 2019. The Government's rights to use, modify, reproduce, release, perform, display, or disclose technical data or computer software marked with this legend are restricted during the period shown as provided in paragraph (b) (4) of the Rights in Noncommercial Technical Data and computer Software—Small Business Innovative Research (SBIR) Program clause shown above. Any reproduction of technical data, computer software, or portions thereof marked with this legend must also reproduce the markings.

# The Ideal Candidate System will Provide...

(Be-38Al/NiP/SPDT can Provide these Requirements)

- Opto-Thermal-Mechanical Stability (High Precision Elastic Limit)
- Thick High Stiffness Mirror Substrates (Large Section Modulus)
- An Athermal Primary Mirror Assembly (Be-38Al)
- Optical Surfaces to the Edge of the Substrates (Single Point Diamond Turning)





# James Webb Space Telescope

- Beryllium
- \$6.5 Million/m<sup>2</sup>
- Quantity of 18
- Designing to an EELV telescope mass budget using JWST as a guideline:

- Total JWST Mass Budget = 6,500 kg
- Optical Telescope Assembly = 2,500 kg
- Primary Mirror Assembly = 7,500 kg
- Primary Mirror Substrate = 750 kg (JWST was ~90% Lightweighted)

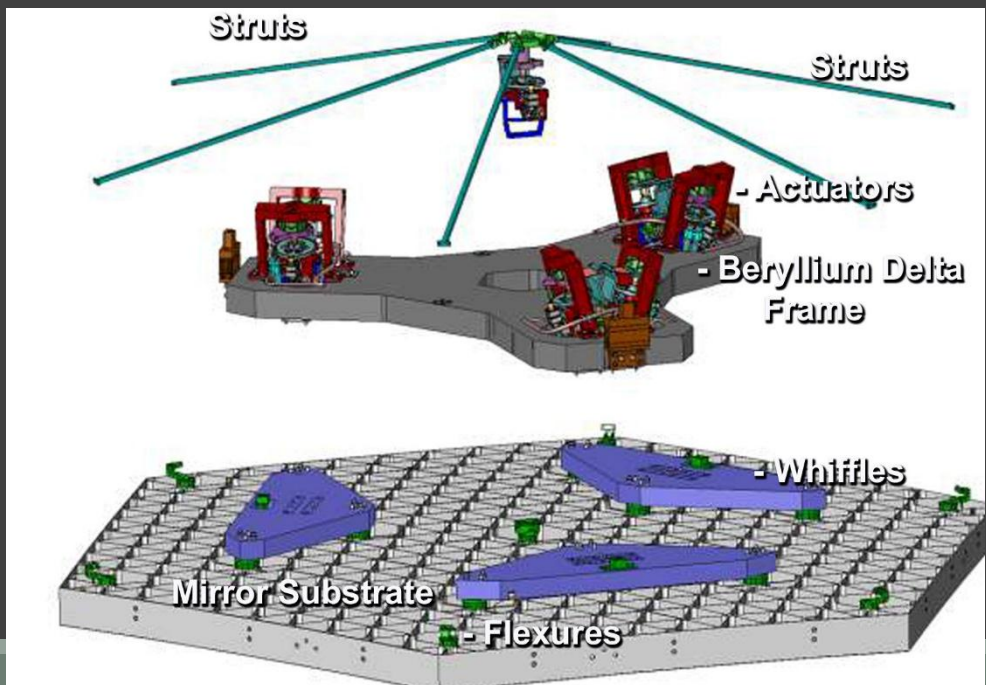
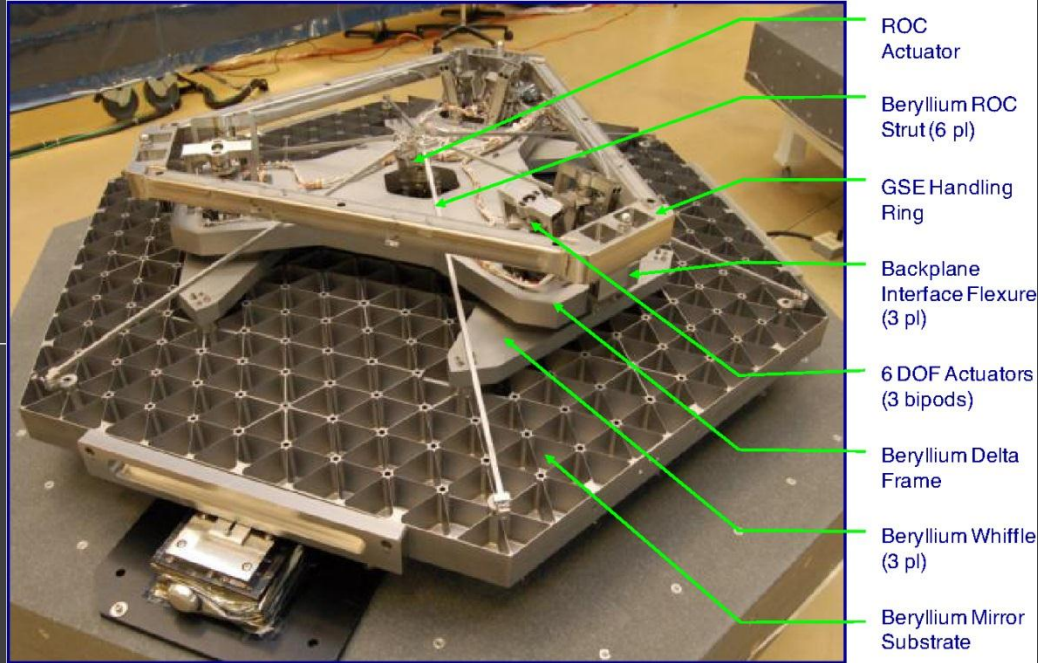

# Primary Mirror Goals

Parameter	JWST Spec *	Ideal PM Goal (EELN)
Wavefront Sensing & Control Error Residual Error	40 nm rms	10 nm rms
Surface Fatigue Error	25 nm rms	6 nm rms
Wavefront Error due to Structural Stability	60 nm rms	15 nm rms
Aspect Ratio	~ 20 to 1	< 10 to 1
AREAL Density	30 kg/m <sup>2</sup>	70 kg/m <sup>2</sup> / 30 kg/m <sup>2</sup>
Substrate Size	~ 1.3 m Hex	Over 4 m & Desired Over 8 m
Substrate Thickness	~ 6.5 cm	~ 40 cm / 80 cm

\* JWST used for comparison purposes.



# Large Aperture Mirrors Ideally Require:

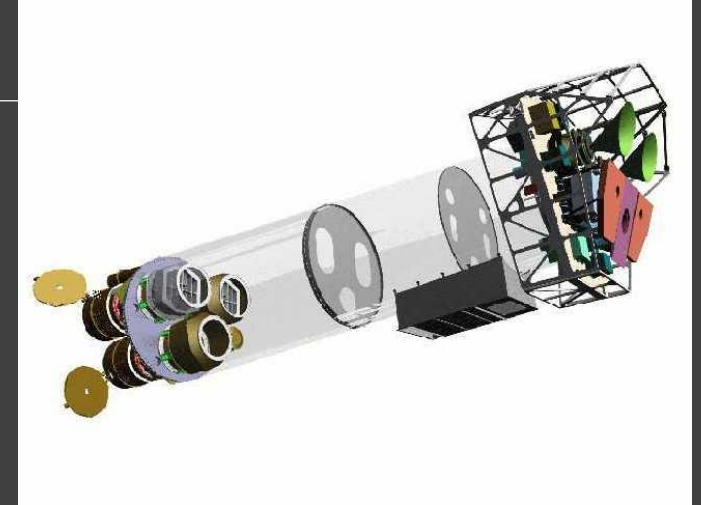
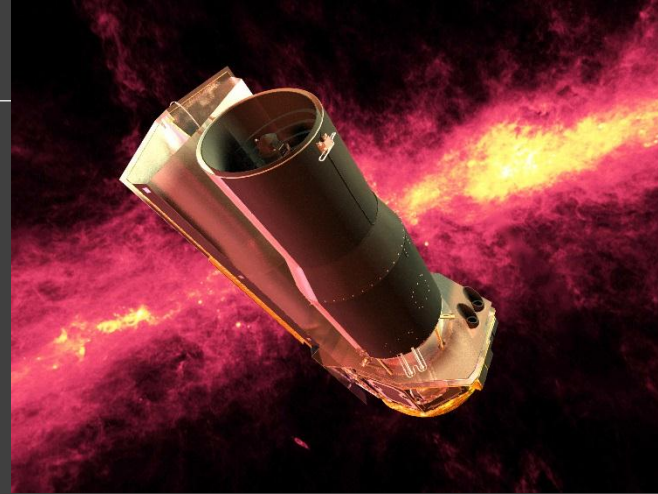
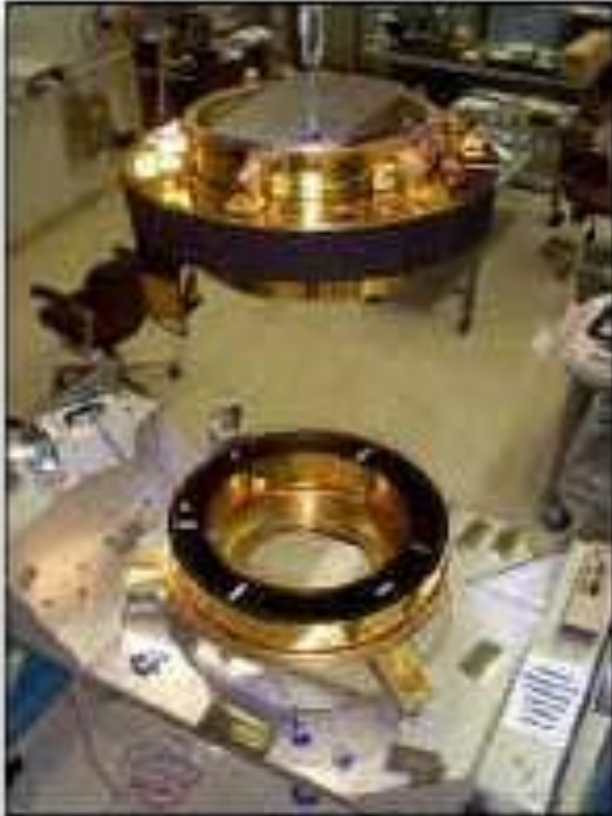

- Depth; to create a large section modulus/stiffer/stable substrate.
- Manageable fabrication and polishing cycles to allow for recovery. (The performance of the primary mirror drives the whole program).
- High precision elastic modulus material to survive launch loads.
- Athermal design capability to minimize alignment/integration times.

# Material Comparison Table

Material	Thermal Conductivity W/mK	Young's Modulus GPa	Density gm/cc	Specific Modulus	Hardness Knoop (kg/mm <sup>2</sup> )	PEL MPa
Zerodur	1.46	90.3	2.53	35.7	620	NA
Silicon Carbide (CVD)	152	311	2.95	105.4	2400	NA
Beryllium	216	303	1.85	163.8	(E) 490	30
ULE	1.3	68	2.21	30.8	460	NA
Be-38Al	210	192	2.10	91.4	NA	17.3



# Current Existing Size Limitations for Be-38Al/NiP/SPDT

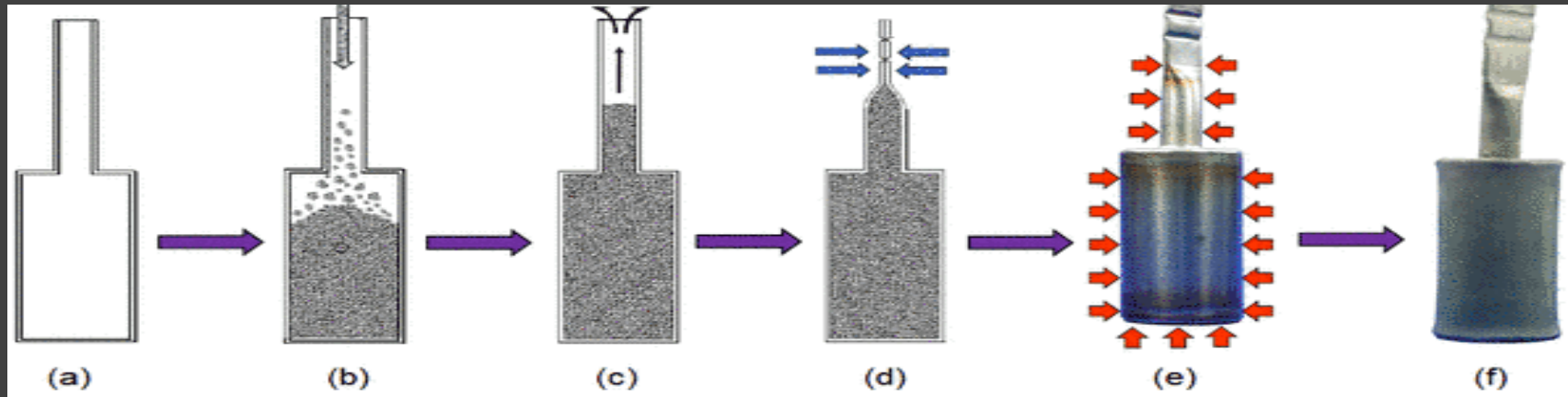

- Hot Isostatic Pressing Machine – 60” diameter x 120” (material can be welded/LID/brazed/bonded/assembled).
- NiP Plating – No Limits (plating limited only by tank size).
- Single Point Diamond Turning – 1.5 m (goal would be to SPDT final surface)

# Comparison - Low Cost (1 m<sup>2</sup> JWST Basis, Estimated Costs)

Costs	Past (Beryllium)	Our Approach (Be-38Al)
Substrate	\$1.25 m	\$0.5 m
Processing	2.25 m	0.5 m
Grinding/Polishing (NiP for Be-38Al & SPDT)	2.75 m	0.5 m
Optical Coating	0.25 m	0.10 m
<b>Total</b>	<b>\$6.5 m</b>	<b>\$1.6 m</b>

Over a 4x  
Difference



# Recovery

---

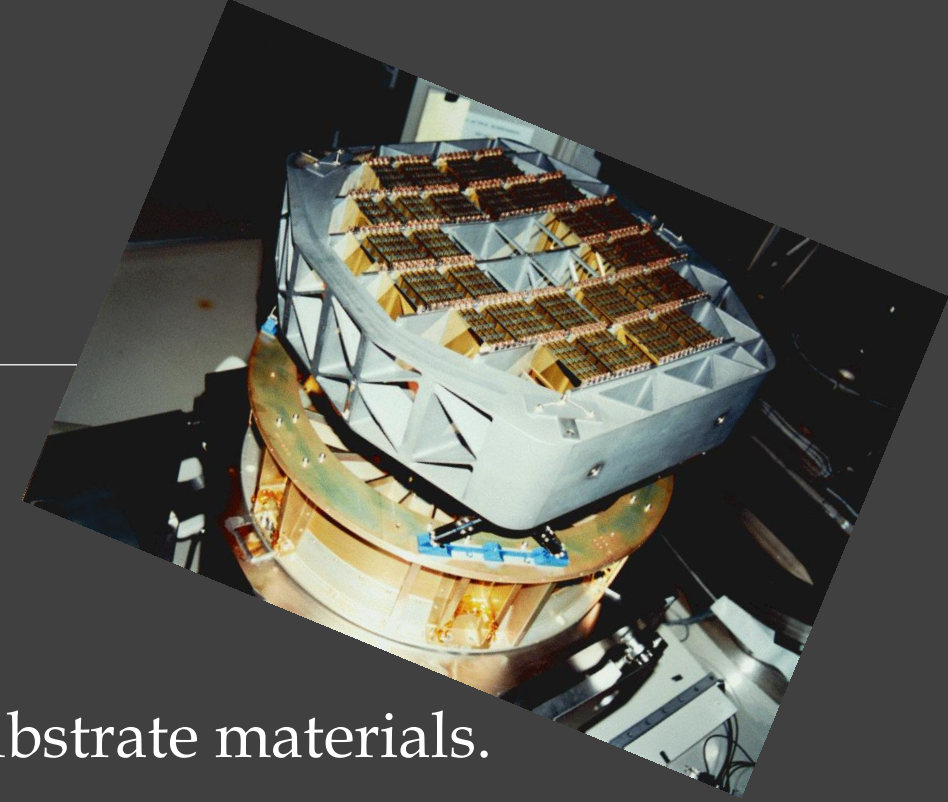

- Be-38Al is not brittle like Be and other optical substrate materials.
- Be-38Al (Tough); repaired by welding/brazing/epoxy bonding/other.
- NiP plating can be removed and re-plated.

# Phase II: Define the NiP Formula

---

Initial screening to verify our direction forward (110 mm monolithic coupons).

Large test matrix to zero in on exact phosphorous percentage (110 mm monolithic coupons).

Re-verify / retest to verify percentage on representative coupons (Establish Statistically Significant Basis).



Design, Fab and test representative (scaled 8 m) optic 0.5 m or larger. Two mirrors one monolithic; the other from two pieces to demonstrate joining methodology and performance against the monolithic mirror.



# Phase II: Zero in on Phosphorous Percentage via 110 mm Monolithic Coupons

Effect of phosphorus content on EN deposit  
Coefficient of thermal expansion

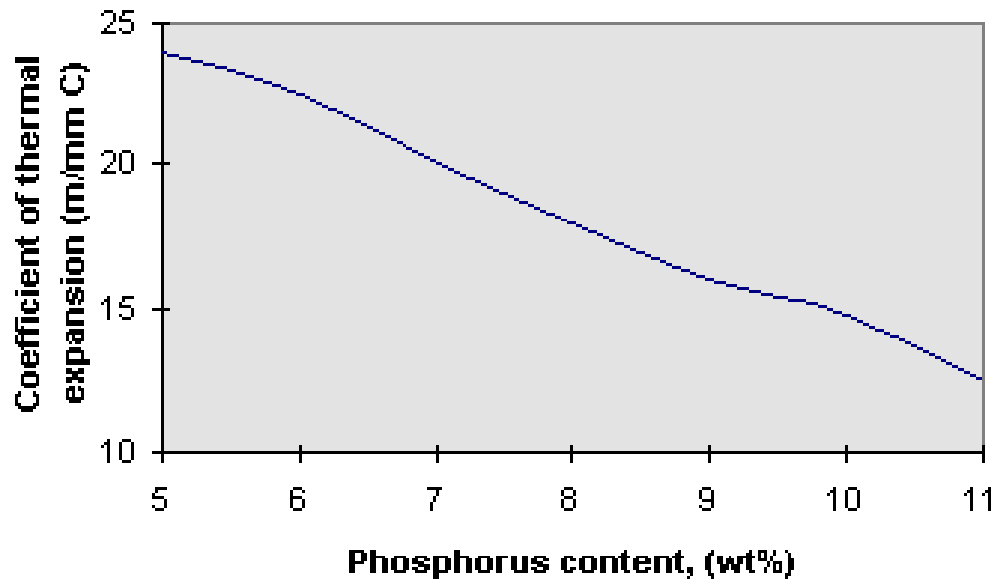

We need a statistically significant number of coupons to evaluate the phosphorous content.



# Make and Test 0.5m Optic

---

Design substrates as scaled models of an 8 m primary mirror, one as a monolithic design a second as a two piece design LID bonded together (Based upon Patent 6,779,713 B1).

Using defined phosphorous content, plate substrates, SPDT, and then test at room temperature and at cryogenic.

Retest the two optics at room temperature and cryogenic to capture test to test variations.

After cryogenic testing, mechanical test the substrates to verify deformation under potential launch loads. Retest surface figure at room temperature and cryogenic and verify differences.





# Liquid Interface Diffusion Bonding

---

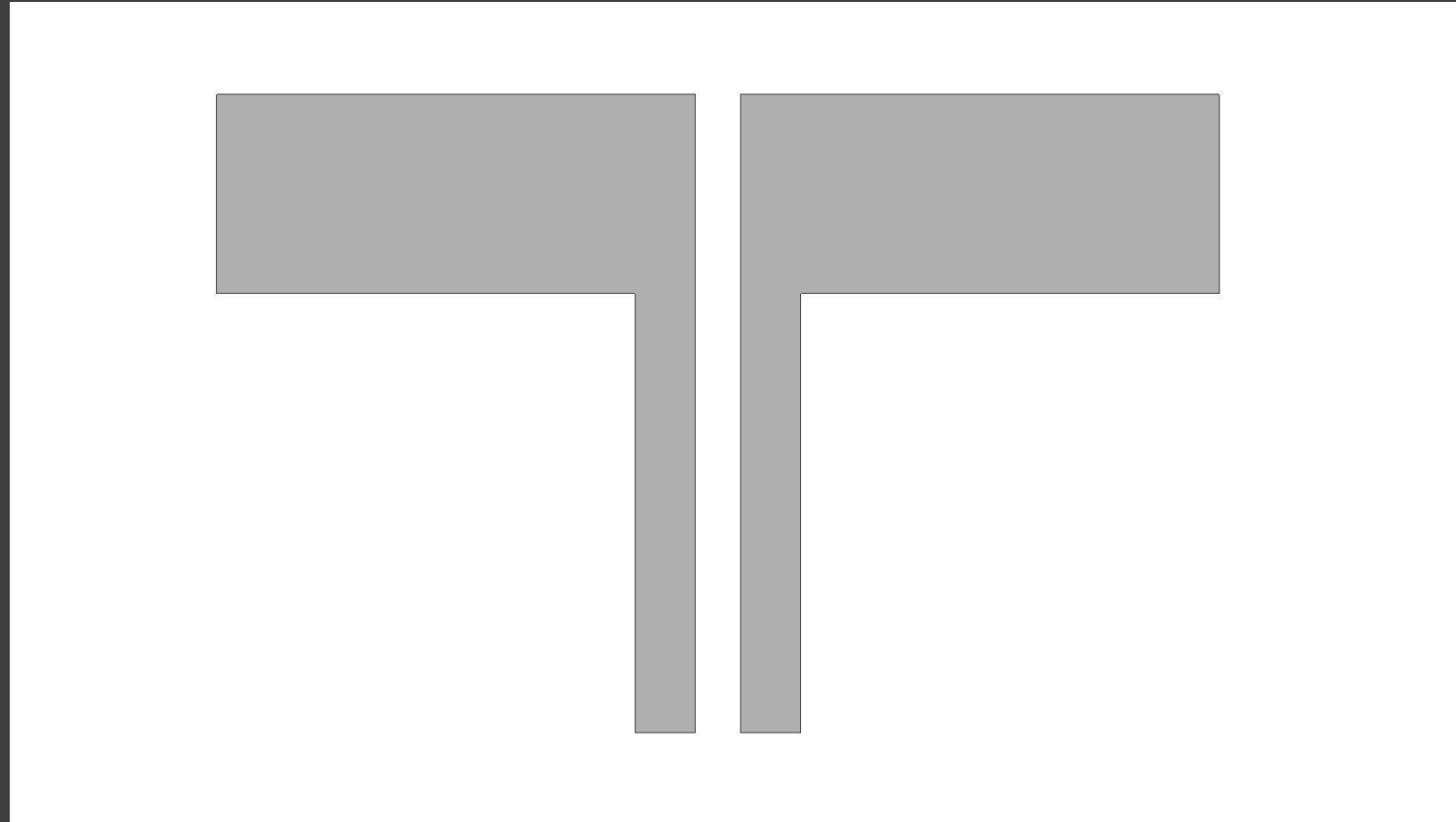

# Liquid Interface Diffusion Bonding

---

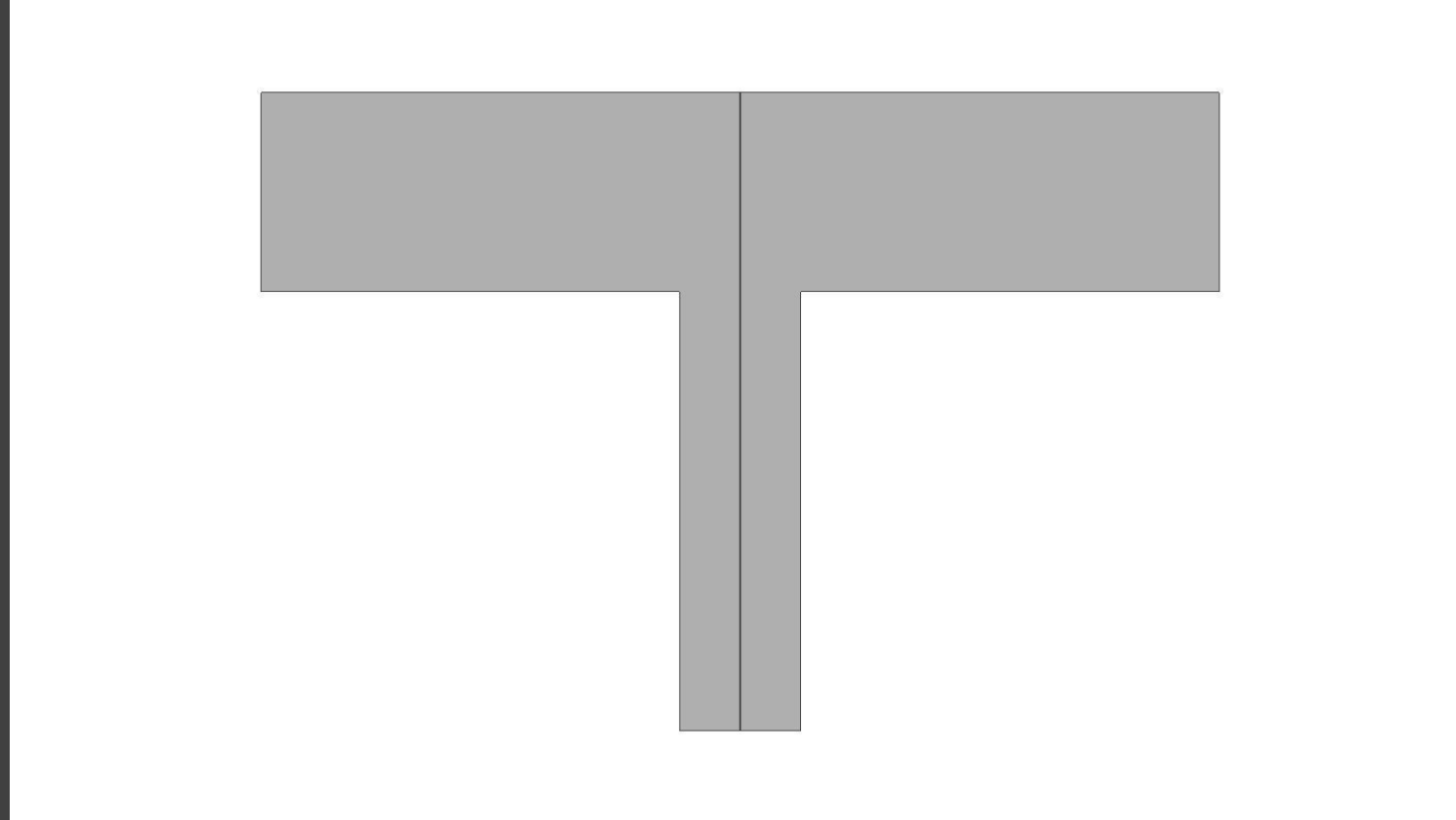



# Liquid Interface Diffusion Bonding

---

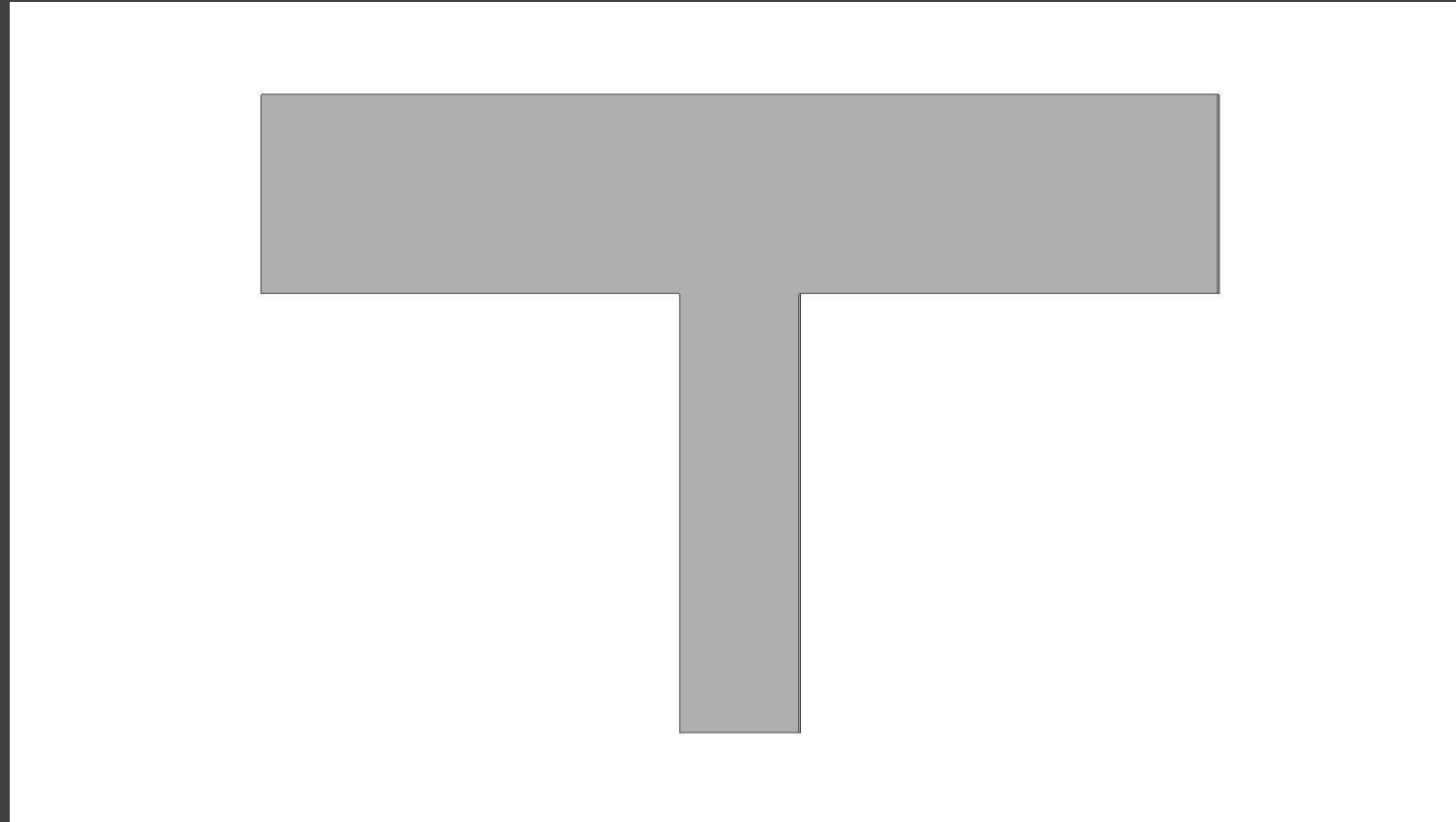

# LID Bonding then Machining

---

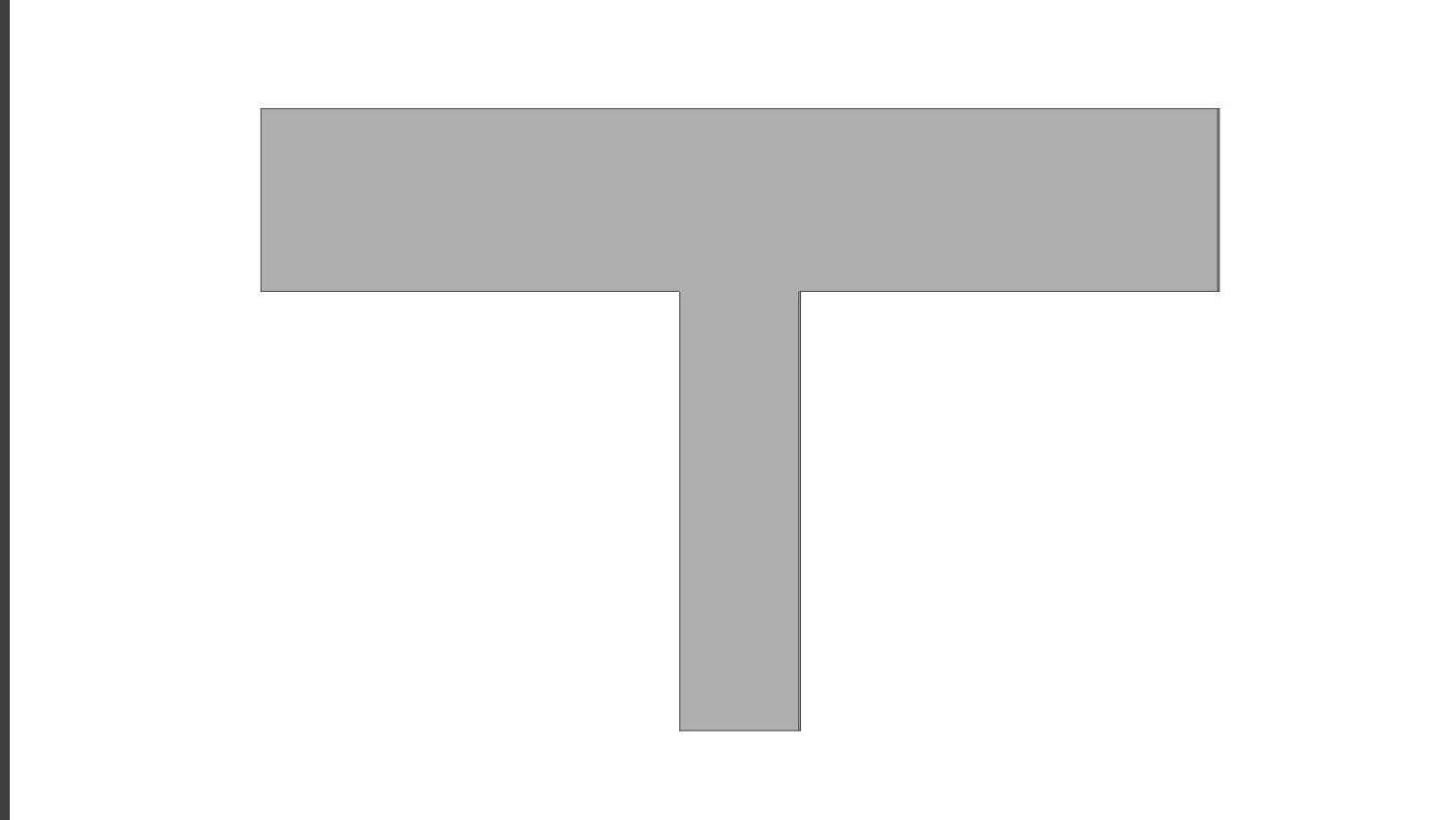

# NiP then Plated

---

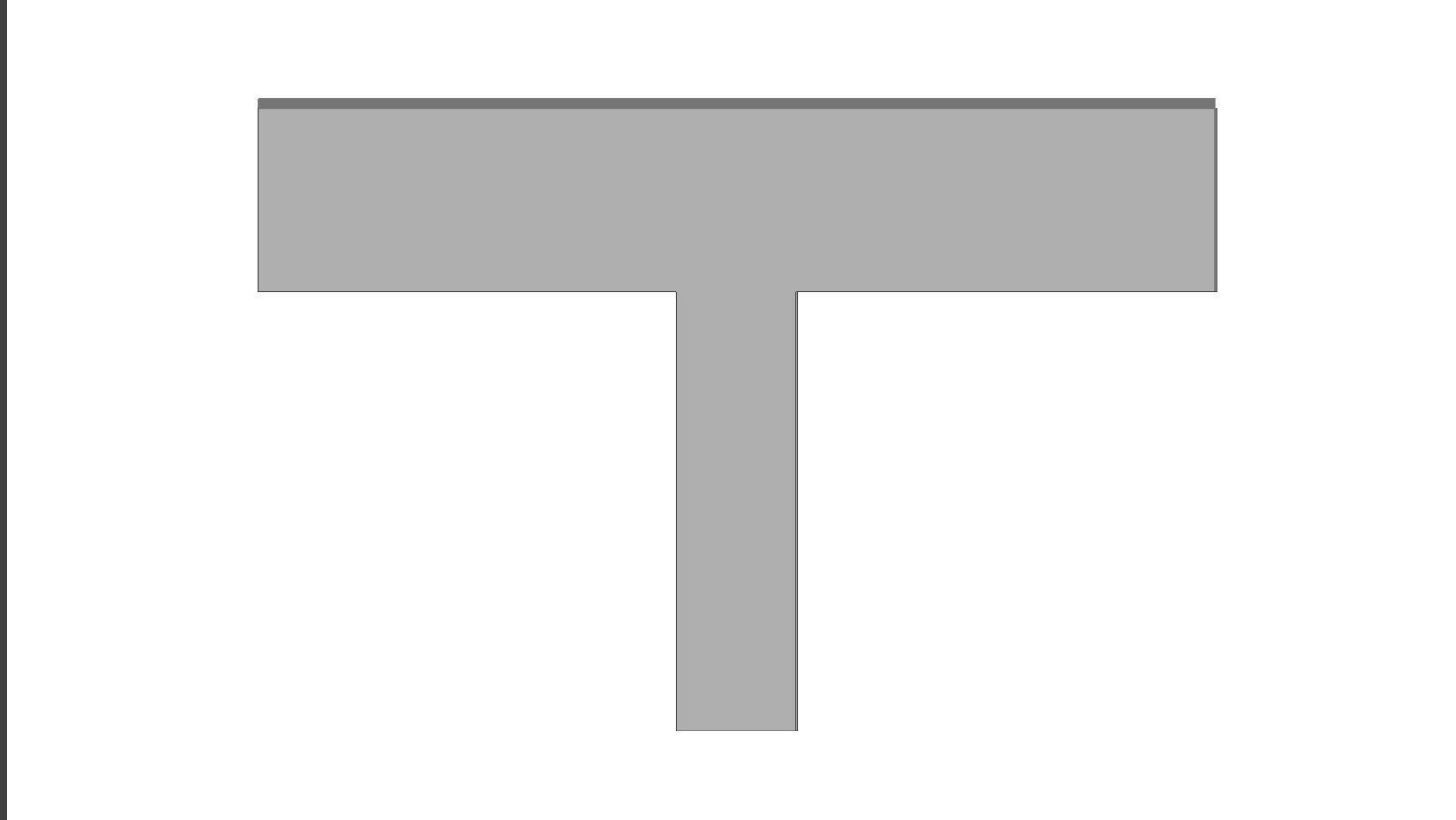



# Single Point Diamond Turning

---

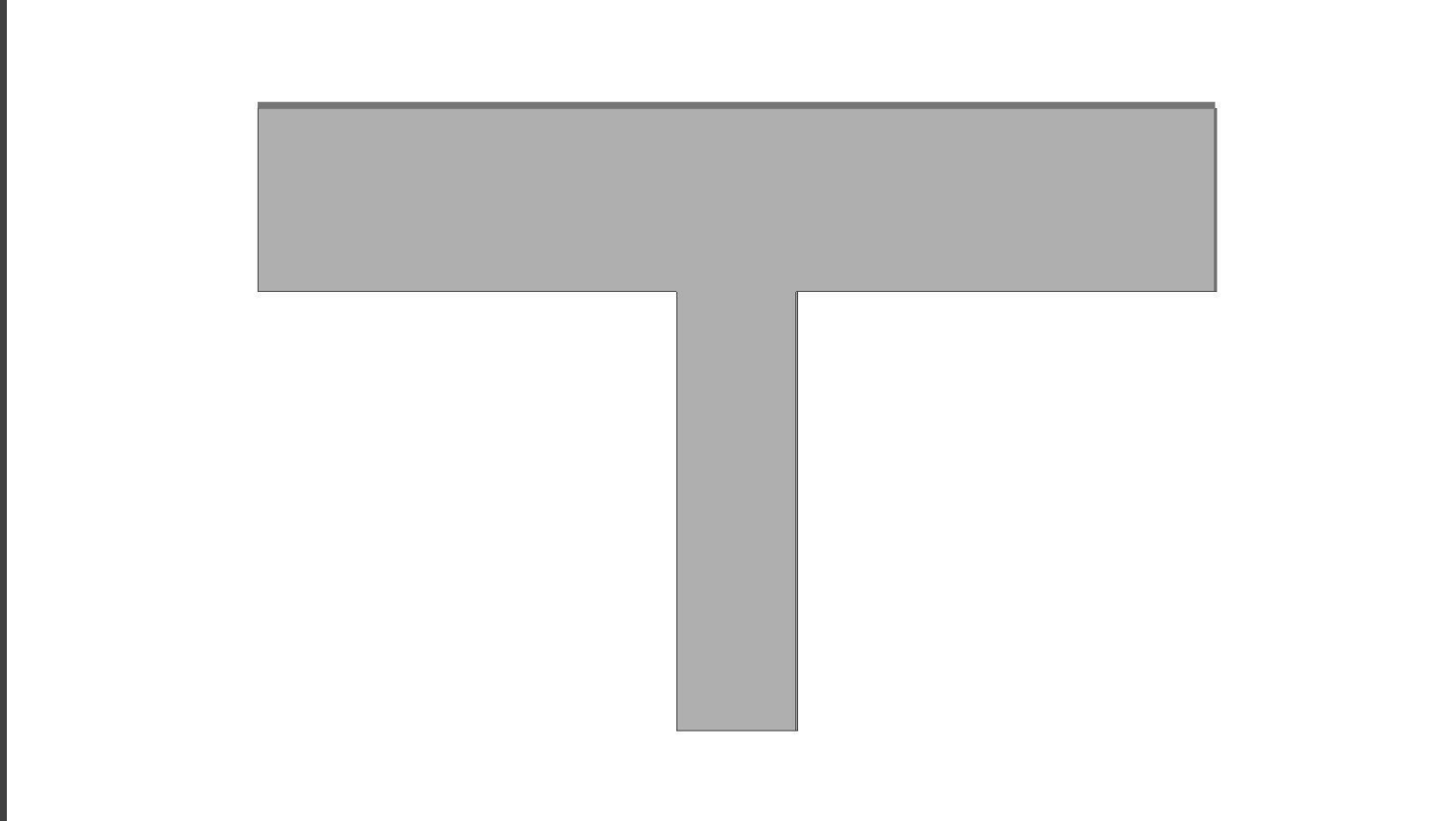

# 8 meter Substrate LID Bonded

---

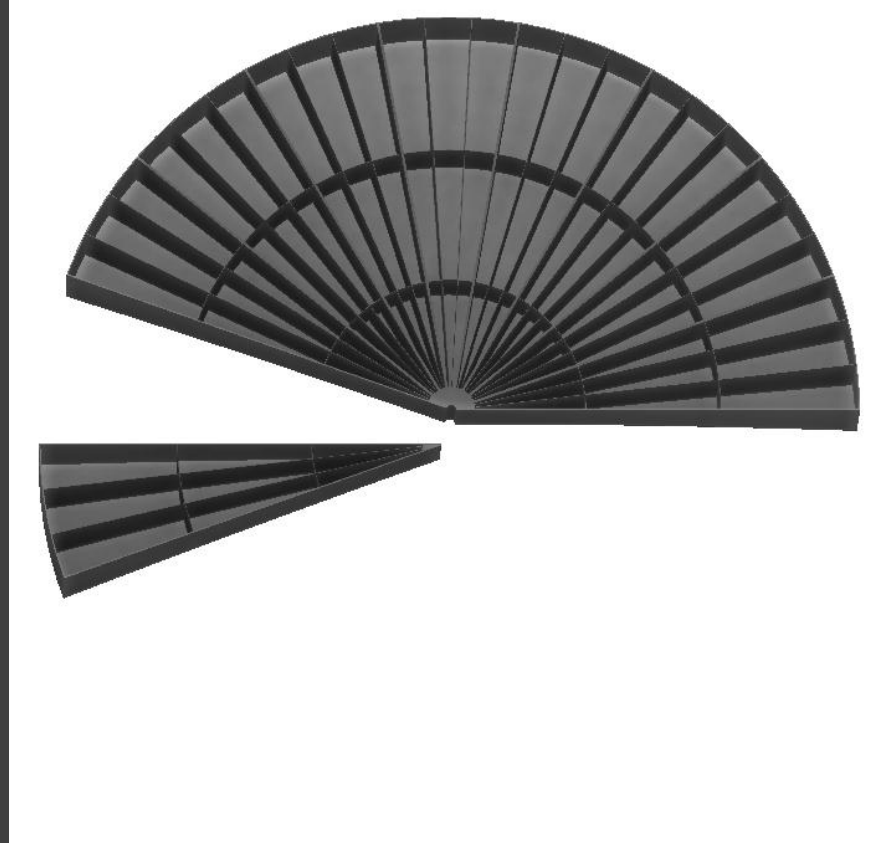

# 8 meter Substrate LID Bonded

---

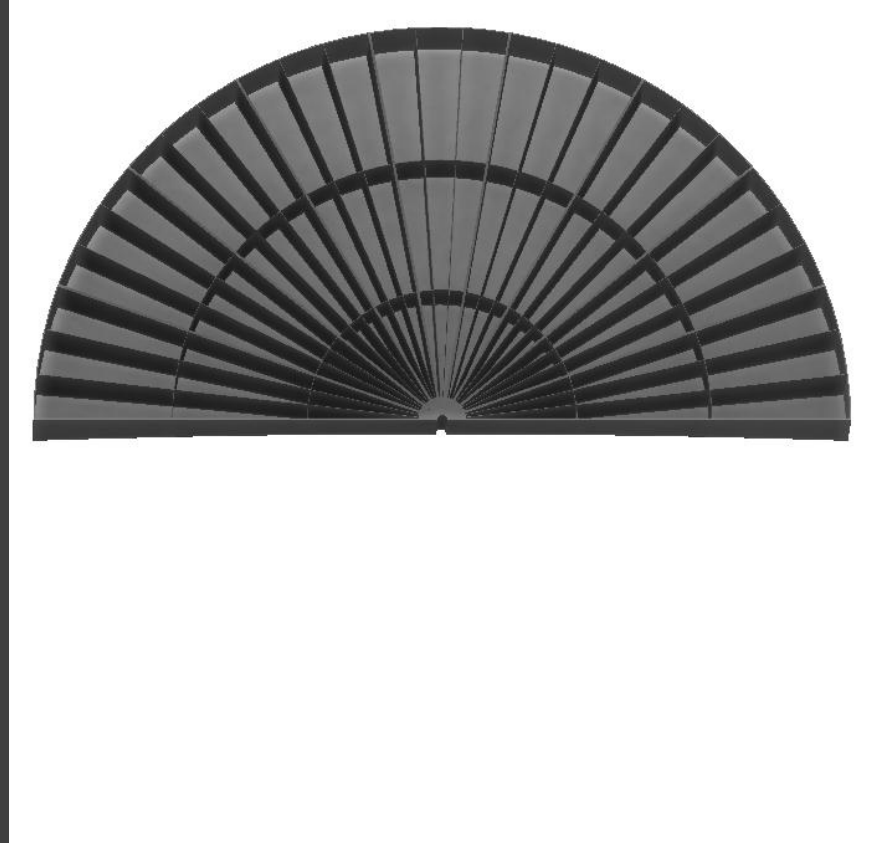



# 8 meter Substrate LID Bonded

---

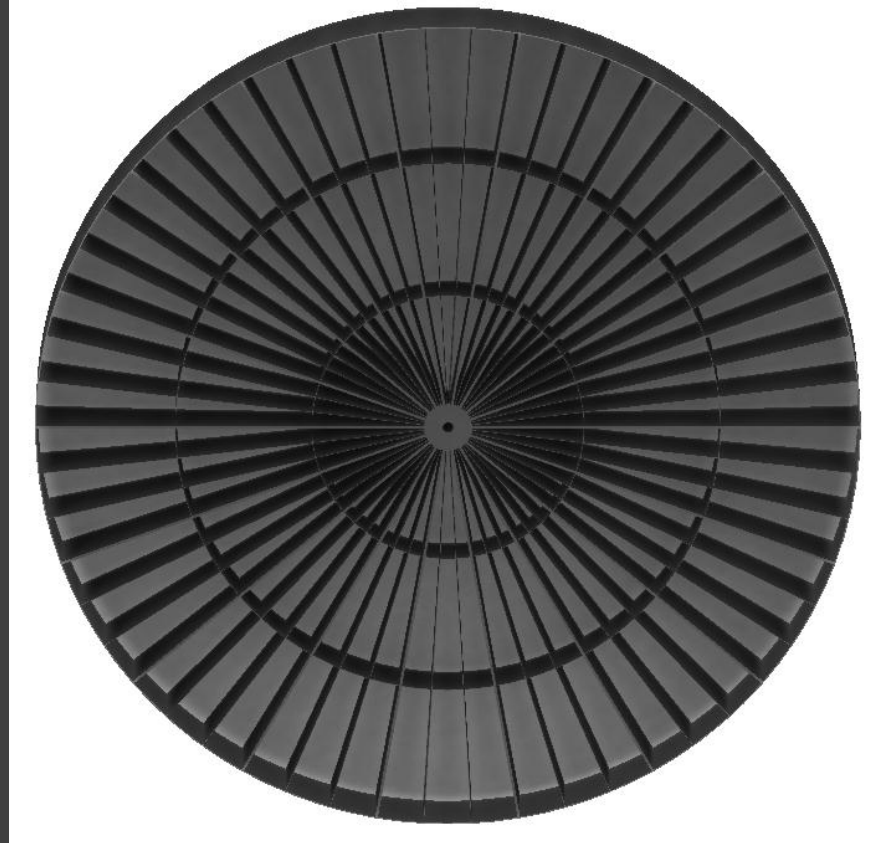

# 8 meter Substrate LID Bonded

---

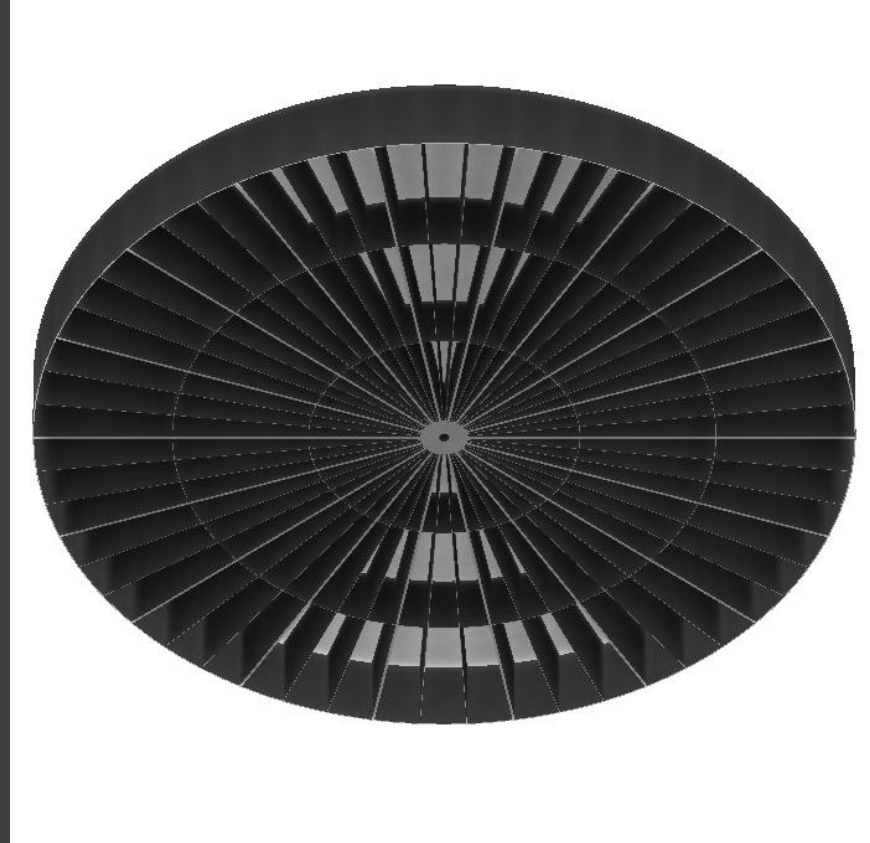

# 8 meter Substrate Finish Machined

---

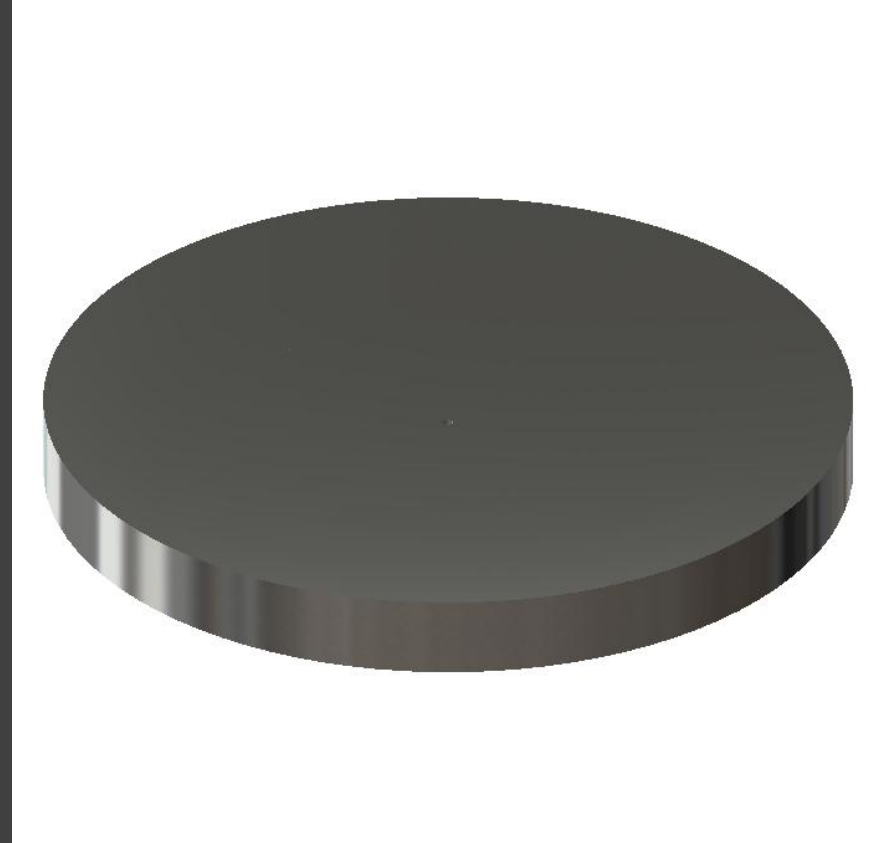



# 8 meter Substrate Ready to NiP Plate

---

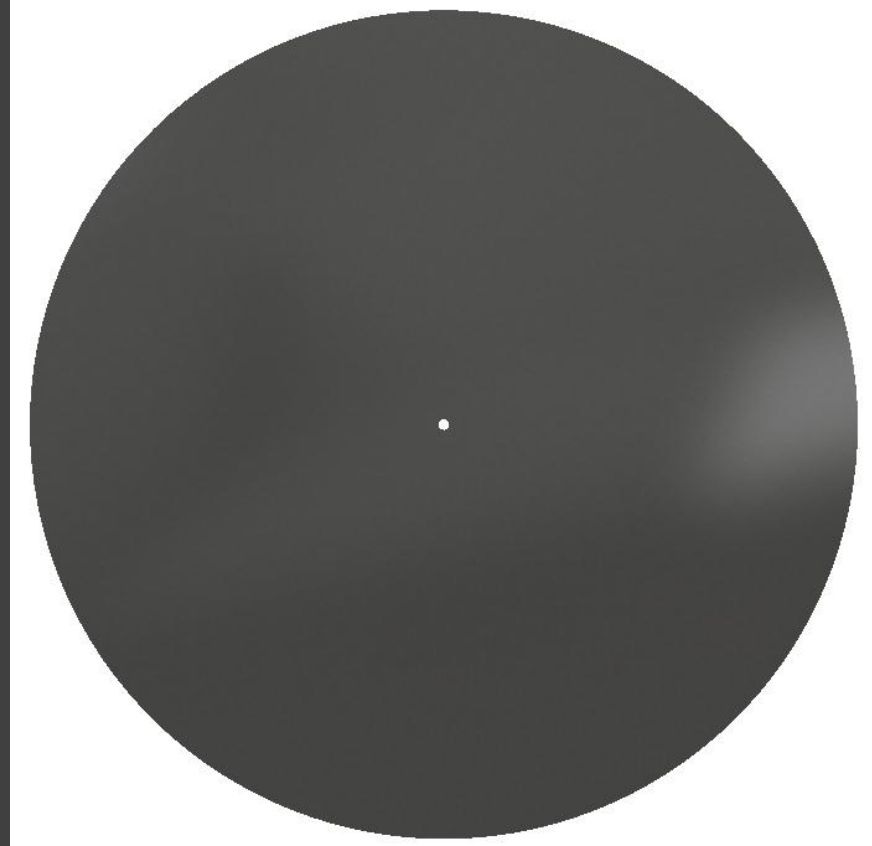

# 8 meter Substrate / NiP / SPDT / Then Coated

---

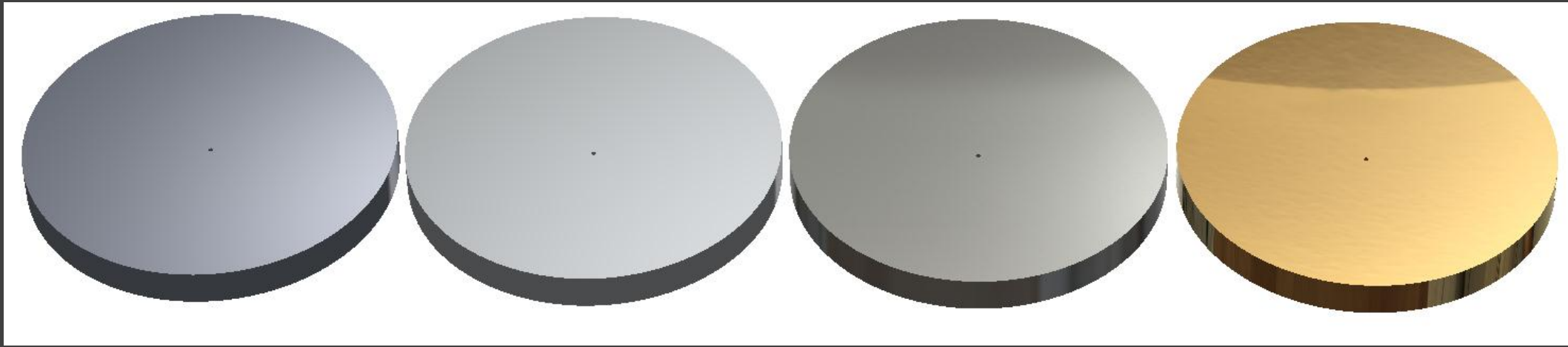



Phases I and II Leads to...

Phase III: Engineering  
Integration and Testing of a  
Representative Mirror



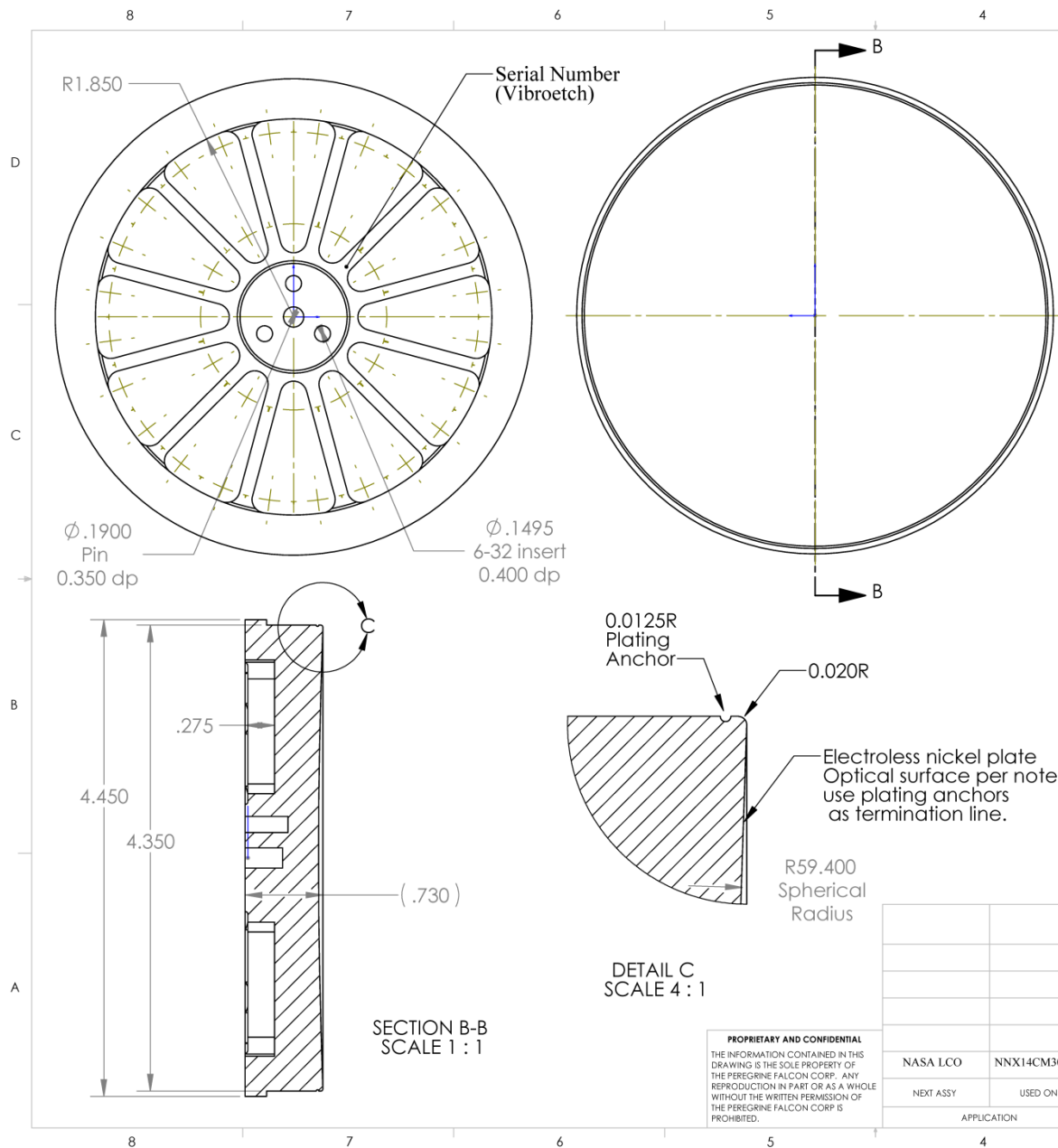

SN 01 thru 08 NiP plated with 7% to 11% Phosphorous containing Electroless Nickel.

**PROPRIETARY AND CONFIDENTIAL**  
 THE INFORMATION CONTAINED IN THIS DRAWING IS THE SOLE PROPERTY OF THE PEREGRINE FALCON CORP. ANY REPRODUCTION IN PART OR AS A WHOLE WITHOUT THE WRITTEN PERMISSION OF THE PEREGRINE FALCON CORP IS PROHIBITED.

UNLESS OTHERWISE SPECIFIED:		NAME	DATE
DIMENSIONS ARE IN INCHES		DRAWN	R. Hardesty
TOLERANCES:		CHECKED	
FRACTIONAL: 1/64		ENG APPR.	
ANGULAR: MACH ± 0.5		MFG APPR.	
TWO PLACE DECIMAL +/- .010"		Q.A.	
THREE PLACE DECIMAL +/- .005"		COMMENTS:	
INTERPRET GEOMETRIC TOLERANCING PER: ASME Y14.100		Caution: Al-Be AMS7911 is a Beryllium Containing Material. See MSDS M13	
MATERIAL	Al-Be AMS7911		
FINISH	60 RMS		
DO NOT SCALE DRAWING			
NASA LCO	NNX14CM30P		
NEXT ASSY	USED ON		
APPLICATION			

<b>The Peregrine Falcon Corporation</b> 1051 Serpentine Lane, Ste 100 Pleasanton, CA 94566		
TITLE:		
<b>Substrate 4.35 Dia.          Elect Ni CTE Test</b>		
SIZE	DWG. NO.	REV
<b>B</b>	<b>Q42-450EN</b>	<b>E</b>
SCALE: 1:2	WEIGHT:	SHEET 1 OF 1

Q42-450EN Rev E for Hudson



# Be-38Al

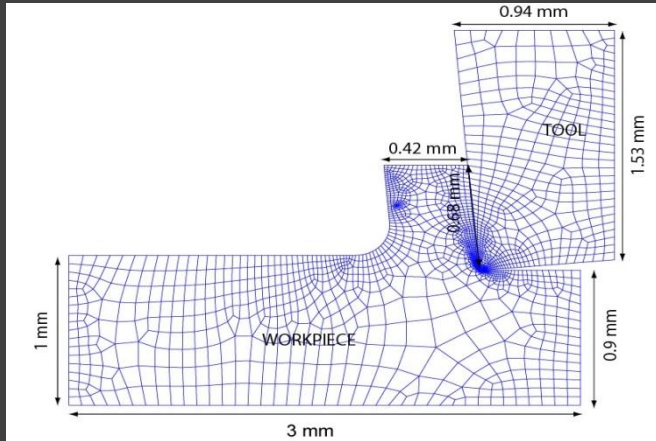

90 to 95% lightweighted Mirror

# NiP

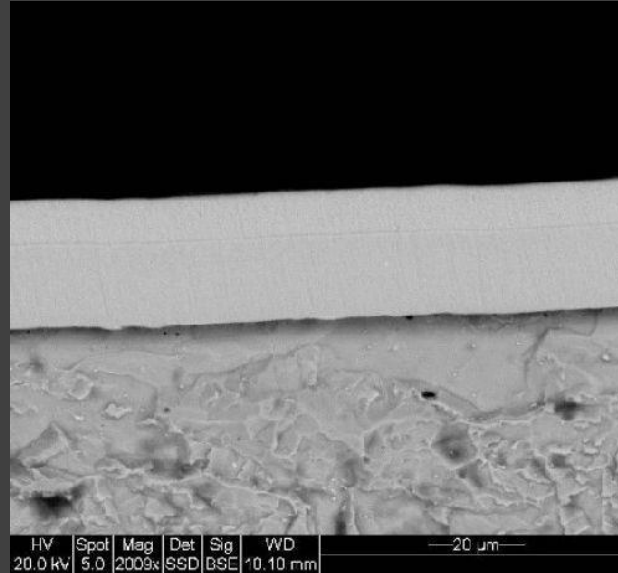

SPDT

# LID

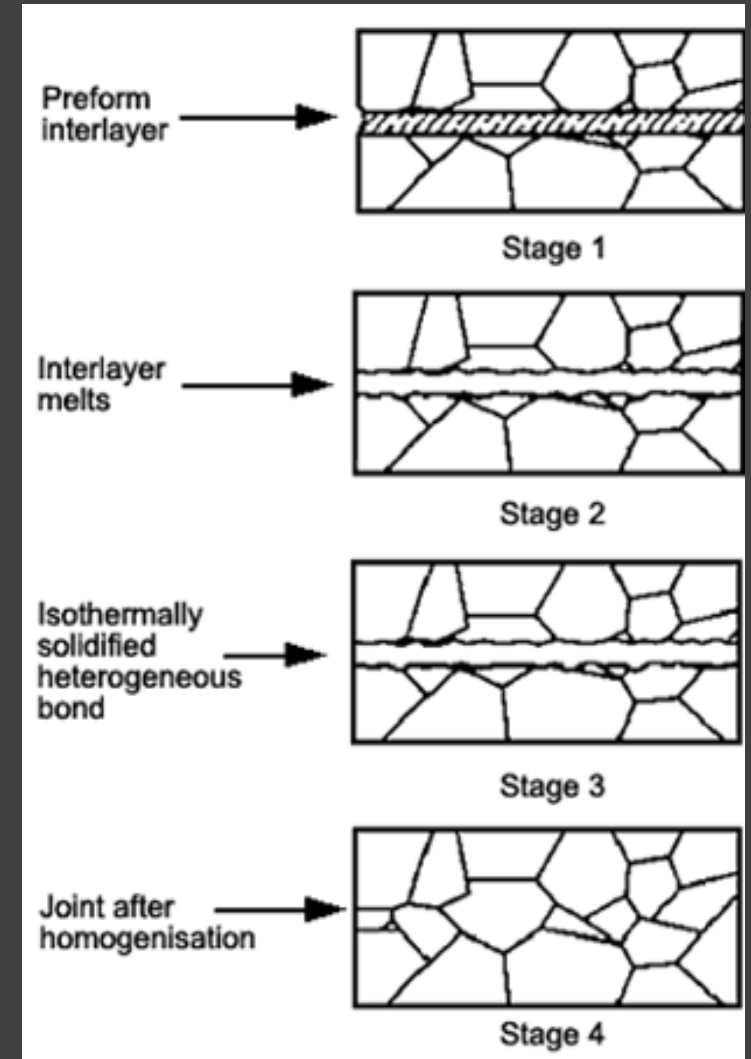

# Advantages

---

The Be-38Al/NiP/SPDT system provides the following advantages:

- Thick substrates can be produced (Aspect ratios  $< 10$  to 1; Large section modulus).
- Low density and allows for thin sections (Lightweight substrates to survive launch).
- Be-38Al has a high precision elastic limit (Yields a stable structure / HAC).
- NiP provides an amorphous optical surface (Can be SPDT).
- SPDT to the edge uses entire optical surface and eliminates stray light (Most efficient).
- Robust; it's durable and repairable (Manageable Schedule).
- Allows for the design of an athermal system (No dissimilar metal CTE issues).

The Peregrine Falcon Corporation  
1051 Serpentine Lane  
Pleasanton, California 94566

PRECISION ENGINEERED PRODUCTS  
Since 1994  
**PEREGRINE™**  
**20th ANNIVERSARY**

Kelsey Parker

[kparker@peregrinecorp.com](mailto:kparker@peregrinecorp.com)

Robert Hardesty

[rhardesty@peregrinecorp.com](mailto:rhardesty@peregrinecorp.com)

[www.peregrinecorp.com](http://www.peregrinecorp.com)



# Large Optics

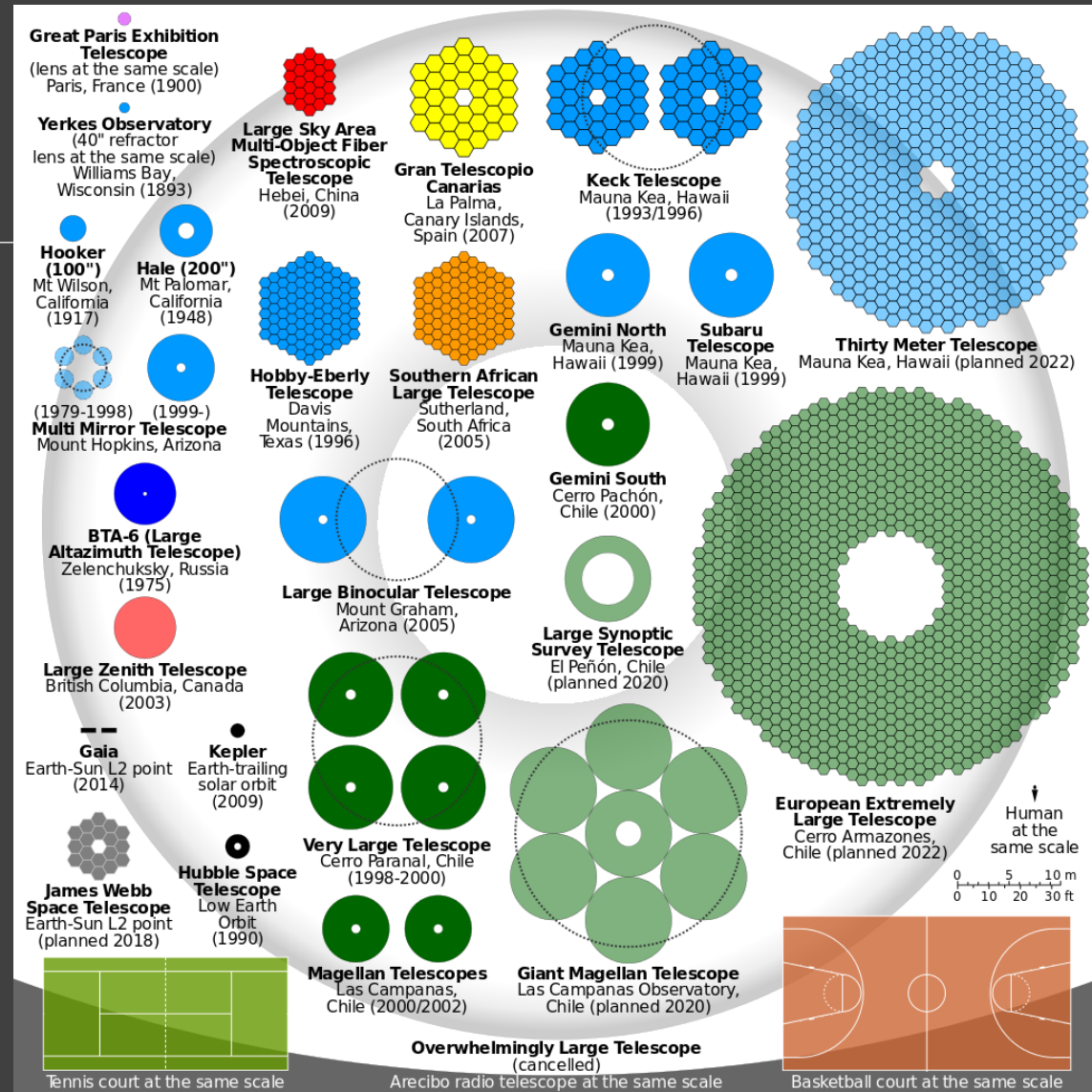



# LID Bonded Be-38Al Optical support Structure, 4 piece (stepped) construction

---



# Beryllium Substrate

---

