



AIAA–2000–3719
Numerical Modeling and Test Data
Comparison of Propulsion Test Article
Helium Pressurization System

Kimberly Holt and Alok Majumdar
NASA Marshall Space Flight Center
MSFC, AL

Todd Steadman and Ali Hedayat
Sverdrup Technology (MSFC Group)
Huntsville, AL

36th AIAA/ASME/SAE/ASEE Joint Propulsion
Conference and Exhibit
The Von Braun Center
Huntsville, Alabama
16–19 July 2000

NUMERICAL MODELING AND TEST DATA COMPARISON OF PROPULSION TEST ARTICLE HELIUM PRESSURIZATION SYSTEM

Kimberly Holt and Alok Majumdar*
Marshall Space Flight Center, MSFC, Alabama

Todd Steadman* and Ali Hedayat**
Sverdrup Technology (MSFC Group), Huntsville, Alabama

Abstract

A transient model of the propulsion test article (PTA) helium pressurization system was developed using the generalized fluid system simulation program (GFSSP). The model included pressurization lines from the facility interface to the engine purge interface and liquid oxygen (lox) and rocket propellant-1 (RP-1) tanks, the propellant tanks themselves including ullage space, and propellant feed lines to their respective pump interfaces. GFSSP's capability was extended to model a control valve to maintain ullage pressure within a specified limit and pressurization processes such as heat transfer between ullage gas, propellant, and the tank wall as well as conduction in the tank wall. The purpose of the model is to predict the flow system characteristics in the entire pressurization system during 80 sec of lower feed system priming, 420 sec of fuel and lox pump priming, and 150 sec of engine firing.

1. Introduction

The PTA provides a test-bed environment to evaluate low-cost solutions to booster technology. PTA consists of lox and RP-1 tanks with a total usable propellant load of 44,000 lbm. The pressurization system is one of the major PTA subsystems, and provides helium to the propellant tanks for pressurization, to valves for actuation, and to the engine for purges. A schematic of the PTA pressurization system is shown in figure 1. This system consists of a lox tank and an RP-1 tank that are both pressurized by helium. A mathematical model was required to predict the ullage and propellant conditions for PTA during pressurization for lower feed system priming, pump priming, and engine firing. The model prediction will ensure that the helium system can provide adequate helium flow to both propellant tanks and the engine, the temperature levels inside the tanks remain within acceptable limits, and the propellant interface pressure satisfies the net positive suction pressure (NPSP) requirements of the fuel and oxidizer pumps.

The pressurization of a propellant tank is a complex thermodynamic process with heat and mass transfer in a stratified environment. Ring¹ described the physical processes and heat transfer correlation in his monograph. Epstein and Anderson² developed an equation for the prediction of cryogenic pressurant requirements for axisymmetric propellant tanks. Van Dresar³ improved the accuracy of Epstein and Anderson's correlation for liquid hydrogen tanks. A computer program⁴ was also developed for Marshall Space Flight Center to simulate pressurization sequencing for the lox and hydrogen tanks in the Technology Test Bed. This program employs a single-node thermodynamic ullage model to calculate the ullage pressure based on ideal gas law, heat transfer, and mixing. Recently, a GFSSP⁵ has been developed for flow and heat transfer analysis in a fluid network. The transient capability of GFSSP⁶ has been extended to model the pressurization process in a propellant tank. The predicted pressurant requirement was verified by a comparison with Epstein and Anderson's² correlation.

*Member

**Senior Member

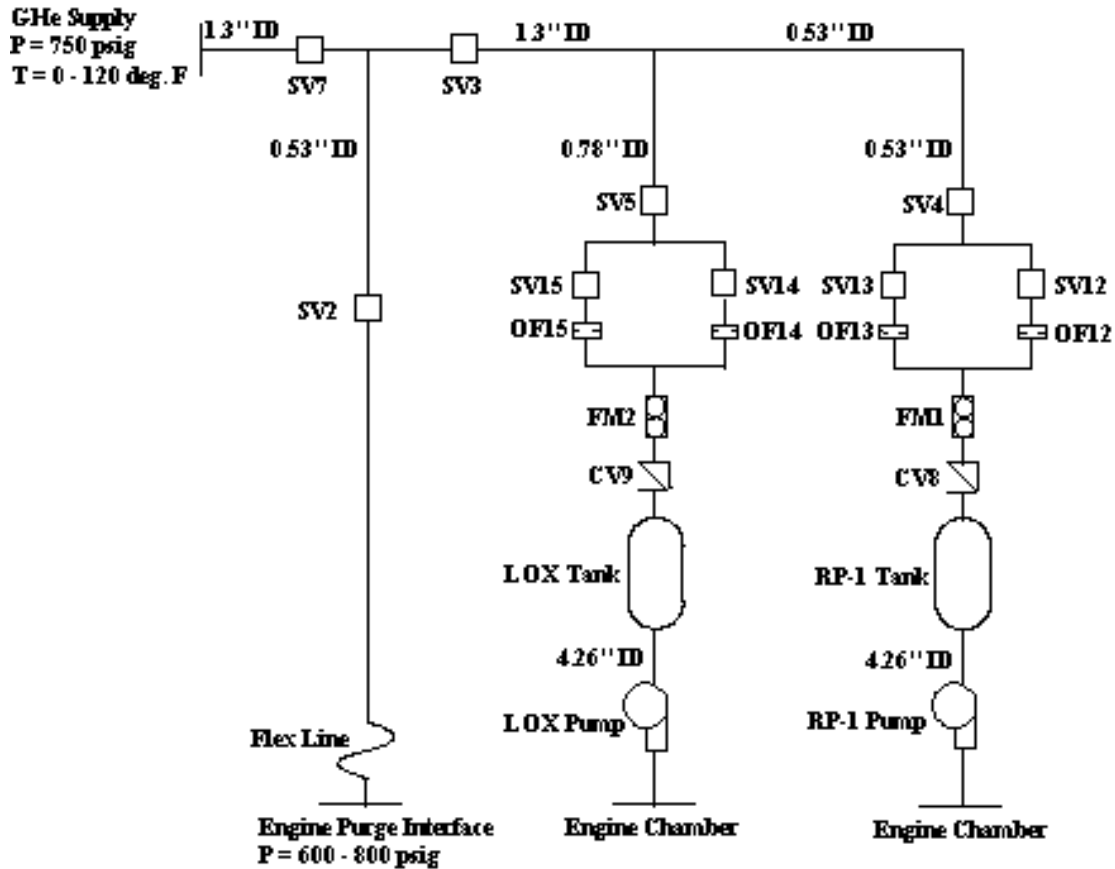

Fig. 1. Helium pressurization system of PTA.

The objective of the present work is to develop an integrated mathematical model from the facility helium supply interface to the PTA/engine interfaces to model pressurization prior to and during engine operation. The model has four primary functions. These functions are:

- (1) To verify by analysis that the main propulsion system/engine requirements are met
- (2) To predict the flow rate and pressure distribution of the helium supply line feeding both the lox and RP-1 tanks
- (3) To predict the ullage conditions considering heat transfer between the ullage, propellant, and the tank wall
- (4) To predict the propellant conditions leaving the tank.

This paper describes an integrated GFSSP model of the helium pressurization system of PTA. The model extends from facility interface to engine purge and pump interfaces and includes all piping, fittings, orifices, and valves. Both RP-1 and lox tanks are included in the model. Each propellant tank has a diffuser and a control system.

Pressure and temperature are specified at the interfaces. The predicted pressure distribution has been compared with test data.

2. GFSSP Model

The helium pressurization system is discretized into a number of nodes and branches. There are two kinds of nodes: boundary nodes and internal nodes. At boundary nodes, pressure, temperature, and species concentrations are specified. GFSSP calculates pressure, temperature, and concentrations at internal nodes by solving mass, energy, and specie conservation equations. Flow rates are calculated at branches by solving momentum conservation equations. The branches and nodes are numbered arbitrarily. The branches represent flow resistances that include all common pipeline fittings and orifices. An integrated GFSSP model of the helium pressurization system of PTA is shown in figure 2. The model consists of 65 nodes and 64 branches. The model contains six boundary nodes, which are listed along with the interface they represent in table 1.

Table 1. PTA boundary node locations.

Boundary Node	Interface
1	Facility
65	Engine (purge)
55	Ullage-propellant (lox tank)
59	Lox pump
30	Ullage-propellant (RP-1 tank)
34	RP-1 pump

Pressure and temperatures are prescribed at all boundary nodes except node 55 and 30. It may be noted that the nodes representing the ullage-propellant interface (node 55 and 30) are pseudoboundary nodes. The code uses the calculated ullage pressure at the previous time step. Helium enters into the system from the facility interface through a 1.5-in. outside diameter (OD) tubing. From this main line, helium is distributed into three parallel branches. The first branching takes place after 128 in. of tubing, supplying helium to the engine for engine purges through a 0.75-in. OD tubing. The second branching takes place 305 in. downstream of the first branch. This branch supplies helium to the lox tank using 1-in. OD tubing. The remainder of the helium line is routed to pressurize the RP-1 tank using 0.75-in. OD tubing. All tubing sizes have a wall thickness of 0.109 in. The lines leading to the lox and RP-1 tanks each have two parallel legs, one of which remains closed during a given operation. The left leg of each circuit uses an orifice to choke the flow at a lower flow rate and is used to pressurize the tank during lower feed system priming. The right leg of the circuit has an orifice for higher flow rate and is used to pressurize the tank during pump priming operation and during engine firing. In the model discussed in this paper, setting a high resistance in the appropriate branches eliminated the flow to the leg not being used for that particular run.

The GFSSP model shown in figure 2 was broken into six separate runs that covered a period of 650 sec, beginning at -500 sec before engine start and continuing to 150 sec after engine start, using a time step of 0.1 sec. The first three runs represent the lower feed system priming, the next two runs represent the pump priming, and the final run represents the engine firing. The model was broken into multiple runs to accurately model the various propellant flow rates required at different stages of operation. These flow rates were achieved by altering the orifice sizes in the branches downstream of the lox and RP-1 propellant tanks until GFSSP predicted the calculated flow rate for that particular period of operation.

The first run is a steady-state analysis, which is used exclusively to obtain an initial solution for use in the first transient run. Each run thereafter uses the previous run's final time-step solution as its initial condition. The second run begins at -500 sec and runs for 1 to -499 sec. During this time there is no flow leaving either the lox or RP-1 tank. The ullages of each tank are initially at a pressure of 14.7 psia with their respective ullage pressure control set points set to a nominal pressure of 20 psia with a ± 3 psi control band. The third run lasts for 79 sec, beginning at -499 sec and ending at -420 sec. The ullage pressure control remains at a set point of 20 psia while there is now a 0.12 lbm/sec propellant bleed flow from the lox tank and a 0.1 lbm/sec propellant bleed flow from the RP-1 tank. During the test, the RP-1 system is primed before the lox system, but for simplicity, both propellant systems are primed at the same time during the analysis.

The fourth run covers a 60 sec duration from -420 to -360 sec. At the beginning of this run, the ullage pressure control set points increase to 67 psia for the lox tank and 50 psia for the RP-1 tank with a ± 3 psi control band. The propellant bleed flow rates see an increase to 1 lbm/sec for the lox tank and 0.25 lbm/sec for the RP-1 tank. At the end of this run, the RP-1 bleed is closed and the system is considered primed. The fifth run encompasses the remaining 360 sec before engine start from -360 to 0 sec. The ullage pressure control set points remain the same for the first 240 sec of this run. At -120 sec, prepress occurs and the set point for RP-1 tank rises by 5 psi, resulting in nominal set point of 55 psia for the RP-1 tank with a ± 3 psi control band. The propellant bleed flow rate for lox remains at 1 lbm/sec and there is no RP-1 propellant bleed flow during this time.

The sixth and final run covers the 150-sec engine firing period from 0 to 150 sec. Initially, the ullage pressure control set point for the RP-1 tank remains at the prepress value, but after 3 sec it drops 5 psi to 50 psia with a ± 3 psi control band. Nominal propellant flow to the engine is 139 lbm/sec for lox and 64 lbm/sec for RP-1. Table 2 shows the different pressures and flow rates assumed for the analysis.

During testing there were hardware changes made to the orifice sizes for OF12, OF13, OF14, and OF15. The orifices were designed with the assumption of a $C_d=0.6$. The orifice flows were not tested prior to being installed in the helium system. With this in mind, the analysts selected various sizes of orifices to be purchased so that any required changeouts could be made in a day with available orifices. The only orifice that required two changes was OF14. The requested orifice size was not immediately available so a smaller orifice was used. Table 3 gives the

Table 2. System pressures and flow rates assumed for the analysis.

Time (sec)	Lox Ullage Pressure (psia)	RP Ullage Pressure (psia)	Lox Mass Flow Rate (lbm/sec)	RP Mass Flow Rate (lbm/sec)	Comments
-500	14.7	14.7	0	0	Initial solution
-500 to -499	20 ± 3	20 ± 3	0	0	Pressure control set point change
-499 to -420	20 ± 3	20 ± 3	0.12	0.1	Priming of lower feed system
-420 to -360	67 ± 3	50 ± 3	1	0.25	Priming of the engine pumps
-360 to -120	67 ± 3	50 ± 3	1	0	RP system is primed
-120 to 0	67 ± 3	55 ± 3	1	0	Increase set point to prepress conditions
0 to 3	67 ± 3	55 ± 3	1 to 139	0 to 64	Engine start transient
3 to 150	67 ± 3	50 ± 3	139	64	Engine steady-state firing

Table 3. PTA helium pressurization orifice sizes.

Orifice ID	As Designed			Test 31		
	Diameter (in.)	C _d	C _d A	Diameter (in.)	C _d	C _d A
OF12	0.192	0.6	0.0174	0.143	0.92	0.01478
OF13	0.1	0.6	0.00471	0.09	1.0	0.00636
OF14	0.36	0.6	0.06107	0.25	0.92	0.04516
OF15	0.15	0.6	0.01060	0.11	1.0	0.00950

updated diameter and C_d values for each of the four orifices.

3. Operations Scenario

The test chosen for comparison is an engine hot fire test (test 31). For the engine firing, the fuel and oxidizer tanks were both filled 90–95 percent. The RP–1 system was primed first, and fuel tank pressurized to 20 psia. The bypass valve was opened so that RP–1 would fill the lower feed line. The prevalve was then opened and the bypass valve closed. The objective was to fill the lower feed line and the engine with RP–1. After the fuel system was primed, the lox tank was pressurized to 20 psia. The lox bypass was opened to chill and fill the lower feed line. During this process the lox tank was vented and replenished. The tank was then pressurized to 20 psia again and priming was completed. The prevalve was opened and the bypass valve was closed. The lox tank was then pressurized to 67 psia. The RP–1 tank was also pressurized to run pressure and then to prepress conditions. The engine start command was issued at T=0. The engine ran for ~126

sec before an erroneous instrumentation reading cut the test. Figures 3 and 4 show measured ullage pressure for lox and RP–1 tanks, respectively, during the entire operation.

4. Comparison With Test Data

The numerical model only simulated the last 500 sec before engine start as well as the engine firing itself. Also, the numerical model used C_d and area values for the orifices as initially designed and did not account for the hardware changes made during testing. Figure 5 shows the comparison of lox ullage between the model pressure prediction and the test data. The predicted ullage pressure in the lox tank has been compared with measured data from three sensors located in the ullage. All three sensors recorded almost identical pressures, confirming that pressure is uniform in the ullage. The predicted pressure distribution compares very well with test data. It may be noted that the predicted frequencies of closing and opening the valve are in good agreement with measurements both prior to engine start and during engine firing. There

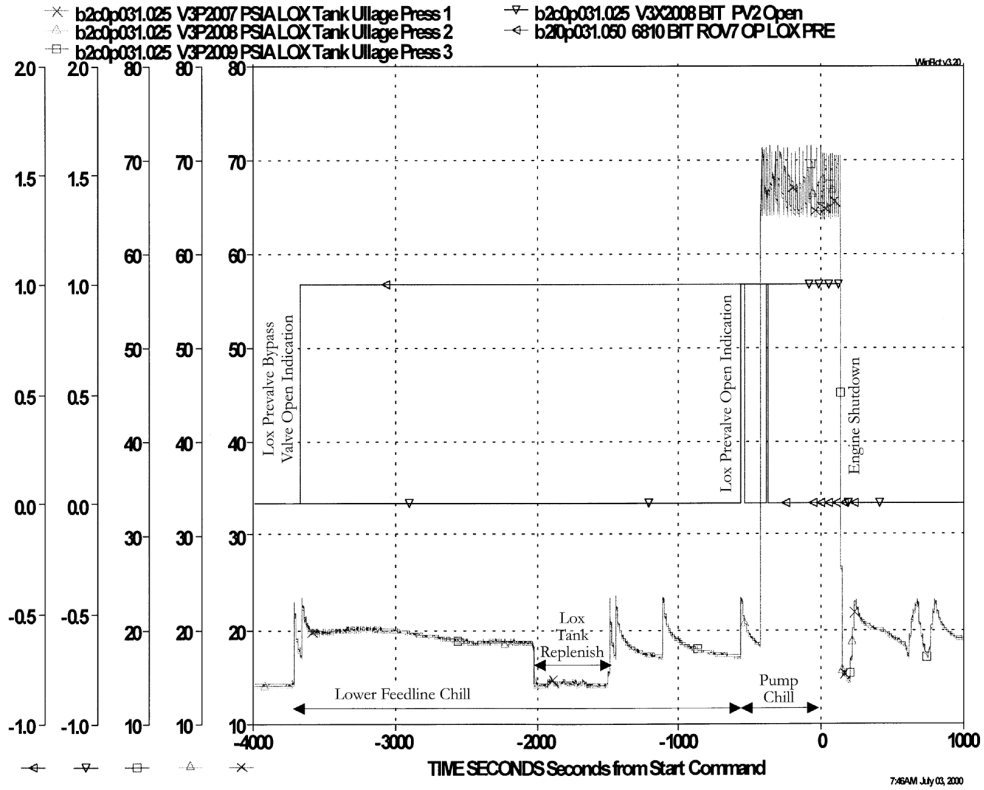

Fig. 3. Lox tank pressure distribution during operation for test 31.

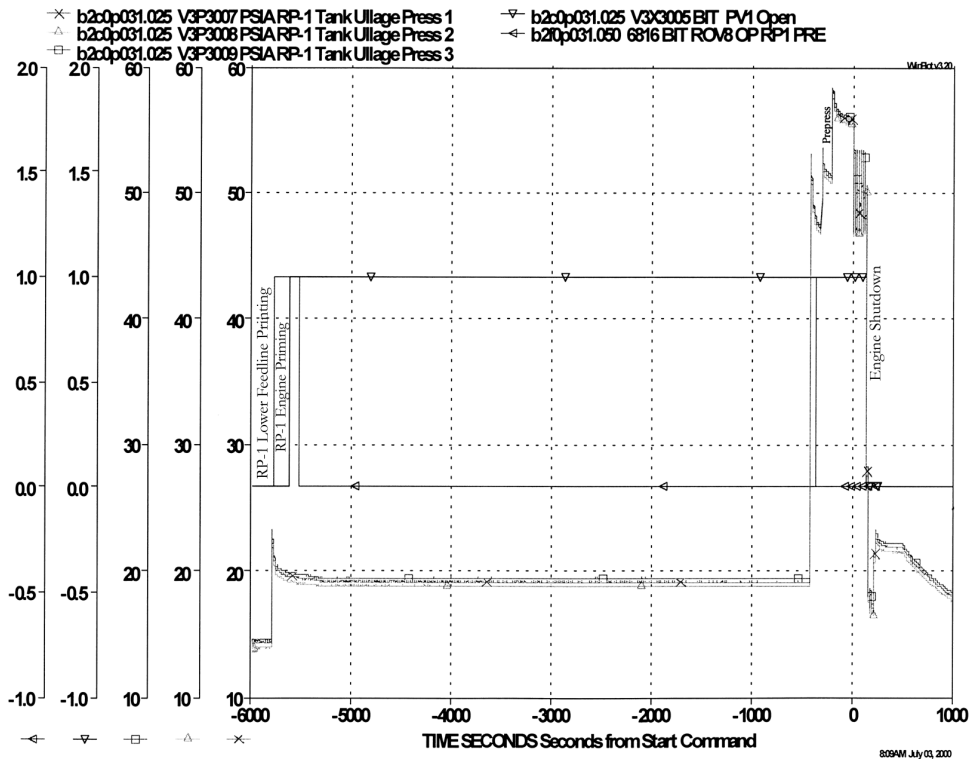

Fig. 4. RP-1 Tank pressure distribution during operation for test 31.

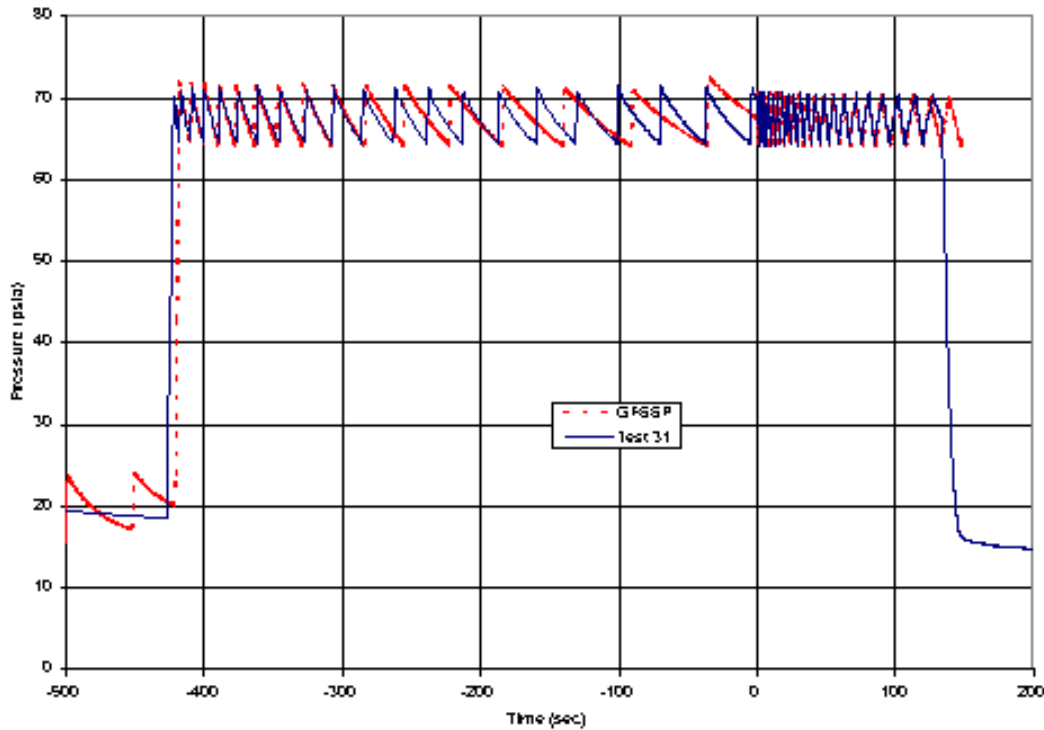

Fig. 5. Comparison between lox tank ullage pressure prediction and test data.

is an observed discrepancy between the prediction and test data between -500 and -420 sec. The prediction shows closing and opening of the valve during this period while test data shows relatively constant pressure during this period. This discrepancy can be attributed to the assumed flow rate during this period.

Figure 6 shows the comparison of the model predictions to the test data for the RP-1 tank ullage. The predicted ullage pressure compares well with the three ullage measurements. The frequency of the control valve openings and closings are in close agreement with the data during engine firing. During -420 to 0 sec the test shows three sequences of valve openings and closings that the analysis did not predict. The observed discrepancy could be attributed to assumed flow rate of RP-1 during this operation.

Figure 7 shows the comparison between measured and predicted lox tank ullage temperature. The predicted temperature follows the same trend as the test data, but there is a discrepancy. This could in part be due to a single temperature measurement in the ullage. To truly measure the ullage temperature accurately, the stratification in the ullage would need to be recorded. This would require many axial and radial temperature measurements to be recorded in the ullage to define the stratification. In the model, the

ullage is considered a single-lump node which does not allow the model to predict the stratification effect.

Figure 8 shows the comparison between the measured and the predicted ullage temperature for the RP-1 tank. Like the lox tank, the predicted temperature follows the same trend as the test data, but there is a discrepancy. At $T=0$ the test data and the prediction diverge for a few seconds, due to the difference in the pressurization curve during engine start. The model predicted an ullage pressure increase during engine start when the closed-loop control pressure is set to 55 psia.

Figure 9 shows the predicted helium flow rates, which vary over time due to opening and closing the control valves. The flow from the facility interface is distributed to three branches. A nearly constant flow rate (≈ 0.4 lbm/sec) is predicted to the engine purge interface for engine purges. The orifices in each branch to the propellant tanks were designed to be the choke point in the system and therefore control the pressurant flow to the tanks. The calculated flow for each orifice is shown in table 4. Predicted flow rates compare well with test data. The maximum flow rates to the lox and RP-1 tanks are approximately 0.34 and 0.085 lbm/sec, respectively. On three occasions, predicted helium flow rate to lox tank exceeds choked flow rates. This appears to be numerical fluctuations due to lack of convergence at these time steps.

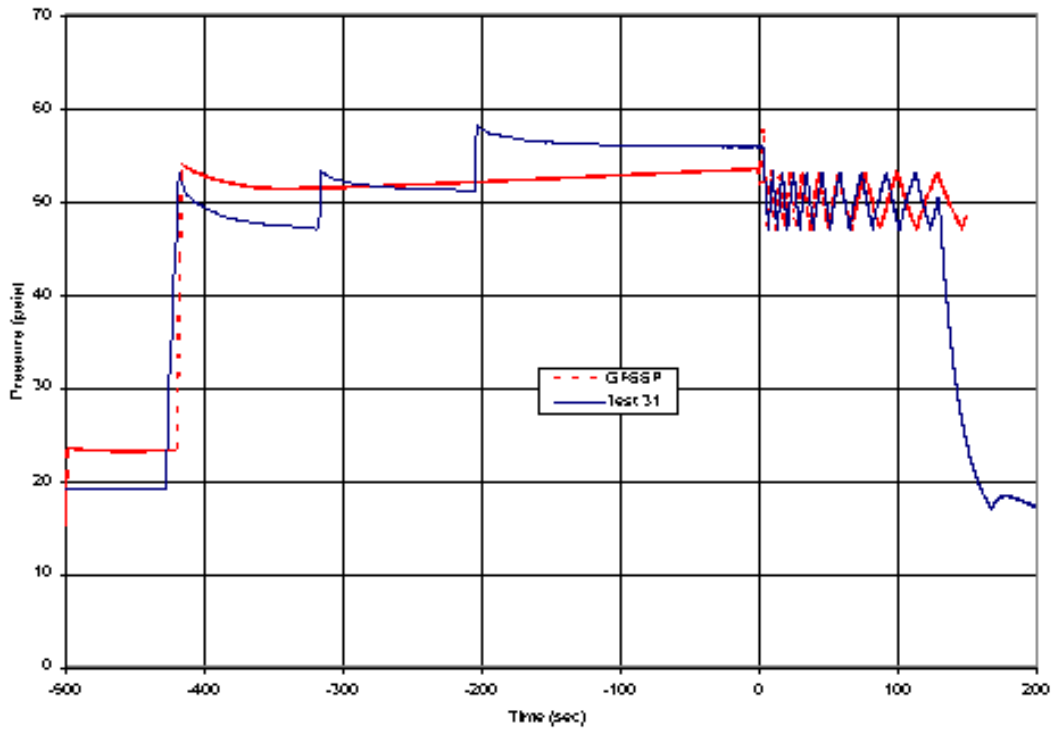

Fig. 6. Comparison between RP-1 tank ullage pressure prediction and test data.

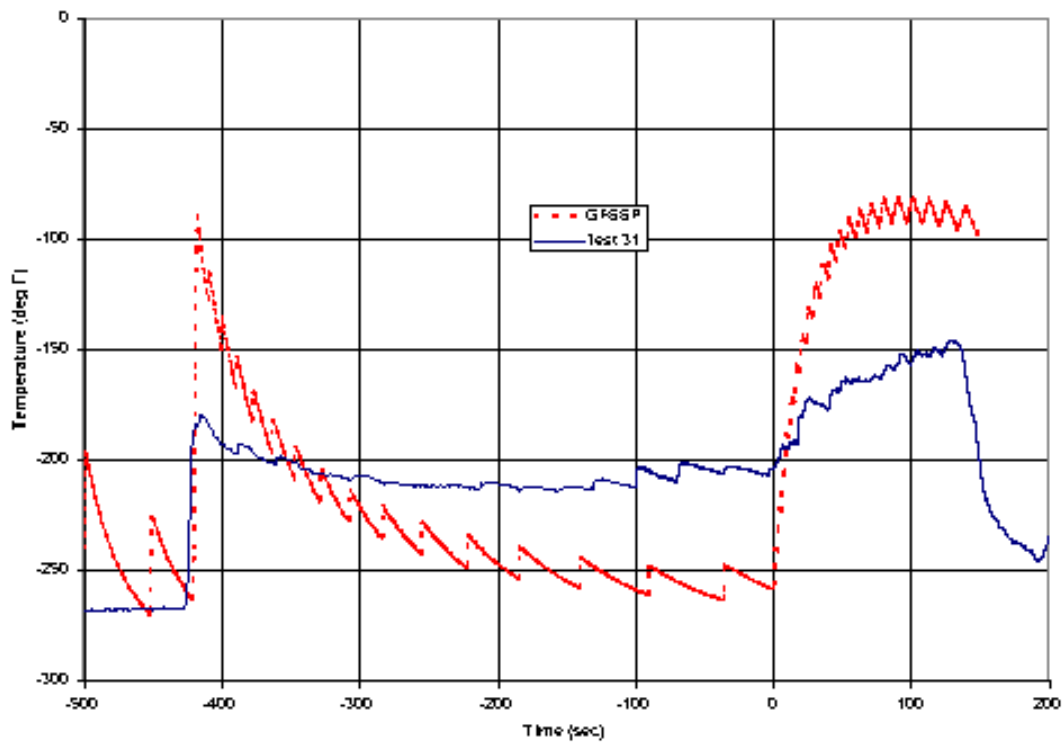

Fig. 7. Comparison between lox tank ullage temperature prediction and test data.

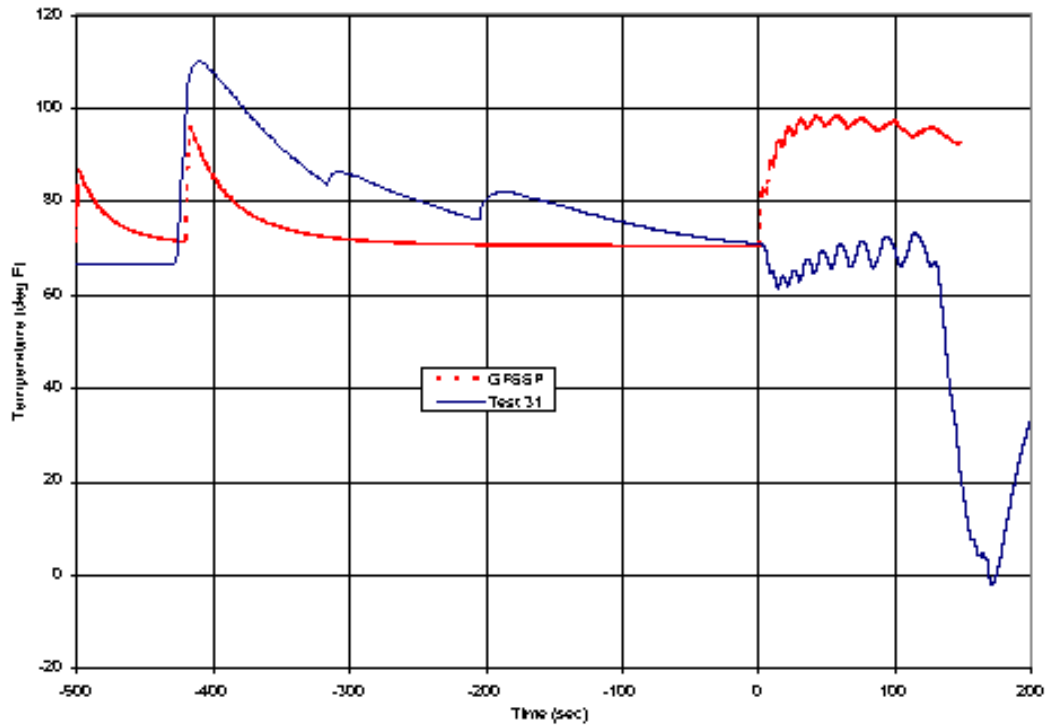

Fig. 8. Comparison between RP-1 tank ullage temperature prediction and test data.

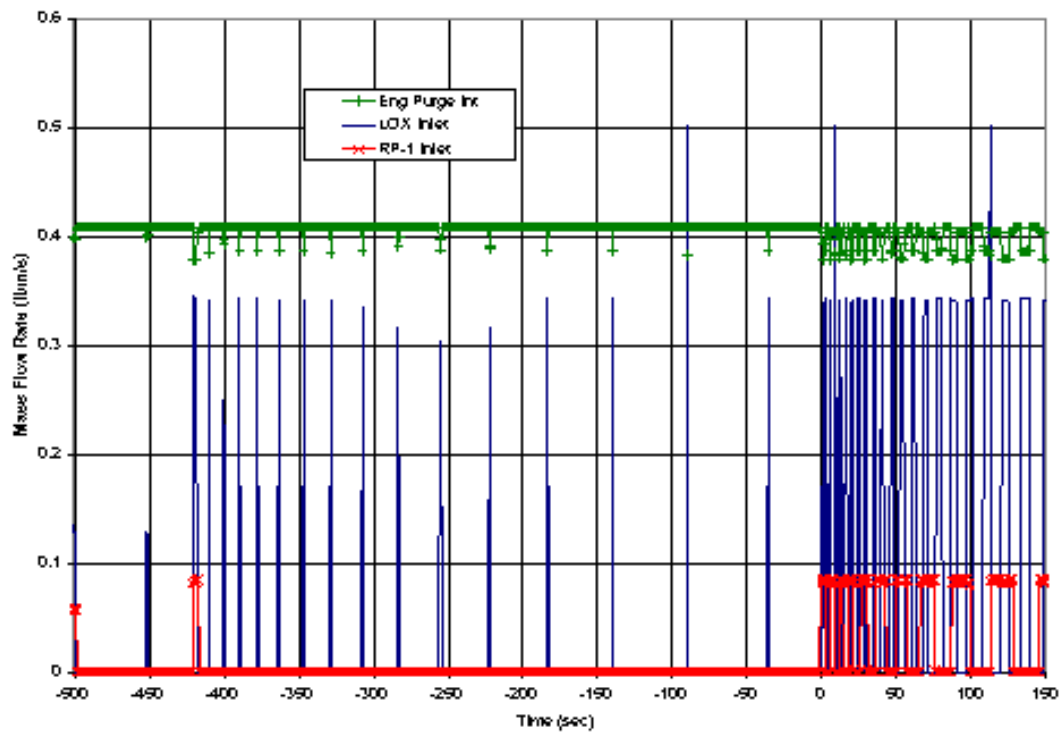

Fig. 9. Predicted helium flow rates.

Table 4. Comparison between GFSSP and test helium flow rates.

GFSSP (lbm/sec)		Test (lbm/sec)	
Lox	RP-1	Lox	RP-1
0.34	0.085	0.33	0.101

5. Conclusions

A detailed numerical model of a pressurization system consisting of lox and RP-1 tanks was developed using the GFSSP. The model included feed lines from the facility interface to the engine purge interface, lox, and RP-1 tanks including ullage space and propellant feed lines and propellant pump interfaces. The control valves of both tanks were modeled to set the pressure within a specified band. The model also accounted for the heat transfer between helium and propellants and between helium and the tank wall in the tank ullage. The model predicted pressure, temperature, and flow rate distribution during 650 sec of operation, which included 500 sec of priming and 150 sec of engine firing. The predicted pressure and temperature in the tank ullage were compared with test data. The predicted pressures in both tanks compared well with test data. In particular, valve sequencing was predicted accurately during engine firing. However, some discrepancies were observed in pressure prediction during the chill down and priming period that can be attributed to the error in estimating flow rate during that period. The predicted temperatures show correct trends when compared with the test data. The observed discrepancy in temperature can be attributed to stratification and the lack of resolution in the numerical model. The predicted helium flow rates compare well with test data.

References

1. Ring, E., *Rocket Propellant and Pressurization Systems*, Prentice Hall, 1964.
2. Epstein, M., and Anderson, R.E., "An Equation for the Prediction of Cryogenic Pressurant Requirements for Axisymmetric Propellant Tanks," *Advances in Cryogenic Engineering*, Plenum, New York, Vol. 13, pp. 207-214, 1968.
3. Van Dresar, N.T., "Prediction of Pressurant Mass Requirements for Axisymmetric Liquid Hydrogen Tanks," *Journal of Propulsion and Power*, Vol. 13, No. 6, pp. 796-799, 1997.
4. A computer program entitled "TTBSIM" for simulating tank pressurization for Technology Test Bed at Marshall Space Flight Center, June 1997.
5. Majumdar, A., "Generalized Fluid System Simulation Program (GFSSP) Version 3.0," Sverdrup Technology Report No. MG-99-290, Contract No. NAS8-40836, November 1999.
6. Majumdar, A., and Steadman, T., "Numerical Modeling of Pressurization of a Propellant Tank," Paper No. AIAA 99-0879, 37th AIAA Aerospace Sciences Meeting Conference and Exhibit, January 11-14, 1999, Reno, Nevada.