

CD-2012-72

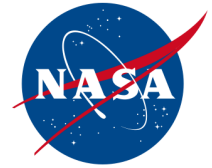

COMPASS Final Report: Advanced Lithium Ion Venus Explorer (ALIVE)

Requestor: Michael Paul, Applied Research Laboratory / Pennsylvania State University

COMPASS Lead: Steven R. Oleson

COMPASS Concept Design Integration Lead: Melissa L. McGuire

COMPASS Study System Integration Lead: Carl E. Sandifer II

COMPASS Team Members

*Les Balkanyi
Michael Bur
Laura Burke
Kristen Bury
Tony Colozza
John Dankanich*

*Jon Drexler
James Fincannon
Jim Fittje
John Gyekenyesi
Geoffrey Landis
Mike Martini*

*Tom Packard
Carlos Rodriguez
Charles Sheehe
Anita Tenteris
Joe Warner
Glenn Williams*

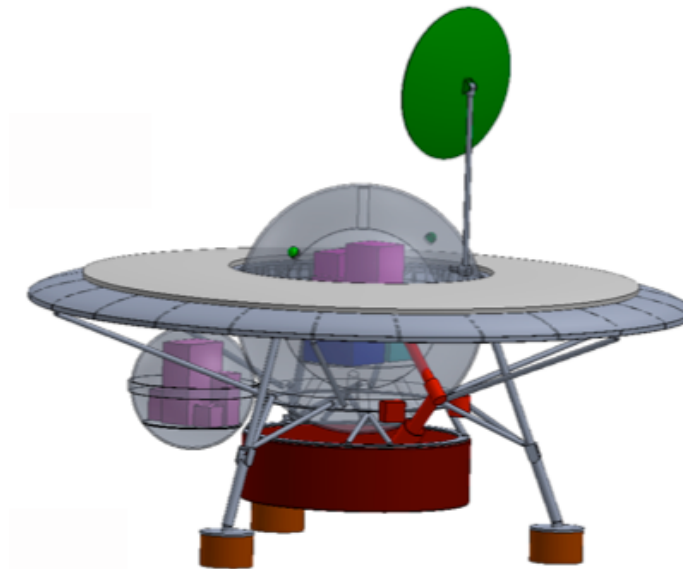

This work is preliminary in nature, capturing the progress of work in a design group.



Deleted this table before printing

Version	Date	Description
V2	5/31/2012	Carl needs to update/format Science
V2	5/31/2012	Carl needs to update/format Communications
V2	5/31/2012	Carl needs to update Systems
V2	5/31/2012	Carl needs to update formulas for Structures
V3	6/15/2012	Planned completion for integration of technical details
V4	6/15/2012	Out of Publishing, Lorie and Les made comments

TABLE OF CONTENTS

1.0	INTRODUCTION	Error! Bookmark not defined.
2.0	STUDY BACKGROUND AND ASSUMPTIONS.....	2
2.1	Introduction.....	2
2.1.1	Background/Past Potential Venus Missions (Needs to be updated and formatted-ces).....	3
2.1.2	Report Perspective and Disclaimer.....	4
2.2	Assumptions and Approach	4
2.3	Study Summary Requirements	6
2.3.1	Figures of Merit	6
2.4	Growth, Contingency, and Margin Policy	7
2.4.1	Terms and Definitions	7
2.4.2	Mass Growth.....	9
2.4.3	Power Growth (Needs to be updated-ces)	10
2.5	Mission Description.....	10
2.5.1	Mission Analysis Assumptions.....	11
2.5.2	Mission Trades.....	11
2.5.3	Mission ΔV Details.....	13
2.5.4	Mission Analysis Analytic Methods.....	13
2.5.5	Concept of Operations (CONOPS).....	13
2.5.6	Mission Communications Details.....	16
2.6	Launch Vehicle Details.....	18
2.6.1	Payload Fairing Configuration.....	19
3.0	BASELINE DESIGN.....	20
3.1	Top-Level Design	20
3.1.1	Master Equipment List (MEL)	20
3.1.2	S/C Total Mass Summary	22
3.1.3	Power Equipment List (PEL).....	23
3.2	System-Level Summary (Needs to be updated-ces)	25
3.2.1	Propellant Calculations	25
4.0	AREAS FOR FUTURE STUDY	26
5.0	SUBSYSTEM BREAKDOWN	27
5.1	Science Package.....	27
5.1.1	Descent Instruments.....	27
5.1.2	Surface Instrument Details.....	28
5.1.3	Science Design and MEL	29
5.2	Communications	29
5.2.1	Communications Requirements.....	29
5.2.2	Communications Assumptions	30
5.2.3	Communications Design and MEL.....	33
5.2.4	Communications Recommendation.....	34
5.3	Command and Data Handling.....	34
5.3.1	C&DH Requirements.....	34
5.3.2	C&DH Assumptions.....	34
5.3.3	C&DH Design and MEL	34
5.3.4	C&DH Trades	36
5.3.5	C&DH Analytical Methods	36
5.3.6	C&DH Risk Inputs.....	36
5.3.7	C&DH Recommendation.....	36
5.4	Guidance, Navigation and Control	37



5.4.1	GN&C Requirements.....	37
5.4.2	GN&C Assumptions.....	37
5.4.3	GN&C Design and MEL.....	37
5.4.4	GN&C Trades.....	38
5.4.5	GN&C Analytical Methods.....	38
5.4.6	GN&C Risk Inputs.....	41
5.4.7	GN&C Recommendation.....	41
5.5	Electrical Power System.....	41
5.5.1	Power Requirements.....	41
5.5.2	Power Assumptions.....	42
5.5.3	Power Design and MEL.....	42
5.5.4	Power Trades.....	46
5.5.5	Power Analytical Methods.....	46
5.5.6	Power Risk Inputs.....	46
5.5.7	Power Recommendation.....	46
5.6	Propulsion System.....	46
5.6.1	Propulsion System Requirements.....	46
5.6.2	Propulsion System Assumptions.....	46
5.6.3	Propulsion System Design and MEL.....	47
5.6.4	Propulsion System Trades.....	48
5.6.5	Propulsion System Analytical Methods.....	48
5.6.6	Propulsion System Risk Inputs.....	49
5.6.7	Propulsion System Recommendation.....	49
5.7	Structures and Mechanisms.....	49
5.7.1	Structures and Mechanisms Requirements.....	49
5.7.2	Structures and Mechanisms Assumptions.....	49
5.7.3	Structures and Mechanisms Design and MEL.....	49
5.7.4	Structures and Mechanisms Trades.....	52
5.7.5	Structures and Mechanisms Analytical Methods.....	52
5.7.6	Structures and Mechanisms Risk Inputs.....	53
5.7.7	Structures and Mechanisms Recommendation.....	53
5.8	Thermal Control.....	53
5.8.1	Cruise Deck Thermal Control.....	54
5.8.2	Electric Heaters.....	54
5.8.1	MLI and Thermal Control Paint.....	55
5.8.2	Radiator and Cold Plates.....	56
5.9	Venus Atmospheric Environment.....	57
5.10	Aeroshell and Descent Thermal Control.....	58
5.10.1	Descent Electronics Enclosure Thermal Control.....	59
5.11	Surface Lander Thermal Control.....	60
6.0	COST AND RISK.....	61
6.1	Cost.....	61
6.2	Risk.....	63
7.0	BIBLIOGRAPHY.....	68
APPENDIX A —ACRONYMS AND ABBREVIATIONS.....		70
APPENDIX B —RENDERED IMAGES.....		72
B.1	Insert subtitle.....	72
APPENDIX C —COMPASS INTERNAL DETAILS (ALWAYS LAST).....		73
C.1	COMPASS Description.....	73
C.2	GLIDE Study Share.....	73
C.2.1	GLIDE Architecture.....	73

C.2.2 GLIDE Study Container 73

LIST OF FIGURES

Figure 1.1—ALIVE S/C. 2

Figure 2.1—Previous Venus space vehicles. 3

Figure 2.2—Probe 5-d cruise and descent timeline. 4

Figure 2.3—Cartesian Map of Ovda Regio. 5

Figure 2.4—Graphical illustration of the definition of basic, predicted, total and allowable mass. 7

Figure 2.5—Trajectory graphic. Best case ALIVE opportunity. 11

Figure 2.6—Figure 2.6.2-1: Primary and backup mission opportunities. 11

Figure 2.7—Minimum arrival energy solution. 12

Figure 2.8—Example LGA option to reduce launch energy requirements. 13

Figure 2.9—ALIVE EDL operations. 15

Figure 2.10—Earth-Probe distance (a) and SEP and SPE angles (b). 16

Figure 2.11—SOAP communications analysis. 17

Figure 2.12—Need caption. 17

Figure 2.13—Need caption. 17

Figure 2.14— 18

Figure 2.15— 18

Figure 2.16— 18

Figure 2.17—ALIVE Lander aeroshell dimensions. 19

Figure 2.18—Isometric views of the ALIVE Lander inside the aeroshell. 20

Figure 2.19—Landing legs and X-band antenna deployment sequence. 20

Figure 3.1—ALIVE design approach. 21

Figure 5.1—Block diagram of ALIVE communications hardware. 31

Figure 5.2—Illustration of ALIVE LGA. 32

Figure 5.3—Graphic of ALIVE HGA. 32

Figure 5.4—Image of ALIVE SDST communications hardware. 33

Figure 5.5—Image of ALIVE TWTA and EPC. 33

Figure 5.6—Summary of nominal EDL profile. 39

Figure 5.7—Acceleration timeline from atmospheric entry. 39

Figure 5.8—Nominal altitude profile during atmospheric entry. 40

Figure 5.9 Duplex Sketch. 43

Figure 5.11—Heat and power flows for ALIVE Power and Cooling System. 44

Figure 5.12—ALIVE Power/Cooling System highlights. 45

Figure 5.13—Feed System components. 47

Figure 5.14—Preliminary Cruise Deck Propulsion P&ID. 47

Figure 5.15—(a) The Lander stowed within the heat shield/backshell assembly and (b) the Lander fully deployed. 50

Figure 5.16—DuPont Kapton Strip Heater. 54

Figure 5.17—Example of MLI blanket design and application. 55

Figure 5.18—Example of a cold plate with integrated heat pipes. 56

Figure 5.19—Radiator with integral heat pipes (ACT, inc). 57

Figure 5.20—Venus atmospheric properties. 57

Figure 5.21—Venus atmospheric structure. 58

Figure 5.22—Orion heat shield structural makeup. 59

Figure 5.23—Stardust Aeroshell Geometry. 59

Figure 5.24—Descent electronics thermal control items. 60

Figure 5.25—Heat leak into the Lander electronics enclosure pressure vessel. 61



Figure 6.1—ALIVE Risk List 64
 Figure 6.2—Risks 1 and 2—Mission and Power risks for ALIVE. 65
 Figure 6.2—Risks 3 and 4—Mechanisms and Mission risks for ALIVE. 65
 Figure 6.3—Risks 5 and 6—Thermal and Mission risks for ALIVE. 66
 Figure 6.4—Risks 7 and 8—Electronics and Structures risks for ALIVE. 66
 Figure 6.5—Risks 9 and 10—Thermal risks for ALIVE. 67
 Figure 6.6—Risks 11 and 12—Thermal and Propulsion risks for ALIVE. 67
 Figure 6.7—ALIVE TRL assessment. 68
 Figure B.1—..... 72
 Figure B.2—..... 72
 Figure B.3—..... 72

LIST OF TABLES

Table 1.1—Mission and S/C Summary for the ALIVE mission 2
 Table 2.1—Assumptions and Study Requirements 5
 Table 2.2—Definition of Masses Tracked in the MEL 9
 Table 2.3—MGA and Depletion Schedule (AIAA S-120-2006) 10
 Table 2.4—LV performance versus launch energy of interest. 12
 Table 2.5—Mission ΔV Summary for the ALIVE S/C 13
 Table 2.6—Additional Mission Analysis..... 13
 Table 3.1—ALIVE MEL WBS Format 21
 Table 3.2—ALIVE System Summary 22
 Table 3.3—ALIVE Total Mass With Payload (Includes 30% System Level Growth) 23
 Table 3.4—Definition of the ALIVE S/C Power Modes 23
 Table 3.5—ALIVE S/C PEL 24
 Table 3.6—Case x Thermal Waste Heat Per Power Mode 24
 Table 3.7—ALIVE S/C Propellant Details 25
 Table 3.8—Inert Mass Calculations For ALIVE Total S/C..... 26
 Table 3.9—ALIVE Architecture Details 26
 Table 5.1—Descent Instruments 27
 Table 5.2—Surface Instruments 28
 Table 5.3—Science ALIVE MEL 29
 Table 5.4—Communications Science Link Budget 30
 Table 5.5—Communications Case x MEL 33
 Table 5.6—C&DH ALIVE S/C MEL 35
 Table 5.7—GN&C ALIVE S/C MEL 37
 Table 5.8—Assumptions Made During Parachute Sizing 40
 Table 5.9—Power Requirements 42
 Table 5.10 Mass Breakdown of Duplex Power System 45
 Table 5.11—Electrical Power System ALIVE S/C MEL 45
 Table 5.12—Propulsion System ALIVE S/C MEL 48
 Table 5.13—ALIVE S/C Structures MEL 50
 Table 5.14—Lander Structures MEL 51
 Table 5.15—Aeroshell Structures MEL 51
 Table 5.16—Cruise Deck Structures MEL 52
 Table 5.17—Transit Environment Constants 54
 Table 5.18—Thermal ALIVE S/C MEL 55
 Table 5.19—MLI Specifications 56
 Table 5.20—Cruise Deck Radiator Sizing 57
 Table 5.21—Heatshield Material Layer Properties 59
 Table 5.22—Insulation and Phase Change Material Specifications 60

COMPASS Final Report

Table 5.23—Pressure Vessel Components and Heat Leak.....	61
Table 6.1—COMPASS Subsystem Level Cost Breakdown—ALIVE.....	62
Table 6.2—Lifecycle Cost Comparison for the ALIVE mission.....	63
Table C.1—Study Container and Descriptions.....	73



STUDY PARTICIPANTS (NEEDS TO BE UPDATED-CES)

Study Name Design Session			
Subsystem	Name	Center	Email
Propulsion PI	Michael Paul	PSU	
Science PI	James Kasting	PSU	
Propulsion PI	George Schmidt	GRC	
Science PI, Robotic Elements	Geoffrey Landis	GRC	
Robotic Elements	Gary Hunter	GRC	
COMPASS Team			
Lead	Steve Oleson	GRC	Steven.R.Oleson@nasa.gov
System Integration, MEL, Mission Visualization, and Final Report Documentation	Carl E. Sandifer II	GRC	Carl.E.Sandifer@nasa.gov
Technical Editing and Oversight	Melissa.L.Mcguire	GRC	Melissa.@nasa.gov
Internal Editing and Final Report Documentation	Leslie Balkanyi	GRC	Leslie.R.Balkanyi@nasa.gov
Mission	John Dankanich,	GRC	John.Dankanich@nasa.gov
Mission	Ian Dux	GRC	Ian.J.Dux@nasa.gov
Mission, Operations, GN&C	Michael Martini	QNA Corp	Michael.C.Martini@nasa.gov
ELV, Integration and Test, Operations	Carlos Rodriguez	GRC	Carlos.D.Rodriguez@grc.nasa.gov
Propulsion and Propellant	James Fittje	QinetiQ	James.E.Fittje@nasa.gov
Propulsion and Propellant	David Chato	GRC	David.J.Chato@nasa.gov
Mechanical Systems	John Gyekenyesi	GRC	John.Z.Gyekenyesi@nasa.gov
Mechanical Systems	David McCurdy	ASRC	David.R.Mccurdy@nasa.gov
Thermal	Tony Colozza	QNA Corp	Anthony.J.Colozza@nasa.gov
Power	Paul Schmitz	PCS	Paul.C.Schmitz@nasa.gov
Power	Timothy Miller	PSU	
Command and Data Handling	Glenn L. Williams	GRC	Glenn.L.Williams@nasa.gov
Communications	Charles Sheehe	GRC	Charles.J.Sheehe@nasa.gov
Configuration	Tom Packard	GRC	Thomas.W.Packard@nasa.gov
Cost	Jonathan Drexler	GRC	
Risk/Reliability	Anita Tenteris	GRC	Anita.D.Tenteris@nasa.gov



1.0 EXECUTIVE SUMMARY

The COncurrent Multidisciplinary Preliminary Assessment of Space Systems (COMPASS) Team partnered with the Applied Research Laboratory to perform a NASA Innovative Advanced Concepts (NIAC) Program study to evaluate chemical based power systems for keeping a Venus lander alive (power and cooling) and functional for a period of days. The mission class targeted was either a Discovery (\$500M) or New Frontiers (\$750M to \$780M) class mission.

Historic Soviet Venus landers have only lasted on the order of 2 hours in the extreme Venus environment: temperatures of 460 °C and pressures of 93 bar. Longer duration missions have been studied using plutonium powered systems to operate and cool landers for up to a year. However, the plutonium load is very large. This NIAC study sought to still provide power and cooling but without the plutonium. Batteries are far too heavy but a system which uses the atmosphere (primarily carbon dioxide) and on-board fuel to power a power generation and cooling system was sought. The resulting design was the Advanced Long-Life Lander Investigating the Venus Environment (ALIVE) Spacecraft (S/C) which burns lithium (Li) with the CO₂ atmosphere to heat a Duplex Stirling to power and cool the lander for a 5 day duration (until the Li is exhausted).

While it does not last years a chemical powered system surviving days eliminates the cost associated with utilizing a flyby relay S/C and allows a continuous low data rate direct to earth (DTE) link in this instance from the Ovda Regio of Venus. The five day collection time provided by the chemical power systems also enables science personnel on earth to interact and retarget science – something not possible with a ~2 hour spacecraft lifetime. It also allows for contingency operations directed by the ground (reduced risk). The science package was based on that envisioned by the Venus Intrepid Tessera Lander (VITaL) Decadal Survey Study.

The Li Burner within the long duration power system creates approximately 14000 W of heat. This 1300 °C heat using Li in the bottom ‘ballast’ tank is melted to liquid by the Venus temperature, drawn into a furnace by a wick and burned with atmospheric CO₂. The Li carbonate exhaust is liquid at 1300°C and being denser than Li drains into the the Li tank and solidifies. Since the exhaust product is a dense liquid no ‘chimney’ is required which conserves the heat for the stirling power convertor. The Duplex Stirling provides about 300 W of power and removes about 300 W of heat from the avionics and heat that leaks into the 1 bar insulated payload pressure vessel kept at 25 °C. The NaK radiator is run to the top of the drag flap.

The ALIVE vehicle is carried to Venus via an Atlas 411 launch vehicle (LV) with a C₃ of 7 km²/s². An Aeroshell, derived from the Genesis mission, enables a direct entry into the atmosphere of Venus (–10°, 40 g max) and 6 m/s for landing (44 g) using a drag ring. For surface science and communication, a 100 WRF, X-Band 0.6m pointable DTE antenna provides 2 kbps to DSN 34 m antenna clusters.

Table 1.1 summarizes the top-level details of each subsystem that was incorporated into the design.

Cost estimates of the ALIVE mission show it at ~ \$760M which puts it into the New Frontiers class.

The ALIVE landed duration is only limited by the amount of Li which can be carried by the lander. Further studies are needed to investigate how additional mass can be carried, perhaps by a larger launcher and larger aeroshell. Other power conversion/cooling systems might also bring other benefits.

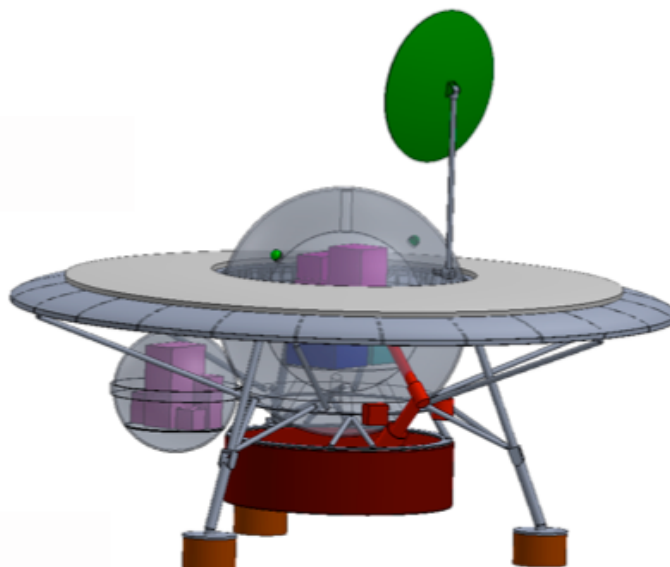

Figure 1.1—ALIVE S/C.

Table 1.1—Mission and S/C Summary for the ALIVE mission

Subsystem area	Details	Total Lander mass with growth (kg)
Top-level system	5-d Venus lander for scientific explorer of Venus, Mass Growth per to AIAA S-120-2006 (add growth to make system level 30%)	
Mission and operations, and Guidance, Navigation and Control (GN&C)	Direct to Venus, genesis aeroshell, parachute to remove aeroshell and backshell	167
Launch	Atlas 411 class	
Science	Landed and descent science packages similar to VITaL 2010 Decadal survey study. Landed science Pan Cam, context imager, and LIBS for in-situ science	47
Power	Li/Atm CO ₂ burner, Duplex Stirling power (300 W _e)/Cooling (300 W-hr), Li tank also used as ballast, sodium-potassium alloy (NaK) radiator placed on drag flag, high temperature sodium-sulfur (NaS) batteries for load leveling	311
Propulsion	Hydrazine monopropellant for RCS and mid course corrections	
Structures and mechanisms	~ 5g launch, 40 g entry and landing loads, all metallic, pressure vessels to handle 90 bar Venus atmospheric pressure	606
Communications	Waveguide with window between the coldbay and external antenna. Omni antennas for telemetry/control during cruise/descent	53
Command and Data Handling (C&DH)	2 kbps data rates for landed science, 1 GB storage, 100 WRF X-band DTE 0.6 m pointable antenna.	30
Thermal	External Venus temps 90 bar/460 °C max, Internal vault pressure/temps 1 bar/ 25 °C max	42

2.0 STUDY BACKGROUND AND ASSUMPTIONS

2.1 Introduction

NIAC has sponsored an effort to evaluate chemical based power systems by keeping a Venus lander alive (power and cooling) for a period of 5 days. The ALIVE S/C consists of three elements: the Cruise Deck, Aeroshell, and Lander.

The Cruise Deck is responsible for housing the hydrazine monopropellant for the reaction control system (RCS) and for mid-course corrections after separating from the Atlas 411 Expendable Launch Vehicle (ELV). The Aeroshell enables a direct entry into the atmosphere of Venus (-10°, 40 g max). The

Aeroshell is jettisoned after the Lander parachute is deployed to allow for a secure landing with the support of a fixed drag flap to reduce the landing velocity. The Lander is designed to operate within a 460 °C (860 °F) environment with a pressure of 93 bar (9,300,000 Pa) while sized to support surface science and communications with the Earth-based DSN for 5 days. Assuming the targeted landing site of Ovda Regio, the science objectives include:

- Correlating high altitude mountain surface reflectivity from radar measurements with surface data
- Investigating mineralogy and weathering of the Venus surface
- Evaluating the past extent of Venus oceans
- Increasing knowledge of Venus weather

From a cost perspective, the drive was to design a S/C that will meet the requirements of a Discovery (\$500M) or New Frontiers (\$780M) class mission.

2.1.1 Background/Past Potential Venus Missions (Needs to be updated and formatted-ces)

Referenced from the VITaL mission concept study report, the Russian Venera Landers utilized lithium nitrate trihydrate (LNT) for phase change material to provide maximum conduction to electronics. There were 10 Venera probes that successfully landed on the surface of Venus and transmitted data between 1964 and 1982 (Balint, Tibor). The U.S. Pioneer Venus mission of 1978 operated similarly to the Venera Landers. Typically, these landers survived for less than an hour on the surface due to the harsh environment. Figure 2.1 shows a variety of probes previously sent to explore Venus.

The VITaL mission from the recent Decadal survey is comparable to the ALIVE science objectives.

Figure 2.2 shows a typical entry, descent, and landing (EDL) timeline for a Venus lander.

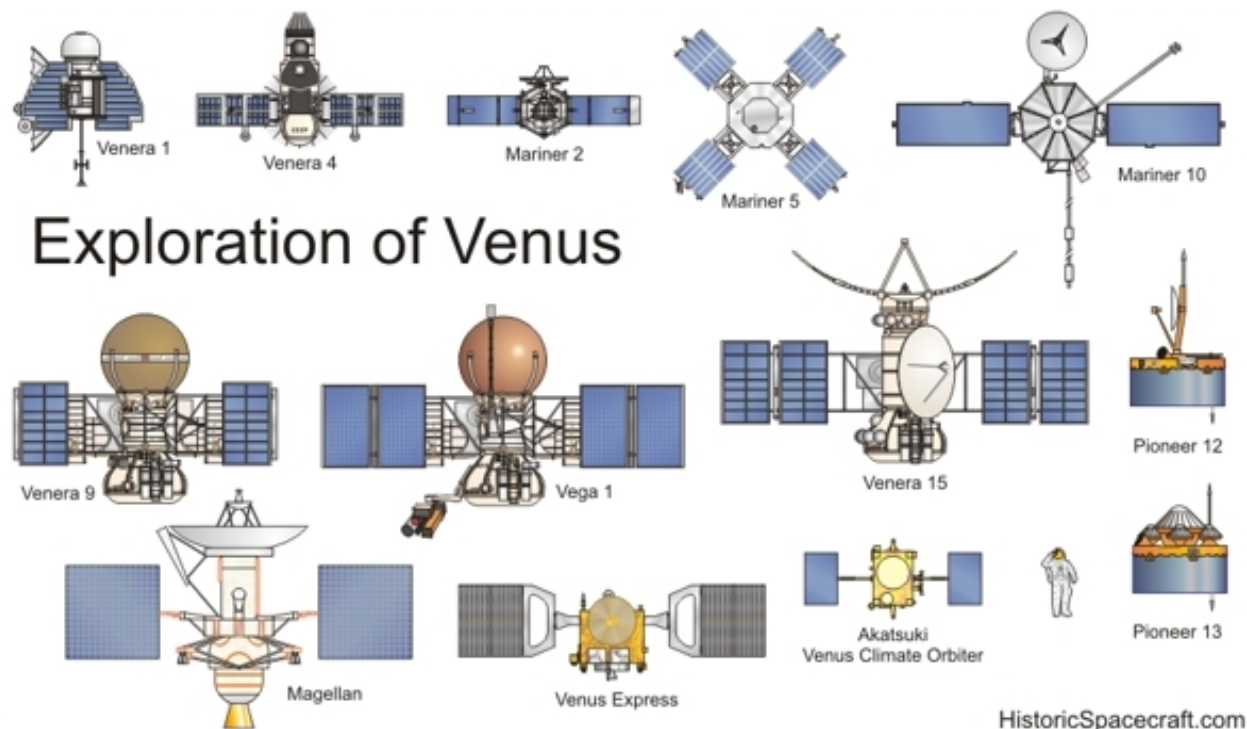

Figure 2.1—Previous Venus space vehicles.

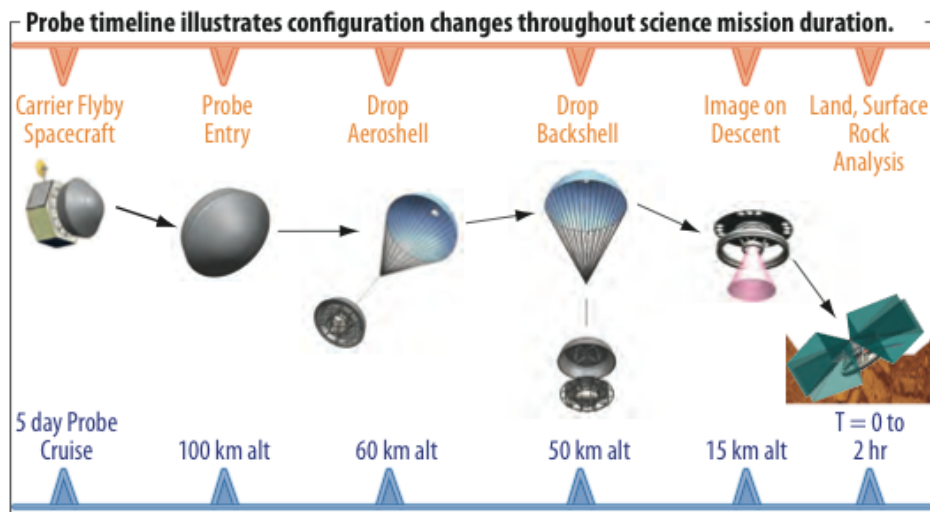

Figure 2.2—Probe 5-d cruise and descent timeline

2.1.2 Report Perspective and Disclaimer

This report is meant to capture the study performed by the COMPASS Team, recognizing that the level of effort and detail found in this report will reflect the limited depth of analysis that was possible to achieve during a concept design session. All of the data generated during the design study is captured within this report in order to retain it as a reference for future work.

2.2 Assumptions and Approach

The harsh environment of Venus provides a number of challenges in the operation of equipment and materials. Operating within this environment, from entry to descent to operation on the surface requires significant thermal control. The atmosphere is composed of mainly CO₂ but does contain corrosive components such as sulfuric acid. The planet has a very thick atmosphere and is completely covered with clouds. The temperature and pressure near the surface is 455 °C at 90 bar.

The Ovda Regio location on Venus was chosen to be the landing and surface science location to maximize communication with Earth, while providing a high altitude for science reflectivity. A Cartesian map of Ovda Regio can be found in Figure 2.3.

The assumptions and requirements about the ALIVE S/C, including those that were known prior to starting the COMPASS design study session, are shown in Table 2.1. This table gathers the assumptions and requirements and calls out trades that were considered during the course of the design study, and off-the-shelf (OTS) materials that were used wherever possible.

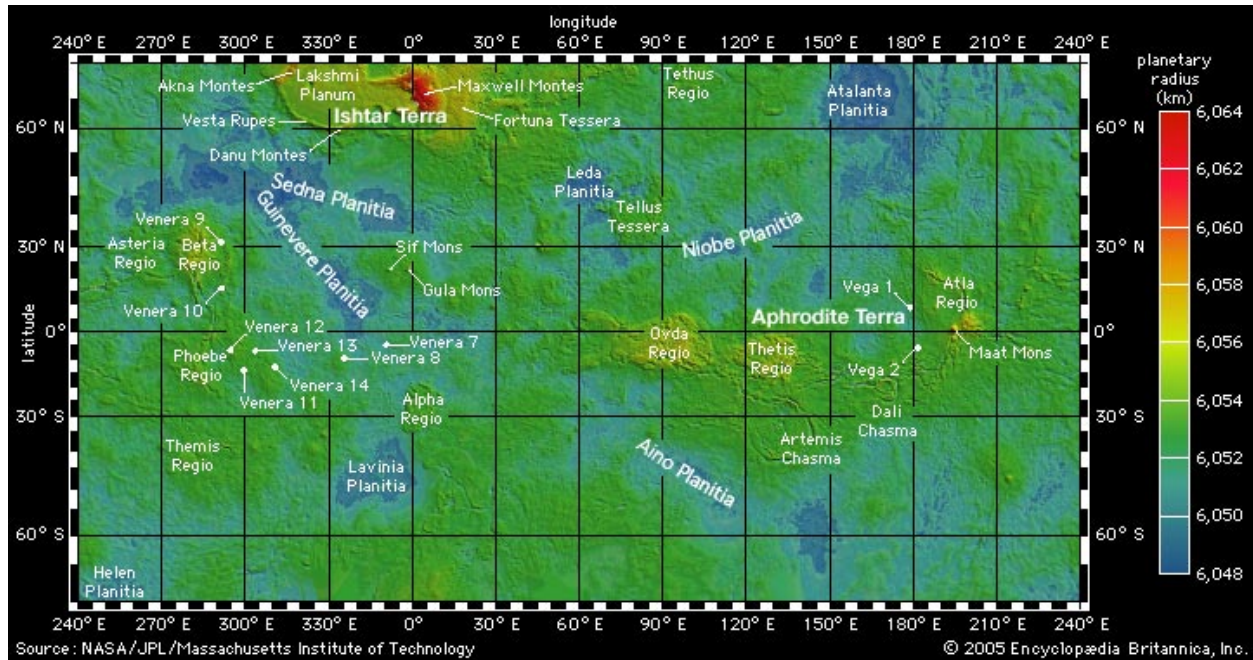

Figure 2.3—Cartesian Map of Ovda Regio.

Table 2.1—Assumptions and Study Requirements

Subsystem area	Requirements/Assumptions	Trades
Top-level	5 day Venus lander for scientific exploration of Venus. Science investigations based on VITaL FOMs: Surface duration, Science collected, Science data returned, Cost	Science approach, duration, fuel
System	Identify new technologies, TRL 6 cutoff 2018, 2022 launch year, single fault tolerant. Earth directed operations for 5 d on Venus surface Mass growth per to AIAA S-120-2006 (add growth to make system level 30%)	
Mission and operations and GN&C	Direct to Venus, $C_3 = 7 \text{ km}^2/\text{s}^2$, -10° entry angle, genesis aeroshell, parachute to remove aeroshell and backshell, fixed drag-flap to slow landing speed to 6 m/s	Parachute descent time, aeroshell sizing, deceleration gs, ballutes. Aeroshell (3.6 m, Genesis derivative) and parachute (descent time) sizing. Parachute separation
LV	Atlas 411 class Launch Loads: Axial $SS \pm 4.5 \text{ g}$, Lateral $\pm 1\text{g}$	
Science	Landed and descent science packages similar to VITaL 2010 Decadal survey study. Descent science in separate pressure vessel to minimize landed pressure vessel (atm spectrometers and imagers). Landed science Pan Cam, context imager, and LIBS for in-situ science	Placement of instruments, number of images
Propulsion	Hydrazine monopropellant for RCS and mid course corrections	Biprop for starting at GTO
Power	Li/Atm CO_2 burner, Duplex Stirling power (300 W_e) / Cooling (300 W_h), Li tank also used as ballast, NaK radiator placed on drag flag, high temperature NaS batteries for load leveling	Brayton or Stirling, Fuel type (Li, MgAl), batteries (NaS), power convertor/cooler
C&DH/ Communications	2 kbps data rates for landed science, 1 GB storage, 100 WRF X-band DTE 0.6 m pointable antenna. Waveguide with window between the coldbay and external antenna. Omni antennas for telemetry/control during cruise/descent	Bluetooth controllers to eliminate feedthroughs, Data storage, MIPS, operating temperature, Pointing, data rate (2 kbps), store/deploy

Subsystem area	Requirements/Assumptions	Trades
Thermal and environment	External Venus temps 90 bar/460 °C max, Internal vault pressure/temps 1 bar/25 °C max. 20 cm aerogel insulation inside internal vault, avionics waste heat and heat leak (~300 Wth) removed with Stirling cooler. 3.6 m Aeroshell base on -10° entry angle and Genesis	Internal pressure (ambient vs 1 atm vs vacuum) and insulation (aerogel or MLI), windows for science and comms, minimize wire feedthroughs, active sterling or passive pre-use of chemical fuel to absorb surface heat in 25°C temperature, aeroshell
Mechanisms	Deployable Legs with crushable pads, deployable, pointable X-band antenna, Aeroshell and cruise deck separations	Number, size of wheels
Structures	~ 5g launch, 40 g entry and landing loads, all metallic, pressure vessels to handle 90 bar Venus atmospheric pressure	What pressure for cold box? Trade 1 bar vs 90 bar S/C, reuse pressure vessel as aeroshell
Cost	New Frontiers Assumptions, 2015 \$	Discovery and New Frontiers assumptions
Risk	Major Risks: high temp mechanisms/gimbals, landing	

2.3 Study Summary Requirements

2.3.1 Figures of Merit

(Provided by System Integration Lead)

The following are the figures of merit (FOM) and/or the elements upon which the design is judged to assess the closure of the study and whether or not the design meets the requirements of the customer:

- **Mass:** Must fit inside an Atlas V 411
- **Launch Date:** 2023 (primary), 2024 (backup)
- **Reliability:** Single fault tolerant (where applicable)
- **Cost:** Discovery or New Frontiers class
- **Effectiveness/applicability/flexibility** of chemical power system
- **Lifetime and survivability** on Venus Surface

2.4 Growth, Contingency, and Margin Policy

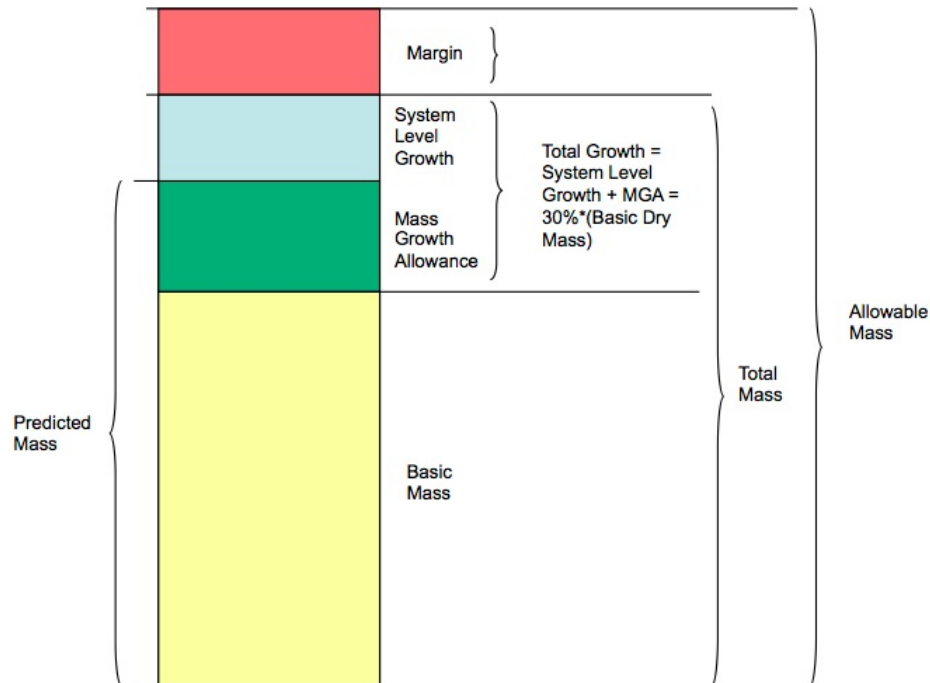

(Basic = bottoms-up estimate of dry mass. Mass growth allowances (MGA) = applied per subsystem line item)

Figure 2.4—Graphical illustration of the definition of basic, predicted, total and allowable mass.

2.4.1 Terms and Definitions

Mass

The measure of the quantity of matter in a body.

Basic Mass (aka CBE Mass)

Mass data based on the most recent baseline design. This is the bottoms-up estimate of component mass, as determined by the subsystem leads.

Note 1: This design assessment includes the estimated, calculated, or measured (actual) mass, and includes an estimate for undefined design details like cables, MLI, and adhesives.

Note 2: The MGA and uncertainties are not included in the basic mass.

Note 3: COMPASS has referred to this as current best estimate (CBE) in past mission designs.

*Note 4: During the course of the design study, the COMPASS Team carries the propellant as line items in the propulsion system in the Master Equipment List (MEL). Therefore, propellant is carried in the basic mass listing, but MGA is **not** applied to the propellant. Margins on propellant are handled differently than they are on dry masses.*

CBE Mass

See Basic Mass.

Dry Mass

The dry mass is the total mass of the system or S/C when no propellant is added.

Wet Mass

The wet mass is the total mass of the system, including the dry mass and all of the propellant (used, predicted boil-off, residuals, reserves, etc.). It should be noted that in human S/C designs the wet masses would include more than propellant. In these cases, instead of

propellant, the design uses Consumables and will include the liquids necessary for human life support.

Inert Mass

In simplest terms, the inert mass is what the trajectory analyst plugs into the rocket equation in order to size the amount of propellant necessary to perform the mission delta-Velocities (ΔV s). Inert mass is the sum of the dry mass, along with any non-used, and therefore trapped, wet materials, such as residuals. When the propellant being modeled has a time variation along the trajectory, such as is the case with a boil-off rate, the inert mass can be a variable function with respect to time.

Basic Dry Mass

This is basic mass (aka CBE mass) minus the propellant or wet portion of the mass. Mass data is based on the most recent baseline design. This is the bottoms-up estimate of component mass, as determined by the subsystem leads. This does not include the wet mass (e.g., propellant, pressurant, cryo-fluids boil-off, etc.).

CBE Dry Mass

See Basic Dry Mass.

MGA

MGA is defined as the predicted change to the basic mass of an item based on an assessment of its design maturity, fabrication status, and any in-scope design changes that may still occur.

Predicted Mass

This is the basic mass plus the mass growth allowance for to each line item, as defined by the subsystem engineers.

Note : When creating the MEL, the COMPASS Team uses Predicted Mass as a column header, and includes the propellant mass as a line item of this section. Again, propellant is carried in the basic mass listing, but MGA is not applied to the propellant. Margins on propellant are handled differently than they are handled on dry masses. Therefore, the predicted mass as listed in the MEL is a wet mass, with no growth applied on the propellant line items.

Predicted Dry Mass

This is the predicted mass minus the propellant or wet portion of the mass. The predicted mass is the basic dry mass plus the mass growth allowance as the subsystem engineers apply it to each line item. This does not include the wet mass (e.g., propellant, pressurant, cryo-fluids boil-off, etc.).

Mass Margin (aka Margin)

This is the difference between the allowable mass for the space system and its total mass. COMPASS does not set a Mass Margin, it is arrived at by subtracting the Total mass of the design from the design requirement established at the start of the design study such as Allowable Mass. The goal is to have Margin greater than or equal to zero in order to arrive at a feasible design case. A negative mass margin would indicate that the design has not yet been closed and cannot be considered feasible. More work would need to be completed.

System-Level Growth

The extra allowance carried at the system level needed to reach the 30% aggregate MGA applied growth requirement.

For the COMPASS design process, an additional growth is carried and applied at the system level in order to maintain a total growth on the dry mass of 30%. This is an internally agreed upon requirement.

Note 1: For the COMPASS process, the total growth percentage on the basic dry mass (i.e. not wet) is:



$$\text{Total Growth} = \text{System Level Growth} + \text{MGA} * \text{Basic Dry Mass}$$

$$\text{Total Growth} = 30\% * \text{Basic Dry Mass}$$

$$\text{Total Mass} = 30\% * \text{Basic Dry Mass} + \text{basic dry mass} + \text{propellants.}$$

Note 2: For the COMPASS process, the system level growth is the difference between the goal of 30% and the aggregate of the MGA applied to the Basic Dry Mass.

$$\text{MGA Aggregate \%} = (\text{Total MGA mass} / \text{Total Basic Dry Mass}) * 100$$

Where Total MGA Mass = Sum of (MGA% * Basic Mass) of the individual components

$$\text{System Level Growth} = 30\% * \text{Basic Dry Mass} - \text{MGA} * \text{Basic Dry Mass} = (30\% - \text{MGA aggregate \%}) * \text{Basic Dry Mass}$$

Note 3: Since CBE is the same as Basic mass for the COMPASS process, the total percentage on the CBE dry mass is:

$$\text{Dry Mass total growth} + \text{dry basic mass} = 30\% * \text{CBE dry mass} + \text{CBE dry mass.}$$

Therefore, dry mass growth is carried as a percentage of dry mass rather than as a requirement for LV performance, etc. These studies are Pre-Phase A and considered conceptual, so 30% is standard COMPASS operating procedure, unless the customer has other requirements for this total growth on the system.

Total Mass

The summation of basic mass, applied MGA, and the system-level growth.

Allowable Mass

The limits against which margins are calculated.

Note: Derived from or given as a requirement early in the design, the allowable mass is intended to remain constant for its duration.

Table 2.2 expands definitions for the MEL column titles to provide information on the way masses are tracked through the MEL used in the COMPASS design sessions. These definitions are consistent with those above in Figure 2.4 and in the terms and definitions. This table is an alternate way to present the same information to provide more clarity.

Table 2.2—Definition of Masses Tracked in the MEL

CBE mass	MGA growth	Predicted mass	Predicted dry mass
Mass data based on the most recent baseline design (includes propellant)	Predicted change to the basic mass of an item phrased as a percentage of CBE dry mass	The CBE mass plus the mass growth allowance (MGA)	The CBE mass plus the mass growth allowance (MGA) — propellant
CBE dry + propellant	MGA% * CBE dry = growth	CBE dry + propellant + growth	CBE dry + growth

2.4.2 Mass Growth

The COMPASS Team normally uses the AIAA S-120-2006, “Standard Mass Properties Control for Space Systems,” as the guideline for its mass growth calculations. Table 2.3 shows the percent mass growth of a piece of equipment according to a matrix that is specified down the left-hand column by level of design maturity and across the top by subsystem being assessed.

The COMPASS Team’s standard approach is to accommodate for a total growth of 30% or less on the dry mass of the entire system. The percent growth factors shown above are applied to each subsystem before an additional growth is carried at the system level, in order to ensure an overall growth of 30%. Note that for designs requiring propellant, growth in the propellant mass is either carried in the propellant calculation itself or in the ΔV used to calculate the propellant required to fly a mission.

The system-integration engineer carries a system-level MGA, called “margin”, in order to reach a total system MGA of 30%. This is shown as the mass growth for the allowable mass on the authority to precede line in mission time. After setting the margin of 30% in the preliminary design, the rest of the steps shown below are outside the scope of the COMPASS Team.

Table 2.3—MGA and Depletion Schedule (AIAA S-120-2006)

Major category	Maturity code	Design maturity (basis for mass determination)	MGA (%)												
			Electrical/electronic components			Structure	Brackets, clips, hardware	Battery	Solar array	Thermal control	Mechanisms	Propulsion	Wire harness	Instrumentation	ECLSS, crew systems
			0 to 5 kg	5 to 15 kg	>15 kg										
E	1	Estimated (1) An approximation based on rough sketches, parametric analysis, or undefined requirements; (2) A guess based on experience; (3) A value with unknown basis or pedigree	30	25	20	25	30	25	30	25	25	25	55	55	23
	2	Layout (1) A calculation or approximation based on conceptual designs (equivalent to layout drawings); (2) Major modifications to existing hardware	25	20	15	15	20	15	20	20	15	15	30	30	15
C	3	Prerelease designs (1) Calculations based on a new design after initial sizing but prior to final structural or thermal analysis; (2) Minor modification of existing hardware	20	15	10	10	15	10	10	15	10	10	25	25	10
	4	Released designs (1) Calculations based on a design after final signoff and release for procurement or production; (2) Very minor modification of existing hardware; (3) Catalog value	10	5	5	5	6	5	5	5	5	5	10	10	6
A	5	Existing hardware (1) Actual mass from another program, assuming that hardware will satisfy the requirements of the current program with no changes; (2) Values based on measured masses of qualification hardware	3	3	3	3	3	3	3	2	3	3	5	5	4
	6	Actual mass Measured hardware	No mass growth allowance—Use appropriate measurement uncertainty values												
	7	Customer furnished equipment or specification value	Typically a “not-to-exceed” value is provided; however, contractor has the option to include MGA if justified												

2.4.3 Power Growth (Needs to be updated-ces)

The COMPASS Team typically uses a 30% margin on the bottoms-up power requirements of the bus subsystems when modeling the amount of required power. Table 3.5 (Section 3.1.3) shows the power system assumptions specific to this design study.

2.5 Mission Description

The baseline mission is a launch on May 18, 2023, direct from Earth to Venus. The mission does not require any deterministic post launch ΔV and only requires a launch energy of 6.2 km²/s². The interplanetary transit is 160 d and arrives on October 24, 2023, with an arrival V_∞ of approximately 4 km/s.

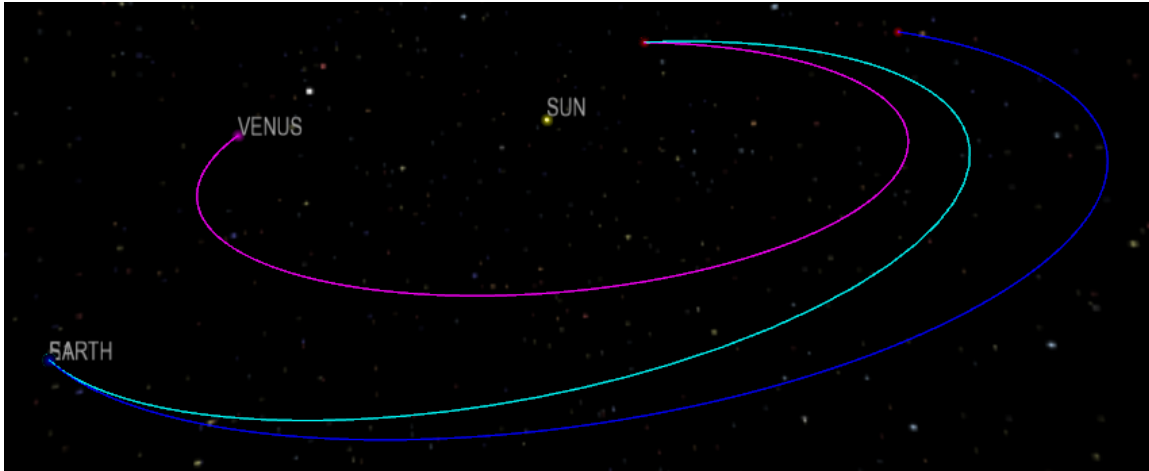

Figure 2.5—Trajectory graphic. Best case ALIVE opportunity.

2.5.1 Mission Analysis Assumptions

The data provided from mission is prior to performance margin consideration. An additional 10% of LV performance will be decremented at the system level. Because there are no deep space maneuvers, no additional margin is included.

2.5.2 Mission Trades

The mission evaluation included a performance assessment over potential launch opportunities from 2020 to 2025. Because the transfer to Venus does not require deterministic post launch ΔV , the launch energy is the only driver in Venus arrival mass capability. Over the launch window, the higher performance launch opportunity and backup dates are May 18, 2023, and December 25, 2024. The S/C and LV capability must be constrained to accommodate either opportunity. May 18, 2023, is the first and therefore baseline mission, however; the LV capability must accommodate the slight energy increase for the backup. The primary and backup missions are illustrated in Figure 2.6.

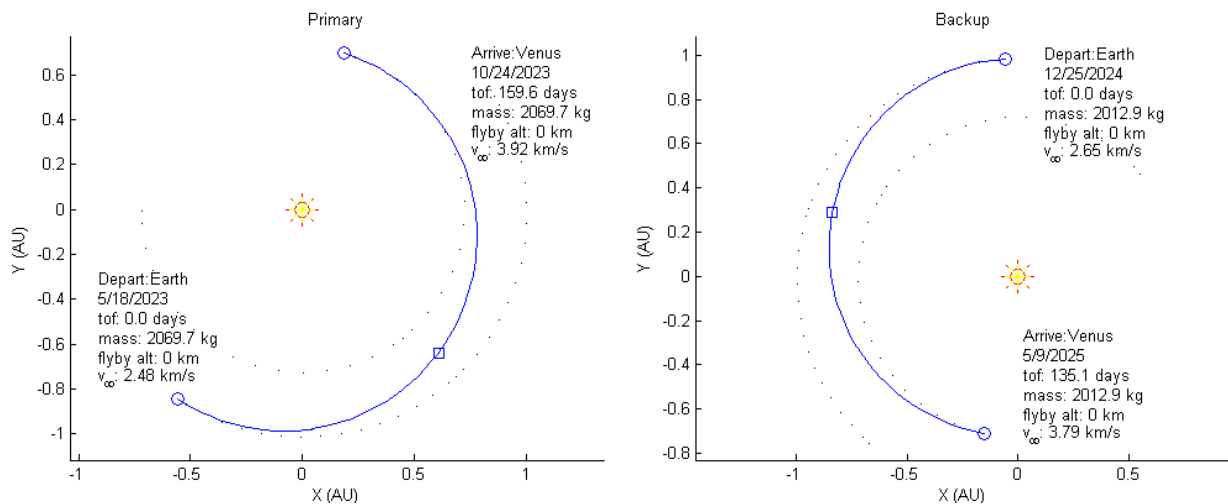

Figure 2.6—Primary and backup mission opportunities.

The examples in Figure 2.6 are for a Falcon 9 Block 2, however; the required launch energy is independent of the LV. The goal was to fit the S/C onto a Falcon 9. Unfortunately the final arrival mass requirements moved the mission onto an EELV class vehicle. The performance of the LV options considered is shown in Table 2.4. The length of the launch window was also evaluated. A 2-week launch window can be accommodated with a launch energy margin of only $0.1 \text{ km}^2/\text{s}^2$ and a 3-wk launch window

can be accommodated with launch energy margin of $0.5 \text{ km}^2/\text{s}^2$; $6.65 \text{ km}^2/\text{s}^2$ is required for the baseline launch energy with a 3-wk launch window.

Table 2.4—LV performance versus launch energy of interest.

C ₃ , km ² /s ²	Launch mass (kg)		
	Falcon 9	Atlas V 401	Atlas V 411
5	2145	2720	3550
7	2015	2600	3400
9	1890	2480	3255
11	1765	2365	3115
13	1650	2255	2980
15	1540	2145	2845

The launch energy for the primary and backup missions is 6 to 7 km^2/s^2 , however; an option to launch with higher launch energy to minimize the arrival energy was also explored. The baseline mission has an arrival energy of $15.4 \text{ km}^2/\text{s}^2$, the highest of any mission option. There is a small range where the arrival launch energy can be reduced while still requiring no deep space maneuvers. Minimizing the arrival energy will change the launch opportunity slightly. Because the mission did not close on a Falcon 9, there is significant margin and virtually no penalty in launching to the higher C₃ and reducing the entry system requirements. An example solution minimizing the arrival energy is shown in Figure 2.7.

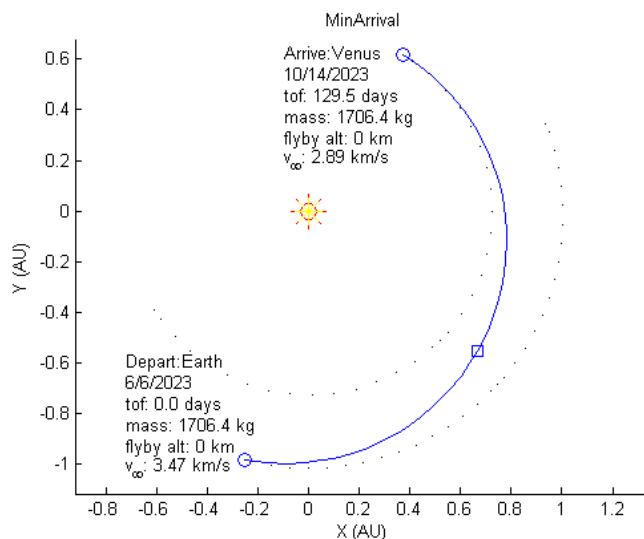

Figure 2.7—Minimum arrival energy solution.

Another option evaluated but not selected was to use a lunar gravity assist (LGA) in order to attempt to stay on the Falcon 9 (Figure 2.8). The only viable option to reduce the LV requirement for a trajectory to Venus is to launch to a negative C₃ and leverage an LGA. Using a launch energy less than escape and performing maneuvers for the LGA and powered deep gravity well burn at Earth, the delivered mass capability of the Falcon 9 can be increased. The LGA does increase the Falcon 9 capability from ~2,000 kg to over 2,500 kg to Venus, it does require a large propulsion system. It was preferred to baseline a larger and higher cost LV rather than accept the increased S/C complexity and cost.

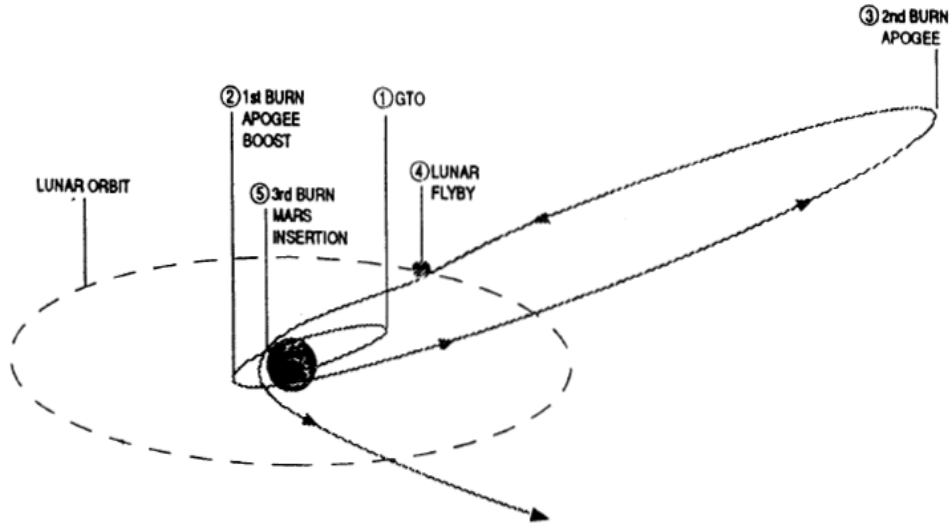

Figure 2.8—Example LGA option to reduce launch energy requirements. (Note: This is a Mars example.)

2.5.3 Mission ΔV Details

Table 2.4 shows a ΔV summary throughout the mission. The vast majority of the ΔV is used for trajectory correction maneuvers (TCM). Analysis of the amount of ΔV used by the MESSENGER S/C revealed that less than 40 m/s of ΔV was used before the S/C first flew by Venus on its way to Mercury, hence it was assumed that ALIVE would need roughly 40 m/s of ΔV for TCMs on its way to Venus. An Isp of 220 s was assumed for the propulsion system.

Table 2.5—Mission ΔV Summary for the ALIVE S/C

Phase no.	Phase name	ΔV (m/s)	Pre burn mass (kg)	Prop used (kg)	Post burn mass (kg)
1	Null tip-off rates	1	2478	1.1	2477
2	TCM 1	20	2477	22.9	2454
3	TCM 2	20	2454	22.6	2431
4	Spin-up	2	2431	2.3	2429
5	Separation	2	232	0.2	232

Table 2.6—Additional Mission Analysis

Insert table here

2.5.4 Mission Analysis Analytic Methods

For the mission design of the ALIVE mission, both Mission Analysis Low-Thrust Optimization (MALTO) and Copernicus were used for trajectory design. The MALTO program was used in ΔV mode for ballistic trajectory optimization. MALTO can only be used for the interplanetary mission design. Copernicus was also used for minimum ΔV optimization of the interplanetary transfer and landing site targeting.

2.5.5 Concept of Operations (CONOPS)

(1) Pre-Launch Ops and Cruise to Venus

ALIVE will be launched from the NASA Kennedy Space Center (KSC) on an Atlas V 411, which will carry all the elements necessary for the mission. The launch date for the analysis is May 18, 2023. Payload will be switched to internal power 5 min before liftoff and will remain on battery power until solar array deployment at approximately 1.5 hr MET.

There is the potential for launch safety concerns due to the presence of solid Li, which is needed for the payload's Stirling engine operation. These concerns will need to be identified and addressed separately, but given the experience of the U.S. Navy in successfully handling solid Li/Rankine torpedo systems we do not foresee any insurmountable difficulties.

The Atlas upper stage will put ALIVE on a trans-Venus injection trajectory roughly 1.5 hr after liftoff. The solar arrays will then be deployed, allowing the S/C to generate its own power. ALIVE will immediately go through a complete vehicle assessment and the first of several instrument testing and calibration sessions. Communications with DSN during the cruise portion of the mission will be through the X-Band omni directional antennas located on the S/C aeroshell. Two hydrazine tanks and 16 thrusters will provide RCS propulsion and control.

The cruise to Venus will last 159.6 d.

(2) Arrival, Entry, Separation, and Lander Descent

At Entry-20 min (E -20 min) the ALIVE S/C will be maneuvered to entry-attitude and the Lander's beacon turned on. Shortly after, the descent instruments will be activated for science mode.

At E -15 min the vehicle will be spun-up to 12 rpm, 5 min later the Lander will separate from the cruise deck, which will subsequently begin a divert burn collision avoidance maneuver (CAM).

Communications with DSN will still be performed through the aeroshell X-band omni antennas. The Lander will go beacon-only as it enters the Venus atmosphere at an angle of -8.7° and an altitude of ~ 200 km.

At about 90 km altitude, or 1.6 min after entry, ALIVE begins its descent science operations. At 65 km the subsonic parachute is deployed and the heat shield is released. Immediately after, the landing legs of the Lander are deployed. The parachute is released 20 min after deployment and the aeroshell departs with it. Communication with DSN is now through the X-Band omni directional antennas located on the Lander.

After approximately 70 min of free-fall, ALIVE will land on the Venus surface, at less than 10 m/s and ~ 40 g's.

(3) Descent Science

After entering the Venus atmosphere, and starting at about 90 km altitude, the Lander descent science instruments begin operating and storing data. This portion of the mission will last about 1.5 hr. The descent data is scheduled for transmission back to Earth during landed operations.

For this analysis we assumed four principal science instruments used during descent:

- *Atmospheric Structure Investigation (ASI)*.—Starting at 90 km altitude, the ASI will make ten 12-b measurements every 10 m, for a total of 1.1 Mb of data, compressed at 10:1
- *Neutral Mass Spectrometer (NMS)*.—The NMS begins gathering data at 30 km and will do 300 measurements before landing, capturing 1.8 Mb of data
- *Tunable Laser Spectrometer (TLS)*.—Beginning also at 30 km the TLS will also do 300 measurements during descent, or 3.6 Mb of data.
- *Descent Imager* – Used only during the last 10 km of descent, it will capture 20 images for a total of 96 Mb of data (LOCO compressed)

The expected total science data volume gathered by these instruments during descent should be approximately 105 Mb.

(4) Early Landed Operations

ALIVE is designed to operate for 5 consecutive days (or 120 hr) after landing on the surface of Venus.

The first major operation is the ignition of the Lithium Duplex Sterling (LiDS) engine, which we assume will take 2 hr. After that ALIVE will deploy its high gain antenna and begin its Earth access routine. Once high rate communication has been established, the first 55 Mb batch of descent data will be sent to Earth,

at 2 kbps. This operation will take 7.6 hr. The rest of the descent data will be sent later on bundled with the landed science data.

(5) Landed Science

ALIVE will toggle between periods of science data gathering (6 hr/d) and periods of data transmission back to Earth (18 hr/d).

ALIVE is designed to send 130 Mb of data per day. Assuming 2 hr for the LiDS activation and 7.6 hr for the initial descent data transmission, ALIVE should have four full periods of landed science, and four full periods of data transmission. By necessity, the last science/transmission cycle will be shorter: one period of science lasting approximately 3.5 hr, followed by a transmission period of close to 11 hr.

For this phase of the mission we assumed four main instruments:

- *Raman/Laser Induced Breakdown Spectroscopy (LIBS).*—The LIBS is re-pointable by Earth command. The current design allows for 12 samples, each 12 Mb, expected total of 62.4 Mb is to be gathered.
- *Panoramic Camera (Pan Cam).*—The Pan Cam is expected to make two eight-frame panoramas, for a total of 308 Mb of data.
- *Context Imager.*—Expected to capture 12 images at 20 Mb each, with an expected total of 220 Mb
- *Meteorology Data (ASI).*—Should operate at 1 bps for the duration of the science periods (27.6 hr) and a total of 100 Kb

(6) End of Mission

Figure 2.9 provides a graphical illustration of the ALIVE EDL operations.

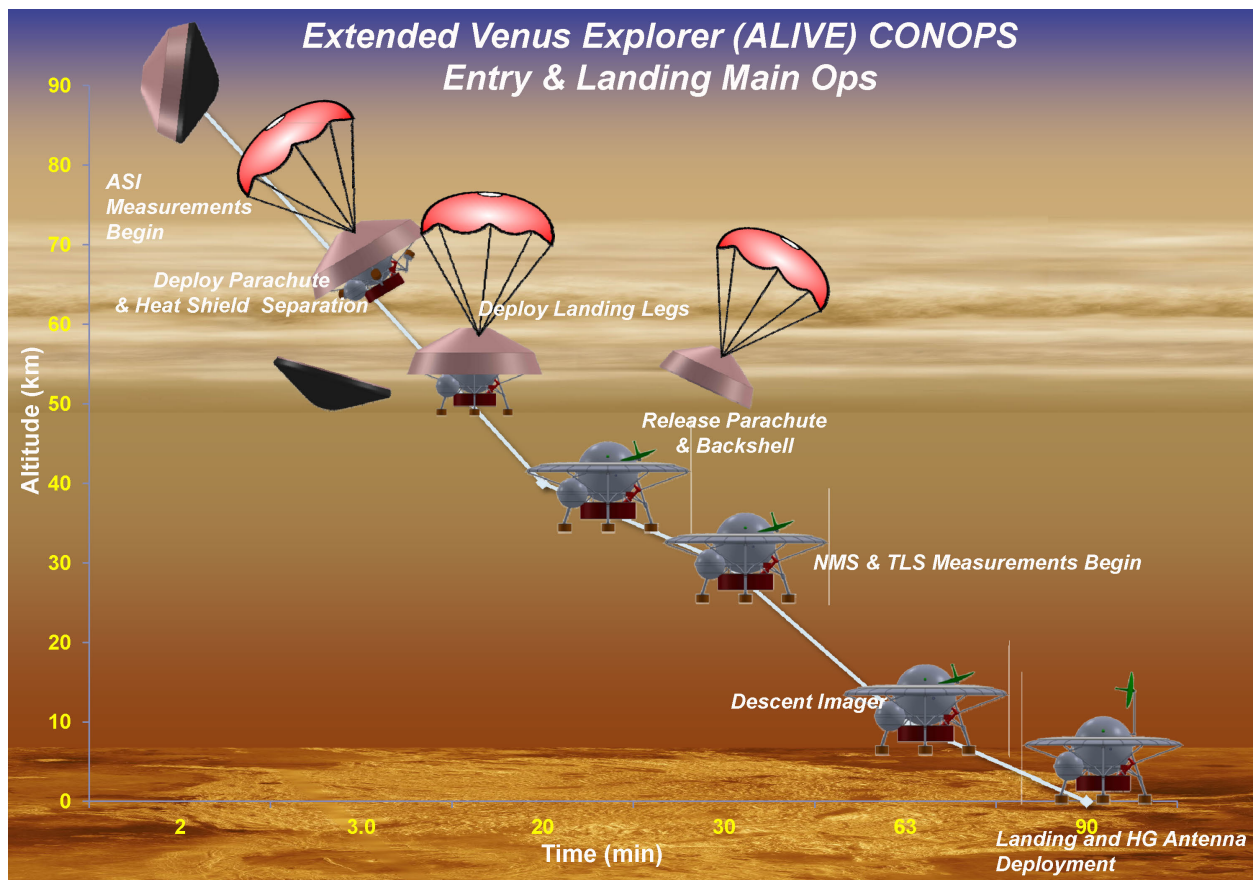

Figure 2.9—ALIVE EDL operations.

2.5.6 Mission Communications Details

The distance between the Earth and S/C is increasing from launch until arrival. At arrival, the S/C (and Venus) are 0.7 AU apart. The Earth-Probe distance is shown in Figure 2.10(a). The Sun-Earth-Probe and Sun-Probe-Earth angles are shown in Figure 2.10(b).

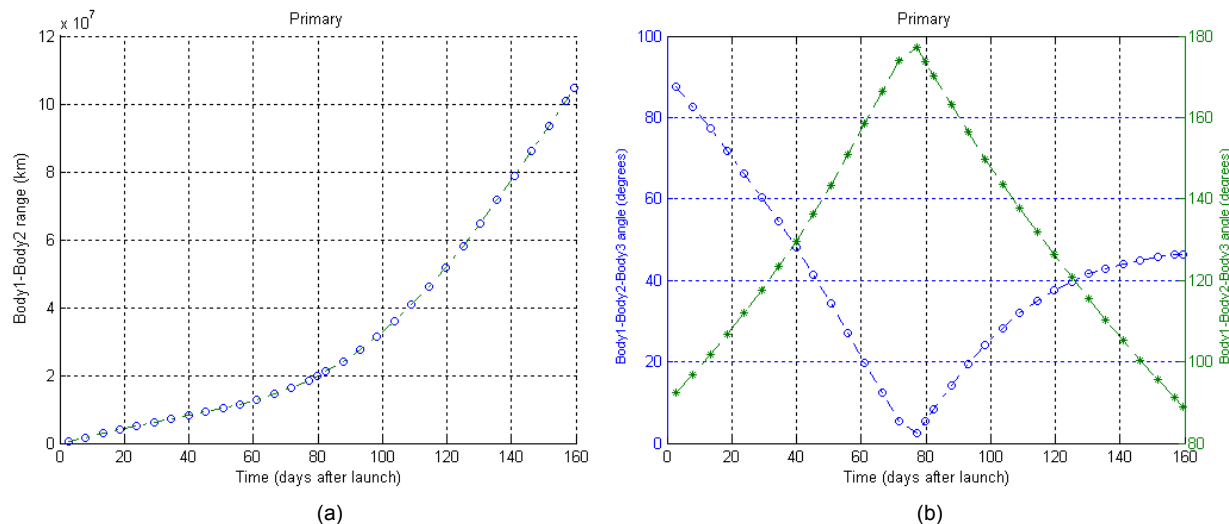

Figure 2.10—Earth-Probe distance (a) and SEP and SPE angles (b).

Communication analysis during the surface stay was performed using the Satellite Orbit Analysis Program (SOAP) (Figure 2.11).

- Ovda Regio (-2.8° S, 85.6° E) was the location selected for this mission to support interesting science and increase communication opportunities with the Earth-bound DSN satellites
- October 24, 2023, is the primary Venus arrival date selected for the mission due to LV performance and Venus to Earth communication availability from the Ovda Regio location
- The ALIVE mission is currently planned to generate science data for 5 days.
- Communications from Ovda Regio to the Earth DSN sites is almost continuous for the 5 day period.
- The SOAP analysis assumes that during a communication period :
 - The Sun is in View from Ovda Regio and Earth
 - The elevation angle from the surface of Ovda Regio to Earth is $> 20^\circ$
 - The elevation angle from the surface of Earth’s DSN’ satellites are $> 20^\circ$
- This prevents mountainous terrain from interfering with ALIVE science

At least one DSN site is in view from Ovda Regio

- The communications system was sized to account for a range of 0.74 AU ($\sim 112,000,000$ km) from Ovda Regio to Earth for the 5 day mission.
- In the event that the mission was extended, additional opportunities would be available.

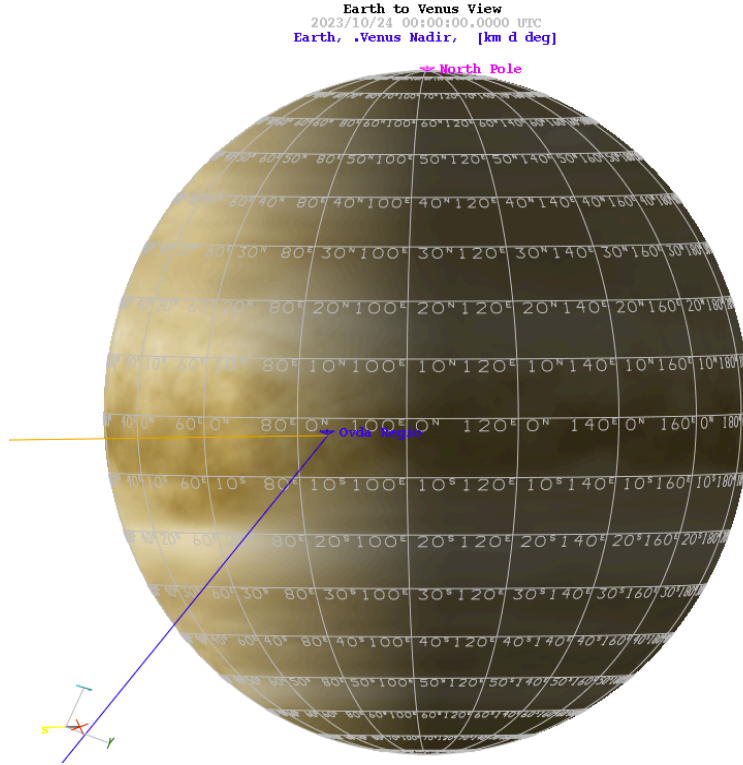

Figure 2.11—SOAP communications analysis.

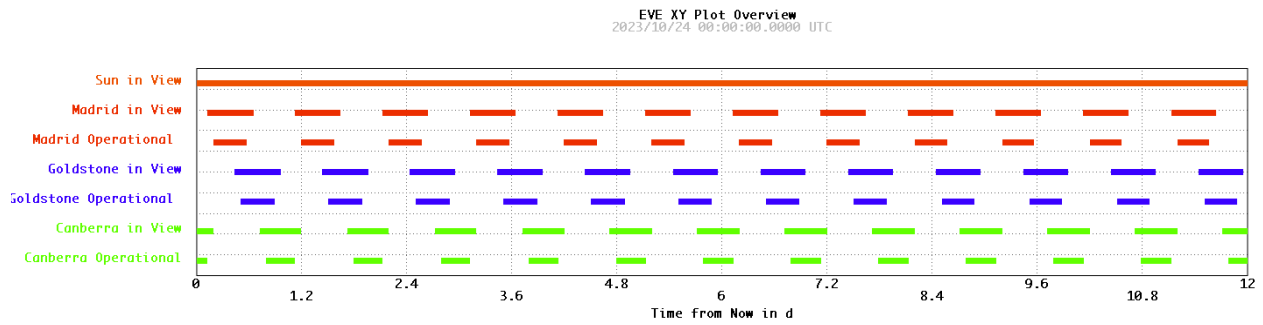

Figure 2.12—Need caption

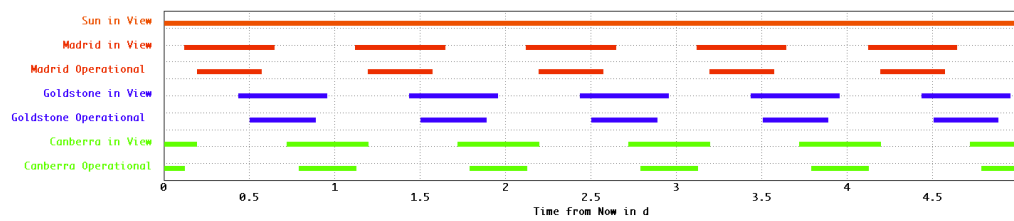
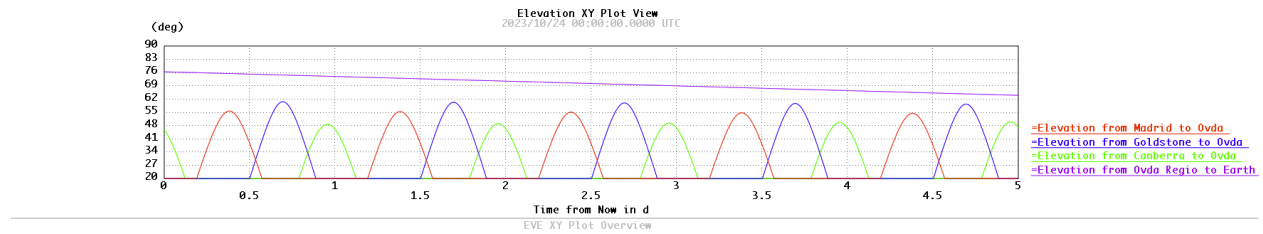

Figure 2.13—Need caption

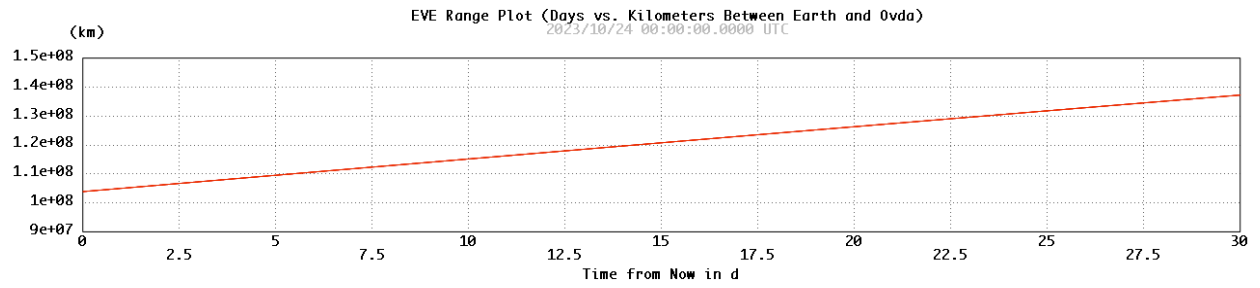

Figure 2.14—

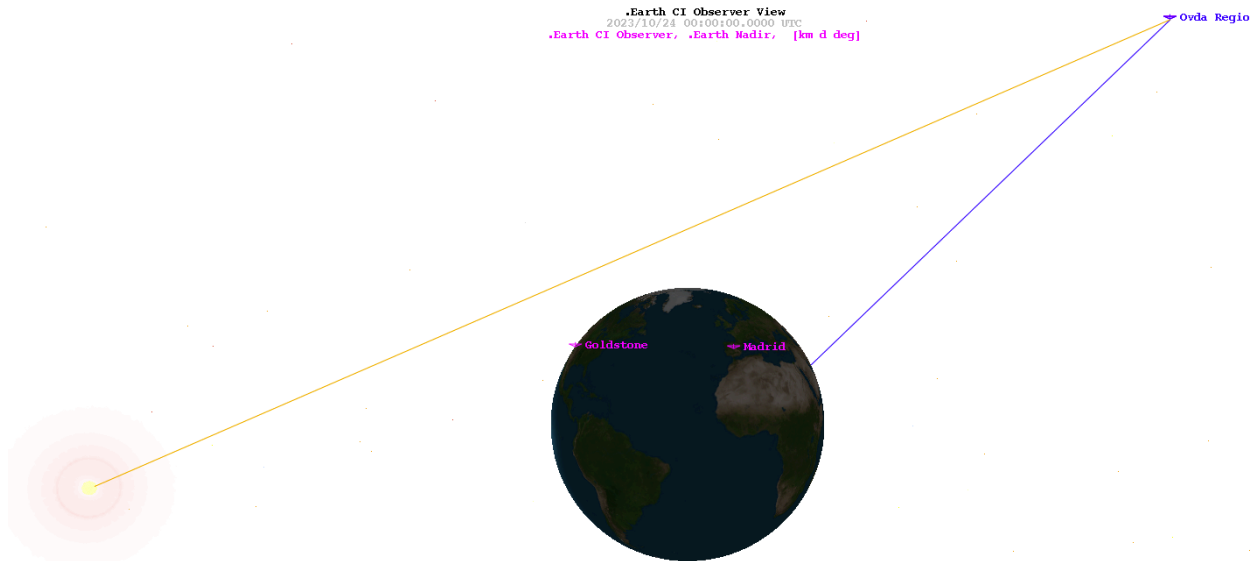

Figure 2.15—

(This data is included when the mission trajectory will take the S/C far from the Earth and the communication system needs accurate distances.)

2.6 LV Details

NASA ELV performance estimation curve(s)
High energy orbits

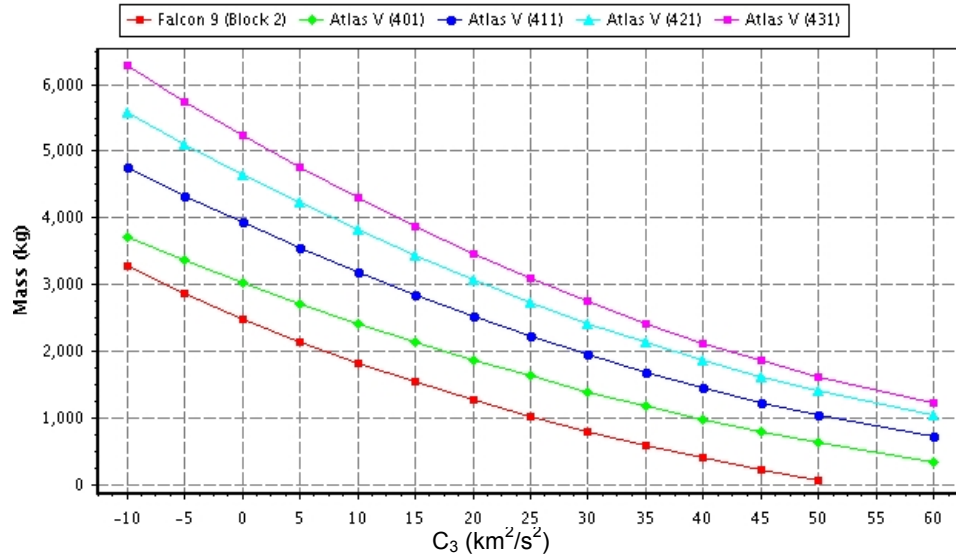

Figure 2.16—

2.6.1 Payload Fairing Configuration

The ALIVE Lander was configured to launch atop an Atlas V 411 (performance shown in Table 2.4), inside of the 4-m LPF fairing and is required to be fully encapsulated inside an aeroshell in order to enter the Venus atmosphere. Due to encapsulation inside the aeroshell, a cruise deck is required to provide power, propulsion, and GN&C for the transit from Earth to Venus. This cruise deck will also provide the interface between the payload adaptor and aeroshell. For launch mass purposes, a C22/type D1666 Payload Adaptor (PLA) stack was assumed. Due to time constraints during the study, a CAD model of the cruise deck was not laid out. However, a cruise deck was sized by the COMPASS Team in order to obtain a mass to ensure the overall system mass fit within the LV capability as well as provide accurate mission analysis. Based on the COMPASS Team sizing, there do not appear to be any major configuration issues with the cruise deck.

The aeroshell used in this design was based on the outer mold line of the aeroshell used for the Genesis mission. Both the backshell and heat shield were scaled up to obtain a maximum external diameter of 3.6-m. This diameter provides sufficient volume inside the aeroshell for the Lander, and allows the aeroshell to fit within the 3.65-m diameter static envelope associated with the 4-m fairing. The overall dimensions of the aeroshell can be seen in Figure 2.17.

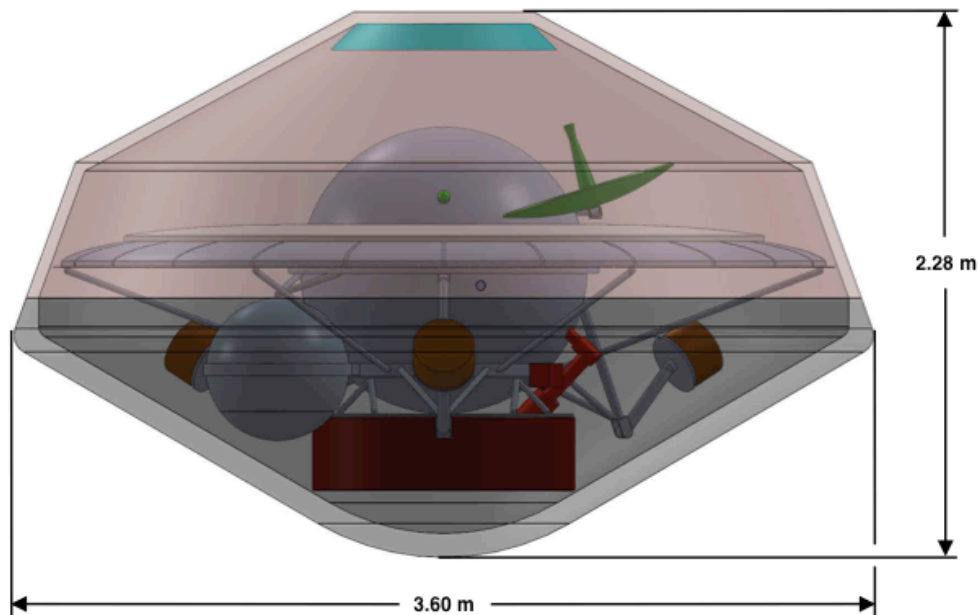

Figure 2.17—ALIVE Lander aeroshell dimensions.

In order for the ALIVE Lander to fit within the envelope of the aeroshell, several components needed to be stowed for the launch and cruise phases of the mission. These components include the three landing legs and the 0.75-m diameter X-band dish antenna and boom. The landing legs utilize a spring-lock mechanism for deployment, and are folded upwards when stowed, allowing the lower portion of the landing leg and the landing pads to fit within the envelope of the heat shield. The landing legs will be deployed just after the heat shield is jettisoned upon deployment of the parachute (stowed in the top of the backshell). The X-band antenna boom is stowed in a horizontal position, while the dish utilizes its 2-axis gimbal to position it so that it fits within the envelope of the aeroshell. Both are tied down to the large drag flap structure (discussed in Section 3.3) for launch. A single mechanism at the base of the boom is used to rotate it 90° to a vertical position upon landing on the surface of Venus. The boom is approximately 0.85-m in length, allowing the antenna to gimbal freely in two axes without any physical interference or blockage of the beam.

Two isometric views of the ALIVE Lander inside the aeroshell can be seen in Figure 2.18 while the deployment sequence for the landing legs and X-band antenna can be seen in Figure 2.19. Additional images of the stowed ALIVE Lander can be found in Appendix B.

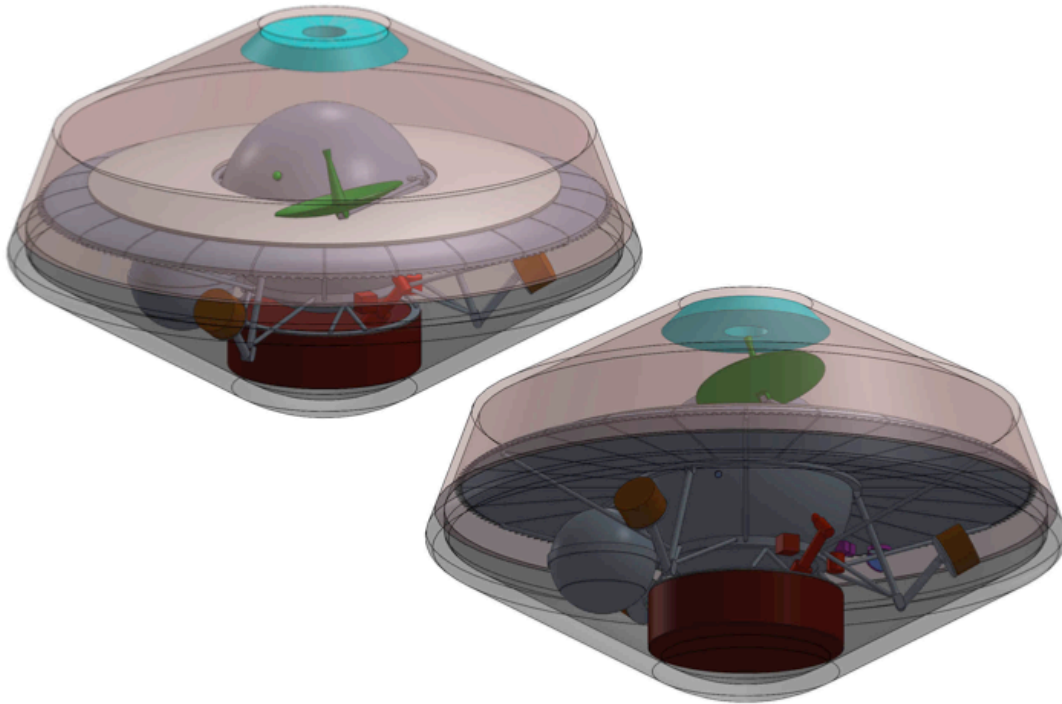

Figure 2.18—Isometric views of the ALIVE Lander inside the aeroshell.

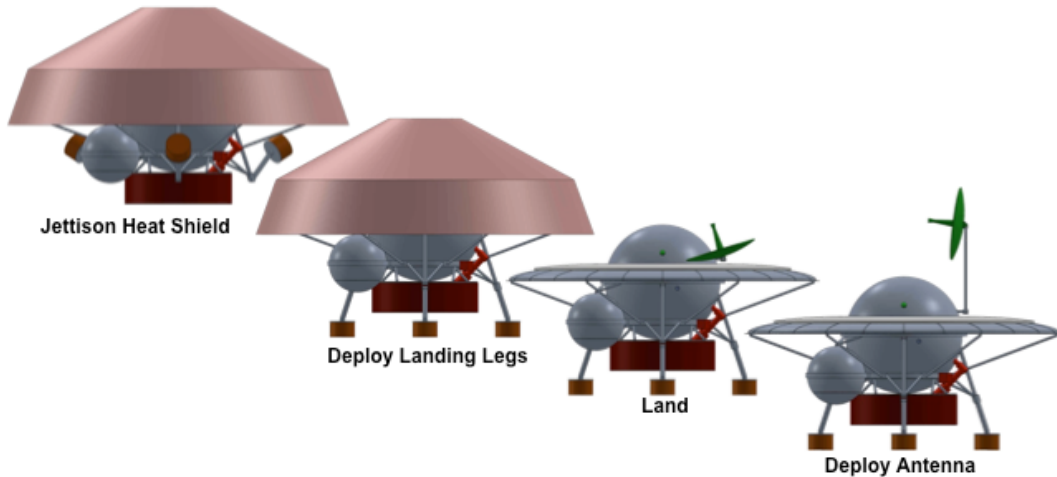

Figure 2.19—Landing legs and X-band antenna deployment sequence.

3.0 BASELINE DESIGN

3.1 Top-Level Design

3.1.1 Master Equipment List (MEL)

The Cruise Deck, Aeroshell, and Lander together are required to fit inside of the same physical Atlas V 411 LV along with fitting inside a total mass allocation as a requirement for this analysis. The theory behind the design of the MEL for this study is shown in Figure 3.1. The impacts of structure, performance, and thermal are common to the elements of the ALIVE S/C.

ALIVE External Components

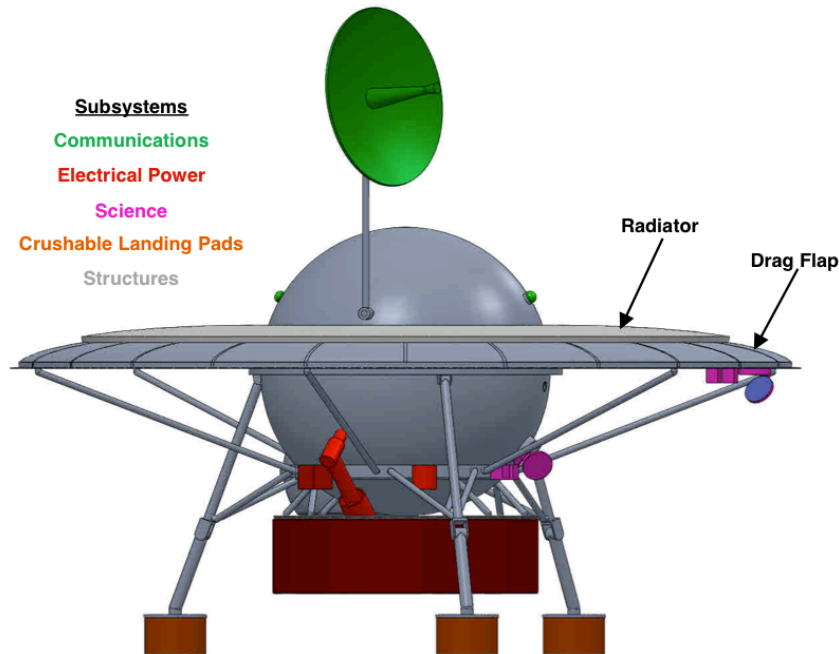

Figure 3.1—ALIVE design approach.

Therefore, the MEL lists these three major elements in terms of the major subsystems within them. The ALIVE S/C, previously named the Extended Venus Explorer (EVE), is listed as work breakdown structure (WBS) Element 06. The Lander itself is listed in the MEL as WBS Element 06.1. The Aeroshell, is listed as WBS Element 06.2, and the Cruise Deck is listed as WBS Element 06.3 respectively. Table 3.1 shows the MEL listing of the Lander, Aeroshell, and Cruise Deck as the three elements of the ALIVE S/C designed by the COMPASS Team and documented in this study.

Table 3.1—ALIVE MEL WBS Format

WBS	Description	QTY	Unit Mass	Basic Mass	Growth	Growth	Total Mass
Number	Case 1 NIAC Venus Spacecraft CD-2012-72		(kg)	(kg)	(%)	(kg)	(kg)
06	Extended Venus Explorer Spacecraft Design			1917.94	16.1%	308.47	2226.41
06.1	Lander			1079.92	16.4%	177.57	1257.49
06.1.1	Science			39.80	18.7%	7.45	47.25
06.1.2	Attitude Determination and Control			142.61	17.4%	24.75	167.36
06.1.3	Command & Data Handling			22.60	33.0%	7.47	30.07
06.1.4	Communications and Tracking			47.71	10.9%	5.20	52.91
06.1.5	Electrical Power Subsystem			277.50	12.2%	33.77	311.27
06.1.6	Thermal Control (Non-Propellant)			35.79	18.0%	6.44	42.23
06.1.11	Structures and Mechanisms			513.91	18.0%	92.50	606.42
06.2	Aeroshell			608.77	18.0%	109.47	718.24
06.2.2	Attitude Determination and Control			54.23	18.0%	9.76	63.99
06.2.4	Communications and Tracking			1.40	10.0%	0.14	1.54
06.2.6	Thermal Control (Non-Propellant)			371.29	18.0%	66.83	438.13
06.2.11	Structures and Mechanisms			181.85	18.0%	32.73	214.58
06.3	Cruise Deck			229.25	9.4%	21.44	250.69
06.3.2	Attitude Determination and Control			3.44	3.0%	0.10	3.54
06.3.3	Command & Data Handling			7.50	14.0%	1.05	8.55
06.3.5	Electrical Power Subsystem			33.00	3.0%	1.00	34.00
06.3.6	Thermal Control (Non-Propellant)			10.34	18.0%	1.86	12.20
06.3.7	Propulsion (Chemical Hardware)			30.52	5.2%	1.58	32.10
06.3.8	Propellant (Chemical)			56.43	0.0%	0.00	56.43
06.3.11	Structures and Mechanisms			88.01	18.0%	15.84	103.86

The Lander, Aeroshell, and Cruise Deck sections of the MEL starts at WBS 06.1, WBS 06.2, WBS 06.3, and opens down to the subsystem level, as shown in Table 3.2. The Lander science instruments can be found within WBS 06.1.1, and discussed in Section 5.1.

3.1.2 S/C Total Mass Summary

The system-level summary for the baseline case, which includes the additional system-level growth, is shown in Table 3.2. In order to reach the 30% total system level growth on the basic mass of the S/C required for this study, MGA and system level growth was calculated for each individual subsystem within the three elements.

Table 3.2—ALIVE System Summary

WBS	Main Subsystems	Basic Mass (kg)	Growth (kg)	Total Mass (kg)	Aggregate Growth (%)
06	Extended Venus Explorer (EVE) Spacecraft	1917.9	308.5	2226.4	
06.1	Lander	1079.9	177.6	1257.5	16%
06.1.1	Science	39.8	7.4	47.2	19%
06.1.2	Attitude Determination and Control	142.6	24.7	167.4	17%
06.1.3	Command and Data Handling	22.6	7.5	30.1	33%
06.1.4	Communications and Tracking	47.7	5.2	52.9	11%
06.1.5	Electrical Power Subsystem	277.5	33.8	311.3	12%
06.1.6	Thermal Control (Non-Propellant)	35.8	6.4	42.2	18%
06.1.7	Propulsion (Chemical Hardware)	0.0	0.0	0.0	
06.1.8	Propellant (Chemical)	0.0		0.0	
06.1.9	Propulsion EP Hardware)	0.0	0.0	0.0	
06.1.10	Propellant (EP)	0.0		0.0	
06.1.11	Structures and Mechanisms	513.9	92.5	606.4	18%
System Level Growth Calculations _Lander					Total Growth
	Dry Mass Desired System Level Growth	1080	324	1404	30%
	Additional Growth (carried at system level)		146		14%
	Total Wet Mass with Growth	1080	324	1404	
06.2	Aeroshell	608.8	109.5	718.2	18%
06.2.1	Science	0.0	0.0	0.0	
06.2.2	Attitude Determination and Control	54.2	9.8	64.0	18%
06.2.3	Command and Data Handling	0.0	0.0	0.0	
06.2.4	Communications and Tracking	1.4	0.1	1.5	10%
06.2.5	Electrical Power Subsystem	0.0	0.0	0.0	
06.2.6	Thermal Control (Non-Propellant)	371.3	66.8	438.1	18%
06.2.7	Propulsion (Chemical Hardware)	0.0	0.0	0.0	
06.2.8	Propellant (Chemical)	0.0		0.0	
06.2.9	Propulsion EP Hardware)	0.0	0.0	0.0	
06.2.10	Propellant (EP)	0.0		0.0	
06.2.11	Structures and Mechanisms	181.8	32.7	214.6	18%
System Level Growth Calculations _ Aeroshell					Total Growth
	Dry Mass Desired System Level Growth	609	183	791	30%
	Additional Growth (carried at system level)		73		12%
	Total Wet Mass with Growth	609	183	791	
06.3	Cruise Deck	229.2	21.4	250.7	9%
06.3.1	Science	0.0	0.0	0.0	
06.3.2	Attitude Determination and Control	3.4	0.1	3.5	3%
06.3.3	Command and Data Handling	7.5	1.1	8.6	14%
06.3.4	Communications and Tracking	0.0	0.0	0.0	
06.3.5	Electrical Power Subsystem	33.0	1.0	34.0	3%
06.3.6	Thermal Control (Non-Propellant)	10.3	1.9	12.2	18%
06.3.7	Propulsion (Chemical Hardware)	30.5	1.6	32.1	5%
06.3.8	Propellant (Chemical)	56.4		56.4	
06.3.9	Propulsion EP Hardware)	0.0	0.0	0.0	
06.3.10	Propellant (EP)	0.0		0.0	
06.3.11	Structures and Mechanisms	88.0	15.8	103.9	18%
System Level Growth Calculations _Cruise Deck					Total Growth
	Dry Mass Desired System Level Growth	173	52	225	30%
	Additional Growth (carried at system level)		30		18%
	Total Wet Mass with Growth	229	52	281	

- The Lander MGA was 16%, and the remaining 14% growth (146 kg) was carried at the system level



- The Aeroshell MGA was 18%, and the remaining 12% growth (73 kg) was carried at the system level
- The Cruise Deck (contains RCS) MGA was 9%, with the remaining 21% growth (30 kg) carried at the system level

This additional system-level mass is counted as part of the inert mass to be flown along the required trajectory. Therefore, the additional system-level growth mass impacts the total propellant required for the mission design. The total wet mass of the ALIVE S/C stack with system level growth and MGA (558 kg) included was 2476 kg. Sections 3.2.1 and 3.2.2 provide additional details about the basic and total masses of the different subsystems and the entire ALIVE S/C, after MGA and system level growth has been applied.

In the calculations shown in Table 3.3, the inert mass of the ALIVE S/C is the dry mass plus trapped pressurant, residuals, and propellant margin. The dry mass on each segment is calculated as the total bottoms-up dry mass with the MGA percentage applied plus additional system mass, so that the total growth on each stage is 30% of the basic mass. The total dry basic mass of the ALIVE S/C Stack is 1862 kg. The total basic mass of the ALIVE S/C with the bottoms-up growth (308 kg of the dry mass applied by the subsystem engineers) is 1862 kg + 308 kg = 2170 kg. This is also known as predicted mass, and does not contain the system level growth to reach the 30% growth on dry mass. The total inert mass of the ALIVE S/C with 30% growth carried on the basic masses is 2427 kg. The total wet mass of the complete ALIVE stack is 1918 kg + 558 kg = 2476 kg. This summary of mass is shown in Table 3.3.

Table 3.3—ALIVE Total Mass With Payload
(Includes 30% System Level Growth)

Total masses	
Total stack dry	2420 kg
Total stack inert	2427 kg
Total stack wet.....	2476 kg
Total Lander dry.....	1404 kg
Total Lander inert.....	1404 kg
Total Lander wet.....	1404 kg
Total Aeroshell dry.....	791 kg
Total Aeroshell inert.....	791 kg
Total Aeroshell wet.....	791 kg
Total Cruise Deck dry	225 kg
Total Cruise Deck inert	232 kg
Total Cruise Deck wet.....	281 kg

3.1.3 Power Equipment List (PEL)

Table 3.4—Definition of the ALIVE S/C Power Modes

Mode	Title	Description
Power mode 1	Ground Ops & Launch	Preliminary ground operations, transfer to internal power, launch, and insertion into Venus trajectory
Power mode 2	SA Deploy & Cruise	Deployment of solar arrays, ALIVE generating power, and transit to Venus
Power mode 3	Descent Drop Cruise Deck, Heat shield, Parachute, Aeroshell	Entry, drop of cruise deck, heat shield, deployment of parachute, parachute release, aeroshell release, and first part of descent science
Power mode 4	Free Fall Descent	Free fall portion of descent and descent science
Power mode 5	Landed Science Mode	Portion of the mission devoted to gathering science
Power mode 6	Landed Communication Mode	Portion of the mission devoted to communication

Table 3.5 provides the assumptions about the power requirements in all the modes of operation. The power system designers use these assumptions to size the solar arrays and other power system components.

Table 3.5—ALIVE S/C PEL

WBS	Description	Power Mode 1	Power Mode 2	Power Mode 3	Power Mode 4	Power Mode 5	Power Mode 6
Numb	NIAC Venus Spacecraft CD-2012-72	(W)	(W)	(W)	(W)	(W)	(W)
	Power Mode Name Power Mode duration (units tbd)	Ground Ops & Launch	DPLY, Cruise & Flyby	Drop Cruise Deck & Aeroshell Descent	Parachute Descent	Landed Science Mode	Landed Comm Mode
		8 hr	6480 hr	1 hr	2 hr	30 hr	90 hr
06	NIAC Venus Spacecraft Design	47.80	325.86	280.50	362.70	117.70	271.30
06.1	Lander	30.00	286.50	280.50	362.70	117.70	271.30
06.1.1	Science	0	0	0	82.2	57.4	0
06.1.2	Attitude Determination and Control	5	38	38	38	0	0
06.1.3	Command & Data Handling	25	25	19	19	24	24
06.1.4	Communications and Tracking	0	223.5	223.5	223.5	29.5	240.5
06.1.5	Electrical Power Subsystem	0	0	0	0	0	0
06.1.6	Thermal Control (Non-Propellant)	0.00	0.00	0.00	0.00	6.80	6.80
06.1.7	Propulsion (Chemical Hardware)	0	0	0	0	0	0
06.1.8	Propellant (Chemical)	0	0	0	0	0	0
06.1.9	Propulsion (EP Hardware)	0	0	0	0	0	0
06.1.10	Propellant (EP)	0	0	0	0	0	0
06.1.11	Structures and Mechanisms	0	0	0	0	0	0
06.2	Aeroshell	0.00	0.00	0.00	0.00	0.00	0.00
06.3	Cruise Deck	17.80	39.36	0.00	0.00	0.00	0.00
06.3.1	Science	0	0	0	0	0	0
06.3.2	Attitude Determination and Control	8	8	0	0	0	0
06.3.3	Command & Data Handling	5	5	0	0	0	0
06.3.4	Communications and Tracking	0	0	0	0	0	0
06.3.5	Electrical Power Subsystem	0	0	0	0	0	0
06.3.6	Thermal Control (Non-Propellant)	0.00	0.00	0.00	0.00	0.00	0.00
06.3.7	Propulsion (Chemical Hardware)	4.8	26.36	0	0	0	0
06.3.8	Propellant (Chemical)	0	0	0	0	0	0
06.3.9	Propulsion (EP Hardware)	0.00	0.00	0.00	0.00	0.00	0.00
06.3.10	Propellant (EP)	0	0	0	0	0	0
06.3.11	Structures and Mechanisms	0	0	0	0	0	0

Table 3.6 shows the thermal waste heat for the ALIVE S/C. The thermal waste heat data is used by the Thermal subsystem lead to size each of the ALIVE elements for worst-case environmental conditions.

Table 3.6—Case x Thermal Waste Heat Per Power Mode

Thermal Waste Heat w/ Margins	Factor	Ground Ops & Launch	DPLY, Cruise & Flyby	Drop Cruise Deck & Aeroshell Descent	Parachute Descent	Landed Science Mode	Landed Comm Mode
		8 hr	6480 hr	1 hr	2 hr	30 hr	90 hr
		NIAC Venus Spacecraft Design					
Lander	Total	39	227.2	219.4	326.2	133.8	196.4
Science	1.3	0	0	0	106.9	74.6	0.0
Attitude Determination and Control	1.3	6.5	49.4	49.4	49.4	0	0
Command & Data Handling	1.3	32.5	32.5	24.7	24.7	31.2	31.2
Communications and Tracking	0.65	0	145.3	145.3	145.3	19.2	156.3
Electrical Power Subsystem	1.3	0	0	0	0	0	0
Thermal Control (Non-Propellant)	1.3	0	0	0	0	8.84	8.84
Structures and Mechanisms	1.3	0	0	0	0	0	0
Cruise Deck	Total	19.3	40.9	n/a	n/a	n/a	n/a
Science	1	0	0	0	0	0	0
Attitude Determination and Control	1	8	8	0	0	0	0
Command & Data Handling	1.3	6.5	6.5	0	0	0	0
Communications and Tracking	1	0	0	0	0	0	0
Electrical Power Subsystem	1	0	0	0	0	0	0
Thermal Control (Non-Propellant)	1	0	0	0	0	0	0
Propulsion (Chemical Hardware)	1	4.8	26.4	0	0	0	0
Propellant (Chemical)	1	0	0	0	0	0	0
Structures and Mechanisms	1	0	0	0	0	0	0



3.2 System-Level Summary (Needs to be updated-ces)

The system block diagram that captures the theory behind the ALIVE design is shown in Figure 5.1. The components were designed and placed in a manner that allows for a controlled landing at Ovda Regio while supporting descent and surface science.

3.2.1 Propellant Calculations

The propellant details are captured in Table 3.7. The total 2476 kg stack wet mass includes residuals and margin from each of the three elements. The total 2427 kg S/C inert mass is used by the mission seat to iteratively calculate total useable propellant.

Table 3.7—ALIVE S/C Propellant Details

Lander: Propellant Details (Chemical)	
Lander Totals	
Lander Dry mass	1404 kg
Lander Inert mass	1404 kg
Lander Wet mass	1404 kg
Aeroshell: Propellant Details (Chemical)	
Aeroshell Totals	
Aeroshell Dry mass	791 kg
Aeroshell Inert mass	791 kg
Aeroshell Wet mass	791 kg
Cruise Deck: Propellant Details (Chemical)	
RCS/ACS Used Prop	49 kg
Mass, RCS Total	56 kg
RCS/ACS margin	5 kg
RCS/ACS Residuals	2 kg
RCS Total Loaded Pressurant	1 kg
Cruise Deck Totals	
Cruise Deck Dry mass	225 kg
Cruise Deck Inert mass	232 kg
Cruise Deck Wet mass	281 kg

The formulas given below were used to calculate the amount of propellant needed to push the ALIVE S/C (Lander, Aeroshell, and Cruise Deck) along the trajectory to the surface of Venus. The used propellant is calculated using the following rocket equation:

$$\Delta V = I_{sp} * g * \ln\left(\frac{m_0}{m_1}\right)$$

which can be rewritten as:

$$m_1 = m_0 * e^{\left(\frac{-\Delta V}{I_{sp} * g}\right)}$$

The variables in this equation are signified as follows:

- ΔV is the total mission change in velocity to perform the attitude control maneuvers
- m_0 is the initial total mass, including propellant
- m_1 is the final total mass and is the value being determined, as shown by the second equation
- I_{sp} is the specific impulse expressed as a time period
- g is the gravitational constant, which is equal to 9.8 m/s

Following are propellant details for the mission. Additional information can be found in Table 3.7.

- Total RCS/ACS propellant = (Used + Margin + Residuals + Loaded Pressurant) = 49 kg + 5 kg + 2 kg + 1kg = 56 kg
- Total ALIVE Stack Masses:

- Wet mass = (basic mass + subsystem growth + system growth + total propellant + total RCS propellant) = 2476 kg
- Dry mass = (wet mass – total propellant) = 2420 kg
- Inert Mass = (wet mass – used propellant) = 2427 kg

Table 3.8—Inert Mass Calculations For ALIVE Total S/C

ALIVE S/C Mass Calculations	Basic Mass (kg)	Growth (kg)	Total Mass (kg)	Aggregate Growth (%)
EVE spacecraft Total Wet Mass	1918	308	2226	
EVE spacecraft total Dry Mass	1862	308	2170	16%
Dry Mass Desired System Level Growth	1862	558	2420	30%
Additional Growth (carried at system level)		250		14%
Total Useable Propellant	49		49	
Total Trapped Propellants, Margin, pressurant	7		7	
Total Inert Mass with Growth	1869	558	2427	
EVE spacecraft Total Wet Mass with System Level Growth	1918	558	2476	

The LV performance margin of 584 kg was calculated by subtracting the wet mass of the S/C from the assumed LV performance. After including an additional margin of 10% from the LV performance, the ALIVE S/C was required to be lighter than 3060 kg.

Table 3.9—ALIVE Architecture Details

Architecture Details	
LV.....	Atlas V 411
V.....	2.65 km/s
Energy, C ₃	7.00 km ² /s ²
ELV performance (pre-margin)	3400 kg
ELV Margin (%).....	10%
ELV performance (post-margin).....	3060 kg
C22 ELV Adaptor (Stays with ELV)	0 kg
ELV performance (post-adaptor)	3060 kg
EV Spacecraft Total Wet Mass with System Level Growth	2476 kg
Available ELV Margin	584 kg
Available ELV Margin (%).....	19%
Lander: Propellant Details (Chemical)	
Lander Dry mass.....	1404 kg
Lander Inert mass	1404 kg
Lander Wet mass.....	1404 kg
Aeroshell: Propellant Details (Chemical)	
Aeroshell Dry mass.....	791 kg
Aeroshell Inert mass	791 kg
Aeroshell Wet mass	791 kg
Cruise Deck: Propellant Details (Chemical)	
RCS/ACS Used Prop.....	49 kg
Mass, RCS Total.....	56 kg
RCS/ACS margin5 kg
RCS/ACS Residuals2 kg
RCS Total Loaded Pressurant.....	.1 kg
Cruise Deck Totals	
Cruise Deck Dry mass	225 kg
Cruise Deck Inert mass.....	232 kg
Cruise Deck Wet mass	281 kg

The mass of the ELV is absorbed in the structure calculations.



4.0 AREAS FOR FUTURE STUDY

The ALIVE landed duration is only limited by the amount of Li which can be carried by the lander. Further studies are needed to investigate how additional mass and volume of Li can be carried, in the minimum by a more elegant Li tank design perhaps even longer using a larger launcher and/or larger aeroshell. Other power conversion/cooling systems might also bring other benefits.

A more detailed conceptual design of the Li burner system is necessary for technology development planning purposes.

5.0 SUBSYSTEM BREAKDOWN

5.1 Science Package

5.1.1 Descent Instruments

The ALIVE science package consisted of various descent and surface science instruments, see Table 5.1 and Table 5.3.

Table 5.1—Descent Instruments

Instrument	Mass (kg)	Power (W)	Footprint (m)	Data (kbps)	Heritage	comments
NMS	11	50	0.26 by 0.16 by 0.39	0.5	High: MSL, SAM, Pioneer	A slightly smaller instrument was flown on Pioneer Venus
TLS	4.5	17	0.25 by 0.10 by 0.10	1.0	High: MSL, SAM	Data rate can be reduced (will give fewer points in profile)
Descent imager	2	12	0.15 by 0.15 by 0.10	24	High: MSL	Only used last 10 km of descent
ASI	2	3.2	0.10 by 0.10 by 0.10	0.25	High: flagship	Data rate seems to be high
IMU	-----	-----	-----	0.5	High	Assume MEMS accelerometer

IMU

The 3-axis accelerometer (IMU) is part of the atmospheric science, to measure wind velocities from descent motion. Table 5.1 does not include IMU mass or power because the IMU instrument is accounted in the G&NC budget.

ASI

This consists primarily of temperature and pressure measurements during descent. Ten 12-b measurements per second should be sufficient, that would be 0.12 kbps. If we run the anemometer during descent; this will double the bit rate. The data rate from the VITAL statistics is 2.5 kbps; this seems higher than is needed.

Descent imager data rate:

The images are assumed to begin at 10 km, and the descent rate is assumed to be 5m/sec, so the duration is 2000 s. The ten lossless images (48 Mb) is thus an average rate of 24 kbps.

Data rate will be lower if we assume a lower descent rate or higher data compression. Since the highest altitude frames will be blurred due to atmospheric scattering, it may be reasonable to use higher compression for all but the lowest few frames

Data Volume

- NMS data volume calculation:
 - Assume one measurement every 100 m from 30 km to surface = 300 measurements.
 - Each measurement is 12 b times 512 data points = 6 Kb (512 data points will give 0.2 Dalton resolution for 1 to 99 Dalton range. This is comparable to Cassini data resolution)

- Total is 1.8 Mb
- If these measurements are taken over a descent time of 1 hr (3600 s), data rate is 0.5 Kb/s
- Cassini instrument:
http://lasp.colorado.edu/~horanyi/graduate_seminar/Ion_Neutral_Mass_Spec.pdf
- TLS data volume:
 - Assume one measurement every 100 m from 30 km to surface = 300 measurements.
 - Each measurement is 12 b times 1024 data points = 12 Kb
 - Total is 3.6 Mb
 - If these measurements are taken over a descent time of 1 hr (3600 s), this will come to 1 Kb/s

5.1.2 Surface Instrument Details

Table 5.2—Surface Instruments

Instrument	Mass (kg)	Power (W)	Footprint (m)	Data (Mb)	Heritage	comments
LIBS	13	50	Two boxes (laser and spectrometer): 0.15 by 0.15 by 0.30 0.20 by 0.20 by 0.20	5.2/sample	Will be demonstrated on MSL	"12 b, three measurements per sample" (1 R, 2 LIBS)
Pan Cam	1	2.2	Two boxes (optical and electronics) 0.04 by 0.05 by 0.06 0.07 by 0.07 by 0.034	154 total	High: MSL	Data rate can be reduced with higher compression if needed. Mass includes window
Context Imager	2	2.2	Two boxes (optical and electronics) 0.04 by 0.05 by 0.06 0.07 by 0.07 by 0.034	20/image	High: MSL	Data rate can be reduced with higher compression if needed. Mass includes window
Meteorology (ASI)	0.1	3.2	0.05 by 0.05 by 0.15	1 bps	High: flagship	Mass includes only Anemometer

LIBS/Raman

The LIBS instrument has an optical head with the laser and mirror, and a separate spectrometer connected to the optical head with a fiber optic.

The mirror diameter for the MSL instrument was 11 cm; the larger the mirror, the farther away the instrument can take measurements. For a baseline, we need a window with an 11 cm diameter at the outside (the window can be a truncated cone that tapers to a smaller size on the inside).

The LIBS will have an externally-mounted mirror that uses high-temperature motors to adjust the pointing in two axes.

For info and photos of the MSL instrument, see

http://www.nasa.gov/mission_pages/msl/multimedia/gallery/pia13398.html and <http://msl-scicorner.jpl.nasa.gov/Instruments/ChemCam/>

Panoramic Imager

The panoramic imager has a separate window, and also is pointed using an externally-mounted mirror

Meteorology

Meteorology measurements will include the temperature and pressure sensors from the descent ASI package. The instruments are already incorporated into the descent instrument list, and hence only the anemometer mass and volume is included here. The Anemometer is a rod that will protrude 15 cm upwards from the lander.

Data volume for Images



Calculation of data volume for the images:

Compression:

The MER Pan Cam investigation did lossless (“LOCO”) compression at 4.8 bits per pixel (bpp). We can probably do better than this, however, this value will be used for calculations.

Descent imager data rate assumption:

The science minimum is assumed to be acquisition of ten 1024 by 1024-pixel frames. These will be compressed using LOCO at 4.8 bpp. The total data volume is thus 48 Mb.

Panorama:

The field of view is 60°; we need some overlap to make a panorama, and so the full panorama requires eight frames. Each frame is 2048 by 2048 pixels = 4 Megapixels.

We will take the color image in two parts, a lossless black and white image, and then a higher compression for the four frames of color (the color frames are not going to very different from the black and white, so this can be highly compressed with no loss of image quality). The black and white panorama is thus (eight images) times (4 M-pixels/image) times (4.8 bpp) = 154 Mb. The color portion of the data will be encoded to 1 bpp per color. The color data for the panorama is thus (eight frames) times (four colors per frame) times (4 M-pixels/image) times (1 bpp) = 118 Mb.

5.1.3 Science Design and MEL

The full science payload, summarized in the MEL for the ALIVE S/C in Table 5.3, consists of the descent science instruments, surface science instruments, and additional instruments on the Lander.

Table 5.3—Science ALIVE MEL

WBS	Description	QTY	Unit Mass	Basic Mass	Growth	Growth	Total Mass
Number	Case 1 NIAC Venus Spacecraft CD-2012-72		(kg)	(kg)	(%)	(kg)	(kg)
06	Extended Venus Explorer Spacecraft Design			1917.94	16.1%	308.47	2226.41
06.1	Lander			1079.92	16.4%	177.57	1257.49
06.1.1	Science			39.80	18.7%	7.45	47.25
06.1.1.a	Descent Science Instruments			19.50	20.0%	3.90	23.40
06.1.1.a.a	Neutral Mass Spectrometer (NMS)	1	11.00	11.00	20.0%	2.20	13.20
06.1.1.a.b	Tunable Laser Spectrometer (TLS)	1	4.5	4.50	20.0%	0.90	5.40
06.1.1.a.c	Descent imager	1	2.0	2.00	20.0%	0.40	2.40
06.1.1.a.d	Atmospheric structure (ASI)	1	2.0	2.00	20.0%	0.40	2.40
06.1.1.b	Surface Science Instruments			15.10	20.0%	3.02	18.12
06.1.1.b.a	Raman / Laser Induced Breakdown Spectroscopy (LIBS) Box 1	1	6.5	6.50	20.0%	1.30	7.80
06.1.1.b.b	Panoramic Imager Optical Box	2	0.5	1.00	20.0%	0.20	1.20
06.1.1.b.c	Context Imager Optical Box	1	1.0	1.00	20.0%	0.20	1.20
06.1.1.b.d	Meteorology (ASI)	1	0.1	0.10	20.0%	0.02	0.12
06.1.1.b.e	Raman / Laser Induced Breakdown Spectroscopy (LIBS) Box 2	1	6.5	6.50	20.0%	1.30	7.80
06.1.1.c	Additional Instruments			5.20	10.2%	0.53	5.73
06.1.1.c.a	Motors for Pointing Optical Instruments	4	0.80	3.20	4.0%	0.13	3.33
06.1.1.c.b	Panoramic Imager Electronics Box	2	0.50	1.00	20.0%	0.20	1.20
06.1.1.c.c	Context Imager Electronics Box	1	1.00	1.00	20.0%	0.20	1.20

5.2 Communications

5.2.1 Communications Requirements

- Communications design philosophy
 - Provide direct to Earth communication during all phases of operation

- Provide the highest possible data rates for science. Target 2.2 kbps.
- Single fault tolerant
- Flight heritage components
- Low power consumption electronics, except RF transmitter
- Single Event Upset (SEU) tolerant electronics
- Software hard coded into ASICS chips
- Use of DSN antenna arraying capabilities for increase receive aperture
- X-Band was directed for communications

The communications link budget for the ALIVE S/C can be found in Table 5.4.

5.2.2 Communications Assumptions

Hardware Functionality

- Antennas two fly away low gain antennas (LGA), two LGA’s on Lander and a high gain antenna (HGA) for primary landed communications.
- LGA designed by Allan Hanson, Hughes Aircraft Company for Venus probe (Figure 5.2)
- HGA includes deployment mechanisms, two access gimbals and rotary joints (Figure 5.3)
- HGA a special RF waveguide/window to pierce shell of Lander for reduced heat transference ~ 4 wavelengths depth
- Software functionality
 - Embedded software, vender specific language
- Primary communications mass: 47 kg
- Design based on current hardware: LRO and Orion HGA’s, the Deep Space Transponder and currently deployed TWTA’s by Boeing (Figure 5.5)

Table 5.4—Communications Science Link Budget

Transmitter		
Transmitter power (W, dBW)	75 W	18.75 dBW
Losses of antenna (dB)	-----	-1 dBW
Efficiency	0.5	-----
Transmitted power (W, dBW)	59.57 W	17.75 dBW
DC power	150 W	-----
Transmit antenna		
Frequency	8.4 GHz	-----
Dish diameter	0.75 m	-----
Directivity	4358.52	36.39 dBi
Antenna efficiency	0.5	-----
Antenna gain	2179.26	33.38 dBi
EIRP (dBW)	-----	51.dBW
Receiver	-----	-----
Receiver noise figure	-----	1.0 dB
Receiver noise temperature	-----	81.52 K
Receiver antenna diameter	70 m	-----
Directivity	37967522.42	75.79 dB
Antenna efficiency	0.63	-----
Antenna gain	23919539.12	73.79 dB
	-----	56
Distance between antennas	114000000 km	-----
Spreading loss	3.88×10^{-29}	-284.11 dB
Receiver noise temperature (k)/noise figure (dB)	81.52 K	1.1 dB
Bandwidth (Hz)	4000	-----
Spectral power density	4.50×10^{-18} W	-173.47 dBW

Bits per Hz	0.55	-----
SNR	48.65	16.87 dB
$E_b/N_o \ 10 \cdot \log(2) = 3.01 \text{ db}$	-----	-----
Qpsk = 2	3.01	-----
Required SNR	-----	2.189291851 dB
$E_s/N_o -7$	-----	-----
Margin	-----	14.68 dB

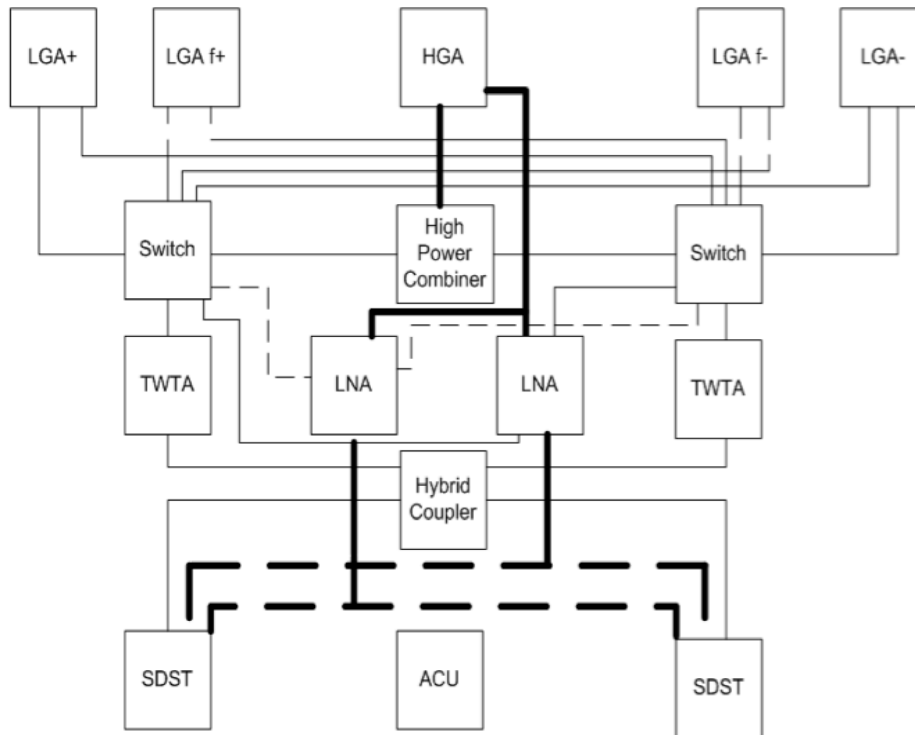

Figure 5.1—Block diagram of ALIVE communications hardware – based on Venus Probe

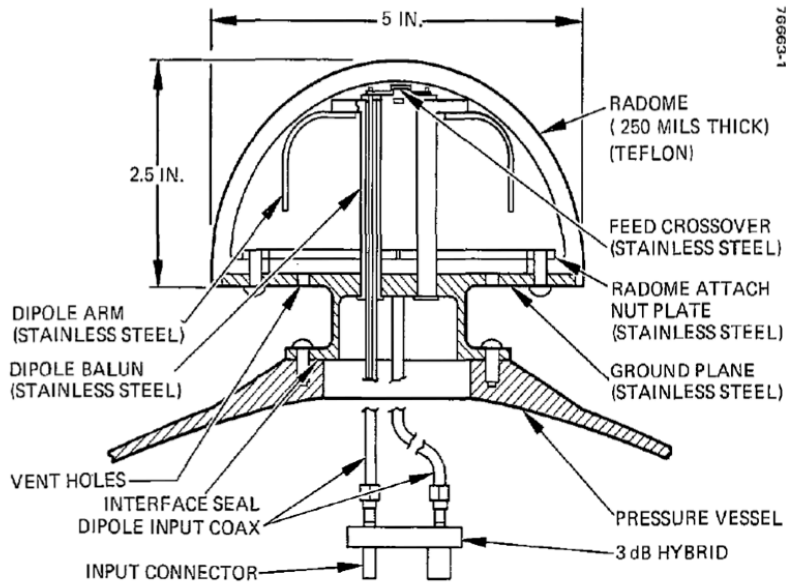

Figure 5.2—Illustration of Venus Probe LGA

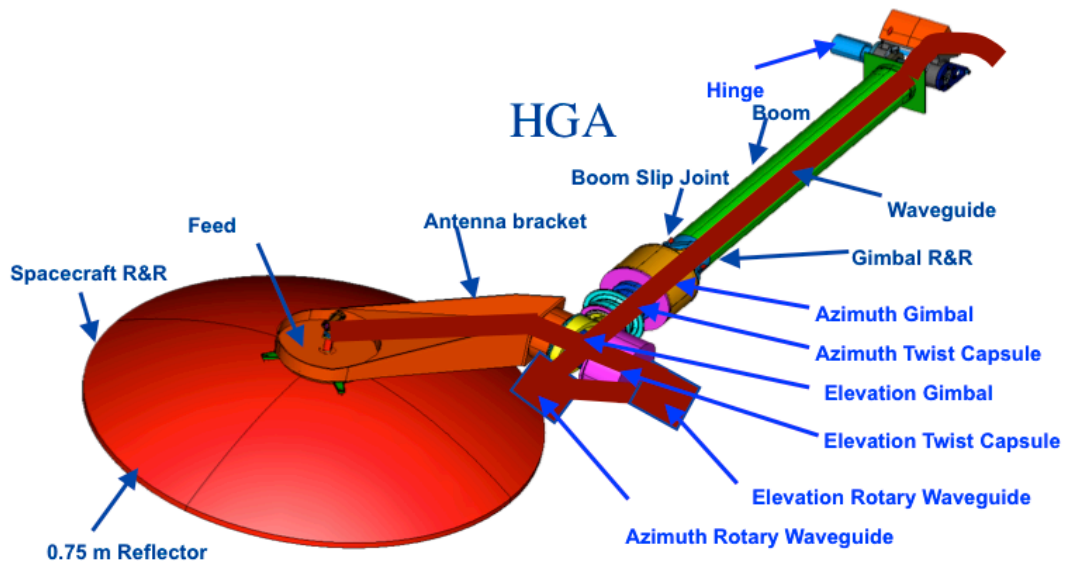

Figure 5.3—Graphic of Orion

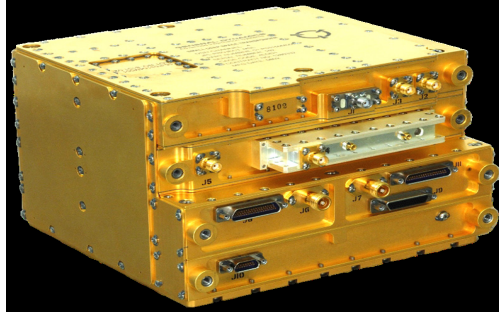

Figure 5.4—Image of Representative SDST communications hardware.

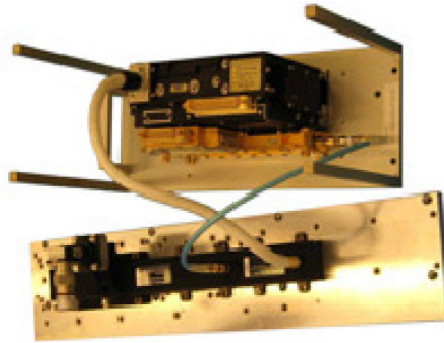

Figure 5.5—Image of Representative TWTA and EPC.

5.2.3 Communications Design and MEL

Table 5.5—Communications Case 1 MEL

WBS	Description	QTY	Unit Mass	Basic Mass	Growth	Growth	Total Mass
Number	Case 1 NIAC Venus Spacecraft CD-2012-72		(kg)	(kg)	(%)	(kg)	(kg)
06	Extended Venus Explorer Spacecraft Design			1917.94	16.1%	308.47	2226.41
06.1	Lander			1079.92	16.4%	177.57	1257.49
06.1.4	Communications and Tracking			47.71	10.9%	5.20	52.91
06.1.4.a	X Band System			40.15	12.9%	5.20	45.35
06.1.4.a.a	SDT Transponder	2	3.20	6.40	10.0%	0.64	7.04
06.1.4.a.b	X Band gimbaling antenna	1	18.00	18.00	10.0%	1.80	19.80
06.1.4.a.c	X Band antenna	1	1.45	1.45	10.0%	0.15	1.60
06.1.4.a.d	Wave guide	1	0.50	0.50	30.0%	0.15	0.65
06.1.4.a.e	X Band TWTA and EPC	2	3.70	7.40	10.0%	0.74	8.14
06.1.4.a.f	X Band LNA	2	0.70	1.40	30.0%	0.42	1.82
06.1.4.a.g	Low Gain Antenna SC positive	1	0.50	0.50	10.0%	0.05	0.55
06.1.4.a.h	Low Gain Antenna SC negative	1	0.50	0.50	10.0%	0.05	0.55
06.1.4.a.j	Diplexer	2	0.50	1.00	30.0%	0.30	1.30
06.1.4.a.k	Switch A	1	1.50	1.50	30.0%	0.45	1.95
06.1.4.a.l	Switch B	1	1.50	1.50	30.0%	0.45	1.95
06.1.4.e	Communications Instrumentation			7.56	0.0%	0.00	7.56
06.1.4.e.b	Cables	1	3.78	3.78	0.0%	0.00	3.78
06.1.4.e.c	TPS	1	3.78	3.78	0.0%	0.00	3.78
06.2	Aeroshell			608.77	18.0%	109.47	718.24
06.2.4	Communications and Tracking			1.40	10.0%	0.14	1.54
06.2.4.a	X Band System			1.40	10.0%	0.14	1.54
06.2.4.a.a	LGA Fly Away positive and negative	2	0.70	1.40	10.0%	0.14	1.54

5.2.4 Communications Recommendation

Development of high temperature electronics to make possible an X-Band phased array. Research of propagation loss in the Venus atmosphere at the assigned frequency may increase the probability of returning all mission data.

5.3 Command and Data Handling

The main purpose of the C&DH system is collecting and distributing non-flight-critical sensor data from the instrumentation throughout the mission and storing it in local memory via high-speed data buses. GN&C, propulsion, and thermal control requirements indicate the need for controlling valves and gimbals, as well as sensing pressure and temperature transducers. All telemetry acquisition and processing of data is followed by forwarding the data to the communication subsystem for transmission to Earth.

5.3.1 C&DH Requirements

The design requirements for the C&DH system are as follows:

- Avionics components and parts shall be Class S, per MIL-STD-883B.
- Avionics shall be one fault tolerant using cold spares.
- Data storage unit shall provide at least 5 GB of onboard permanent solid-state memory.
- Avionics shall be ground-bonded and surge-protected to resist on-pad lightning damage.
- Avionics shall be designed to withstand the on-orbit ionizing and non-ionizing radiation environments dictated by the mission profile. It is important to avoid over-specifying the rad-tolerance levels to minimize cost for parts and testing.

5.3.2 C&DH Assumptions

The following design assumptions are based on the mission requirements:

- Implemented with rad-tolerant microcontrollers, field-programmable gate arrays (FPGAs), and data storage using solid-state random access memory (RAM) and Flash memory. The LEON3 processor is an example of a modern rad-tolerant microcontroller.
- Avionics spare circuitry for fault tolerance is implemented as cold spares in order to minimize power consumption.
- Hardware design heritage is based on previous S/C and lessons learned.
 - Sensor estimate is based on a preliminary assumption of number of channels for input and output and likely will decrease as the design stabilizes.

5.3.3 C&DH Design and MEL

The C&DH system consists of 100 MIPS LEON3-class processor boards containing various hardware and software mechanisms such as timeouts and watchdog circuitry to provide for single fault tolerance. Each processor board includes an FPGA-embedded core built with a main processor such as the LEON3 series, capable of supporting C&DH functions, a 5-plus GB solid-state memory card, as well as communications and payload interface cards. The primary processor is capable of autonomous failover to a redundant cold spare unit if a fault is detected.

Depending on choice of processor, flight computers will use a real-time operating system such as VxWorks or Green Hills Integrity. To support all mission phases, the number of source lines of code (SLOC) has been estimated to be 250000 SLOCs. However, this estimate and implied development cost should be tempered with the understanding that recent developments in autocode technologies that generate known good instruction loads will become a design standard.



The following list is comprised of the main avionics components and their quantities, as input to the MEL shown in Table 5.6:

- Main computers (one main computer and one redundant cold spare)
- Data acquisition channels (including redundant paths for single-fault tolerance)
- Cruise Deck has a simple DCIU commanded by the Lander
- Redundant solid-state memory
- Instrumentation (including approximately 40 sensors, mass of 6 ounces each, power requirement of 50 mW each)

Note: As shown in the MEL, the initial estimate contained two 48-channel analog-to-digital and digital-to-analog serial digital interface (SDI) cards and one 48-channel serial data output (SDO) card, giving 144 channels of input/output, not including any serial bus input/output, all used to estimate worst-case mass and power.

- S/C cabling (per Monte Carlo simulation):
 - Instrumentation wiring approximately 11m per sensor run
 - Approximately 583 m total, 20-24 American Wire Gauge (AWG) Tefzel (exclusive of high currents Power system conductors)

Table 5.6—C&DH ALIVE S/C MEL

WBS	Description	QTY	Unit Mass	Basic Mass	Growth	Growth	Total Mass
Number	Case 1 NIAC Venus Spacecraft CD-2012-72		(kg)	(kg)	(%)	(kg)	(kg)
06	Extended Venus Explorer Spacecraft Design			1917.94	16.1%	308.47	2226.41
06.1	Lander			1079.92	16.4%	177.57	1257.49
06.1.3	Command & Data Handling			22.60	33.0%	7.47	30.07
06.1.3.a	C&DH Hardware			19.30	33.5%	6.48	25.78
06.1.3.a.a	FPGA IP CPU rad hard LEON3	2	1.50	3.00	30.0%	0.90	3.90
06.1.3.a.b	Watchdog switcher	1	0.50	0.50	30.0%	0.15	0.65
06.1.3.a.c	Time Generation Unit	1	0.50	0.50	3.0%	0.02	0.52
06.1.3.a.d	Mass Memory Module	1	0.50	0.50	30.0%	0.15	0.65
06.1.3.a.e	Command and Control Harness	1	6.60	6.60	50.0%	3.30	9.90
06.1.3.a.f	cPCI enclosure with power supply	1	5.00	5.00	20.0%	1.00	6.00
06.1.3.a.g	Valve drivers	1	0.80	0.80	30.0%	0.24	1.04
06.1.3.a.h	Igniter drivers	1	0.80	0.80	30.0%	0.24	1.04
06.1.3.a.i	Separation drivers	1	0.80	0.80	30.0%	0.24	1.04
06.1.3.a.j	TVC drivers	1	0.80	0.80	30.0%	0.24	1.04
06.1.3.a.m	SLOCS	250000	0.00	0.00	0.0%	0.00	0.00
06.1.3.b	Instrumentation & Wiring			3.30	30.0%	0.99	4.29
06.1.3.b.a	AD/DA/SDI card	1	1.00	1.00	30.0%	0.30	1.30
06.1.3.b.c	SDO card	1	1.30	1.30	30.0%	0.39	1.69
06.1.3.b.d	Pressure and Temperature Sensors	20	0.05	1.00	30.0%	0.30	1.30
06.3	Cruise Deck			229.25	9.4%	21.44	250.69
06.3.3	Command & Data Handling			7.50	14.0%	1.05	8.55
06.3.3.a	C&DH Hardware			7.50	14.0%	1.05	8.55
06.3.3.a.b	DCIU	1	3.50	3.50	30.0%	1.05	4.55
06.3.3.a.k	Harness	1	4.00	4.00	0.0%	0.00	4.00

5.3.3.1 Flight Computers and Software

The flight computers and software provide the following functions:

- Load, initialization, executive functions, and utilities executed by the processors
- Flight computer board redundancy management
- Data acquisition and control
- Command and telemetry processing via RS-422 or SERDES
- Health monitoring and management
- Power management, control, and distribution
- GN&C calculations
- Ephemeris calculations for available data communications with Earth
- Event sequence management
- Fault detection, diagnostics, and recovery

5.3.4 C&DH Trades

The S/C must have sufficient particle shielding for the avionics to withstand long-term deep-space exposure to heavy ions. Therefore, future studies should consider trading the inclusion of additional particle shielding in the avionics enclosures. In some cases, titanium (Ti) instead of aluminum (Al) can be used to add shielding with less mass due to the mass ratio of Ti to Al.

By mid-decade, advances in semi-automatic code generation will help guarantee a very capable, secure, and reliable operating system execution. Therefore, the choice of which computer operating system to include on a S/C designed for 2020 and beyond may not be the correct one for a S/C designed in 2012 to 2014. A final choice of operating system should await the actual beginning of detailed design.

5.3.5 C&DH Analytical Methods

As a matter of common practice, the design of a new S/C's C&DH system is often based on one that is proven effective (high TRL) on another S/C, and that requires minor or no modifications for the mission currently under development. This C&DH system is based on previous S/C, such as Dawn, New Horizons, and Extrasolar Planet Observation (EPOXI).

5.3.6 C&DH Risk Inputs

C&DH risks include the following:

- Particle radiation
- Launch vibration stresses
- Obsolescence and/or availability of low-volume space-qualified EEE parts
- Inability to accurately define design and performance requirements and margins early in the project, thereby leading to a system design that is unable to meet downstream requirements leading to schedule delays and cost overruns.

5.3.7 C&DH Recommendation

The following are the recommendations of the C&DH subsystem lead:

- The S/C must have sufficient EMI/RFI shielding as well as being sufficiently ground-bonded and surge-protected to resist on-pad lightning damage.
- The S/C must have sufficient electromagnetic/radio frequency interference and particle shielding, due to its long-term space orbital time.



- Long-term availability and reliability of Avionics for the length of this mission is crucial for mission success.

5.4 Guidance, Navigation and Control

5.4.1 GN&C Requirements

The GN&C subsystem is required to provide attitude determination and control throughout the entire mission, including post LV separation, cruise to Venus, and EDL. The GN&C subsystem is also required to provide an EDL profile where the vehicle experiences no more than a 40 g load.

5.4.2 GN&C Assumptions

Parachute design:

- Consists of determining the required canopy area and estimating the mass of the parachute
- Bridle and suspension line length are left for future work

Atmospheric entry defined as:

- Altitude = 200 km
- Velocity = 11.3 km/s

5.4.3 GN&C Design and MEL

Cruise deck

The GN&C hardware on the cruise deck consists of two Technical University of Denmark (DTU) Advanced Stellar Compass (ASC) Star Trackers and eight sun sensors. A single ASC data processing unit (DPU) is capable of processing information from two optical units (OU) however to remain single fault tolerant, two DPUs were employed, resulting in two DPUs and two OUs. The sun sensors provide rough attitude determination as well as knowledge of the direction to the sun during any required safe modes.

Aeroshell

The only GN&C hardware located in the aeroshell is the parachute. The parachute was sized to create a sufficient difference in drag acceleration between the lander and the heat shield so as to ensure no recontact by the heat shield when it gets jettisoned.

Lander:

The lander GN&C hardware consists of one internally redundant Northrop Grumman Scalable Inertial Measurement Unit (SIRU) that provides knowledge of vehicle body rates, position and attitude information between navigation updates, and knowledge of vehicle accelerations. Even though the SIRU is located in the lander, it provides this information during cruise as well as during EDL. In addition to the SIRU, the lander also contains the drag flap, which provides drag on the vehicle during the last phase of descent to reduce the vehicle terminal velocity. A summary of the GN&C MEL for ALIVE can be seen in Table 5.4.

Table 5.7—GN&C ALIVE S/C MEL

WBS	Description	QTY	Unit Mass	Basic Mass	Growth	Growth	Total Mass
Number	Case 1 NIAC Venus Spacecraft CD-2012-72		(kg)	(kg)	(%)	(kg)	(kg)
06	Extended Venus Explorer Spacecraft Design			1917.94	16.1%	308.47	2226.41
06.1	Lander			1079.92	16.4%	177.57	1257.49
06.1.2	Attitude Determination and Control			142.61	17.4%	24.75	167.36
06.1.2.a	Guidance, Navigation, & Control			142.61	17.4%	24.75	167.36
06.1.2.a.a	Inertial Measurement Units	1	7.10	7.10	5.0%	0.36	7.46
06.1.2.a.b	Drag Flaps	1	135.51	135.51	18.0%	24.39	159.90
06.2	Aeroshell			608.77	18.0%	109.47	718.24
06.2.2	Attitude Determination and Control			54.23	18.0%	9.76	63.99
06.2.2.a	Guidance, Navigation, & Control			54.23	18.0%	9.76	63.99
06.2.2.a.c	Main Parachute	1	54.23	54.23	18.0%	9.76	63.99
06.3	Cruise Deck			229.25	9.4%	21.44	250.69
06.3.2	Attitude Determination and Control			3.44	3.0%	0.10	3.54
06.3.2.a	Guidance, Navigation, & Control			3.44	3.0%	0.10	3.54
06.3.2.a.b	Sun Sensors	8	0.04	0.29	3.0%	0.01	0.30
06.3.2.a.d	Star Tracker Optical Unit	2	0.58	1.16	3.0%	0.03	1.20
06.3.2.a.e	Star Tracker DPU	2	0.99	1.99	3.0%	0.06	2.05

5.4.4 GN&C Trades

5.4.5 GN&C Analytical Methods

The EDL profile was largely based on that of the Pioneer Venus large probe. The nominal profile can be seen in Figure 5.6.

Accelerometers in the IMU are used to know when to trigger the deployment of the parachute. At a sufficiently low speed, roughly at a Mach of 0.7 and nominally just under 3 min from atmosphere entry, the heat shield has served its purpose and hence is jettisoned. A few seconds prior to heat shield jettison a parachute is deployed to create a sufficient difference in drag acceleration between the vehicle and the heat shield. A short time after the heat shield is jettisoned, at a time TBD, the landing legs are deployed. The time between heat shield jettison and landing leg deployment will probably be on the order of seconds to tens of seconds, basically just enough time to ensure that the heat shield has cleared the vehicle. After the landing legs have been deployed, at approximately 20 min after atmosphere entry, the parachute is released, which also releases the vehicle from the back shell. This is done to reduce the amount of drag on the vehicle and hence reduce the amount of time it takes for the vehicle to reach the surface. The vehicle then free falls for approximately another 70 min, reaching the surface roughly 90 min after atmosphere entry. To ensure that the landing load is less than the 40 g limit, the vehicle contains a drag flap to ensure a relatively low terminal velocity along with crush pads on the landing legs to absorb energy at impact.

The Mission Analysis and Simulation Tool In Fortran (MASTIF) was used to simulate the nominal EDL profile for ALIVE. MASTIF contains a Venus atmosphere model, Venus-GRAM 2005, and was used to determine the required flight path angle that would provide a load no greater than 40 g's. It was found that with the given assumptions at entry (altitude of 200 km, velocity of 11.3 km/s), a flight path angle of -8.7° was required to ensure that the maximum load experienced by the vehicle during atmospheric deceleration was less than 40 g's. The nominal acceleration and altitude profile can be seen in Figure 5.7 and Figure 5.8, respectively. If the entry velocity can be reduced than the allowable flight path angle could be increased.

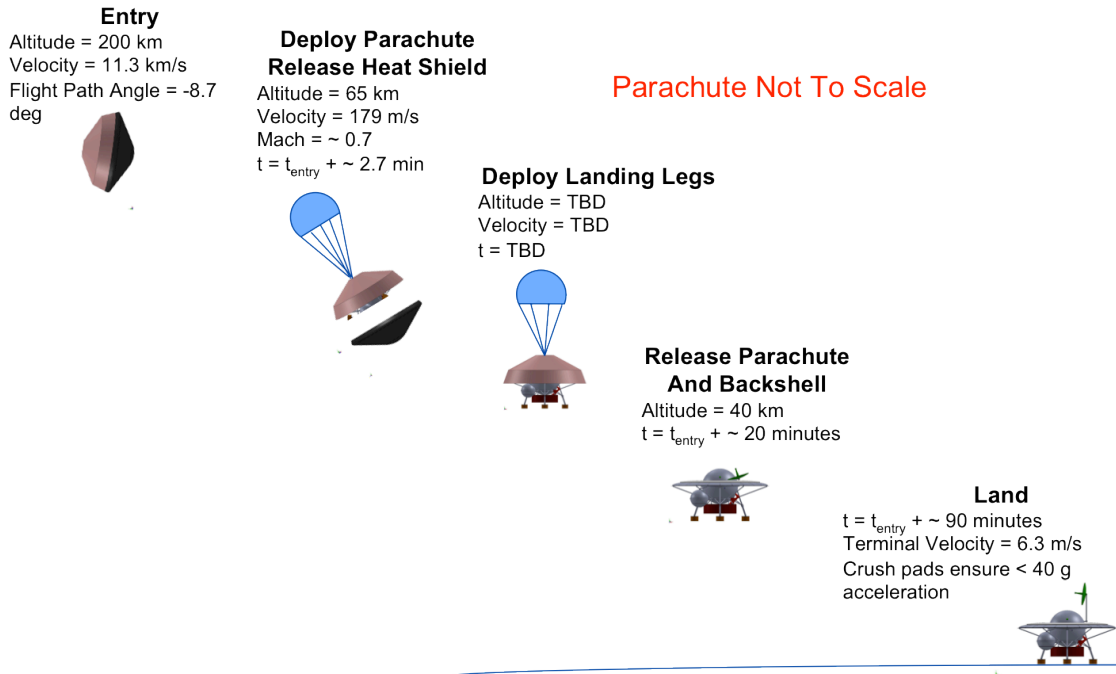

Figure 5.6—Summary of nominal EDL profile.

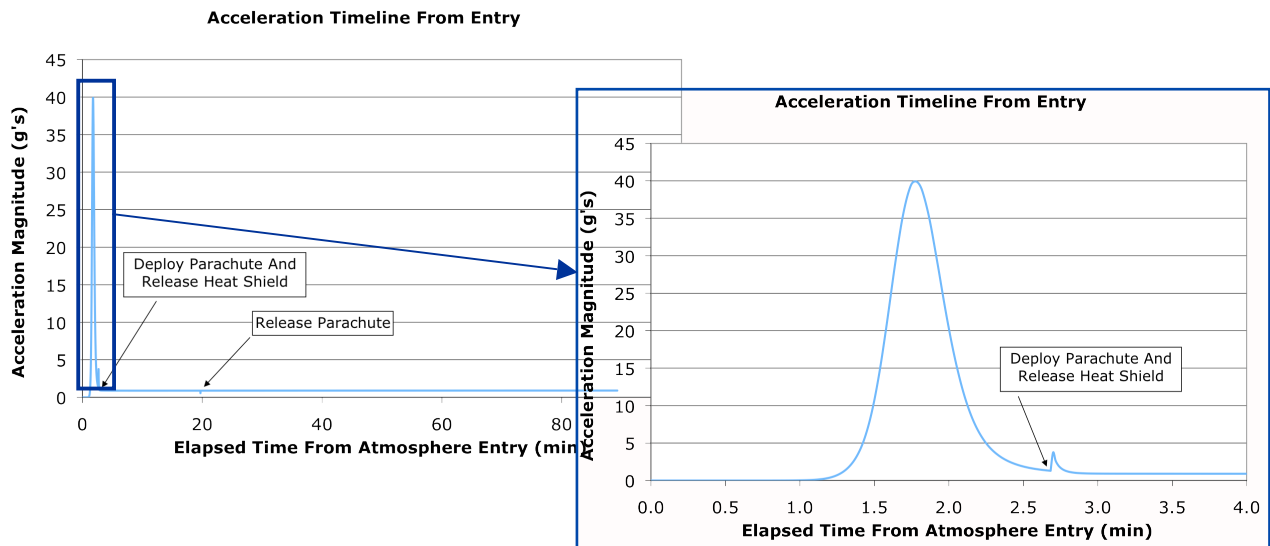

Figure 5.7—Acceleration timeline from atmospheric entry.

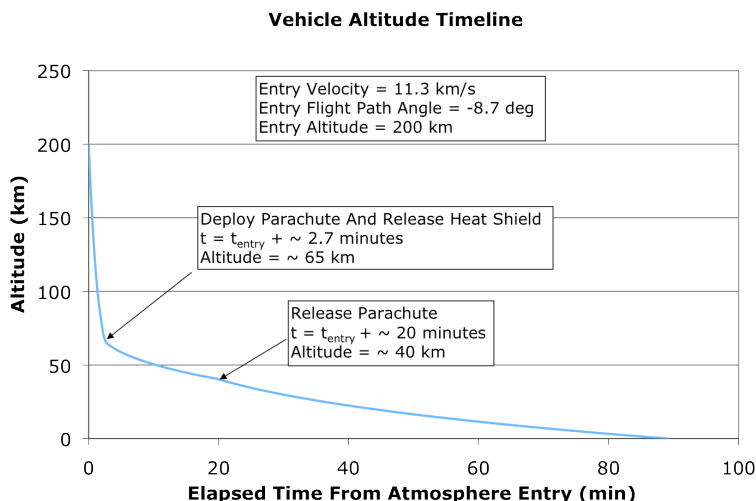

Figure 5.8—Nominal altitude profile during atmospheric entry.

Parachute Sizing

The goal when sizing the parachute was to create a drag area ($C_d * \text{Area}$) large enough that would cause a difference in drag acceleration on the vehicle and the heat shield such that no recontact would occur between the vehicle and heat shield after the heat shield was jettisoned. Table 5.8 shows the assumptions made during the parachute sizing process. It was felt that a difference in acceleration of about 4 m/s^2 between the vehicle and the heat shield would be sufficient to ensure no re-contact after the heat shield was released.

Table 5.8—Assumptions Made During Parachute Sizing

Drag coefficients	
Heat shield	1.2
Vehicle (no chute, no heat shield)	1.0
Parachute	0.7
Parameters at time of chute deployment	
Vehicle velocity	179 m/s
Altitude	65 km
Atmospheric	0.192 kg/m^3
Parachute diameter	
Constructed diameter/inflated diameter	$\pi/2$
Sizing	
Mass/constructed area	0.33 kg/m^2

The drag force acting on the heat shield and the vehicle was calculated from the following equation:

$$\text{Drag Force} = 0.5 \rho v^2 C_d A$$

where:

- ρ = atmospheric density
- v = air relative velocity
- C_d = Drag Coefficient
- A = projected area



With the assumptions in Table 5.8, and assuming a 3.4 m diameter heat shield, the resulting drag on the heat shield after separating from the vehicle is 33.5 kN. Given that the mass of the heat shield is 371 kg, this results in a drag acceleration acting on the heat shield of 90.3 m/s^2 . This means that the acceleration on the vehicle with the inflated parachute, without the heat shield needed to be $\sim 94.3 \text{ m/s}^2$. Since the mass of the vehicle without the heat shield at the time of jettison is 1825 kg, this results in a required drag force of 173 kN. The required drag area ($Cd \cdot A$) to produce 173 kN of force on the vehicle was then calculated to be 56.2 m^2 . The vehicle alone, without the parachute, contributes 9.1 m^2 to the required drag area ($Cd \cdot A$). Subtracting this 9.1 m^2 of drag area from the required 56.2 m^2 of drag area leaves 47.2 m^2 left to be made up by the parachute itself. Assuming a drag coefficient of 0.7 for the parachute, this means that the required inflated area of the parachute is 67.4 m^2 , corresponding to an inflated diameter of 9.3 m. An assumption was then made that the inflated diameter would be a factor of $\pi/2$ smaller than the flat, constructed diameter. This resulted in a required constructed diameter of the parachute to be 14.5 m, corresponding to a total area of 166 m^2 .

Once the cross sectional area was determined, the mass of the parachute was obtained by scaling the mass of the parachute used by the Galileo S/C since the subsystem lead had knowledge of both the cross sectional area and mass of that parachute. The ratio of mass to cross sectional area of the parachute used by the Galileo S/C was 0.33 kg/m^2 . With this knowledge, the mass of the parachute for ALIVE was then estimated to be 54 kg.

5.4.6 GN&C Risk Inputs

At such a shallow flight path angle of -8.7° , there is an increased risk that the vehicle will not get captured by the atmosphere at the time of entry. Increasing the g-load limit would allow for a steeper flight path angle at entry, as would a lower entry velocity. Since the 11.3 km/s entry velocity was just an assumption at the time of this design, it is left as future work to iterate with the mission design lead to design an end to end trajectory that arrives at Venus with a lower entry velocity.

5.4.7 GN&C Recommendation

As previously mentioned, no particular landing site was targeted by the GN&C subsystem. Atmospheric entry conditions were found that did in fact meet the 40 g load requirement for the EDL profile. It remains as future work however to iterate with the mission design lead to develop an end to end trajectory (interplanetary and EDL) that can deliver the vehicle to a specific, targeted landing site while meeting the less than 40 g load requirement.

5.5 Electrical Power System

5.5.1 Power Requirements

Table 5.9 shows the power requirements for the specified mission stages. Ground operations and Launch, Cruise and Flyby and power needs are met by the solar arrays and Li-ion batteries. The Li-ion batteries are used for the Aeroshell/Parachute Descent and contained within a chamber that isn't cooled but maintains acceptable temperatures during its multi-hour descent and duplex startup. Landed Science alternates between a "science" mode that operates for 6 hr continuous and requires 180 W of electrical power and "communications" mode that requires 380 W of power for 18 hr continuous. Because of this power fluctuation we use a combination of Li burner/Stirling and NaS batteries for power leveling. This allows us to operating the Stirling duplex at a constant electrical and cooling output while being able to follow the electrical power transients. Average electrical power is 330 W.

Table 5.9—Power Requirements

	Ground ops and launch	Deploy, cruise and flyby	Drop cruise deck and aeroshell descent	Parachute descent	Landed science mode	Landed comm. mode
	8 hr	6480 hr	1 hr	2 hr	30 hr	90 hr
ALIVE total	47.8	347.1	301.7	384.9	138.7	292.5
ALIVE total with 30% margin (W)	62.1	451.2	392.2	500.4	180.3	380.3
Power (W)						
Lander with 30% margin	39.0	400.0	392.2	500.4	180.3	380.3
Cruise deck with 30% margin	23.1	51.2	N/A	N/A	N/A	N/A
Total lander and cruise deck with 30% margin	62.1	451.2	392.2	500.4	180.3	380.3

5.5.2 Power Assumptions

The following assumptions were defined by the electrical power system lead for the ALIVE mission.

Cruise Deck

- Body mounted arrays are practical for S/C cruise deck
- Li-ion batteries are located in a thermally isolated chamber without the need for separate cooling system along with a phase-change material to control temperature during descent.

Lander

- Stirling Duplex can be integrated into Cold Box
- Li burner can transport its heat to Stirling while only losing 5% of its heat to surroundings
- A Stirling Duplex machine can be made which operates at heat to PV power efficiency of 50% of Carnot at a TR of 1.5.

5.5.3 Power Design and MEL

ALIVE Power System Design

The ALIVE power system consists of two distinct parts. The first is the Cruise Deck power system and the second is the lander power system. The Cruise Deck uses body mounted solar arrays to provide power until the decent at Venus. Although Li-ion batteries are used for load leveling during the trip to Venus, these batteries are located on the Lander and used for descent power. The Lander power system has two distinct systems. The Li-ion batteries (also used during Cruise) power the vehicle during descent. Once on the surface a combination power and cooling by a Stirling duplex power that is driven by heat from the burning of Li and the Venus CO₂ atmosphere.

The engine/cooler system is assumed to be a conventional “Duplex Stirling” configuration in that the cooler and engine share the same mean operating pressure and frequency. Figure 5.9 shows a schematic of a Stirling Duplex.

The convertor employs a simple monolithic heater head / pressure vessel. Figure 5.10 shows an overview of the heat and electrical flows of this single stage duplex system. The convertor hot end materials (Mar-M-243) are based upon those used in the Advanced Radioisotope Stirling Convertor (ASRG) with an upper temperature limit of 850 °C. The ASRG is currently creep life limited at 850 °C at 17 yr and for the short duration of this mission (5 d) we are projecting that an additional 100 °C (950 °C) will be our convertor upper temperature. The Li heat source is connected to the Stirling convertor using a sodium heat pipe. The Li burner is used to heat the gas inside the Stirling convertor that produces P-V work. Some of this work is converted to electrical power via a linear alternator while some of the P-V work drives the cooling stages. The advantage of the duplex system over separate Stirling power and cooling systems is rather than converting all of the PV power to electricity in the Stirling generator and then some

back into piston motion for the cooler, we can use the work directly in the cooler (eliminating the alternator efficiency).

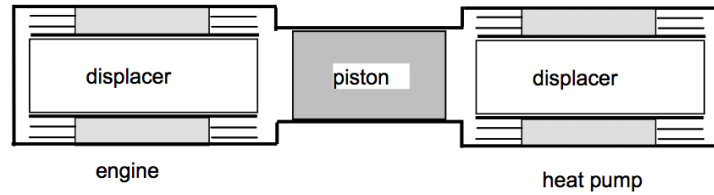

Figure 5.9—Duplex Sketch

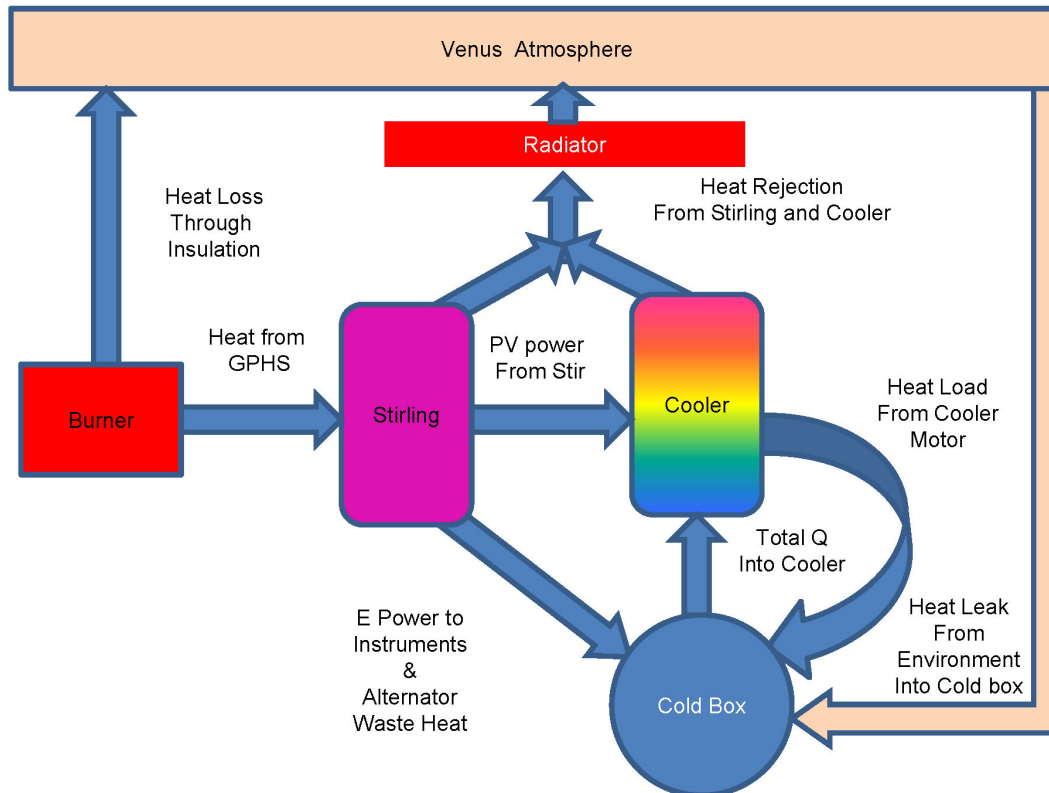

Figure 5.10—Heat and power flows for a Stirling Duplex.

Figure 5.11 shows the design point heat/power flows for the ALIVE Stirling duplex integrated with the cold box that contains the temperature sensitive electronics. This sketch shows an outer shell exposed to the ambient conditions and an inner shell containing the electronics and linear alternator. Approximately 14 kW of heat are generated by the burning of Li with the CO₂ atmosphere. The products of this reaction are lower in density than the reactants and thus create a lower pressure area inside the tank drawing them into the Li tank. The insulation around the burner is sized to allow a 5% heat loss (665 W). Heat is transported to the Stirling duplex via a sodium heat pipe with the condenser being integrated into the Stirling duplex heater head. Approximately 13.3 kW of thermal power are put into the Stirling duplex to drive the cycle. Because of the low temperature ratio (TR) of the cycle (TR = 1.5, T_{hot} = 950 °C, T_{cold} = 500 °C) Stirling convertors fraction of Carnot efficiencies are lower than that seen in other higher temperature ratio convertors (ASRG, TR > 3). While ASRG has a fraction of Carnot efficiency approaching 60% it was assumed that this lower TR convertor would have a fraction of Carnot efficiency of only 50%. Overall PV efficiency was relatively low at 16%. Heat is rejected from the cycle via a pumped NaK loop. An electromagnetic pump (EMP) is used to move the liquid NaK over the cold end of the convertor and removing both the heat from the power generation portion of the system but also the heat from the cold box. Radiator area is 4.4 m² and set by an assumed ΔT across the cold end of the

converter of 25 °C (maximum ΔT in order that cycle efficiency maximized) and 50 °C above the ambient environment (500 °C). The EMP is 5% efficient. Electrical generation efficiency (after alternator and controller) was 15%. Average electrical power required by the system is 330 W. The majority of power generated in the duplex is used for cooling. Approximately 1500 W of PV power go into the cooler portion of the duplex. The cooler is assumed to be 35% of Carnot based on previous analysis of duplex cycles for the Venus atmosphere (VFDRM). Because the temperatures on the Venus surface are well above the allowable temperature of conventional magnets the linear alternator is placed within the cold box generating approximately 23 W of heat. Additionally, both heat led in from the environment and the heat generated from the electronics used to run the lander must also be removed. However, because communication power consumes a significant amount of power, much of the electrical power generated is emitted from the transmitters. Of the 330 W of electrical power generated only 165 W are added to the cold chamber with the rest emitted or used to charge the external load leveling batteries. High temperature NaS batteries are located on the external surface of the lander. After arrival at Venus, the NaS liquefies and the batteries start in a full state of charge. These batteries are used to start the duplex power system and take over for the Li-ion batteries after descent and landing.

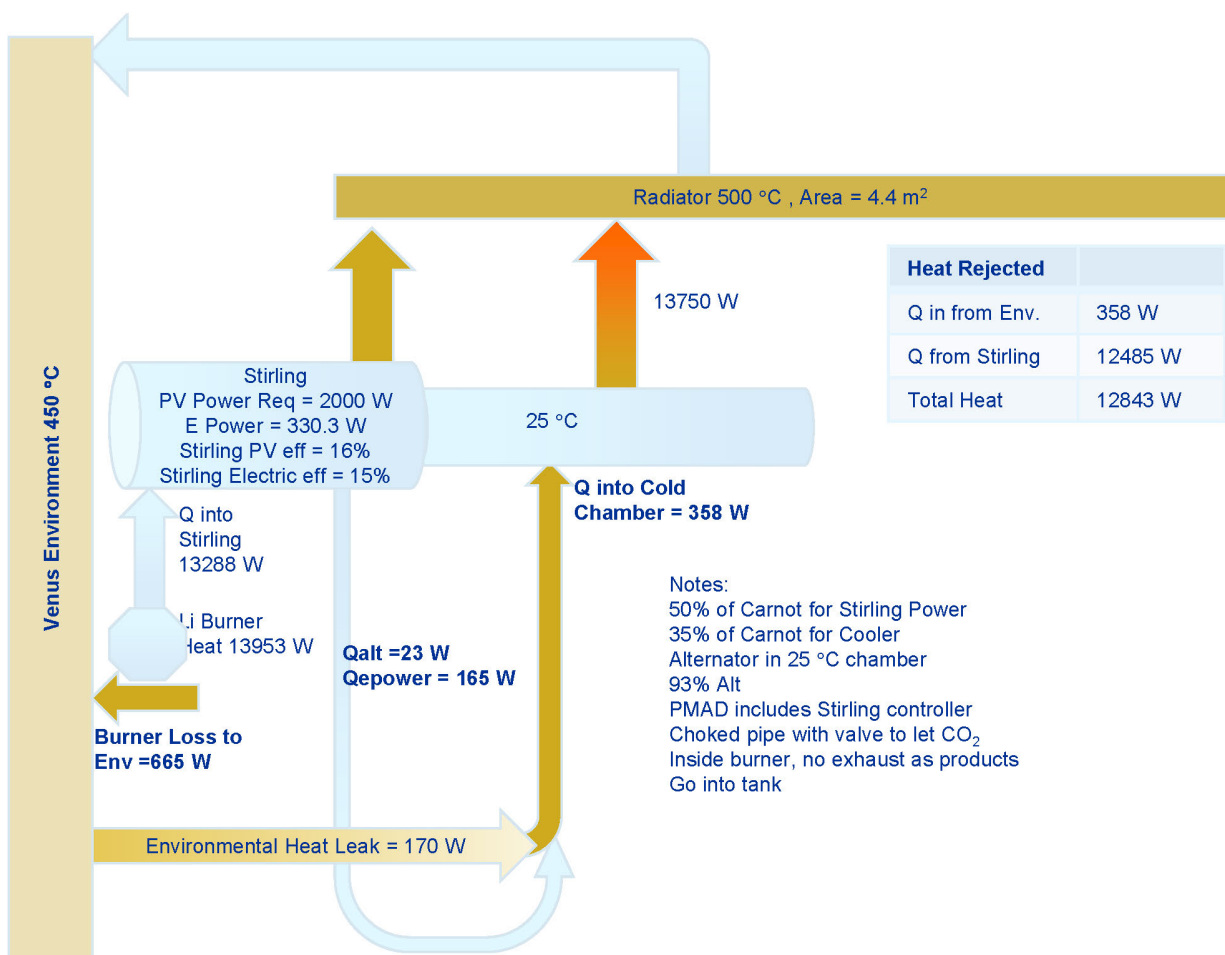

Figure 5.11—Heat and power flows for ALIVE Power and Cooling System.

Figure 5.12 shows an overview of the lander along with the Duplex, Li tank and burner. Additionally the surrounding disk is a conceptual design of the pumped loop radiator that also serves as an additional drag to slow the descending S/C.

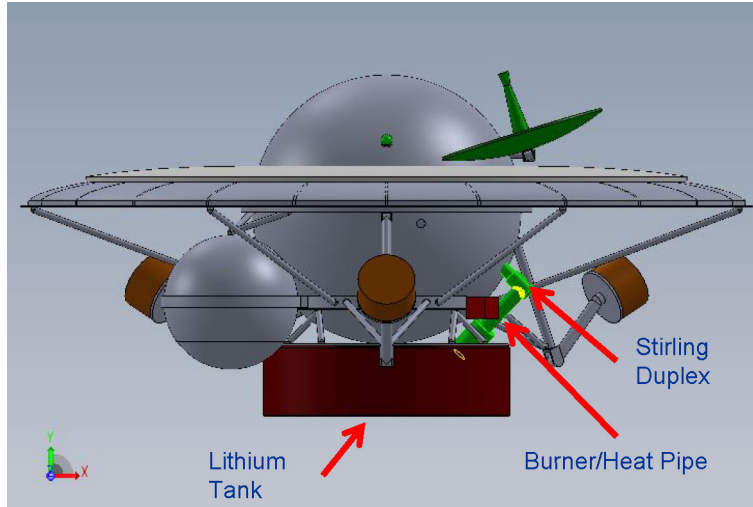

Figure 5.12—ALIVE Power/Cooling System highlights.

Table 5.10 Mass Breakdown of Duplex Power System

Component	Mass (kg)
Stirling Duplex	16
Burner and Insulation	1
Radiator	22
Duplex Controller and PMAD	8
Li Tank	5.5
Li Fuel (5 d)	200
EM Pump (pumped loop radiator)	2
Power Leveling Battery	4
Totals	259

All of the components of the power subsystem and their masses are shown in Table 5.11.

Table 5.11—Electrical Power System ALIVE S/C MEL

WBS	Description	QTY	Unit Mass	Basic Mass	Growth	Growth	Total Mass
Number	Case 1 NIAC Venus Spacecraft CD-2012-72		(kg)	(kg)	(%)	(kg)	(kg)
06	Extended Venus Explorer Spacecraft Design			1917.94	16.1%	308.47	2226.41
06.1	Lander			1079.92	16.4%	177.57	1257.49
06.1.5	Electrical Power Subsystem			277.50	12.2%	33.77	311.27
06.1.5.a	Chemical Power System			265.00	11.8%	31.27	296.27
06.1.5.a.a	Stirling Duplex	1	16.00	16.00	20.0%	3.20	19.20
06.1.5.a.b	Radiator	1	22.00	22.00	20.0%	4.40	26.40
06.1.5.a.c	Lithium Fuel and Tank	1	213.30	213.30	10.0%	21.33	234.63
06.1.5.a.d	PMAD	1	7.80	7.80	20.0%	1.56	9.36
06.1.5.a.e	Power Leveling Battery	1	3.90	3.90	20.0%	0.78	4.68
06.1.5.a.f	EM Pump	1	2.00	2.00	0.0%	0.00	2.00
06.1.5.b	Power Management & Distribution			0.50	20.0%	0.10	0.60
06.1.5.b.d	Burner	1	0.50	0.50	20.0%	0.10	0.60
06.1.5.d	Power Cable and Harness Subsystem (C and HS)			12.00	20.0%	2.40	14.40
06.1.5.d.a	Spacecraft Bus Harness	1	12.00	12.00	20.0%	2.40	14.40
06.3	Cruise Deck			229.25	9.4%	21.44	250.69
06.3.5	Electrical Power Subsystem			33.00	3.0%	1.00	34.00
06.3.5.c	Solar Array Power System			28.00	0.0%	0.00	28.00
06.3.5.c.a	Body Mounted Solar Array	1	25.00	25.00	0.0%	0.00	25.00
06.3.5.c.b	Batteries	1	3.00	3.00	0.0%	0.00	3.00
06.3.5.d	Power Cable and Harness Subsystem (C and HS)			5.00	20.0%	1.00	6.00
06.3.5.d.a	Spacecraft Bus Harness	1	5.00	5.00	20.0%	1.00	6.00

Technology Maturity

- Solar arrays = TRL-6
- Stirling Duplex = TRL-3
- Li/CO₂ Burner = TRL-3

5.5.4 Power Trades

Power trades were performed on mission duration. Mission duration was varied until the landed Li and tank mass allowed the lander to fit within its mass limits.

5.5.5 Power Analytical Methods

A spreadsheet Stirling duplex sizing tool that was developed for the radioisotope Venus duplex was used for this mission study. It was modified to add the burner and Li fuel and tank.

5.5.6 Power Risk Inputs

The following are the power risks:

- Unable to make a Stirling power portion operate as 50% of Carnot at a temperature ratio of 1.5.
- Unable to make a Stirling cooler operate at 35% of Carnot.
- Unable to effectively integrate Li burner/Stirling duplex
- Unable to create a closed (i.e., no release to atmosphere) Li/ CO₂ burner

5.5.7 Power Recommendation

The following are the future work and recommendations from the power subsystem lead:

- More detailed design of the heat pipe to Stirling duplex interface
- Preliminary design of Stirling duplex to ensure regenerator length can match insulation thickness requirements.
- Consider higher temperature electronics

5.6 Propulsion System

(Entire section 5.6 and subsections provided by the Power Seat, except for the MEL, provided by the Systems Integration Lead)

5.6.1 Propulsion System Requirements

The propulsion system is required to provide adequate total impulse, at an acceptable thrust level, to perform trajectory adjustments and maintain proper vehicle orientation during the cruise to Venus. Prior to jettisoning the cruise stage, the propulsion system is required to orient the S/C to the desired orientation for Venus atmospheric entry.

In order to reduce risk and cost, the propulsion system is required to be single fault tolerant, and composed of high TRL level COTS components.

Finally, propellant is to be stored and provided at the conditions and flow rates required by the propulsion system, regardless of the number of thrusters firing at any given time.

5.6.2 Propulsion System Assumptions

It is assumed that a single fault tolerant hydrazine based blow down system is used. It is also assumed that small thrusters are used for S/C orientation, while larger thrusters in the axial direction are used for trajectory adjustments.

5.6.3 Propulsion System Design and MEL

The entire propulsion system is located on the cruise deck, which is jettisoned prior to Venus atmospheric entry. The system is comprised of sixteen thrusters, located in four clusters containing four thrusters each, two nitrogen pressurized commercial off-the-shelf membrane tanks, and a single fault tolerant feed system.

Each cluster of thrusters contains three MR-103C thrusters which can deliver 0.9 N (0.2 lbf) of thrust at a nominal ISP of 220 s, and are used to provide fine attitude control. Each cluster also has one larger MR-106E thruster delivering 22.3 N (5.0 lbf) of thrust at a nominal Isp of 230 s, and are used to provide axial thrust.

All four clusters are feed hydrazine propellant via a single fault tolerant feed system comprised of various COTS components, a nominal instrumentation suite including Pain Electronics flight certified pressure sensors and thermocouples, tank and line heaters, and MLI. The system is fueled via a set of Vacco V1E10430-01 fill and drain valves, which are flight qualified and have a metal to metal primary seat. The propellant is filtered via Vacco F1D10638-01 15 μm absolute propellant filters. Tank isolation is provided by three MOOG 51-166 valves, although pyrotechnic valves could be substituted. The hydrazine is stored in two ATK 80275-1 Ti alloy (Ti-6Al-4V) spherical membrane tanks with a volume of 37.69 L (2300 in³) and a MOP of 30 bar (435 psia). Some of the feed system components are shown in Figure 5.13, and a preliminary P&ID of the system is shown in Figure 5.14.



Figure 5.13—Feed System components.

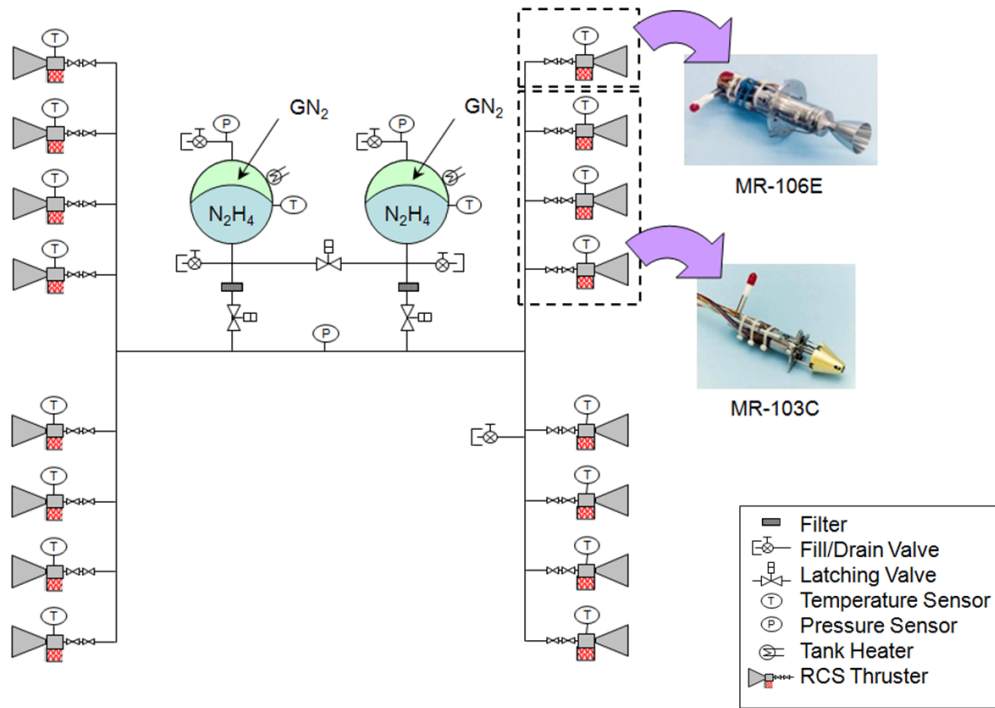

Figure 5.14—Preliminary Cruise Deck Propulsion P&ID

The total propellant mass is calculated using information from both the trajectory mission analysis output, as well as internal propellant and propulsion system calculations. The three different propellants tracked in the MEL are: Used, Residuals, and Performance Margin. These are defined as follows:

Used.—The used propellant is calculated using an ideal equation. This is the propellant necessary to push the mass of the S/C using the total mission ΔV and the idealized form of the rocket equation. There is no margin on the used propellant.

Performance Margin.—The performance margin is calculated by taking a percentage of the propellant use for total ΔV performed by that particular propulsion system. For this analysis, 10% is used.

Residuals.—The residuals are calculated by taking the total mass of the used and margin propellants, and calculating a percentage of that mass. For this analysis, 3.5% is used to calculate the residual hydrazine mass.

Total propellant.—The total propellant of the mission is the sum of used, margin and residuals.

$$m_{\text{TotalPropellant}} = m_{\text{Used}} + m_{\text{Margin}} + m_{\text{Residuals}}$$

These divisions of propellant are used in the calculation of dry, wet and inert mass of the total S/C. A listing of all major propulsion system component masses as captured in the MEL shown in Propulsion System Trades

There were no propulsion system trades conducted for this study.

5.6.4 Propulsion System Analytical Methods

The methods used to design the propulsion system involve using a mix of published values, empirical data, and analytical tools. Published values and empirical data are used wherever possible, with analytical tools being used as necessary. These include National Institute of Standards and Technology (NIST) tables, CEA, and other fluid/gas property codes, as well as custom tools developed from basic physical relationships and conservation equations with empirical based inclusions for real life hardware requirements (mounting bosses, flanges, etc.).

Table 5.12.

5.6.5 Propulsion System Trades

There were no propulsion system trades conducted for this study.

5.6.6 Propulsion System Analytical Methods

The methods used to design the propulsion system involve using a mix of published values, empirical data, and analytical tools. Published values and empirical data are used wherever possible, with analytical tools being used as necessary. These include National Institute of Standards and Technology (NIST) tables, CEA, and other fluid/gas property codes, as well as custom tools developed from basic physical relationships and conservation equations with empirical based inclusions for real life hardware requirements (mounting bosses, flanges, etc.).

Table 5.12—Propulsion System ALIVE S/C MEL



WBS	Description	QTY	Unit Mass	Basic Mass	Growth	Growth	Total Mass
Number	Case 1 NIAC Venus Spacecraft CD-2012-72		(kg)	(kg)	(%)	(kg)	(kg)
06	Extended Venus Explorer Spacecraft Design			1917.94	16.1%	308.47	2226.41
06.3	Cruise Deck			229.25	9.4%	21.44	250.69
06.3.7	Propulsion (Chemical Hardware)			30.52	5.2%	1.58	32.10
06.3.7.a	Primary Chemical System Hardware			11.04	4.9%	0.54	11.58
06.3.7.a.b	Reaction Control System Hardware			11.04	4.9%	0.54	11.58
06.3.7.a.b.b	RCS Thruster Subassembly	4	0.50	2.00	18.0%	0.36	2.36
06.3.7.a.b.c	Large RCS Thrusters	4	1.27	5.08	2.0%	0.10	5.18
06.3.7.a.b.d	Small RCS Thrusters	12	0.33	3.96	2.0%	0.08	4.04
06.3.7.b	Propellant Management (Chemical)			19.48	5.3%	1.04	20.52
06.3.7.b.b	RCS Propellant Management			19.48	5.3%	1.04	20.52
06.3.7.b.b.a	Fuel Tanks	2	7.71	15.42	2.0%	0.31	15.73
06.3.7.b.b.f	Feed System - regulators, valves, etc	1	4.06	4.06	18.0%	0.73	4.80

Thrust requirements and propellant load are determined by GN&C analysis. Using those results, the tanks are selected so that both adequate propellant and tank pressure are available to ensure proper propulsion system performance during the entire mission, and that adequate engine performance is available to meet both vehicle and mission requirements and constraints.

5.6.7 Propulsion System Risk Inputs

One constant risk with hydrazine is the possibility of it freezing, especially on the shadow side of the S/C, which could cause a loss of mission. Detailed thermal analysis, however, can provide MLI and strip heater power requirements that minimize this risk.

5.6.8 Propulsion System Recommendation

Since the propellant tanks are COTS, they are slightly oversized for their respective propellant loads. Therefore, it is recommended that the hydrazine tanks be filled to capacity to provide additional delta-V margin, assuming that this doesn't negatively impact S/C wet mass and/or LV launch margin to an unacceptable degree.

Another recommendation is to conduct a propellant trade of hydroxyl-ammonium nitrate (HAN) based monopropellants versus hydrazine. Although this mission doesn't really require the cold temperature capability of the HAN monopropellants, their lack of toxicity relative to hydrazine may lower ground handling related costs. As of this writing, however, HANs are still undergoing materials compatibility testing, and thus may be too risky for this class of mission in the near term.

5.7 Structures and Mechanisms

(Entire section 5.8? and subsections provided by the Structures Seat, except the MEL, which is provided by Systems Integration Lead)

5.7.1 Structures and Mechanisms Requirements

The S/C must contain the necessary hardware for research instrumentation, avionics, communications, power, and propulsion. It must be able to withstand applied loads from the LV, landing on the Venus surface, and operating in the Venetian environment. The maximum axial acceleration of 44 g (430 m/s², 1420 ft/s²) is during descent to the Venetian surface. The Venus surface is at approximately 480 °C (900 °F) in temperature and 9 MPa (1300 psi) pressure. In addition, the S/C bus has to provide minimum deflections, sufficient stiffness, and vibration damping. Weight has to be kept to a minimum and the stowed S/C must fit the confines of the LV.

Mechanisms are used to separate from the LV, jettison the heat shield, deploy landing legs, and jettison the backshell.

5.7.2 Structures and Mechanisms Assumptions

The S/C bus provides the main backbone for the S/C. It is constructed of a Ti alloy, Ti-6Al-4V. The Cruise Deck is a simple frustum, also, constructed of the Ti alloy, Ti-6Al-4V. The Ti alloy, used in the construction of the S/C, is specified in the Federal Aviation Administration's Metallic Materials Properties Development and Standardization (MMPDS) (2006). The main bus consists of a sphere and strut mounted hardware.

5.7.3 Structures and Mechanisms Design and MEL

The main bus of the Lander consists of a sphere, which provides the most efficient approach for surviving the Venus environment while keeping mass to a minimum. Secondary components, such as struts and mounting flanges/rings consist of Ti also.

The fuel container is cylindrical. The inside of the container is exposed to the Venetian atmospheric pressure. This negates the need for thick walls relative to the main spherical bus. A ring flange, mounted to the top of the tank, is utilized to attach the support struts from the S/C to the tank.

A smaller Ti sphere is used to house the science instruments. A mounting ring is located equatorially around the science sphere and is used to attach the struts that support the sphere to the S/C.

Landing gear consists of rigid tubular members. The main tube of each landing leg has a lockable hinge to allow stowing the landing gear within the aeroshell assembly. Crushable Ti honeycomb, mounted to the base of each pad, is used to absorb the energy upon landing on the surface of Venus. The honeycomb is a commercial component, Benecor, Inc. Ti3AL2.5V Honeycomb 9.56 (.125/.002).

Tubular members support and attach the radiators to the S/C. Similarly, ring flanges, ribs, and tubular struts are used to mount aero drag flaps to the S/C. Figure 5.15 illustrates the Lander in stowed and deployed states.

Pyrotechnic fasteners are specified for all the separation planes. The devices provide a simple, reliable, and light weight approach for handling the separation of the various components.

Table 5.13 shows the expanded MEL for the structures subsystem on the EZE Lander platform. This MEL breaks down the structures line elements to the lowest WBS.

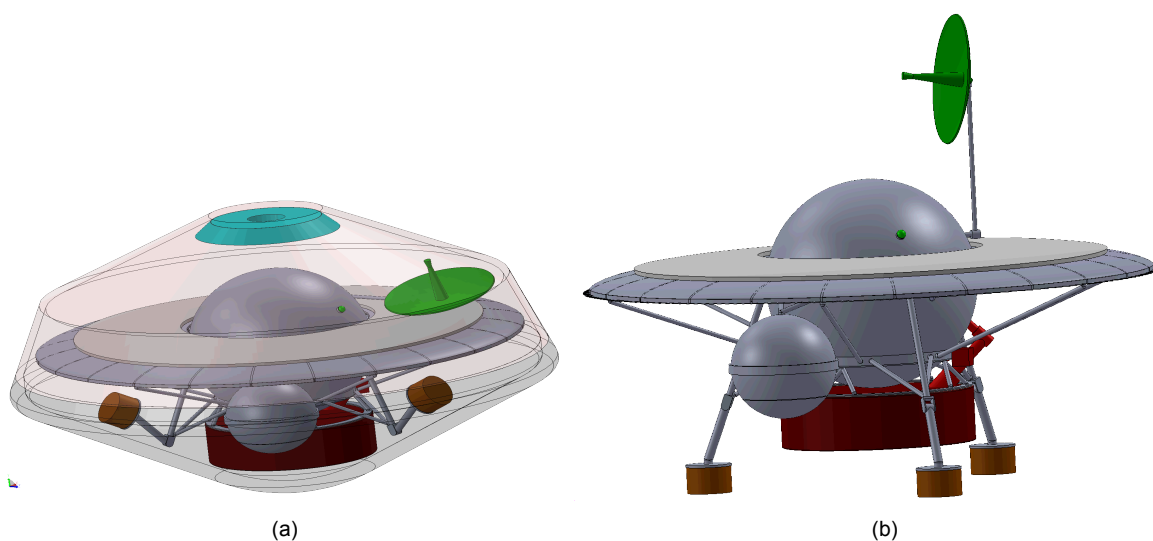

Figure 5.15—(a) The Lander stowed within the heat shield/backshell assembly and (b) the Lander fully deployed.



Table 5.13—ALIVE S/C Structures MEL

WBS	Description	QTY	Unit Mass	Basic Mass	Growth	Growth	Total Mass
Number	Case 1 NIAC Venus Spacecraft CD-2012-72		(kg)	(kg)	(%)	(kg)	(kg)
06	Extended Venus Explorer Spacecraft Design			1917.94	16.1%	308.47	2226.41
06.1	Lander			1079.92	16.4%	177.57	1257.49
06.1.11	Structures and Mechanisms			513.91	18.0%	92.50	606.42
06.1.11.a	Structures			491.23	18.0%	88.42	579.65
06.1.11.b	Mechanisms			22.68	18.0%	4.08	26.76
06.2	Aeroshell			608.77	18.0%	109.47	718.24
06.2.11	Structures and Mechanisms			181.85	18.0%	32.73	214.58
06.2.11.a	Structures			150.44	18.0%	27.08	177.51
06.2.11.b	Mechanisms			31.41	18.0%	5.65	37.07
06.3	Cruise Deck			229.25	9.4%	21.44	250.69
06.3.11	Structures and Mechanisms			88.01	18.0%	15.84	103.86
06.3.11.a	Structures			75.88	18.0%	13.66	89.54
06.3.11.b	Mechanisms			12.13	18.0%	2.18	14.31

Table 5.14—Lander Structures MEL

WBS	Description	QTY	Unit Mass	Basic Mass	Growth	Growth	Total Mass
Number	Case 1 NIAC Venus Spacecraft CD-2012-72		(kg)	(kg)	(%)	(kg)	(kg)
06	Extended Venus Explorer Spacecraft Design			1917.94	16.1%	308.47	2226.41
06.1	Lander			1079.92	16.4%	177.57	1257.49
06.1.11	Structures and Mechanisms			513.91	18.0%	92.50	606.42
06.1.11.a	Structures			491.23	18.0%	88.42	579.65
06.1.11.a.a	<i>Primary Structures</i>			322.75	18.0%	58.10	380.85
06.1.11.a.a.a	Primary structure, sphere	1	234.95	234.95	18.0%	42.29	277.24
06.1.11.a.a.b	Flange assy., sphere middle	1	22.50	22.50	18.0%	4.05	26.55
06.1.11.a.a.c	Ring, hardware mounting	1	8.34	8.34	18.0%	1.50	9.84
06.1.11.a.a.d	Sphere, science	1	56.96	56.96	18.0%	10.25	67.22
06.1.11.a.b	<i>Secondary Structures</i>			168.48	18.0%	30.33	198.80
06.1.11.a.b.a	Fuel tank mount assembly	1	19.63	19.63	18.0%	3.53	23.16
06.1.11.a.b.b	Landing gear assembly	1	135.83	135.83	18.0%	24.45	160.28
06.1.11.a.b.c	Radiator support	1	1.06	1.06	18.0%	0.19	1.26
06.1.11.a.b.d	Science sphere mounts	1	2.62	2.62	18.0%	0.47	3.09
06.1.11.a.b.e	Flange, heat shield to fuel tank	1	9.34	9.34	18.0%	1.68	11.03
06.1.11.b	Mechanisms			22.68	18.0%	4.08	26.76
06.1.11.b.f	<i>Installations</i>			22.68	18.0%	4.08	26.76
06.1.11.b.f.b	ECLSS Installation	1	1.59	1.59	18.0%	0.29	1.88
06.1.11.b.f.c	GN&C Installation	1	5.70	5.70	18.0%	1.03	6.73
06.1.11.b.f.d	Command and Data Handling Installation	1	0.90	0.90	18.0%	0.16	1.07
06.1.11.b.f.e	Communications and Tracking Installation	1	1.95	1.95	18.0%	0.35	2.30
06.1.11.b.f.f	Electrical Power Installation	1	11.10	11.10	18.0%	2.00	13.10
06.1.11.b.f.g	Thermal Control Installation	1	1.43	1.43	18.0%	0.26	1.69

Table 5.15—Aeroshell Structures MEL

WBS	Description	QTY	Unit Mass	Basic Mass	Growth	Growth	Total Mass
Number	Case 1 NIAC Venus Spacecraft CD-2012-72		(kg)	(kg)	(%)	(kg)	(kg)
06	Extended Venus Explorer Spacecraft Design			1917.94	16.1%	308.47	2226.41
06.2	Aeroshell			608.77	18.0%	109.47	718.24
06.2.11	Structures and Mechanisms			181.85	18.0%	32.73	214.58
06.2.11.a	Structures			150.44	18.0%	27.08	177.51
06.2.11.a.a	<i>Primary Structures</i>			135.86	18.0%	24.46	160.32
06.2.11.a.a.a	Aeroshell back	1	135.86	135.86	18.0%	24.46	160.32
06.2.11.a.b	<i>Secondary Structures</i>			14.57	18.0%	2.62	17.19
06.2.11.a.b.a	Flange, aeroshell back to chute housing	1	5.23	5.23	18.0%	0.94	6.17
06.2.11.a.b.b	Flange, heat shield to fuel tank	1	9.34	9.34	18.0%	1.68	11.03
06.2.11.b	Mechanisms			31.41	18.0%	5.65	37.07
06.2.11.b.e	<i>Adaptors and Separation</i>			14.40	18.00%	2.59	16.99
06.2.11.b.e.a	Pyrotechnic fasteners & springs, heat shield	6	1.20	7.20	18.00%	1.30	8.50
06.2.11.b.e.c	Pyrotechnic fasteners & springs, back shell	6	1.20	7.20	18.00%	1.30	8.50
06.2.11.b.f	<i>Installations</i>			17.01	18.00%	3.06	20.07
06.2.11.b.f.c	GN&C Installation	1	2.16	2.16	18.00%	0.39	2.55
06.2.11.b.f.g	Thermal Control Installation	1	14.85	14.85	18.00%	2.67	17.53

Table 5.16—Cruise Deck Structures MEL

WBS	Description	QTY	Unit Mass	Basic Mass	Growth	Growth	Total Mass
Number	Case 1 NIAC Venus Spacecraft CD-2012-72		(kg)	(kg)	(%)	(kg)	(kg)
06	Extended Venus Explorer Spacecraft Design			1917.94	16.1%	308.47	2226.41
06.3	Cruise Deck			229.25	9.4%	21.44	250.69
06.3.11	Structures and Mechanisms			88.01	18.0%	15.84	103.86
06.3.11.a	Structures			75.88	18.0%	13.66	89.54
06.3.11.a.a	<i>Primary Structures</i>			70.66	18.0%	12.72	83.38
06.3.11.a.a.a	Main Cruise Deck Structure	1	70.66	70.66	18.0%	12.72	83.38
06.3.11.a.b	<i>Secondary Structures</i>			5.23	18.0%	0.94	6.17
06.3.11.a.b.a	Flange, aeroshell back to chute housing	1	5.23	5.23	18.0%	0.94	6.17
06.3.11.b	Mechanisms			12.13	18.0%	2.18	14.31
06.3.11.b.e	<i>Adaptors and Separation</i>			7.20	18.00%	1.30	8.50
06.3.11.b.e.a	Pyrotechnic fasteners & springs	6	1.20	7.20	18.00%	1.30	8.50
06.3.11.b.f	<i>Installations</i>			4.93	18.00%	0.89	5.82
06.3.11.b.f.c	GN&C Installation	1	0.14	0.14	18.00%	0.02	0.16
06.3.11.b.f.f	Electrical Power Installation	1	1.32	1.32	18.00%	0.24	1.56
06.3.11.b.f.i	Chemical Propulsion Installation	1	3.47	3.47	18.00%	0.62	4.10

5.7.4 Structures and Mechanisms Trades

No trades for structural design were considered for this study.

5.7.5 Structures and Mechanisms Analytical Methods

The high pressure and temperature of the atmosphere on the surface of Venus provides challenges for maintaining the structural integrity of a Lander. All the main structural components are fabricated from the Ti alloy, Ti-6Al-4V. The high pressure environment causes potential issues with buckling of the structure. The sphere of the main bus was checked for buckling and the wall thickness was specified to minimize the risk. The equation, presented by Young’s and Budynas’ Roark’s Formulas for Stress and Strain (2002), for determining the external pressure for buckling a sphere is

$$(1)$$

The equation represents a probable actual minimum pressure to cause buckling. The variables from the equation are



P = pressure to cause buckling
E = Young's modulus of the material
t = wall thickness of the sphere
r = radius of the sphere

Solving Equation (1) for the wall thickness and applying a safety factor of 1.5 results in a minimum wall thickness of 12 mm (0.47 in). The sphere for the science instruments has the same wall thickness as the main bus sphere.

The original drag flap design had the supports cantilevered out from the center. The expected 2000 kg mass at the given stage of the trajectory and 44 g (430 m/s², 1411 ft/s²) deceleration significantly exceeded the strength limits of the structure. As a result, support struts were added around the outer perimeter of the drag flaps.

The crushable honeycomb pads on each leg of the landing gear were sized to limit the deceleration to 40 g (390 m/s², 1280 ft/s²) upon landing. The approach velocity is estimated to be 6.3 m/s (250 in/s). Using the physics equations of motion the resulting necessary displacement of the crushable honeycomb pads is a minimum of 0.051 m (2.0 in).

Assuming the landing load is distributed evenly among the three landing legs the force per leg is 141 kN (31,700 lbf). The necessary diameter of each pad is 312 mm (12.3 in) for a Ti honeycomb that has a high temperature ultimate strength of 5.76 MPa (835 psi). The honeycomb pads are sized to have the applied load induce a stress at the approximate ultimate strength of the honeycomb.

A quick check was made to size the lower standoffs between the spheres of the double walled main bus structure. The inner sphere and its contained hardware were estimated to be 100 kg (220 lb). A maximum of 200 g (1960 m/s², 6430 ft/s²) is anticipated. Four supports or standoffs at 30° from the vertical are assumed for the lower support. Using tubes of 5 cm (2.0 in.) OD with 3 mm (0.12 in.) thick walls the resulting maximum stress is approximately 128 MPa (18.5 ksi). The yield strength of Ti-6Al-4V is approximately 530 MPa (77 ksi) as per the Federal Aviation Administration's MMPDS (2006). Using a safety factor of 1.5 provides a material limit of 350 MPa (51 ksi). The resulting margin is 1.7.

An additional installation mass was added for each subsystem. These installations were modeled using 4% of the CBE dry mass of each of the subsystems. The 4% magnitude for an initial estimate compares well with values reported by Heineman (1994) for various systems. This is to account for attachments, bolts, screws and other mechanisms necessary to attach the subsystem elements to the bus structure and not book kept in the individual subsystems.

5.7.6 Structures and Mechanisms Risk Inputs

Structural risks may include excessive g loads, impact from a foreign object, or harsh landing on Venus which may cause too much deformation, vibrations, or fracture of sections of the support structure. Consequences include lower performance from mounted hardware to loss of mission.

Excessive deformation of the structure can misalign components dependent on precise positioning, therefore, diminishing their performance. Internal components may be damaged or severed from the rest of the system resulting in diminished performance or incapacitation of the system. Excessive vibrations may reduce instrumentation performance and/or potentially lead to long term structural failure due to fatigue. Overall, the mission may not be completed in an optimum manner or it can be terminated in the worst case.

In an effort to mitigate the structural risk the structure is to be designed to NASA standards to withstand expected g loads, a given impact, and to have sufficient stiffness and damping to minimize issues with vibrations. Trajectories are to be planned to minimize the probability of impact with foreign objects.

Similar to the structural risks excessive g loads, impact from a foreign object, or harsh landing may damage mechanisms. Consequences include lower performance from mounted hardware to loss of mission.

Failure of mechanisms may prevent optimum hardware operation or may inhibit mission completion. Failure of separation or deployment units can prevent planned mission completion.

Mitigation of the risks with mechanisms would include the mechanisms are to be designed to NASA standards to withstand expected environmental conditions. All precautions should be taken to prevent damage from installation, launch, and operating conditions.

5.7.7 Structures and Mechanisms Recommendation

Mass savings may be realized with different materials and architectures. Although, the harsh environment presented by Venus may limit material selection. Sandwich construction composites, isogrids, or orthogrids may be considered. A detailed stress analysis using numerical methods may be applied to optimize the design for the anticipated mission loads.

5.8 Thermal Control

The thermal control system for the Venus lander mission is broken down in the thermal control for the various segments of the mission, transit to Venus, entry into the Venus atmosphere and operation on the Venus surface. The thermal control system for each stage in the mission is described in the following sections.

5.8.1 Cruise Deck Thermal Control

The cruise deck thermal control system has to protect and regulate the temperature of the S/C and lander as it transits from Earth to Venus. The Stirling cooler cools the components within the lander during transit. The heat removed by the cooler must be rejected to space through the use of a radiator on the cruise deck. The environment in which the thermal control system has to operate to maintain the desired internal operating temperature of the electronics and lander varies from near Earth operation to deep space transit to operation near Venus. The sizing of the components of the thermal system is based on operation within this environment. The heat transfer to and from the S/C is based on a radiative energy balance between the vehicle and its surroundings. Solar radiation is the main source of external heat for the majority of the mission, during transit. Operation near Earth and Venus also involves the albedo (reflected sunlight) from the planet as well as direct radiation (infrared (IR)) from the planet itself. These environmental conditions are listed in Table 5.17.

Table 5.17—Transit Environment Constants

Constant	Earth	Venus
Solar Intensity	1360 W/m ²	2613 W/m ²
Albedo	0.3	0.75
Planet IR	240 W/m ²	141 W/m ²

To maintain the S/C and lander components at their desired operating temperature the following components were utilized for the cruise deck thermal control.

- Electric heaters, thermocouples and data acquisition for controlling the temperature of the electronics.
- MLI for insulating the electronics and temperature sensitive components.
- Thermal paint for minimal thermal control on exposed structural surfaces.
- Radiator for rejecting heat from the enclosed lander.
- Cold plates with heat pipe connections to the radiator, for channeling the heat from the lander to the radiator.

5.8.2 Electric Heaters

The electric heaters were used to provide added thermal control to the cruise deck electronics during transit. Strip heaters, as shown in Figure 5.16, were used to provide heat to the reaction control system propellant lines and other components within the cruise deck. Thermal control is accomplished through the use of a network of thermocouples whose output is used to control the power to the various heaters. A data acquisition and control computer is used to operate the thermal system.

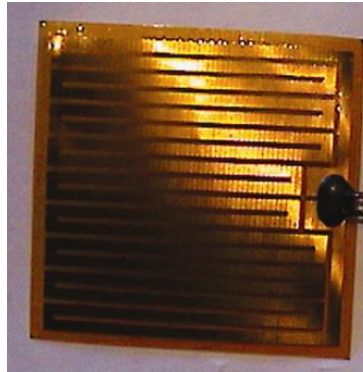

Figure 5.16—DuPont Kapton Strip Heater.

The mass breakdown of the thermal system for the ALIVE is shown in Table 5.18.

Table 5.18—Thermal ALIVE S/C MEL

WBS	Description	QTY	Unit Mass	Basic Mass	Growth	Growth	Total Mass
Number	Case 1 NIAC Venus Spacecraft CD-2012-72		(kg)	(kg)	(%)	(kg)	(kg)
06	Extended Venus Explorer Spacecraft Design			1917.94	16.1%	308.47	2226.41
06.1	Lander			1079.92	16.4%	177.57	1257.49
06.1.6	Thermal Control (Non-Propellant)			35.79	18.0%	6.44	42.23
06.1.6.a	Active Thermal Control			1.50	18.0%	0.27	1.77
06.1.6.a.c	Data Acquisition	1	1.00	1.00	18.0%	0.18	1.18
06.1.6.a.d	Thermocouples	5	0.10	0.50	18.0%	0.09	0.59
06.1.6.b	Passive Thermal Control			34.29	18.0%	6.17	40.46
06.1.6.b.a	Heat Sinks	4	0.14	0.55	18.0%	0.10	0.65
06.1.6.b.b	Heat Pipes	4	0.21	0.84	18.0%	0.15	0.99
06.1.6.b.c	Electronics Enclosure Insulation	1	32.89	32.89	18.0%	5.92	38.81
06.2	Aeroshell			608.77	18.0%	109.47	718.24
06.2.6	Thermal Control (Non-Propellant)			371.29	18.0%	66.83	438.13
06.2.6.b	Passive Thermal Control			371.29	18.0%	66.83	438.13
06.2.6.b.a	Ablative Material	1	371.29	371.29	18.0%	66.83	438.13
06.3	Cruise Deck			229.25	9.4%	21.44	250.69
06.3.6	Thermal Control (Non-Propellant)			10.34	18.0%	1.86	12.20
06.3.6.a	Active Thermal Control			2.90	18.0%	0.52	3.42
06.3.6.a.b	Thermal Controller	2	0.20	0.40	18.0%	0.07	0.47
06.3.6.a.c	Data Acquisition	2	1.00	2.00	18.0%	0.36	2.36
06.3.6.a.d	Thermocouples	5	0.10	0.50	18.0%	0.09	0.59
06.3.6.b	Passive Thermal Control			5.56	18.0%	1.00	6.56
06.3.6.b.c	Electronics Enclosure Insulation	1	5.56	5.56	18.0%	1.00	6.56
06.3.6.c	Semi-Passive Thermal Control (cruise deck and internal)			1.88	18.0%	0.34	2.21
06.3.6.c.c	Radiator	1	1.88	1.88	18.0%	0.34	2.21

5.8.1 MLI and Thermal Control Paint

MLI was used to insulate the cruise deck electronic components and exposed propellant tanks to minimize their heat loss for deep space operation. MLI is constructed of a number of layers of metalized material with a nonconductive spacer between the layers. The metalized material has a low absorptivity that resists radiative heat transfer between the layers. The insulation can be molded to conform over the exterior of the cruise deck or any individual component, as shown in Figure 5.17.

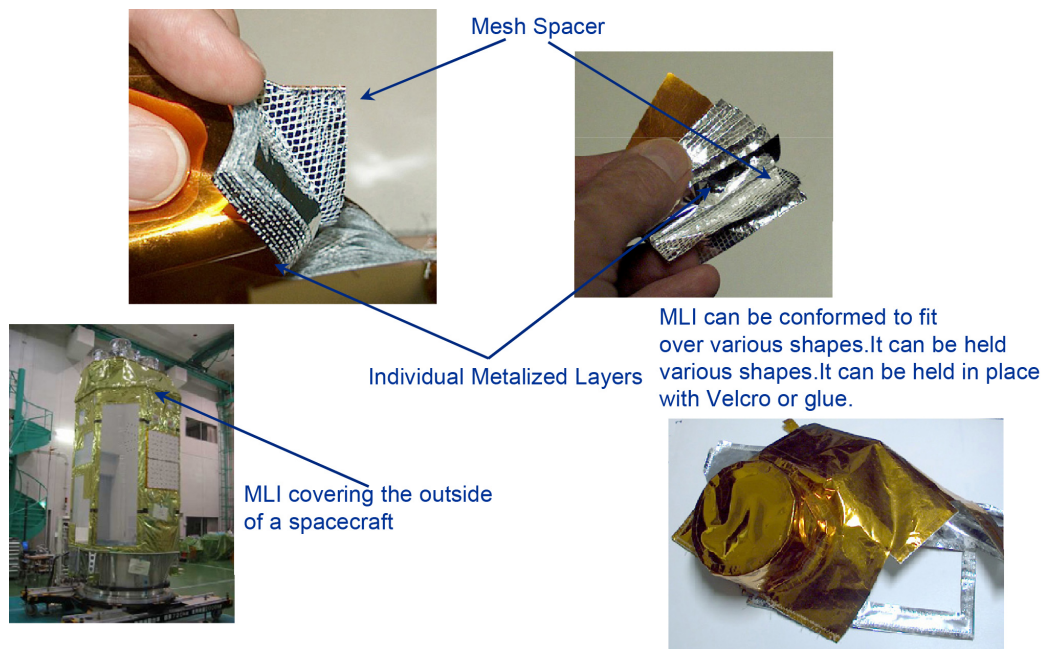

Figure 5.17—Example of MLI blanket design and application.

In exposed areas where MLI cannot be applied, mainly exposed structural components, thermal control paint is applied. Since the S/C will be exposed to direct sunlight for the majority of its operation, this paint is used to minimize the absorption of solar radiation. This helps maintain thermal control of the vehicle by minimizing the temperature of exposed components. The paint utilized is AZ-93. Its characteristics are listed in Table 5.19.

Table 5.19—MLI Specifications

Variable	Value
MLI Emissivity.....	0.07
MLI Material.....	Metalized (Al) Kapton layers
Layer Thickness	0.025 mm
Number of MLI layers	25
AZ-93 Emissivity.....	0.91
AZ-93 Absorptivity	0.15

5.8.2 Radiator and Cold Plates

To reject heat from the lander during transit from the Earth to Venus, a radiator was utilized. This radiator was coupled to the hot end of the Stirling cooler through a cold plate interface. The Stirling cooler was used to remove any waste heat from the interior of the lander during transit. Heat pipes were used to move heat from the cold plate to the radiator panel, which then rejected the heat to space. An example of a cold plate with integral heat pipes is shown in Figure 5.18. The radiator was sized for operation near Venus. This is the worst case operating condition for rejecting heat from the radiator. The radiator was coated to limit its solar radiation absorption characteristics. The details on the radiator sizing are given in Table 5.20.

The radiator was surface mounted to the cruise deck and therefore rejected heat from one side. The radiator was sized based on an energy balance approach, utilizing the thermal heat needed to be rejected and the incoming thermal radiation from Venus and the sun. An example of a S/C radiator with integral heat pipes is shown in Figure 5.19.

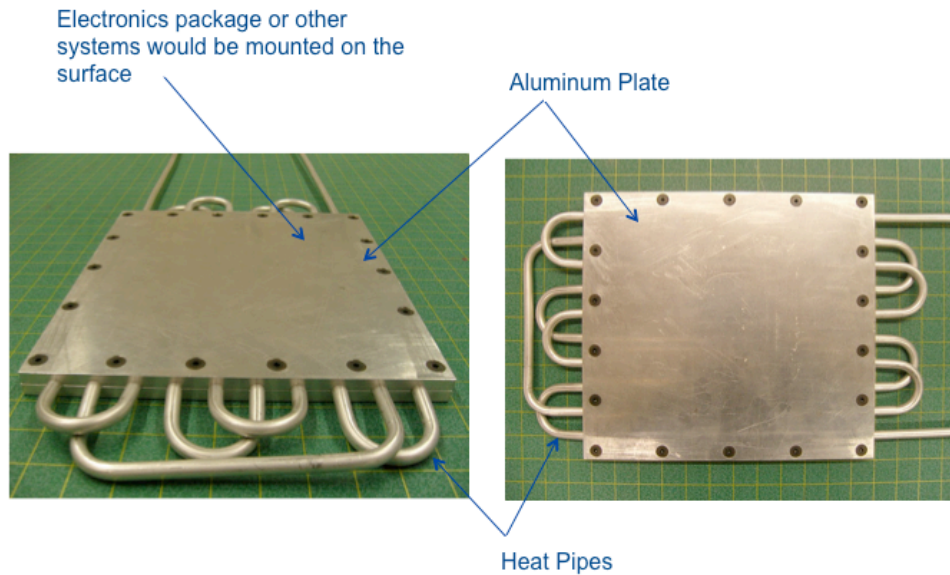

Figure 5.18—Example of a cold plate with integrated heat pipes.

Table 5.20—Cruise Deck Radiator Sizing

Component	Value
Radiator Solar Absorptivity	0.14
Radiator Emissivity	0.84
Estimated Maximum Radiator Solar Angle	70°
Total Radiator Dissipated Thermal Power	152 W
View Factor to Venus.....	0.25
Required Radiator Area	0.24 m ²
Radiator Operating Temperature	358 K
Cold Plate Material.....	Al
Cold Plate Dimensions.....	0.1- by 0.1- by 5-mm

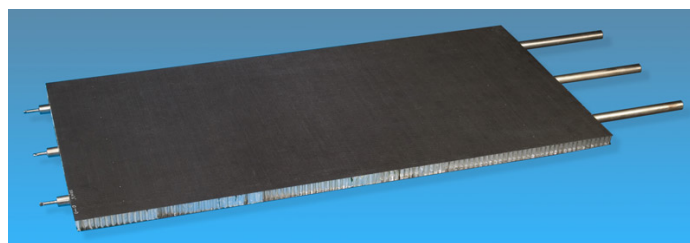

Figure 5.19—Radiator with integral heat pipes (ACT, inc).

5.9 Venus Atmospheric Environment

The harsh environment of Venus provides a number of challenges in the operation of equipment and materials. Operating within this environment, from entry to descent to operation on the surface requires significant thermal control. The atmosphere is composed of mainly CO₂ but does contain corrosive components such as sulfuric acid. The planet has a very thick atmosphere and is completely covered with clouds. The temperature and pressure near the surface is 455 °C at 90 Bar. The atmospheric properties (temperature, wind speed, solar attenuation and atmospheric density) from the surface to 100 km altitude are shown in Figure 5.20 and illustrated in Figure 5.21.

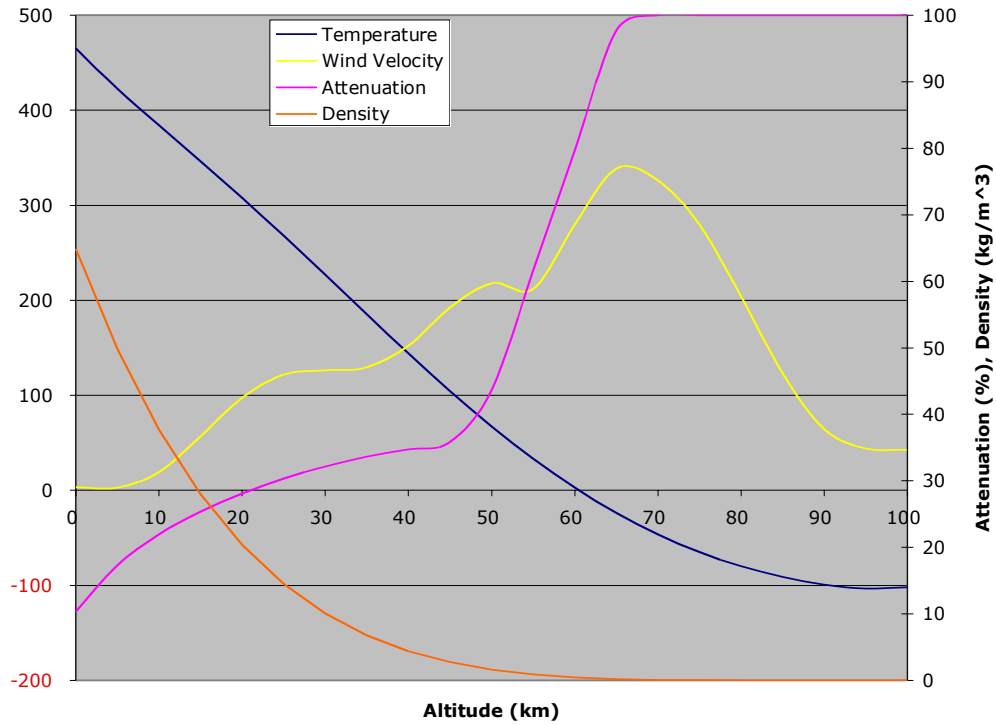

Figure 5.20—Venus atmospheric properties.

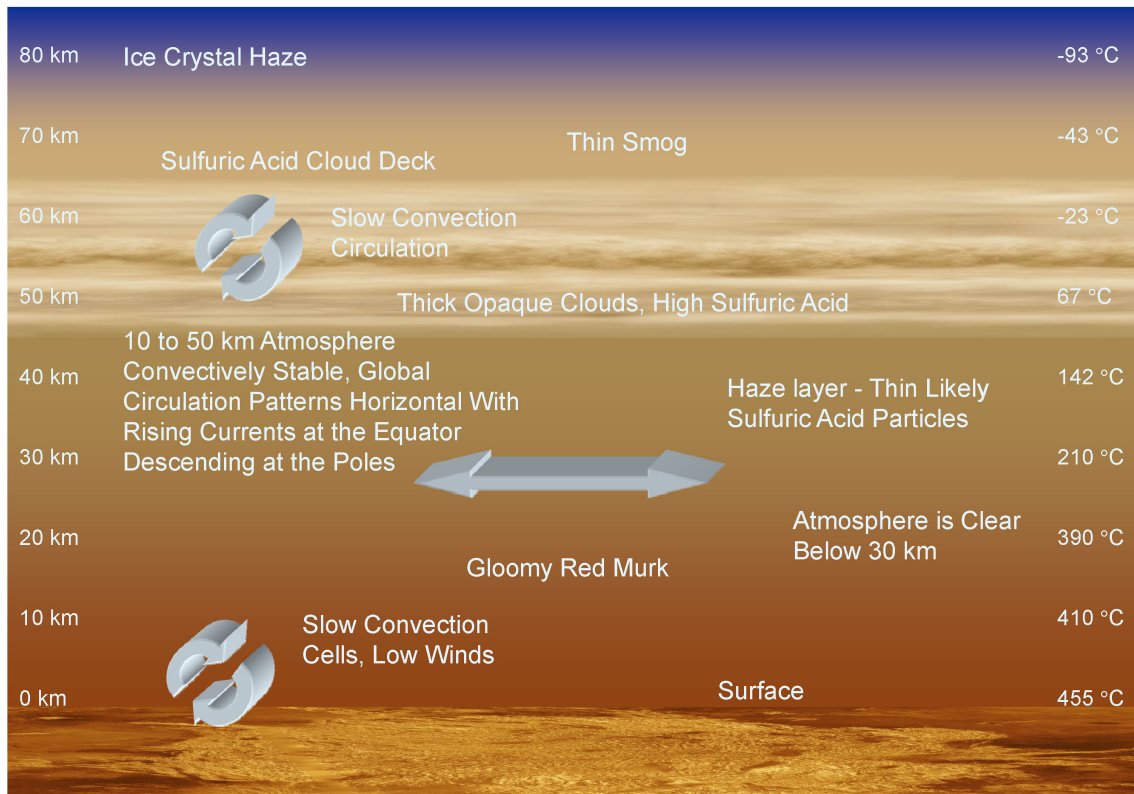

Figure 5.21—Venus atmospheric structure.

The winds within the atmosphere blow fairly consistently in the same direction as the planetary rotation (East to West) over all latitudes and altitudes up to 100 km. Above 100 km, the winds shift to blow from the dayside of the planet to the night side. The wind speeds decrease as a function of altitude from ~100 m/s at the cloud tops (60 km) to ~0.5 m/s at the surface. These high wind speeds and the slow rotation of the planet produce a super rotation of the atmosphere (nearly 60 times faster than the surface). These high wind speeds and the slow rotation of the planet produce a super rotation of the atmosphere (nearly 60 times faster than the surface).

5.10 Aeroshell and Descent Thermal Control

The aeroshell consists of a heat shield and back shell. The heat shield needs to be able to withstand the aerodynamic heating that will be encountered during entry into the Venus atmosphere. The heat is generated by friction caused by the drag of the capsule as it enters the atmosphere. The heat load will depend on the entry angle and speed. The heat shield for Venus entry was scaled off of the Stardust and Genesis Earth entry vehicles as well as the proposed Orion entry vehicle. All of these vehicles had similar entry velocities (~ 11 km/s) to what is expected for the Venus lander aeroshell. The heat shield sizing utilized the Orion structural design, shown in Figure 5.22, but substituted AVCOAT for PICA as the ablative material. This was done due to the size of the heat shield. The AVCOAT thickness utilized was 4.3 cm. The materials breakdown for the heat shield is given in Table 5.21.

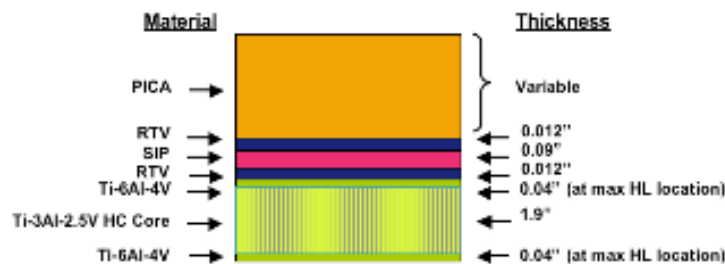

Figure 5.22—Orion heat shield structural makeup.

Table 5.21—Heatshield Material Layer Properties

Material	Thickness (cm)	Density (kg/m ³)
Avcoat	4.3	510
RTV Glue	0.0305	1060
Foam Insulation (SIP)	0.229	70
RTV Glue	0.0305	1060
Ti Alloy (Ti-6Al-4V)	0.102	4430
Ti Alloy (Ti-3Al-2.5V) Honeycomb	4.83	96.3
Ti Alloy (Ti-6Al-4V)	0.102	4430

The heat shield and backshell geometry were scaled up from the Stardust aeroshell design (shown in Figure 5.23). The Stardust aeroshell and entry specifications are:

- Entry velocity was 11.04 km/s
- 60° half angle
- -8.0° entry angle,
- 15 rpm 4 hr before entry
- Backshell thickness 5 cm
- Heat shield/structure thickness 10 cm

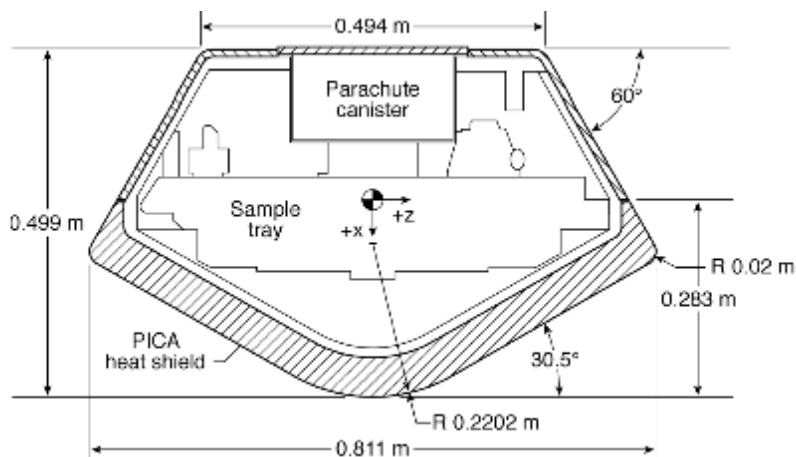

Figure 5.23—Stardust Aeroshell Geometry

5.10.1 Descent Electronics Enclosure Thermal Control

The descent electronics enclosure is an insulated pressure vessel that contains the electronics, equipment and sensors that are utilized during decent and landing.

The enclosure does not have any active cooling. It utilizes aerogel insulation and phase change material to maintain the internal temperature of the enclosure at approximately 300 K during the descent for duration of 1 hr, as illustrated in Figure 5.24.

To maintain the interior temperature of the enclosure, a layer of aerogel insulation is utilized on the inside of the pressure vessel outer wall. On the inside of the insulation is a layer of phase change material. It was selected because of its melting point of 305 K. As heat enters the chamber through the insulation it will cause the phase change material to melt. For the 1 hr descent all of the thermal energy leaking in through the insulation will be absorbed by the sodium sulfate through a phase change between a solid and liquid. This will maintain the interior temperature of the chamber at around 305 K. The specifications for the thermal control components for the descent electronics enclosure are given in Table 5.22.

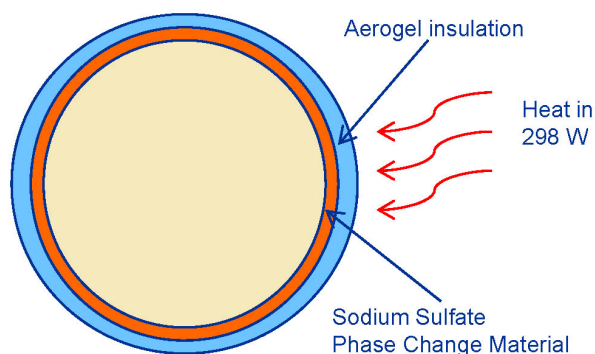

Figure 5.24—Descent electronics thermal control items.

Table 5.22—Insulation and Phase Change Material Specifications

Item	Insulation	Phase change material
Material	Aerogel	Sodium sulfate
Thickness	2 cm	7 mm
Density	20 kg/m ³	1464 kg/m ³
Mass	0.4 kg	22.5 kg

5.11 Surface Lander Thermal Control

All of the components that require a low temperature, relative to the atmosphere, for operation are located within the electronics enclosure pressure vessel. This pressure vessel is actively cooled by the Stirling cooler system. To minimize the power needed to cool this enclosure it is insulated from the outside environment. Within the pressure vessel along the outer surface wall is aerogel insulation. This insulation is utilized to reduce the heat leak in from the external atmospheric conditions.

The exterior temperature was assumed to be 735 K and the inside operational temperature was 300 K. In addition to heat leaking in through the insulation, heat also entered through a number of penetrations through the insulation that were necessary for the vehicle operation. These included wires, view ports and structural support standoffs. The heat leak into the chamber came from a number of sources. The interior of the pressure vessel was at 1 atm. Utilizing a gas within the pressure vessel provided a number of benefits. It allowed more even heat transfer between the electronics and the Stirling cooler. Also since the insulation selection and designed was made to operate within a 1 atm environment its operation was less susceptible to small leaks into the pressure vessel. If a completely evacuated pressure vessel was utilized along with MLI, any gas leak into the chamber would significantly reduce the insulation’s insulating capability and could be mission ending. However, with the aerogel insulation, it is capable of operating over a much larger pressure range and therefore is not very sensitive to minor leaks of gas into the pressure vessel. Also if atmospheric gas was to leak into the pressure vessel at a slow rate, there would be a slow degradation of the insulating capability of the aerogel which would mean a reduced mission time as the temperature slowly rose within the chamber but not a catastrophic mission failure as would occur in a similar situation with MLI.

A diagram of the heat leak rates into the pressure vessel through the various components is shown in Figure 5.25 and the characteristics of each is given in Table 5.23.

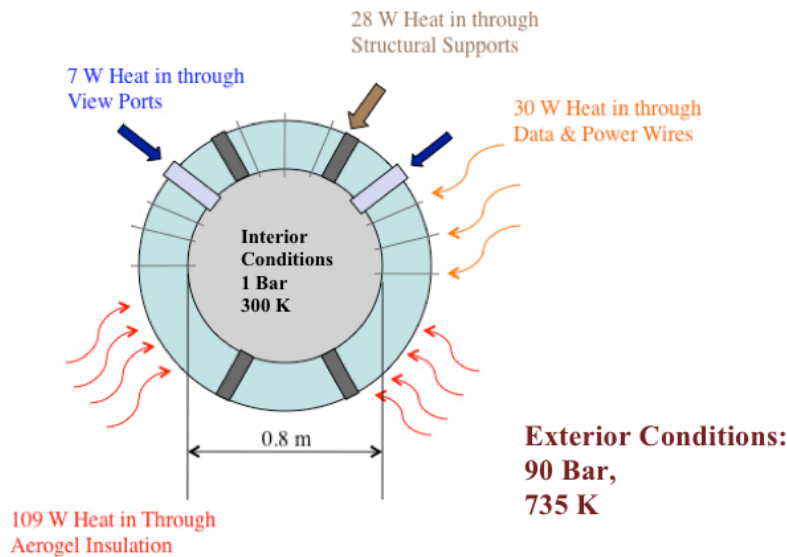

Figure 5.25—Heat leak into the Lander electronics enclosure pressure vessel.

Table 5.23—Pressure Vessel Components and Heat Leak

	View Port	Insulation	Wires	Structural Standoffs
Material	Fused quartz	Aerogel	Ceramic insulated Ti	Ti alloy (Ti-6Al-4V)
Thickness	21.6 cm	20 cm	21.6 cm	21.6 cm
Diameter	4 cm	N/A	6 mm (including insulation)	Hollow Tube 5 cm OD, 3 mm thick
Density	2200 kg/m ³	20 kg/m ³	4500 kg/m ³	4430 kg/m ³

Thermal Conductivity	1.4 W/mK	0.017 W/mK	21.9 W/mK	6.7 W/mK
Quantity	2	NA	24	9
Heat Leak In (Total)	7.1 W	108.9 W	30.0 W	27.8 W

6.0 COST AND RISK

6.1 Cost

Please note that the cost estimates presented in this section should be considered rough order of magnitude (ROM) costs for a S/C that is early in its design phase.

In order to estimate the cost of the ALIVE Mission Study S/C design, the MEL generated by the COMPASS team is linked to an Excel-based cost model. Costs are estimated at the subsystem and component levels using mostly mass-based, parametric relationships developed with historical cost data. Quantitative risk analysis is performed on these costs using Monte Carlo simulation based on mass and cost estimating relationship (CER) uncertainties. The pertinent cost modeling assumptions that apply for this S/C design are as follows:

- The S/C would be designed and built by a prime contractor based on NASA provided specifications.
- The S/C is assumed to be developed using a proto-flight approach for all subsystems and components.
- No ground spares are included.
- Flight heritage is assumed to be OTS for most components as defined by the subsystem leads. However, the electrical power subsystem is assumed to require a new development.
- The science payload includes the instruments for both the descent science and the surface science as well as the mechanisms for pointing the optical instruments. The cost for these instruments is estimated using the NASA Instrument Cost Model (NICM) for the LIBS, analogies to Galileo for the NMS and ASI, and camera and spectrometer specific CERs for the remaining imagers and spectrometers.
- The development cost for the Stirling Duplex is based on a CER developed for Non-nuclear Power and Dynamic Isotope Power Systems. The flight hardware for this component is estimated at \$20M, based on current estimates for the ASRG which is of similar complexity.
- The parametric modeling approach assumes that all components are at TRL-6 or higher; therefore, this section does not include any technology development costs necessary to bring any technology up to this level.
- Software is included as part of a subsystem CER used to estimate the Command and Data Handling subsystem.
- Planetary systems integration wraps are used to determine costs for Integration, Assembly and Check-out (IACO), Systems Test Operations (STO), Ground Support Equipment hardware (GSE), Systems Integration and Test (SE&I), Program Management (PM) and Launch and Orbital Operations Support (LOOS).
- The cost estimate represents the ‘most likely’ point estimate based on the cost risk simulation results and roughly equates to the 35th percentile on a pseudo-lognormal distribution.
- The cost of propellant is not included in these estimates.
- Costs are in this section are all in FY15\$M in order to compare to the New Frontiers cost cap.

Taking these assumptions into account, the cost estimate for the COMPASS team S/C design is shown in Table 6.1. The design, development, testing and engineering (DDT&E) represents the non-recurring cost of the S/C while the flight hardware represents the recurring cost. The most-likely cost risk simulation



results for the ALIVE S/C design only (including system integration wraps and prime contractor fee) are shown in Table 6.1 in FY\$15M.

Table 6.1—COMPASS Subsystem Level Cost Breakdown—ALIVE

WBS	Description	DDT&E total (FY15\$M)	Flight HW total (FY15\$M)	DD&FH total (FY15\$M)
Lander		153	97	250
06.1.1	Science	46	34	81
06.1.2	AD&C	4	4	7
06.1.3	C&DH	9	8	17
06.1.4	Communications and Tracking	10	10	21
06.1.5	Electrical Power Subsystem	42	25	68
06.1.6	Thermal Control (Non-Propellant)	6	1	7
06.1.11	Structures and Mechanisms	35	15	50
Aeroshell		30	17	47
Cruise Deck		27	15	42
Subtotal		209	129	339
	IACO	11	4	15
	STO	10	10	
	GSE Hardware	20	20	
	SE&I	35	14	49
	PM	17	6	23
	LOOS	14	14	
Spacecraft Total (with Integration)		316	154	470
Prime Contractor Fee (10% less Science Payload)		27	12	39
Spacecraft Total with Fee		343	166	508

Figure 6.2 shows lifecycle cost estimate is also included. For this estimate, NASA insight/oversight for the mission is 15% of the prime contractor cost plus fee. Phase A costs are capped at \$2.5M per the 2009 New Frontiers AO. The S/C cost represents the development and flight hardware cost from the previous figure. The Mission Operations and Ground Data Systems (GDS) costs consist of a \$20M placeholder used to represent the total cost for set-up and operations for this mission. The LV cost is not included in the calculations but assumes an Atlas 411-class LV. Finally, reserves are calculated at 25%. All costs are shown in FY\$15M.

Table 6.2—Lifecycle Cost Comparison for the ALIVE mission

	FY15\$M	
NASA insight/oversight	76	15% of prime contractor costs
Phase A	3	NF AO Cost Cap
Spacecraft (with Payload)	508	Prime Contractor B/C/D cost plus fee (10% - less science payload)
LV		Atlas 411
Mission Ops/GDS	20	Mission Ops, GDS, and set-up placeholder cost
Reserves	152	25% reserves (less LV)
Total	760	

Overall, the mission seems to fit in the higher end of a New Frontiers cost cap, which is assumed to be approximately \$775M (FY15\$M). However, the reserve posture of this estimate with a minimum 25% reserves would most likely not have enough reserves to be deemed a ‘competitive’ New Frontiers option. But, a stronger reserve posture of 30% or higher exceeds the estimated cost cap. So, this initial analysis shows that the ALIVE mission could potentially compete as a New Frontiers mission in 2015 but would need more reserves to be competitive against other mission proposals. Risk

6.2 Risk

Risk Requirements for any S/C design:

- The management of risk is a foundational issue in the design, development and extension of technology. Risk management is used to innovate and shape the future
- Risk is a chance to do better than planned
- Each subsystem was tasked to write a risk statement regarding any concerns, issues and ‘ah ha’s’
- Mitigation plans would focus on recommendations to alleviate, if not eliminate the risk

It is important to capture risk in cost estimates, especially technical, schedule and risk data. It may be too early to conduct an in-depth risk analysis, but there are many risks that can and should be identified and addressed at a high level. Cost estimating uncertainty and technical input variable uncertainty need to be considered. In this study, the ground rules and assumptions, data sources, methodology, and the risk assessment are documented to increase credibility and facilitate information sharing, and to make this design/technology usable in the future.

Assumptions for any S/C design consist of

- Risk List is not based on trends or criticality
- Some mitigation plans are offered as suggestions

The risk matrix in Figure 6.1 shows a shotgun scatter of where the ALIVE risks are located. Almost all of the risks are considered medium or moderate (yellow) risks. One of the 12 risks were identified as Green or low risks. There was one red risk identified for the X-band science collection system from Venus. All risk owners strive to drive risks and their mitigation steps down to a LxC score of 1x1 within reason.

Risks are characterized by the combination of the likelihood (probability) the program element or project will experience an undesired event and the consequences (impact), or severity of the undesired event, were it to occur. In order to establish metrics whereby risks within COMPASS may be assessed on an equitable basis, it is essential that the means for evaluating likelihood and consequences follow the same format. The format is based on a 5x5 risk matrix listed in Figure 6.1. The 5x5 risk matrix contains five adjective ratings for likelihood and five adjective ratings for consequences. Each of the factors (technical, cost, schedule, and safety) must be considered when making a determination of risk Consequence, but a risk need not have impact on all of the four factors.

Risk likelihood intends to provide an estimate based on available quantitative data and qualitative experience. Consequence classifications are based on program requirements, project and task performance requirements, mission success criteria, resources, safety, and cost and schedule constraints. Each of the factors (i.e., technical, cost, safety, schedule) must be considered when making a determination of risk consequence.

Figure 6.2 to Figure 6.7 describe the risk statement, the risk context, and possible mitigation plans for each risk identified.

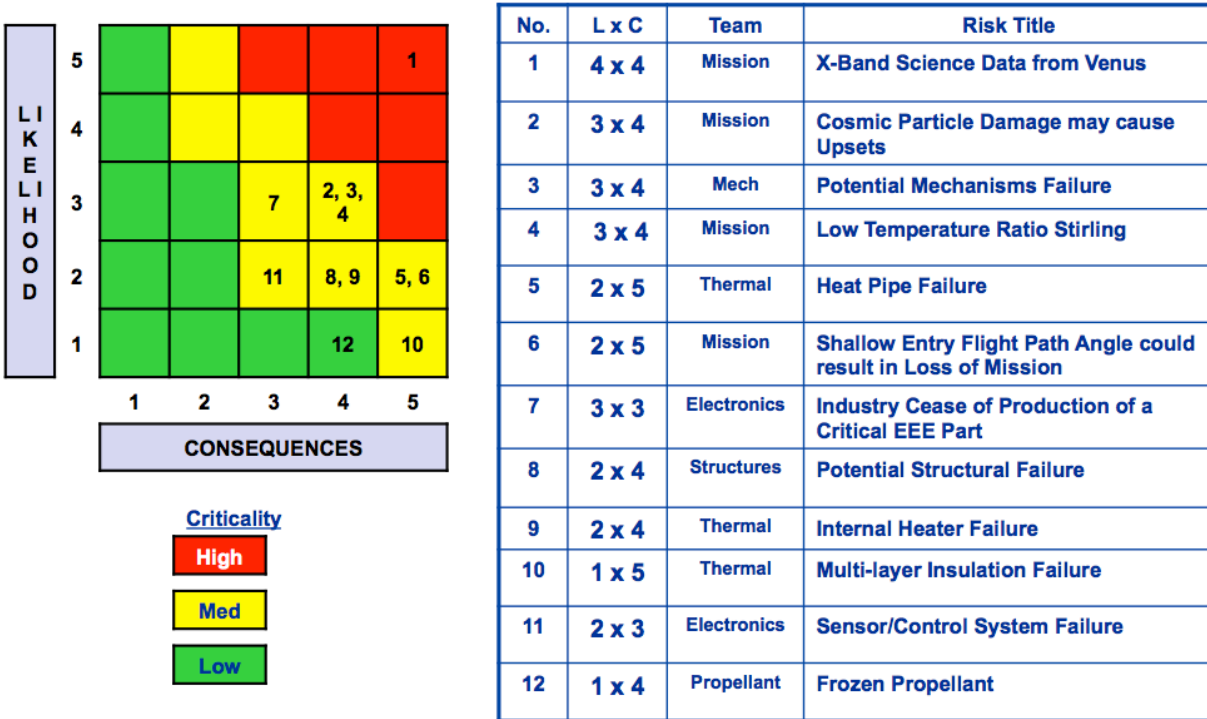

Figure 6.1—ALIVE Risk List.

Risk ID / Subsystem / Risk Attributes	Risk Title	Risk Statement/ Context	Approach
1 - Mission Lk: 4 Consq: 4 Safety: 1 Perform: 4 Sched: 1 Cost: 1	X-Band Science Data from Venus	<p>Statement: Given that X-Band communications has not been accomplished from Venus; there is a possibility that the Landers communications systems will not be capable of returning all desired science information</p> <p>Context: There is limited propagation information on Venus, the line of sight to earth may be through more atmosphere than designed for, landing tilted. Deep Space Network is removing there 70 meter (m) antennas and arrayed 34 m antennas may not be able to compensate for the added propagation losses. The HGA antenna mechanisms may discontinue working after initial deployment due to the harsh environment causing increased pointing losses, thus decrease performance.</p>	<p>Mitigate: Conduct Propagation studies with a Venus atmosphere. Prioritize Science data for transmission</p>
2 - Power Lk: 3 Consq: 3 Safety: 4 Perform: 4 Sched: 3 Cost: 3	Cosmic Particle Damage May Cause Upsets	<p>Statement: Given that the spacecraft will spend a number of years in interplanetary space; there is a probability that a semiconductor device will suffer a particle-induced upset or failure, or will experience reduced capability in a EEE part or quartz oscillator.</p> <p>Context: The Risk Statement is generally universal to all spacecraft in interplanetary space. Both the causes and effects of particle radiation hazards and damage are explained in many texts.</p>	<p>Mitigate: Investigations have shown that extra particle shielding and/or particle radiation effects mitigations can be accomplished by two or more different approaches: 1) Use thick wall avionics enclosures (such as 1.25 in. Aluminum); 2) Use Titanium for the walls of avionics enclosures. Ti has a much larger barns factor than Aluminum (e.g. T-6061); 3) Use Error Detection and Correction (EDAC) solid state memory; 4) Use rad-hard (or rad-tolerant) Field Programmable Gate Arrays for digital processors and complex electronics; 5) Do not use semiconductor types that are rad-soft; 6) Use redundant processing lanes or redundant processor boards; 7) Shield digital/video cameras when not in use; 8) Employ electronic current outout devices (e.g. fuses) in power leads from main power supplies (in case of Single Event Burnout).</p>

Figure 6.2—Risks 1 and 2—Mission and Power risks for ALIVE.

Risk ID / Subsystem / Risk Attributes	Risk Title	Risk Statement/ Context	Approach
3 - Mechanism Lk: 3 Consq: 1 Safety: 4 Perform: 3 Sched: 3 Cost: 3	Potential Mechanisms Failure	<p>Statement: Given that excessive g loads, impacts from a foreign object, or harsh environmental conditions may damage mechanisms; there is a possibility of lower performance from mounted hardware to loss of mission</p> <p>Context: Failure of mechanisms may prevent optimum hardware operation or may inhibit mission completion. Failure of separation or deployment units can prevent planned mission completion.</p>	<p>Mitigate: The mechanisms are to be designed to NASA standards to withstand expected environmental conditions. All precautions should be taken to prevent damage from installation, launch, and operating conditions.</p>
4 - Mission Lk: 2 Consq: 4 Safety: 5 Perform: 2 Sched: 2 Cost: 2	Low Temperature Ratio Stirling	<p>Statement: Given the temperature limits of materials used to construct the Stirling Duplex machine may not be sufficient on the Venus surface; there is a possibility that a low temperature ratio across the Stirling convertor will make the design difficult and inefficient</p> <p>Context: Stirling convertors for power generation generally operate at temperature ratios of greater than 2.0 (Thot/ Tcold). The Advanced Stirling Radioisotope Generator (ASRG) operates at a temperature ratio of greater than 3.0. Best efficiency operation (highest fraction of Carnot) occurs at these temperature ratios. Due to the environment and materials limits the temperature ratio of this convertor was 1.5. To reflect this low temperature ratio a much lower fraction of Carnot efficiency was assumed. The Venus lander as currently modeled assumes a fraction of Carnot of 50%, much lower than the approximately 60% that the ASRG operates at. While this efficiency was assumed there is no guarantee that the convertor will work as modeled or even achieve the assumed efficiency.</p>	<p>Mitigate: Development of a low temperature ratio Stirling Duplex machine and testing in a relevant environment</p>

Figure 6.3—Risks 3 and 4—Mechanisms and Mission risks for ALIVE.

Risk ID / Subsystem / Risk Attributes	Risk Title	Risk Statement/ Context	Approach
5 - Thermal Lk: 2 Consq: 4 Safety: 5 Perform: 2 Sched: 2 Cost: 2	Heat Pipe Failure	<p>Statement: Given the a leak may be caused by a stress crack, weld failure, or micro meteor; there is a possibility that a failure of the electronics which are being cooled by the heat pipe system will occur.</p> <p>Context: A failure with the heat pipes would most likely lead to a failure of the electronics or other internal system components, which depend on the pipes for cooling.</p>	<p>Mitigate: Utilize micro meteor shielding on any exposed heat pipes (especially those going to the radiator), inspect any welds made in the pipes and design the system to minimize stress on the heat pipes. Also, redundant heat pipes can be used to reduce or eliminate the effects of any individual heat pipe failure.</p>
6 - Mission Lk: 2 Consq: 1 Safety: 3 Perform: 5 Sched: 5 Cost: 5	Shallow Entry Flight Path Angle could result in Loss of Mission	<p>Statement: Given the shallow flight path angle that the lander may enter the Venus atmosphere; there is a possibility the vehicle will not be captured by the atmosphere.</p> <p>Context: There is a requirement to keep the acceleration experienced by the lander to be less than 40 g's. One of the main contributors to a high g load at atmospheric entry is the flight path angle. The steeper the flight path angle the higher the g-load, the more shallow the flight path angle, the lower the g-load. To keep the g-load experienced by the vehicle at atmospheric entry below 40 g's, a fairly shallow flight path angle is required (~ 8 degrees). However, for a given entry velocity and vehicle ballistic coefficient, if the entry flight path angle is too shallow the vehicle will not be decelerated enough by the atmosphere and hence will not be captured.</p>	<p>Mitigate: Additional analysis is required to confirm that the vehicle can be captured by Venus' atmosphere given a particular entry velocity..</p>

Figure 6.4—Risks 5 and 6—Thermal and Mission risks for ALIVE.

Risk ID /Subsystem / Risk Attributes	Risk Title	Risk Statement/ Context	Approach
7 - Electronics Lk: 3 Consq: Safety: 2 Perform: 3 Sched: 3 Cost: 3	Industry Cease of Production of a critical EEE part	<p>Statement: Given that market forces and/or natural disasters may cause a EEE parts manufacturer to shut down production of a critical EEE part; there is a possibility that an alternate part will have to be chosen and flight qualified.</p> <p>Context: Manufacturers have been known to cease production of EEE parts such as capacitors, resistors, transistors, etc. due to lack of sales demand, obsolescence, etc. Or a part being made in a single location has production interrupted due to fire, earthquake, or other disaster.</p>	<p>Mitigate: 1. Contact manufacturer to discuss options and proposed part retirement dates. 2. Contact manufacturer for purchasing a project life quantity of the critical parts from their production line in case of production line shutdown.</p>
8 - Structures Lk: 2 Consq: Safety: 1 Perform: 4 Sched: 4 Cost: 4	Potential Structural Failure	<p>Statement: Given the excessive g loads from impact of a foreign object or harsh landing may cause excessive deformation, vibrations, or fracture of sections of the support structure; there is a possibility that lower performance from mounted hardware or loss of mission will result.</p> <p>Context: Excessive deformation of the structure can misalign components dependent on precise positioning, therefore, diminishing their performance. Internal components may be damaged or severed from the rest of the system resulting in diminished performance or incapacitation of the system. Excessive vibrations may reduce instrumentation performance and/or potentially lead to long term structural failure due to fatigue. Overall, the mission may not be completed in an optimum manner or it can be terminated in the worst case.</p>	<p>Mitigate: The structure is to be designed to NASA standards to withstand expected g loads, a given impact, and to have sufficient stiffness and damping to minimize issues with vibrations. Trajectories are to be planned to minimize the probability of impact with foreign objects. Landing systems are to be designed with sufficient reliability to minimize induced loads.</p>

Figure 6.5—Risks 7 and 8—Electronics and Structures risks for ALIVE.

Risk ID /Subsystem / Risk Attributes	Risk Title	Risk Statement/ Context	Approach
9 – Thermal Lk: 2 Consq: Safety: 3 Perform: 4 Sched: 2 Cost: 2	Internal heater Failure	<p>Statement: Given the internal heaters, used to maintain electronics, components, and propulsion system temperatures may fail; there is a possibility that the mission will be jeopardized.</p> <p>Context: If this failure occurs it could lead to the failure of the electronics, component or propulsion system and jeopardize all or part of the mission</p>	<p>Watch: The mitigation approach is to utilize redundant heaters, switches and control system along with multi-layer insulation in order to minimize any effects of a heater failure</p>
10 - Thermal Lk: 1 Consq: Safety: 3 Perform: 5 Sched: 3 Cost: 2	Multi-layer Insulation Failure	<p>Statement: Given the failure of the multi-layer insulation, used to maintain the interior temperature of the spacecraft, may occur; there is a possibility that the electronics, other components, or the propulsion system will fail and jeopardize the mission.</p> <p>Context: The insulation is utilized to maintain the interior temperature of the spacecraft. If does not function properly it could lead to the failure of the electronics, component or propulsion system and jeopardize all or part of the mission.</p>	<p>Mitigate: The insulation is a critical part of the thermal control system. Although loss of the insulation is extremely unlikely, any degradation in its performance can jeopardize the mission and vehicle. The mitigation approach is to inspect the insulation installation prior to launch to insure it will not come loose or be dislodged during launch. Debris impacts can tear or remove chunks of insulation. To mitigate any insulation degradation, additional heater capacity can be added to offset the increased heat loss that would occur.</p>

Figure 6.6—Risks 9 and 10—Thermal risks for ALIVE.

Risk ID /Subsystem / Risk Attributes	Risk Title	Risk Statement/ Context	Approach
11 - Thermal Lk: 2 Consq: 3 Safety: 3 Perform: 3 Sched: 2 Cost: 2	Sensor / Control System Failure	<p>Statement: Given the failure of one or more of the temperature sensors or controllers, used to maintain a minimum electronics and component temperature may occur; there is a possibility that the electronics or other components will fail and jeopardize the mission.</p> <p>Context: A failure of the thermal control system, which includes the temperature sensors, data acquisition system or computer controller, would compromise the ability to accurately control the interior temperature of the electronics. The control system mainly controls the operation of the electric heaters. A failure in this system would prevent the heaters from operating properly. If this failure occurs the heaters would not operate correctly which could lead to the failure of the electronics or other components and jeopardize all or part of the mission</p>	<p>Mitigate: The mitigation approach is to utilize redundant thermocouples and control system. Also the implementation of a manual, earth commanded, capability to turn the heaters on and off would reduce the risks.</p>
12 - Propulsion Lk: 1 Consq: 1 Safety: 1 Perform: 1 Sched: 4 Cost: 4	Propellant Freezing	<p>Statement: Given that the relatively high freezing point of Hydrazine may freeze the tanks, lines, and valves of the engine; there is a possibility that the RCS will be rendered inoperable.</p> <p>Context: Due to the extreme temperature differences experienced in space, inadequate insulation, heating, or temperature distribution can result in hydrazine freezing in the propellant feed system or tanks. This results in a non-functional propulsion system, and at worst, possibly a burst fuel line or tank, thus crippling the vehicle. Detail thermal modeling and/or testing can determine detailed heater and insulation requirements, thus mitigating the risk.</p>	<p>Mitigate: Perform detailed thermal analysis of fuel tanks and feed system to determine adequate thermal and insulation requirements, and cross reference those results with other space craft of this type. If funding is available, perform thermal vacuum testing on entire vehicle. Additional option is to the use of HAN monopropellants, which can tolerate lower temperatures before freezing.</p>

Figure 6.7—Risks 11 and 12—Thermal and Propulsion risks for ALIVE.

Technology	TRL	R&D ³	TFDoM
1. Li Burner			
2. Duplex Stirling			
3. Leveling Battery			
4. Insulation			
5. High Temperature/High Pressure Communications Antenna			
6. High Temperature/High Pressure Waveguide			
7. High Temperature/High Pressure Gimbals/motors			
8. High Temperature/High Pressure Windows			
9. High Temperature/High Pressure 450 C 40 g Pressure vessel			

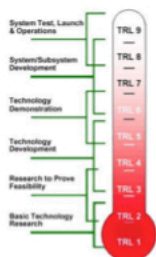

Research and Development Degree of Difficulty (R&D³)

- R&D³ = I: Probability of Success in R&D ~ 99%
- R&D³ = II: Probability of Success in R&D ~ 90%
- R&D³ = III: Probability of Success in R&D ~ 80%
- R&D³ = IV: Probability of Success in R&D ~ 50%
- R&D³ = V: Probability of Success in R&D ~ 20%

Test Facility Degree of Modification (TFDoM)

- 0 = Existing Facility with No Modifications
- 1 = Minor Modification to Existing Facility
- 2 = Significant Modifications to Existing Facility
- 3 = New Facility Required

Figure 6.8—ALIVE TRL assessment.



7.0 BIBLIOGRAPHY

System

AIAA S-120-2006, AIAA Standard Mass Properties Control for Space Systems.
ANSI/AIAA R-020A-1999, Recommended Practice for Mass Properties Control for Satellites, Missiles, and Launch Vehicles.
Larson, W.J. and Wertz, J.R. (eds.), (1999) Space Mission Analysis and Design, Third Edition, Space Technology Library, Microcosm Press.

Mission

Anderson, David J., Pencil, Eric J., Liou, Larry C., Dankanich, John W., Munk, Michelle M., and Hahne, David, (2010), "The NASA In-Space Propulsion Technology Project's Current Products and Future Directions," AIAA-2010-6648, 46th AIAA/ASME/SAE/ASEE Joint Propulsion Conference & Exhibit, July 25–28, 2010, Nashville, TN.
Balint, Tibor, (2002), "Summary of Russian Planetary Lander Missions." Deep Space Mission Architecture Group, NASA-JPL, CA
"COMPASS Final Report: Mars Earth Return Vehicle (MERV)," CD-2009-31, February–March 2009.
Desai, P.N., Braun, R.D., Engelund, W.C., Cheatwood, F.M., Kangas J.A., (1998), "Mars Ascent Vehicle Flight Analysis," 7th AIAA/ASME Joint Thermophysics and Heat Transfer Conference June 15–18, 1998, Albuquerque, NM, AIAA 98-2850.
Dillman, Robert and Corliss, James, (2008), "Overview of the Mars Sample Return Earth Entry Vehicle," Sixth International Planetary Probe Workshop, June 26, 2008.
Dux Ian J., Huwaldt, Joseph A., McKamey, R. Steve, Dankanich, John W., (2010) Mars Ascent Vehicle Gross Liftoff Mass Sensitivities for Robotic Mars Sample Return, NASA Deep Space Missions, NASA TM 2010.
ESA Aurora Program, http://www.esa.int/esaMI/Aurora/SEMCWB1A6BD_0.html
Holmberg, Neil A.; Robert P. Faust, H. Milton Holt (1980), "Viking '75 Spacecraft Design and Test Summary Volume III—Engineering Test Summary," NASA Reference Publication 1027, Nov. 1980.
Johnston, M.D., Esposito, P.B., Alwar, V., Demcak, S.W., Graat, E.J., and Mase, R.A. (1998), "Mars Global Surveyor Aerobraking at Mars," AAS 98-112 <http://Mars.jpl.nasa.gov/mgs/sci/aerobrake/SFMech.html>
Matousek, S., Adler, M., Lee, W., Miller, S.L., Weinstein, S., (1998), "A Few Good Rocks: The Mars Sample Return Mission Architecture," AIAA/AAS Astrodynamics Specialist Conference, August 10–12, 1998, Boston, MA, AIAA-98-4282.
Palaszewski, B. and Frisbee, R., (1988), "Advanced Propulsion for the Mars Rover Sample Return Mission," AIAA-88-2900, AIAA/ ASME/SAE/ASEE 24th Joint Propulsion Conference, July 11–13, 1988, Boston, MA
Preliminary Planning for an International Mars Sample Return Mission, Report of the International Mars Architecture for the Return of Samples (iMARS) Working Group, June 1, 2008.
Rose, J., (1989), "Conceptual Design of the Mars Rover Sample Return System," 27th Aerospace Sciences Meeting, Jan. 9–12, 1989, Reno, NV, AIAA-89-0418.
Spencer, D.A., Tolson, R., (2007), "Aerobraking Cost and Design Considerations," Journal of Spacecraft and Rockets, Vol. 44, No. 6, Nov/Dec. 2007
Stephenson, David, (2002), "Mars Ascent Vehicle—Concept Development," 38th Joint Propulsion Conference and Exhibit, July 7–10, 2002, Indianapolis, IN, AIAA 2002-4318.
Whitehead, John C., (1997), "Mars Ascent Propulsion Options for Small Sample Return Vehicles." 33rd AIAA/ASME/SAE/ASEE Joint Propulsion Conference and Exhibit, July 6–9, 1997, Seattle, WA, AIAA 97-2950.
Williams, R., Gao, Y., Kluever, C.A., Cupples, M., and Belcher, J., (2005), "Interplanetary Sample Return Missions Using Radioisotope Electric Propulsion," 41st AIAA/ASME/SAE/ASEE Joint Propulsion Conference & Exhibit, July 10–13, 2005, Tucson, AZ, AIAA-2005-4273.
Zubrin, Robert, (1996), "A comparison of approaches for the Mars Sample Return Mission," AIAA 34th Aerospace Sciences Meeting and Exhibit, Reno, NV, Jan. 15–18, 1996, A9618450, AIAA Paper 96-0489.

GN&C

L. Norris, Y.C. Tao, R. Hall, J. Chuang, M. Whorton, "Analysis of Ares I Ascent Navigation Options", AIAA 2008-6290.

Structures

D. Persons, L. Mosher, T. Hartka, (2000), "The NEAR and MESSENGER Spacecraft: Two Approaches to Structure and Propulsion Design," AIAA-00-1406, A00-24531.
Zibdeh, Hazim S., and Heller, Robert A., (1989), "Rocket motor Service Life Calculations Based on the First-Passage Method," Virginia Polytechnic Institute and State University, Blacksburg, VA, Journal of Spacecraft and Rockets, 0022-4650, Vol. 26, No. 4 pp. 279–284.

Thermal

Aerodynamic Heating Wikipedia entry. http://en.wikipedia.org/wiki/Aerodynamic_heating
Alexander, M. (ed.) (2001), "Mars Transportation Environment Definition Document," NASA/TM—2001-210935.
Bejan, A. and Kraus, A.D., (2003), Heat Transfer Handbook, John Wiley & Sons.

COMPASS Final Report

- Chapman, A.J., (1974), Heat Transfer, Third Edition, Macmillan Publishing Company.
- Gilmore, David G. (ed.), (2002), Spacecraft Thermal Control Handbook: Volume 1 Fundamental Technologies, AIAA.
- Hyder, A.J., Wiley, R.L., Halpert, G., Flood, D.J. and Sabripour, S., (2000), Spacecraft Power Technologies, Imperial College Press.
- Incopera, F.P. and DeWitt, D.P., (1990), Fundamentals of Heat and Mass Transfer, John Wiley and Sons.
- Larson, W.J. and Wertz, J.R. (eds.), (1999), Space Mission Analysis and Design, Third Edition, Space Technology Library, Microcosm Press.
- Olds, J. and Walberg, G., (1993), "Multidisciplinary Design of Rocket-Based Combined Cycle SSTO Launch Vehicle using Taguchi Methods," AIAA 93-1096, AIAA/AHS/ASEE Aerospace Design Conference, February 16-19, 1993, Irvine, CA.
- Penuela, David, Simon, Mathew, Bemis, Eammon, Hough, Steven, Zaleski, Kristina, Jefferies, Sharon and Winski, Rick, "Investigation of Possible Heliocentric Orbiter Applications for Crewed Mars Missions," NIA/Georgia Institute of Technology, Project 1004. http://www.nianet.org/rascal/forum2006/presentations/1004_nia_paper.pdf
- RP-07-100_05-019-I; Volume I: Ice Mitigation Approaches for Space Shuttle External Tank Final Report.
- Sutton, Kenneth and Graves, Randolph A. Jr., (1971), "A General Stagnation Point Convective-Heating Equation for Arbitrary Gas Mixtures," NASA TR R-376.
- <http://kids.britannica.com/comptons/art-94135/A-surface-map-of-Venus-shows-the-planets-global-topography>
- <http://www.sageofathens.com/Documents/Duplex.pdf>



APPENDIX A—ACRONYMS AND ABBREVIATIONS

ACS	Attitude Control System	EDS	Earth departure stage
AD&C	Attitude, Determination & Control	EEE	
AIAA	American Institute for Aeronautics and Astronautics	EIRP	equivalent isotropic radiated power
Al	aluminum	ELV	expendable launch vehicle
ALIVE	Advanced Long-Life Lander Investigating the Venus Environment	EMP	electromagnetic pump
ANSI	American National Standards Institute	EP	electric propulsion
AO	Announcement of Opportunity	EPC	?
ASC	Advanced Stellar Compass	EPOXI	Extrasolar Planet Observation
ASI	Atmospheric Structure Investigation	EVE	Extended Venus Explorer
ASRG	Advanced Stirling Radioisotope Generators	FOM	figure(s) of merit
AWG	American Wire Gauge	FPGA	Field Programmable Gate Array
C&DH	Command and Data Handling	FY	fiscal year
C&T	command and telemetry	GDS	Ground Data Systems
C&TN	Communications & Tracking Network	GLIDE	GLobal Integrated Design Environment
CAM	collision avoidance maneuver	GN&C	Guidance, Navigation and Control
CBE	current best estimate	GRC	NASA Glenn Research Center
CEA		GSE	Ground Support Equipment
CER	cost estimating relationships	HAN	hydroxyl-ammonium nitrate
CO ₂	carbon dioxide	HGA	high gain antenna
Comm	communications	IACO	Integration, Assembly and Check-Out
COMPASS	COlaborative Modeling and Parametric Assessment of Space Systems	IR	infrared
COTS	commercial off the shelf	Isp	specific impulse
DCIU	Digital Control and Interface Unit?	JPL	NASA Jet Propulsion Laboratory
DD&FH		KSC	NASA Kennedy Space Center
DDT&E	design, development, test, and evaluation	LGA	low gain antenna
DPU	data processing unit	LGA	lunar gravity assist
DSN	Deep Space Network	Li	lithium
DTE	data terminal equipment	LIBS	Raman/Laser Induced Breakdown Spectroscopy
DTU	Technical University of Denmark	LiDS	Lithium Duplex Sterling
Eb/N0	energy per bit to noise power spectral density ratio	LNT	lithium nitrate trihydrate
EDL	entry, descent, and landing	LOCO	LOW COMplexity LOSSless COMpression
		LOOS	Launch and Orbital Operations Support
		LPF	pg18
		LRO	Lunar Reconnaissance Orbiter
		LV	launch vehicle

COMPASS Final Report

MAC	media access control	R&D ³	Research and Development
MALTO	Mission Analysis Low-Thrust Optimization		Degree of Difficulty
MASTIF	Mission Analysis and Simulation Tool In Fortran	RAM	random access memory
MEL	Master Equipment List	RCS	Reaction Control System
MER	Mars Exploration Rover	RF	radio frequency
MET	pg12	RFI	radio frequency interference
Mg	magnesium	ROM	rough order of magnitude
MGA	mass growth allowance	S/C	spacecraft
MLI	multilayer insulation	SA	solar array
MMPDS	Metallic Materials Properties Development and Standardization	SDI	serial digital interface
MOP		SDO	serial data output
MSL	Mars Science Laboratory	SDST	
N/A	not applicable	SE&I	Systems Integration and Test
NaK	sodium-potassium alloy	SEU	single event upset
NaS	sodium-sulfur	SIRU	Scalable Inertial Measurement Unit
NASA	National Aeronautics and Space Administration	SLOC	source lines of code
Nav	navigation	SOAP	Satellite Orbit Analysis Program
NIAC	NASA Innovative Advanced Concepts	STO	Systems Test Operations
NICM	NASA Instrument Cost Model	SUA	systems uncertainty analysis
NIST	National Institute of Standards and Technology	TBD	to be determined
NMS	Neutral Mass Spectrometer	TBR	to be resolved
OTS	off-the-shelf	TCM	trajectory correction maneuvers
OU	optical units	TCS	Thermal Control System
P&ID		TDRSS	Tracking and Data Relay Satellite System
PAF	payload attach fitting	TFDoM	Test Facility Degree of Modification
Pan Cam	Panoramic Camera	Ti	titanium
PEL	Power Equipment List	TLI	trans-lunar injection
PICA	Phenolic Impregnated Carbon Ablator	TLS	Tunable Laser Spectrometer
PLA	Payload Adaptor	TRL	technology readiness level
PM	Program Management	TT&C	telemetry, tracking and command
PMAD	power management and distribution	TWTA	traveling wave tube amplifier
PN	pseudo-noise	VFDRM	
PV	photovoltaics	VITaL	Venus Intrepid Tessera Lander
		WBS	work breakdown structure
		WGA	weight growth allowance
		WGS	weight growth schedule



APPENDIX B—RENDERED IMAGES

B.1 Insert subtitle

Figure B.1—

Figure B.2—

Figure B.3—

APPENDIX C—COMPASS INTERNAL DETAILS (ALWAYS LAST)

C.1 COMPASS Description

The COncurrent Multidisciplinary Preliminary Assessment of Space Systems (COMPASS) team is a collaborative engineering team whose primary purpose is to perform integrated-vehicle systems analysis and provide trades and designs for both Exploration and Space Science Missions.

C.2 GLIDE Study Share

GLobal Integrated Design Environment (GLIDE) is a data collaboration tool that enables secure transfer of data between a virtually unlimited number of sites from anywhere in the world. GLIDE is the primary tool used by the COMPASS design team to pass data real between subsystem leads in real-time.

While GLIDE 2 was being tested during this design session, the old shares are being used to store the data and the MELs. The data on the share can be found here:

<https://glidesharename/XXXX>

C.2.1 GLIDE Architecture

For this study, the COMPASS Team is testing the GLIDE 2 application and server. The architecture and database information will be referencing the GLIDE 2 server.

Architecture: **XXX**

C.2.2 GLIDE Study Container

Table C.1 lists the study container and descriptions of the cases run with the GLIDE-specific data necessary for the COMPASS Team members to conduct the study.

Table C.1—Study Container and Descriptions

Study name	Description	Study container
Case no.		XXX_Case0