



The Wind and Beyond

A Documentary Journey into the
History of Aerodynamics in America

Volume III: Other Paths, Other Flyways

James R. Hansen and Jeremy R. Kinney, Editors
with D. Bryan Taylor, Molly F. Prickett, and J. Lawrence Lee

The Wind and Beyond

A Documentary Journey into the History
of Aerodynamics in America

Volume III: Other Paths, Other Flyways

The airplane ranks as one of history's most ingenious and phenomenal inventions. It has surely been one of the most world-changing. How ideas about aerodynamics first came together and how the science and technology evolved to forge the airplane into the revolutionary machine that it became is the epic story told in this multivolume work, *The Wind and Beyond: A Documentary Journey into the History of Aerodynamics in America*.

Following up on the first volume's account of the invention of the airplane and creation of the aeronautical research establishment in the United States and the second's depiction of the airplane design revolution of the 1920s and 1930s and the quest for improved airfoils, this volume explores the aerodynamics of airships, flying boats, and rotary-wing aircraft.

In 2005, the Society for the History of Technology awarded its first annual Eugene S. Ferguson Prize for outstanding and original reference works to *The Wind and Beyond*. The citation read in part:

The Wind and Beyond is remarkable in its breadth of vision. Its purview includes not just aerodynamical theories and research results, but also innovative airships and airship components as well as the institutions in which and through which aerodynamics developed.... Each [chapter] essay is original in two ways. First, each is a first-rate piece of scholarship in its own right. Second, the very decision to include these narratives is significant: they comprise roughly 10 percent of the contents of the volume, but they make the other 90 percent both accessible and meaningful to the nonspecialist reader, simultaneously enhancing the value of and enlarging the potential audience for the volume.... *The Wind and Beyond* will be a boon both to students and to established scholars in several ways. Like many similar collections, it provides one-stop access to documents that were previously scattered in many different places. Going beyond other similar collections, however, *The Wind and Beyond* makes the documents intellectually as well as physically accessible.... The end result is an eminently readable reference work, one that is truly, as its title suggests, the beginning of a journey rather than the end.

About the Editors

James R. Hansen is professor emeritus of history at Auburn University in Alabama. His *First Man* (2005), an award-winning biography of Neil Armstrong, spent three weeks on the *New York Times* bestseller list on two different occasions and as recently as 2018. He is coauthor with the late Allan J. McDonald of *Truth, Lies, and O-Rings: Inside the Space Shuttle Challenger Disaster* (2009), which has been called "the definitive study" of the Challenger accident. Jim served as the head of the Auburn team that initiated NASA's multi-volume *Wind and Beyond* documentary history project over 20 years ago. His most recent contribution is a two-volume edited and annotated collection of Neil Armstrong's correspondence, which was published by Purdue University Press in 2019–20.

Jeremy R. Kinney is the Associate Director for Research and Curatorial Affairs at the Smithsonian Institution's National Air and Space Museum. He is the author of the award-winning *Reinventing the Propeller: Aeronautical Specialty and the Triumph of the Modern Airplane* (2017) and *The Power for Flight: NASA's Contributions to Aircraft Propulsion* (2017). He has taught courses in aerospace history at the University of Maryland at College Park, George Mason University, and New York University. Before joining the Smithsonian, he was an American Historical Association/NASA Fellow in Aerospace History. He earned his doctorate in the history of technology from Auburn University.

Cover: *Fluid Dynamics*, Tina York. The study of fluid dynamics attempts to explain what happens to an object when it encounters the friction of atmospheric resistance (such as a plane encountering resistance as it speeds through the air). The artist has decided to depict the effect of air flow as a plane or other flying objects move through the air. (NASA Image 95-HC-379)

The Wind and Beyond

Vol. III

NASA SP-2021-4409

The Wind and Beyond: A Documentary Journey into the History of Aerodynamics in America

Volume III: Other Paths, Other Flyways

James R. Hansen and Jeremy R. Kinney, Editors
with D. Bryan Taylor, Molly F. Prickett, and J. Lawrence Lee

The NASA History Series



National Aeronautics and Space Administration
Office of Communications
NASA History Division
Washington, DC, 20546

Library of Congress Cataloging-in-Publication Data

The Wind and Beyond: A Documentary Journey into the History of Aerodynamics in America/James R. Hansen and Jeremy Kinney, editors; with D. Bryan Taylor, Molly F. Prickett, and J. Lawrence Lee.

p. cm. — (The NASA History Series) (NASA SP: 4409)

Includes bibliographical references and index.

Contents: v. 3. Other Paths, Other Flyways

1. Aerodynamics—Research—United States—History. 2. Aeronautical engineers—United States. I. Hansen, James R. II. Series III. Series: NASA SP: 4409

TL570.W64 2021

2002035774



This publication is available as a free download at <http://www.nasa.gov/ebooks>.



Table of Contents

Foreword	xix
Acknowledgments	xxi
Introduction to Volume III: Other Paths, Other Flywaysxxiii
Biographies of Volume III Contributors	xxv
CHAPTER FIVE: OTHER PATHS, OTHER FLYWAYS	1
Essay: The Aerodynamics of Airships, Flying Boats, and Rotary-Wing Aircraft . . .	1
The Documents	67
5-1, Excerpt from Max M. Munk, “My Early Aerodynamic Research— Thoughts and Memories,” in <i>Annual Review of Fluid Mechanics</i> 131 (1981): 1–7.	68
5-2 (a), “Development of Rigid Airships,” <i>NACA Annual Report</i> (1920), p. 19.	71
5-2 (b), “Production of Helium,” <i>NACA Annual Report</i> (1920), p. 19. . . .	71
5-2 (c), “Helium and Airships,” <i>NACA Annual Report</i> (1921), p. 5.	72
5-2 (d), “Airship Development,” <i>NACA Annual Report</i> (1921), pp. 21–22. .	72
5-2 (e), “Helium for Airships,” <i>NACA Annual Report</i> (1921), p. 22.	73
5-2 (f), “The Electrostatic Problem of Airships,” <i>NACA Annual Report</i> (1921), p. 22.	74
5-2 (g), “Special Committee on Design of Army Rigid Semirigid Airship ‘RS-1’,” <i>NACA Annual Report</i> (1924), pp. 9–10.	74
5-2 (h), “The Airship Problem,” <i>NACA Annual Report</i> (1925), p. 58. . . .	76
5-2 (i), “Airships,” <i>NACA Annual Report</i> (1927), pp. 72–74.	77
5-2 (j), “American Airship Development,” <i>NACA Annual Report</i> (1928), pp. 17–19.	80
5-2 (k), “Airships,” <i>NACA Annual Report</i> (1929), p. 85.	85
5-2 (l), “Airship Investigations,” <i>NACA Annual Report</i> (1929), pp. 30–32. .	86
5-2 (m), “Airships,” <i>NACA Annual Report</i> (1931), pp. 65–66.	89
5-2 (n), “Airships,” <i>NACA Annual Report</i> (1932), pp. 59–60.	91
5-2 (o), Excerpts from <i>Annual Report of the National Advisory Committee for Aeronautics</i> (Washington, DC), 1920–36. “Airships,” <i>Annual Report</i> (1933), p. 15.	93
5-2 (p), “Lighter-Than-Air Craft,” <i>NACA Annual Report</i> (1934), p. 2. . . .	93
5-2 (q), “Airships,” <i>NACA Annual Report</i> (1934), p. 17.	93
5-2 (r), “Airships,” <i>NACA Annual Report</i> (1935), p. 16.	94
5-2 (s), “Airships,” <i>NACA Annual Report</i> (1936), p. 17.	94

5-3, “Reports from the NACA Subcommittee on Airships,” in <i>Annual Report of the National Advisory Committee for Aeronautics</i> (Washington, DC), 1929–38.	95
5-4, “Resume of Airship Investigations Made by the National Advisory Committee for Aeronautics,” 1933.	103
5-5 (a), “Outline of Purpose and Method for Conduct of Research Authorization No. 255, ‘Study of Airship Forms, and Especially of Airship Appendages, in the Variable-Density Wind Tunnel.’ Approved by the Subcommittee on Airships, Dec. 20, 1928.”	108
5-5 (b), Garland Fulton, Comdr. (CC), USN, by Direction from the Chief of the Bureau of Aeronautics, to the Inspector of Naval Aircraft, Akron, Ohio, “Wind Tunnel Models of Airship ZRS-4,” 10 January 1929.	109
5-5 (c), Henry J. E. Reid, Engineer-in-Charge, NACA Langley, to NACA, “Meeting of Airships Subcommittee on January 10, 1931,” 7 January 1931. Attached to this letter is NACA Langley’s “Report to Subcommittee on Airships,” 10 January 1931.	110
5-5 (d), George W. Lewis, Director of Aeronautical Research, NACA, to Langley Memorial Aeronautical Laboratory, “Investigation of Models of Airship ZRS-4, in Propeller Research Tunnel and Variable- Density Wind Tunnel,” 15 January 1931.	113
5-5 (e), Henry J. E. Reid to NACA, “Investigation of Models of Airship ZRS-4 in Propeller Research Tunnel and Variable-Density Tunnel,” 17 January 1931.	114
5-5 (f), C. P. Burgess, Bureau of Aeronautics, U.S. Navy, “Significance of the Tests of the Metal Models of Airships ZRS-4 and MC-38 in the Variable-Density Wind Tunnel,” Design Memorandum No. 108 (March 1931).	115
5-5 (g), “Airship Investigations of the National Advisory Committee for Aeronautics,” 10 March 1932.	116
5-6 (a), “‘Airship Dropping’: Extract from Memorandum Dated 10/26/29, by Eastman N. Jacobs, Regarding Subject Discussed with Professor G. I. Taylor During His Visit to Langley Memorial Aeronautical Laboratory,” 2 November 1929.	118
5-6 (b), Eastman N. Jacobs, Associate Aeronautical Engineer, NACA Langley, to Engineer-in-Charge, “Request for Airship Test Authorization for Variable-Density Wind Tunnel,” 30 January 1931.	119
5-6 (c), Eastman N. Jacobs, Associate Aeronautical Engineer, NACA Langley, to Engineer-in-Charge, “Investigation of Airship Forms in Variable-Density Tunnel,” 11 January 1932.	119

5-6 (d), George W. Lewis, Director of Aeronautical Research, NACA, to Langley Memorial Aeronautical Laboratory, "Investigation of Airship Forms in the Variable-Density Wind Tunnel, 19 February 1932." . . .	121
5-7 (a), Hugh B. Freeman, Assistant Physicist, NACA Langley, "Boundary Layer Control for Airships," 8 January 1934.	123
5-7 (b), Floyd L. Thompson, Associate Aeronautical Engineer, "Comments Regarding Proposed Full-Scale Tests on the Airship Los Angeles," 17 April 1934.	126
5-7 (c), George W. Lewis to Dr. Joseph S. Ames, c/o Morgan et Cie, Place Vendôme, Paris, France, 2 July 1932.	127
5-8 (a), Max M. Munk, "On the Problems of Progressive Airship Research," in <i>Report on Airship Forum, July 25–26, 1935</i> (Akron, OH: The Daniel Guggenheim Airship Institute, Publication No. 3, 1935), pp. 89–96.	130
5-8 (b), Theodore von Kármán, "Lighter Than Air," in <i>The Wind and Beyond: Theodore von Kármán, Pioneer in Aviation and Pathfinder in Space</i> (Boston and Toronto: Little, Brown and Co., 1967), pp. 159–168.	140
5-9 (a), Max M. Munk, "Preface: Aerodynamics of Airships," in <i>Aerodynamic Theory: A General Review of Progress, Under a Grant of the Guggenheim Fund for the Promotion of Aeronautics</i> , vol. 6, ed. William F. Durand (Berlin: Julius Springer, 1934), pp. 32–33.	149
5-9 (b), Karl Arnstein and Wolfgang Klemperer, excerpts from "Performance of Airships," in <i>Aerodynamic Theory: A General Review of Progress, Under a Grant of the Guggenheim Fund for the Promotion of Aeronautics</i> , vol. 6, ed. William F. Durand (Berlin: Julius Springer, 1934), pp. 69–80 and pp. 88–102.	151
5-10 (a), "Across the Ocean by Airship!" Deutsche Zeppelin-Reederei advertising brochure, 16 pp., 1937.	174
5-10 (b), "Hindenburg Burns in Lakehurst Crash," <i>New York Times</i> (7 May 1937): 1.	182
5-11, Excerpt from Dr. Hugo Eckener, <i>Im Zeppelin über Länder und Meere</i> , p. 559, translated in Douglas H. Robinson, <i>Giants in the Sky: A History of the Rigid Airship</i> (Seattle: University of Washington Press, 1973), p. 324.	186
5-12 (a), "Welcome to Worldwide Aeros."	188
5-12 (b), "Interface Airships."	192
5-12 (c), "Prospective Concepts AG."	193
5-12 (d), "Welcome to Advanced Technologies Group: Revolutionary Aerospace Solutions and Telecommunications in the 21st Century." .	194

5-12 (e), “The Easy Solution to the Problem of Transporting Heavy Loads,” Press Release from CargoLifter AG, Frankfurt, Germany, May 2000.	198
5-13 (a), Octave Chanute to Wilbur Wright, 13 March 1903, quoted in H. F. King, <i>Aeromarine Origins: The Beginnings of Marine Aircraft, Winged Hulls, Air-Cushion and Air-Lubricated Craft, Planing Boats and Hydrofoils</i> (London: Putnam, 1966), pp. 19–20.	202
5-13 (b), Orville Wright to Commander Holden C. Richardson, date unknown, quoted in H. F. King, <i>Aeromarine Origins</i> , pp. 24–25.	202
5-13 (c), Story in <i>Dayton Daily News</i> , date unknown, quoted in H. F. King, <i>Aeromarine Origins</i> , p. 25.	203
5-13 (d), Bishop Milton Wright, diary entry, 1907, quoted in H. F. King, <i>Aeromarine Origins</i> , p. 37.	203
5-14 (a), Gabriel Voisin on Henri Fabre’s hydroaeroplane, date unknown, quoted in H. F. King, <i>Aeromarine Origins</i> , pp. 28–29.	204
5-14 (b), Anonymous report on Fabre’s hydroaeroplane, October 1909, quoted in H. F. King, <i>Aeromarine Origins</i> , p. 29.	205
5-14 (c), E. Holt-Thomas on Fabre hydroaeroplane, June 1912, quoted in H. F. King, <i>Aeromarine Origins</i> , p. 30.	205
5-14 (d), Article in <i>The Yachting World</i> , 1911, quoted in H. F. King, <i>Aeromarine Origins</i> , p. 31.	206
5-15, Grover Cleveland Loening, “Keels,” in <i>Monoplanes and Biplanes: Their Design, Construction, and Operation</i> (New York: Munn & Co., 1911), pp. 255–259.	208
5-16, Lieutenant T. G. Ellyson, U.S.N., “Safe Flying and the Flying Boat,” <i>Transactions of the New York Electrical Society</i> (New Series, 1913, No. 6): 69–79.	213
5-17 (a), Samuel W. Stratton, Secretary, National Advisory Committee for Aeronautics, 2722 Navy Building, 17th and B Streets NW, Washington, DC, to Dr. J. C. Hunsaker, Member, Committee on Aerodynamics, NACA, Washington, DC, 17 May 1920.	220
5-17 (b), J. C. Hunsaker, Commander, Construction Corps, U.S. Navy, to Dr. Joseph S. Ames, National Advisory Committee for Aeronautics, Room 2722, Navy Building, Washington, DC, “Letter from N.A.C.A. to Dr. Hunsaker dated May 17, 1920, No. 3261,” 1 September 1920.	221
5-17 (c), Ludwig Prandtl, “Applications of Modern Hydrodynamics to Aeronautics,” NACA Technical Report 116 (Washington, DC, 1921).	222
5-18 (a), “The N.C.’s,” selection from Grover Loening, <i>Our Wings Grow Faster</i> (Garden City, NY: Doubleday, Doran & Co., Inc., 1935), p. 103.	239

5-18 (b), “The Flying Yacht,” selection from Grover Loening, <i>Our Wings Grow Faster</i> (Garden City, NY: Doubleday, Doran & Co., Inc., 1935), pp. 112–113.	240
5-18 (c), “A Goal Achieved,” selection from Grover Loening, <i>Our Wings Grow Faster</i> (Garden City, NY: Doubleday, Doran & Co., Inc., 1935), p. 114.	241
5-18 (d), “New York to Newport,” selection from Grover Loening, <i>Our Wings Grow Faster</i> (Garden City, NY: Doubleday, Doran & Co., Inc., 1935), pp. 119–122.	241
5-18 (e), “The Crisis,” selection from Grover Loening, <i>Our Wings Grow Faster</i> (Garden City, NY: Doubleday, Doran & Co., Inc., 1935), pp. 123–126.	244
5-18 (f), “Cutting Too Close,” selection from Grover Loening, <i>Our Wings Grow Faster</i> (Garden City, NY: Doubleday, Doran & Co., Inc., 1935), pp. 130–131.	245
5-18 (g), “Off to a Good Start,” selection from Grover Loening, <i>Our Wings Grow Faster</i> (Garden City, NY: Doubleday, Doran & Co., Inc., 1935), pp. 137–138.	246
5-18 (h), “Orders and Orders,” selection from Grover Loening, <i>Our Wings Grow Faster</i> (Garden City, NY: Doubleday, Doran & Co., Inc., 1935), pp. 139–140.	247
5-19 (a), Henry S. Conklin, Associate Aeronautical Engineer, Naval Aircraft Factory, “Development of Navy Patrol Planes,” <i>Aero Digest</i> 6 (May 1925): 242–244, 288.	250
5-19 (b), Commander W. W. Webster (CC), U.S.N., “The Navy PN-12 Seaplane,” <i>Aviation</i> 24 (14 May 1928): 1366, 1404.	256
5-19 (c), Rear Admiral W. A. Moffett, U.S.N., Chief of the Bureau of Aeronautics, to Chief of Naval Operations, “Fleet Patrol Plane,” 17 August 1932.	259
5-20 (a), Walter S. Diehl, “Seaplane Floats,” chapter 15 in <i>Engineering Aerodynamics</i> (New York: The Ronald Press Co., 1928), pp. 253–265.	263
5-20 (b), William Nelson, “Take-Off of the Seaplane,” chapter 9 in <i>Seaplane Design</i> (New York and London: McGraw-Hill Book Company, Inc., 1934), pp. 102–121.	273
5-20 (c), Marcus Langley, “Flying Boat Hull Design,” chapter 5 in <i>Seaplane Float and Hull Design</i> (London: Sir Isaac Pitman & Sons, 1935), pp. 80–92.	284
5-21 (a), H. J. E. Reid, Engineer-in-Charge, Langley Memorial Aeronautical Laboratory, to NACA, “Extension of Work on Seaplane Floats and Flying-Boat Hulls To Include Aerodynamic Tests and Necessity for Tests and Reports on Propellers at Low Speed of Advance,” 26 September 1933.	296

5-21 (b), G. W. Lewis to LMAL, "LMAL Letter of September 26, 1933," 29 September 1933.	298
5-21 (c), "Outline of Purpose and Method for Conduct of Research Authorization No. 433, 'Investigation of the Air Drag of Seaplane Floats and Flying Boat Hulls,'" 7 October 1933.	299
5-21 (d), G. W. Lewis to LMAL, "Drag of Floats and Hulls—Work of Bureau of Aeronautics in Reducing," 10 January 1934.	300
5-21 (e), Starr Truscott, Head Aeronautical Engineer, to Engineer-in- Charge, LMAL, "Proposed Program on Forms Suitable for the Hulls of Large, High-Speed Flying Boats—Including Both Aerodynamic and Hydrodynamic Tests To Determine the Optimum Combination of Qualities," 8 March 1938.	300
5-21 (f), Starr Truscott, Head Aeronautical Engineer, to Engineer-in- Charge, LMAL, "Proposed Program of Research on Forms of Hulls Suitable for Use in Flying Boats of Large Size and High Speed— Conversation with Commander Diehl," 5 May 1938.	304
5-22 (a), Excerpts from <i>Annual Report of the National Advisory Committee for Aeronautics</i> (Washington, DC, 1933–40). "Seaplanes," <i>Annual Report</i> (1933), pp. 15–16.	307
5-22 (b), Excerpts from <i>Annual Report of the National Advisory Committee for Aeronautics</i> (Washington, DC, 1933–40). "Seaplanes," <i>Annual Report</i> (1934), pp. 20–22.	309
5-22 (c), Excerpts from <i>Annual Report of the National Advisory Committee for Aeronautics</i> (Washington, DC, 1933–40). "Subcommittee on Seaplanes," <i>Annual Report</i> (1935), pp. 20–21.	313
5-22 (d), Excerpts from <i>Annual Report of the National Advisory Committee for Aeronautics</i> (Washington, DC, 1933–40). "Subcommittee on Seaplanes," <i>Annual Report</i> (1936), pp. 19–20.	316
5-22 (e), Excerpts from <i>Annual Report of the National Advisory Committee for Aeronautics</i> (Washington, DC, 1933–40). "Subcommittee on Seaplanes," <i>Annual Report</i> (1937), pp. 22–23.	318
5-22 (f), Excerpts from <i>Annual Report of the National Advisory Committee for Aeronautics</i> (Washington, DC, 1933–40). "Subcommittee on Seaplanes," <i>Annual Report</i> (1938), pp. 20–22.	320
5-22 (g), Excerpts from <i>Annual Report of the National Advisory Committee for Aeronautics</i> (Washington, DC, 1933–40). "Subcommittee on Seaplanes," <i>Annual Report</i> (1939), pp. 19–21.	323
5-22 (h), Excerpts from <i>Annual Report of the National Advisory Committee for Aeronautics</i> (Washington, DC, 1933–40). "Subcommittee on Seaplanes," <i>Annual Report</i> (1940), pp. 10–11.	326
5-23 (a), Carl J. Wenzinger and Joseph A. Shortal, "Aerodynamic Tests of 1/25-Scale Model of Boeing Airplane No. 314 in the N.A.C.A. 7- by	

10-Foot Wind Tunnel (Modified), <i>NACA Confidential Memorandum Report for Boeing Aircraft Company</i> (Seattle, Washington, 2 September 1936).	330
5-23 (b), Wellwood E. Beall, Engineer in Charge of All Commercial Projects, Engineering Department, Boeing Aircraft Company, "Design Aspects of the Boeing Trans-Atlantic Clipper," presented at the Air Transport Meeting of the Institute of Aeronautical Sciences, Chicago, IL, 18–19 November 1938.	337
5-23 (c), Wellwood E. Beall, Chief Engineer, Boeing Aircraft Co., "Clipper of the '40's," <i>Yale Scientific Magazine</i> (Winter 1940): 2–4, 29–31.	353
5-24 (a), E. G. Stout, Consolidated Aircraft Corp., San Diego, CA, "Flying Boat Development," <i>Report No. ZH-011</i> (August 1943).	361
5-24 (b), L. D. Coates, Comdr., USN, Memorandum of a Conference, Bureau of Aeronautics, Navy Department, "Trend of Future Design in VPB Types," 10 February 1944.	370
5-25 (a), E. G. Stout, "Proposal for Hydrodynamic Test Program of CVAC Long Range Flying Boat Development," <i>Report No. ZH-017</i> , revised July 1944.	373
5-25 (b), Campbell C. Yates and John M. Riebe, "Effect of Length-Beam Ratio on the Aerodynamic Characteristics of Flying-Boat Hulls," NACA Technical Note 1305 (Washington, DC, June 1947).	381
5-26, George W. Gray, "Air and Water," chapter 4 in <i>Frontiers of Flight: The Story of NACA Research</i> (New York: Alfred A. Knopf, 1948), pp. 63–81.	403
5-27 (a), Excerpts from <i>Annual Report of the National Advisory Committee for Aeronautics</i> (Washington, DC), 1946–57, "Hydrodynamics," <i>Annual Report</i> (1946), pp. 8–9.	419
5-27 (b), Excerpts from <i>Annual Report of the National Advisory Committee for Aeronautics</i> (Washington, DC), 1946–57, "Seaplane Design," <i>Annual Report</i> (1946), p. 14.	420
5-27 (c), Excerpts from <i>Annual Report of the National Advisory Committee for Aeronautics</i> (Washington, DC), 1946–57, "Subcommittee on Seaplanes," <i>Annual Report</i> (1947), pp. 23–24.	421
5-27 (d), Excerpts from <i>Annual Report of the National Advisory Committee for Aeronautics</i> (Washington, DC), 1946–57, "Subcommittee on Seaplanes," <i>Annual Report</i> (1948), pp. 21–22.	422
5-27 (e), Excerpts from <i>Annual Report of the National Advisory Committee for Aeronautics</i> (Washington, DC), 1946–57, "Subcommittee on Seaplanes," <i>Annual Report</i> (1949), pp. 25–26.	423

5-27 (f), Excerpts from <i>Annual Report of the National Advisory Committee for Aeronautics</i> (Washington, DC), 1946–57, “Subcommittee on Seaplanes,” <i>Annual Report</i> (1950), p. 27.	425
5-27 (g), Excerpts from <i>Annual Report of the National Advisory Committee for Aeronautics</i> (Washington, DC), 1946–57, “Seaplanes,” <i>Annual Report</i> (1951), p. 16.	426
5-27 (h), Excerpts from <i>Annual Report of the National Advisory Committee for Aeronautics</i> (Washington, DC), 1946–57, “Seaplanes,” <i>Annual Report</i> (1952), p. 28.	426
5-27 (i), Excerpts from <i>Annual Report of the National Advisory Committee for Aeronautics</i> (Washington, DC), 1946–57, “Seaplanes,” <i>Annual Report</i> (1953), p. 17.	427
5-27 (j), Excerpts from <i>Annual Report of the National Advisory Committee for Aeronautics</i> (Washington, DC), 1946–57, “Seaplanes,” <i>Annual Report</i> (1954), pp. 25–26.	428
5-27 (k), Excerpts from <i>Annual Report of the National Advisory Committee for Aeronautics</i> (Washington, DC), 1946–57, “Seaplanes,” <i>Annual Report</i> (1955), pp. 23–24.	430
5-27 (l), Excerpts from <i>Annual Report of the National Advisory Committee for Aeronautics</i> (Washington, DC), 1946–57, “Seaplanes,” <i>Annual Report</i> (1956), pp. 37–38.	432
5-27 (m), Excerpts from <i>Annual Report of the National Advisory Committee for Aeronautics</i> (Washington, DC), 1946–57, “Seaplanes,” <i>Annual Report</i> (1957), pp. 24–25.	434
5-28 (a), Selections from John W. R. Taylor and Maurice F. Allward, <i>Wings for Tomorrow</i> (London: Ian Allan Ltd., 1951), Rt. Hon. The Lord Brabazon of Tara, “Foreword,” pp. 3–4.	439
5-28 (b), Selections from John W. R. Taylor and Maurice F. Allward, <i>Wings for Tomorrow</i> (London: Ian Allan Ltd., 1951), “Wings for Tomorrow,” pp. 97–104.	440
5-29 (a), Anders J. Christenson, FAA Pilot Examiner, “Observations of a Seaplane Pilot Examiner.”	448
5-29 (b), “Kenmore Air—A Unique Airline; ‘An Experience You’ll Never Forget.’”	454
5-29 (c), “Seawinds.”	456
5-29 (d), “SeaAirNY.”	458
5-29 (e), “Seawolf: Multi-Mission Amphibian.”	459
5-30, Excerpt from Theodore Von Kármán with Lee Edson, <i>The Wind and Beyond: Theodore Von Kármán, Pioneer in Aviation and Pathfinder in Space</i> (Boston & Toronto: Little, Brown and Company, 1967), pp. 85–87.	462

5-31, Edward P. Warner, Chief Physicist, Aerodynamical Laboratory, NACA, Langley Field, VA, "The Problem of the Helicopter," NACA Technical Note 4 (Washington, DC, May 1920), with an "Appendix" by William F. Durand, Stanford University, 3 April 1920.	465
5-32, "The Oehmichen Peugeot Helicopter," NACA Technical Memorandum 13 (Washington, DC, 1921), translated by the Paris Office of the NACA, March 1921.	482
5-33, Excerpt from Fred E. Weick and James R. Hansen, <i>From the Ground Up: The Autobiography of an Aeronautical Engineer</i> (Washington, DC, and London: Smithsonian Institution Press, 1988), pp. 44–45.	487
5-34, Excerpts from Alexander Klemin, "An Introduction to the Helicopter," NACA Technical Memorandum 340 (Washington DC, 1925).	489
5-35, M. Moreno-Caracciollo, "The 'Autogiro,'" NACA Technical Memorandum 218 (July 1923).	524
5-36 (a), Juan de la Cierva, "The Development of the Autogyro," <i>Journal of the Royal Aeronautical Society</i> (January 1926): 8–29.	534
5-36 (b), Juan de la Cierva, "The Development of the Autogyro," <i>Journal of the Royal Aeronautical Society</i> (November 1930): 902–921.	552
5-37, Juan de la Cierva and Don Rose, "The Autogiro in America," in <i>Wings of Tomorrow: The Story of the Autogiro</i> (New York: Brewer, Warren & Putnam, 1931), pp. 126–133.	576
5-38 (a), Frank Tichenor, excerpt from editorial, "Why the NACA?," <i>Aero Digest</i> (December 1930): 49–50.	581
5-38 (b), Henry J. E. Reid, Engineer-in-Charge, NACA Langley, to George W. Lewis, Director of Research, NACA, Washington, DC, 2 January 1931.	581
5-39 (a), Excerpts from <i>Annual Report of the National Advisory Committee for Aeronautics</i> (Washington, DC), 1933–40, "Rotating-Wing Aircraft," <i>Annual Report</i> (1933), pp. 14–15.	583
5-39 (b), Excerpts from <i>Annual Report of the National Advisory Committee for Aeronautics</i> (Washington, DC), 1933–40, "Rotating-Wing Aircraft," <i>Annual Report</i> (1934), pp. 16–17.	584
5-39 (c), Excerpts from <i>Annual Report of the National Advisory Committee for Aeronautics</i> (Washington, DC), 1933–40, "Rotating-Wing Aircraft," <i>Annual Report</i> (1935), p. 16.	585
5-39 (d), Excerpts from <i>Annual Report of the National Advisory Committee for Aeronautics</i> (Washington, DC), 1933–40, "Rotating-Wing Aircraft," <i>Annual Report</i> (1936), pp. 16–17.	586

5-39 (e), Excerpts from <i>Annual Report of the National Advisory Committee for Aeronautics</i> (Washington, DC), 1933–40, “Rotating-Wing Aircraft,” <i>Annual Report</i> (1937), pp. 18–19.	588
5-39 (f), Excerpts from <i>Annual Report of the National Advisory Committee for Aeronautics</i> (Washington, DC), 1933–40, “Rotating-Wing Aircraft,” <i>Annual Report</i> (1938), p. 17.	589
5-39 (g), Excerpts from <i>Annual Report of the National Advisory Committee for Aeronautics</i> (Washington, DC), 1933–40, “Rotating-Wing Aircraft,” <i>Annual Report</i> (1939), pp. 16–17.	589
5-39 (h), Excerpts from <i>Annual Report of the National Advisory Committee for Aeronautics</i> (Washington, DC), 1933–40, “Rotating-Wing Aircraft,” <i>Annual Report</i> (1940), p. 8.	590
5-40, Heinrich Focke, “The Focke Helicopter,” NACA Technical Memorandum 858 (April 1938), translation of “Der Focke-Hubschrauber,” <i>Luftwissen</i> 5 (February 1938): 33–39, by S. Reiss, NACA.	593
5-41, Igor S. Sikorsky, “The Helicopter Becomes a Reality,” <i>The Story of the Winged-S: Late Developments and Recent Photographs of the Helicopter; An Autobiography</i> (New York: Dodd, Mead & Company, Inc., first published in 1938, with subsequent editions in 1941, 1948, 1958, and 1967).	607
5-42, Excerpt from Arthur Young, <i>The Bell Notes: A Journey from Metaphysics to Physics</i> (Mill Valley, CA: Roberts Briggs Associates, 1979), pp. 9–22.	617
5-43 (a), Excerpts from <i>Annual Report of the National Advisory Committee for Aeronautics</i> (Washington, DC), 1946–58, “Helicopters,” <i>Annual Report</i> (1946), pp. 13–14.	629
5-43 (b), Excerpts from <i>Annual Report of the National Advisory Committee for Aeronautics</i> (Washington, DC), 1946–58, “Subcommittee of Helicopters,” <i>Annual Report</i> (1947), pp. 22–23.	630
5-43 (c), Excerpts from <i>Annual Report of the National Advisory Committee for Aeronautics</i> (Washington, DC), 1946–58, “Subcommittee on Helicopters,” <i>Annual Report</i> (1948), p. 21.	633
5-43 (d), Excerpts from <i>Annual Report of the National Advisory Committee for Aeronautics</i> (Washington, DC), 1946–58, “Subcommittee on Helicopters,” <i>Annual Report</i> (1949), pp. 24–25.	635
5-43 (e), Excerpts from <i>Annual Report of the National Advisory Committee for Aeronautics</i> (Washington, DC), 1946–58, “Subcommittee on Helicopters,” <i>Annual Report</i> (1950), pp. 27–29.	638
5-43 (f), Excerpts from <i>Annual Report of the National Advisory Committee for Aeronautics</i> (Washington, DC), 1946–58, “Rotary Wing Aircraft,” <i>Annual Report</i> (1951), pp. 16–17.	641

5-43 (g), Excerpts from <i>Annual Report of the National Advisory Committee for Aeronautics</i> (Washington, DC), 1946–58, “Rotary Wing Aircraft,” <i>Annual Report</i> (1952), pp. 26–28.	642
5-43 (h), Excerpts from <i>Annual Report of the National Advisory Committee for Aeronautics</i> (Washington, DC), 1946–58, “Helicopters,” <i>Annual Report</i> (1953), pp. 17–18.	645
5-43 (i), Excerpts from <i>Annual Report of the National Advisory Committee for Aeronautics</i> (Washington, DC), 1946–58, “Helicopters,” <i>Annual Report</i> (1954), pp. 26–27.	647
5-43 (j), Excerpts from <i>Annual Report of the National Advisory Committee for Aeronautics</i> (Washington, DC), 1946–58, “Helicopters,” <i>Annual Report</i> (1955), pp. 21–23.	650
5-43 (k), Excerpts from <i>Annual Report of the National Advisory Committee for Aeronautics</i> (Washington, DC), 1946–58, “Helicopters,” <i>Annual Report</i> (1956), pp. 36–37.	655
5-43 (l), Excerpts from <i>Annual Report of the National Advisory Committee for Aeronautics</i> (Washington, DC), 1946–58, “Rotary Wing Aircraft,” <i>Annual Report</i> (1957), pp. 25–26.	658
5-43 (m), Excerpts from <i>Annual Report of the National Advisory Committee for Aeronautics</i> (Washington, DC), 1946–58, “Rotary Wing Aircraft,” <i>Annual Report</i> (1958), pp. 44–45.	660
5-44 (a), John P. Reeder and F. B. Gustafson, “Notes on the Flying Qualities of Helicopters,” presented at the annual meeting of the American Helicopter Society, 22–24 April 1948.	664
5-44 (b), John P. Reeder and F. B. Gustafson, “Flying Qualities of Tandem-Rotor Helicopters,” <i>Aero Digest</i> (May 1953): 103–109. . . .	673
5-45, Alfred E. Gessow and Garry C. Myers, Jr., “An Introduction to the Helicopter,” chapter 2 in <i>The Aerodynamics of the Helicopter</i> (New York: Frederick Ungar Publishing, 1985), pp. 16–45; first published by Ungar in 1951.	678
5-46 (a), Excerpts from Wayne Johnson, <i>Helicopter Theory</i> (Princeton, NJ: Princeton University Press, 1980), chapter 1, “Introduction,” pp. 3–11.	698
5-46 (b), Excerpts from Wayne Johnson, <i>Helicopter Theory</i> (Princeton, NJ: Princeton University Press, 1980), chapter 7, “Design,” pp. 313–321.	703
5-47 (a), Robert L. Lichten, “Some Aspects of Convertible Aircraft Design,” <i>Journal of the Aeronautical Sciences</i> 16 (October 1949): 611–622.	712
5-47 (b), Robert L. Lichten, “Some Performance and Operating Characteristics of Convertiplanes,” presented at the national	

meeting of the Society of Automotive Engineers, Los Angeles, CA, 30 September–5 October 1957.	735
5-48 (a), Richard E. Kuhn, Langley Research Center, “Review of Basic Principles of V/STOL Aerodynamics,” in <i>NASA Conference on V/STOL Aircraft; A Compilation of the Papers Presented</i> , Langley Research Center, Langley Field, Virginia, 17–18 November 1960 (NASA, 1960), pp. 1–17.	744
5-48 (b), Robert H. Kirby, Langley Research Center, “Aerodynamic Characteristics of Propeller-Driven VTOL Aircraft,” <i>NASA Conference on V/STOL Aircraft</i> , pp. 19–34.	756
5-48 (c), Richard C. Dingeldein, Langley Research Center, “Considerations of Methods of Improving Helicopter Efficiency,” <i>NASA Conference on V/STOL Aircraft</i> , pp. 101–117.	766
5-48 (d), F. B. Gustafson, Robert J. Pegg, and Henry L. Kelley, Langley Research Center, “Aerodynamic Observations from Flight Tests of Two VTOL Aircraft,” <i>NASA Conference on V/STOL Aircraft</i> , pp. 149–169.	776
5-48 (e), Charles H. Zimmerman, Langley Research Center, “Summary of V/STOL State of the Art,” <i>NASA Conference on V/STOL Aircraft</i> , pp. 335–345.	788
5-49 (a), Selections from Martin D. Maisel, Demo J. Giulianetti, and Daniel C. Dugan, <i>The History of the XV-15 Tilt Rotor Research Aircraft: From Concept to Flight</i> , Monographs in Aerospace History, no. 17 (Washington, DC: NASA, 2000), “XV-3 Program,” pp. 12–19.	795
5-49 (b), Selections from Martin D. Maisel, Demo J. Giulianetti, and Daniel C. Dugan, <i>The History of the XV-15 Tilt Rotor Research Aircraft: From Concept to Flight</i> , Monographs in Aerospace History, no. 17 (Washington, DC: NASA, 2000), “Building the Technology Base,” pp. 20–27.	800
5-49 (c), Selections from Martin D. Maisel, Demo J. Giulianetti, and Daniel C. Dugan, <i>The History of the XV-15 Tilt Rotor Research Aircraft: From Concept to Flight</i> , Monographs in Aerospace History, no. 17 (Washington, DC: NASA, 2000), “Flight Research,” pp. 65–82.	805
5-49 (d), Selections from Martin D. Maisel, Demo J. Giulianetti, and Daniel C. Dugan, <i>The History of the XV-15 Tilt Rotor Research Aircraft: From Concept to Flight</i> , Monographs in Aerospace History, no. 17 (Washington, DC: NASA, 2000), “Epilogue,” pp. 105–114.	819
5-50, J. C. Narramore, “Advanced Technology Airfoil Development for the XV-15 Tilt-Rotor Vehicle,” presented at AIAA/NASA Ames VSTOL Conference, 7–9 December 1981, Palo Alto, CA.	830

5-51, Michael K. Farrell, Bell Helicopter Textron, Fort Worth, TX,
 “Aerodynamic Design of the V-22 Osprey Proprotor,” presented at
 the 45th Annual Forum of the American Helicopter Society, Boston,
 MA, 22–24 May 1989 839

5-52 (a), Eric Umansky, “Chopper Troubles: The Army’s New Attack
 Helicopter Has a Little Weight Problem,” *Mother Jones* (January/
 February 1999). 857

5-52 (b), Nick Kernstock, “Sikorsky S-92 Helibus Makes First Flight,”
Rotor & Wing 33 (February 1999). 858

5-52 (c), Jim Wilson, Stefano Coledan, and Steve Ditlea, “21st Century
 Sky Trooper,” *Popular Mechanics* 176, no. 4 (April 1999): 21. 860

5-53, Dennis Bushnell, “The Personal Helicopter,” in *The Personal
 Aircraft—Status and Issues* (NASA Langley Research Center,
 Hampton, VA: NASA Technical Memorandum 109174, December
 1994), pp. 37–44. 862

5-54, E. K. Liberatore, “Epilogue,” *Helicopters Before Helicopters*
 (Malabar, FL: Krieger Publishing Company, 1998), pp. 157–169. . . 870

NASA HISTORY SERIES 885

INDEX 901

Foreword

The airplane is surely one of the most significant technological achievements of the last century. The impact of aircraft goes far beyond the realm of the history of technology, for it touches upon virtually every aspect of modern life. While the National Aeronautics and Space Administration (NASA) is widely seen by the public as a space exploration agency, “aeronautics” is the second word in our agency’s name for a reason. NASA was founded primarily on the basis of the National Advisory Committee for Aeronautics (NACA) in 1958 and has carried forward cutting-edge, practical research on aviation since then. Although NASA’s aeronautics achievements have taken place in the shadow of the headline accomplishments of our space program, they have continued to be of fundamental significance to the field, like those of the NACA. This series of books has been aimed at starting the same kind of documentary historical foundation that NASA’s history program has lavished on our space accomplishments.

The first two volumes in the *Wind and Beyond* series covered the genesis of the airplane and aeronautical research, as well as the design revolution that followed in the 1920s and 1930s. This volume pauses that chronology to review the documentary history of rotorcraft. The series was planned as an aeronautics companion to the *Exploring the Unknown: Selected Documents in the History of the U.S. Civil Space Program* (NASA SP-4407) series of books. As with *Exploring the Unknown*, the documents collected during this research project were assembled from diverse public and private sources. A major repository of primary source materials is the NASA Historical Reference Collection in the NASA History Division. Historical materials housed at NASA Field Centers, academic institutions, and presidential libraries were also considered for inclusion, as were papers in the archives of private individuals and corporations.

The format of this volume also is very similar to that of the *Exploring the Unknown* volumes, except that this volume consists of a single (large) chapter. Across the series, the chapters are numbered sequentially, with volume 1 containing chapters 1 and 2, volume 2 holding chapters 3 and 4, and this third book in the series consisting of chapter 5. But, as with the previous two volumes, the present volume starts with an overview essay that is intended to introduce and complement the documents that follow it and to place them in a chronological and substantive context. The essay contains references to the documents in the section it introduces and also contains references to documents in other sections of the collection. These introductory essays are the responsibility of Drs. Hansen and Kinney, the series authors and chief editors; the views and conclusions contained therein do not necessarily represent the opinions of Auburn University, the National Air and Space Museum, or NASA.

The documents included in this volume were chosen by the project team from a much longer list initially assembled by the research staff. The contents of this volume emphasize primary documents, including long-out-of-print essays and articles as well as material from the private collections of important actors in shaping rotorcraft thinking in the United States and abroad. Some key legislation and policy statements are also included. As much as possible, the goal of the series has been to create an integrated historical narrative.

For the most part, the documents included in each section are arranged chronologically. Each document, or string of documents, is assigned a number. For example, the 15th document herein is designated “Document 5-15” since it is the 15th document of chapter 5. Each document is accompanied by a headnote setting out its context and providing a background narrative. These headnotes also provide specific information and explanatory notes about people and events discussed. Many of the documents, as is the case with Document 5-2, involve document “strings,” i.e., Document 5-2 (a–s). Such strings involve multiple documents—in this case, 19 of them (a through s) that have been grouped together because they relate to one another in a significant way. Together, they work to tell one documentary “story.”

The editorial method that has been adopted seeks to preserve, as much as possible, the spelling, grammar, and language usage as they appear in the original documents. We have sometimes changed punctuation to enhance readability. We have used the designation [abridged] to note where sections of a document have not been included in this publication, and we have avoided including words and phrases that had been crossed out or removed in some other way from the original document unless they contribute to an understanding of what was going on in the mind of the writer in making the record. Marginal notations on the original documents are inserted into the text of the documents in brackets, each clearly marked as a marginal comment. Page numbers in the original document are noted in brackets internal to the document text. Copies of all documents in their original form are available for research by any interested person at the NASA History Division or Auburn University.

Drs. Hansen and Kinney and their team have crafted an award-winning reference work in the first three volumes of *The Wind and Beyond*. Original plans called for a total of six volumes in this series that would carry the documentary history of aeronautics through the 20th century. Unfortunately, work on the second half of the series is currently on hold. We hope to complete the series in the future. In the meantime, there is much to digest in this (and previous) volumes of this series. We wish you happy, and enlightening, reading.

William P. Barry, D.Phil.
NASA Chief Historian, 2010–20

Brian C. Odom, Ph.D., M.L.I.S.
Acting NASA Chief Historian

Acknowledgments

This volume represents the collected efforts of many members of an outstanding team. At Auburn University, a number of individuals provided generous assistance to Dr. James R. Hansen's project team. Dr. Paul F. Parks, former university provost, strongly encouraged and supported the project from its inception, as did Dr. Michael C. Moriarty, vice president for research. To undertake his leadership of the project, Dr. Hansen gave up his job as chair of the Department of History, something he would not have felt comfortable doing without being certain that the administration of his department would be in the capable hands of worthy successors—first Dr. Larry Gerber, and then Dr. William F. Trimble. Both Gerber and Trimble gave hearty and vocal support to Auburn's NASA history project. A number of colleagues in aerospace history gave help to the project, including distinguished university professor Dr. W. David Lewis and Dr. Stephen L. McFarland. Dr. Roy V. Houchin, who earned a doctorate under Hansen, lent aid and comfort to the project team from his vantage point inside the United States Air Force (USAF). A number of Hansen's graduate students assisted with the project in various ways, notably Andrew Baird and Kristen Starr. Dr. David Arnold, also of the USAF, and Dr. Amy E. Foster of the University of Central Florida, who earned their respective doctorates in aerospace history while this project was being conducted, also provided assistance.

The staff of the National Air and Space Museum (NASM) proved to be an important component of this team. In the Aeronautics Division, museum specialist Roger Connor provided valuable insight into the history of rotary-wing aircraft generated by his groundbreaking research. Archivists Melissa Keiser and Jessamyn Lloyd facilitated the acquisition of many photographs crucial to the stories in this volume. Volunteers Howard Wesoky and Michael Kern assisted with preliminary photograph selection, fact-checking, and image scanning.

A number of people in the NASA History Division deserve credit. Former Chief Archivist Jane Odom and archivists Colin Fries, John Hargenrader, and Liz Suckow tracked down documents from NASA's Historical Reference Collection. Nadine Andreassen provided much valuable general assistance. Interns Clare Kim, Jacki Cortese, and Madison Moore helped tremendously by organizing all the materials prior to starting production. Historian Steve Garber oversaw the entire process and made sure that our third volume became a reality.

Also at NASA Headquarters, Tony Springer in the Aeronautics Research Mission Directorate served as an invaluable sounding board on technical aeronautics issues. Former NASA Chief Historian Roger D. Launius is owed a special debt of gratitude for providing the initial impetus and guidance for this worthy project. Photo

archivist Teresa L. Hornbuckle deserves special mention for her help with locating historic National Advisory Committee for Aeronautics (NACA) and NASA photographs.

A talented, dedicated group of professionals in the NASA Headquarters Communications Support Services Center (CSSC) handled the production of this book over its long gestation. In particular, Lisa Jirousek ably served as the lead copy editor for this demanding manuscript, designer Michele Ostovar skillfully laid out this lengthy book and also created the index, and Tun Hla expertly oversaw the printing. CSSC supervisors Barbara Bullock, Maxine Aldred, and Tun Hla oversaw the production with grace and skill. Apologies to those whose names we've inadvertently omitted. Thanks are due to all these skilled, patient professionals.

Last but not certainly not least, our sincere gratitude to Karen Rugg in the Aeronautics Research Mission Directorate, who supported the printing of hard copies of this volume.

Introduction to Volume III

Other Paths, Other Flyways

It is a basic premise of the *Wind and Beyond* series that nothing about the historical development of aircraft has ever been linear. On the way to aeronautical “progress”—however one chooses to define the term—there has always been, and always will be, countless twists and turns. And in the end, the entire story could have turned out differently—and still may. It is hoped that not only this volume of our series, but also our entire study, will suggest to readers how the historical development of aerodynamics has always involved options, alternatives, and various ways of doing things.

Autogiro pioneer Juan de la Cierva wrote in his 1931 book *Wings of Tomorrow* that “the essential theory of flight can be reduced to a comparatively simple statement, though it becomes a highly complicated affair as it is presented in figures and formulae.”¹ As Cierva recognized, these technical complications are inherent in every single sort of flying machine, even to the simplest lighter-than-air craft.

But Cierva’s statement by itself underestimated the factors complicating the design of flying machines by restricting them just to “figures and formulae.” Dwarfing the undoubtedly limitless variations within technical design are the even more intricate networks of human complexity that underpin, shape, and ramify the creative process. The history of aerodynamics, like the entire history of science and technology, has not been just about engineering tables and equations, as multifaceted and fascinating as they have been in terms of influencing the course of invention and technical development. Even more so, the history of aerodynamics has been about ambition and drive; about social relations; about institutions, ideals, and aesthetics; and about dreams. It has been about what historian of technology Melvin C. Kranzberg called the “soft and mushy” things, like politics and culture, like what bankers think can make them money, or what activists say may harm the environment.² These contextual factors often negate or override technical and engineering logic—and, generally speaking, they should. Put the two “worlds” of technology together—the internal and the external, the figures and formulae along with the soft and mushy—and one confronts the myriad fascinations of studying technological history.

¹ Juan de la Cierva and Don Rose, *Wings of Tomorrow: The Story of the Autogiro* (New York: Brewer, Warren & Putnam, 1931), p. 66.

² Melvin C. Kranzberg, “Technology and History: ‘Kranzberg’s Laws,’” *Technology and Culture* 27 (July 1986): 547–549.

It is hoped that our readers will observe this theme throughout our work and come away with a richer feeling for both worlds, as well as for how the two are really an amalgam of one massive complex of historical forces. It is a leitmotif for which one should listen as we now move into the subsequent volumes of our work, dealing with the history of aerodynamics during the age of jets and rockets.

Biographies of Volume III Contributors

James R. Hansen is professor emeritus of history at Auburn University in Alabama. His *First Man* (2005), an award-winning biography of Neil Armstrong, spent three weeks on the New York Times bestseller list on two different occasions and as recently as 2018. He is coauthor with the late Allan J. McDonald of *Truth, Lies, and O-Rings: Inside the Space Shuttle Challenger Disaster* (2009), which has been called “the definitive study” of the Challenger accident. Jim served as the head of the Auburn team that initiated NASA’s multi-volume Wind and Beyond documentary history project over 20 years ago. His most recent contribution is a two-volume edited and annotated collection of Neil Armstrong’s correspondence, which was published by Purdue University Press in 2019–20.

Jeremy R. Kinney is the Associate Director for Research and Curatorial Affairs at the Smithsonian Institution’s National Air and Space Museum. He is the author of the award-winning *Reinventing the Propeller: Aeronautical Specialty and the Triumph of the Modern Airplane* (2017) and *The Power for Flight: NASA’s Contributions to Aircraft Propulsion* (2017). He has taught courses in aerospace history at the University of Maryland at College Park, George Mason University, and New York University. Before joining the Smithsonian, he was an American Historical Association/NASA Fellow in Aerospace History. He earned his doctorate in the history of technology from Auburn University.

D. Bryan Taylor holds a master’s degree in history from Brigham Young University and has conducted graduate studies in the history of technology at Auburn.

Molly E. Prickett holds a bachelor’s degree in English from Auburn University.

J. Lawrence Lee holds bachelor’s, master’s, and doctoral degrees from Auburn University. He is an engineer-historian at the Historic American Engineering Record, a branch of the National Park Service, and is a former chair of the History and Heritage Committee of the American Society of Mechanical Engineering.

Chapter Five

Other Paths, Other Flyways

Destination Document:

... [T]ypes of aircraft differ from one another not only in aerodynamics but also in most other respects. Thus, different types of fuel go together with different types of aircraft and, in general, each of the latter requires a particular mode of propulsion and type of engine. Again, each is likely to be associated with the use of particular materials and methods of construction, and the modes of operation may also differ. As a consequence, the design procedures generally differ from one type to another, and entirely different types of layout are obtained. These profound and widespread differences between the types of aircraft require equally radical changes in the outlook and the attitude of research workers and designers. In this respect, some psychological difficulties must be overcome because the immense success of the traditional classical layout has imbued us all with the notion that every aircraft should have a fuselage for providing the volume needed, separate wings for providing the lift, and separate engines for providing propulsion.

—Dietrich Küchemann,
The Aerodynamic Design of Aircraft (1978), p. 512.

The Aerodynamics of Airships, Flying Boats, and Rotary-Wing Aircraft

In the quotation above, German aerodynamicist Dietrich Küchemann was not thinking about airships, flying boats, or rotary-wing aircraft, the subjects of this volume. What he had in mind was the problem of technological orthodoxy, a constrained mindset that inhibited aircraft designers from thinking more creatively about the possibilities of bold new aircraft types based on radically different aerodynamic concepts and social needs. Specifically, the form of aircraft Küchemann promoted in his 1978 book on aerodynamics was the “wave rider,” a fully integrated propulsive lifting body that (in theory) could fly along at hypersonic speeds on top of strong shock waves that the moving body itself produced and contained between its sharp leading edges. Near the end of his provocative book, published two years after his death, Küchemann devoted an entire chapter to his belief in the potential of the wave rider. In his view, its extremely high speed and global range offered a



FIGURE 5.1. Pictured is Küchemann's dream of the future: a Mach 5.5 Wave Rider model in the Full Scale Wind Tunnel at Langley Research Center in the 1990s. (NASA Image #L-1995-04049 [LaRC])

way to bring the whole world together as a “global village” within an easy traveling time of a few hours—if the aircraft industry could only think far enough “outside the box” of classical aerodynamics to go after such a visionary design.

For us, Küchemann's words communicate a profound meaning that goes far beyond his wave-rider concept. They critique a linear approach by which aircraft development has been and generally still is understood—not just by engineers, but by historians as well. But aircraft development has never, anywhere, at any time, run the course of a straight line. It has taken sharp dips and turns. It has met with detours and has sometimes circled back upon itself. It has taken big leaps forward, but at other times it has seemed to run in place. It has come to countless forks in the road and encountered thousands of “paths not taken.” There have been hordes of mistakes, lost labors, and miserable failures. As many seemingly offbeat, screwball ideas emerged as did sound and practical ones. Some great ideas did not pan out, perhaps arriving before their time. Some types of aircraft came to life, flourished, and died out; but at none of these phases did they do so simply due to the “logic” of the technology itself. As Küchemann so obviously understood, other types of human forces have always been at work: political, economic, social, cultural, psychological, and even aesthetic. During specific eras, a certain type of

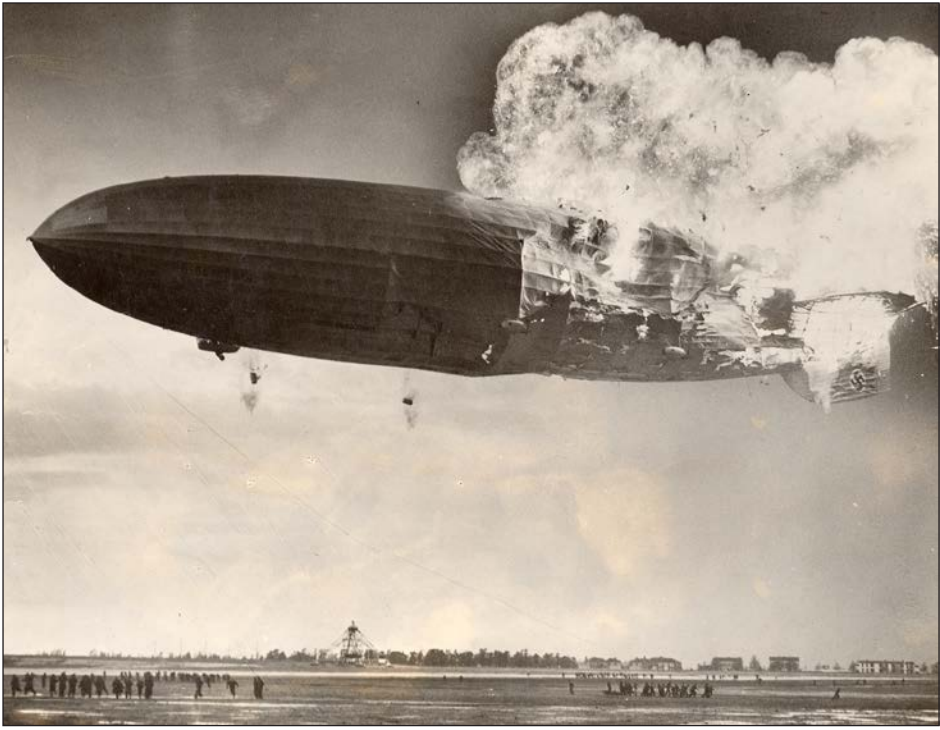

FIGURE 5.2. The explosion of the Hindenburg at Lakehurst, New Jersey, in May 1937 was one of the defining moments of 1930s culture after Herb Morrison's emotional broadcast of the disaster through radios across the United States. (National Air and Space Museum, Smithsonian Institution [SI 73-8701])

flying machine prospered; at other times, the very same type “lost” in competition with what came to prevail as the “conventional” technology of flying. Never were any of these developments inevitable. To a considerable extent, they depended, as Küchemann recognized, on biases, prejudices, and psychological factors at work within the aeronautical engineering design community. (One could point to any number of cases where this seemed to happen—for one, the antipathy directed for many years at the potential of the “flying wing.”) Perhaps even more so, the success or failure of an aircraft concept hinged on forces well beyond the control of the aeronautical community. Here, one need only think about the social and psychological forces that brought about the demise of the great rigid airship, a denouement that was primarily due to the public’s reaction to a single event: the fiery explosion of the Hindenburg at Lakehurst, New Jersey, on 6 May 1937.

In this chapter, a very long one, we will document the historical development of three types of flying machines. At different times, and in different ways, each one rivaled the conventional airplane. Two of them, the airship and the flying boat, flourished in the first five decades of the century and then virtually disappeared from the mainstream of aviation. The third type struggled in various ineffective

and experimental forms through the first half of the century, but eventually, one configuration, the helicopter, became highly successful and virtually ubiquitous, and other rotary-wing forms, such as the tilt-rotor, held out great promise by the end of the century.

But even the airship and the flying boat have managed to survive in some forms into the 21st century—not just in terms of design, manufacture, and operation, but also in terms of public enthusiasm and lasting impressions on the American psyche. Airships, those great lethargic giants of the sky, still engender feelings of nostalgia and romance. When a blimp flies over a neighborhood today, it is such a novelty that many will run outside to gaze up at its grace. To a lesser extent, the same has become true for the flying boat, though most people now have never seen one. A bare 50 years ago, though, at mid-century, people not just in America but around the world associated many of their earliest excitements and wonderments about aviation with these sorts of aircraft, both of which were well on their way to becoming dinosaurs by 1950. Then came the helicopter. The sound and sight of this machine came to convey extraordinary social and cultural meaning in the second half of the century. This happened largely because of the conflict in Vietnam, a veritable



FIGURE 5.3. Flights of Bell UH-1 Iroquois, or “Huey,” helicopters in the skies over Vietnam were a constant image for soldiers and marines on the ground and the American people at home through their television sets. (Army News Features via NASM, Smithsonian Institution [SI 2006-622])

“helicopter war.” Not only did millions of TV viewers regularly see on the nightly news how helicopter gunships served as taxicabs for war correspondents, but they saw them armed with rockets and multi-barrel machine guns and providing close support to ground troops. The public saw helicopters flying medical-evacuation and search-and-rescue missions—and even though they did not see them doing it, they knew that helicopters were also carrying out clandestine missions behind enemy lines. Between 1962 and 1973, the United States armed forces fighting in Southeast Asia lost a total of 4,870 helicopters in either combat or noncombat operations. Nearly 2,200 American helicopter pilots lost their lives or were reported as missing in action. The sound of “choppers coming in” became both the audio and visual icon of the Vietnam experience. Director Francis Ford Coppola used the sound, fury, and moral ambiguity of the helicopter in powerful ways in his 1979 film *Apocalypse Now*. So vital was the helicopter to live theater’s *Miss Saigon* and its tragic opera of evacuating the American embassy in April 1975 that its producers went to the trouble of building a full-scale mockup of a helicopter gunship and “flying” it onto the stage for every single performance.

Readers might wonder about the efficacy of combining the history of all three of these types of aircraft into a single chapter; so did we. Each type’s development on its own is difficult enough to follow, with its own complexities and fascinations. Aerodynamically, each type posed very different problems. But the broader themes imbedded in the Küchemann quotation that begins this chapter justify the trio combination. Aerodynamics has never been all about airplanes. From the start, it has involved other principal means of mechanical flight. Most notable among these have been the airship (and the balloon before it), the flying boat, and different forms of rotary-wing aircraft, as well as the missile or rocket (not dealt with in this chapter). For all these flight vehicles, the same laws of nature, the same physics, and the same basic aerodynamic principles applied. But each type of vehicle featured its own potentialities for flight, offered its own opportunities for growth and development, and posed its own unique problems of design, fabrication, and operation. This distinctiveness led to the emergence of dedicated specialists devoted to the progress of each type of machine. To a great extent, aerodynamic knowledge translated in all directions between these groups, with each enriching the others with new ideas, findings, theories, inventions, and processes that contributed to the progress of aerodynamics generally. But committed belief in different forms of aircraft also led to social, professional, and economic groupings that competed for attention, missions, resources, passengers, and center stage. The dynamics of these groupings and their interrelationships undoubtedly helped lead to the conformity and lack of vision that Küchemann lamented. The essay and documents to follow deal with the many complexities of historical development related to the aerodynamics of airships, flying boats, and rotary-wing aircraft. In doing so, this chapter should offer at least hints and suggestions about the many issues relevant to determining how to define—and *not* define—aeronautical progress.

Part 1: The Airship

It was not at all clear until well into the 20th century what sort of flying machine, if any, would come to predominate. If bets had been placed, many would have put their money on the steerable airship or “dirigible.” The basic technology for the airship derived from that of the balloon. Hot-air balloons flew 120 years before the Wright brothers’ airplane at Kitty Hawk, North Carolina. The first of these were the *globes aerostatiques* designed by Joseph (1740–99) and Etienne (1745–99) Montgolfier and flown in France in early 1783, six years before the French Revolution. Inspired by their success, the French Academy of Sciences commissioned the chemist J. A. C. Charles (1746–1823) to inflate a balloon with hydrogen. Launched on 27 August 1783 from a military drill field known as Champs de Mars (near the later site of the Eiffel Tower), Charles’s gas balloon floated for 15 miles, landing safely near the village of Gonesse, today a Paris suburb. Excitement about the balloon reached fever pitch in Paris in 1783. On 21 November, the Montgolfiers built a larger balloon that carried two men on board (Jean-François Pilâtre de Rozier and the Marquis d’Arlandes), the first known voyage ever through the air by humankind. A week and a half later, a gas balloon lifted off with its designer, J. A. C. Charles, and his associate Aine Robert, who had devised for Charles the means by which to impregnate silk with liquid latex, thereby creating a gas-tight envelope. Charles’s balloon, which stayed up in the air about 2 hours after lifting off from the Tuileries gardens in Paris, “cast the form of the world’s only practicable aircraft” for the next 70 years, until another French inventor, Henri Giffard (1825–82), developed the dirigible in 1852.¹



FIGURE 5.4. Jean-François Pilâtre de Rozier and the Marquis d’Arlandes made the first human ascent in their Montgolfier balloon in November 1783 from the garden of the Chateau de LaMuet, France. (NASM, Smithsonian Institution [SI 80-2357])

¹ Richard K. Smith, “Aeronautics and the Origins of Its Scientific and Technological Infrastructure, 1492–1899” (unpublished MSS, ca. 1985), p. 9.

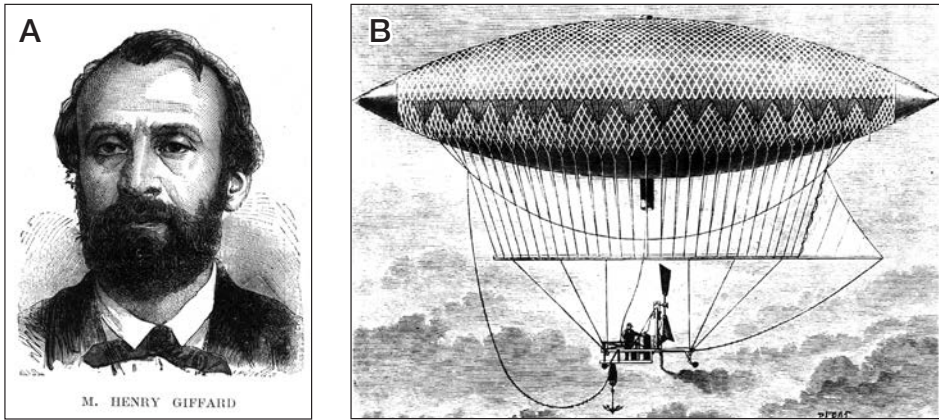

FIGURE 5.5. (A) Henri Giffard was one of many influential French engineers who experimented in aeronautics in the 19th century. (NASM, Smithsonian Institution [SI 73-5534]) (B) Pictured is an engraving of Giffard's 1852 dirigible in flight. (NASM, Smithsonian Institution [SI 73-5535])

Compared with airships, the problem with balloons, as intrepid aeronauts instantly discovered, was that it was virtually impossible to control their direction. Improved aerodynamics offered some fundamental solutions. In place of the big ball, the balloon could be given a more streamlined cylindrical shape. Moveable surfaces could provide directional control; and fins, greater stability. Add to these improvements an air diaphragm or “ballonet” to maintain constant pressure inside the gas envelope and hold it taut, as well as a control car suspended beneath the envelope, and one had the essential elements of the modern nonrigid or “blimp”-type airship. Curiously, it took until after mid-century before all these elements combined into the world's first *ballon dirigeable*, or “steerable” airship. Giffard, its designer, flew the dangerous hydrogen-filled machine a distance of 17 miles from Paris to the village of Trappes on 24 September 1852 at a reported speed of 6 miles per hour in still air. (The ship was dangerous because it incorporated a coke-fired furnace with 88,000 cubic feet of highly flammable hydrogen swaying above the control platform.) Giffard's airship had many serious limitations; in fact, it could not even make the return trip from Trappes to Paris. But more than any other design, it defined the type of flying machine that, along with the balloon, was to play the most practical role in world aviation into the early 20th century.

Even a partial list of the aeronautical achievements of balloons and airships from the late 19th and early 20th centuries should make clear their growing importance. In June 1859, it took American John Wise and two companions only 20 hours to sail in a balloon 802 miles from St. Louis, Missouri, to Henderson, New York. The distance record they set lasted until 1899, when a French balloon broke it flying from Vincennes, France, to Kiev, Russia. John Wise used the publicity surrounding his 1859 feat to sell a number of balloons to the United States War Department. Early in the American Civil War, Union forces in particular made

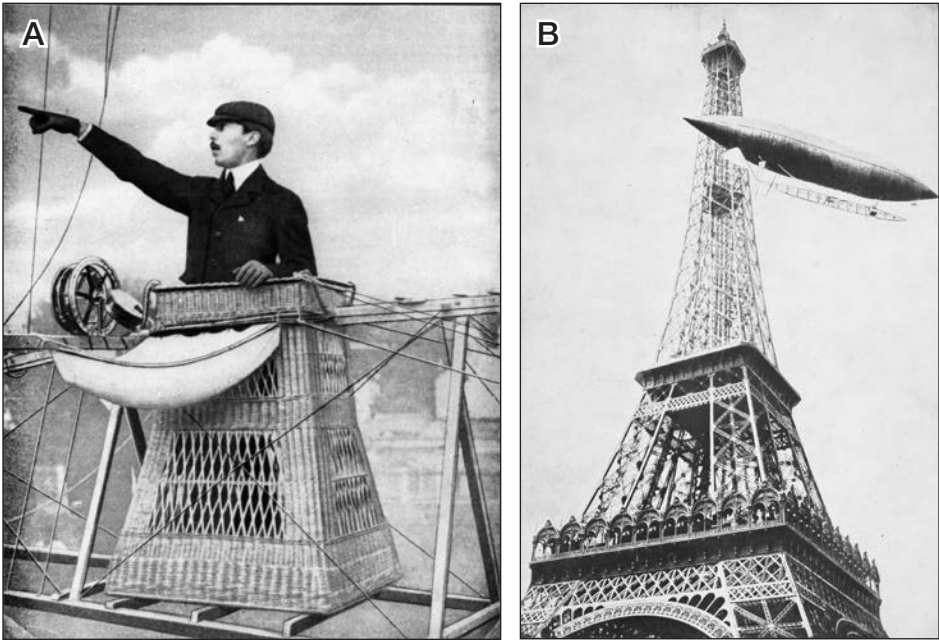

FIGURE 5.6. (A) Alberto Santos-Dumont (1873–1932) pioneered both lighter- and heavier-than-air flight as a wealthy Brazilian expatriate living in turn-of-the-century France. After his sensational airship flights, he made the first powered flight in an airplane in Europe in November 1906 and designed his famous Demoiselle monoplane in 1907. (NASM, Smithsonian Institution [SI 94-5784]) (B) Santos-Dumont successfully rounds the Eiffel Tower in his No. 6 airship during the successful flight that won him the 100,000-franc Deutsch de la Meurthe Prize before thousands of Parisians in 1901. (NASM, Smithsonian Institution [SI 90-3231])

extensive use of balloons for observation and reconnaissance until various technical and logistical problems ended the effort. In 1871, the citizens of Paris employed a virtual armada of balloons during the Franco-Prussian War, lifting 102 passengers, 400 messenger pigeons, and over two tons of letters out of their besieged city. Unfortunately, the balloons could not be flown back into Paris safely, a condition that demonstrated the most serious limitation of the balloon, i.e., that it could not be adequately directed or navigated. This constraint inspired French naval architect Dupuy de Lome (1816–85) to design a rather large airship (106 feet long, 47 feet maximum diameter, and with 11,000 cubic feet of gas), the first to have an air balloonet. Moderately successful, de Lome's airship of 1872 augured a future for aviation soon to be dominated by dirigibles.

As the number of record balloon flights mounted in the last decades of the 19th century, military establishments became more and more intrigued by the idea of using flight vehicles in war. In 1892, the United States Army reintroduced the use of balloons for observation in the field. The following year, the Austrian and Russian armies established balloon services. So promising did balloons and dirigibles appear to be for purposes of war by the end of the century that the first

Hague Peace Conference in 1899 agreed to prohibit the use of projectiles thrown from them for a period of five years. Later in 1899, a Brazilian aeronaut living in Paris, Alberto Santos-Dumont, caused a sensation by flying his first successful airship, a later version of which circled around the Eiffel Tower. The following year, 1900, Count Ferdinand von Zeppelin, a German ex-cavalry officer, started making successful flights with a large airship over Lake Constance. Count Zeppelin went on to build a series of giant airships, five of which made 1,587 flights for a total of 107,213 miles from 1910 to 1913. During this one protracted stretch, zeppelins carried 34,228 passengers without a single injury to any passenger or crewmember.

By the start of World War I, the airship had evolved into two main types: the “rigid” airship, with its skeletal frame structure (or “keel”), and the “nonrigid,” which was devoid of internal structure but made rigid by pressure (thus more accurately named “pressure-rigid” rather than “nonrigid”). It is this type of airship that came to be known as a “blimp.” There was also an intermediate type, the “semi-rigid,” which had a pressure-rigid envelope but a solid keel. Rigid airships played the most dramatic role in the Great War, notably the giant German zeppelins that carried out the first sustained strategic bombing in history. Although nowhere near as devastating as the strategic bombing campaigns carried out by airplanes in World War II, the 220 tons of bombs dropped in the zeppelin strikes against English targets between January 1915 and August 1918 killed 550 people and caused an estimated \$7.5 million in damages (which amounts to more than \$190 million in 2019 dollars). The raids also disturbed wartime production by forcing workers to rush into air raid shelters. Germany’s rigid airships have received most of the attention for this action in the war, but the British navy actually used airships more extensively, including some 200 nonrigid ones involved in antisubmarine patrolling. The United States Navy, as well as the French and Italian armies and navies, also made use of airships during the war, though in far fewer numbers.

Even after World War I, with all the progress made by airplanes in terms of technology and combat roles, it was not clear to even the shrewdest observer of aviation which type of flying machine would win out over the other, the airplane or the airship. Into the 1920s, airplanes were still relatively slow and small—an aerodynamicist who favored airships over airplanes even went to the bother of “proving” that airplanes larger than those of the day could never be built. Advocates of what had come to be known as “lighter than air” (LTA) believed that airships had enormous unproven capabilities. They were not much slower and could carry many more passengers in far greater comfort than airplanes, most of which still had open cockpits; they were much more forgiving than airplanes during instrument flight; and with their extreme range and low operating cost, they could be used not just as military weapons, but also for the transportation of heavy commercial and industrial loads.

Postwar aviation featured “Atlantic fever,” with a number of pilots and aircraft trying ocean crossings. Many of the headlines were grabbed by airships, as when,



FIGURE 5.7. The U.S. Navy's airships performed a dual role of scouting for the fleet and bringing naval aviation to the American public in the 1920s. On a publicity tour to the American Midwest, the Shenandoah, seen here cruising over the Capitol, crashed during a violent Ohio thunderstorm in September 1925. (NASM, Smithsonian Institution [SI 99-41014])

in July 1919, the British sent their large dirigible, the R-34, across the Atlantic. Its flight was not just the first transatlantic crossing by an airship; it was also the first east-to-west crossing by any aircraft and the first double crossing (to Canada and back).

Airship research and development (R&D) accelerated at least as quickly as did airplane R&D after World War I. In November 1921, the Army's first airship, the *Roma*, made its first flight, which was from Langley Field, Virginia. That same year, the National Advisory Committee for Aeronautics (NACA) urged increased funding for the U.S. Navy's airship program, which was being designed in particular to serve the Pacific fleet in a reconnaissance network canvassing many thousands of miles. Throughout the 1920s, the Navy's Bureau of Aeronautics, under Admiral William A. Moffett, showed an intense interest in airship development. From 1921 to 1923, the Navy built the airship U.S.S. Shenandoah (ZR-1, the first of the zeppelin type to use helium gas), manufacturing its parts at the Naval Aircraft Factory in Philadelphia and erecting the airship in the big hangar at the naval air station at Lakehurst, New Jersey. In 1924, the Navy received what became the airship U.S.S. Los Angeles from Germany and prepared specifications for what became the

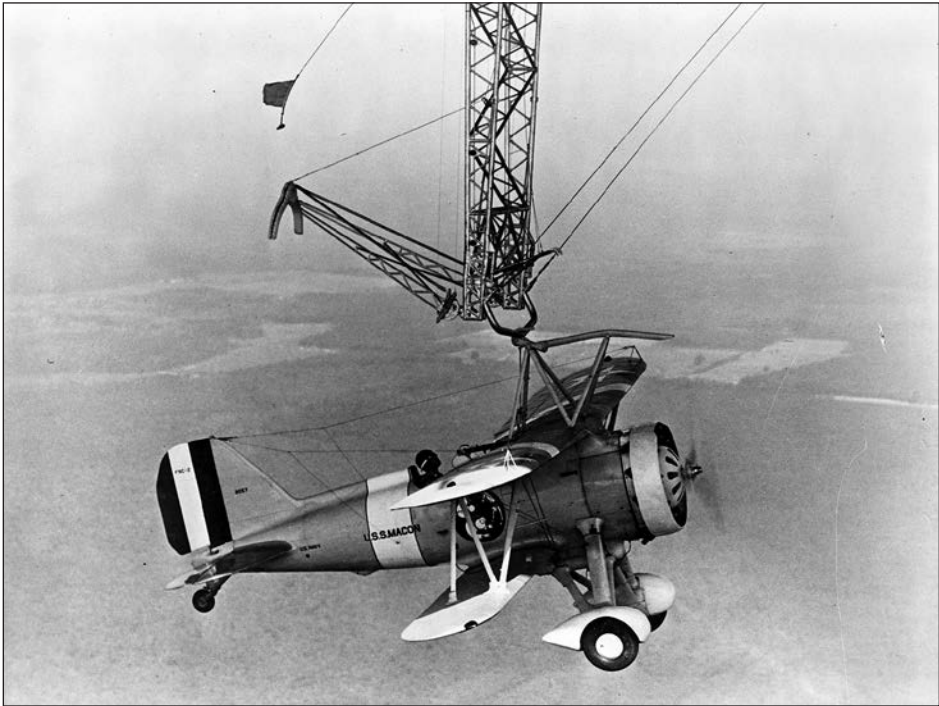

FIGURE 5.8. The U.S.S. Macon was a flying aircraft carrier that relied upon small Curtiss F9C-2 Sparrowhawk fighter aircraft capable of extending its scouting capability with the fleet. The Sparrowhawks hooked onto the Macon's trapeze-and-hoist arrangement and could be brought inside the airship's internal hangar. (U.S. Navy via NASM, Smithsonian Institution [NASM A-42334])

airships U.S.S. Akron and Macon. The Los Angeles flew for eight years, until it was decommissioned in 1932, with a record of over 5,000 hours in the air. The Navy's other airships did not fare so well. In September 1925, the Shenandoah crashed in an Ohio thunderstorm, killing 14 of the 43 people on board. In April 1933, the Akron went down at sea in a storm off the coast of New Jersey, killing most of its crew (73 men, specifically), including the architect of U.S. naval aviation himself, Admiral Moffett. Less than a year later, in February 1934, sister ship Macon crashed at sea in a storm off California. This disaster broke the camel's back. The Navy's use of giant rigid dirigibles came to an end.

But in the public mind of the 1930s, no matter how many military airship disasters occurred (we have not mentioned the crash of British R.101 in 1930, killing 47 of 54 on board, which resulted in the British terminating their dirigible activity), nothing could totally undermine popular enthusiasm for the great zeppelins, especially the huge and luxurious passenger airships operated by Germany. In August 1929, one of these monumental German rigid airships, Graf Zeppelin, captured headlines by flying around the world in just 22 days. Two years later, in June 1931, the same big airship carried an international team of 12 scientists on a



FIGURE 5.9. Named in honor of Count von Zeppelin, the Graf Zeppelin traveled over a million miles in 590 flights without an accident. To many, it represented the future of high-class, long-distance travel for its small complement of 20 passengers. It is seen here with the equally gargantuan Dornier Do-X flying boat on the Bodensee between Germany and Switzerland. (NASM, Smithsonian Institution [SI 85-19411])

highly publicized expedition to the Arctic. In a routine operation, Graf Zeppelin I and II, along with their sister ship, the Hindenburg, the largest dirigible ever built, shuttled high-paying passengers between Germany and South America. As readers will see in Document 5-8 below, even an aerodynamicist as advanced as Theodore von Kármán viewed “the handsome gas-filled bags of the skies” as “one of the great products of early aeronautical engineering.” He “believed in them.” He thought they were “graceful and practical exhibitions of what man could do in the way of comfortable long-distance transport.” From a technical point of view, he considered them “highly efficient vehicles” and felt that they were “unnecessarily losing out to the airplane, which was faster but not as efficient or as comfortable for long journeys.”

Of course, von Kármán and all other believers in airship travel were thankful that they were not aboard the Hindenburg on 6 May 1937, when it exploded in a fireball as it was approaching the mooring mast at Lakehurst, New Jersey. For all practical purposes, the Hindenburg disaster ended the age of the airship, despite the capabilities that this type of vehicle might still have offered. By the time this tragedy occurred, however, the airplane had evolved into a tremendously more practical vehicle than it had been 20 years earlier, having undergone its total “reinvention” as a result of the airplane design revolution of the 1920s and 1930s. If that reinvention had not taken place, it would surely have been far harder for the

aviation world to throw in the towel on the rigid airship. (See Document 5-11 for reflections about this matter.) Flight, after all, had achieved a prominent place in modern society, not just as a transportation system but as a glorious symbol—perhaps *the* symbol—of human progress. It was just a question of what form of flight was going to fulfill that promise the best. By the start of World War II, it was clear that that form would not be the airship.

As we will see in the first parcel of documents below, the development of airships in the early 20th century contributed in many significant ways to the progress of aerodynamics generally, as did the airplane-airship competition itself. Airship design leaned more heavily on aerodynamic theory than did airplane design because a much lesser number and variety of airships had been built, so there was less empirical knowledge of airships. Larger and more expensive than airplanes, completed airship structures could not be modified for experimental variations as readily; hence, flight testing was extremely limited. At the same time, wind tunnel tests of airships proved less persuasive than those of airplanes because of the relatively greater difficulties caused by scale effects.²

One thing that should be clear from some of the documents below is that attention to airships, such as that paid by NACA researchers in the 1920s and 1930s, stimulated some productive crossflows between airship aerodynamics and airplane aerodynamics. These exchanges took place in ordinary ways, such as when NACA engineers in the mid-1920s designed experimental nacelle shapes for airplane engines by starting with the best airship shape available. They also occurred in some rather extraordinary ways, as readers may gather from Document 5-9, a chapter on the aerodynamics of airships written by former NACA researcher Dr. Max M. Munk for William F. Durand's 1936 six-volume *Aerodynamic Theory*. In this chapter, Munk predicts that "since airship design draws on the whole domain of aerodynamics and since special airship aerodynamics should contain as its most notable problem the full analysis of airship drag, it seems quite possible that from airship theory may some day come forward such fundamental progress as shall revolutionize our technique of air travel." In an important way, Munk's intuition proved correct: airship theory became extremely valuable when aerodynamicists began to extend airfoil theory to the near-sonic and supersonic speed ranges. Most notably, in 1945, NACA researcher Robert T. Jones, a student of Munk's at Catholic University in Washington, DC, in the early 1930s, used as the basis for a new slender-wing theory a linearization formulated by Munk in 1925 for approximating the forces acting on airship hulls. Jones's approximation avoided severe mathematical difficulties in determining the lift distribution of wings—difficulties involving, among other things, the solution of an equation containing a double integral. Near

² On the Akron crash and an assessment of Admiral William A. Moffett's career promoting airships and naval aviation generally, see William F. Trimble, *Admiral William A. Moffett, Architect of Naval Aviation* (Washington, DC, and London: Smithsonian Institution Press, 1994).

the end of World War II, Jones recognized the indirect value of such a theory for the design of delta (i.e., triangular) and swept wings; soon after the NACA's publication of Jones's theory, so did many others.

Instances of dramatic transfer from airship theory to airplane theory were rare, naturally. The mainstay of aerodynamic research as it related to airships in the first decades of the 20th century concerned ways of reducing the drag of the vehicle—notably skin friction drag (i.e., the viscous drag over the outer skin of the airship) and the form drag (i.e., the drag acting upon the airship ascribed to its overall form). This was the focus, certainly, at the special Airship Institute established in the early 1930s with Guggenheim money at Goodyear-Zeppelin in Akron, Ohio, the company responsible for virtually all research on zeppelin behavior and design in the United States. The first official project at the new institute was to investigate the nature of wind forces on an airship in flight. The drag brought on by atmospheric turbulence and the kind of storms that all too frequently had destroyed airships needed urgent attention. Consulting for Goodyear-Zeppelin, von Kármán delved deeper into the anatomy of turbulence than anyone had ever done before. As readers will see in the previously mentioned Document 5-8, von Kármán thought in terms of “thick turbulent air masses that cling to the airship and cause skin friction.” Although wind tunnel tests were run at the Airship Institute, von Kármán arranged for slow-motion pictures to be taken as clouds passed over Pikes Peak in Colorado. In his view, this simulation demonstrated “the creation of turbulence on the grand scale” and suggested that the vortices created around the mountaintop were similar to those forming around an airship in flight. Unfortunately, the results of this investigation came too late to save the ill-fated Akron and Macon. What the research program did help advance was greater attention to the science of meteorology, not just for airship travel but for aviation generally.

Research into LTA came to an abrupt halt in most places after the Hindenburg disaster. The NACA, which had been extremely active in airship research prior to 1937, understood that further advocacy of comprehensive LTA flight studies was politically foolish. At Langley Memorial Aeronautical Laboratory, researchers did use airship models for a brief time in association with a wind tunnel program designed to explore improving the drag and propulsive efficiency of aircraft through boundary-layer control. But after this work was completed in 1938, NACA Langley carried out no more research relating to airships. Researchers who had specialized in LTA studies quickly translated their skills and experience to the study of airplanes. This translation happened rather easily because those who had been most involved in airship research had been forced by the pressures of the busy NACA agenda to remain active all the while in more general aerodynamic testing.

Rigid airships mostly went the way of the dinosaur following the Hindenburg, but nonrigids continued to be built and utilized. In World War II, the United States Navy operated a “blimp squadron,” the only service in the global conflict to do so. (In June 1942, Congress authorized construction of 200 nonrigid airships

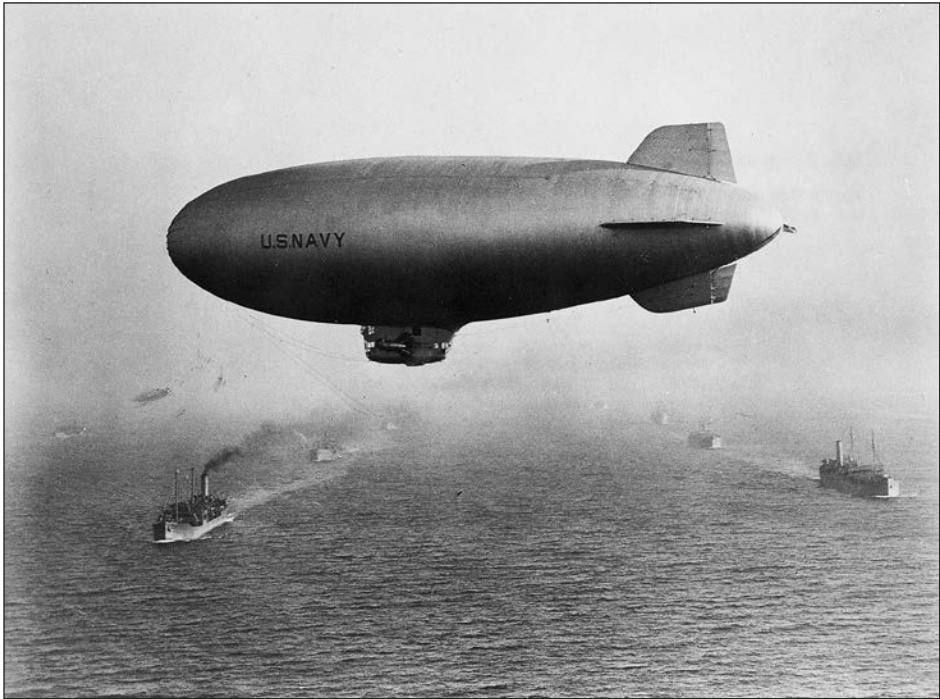

FIGURE 5.10. After the loss of the Akron and Macon, the K-type nonrigid airship, or blimp, became the United States Navy's main lighter-than-air craft. During World War II, K-ships conducted antisubmarine patrols, search-and-rescue missions, convoy escort, reconnaissance, and scout patrols. Unlike heavier-than-air aircraft, the Navy blimps could stay aloft for 60 hours. The Navy suspended the use of airships in 1962. (NASM, Smithsonian Institution [SI- A-4252])

for patrol, convoy, search-and-rescue, and mine-clearing duties.) Serving over the Atlantic and Pacific oceans as well as the Mediterranean Sea, the Navy airships patrolled an area of over three million square miles. Astonishingly, of the 89,000 surface vessels escorted by blimps during the war, not a single one was lost to enemy action. And only one airship was shot down, but not before it damaged the German U-boat involved so badly it could not submerge; the sub was later sunk by British bombers in the North Sea. The United States Navy continued to use airships for various purposes into the mid-1960s. The service looked into reviving the airship in the 1980s, but Congress cut funding for the project in 1989.

Although it became something of an oddity in the last half of the century, modern airships—a few of them rigids—served a number of utilitarian functions. Besides aerial advertising and television coverage of sporting events and parades, they were used in maritime surveillance, geological and hydrographic surveys, border patrol and law enforcement, pollution monitoring, oceanographic and wildlife research, and photographic mapping. For all of these purposes and more, airships, with their hover capability, stable cabin environment, fuel efficiency, high payload

volume, endurance, low vibration and noise, and panoramic viewing, often proved more effective than small airplanes and helicopters—though operating costs could be restrictively high.

One of the most popular books enjoyed by aeronautical enthusiasts in the past 30 years was John McPhee's *The Deltoid Pumpkin Seed* (1973). This little book told the story of an experimental deltoid-shaped, hybrid airplane/dirigible developed in the 1960s by an unusual band of engineers and investors making up the Aereon Corporation, based in Princeton, New Jersey. The Aereon airship promised to be a safe workhorse of the skies, capable of carrying the payload of entire freight trains with minimal cost. But despite the perseverance of its inventors, not much came of it other than its ability to attract the many thousands of readers of McPhee's book.

But many other LTA concepts emerged, especially as economic and environmental issues became prominent in the 1970s and 1980s. LTA advocates at the end of the century pointed out that an airship could fly all day using no more fuel than a Boeing 747 consumes just taxiing to the runway. And an airship did so with much less noise and air pollution. In the year 2000, over 20 companies around the world were manufacturing airships with another dozen firms in the design and construction phase. One of their primary goals was to make transporting certain types of bulk cargo more economical, especially over wilderness, desert, tundra, and arctic regions. In the view of today's LTA enthusiasts, airships of the future, with the help of advanced Space Age technologies, may once again become one of the safest and most effective methods of air transportation. If this proves to be the case, engineers and scientists will again be paying serious attention to the aerodynamic problems inherent in airship design and operation. Documents 5-1 through 5-10 concern the aerodynamics of airships as this subject came to be understood in the critical period before 1940. Document 5-11 presents a perspective from famous zeppelin pilot and transatlantic airship pioneer Dr. Hugo Eckener from 1949 on how and why the airplane emerged as such a clear winner over the airship by the end of World War II, and Document 5-12 reproduces illustrative content from a few of the many Web sites devoted to the current and future use of airships. Reading through this material, one will be reminded of what American writer Douglas Robinson, one of the greatest experts on airship history, wrote in 1973:

Nonetheless, it is still a corollary of the immutable laws of physics that one cubic meter of helium will support 68 pounds in the air, while the power to move the load carried *aerostatically* is far less than that required both to move and to sustain in the air a similar load *aerodynamically*. While initial costs may be high (they are high also for jet aircraft), the airship will always be the cheapest, though not the fastest, way to move cargo by air.³

³ Douglas H. Robinson, *Giants in the Sky: A History of the Rigid Airship* (Seattle: University of Washington Press, 1973), pp. 324–325.



FIGURE 5.11. The Goodyear Enterprise and other blimps persist today primarily as vehicles for advertising. (Hans Groenhoff Collection, NASM, Smithsonian Institution [HGD-114-35])

Robinson continued: “All kinds of technological advances made in the last twenty years for the benefit of the aeroplane would benefit the airship also.” (In this context, Robinson specifically mentioned the turboprop, modern instruments, radios, and electronic navigation aids; if written a bit later, his list would also have included the computer. Obviously, the most revolutionary new technologies changing the nature of flight after 1945, the jet engine and the rocket, were not applicable to the airship.) Some of the major problems that had plagued airship operation in the early days, such as ground handling, had been “largely solved years ago by the United States Navy.” In sum, “The obstacles are not technical, they are psychological and financial; and if attitudes change and the money is forthcoming, we may still some day see again the giants in the sky which thrilled and enthralled our parents with their awesome size and majesty.”⁴

Part 2: The Flying Boat

Another kind of giant in the sky that enthralled the public prior to 1945—and that also mostly went the way of the dodo bird afterward—was the flying boat. Unlike the airship, the flying boat did not compete so directly with the airplane but rather complimented it by carrying goods and passengers over watery distances

⁴ Ibid.

and to places where there were no runways for planes to land. Technically, the flying boat was an airplane; it certainly flew aerodynamically rather than aerostatically as airships did. It was also a “seaplane,” but not just one mounted on floats or pontoons in place of conventional landing gear, as the simpler form of seaplane would be outfitted. No, the flying boat was its own distinct and extraordinary form of aircraft, one with a genuine boatlike main central body or hull that allowed the plane structure itself to float, take off, and alight on water.

The design of a flying boat posed many special problems inherent to its amphibious nature. First of all, the vehicle had to be buoyant and have an effective displacement so that it performed effectively in the water as a true boat. It had to be maneuverable and stable as well as structurally strong and seaworthy. Its hydrodynamic drag or resistance through the water could not be too high. When picking up speed for liftoff, the hull could not spray too much water out and up, striking the rest of the structure. Not only would this spray make it hard for the pilot to see through his windshield, but it would adversely affect control surfaces and the aerodynamic lift required for takeoff. Spray ingestion also endangered the performance of the propellers and their motors. As we will see in the documents that follow, it took some advanced knowledge of naval architecture to configure and integrate all the critical design details of a flying-boat hull effectively.

And that was only half of the problem, if that much. As with any amphibian, the actual transition from one form of existence to another required very special abilities of metamorphosis. Before the boat could lift off and take its form as an airplane, it had to overcome not only the water drag associated with the hull but the aerodynamic drag as well. It had to reach what came to be called “hump speed,” the velocity during its takeoff run at which the water resistance was at its maximum. Somehow, through the design of an effective hull, the high drag associated with the flying boat’s passage through the hump had to be managed. Otherwise, it remained a boat, incapable of “getaway speed,” the point at which the entire weight of the vehicle would be carried by its wings. This was the major challenge: at exactly the same instant that the most severe hydrodynamic resistance was being encountered, effective aerodynamic performance had to kick into gear. This was not easy, given that the size and shape of the hull, no matter how well designed, compromised the vehicle’s aerodynamic performance. Dynamic lift was never as high, and aerodynamic drag never as low, as for a comparable landplane. All in all, the design of an effective flying boat proved to be an extraordinarily complicated challenge. But it was one that aeronautical engineers tackled rather successfully, not just in the United States but all around the world, in the golden age of aviation prior to 1945.

No doubt much of the enthusiasm for flying boats—and all other kinds of seaplanes, for that matter—rested on what many of the earliest aviation pioneers recognized to be strong affinities between air and water. In the 18th and 19th centuries, fluid mechanics emerged as a modern scientific discipline largely based on the study of water, which was, after all, the most familiar fluid to humans in

terms of the objects they built for movement and transportation. Many of the basic principles that became essential to the science of aerodynamics actually came out of the science of water in motion. Daniel Bernoulli's famous theorem of the 1700s, which turned into one of the most fundamental laws in aerodynamics, dealt with the medium of water. Though perhaps best known today for laws related to aerodynamics, what Bernoulli and fellow Swiss mathematician Leonhard Euler did was lay the foundations of hydrodynamics. Later on, early aerodynamicists seeking to extrapolate experimental data from scale models to the performance of full-scale flying machines borrowed a technique from English engineer and naval architect William Froude (1810–79), who influenced ship design by developing a method of studying scale models propelled through water and applying the information to full-sized ships. Many later experimenters moved back and forth freely between hydrodynamic and aerodynamic analysis. By the 1920s, Sir Horace Lamb, author of *Hydrodynamics* (1895), for many years the standard work on that subject, was making valuable studies of airflow over aircraft surfaces. The same was true for German physicist Ludwig Prandtl, who many rightfully consider one of the fathers of aerodynamics. But Prandtl's seminal 1904 paper, in which he introduced the concept of the "boundary layer," specifically concerned hydrodynamic flows. From Prandtl's time on, the flow of air became of just as much interest to physicists and engineers as the flow of water, and hydrodynamics evolved into a specialized branch of a broader field known as "fluid mechanics." No one understood the "Applications of Modern Hydrodynamics to Aeronautics" better than Prandtl did. This was in fact the title of one of his most classic essays, which the NACA translated and published as Technical Report 116 in 1921 (see Document 5-17). So, to the considerable extent that the pioneers of aircraft design sought to build aircraft that could fly *over* water, *from* water, and, via hydroplanes, hydrofoils and air-cushion vehicles, even *in* water, one should not be at all surprised, given the many close and inherent relationships between the dynamics involved.

To wit, a number of the early aeronautical experimenters chose to work *over* water. Leonardo da Vinci recommended it in his notebooks: "You should carry a long wineskin as a girdle, so that in case you fall you will not be drowned." Three hundred years later, in the 1890s, French-born aeronautical experimenter Louis Mouillard advised that piloted test flights should be made over a lake; so too did Australian pioneer Lawrence Hargrave, the inventor of the box kite. As described in chapter 1, Samuel P. Langley successfully flew his steam-powered models from atop a houseboat on the Potomac River and tried to do the same with his crewed Aerodrome of 1903. After extensively modifying it, Glenn Curtiss fitted Langley's inept machine with floats and flew it in 1914 over Lake Keuka near Hammondsport, New York. These were only a few of the dozens of instances in which aeronautical experimenters chose to fly over water, primarily for safety reasons. Whereas da Vinci, Mouillard, and Langley recommended flying *over* water, Hargrave called for flying *from* water, requiring the design of some form of seaplane. Some historians

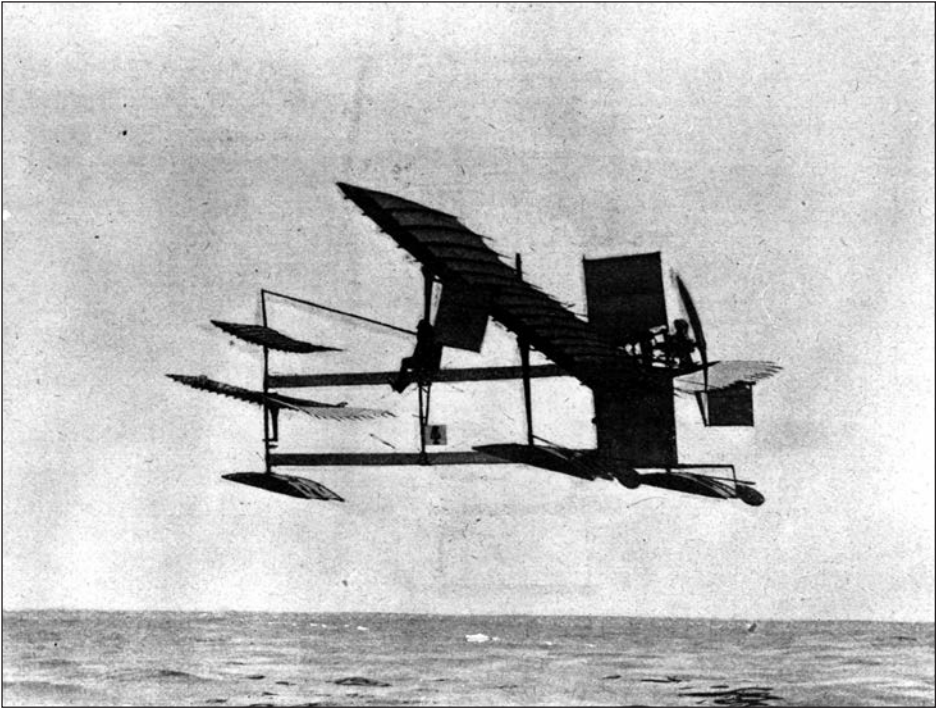

FIGURE 5.12. Pictured is the first seaplane: the Hydroaéronautique No. 1 in flight over Lake Berre near Martigues on the Mediterranean in March 1910. (NASM, Smithsonian Institution [SI A-1172-C])

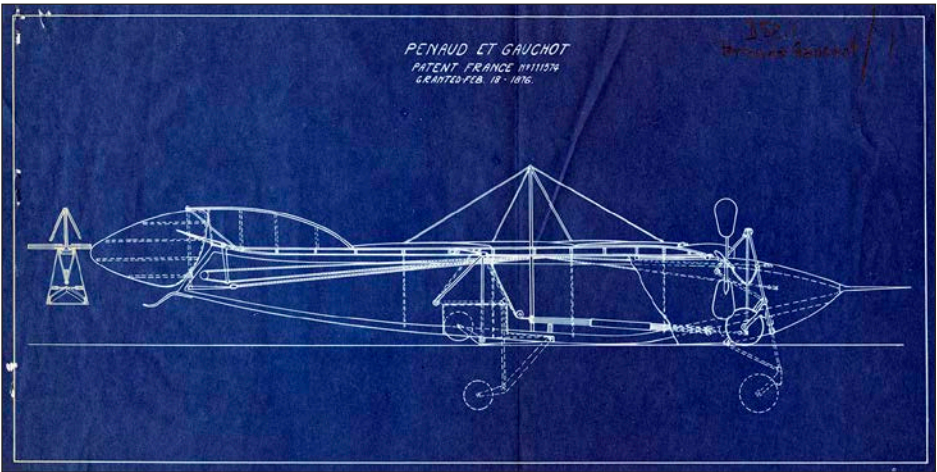

FIGURE 5.13. Alphonse Pénaud and mechanic Paul Gauchot patented their amphibious design in 1876. It would not be until the early 1920s that true amphibians would take to the air in the form of Grover Loening's designs, used by the United States Army and Navy, as well as civilian operators. (NASM, Smithsonian Institution [SI 92-15366])

have suggested that the world's first authentic seaplane flew in France in 1910, at Lake Berre near Marseilles. Built by an engineer who specialized in hydrodynamics, Henri Fabre (not to be confused with the famous 19th-century entomologist of the same name), the vehicle was a floatplane rather than a flying boat, one whose best flight spanned some 4 miles at an altitude of about 150 feet, after which it made a good landing. Aerodynamically, Fabre's machine was interesting because its floats—three of them, shaped flat on the bottom and curved on the top and placed similarly (one at the forward end and two after) to an arrangement tested by Froude in a water tank in the early 1870s—served also as airfoils, providing additional lift. The floats could be adjusted in the air not just for lift, but to form an optimum contact angle with the water for landing. The latter aided a pilot in adjusting for sea waves of different sizes.

As significant as Fabre's float plane was, it had predecessors. In 1876, Alphonse Pénaud patented a true amphibian having a central hull, lateral wingtip floats, and retractable wheels. In 1897, Edson Gallaudet experimented with twin-float gliders. Six years later, in early 1903, Octave Chanute wrote the Wright brothers that he had recently seen in Vienna, Austria, a water-borne aircraft that in his opinion was capable of flight if its engine just did not weigh so much. Chanute called this machine, built by Austrian inventor Wilhelm Kress, a "flying boat," one of the first known uses of the label.⁵ The first crewed flight from water took place in June 1905 on the Seine River near Paris as Gabriel Voisin's twin float-mounted glider (a Hargrave box-kite design) lifted off from behind a racing motorboat. One of Voisin's flights spanned 600 meters, or 1,968 feet. These were not the only efforts to fly from water prior to Fabre. As readers will see in Document 5-13, even the Wright brothers, during 1907, engaged the problem of flying an airplane off water. On the Miami River in Dayton, Ohio, they tried out not only floats but hydrofoils, a structure similar to an airfoil designed to act in water.

But no one in Europe or America pursued the design of seaplanes more aggressively than did American Glenn H. Curtiss. He concentrated his efforts to sell his water-based machines to the United States Navy since the Wrights dominated the market for land-based aircraft with the U.S. Army. Curtiss was already a famous aviator. On 4 July 1908, Curtiss achieved his first great fame by making the country's first official public flight of more than 1 mile. He did this in a landplane, the June Bug, an aircraft fitted with wingtip ailerons, the design feature that brought the lawsuit by the Wrights for the infringement of their patent. But Curtiss quickly remodeled the June Bug and mounted it with pontoons; and by early 1909, he was test-flying it upon Lake Keuka in New York. The machine, now known as the Loon, possessed many of the basic features that were to become standard in a flying boat.

⁵ Quoted in H. F. King, *Aeromarine Origins: The Beginnings of Marine Aircraft, Winged Hulls, Air-Cushion and Air-Lubricated Craft, Planing Boats and Hydrofoils* (London: Putnam, 1966), p. 14.

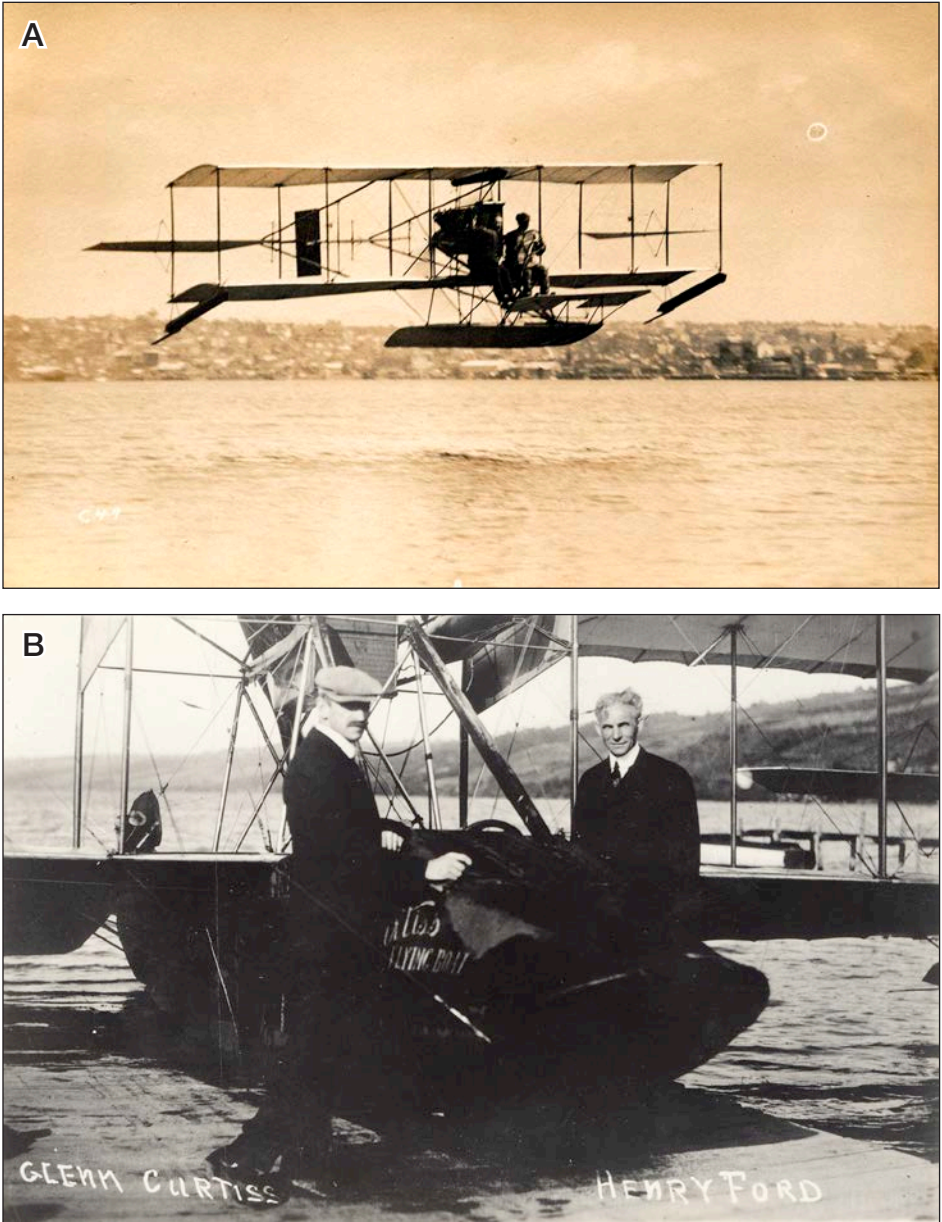

FIGURE 5.14. (A) Curtiss capitalized on his work with the Loon and his observation of French advances with the more practical Hydro, which made its first flights in San Diego in January 1911. (NASM, Smithsonian Institution [NASM 7A10527]) (B) Curtiss quickly moved toward the development of flying boats. Here he is with Henry Ford (right) in front of the refined Model F flying boat in 1913. By the end of the early flight period, Curtiss was the leading flying-boat manufacturer in the United States, with a substantial amount of experience in design and operation. (NASM, Smithsonian Institution [SI 90-8391])

Before he could win contracts from the U.S. Navy to build seaplanes, Curtiss had to prove he could get his designs out of the water, something the primitive Loon was never quite able to do. In the late summer of 1909, after months of experimenting with different hydroplane hulls, Curtiss visited France for the purpose of competing in what was to be the world's first great air meet. At this event, held at Rheims, Curtiss won the prize for reaching the highest speed, 43.38 miles per hour. His aircraft was not a seaplane, though. Still, his trip to France proved decisive for what his seaplanes would become. Seeing Henri Fabre's seaplane in Paris, Curtiss sought out its designer and learned as much as he could not just about float design, but about hydrodynamics generally.

Returning to the United States, Curtiss designed his first effective seaplane, the Hydro, which made its maiden flight in January 1911. (That same month, Curtiss staged the first takeoff and landing from an American naval vessel, with pilot Eugene Ely, in a Curtiss Albany Flyer, landing on a makeshift platform on the U.S.S. Pennsylvania, moored at San Francisco Bay.)⁶ He completed his first truly practical flying boat, known as Model E, later that year. This vehicle possessed a tail carried on thin outrigger frames leading from the hull. The tails on Curtiss's later boats, including the Model H America of 1912, would be mounted directly on the hull. Unknown to Curtiss at the time was that another design, the French Donnet-Lévêque flying boat of 1912, also had its tail mounted directly on the hull. Whichever of the two designs deserves priority, the point is that this became one of the classic features of subsequent flying boat design, though a number of early flying boats—including the Curtiss NC-4, which was the first to cross the Atlantic in 1919—perpetuated the outrigger form. It was his 1912 flying boat America that Curtiss originally planned to be the first to fly across the Atlantic—with him in it—and thereby grab a £10,000 prize being offered by London's *Daily Mail* newspaper for the first across. He did not make that flight, as World War I intervened. But his 1912 flying boat design became the standard for an entire generation of single and multiengine flying boats used by the United States and Great Britain during World War I.

Virtually all of what became the basic design features of a flying boat materialized in the Curtiss flying boats of World War I. One can see these features clearly in Curtiss's twin-engine H-16, a number of which saw action in antisubmarine patrol over the coastal waters off France, not just for the United States Navy but with the British Royal Navy Air Service (RNAS) as well. (The RNAS operated a number of flying boats derived from Curtiss designs, designated "F-1" through "F-5." The ones with an "L" designation, e.g., the F-5L [which arrived in Europe too late to see combat] incorporated the American-made 400-horsepower Liberty engine. The Curtiss company built many of the "F" series boats for the British Navy.)

⁶ Tom D. Crouch, *The Bishop's Boys: A Life of Wilbur and Orville Wright* (New York and London: W. W. Norton & Company, 1989), p. 457.

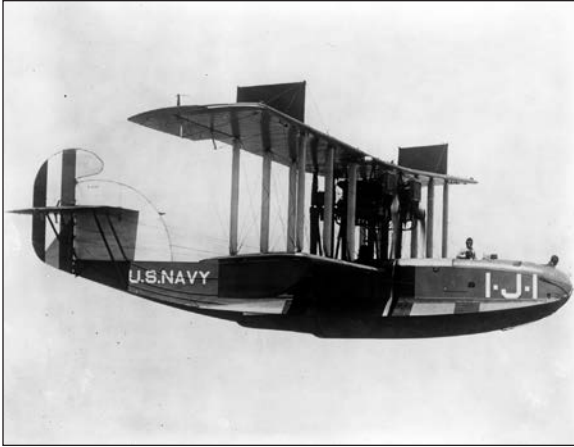

FIGURE 5.15. This Curtiss F-5L, flying with Navy Utility Squadron One in the early 1920s, exhibits the innovative flying boat design features—two-step hull, high-mounted wings and tail, and tip floats—introduced in the H-16. (Shell Companies Foundation, Inc., NASM, Smithsonian Institution [NASM 00044446])

wing. Curtiss realized that any relatively narrow-beamed hull with such a high center of gravity (caused by the aircraft superstructure) needed floats to overcome what naval architects called “negative metacentric height.”⁷ This is what caused a boat to become laterally unstable while moving through water. In smooth water, a flying boat could motor through liftoff without experiencing much lateral instability, and neither float at the tips of the wings would need to touch water. But military patrol boats like the H-16 spent many days in rough seas, and on those occasions, floats stopped the accelerating amphibian from tipping over on its side. (Later, some flying-boat designers used “sponsons” for lateral stability; these were short and stubby little wings that projected from the bottom of the hull on each side.)

The hull of the H-16 also proved prototypical. Curtiss’s designers gave it as wide a beam as possible, making for a rather voluminous hull. This ensured sufficient buoyancy for the hull to support up to twice the design weight of the total vehicle—a safety feature to stop the boat from sinking when taking on water in rough seas. The front of the hull had a shallow V-shaped bottom. Naval architects called the outside angle of this vee the “deadrise.” The deadrise angle is the vertical distance between the keel, i.e., the main structural member running along the center bottom of the hull, and the chine. (Obviously, the design of flying boats required distinctive terminology, most of it borrowed directly from naval architecture.) The chine is the corner or edge where the bottom of the hull joined the

A large (nearly 11,000-pound) biplane, the H-16’s entire wing assembly was mounted atop the hull. Also high above the hull was a horizontal tail, which was fitted upon a long vertical fin that itself extended well above the hull from the rear of the fuselage. All of this was done to keep the aerodynamic surfaces—not to mention the two engines mounted between the wings—out of the water spray during takeoff. Very importantly, what came to be known as “tip floats” were placed atop the upper wing and beneath the lower

⁷ Lawrence K. Loftin, Jr., *Quest for Performance: The Evolution of Modern Aircraft* (Washington, DC: NASA SP-468, 1985), p. 172.

side or deck. It was vital for the designer to set this deadrise angle effectively. If the angle was too small, impact loads on the hull could prove destructive in heavy seas. If the angle was too great, friction drag on the forward part of the hull would be unacceptably high. Designers had to pay careful attention also to the angles formed by the chines, as it was a geometry crucial to determining the hull's spray characteristics.

Another key feature of the Curtiss H-16 was its step. This was another feature that became basic to flying-boat design. A step is an abrupt break or jog in the bottom of the hull—a transverse section that separated the bottom of the hull into a forebody and an afterbody. In essence, it was the step that placed the bottom of that part of the body aft of the step at a higher level than the bottom of that part forward of the step. The step helped to diminish hydrodynamic resistance, lessen water suction effects, and improve control over the boat's longitudinal attitude and, thus, pitch control.

But the step's main purpose, as Curtiss and others came to realize it, lay in helping the boat lift off. Taxiing through the water into takeoff mode, a flying boat floated upon its forebody and afterbody roughly equally, with both parts of the hull supporting the structure after the fashion of what naval builders called a "displacement boat." As the machine achieved hump speed, however, the afterbody rose out of the water and the hull planed on the forebody alone. Without the hydrodynamic flow breaking away from the afterbody, the airplane simply could not get off the water; hydrodynamically, what the transverse step performed was an action akin to what a spoiler does aerodynamically on an airplane wing. Just as a spoiler projects into an airstream about a wing to break up or "spoil" the smoothness of the flow, the step caused the hydrodynamic flow to break away from the afterbody. It was this separation that allowed the boat to transition into the planing regime required for takeoff. Curtiss's flying boats of World War I introduced this innovative feature so crucial to the success of all later flying boats. The hull of the H-16 possessed a single transverse step; some other flying boats would later incorporate two.

It would take many years of R&D before this or any other basic feature of a flying boat would be optimized. The same process of reinvention that fundamentally altered the character of the airplane from its clumsy, strut-and-wire wooden biplane form during the World War I era to the highly streamlined and efficient metal monoplane of World War II also brought major progress to the flying boat. Never would it become as aerodynamically "clean" as a comparable landplane, for there was no way around some of the drag caused by the hull. But, as evidenced in the documents that follow, there can be no question that the design revolution of the 1920s and 1930s significantly improved the overall efficiency of the flying boat, increasing its speed and, above all, its range.

The great flying "Clipper Ships" built by Boeing and by Martin starting in the mid-1930s were as different from the Curtiss H-16 as the Douglas DC-3 was from the Curtiss Jenny. So, too, would be the versatile Consolidated PBY Catalina and



FIGURE 5.16. The “modern” flying boats from Boeing and Martin made Pan American Airways’ transoceanic routes possible in the 1930s. The Martin 130 China Clipper inaugurated transpacific mail and passenger service from San Francisco to Manila in November 1935. (NASM, Smithsonian Institution [SI 88-17652])

Coronado and Martin PBM Mariner patrol boats used so extensively by the Navy in World War II. Most of these mature flying boats included the same innovative technology, such as radial air-cooled engines, streamlined nacelles, optimum wing-mounted engine locations, variable-pitch propellers, wing flaps, cantilever wings, advanced NACA airfoils, and all-metal (or mostly metal) construction. If not for the simultaneous development of reliable large, multi-engine, long-distance land-plane transports, plus a large number of airports with long, hard-surface runways to service them—both developments related to military requirements and the fighting of a global war—the age of the great flying boat might have lasted longer than it did.

As it was, that age essentially ended when Pan American Airways, a company whose reputation was first established by sending luxury flying boats on long over-water routes to places like Rio de Janeiro, Hawaii, the Philippines, and China, terminated its flying-boat operations in April 1946. The Navy and the United States Coast Guard continued to employ a few flying boats for reconnaissance, antisubmarine patrol, and search-and-rescue missions after 1945, and a few commercial operators used them to fly tourists and packages from island to nearby island, for example, in the Caribbean and the South Pacific. But even more so than the airship, the flying boat mostly disappeared shortly after World War II. Various types of landplanes took over most of the flying boats’ missions, and the ones they missed were picked up by helicopters. A few countries, notably Japan and the Soviet



FIGURE 5.17. Amphibians such as this Grumman G-21A Goose persisted into the post–World War II era due to their flexibility in operations, especially for charter companies taking customers to exotic and hard-to-reach locales. In the 21st century, aeronautical companies have resumed production of amphibians and floatplanes due to their high demand. (Hans Groenhoff Collection [HGD-157-18], NASM, Smithsonian Institution)

Union, kept building a few flying boats for military purposes, while Canada manufactured a handful to use as water bombers in fighting forest fires. Other than that, the flying boat was nowhere to be seen.

Still, examining the age of the flying boat technically and historically is more than an exercise in nostalgia. These amphibians served a vital role in the birth and the maturity of global aviation. Not just the United States but also virtually every aeronautically minded nation in the world built and flew a number of them. Their advantages appeared to be many. They could take off and set down on the boundless sea rather than within the stuffy confines of an airfield. They could moor in only slightly protected waters and without the need for huge hangar accommodations—and the world was rich with lakes, rivers, harbors, and inlets suitable for setting down. More than anything else, they seemed to be the type of flight vehicle most suitable for crossing the oceans—because only they had the capacity not just to survive but to succeed if they failed to make it all the way across. Unlike other airplanes, they could alight at sea, rest “safely,” taxi, and even take off again.

Thus, the engineering of the flying boat proceeded from the 1910s through the 1940s with a clear goal of realizing these advantages. In the documents that follow, that is the quest that will be outlined. It should be remembered that the Boeing Clippers did not start crossing the Atlantic until 1939, and even then, they

carried no more than two dozen passengers and had to make intermediate stops for refueling.

Documents 5-13 through 5-24 will reproduce a number of reports, articles, letters, and reminiscences concerning the progress of the flying boat from World War I through the end of World War II, most specifically as it related to the R&D leading to aerodynamic refinement. Documents 5-25 through 5-29 will close this section by providing some insights into what has happened in the field of flying boats from 1945 to the present.

Part 3: Rotary-Wing Aircraft

The two types of aircraft studied so far in this chapter—the airship and the flying boat—enjoyed their heyday prior to 1945. During the 1920s and 1930s, they enjoyed a golden age during which most experts felt that these aircraft would make many fundamental and long-lasting contributions to aviation. Some enthusiasts even felt that they would become a predominant form of aircraft and monopolize certain aviation missions and arenas. Commercial, military, and government establishments dedicated substantial resources to their development; as we have already seen, the National Advisory Committee for Aeronautics, for one, focused considerable attention on both through regular subcommittees devoted to their advancement. As aircraft technologies progressed generally, the form of the airship and the flying boat improved as well. Both types contributed to aviation’s projection of military and commercial power in the pre–World War II era, and both launched a number of airline routes, including the first transoceanic ones. So important were these two types of aircraft that it is impossible to understand aviation development before 1940 without paying attention to the roles fulfilled by these machines.

As the airship and flying boat passed into twilight, another form of aircraft came out of the shadows. This was the rotary-wing machine, notably the helicopter: a vehicle that could have radically affected the course of World War II combat if it had been available. Not that it was a brand new invention after 1945; that was hardly the case. Helicopter pioneer Igor Sikorsky believed that “[t]he idea of a vehicle that could lift itself vertically off the ground and hover in the air was probably born at the same time that man first dreamed of flying.”⁸ As we will see in Documents 5-30 through 5-35, a significant amount of work had been done to advance the science and technology of vertical flight long before World War II. But researchers had not solved enough of the enormous technical problems to turn rotary-wing aircraft into practical machinery. This was particularly true for the helicopter, a type of heavier-than-air craft in which lift was obtained by means of one or more power-driven rotors and that sought to achieve a magnificent flight capability that no other

⁸ Quoted in J. Gordon Leishman, *Principles of Helicopter Aerodynamics* (Cambridge University Press, 2000), p. 1.



FIGURE 5.18. Igor Sikorsky (1889–1972) pioneered both the flying boat and the helicopter after his emigration to the United States in 1918. Pan American Airways used his flying boats to expand its Caribbean and Atlantic routes. He returned to his true passion of developing a practical helicopter in the late 1930s. (NASM, Smithsonian Institution [SI 97-16119])

heavier-than-air craft enjoyed: the capability to hover. The helicopter’s development came painfully slowly, with the first tentative successes occurring only after the mid-1930s—and even then, the few experimental helicopters flying remained highly unstable and difficult to control, largely due to the high torque associated with their powered rotors.

In some ways, it is surprising that it took so long for effective vertical-flight machines to be realized, for just as many dreamers and experimenters had been attracted to the concept behind them as to any other principle of flying. Most everyone who has ever studied the prehistory of flight knows that in his famous notebooks, Renaissance artist and engineer Leonardo da Vinci drew sketches of a helical airscrew. In his *Codex Atlanticus*, da Vinci wrote, “I have discovered that a

screw-shaped device such as this... will rise in the air if turned quickly.” But this discovery actually dated to a spinning top—invented by the Chinese no later than the fourth century—that could raise itself slightly off the ground. By rubbing a stick that had an arrangement of feathers on the top rapidly between their hands, Chinese children could generate enough lift to get their toy slightly airborne. In a famous work entitled *Pao-P’u-Tzu* (ca. A.D. 317), contemporary Chinese encyclopedist Ko-Hung, in answer to a question of traveling to great heights and through the heavens, described “flying cars” (*fei che*) made of wood powered by rotating wings whose blades were actuated by leather straps.

Fourteen hundred years later, in 1754, the innovative Russian chemist and astronomer Mikhail Vasilyevich Lomonosov (1711–65) designed a small rotor device similar to the Chinese top but powered it with a wound-up spring. His device had two rotors mounted on coincident axes (it was thus “coaxial”), so that the rotors moved in opposite directions, incidentally minimizing torque. Lomonosov’s idea was to use the lifting machines to elevate small meteorological instruments, a notion that we do not know he ever put into practice. Thirty years

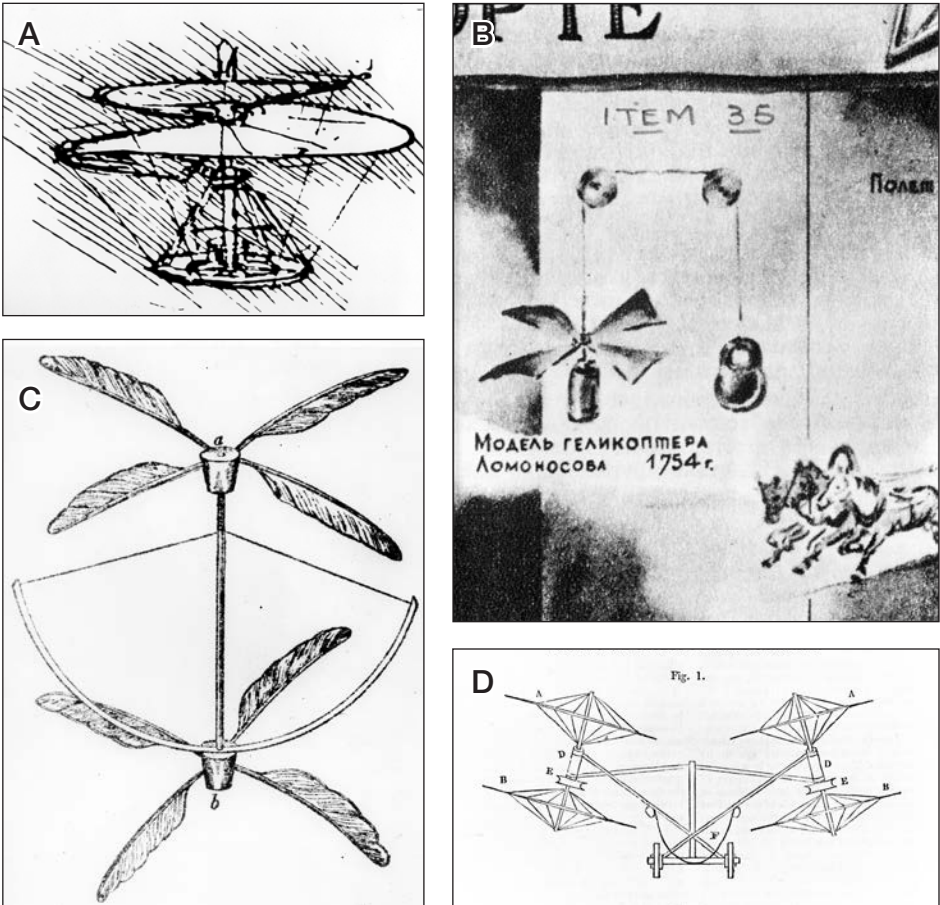

FIGURE 5.19. (A) Pictured are visions of rotary wings from the prehistory of flight: Leonardo da Vinci's helical airscrew, 15th-century Italy. (NASM, Smithsonian Institution [SI 87-15490]) (B) Pictured is Mikhail Vasilyevich Lomonosov's two-rotor spring-powered lifting device, Russia, 1754. (American Helicopter Society Copy Negative Collection, NASM, Smithsonian Institution [NASM 9A00955]) (C) Launoy and Bienvenu's coaxial flying top with wild-turkey-feather rotors, which they developed in France in 1784, influenced the work of Sir George Cayley in England. (NASM, Smithsonian Institution [NASM A-17864]) (D) Sir George Cayley's conceptual "Aerial Carriage" (1843) featured four rotors that generated lift while two propellers provided thrust. (NASM, Smithsonian Institution [SI 92-14966])

later, in 1784, two French inventors, Launoy and Bienvenu, built another coaxial version of the Chinese top.⁹ It consisted of a counter-rotating set of wild turkey feathers and was powered by a string wound around its shaft with tension provided by a crossbow. Two years later, A. J. P. Paucton, another Frenchman more interested

⁹ See Joseph Needham, *Science and Civilization in China, vol. 4, Physics and Physical Technology*, part 2, *Mechanical Engineering* (Cambridge, England: Cambridge University Press, 1965), pp. 582–583.

in vertical heavier-than-air flight than in balloon ascension (remember, this was the era of the Montgolfiers), published a treatise in which he proposed a two-rotor helicopter capable of carrying a human. One of his rotors was to provide lift, the other propulsion.

With such a start, one should hardly be surprised that the pace of experiments related to vertical flight picked up greatly in the 19th century. Sir George Cayley, who developed the concept of the modern airplane, also constructed several vertical-flight models in the early 1800s. Driven by wound-up clock springs, Cayley's little helicopters actually flew pretty well, if only for short distances and only a few feet above the ground. In the 1840s, Horatio Phillips, another Englishman, tried to get a larger machine straight off the ground. A miniature boiler forced steam through the tips of a rotor blade, trying to lift the entire device up. Though his attempt failed, Phillips's effort marked the first time that anyone pursued a helicopter using the power generated by a real engine rather than the stored-up energy of wound-up string or springs. The first recorded use of the term "helicopter" surfaced in the 1860s, when Vicomte Ponton D'Amécourt called his small experimental flying machines *les hélicoptères*, a word he derived from the Greek *elikoeioas*, meaning "spiral or winding," and *pteron*, meaning "feather or wing." The viscount also tried to power a large model with steam. He failed, but his endeavor fascinated compatriot Jules Verne, who later, in his novel *The Clipper of the Clouds* (1886), described a giant helicopter-like machine that gracefully cruised the skies thanks to lift provided by 37 small coaxial rotors.

If situated in the second half of the 19th century, without the awareness of the many difficulties to come, one might have believed from the degree of enterprise in the technology that rotary-wing aircraft and vertical flight might succeed as the first form of powered heavier-than-air flight. Vertical flight models were built and tested all over Europe from the 1860s on: by Henry Bright in England (1861), Gabrielle de La Landelle in France (1863), Alexander Nikolaevich Lodygin in Russia (1869), Alphonse Pénaud in France (1870), Wilhelm von Achenbach in Germany (1874), Dieuaide in France (1877), and Enrico Forlanini in Italy (1878), among others. (The NACA actually published a paper by Achenbach on his experiments with propellers in 1923, as Technical Note 131.) Many of these models flew short distances, but none of them possessed any effective means of control. Even Thomas Alva Edison experimented with the helicopter. First, he tested various rotor configurations driven by a little internal combustion engine that had been powering a cotton gin; but not surprisingly, he quickly turned to the possibility of using an electric motor. Beginning this work in the 1880s, he continued it at least until 1910, when he patented his design for a full-scale helicopter having box-kite-like blades, a machine that never got built. Still, the great American inventor was the first experimenter to realize that for a helicopter to hover efficiently, the diameter of the rotor needed to be relatively large. Besides that, the rotor needed to be highly efficient aerodynamically and required a high-power engine to drive it.

As interested as Edison was in electric motors, the key to the design of the first practical rotary-wing aircraft was in the development of small and lightweight internal combustion engines. This was the critical invention that made it possible for aeronautical experimenters to build full-size models that were adequately powered. But it was also with the emergence of this modern engine that devotees of vertical flight first encountered the huge problem of torque, the damaging effect produced by a fast-turning rotor when it forces the fuselage to rotate in the opposite direction from that of the engine. It would take years of research and development before engineers learned how to counteract rotor torque reaction successfully.

Another essential piece missing from the picture was a mature understanding of the nature of aerodynamic lift. The pioneers who had built the first tentative full-scale rotary-wing aircraft did not understand aerodynamics very well, and they certainly all lacked special knowledge of the aerodynamics of vertical flight. To the extent that relevant aerodynamic theory even existed, most of the pioneers were oblivious to it. In his historical introduction to *Principles of Helicopter Aerodynamics* (2000), J. Gordon Leishman, professor of aerospace engineering at the University of Maryland and former aerodynamicist at Westland Helicopters, noted that “the first significant application of aerodynamic theory to helicopter rotors” did not come until sometime in the early 1920s. Prior to then, pure intuition guided the selection of rotor-blade forms and overall machine shapes. Aerodynamically, one of the major results of this approach was “dissymmetry of lift,” the unequal or asymmetric distribution of lift across the rotor disk owing to the difference in airflow velocity over the advancing and retreating blades. It was this action that tended to cause the early helicopters to flip over on their sides.¹⁰

And these were not the only problems retarding the effective design of helicopters and other types of rotary-wing aircraft in the early 1900s. Engineers had to find a way to keep down the weight of the engine and that of the rest of the structure; otherwise, the machine would be too heavy to lift off with a pilot and any appreciable payload. Once the craft got airborne, it needed an effective means of stability and control. Additionally, vibrations could not be too serious. Here again, aerodynamic knowledge, or the lack thereof, came into play, as it was an insufficient understanding of the dynamic and aerodynamic behavior of rotating wings that led to many failures—not just of rotors, but of airframes as well.

Designers overcame these problems very slowly. Four years after the Wright brothers' historic first powered flight at Kitty Hawk, North Carolina, the world's first recorded free flight of a helicopter and pilot was made when Frenchman Paul Cornu, on 13 November 1907, lifted his twin-rotored machine a few feet into the air for a few seconds. It lifted up with no assistance from the ground, but it did take a team of ground handlers with sticks to stabilize it once it became even slightly

¹⁰ J. Gordon Leishman, *Principles of Helicopter Aerodynamics*, Cambridge Aerospace Series (Cambridge: Cambridge University Press, 2000), p. 3.

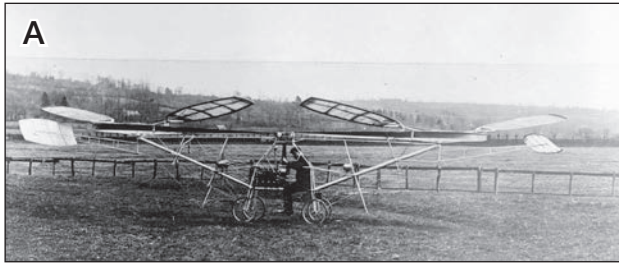

FIGURE 5.20. (A) The twin “rotors” on Paul Cornu’s 1907 helicopter were paddles attached to horizontal bicycle wheels driven by a 24-horsepower engine. (American Helicopter Society Copy Negative Collection, NASM, Smithsonian Institution [NASM 9A00883]) (B) The Berliner 1922 helicopter, seen here hovering briefly at College Park, Maryland, utilized rotors that were essentially wooden propellers with special airfoil profiles and pitch distributions. There was also a small, vertically thrusting auxiliary rotor on the rear of the fuselage. Tilting of the rotor shafts provided directional control, and a small grouping of wings in the rotor slipstream allowed lateral control. All Berliner helicopters used a conventional elevator and rudder assembly at the tail. (NASM, Smithsonian Institution [SI 77-6903]) (C) Jens Ellehammer is a national hero in Denmark for his early flight experiments. His coaxial rotor helicopter never made a free and controlled flight. (NASM, Smithsonian Institution [SI 85-3344]) (D) The Engineering Division’s quadrotor helicopter designed by George de Bothezat lifts off at McCook Field in 1922. (NASM, Smithsonian Institution [SI 77-6876])

airborne. But Cornu's test flights promised much less than the Wrights' and offered far fewer practical solutions. Over the next decade and then some, through the end of World War I and into the early 1920s, Igor Sikorsky in Russia tried numerous other rotary-wing designs or experiments (some as early as 1909).

Several of these early helicopter models featured innovative designs, but none produced a revolutionary breakthrough. Yuriev's configuration of 1911 described the layout of a modern helicopter by having both main and tail rotors. The Russian engineer also proposed the concept of "cyclic pitch" for rotor control. Although it stayed unrealized, the concept called for a control mechanism that could periodically vary the angle of each blade in a rotor during its entire cycle of rotation. This control, Yuriev thought, could produce a tilt in the tip-path plane, forcing motion in a desired direction. When the modern helicopter emerged, this came in the form of a cyclic pitch stick or pitch lever controlled by the pilot. Dutch aviation pioneer Jens Ellehammer's coaxial rotor helicopter of 1914 also incorporated some interesting technical advances, including a cyclic pitch mechanism, but few people knew of his work because he worked in isolation and kept it to himself. Another early helicopter was designed by Georges Botezatu, a Romanian student of Russian aerodynamicist Nicolai Joukowski who later changed his name to George de Bothezat after emigrating to the United States directly following the outbreak of the Bolshevik Revolution.

This project deserves special mention in this history because in the United States, de Bothezat consulted for the NACA through a joint arrangement made with the Army Air Service. Besides advising the NACA on its aerodynamics research program, the Russian émigré was to design a propeller for the Liberty engine, a project that he never completed. De Bothezat moved to a position at McCook Field in Ohio, where, at a cost of about \$2 million, he designed a rather large helicopter for the Flying Section of the Army Engineering Service's Materiel Division. His prototype, a single-seat quadrotor, first flew in October 1922. Although it made over 100 flight tests, it never flew very well. In April 1923, it managed to lift its pilot (test pilot and well-known exhibition flyer Art Smith) and three men hanging on to the airframe to a height of about 4 feet. De Bothezat's helicopter (for which he held United States patent 1,573,228) never attained anything close to the 300-foot hover capability required by the contract. The Army dropped the project totally in January 1924, putting the machine into storage at McCook. Despite his helicopter's demise, de Bothezat's early contributions to the field of rotating-wing aerodynamics are noteworthy. His lengthy paper titled "The General Theory of Blade Screws," which the NACA published as Technical Report 29 in 1919, dated to analyses he had performed in Russia as early as 1916. In his excellent 1998 history of pioneering helicopter concepts, E. K. Liberatore called de Bothezat "one of the more prominent and successful pioneers of the early helicopter era."¹¹ Although de Bothezat's

¹¹ For a full description of de Bothezat's helicopter design, see E. K. Liberatore, *Helicopters Before Helicopters* (Malabar, FL: Krieger Publishing Co., 1998), pp. 115–120.



FIGURE 5.21. The Italian Corradino d'Ascanio reached an altitude of 60 feet in his coaxial helicopter in 1928 and proved to a skeptical public that helicopters could fly higher than a few feet. (American Helicopter Society Copy Negative Collection, NASM, Smithsonian Institution [NASM 9A00958])

1919 paper is not included it in our materials below, the reader will find Document 5-31, a report on “The Problem of the Helicopter,” which the NACA published in May 1920 by Edward P. Warner, who at the time was the chief physicist at Langley.

Although numerous machines were attempted, helicopter progress came slowly. One can get a good indication of exactly how slowly by looking at a few of the records set by helicopters following the Fédération Aéronautique Internationale’s (FAI’s) decision in April 1924 to start officially recognizing helicopter records. The first official FAI record for a helicopter was set in the summer of 1924 by Frenchman Étienne Oehmichen; it was for flying a straight line for 525 meters (1,720 feet). He did so at a whopping height of a little over 3 feet, a clear illustration of how far the technology of rotary-wing aircraft still had to go before becoming practical. Oehmichen later flew his machine, at only a slightly higher altitude, around a 1-kilometer-long closed-circuit course, taking 7 minutes and 40 seconds to do it. For this achievement, the FAI awarded Oehmichen a prize for developing a vertical-lift machine that, according to Alexander Klemin in Document 5-34, was “perfectly maneuverable and stable.” (Document 5-32 reproduces a translation of a French report on Oehmichen’s early work, prepared by the NACA’s Paris Office.)

Four years later, in 1928, Corradino d’Ascanio of Italy (1881–1981) established what was considered to be a remarkable new vertical-flight altitude record when he lifted his coaxial helicopter to some 18 meters, or nearly 60 feet. All these early

pioneers had to contend with fits of “public head-shaking” implying that they were “foolish and mad to get involved in such a crazy idea” as a helicopter.¹² Another illustration of helicopter state of the art in the early 1920s is manifest in Document 5-33, a brief excerpt from Fred E. Weick’s autobiography, *From the Ground Up*. In it, Weick, then employed by the Navy Bureau of Aeronautics, recalled his attendance at the first flight of a lateral rotor helicopter designed by Henry Berliner (the son of helicopter pioneer and inventor Emil Berliner), which took place at College Park, Maryland, in early 1924. (An earlier version of this same helicopter made its first flight demonstration, also at College Park, in June 1922.) As Weick recollected, the performance of Berliner’s machine “was better, I believe, than that by any other helicopter up to that time,” but its performance was still extremely limited. Unable to fly free of ground effects (i.e., where the wake airflow was disturbed by its proximity to the ground), Berliner’s machine never lifted itself any higher than about 15 feet. Weick, who would become a leader in NACA research (1925–29, 1930–36), seems to have passed no direct judgment on the helicopter at the time, but it is clear from his reminiscence that in 1924, he felt that the design of helicopters had a very long way to go.

Still, in the 1920s, enough progress was being made in the rotary-wing field that it was impossible for aeronautical leaders and establishments to ignore it. The NACA, though it actively pursued little vertical-lift research at its Langley Memorial Aeronautical Laboratory in the 1920s, published a considerable number of papers on the subject, many of them foreign (in translation). These included papers by Achenbach (Technical Note 131, 1923), Wladimir Margoulis (TM 79, 1922), Oehmichen (TM 199, 1923), and von Kármán (TN 47, 1921), among others. Britain’s Royal Aircraft Establishment treated the topic of rotary-wing aircraft similarly, doing not much more experimental work than that conducted by the NACA. Document 5-34 provides excerpts from the second major NACA report on helicopters, which appeared in 1925, by the

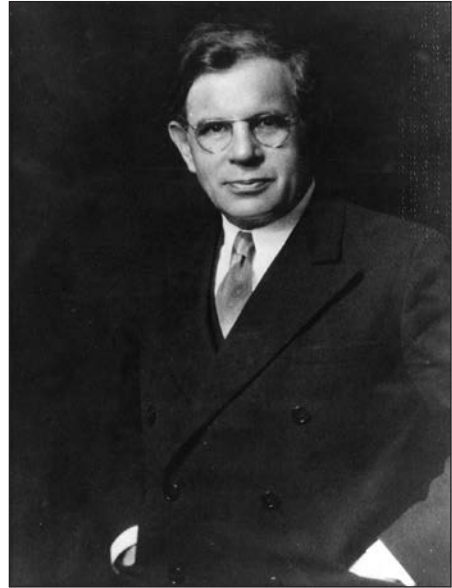

FIGURE 5.22. As head of the Guggenheim School for Aeronautics at NYU, Alexander Klemin (1888–1950) was one of America’s leading aeronautical engineering educators and a strong advocate for helicopter development. (NASM, Smithsonian Institution [SI 79-1250])

¹² Liberatore, *Helicopters Before Helicopters*, p. 161.



FIGURE 5.23. Pictured is the unsuccessful Curtiss-Bleeker helicopter in front of the Langley hangar in June 1930. Bleeker relied upon “stabovators,” fastened to the trailing edge of each rotor, for control. (NASA Image #L-04608 [LaRC])

head of the Guggenheim School for Aeronautics at New York University (NYU), Dr. Alexander Klemin.

The first full-scale rotary-wing machine was not test-flown at the NACA laboratory until the summer of 1930. It was a Curtiss-built helicopter, designed by young Maitland B. Bleeker, a 1924 graduate of the University of Michigan’s aeronautical engineering program. Interestingly, it was while working at NACA Langley for his first two years after graduation that Bleeker first became interested in helicopters.

At Langley, he conducted some experiments that led him to design a propeller-driven rotor prototype; he left the NACA in 1926 to pursue his design with the Curtiss Aircraft Company on Long Island, New York. What Bleeker had in mind, and what Curtiss eventually did build, was an innovative machine that sought to handle the torque reaction problem by delivering power to small propellers that were mounted midway down on each rotor blade. It also had unique auxiliary aerodynamic surfaces in the form of vanes (which Bleeker called “stabovators”) fastened to the trailing edge of each blade of its single four-bladed rotor. These vanes, which Bleeker borrowed from d’Ascanio’s prize-winning 1924 machine, provided

blade cycle and collective pitch control. Curiously, no photographs show the Bleeker machine hovering, only sitting on the ground. The NACA reported that the machine did hover in control in a hangar and made a number of brief flights, some of them at Langley. But its performance was unsatisfactory due to excessive vibrations and instability. Much to Bleeker's disappointment, for he believed its kinks could be worked out, Curtiss and the NACA jointly canceled all work on the machine in 1930 after a total expenditure of nearly \$250,000.

A number of other inventors also built propeller-driven rotor systems, many of them post-Bleeker. These included no fewer than nine prototypes developed in Europe between 1923 and 1941, notably those by Vittorio Isaaco in Italy and Louis Brennan and A. G. Josephson in Great Britain. In 1934, Germany's Anton Flettner also tested a very large (98-foot) rotor version he called the *schwange ente* or "pregnant duck."

By 1930, though, the rotary-wing vehicle attracting most of the attention was not any form of true helicopter, but rather a hybrid machine known as the autogiro. Though it could neither hover nor descend vertically like a helicopter, it was capable of taking off and landing in a small area; thus, many people felt that it was a compromise machine that was much more likely to work out. It seemed to be very safe and virtually stall-proof, given its maneuverability even at very low speeds. Reports and pictures of Juan de la Cierva's successful autogiro flights that took place in Spain beginning in 1923 provoked considerable fascination internationally (see Document 5-35). The *Journal of the Royal Aeronautical Society* published a number of articles by Cierva between 1926 and 1935 (including Document 5-36); in 1926, the first English-built autogiro lifted off; in 1928, the first autogiro flight in America took place; in 1932, Cierva received the Daniel Guggenheim Gold Medal for the autogiro's development; and in 1934, Austrian helicopter advocate Raoul Hafner started building his own improved autogiros. In Britain, several companies built variants of Cierva's machine, including Weir, Avro, Westland, and de Havilland.

In his *Principles of Helicopter Aerodynamics*, J. Gordon Leishman stated that the first flight of an autogiro in the United States came in 1934. But as confirmed in Document 5-37, involving excerpts from Cierva's 1931 book *Wings of Tomorrow: The Story of the Autogiro*, that first flight actually took place some five years earlier, when Harold F. Pitcairn flew one over his home in Bryn Athyn, Pennsylvania, in December 1928. Pitcairn, president of Pitcairn Aviation, a Pennsylvania company that operated a pioneer air mail route between New York, Atlanta, and Miami, had bought the license to build Cierva autogiros in the United States. The very first autogiro that the NACA ever saw firsthand was the machine Pitcairn piloted from near Philadelphia to Langley Field, Virginia, in 1929, a distance of over 300 miles. At Langley, NACA researchers took a close look at it, with mixed reactions about its performance.

How deeply or extensively the NACA became involved in autogiro research has been a matter of some historical controversy. Some scholars, notably Alex Roland

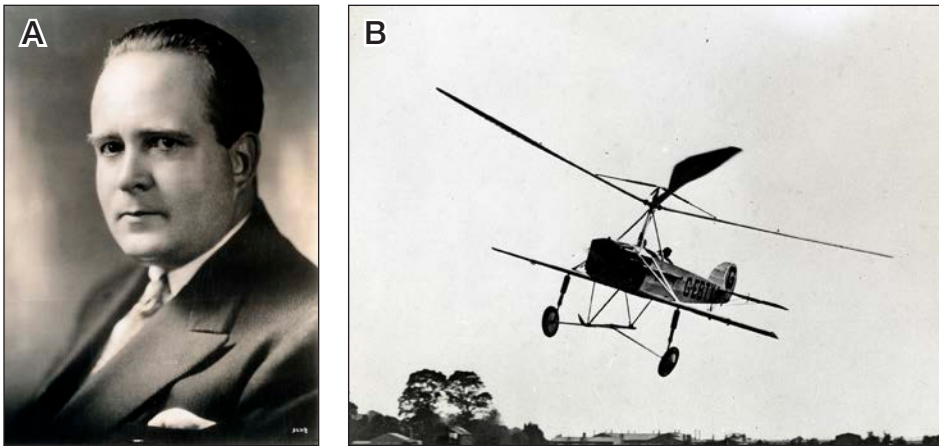

FIGURE 5.24. (A) Juan de la Cierva (1895–1936) desired to build a safe, stall-proof airplane capable of low-speed takeoffs and landings, which led to his invention of the autogiro. (NASM, Smithsonian Institution [SI 88-12576]) (B) Shown is a Cierva C.8V autogiro in flight in 1927. (American Helicopter Society Copy Negative Collection, NASM, Smithsonian Institution [NASM 9A01160])

in *Model Research*, have suggested that the NACA did not spend enough time, money, and energy on the autogiro. Roland simplistically calls the autogiro “a forerunner of the helicopter” when, in fact, it was a rival and a distraction. He also fails to conduct much research into the subject of the NACA’s early interests in rotary-wing aircraft. (Autogiros are mentioned four times in Roland’s two-volume work, twice in an appendix; helicopters get three passing references, one of them in a photo caption.) Roland claimed that there was an “NACA pattern of ignoring helicopter research before World War II.”¹³ In support of this thesis, Roland cited the specific charge of NACA neglect of the autogiro made by the outspoken editor of *Aero Digest*, Frank Tichenor, in his December 1930 article “Why the NACA?” In Tichenor’s view, the autogiro represented “the most



FIGURE 5.25. Harold Pitcairn, seen here with Orville Wright (left), believed in the autogiro and marketed it to the American public. (NASM, Smithsonian Institution [NASM 00081593])

¹³ *Model Research*, pp. 131 and 118.

important invention of recent years,” but the NACA, after showing some initial interest in it, quickly stopped paying attention to it. This was a big mistake and “the most painful subject in connection with the NACA,” according to Tichenor. Document 5-38 reproduces the excerpt from Tichenor’s editorial, along with relevant paragraphs from an internal NACA memorandum of January 1931 in which Langley’s engineer-in-charge, Henry J. E. Reid, responded to Tichenor’s charges.

In the view of others, the NACA’s contribution to the field of rotary-wing aircraft was hardly so weak and insubstantial. In his history *Helicopters Before Helicopters*, Eugene K. Liberatore, a veteran helicopter-engineer-turned-historian, argued that the NACA had taken “the lead” in what he outlined as the third and fourth stages of helicopter development in the United States during the 1920s and 1930s; one of the key aspects of these two stages was “the professional, or scientific approach to the helicopter.” “If one includes its [the NACA’s] autogiro work, rotary wing aircraft got fair treatment before World War II.”¹⁴ In compiling the bibliography for his Cambridge Aerospace Series book *Principles of Helicopter Aerodynamics*, Professor J. Gordon Leishman, an internationally recognized teacher and researcher in the field of helicopters, exclaimed in his preface, “rediscovering the less well-known early NACA and RAE technical literature on the subject of helicopter aerodynamics proved to be one of the most satisfying aspects of writing this book. The rapid progress made in understanding the problems of the helicopter during the period between 1930 and 1950, and the ingenuity shown in both the experimental and analytical work, are quite remarkable.”¹⁵ Thus, to base a claim of an “NACA pattern of ignoring helicopter research before 1945” on an assertion that it did not become an ardent champion of the autogiro—a technology whose protagonism actually retarded helicopter development in many ways during the late 1920s and early 1930s rather than helping it—is a faulty historical interpretation in at least two major respects. First, it grossly undervalues what the NACA actually did in the rotary-wing field; second, it incorrectly perceives autogiro and helicopter development as a single, continuous line.

Even a cursory review of the NACA technical literature shows that some significant attention was being paid to the potential of the rotary wing. Besides the early treatises on helicopter aerodynamics published by the NACA that have already been cited, the NACA also published some of the earliest reports on the autogiro. These included Technical Memorandum 218 (recall Document 5-35), which the NACA issued in 1923 and whose title was “The Autogiro,” involving the work of M. Moreno-Caracciolo, who served as secretary of the Royal Aero Club of Spain; and Technical Memorandum 394, issued in 1927, by R. Seiferth; among others. As mentioned earlier, Langley researchers got a firsthand look at the first autogiro to fly in America as early as 1929, when Harold Pitcairn flew it to Langley

¹⁴ Liberatore, *Helicopters Before Helicopters*, p. 161.

¹⁵ *Principles of Helicopter Aerodynamics*, p. xxvii.



FIGURE 5.26. The NACA conducted an investigation of an experimental cantilevered, three-bladed rotor on the Pitcairn PAA-1 autogiro beginning in 1933. (NASA Image # L-05662 [Langley Research Center, or LaRC])

Field. Beginning in June 1933, at the request of the Aeronautics Branch of the Department of Commerce, researchers at Langley formally began an effort called “Investigation of Landing Characteristics of an Autogiro” under the auspices of NACA research authorization number 418. Between July 1931 and January 1940, Langley test pilots evaluated the performance of no fewer than six different autogiros, including a Pitcairn PCA-2 (July 1931 to September 1933), Pitcairn PAA-1 (which arrived at Langley Field sometime in 1933), Kellett YG-1 (January 1936 to May 1936), Kellett YG-2 (December 1935 to March 1936), Wilford XOZ-1 (August 1937 to sometime in 1941), and Kellett YG-1B (September 1939 to January 1940). All told, autogiros flew experimentally at Langley between 1931 and 1940 for no less than an estimated cumulative total of 86 months, or over 7 flying years. Specific entries on “Rotating Wing Aircraft” began to appear in the NACA’s annual reports in 1933. Document 5-39 reproduces all of the NACA annual report entries on rotating-wing aircraft from 1933 through 1940.

In summarizing for his textbook on helicopter aerodynamics, Professor Leishman recognized that the NACA extensively tested the autogiro in the United States. More than that, he pronounced, based on his review of all the extant technical literature, that the NACA’s critical evaluation of rotary-wing performance helped lead to the demise of the autogiro and to a renaissance of interest in helicopters. In the view of NACA researchers by 1940, the free or “automatic” rotation of blades simply did not suffice and probably never would. What was really needed for effective vertical flight was a true helicopter with a powered rotor system that overcame the chronic problems of torque and lift asymmetry. For a detailed analysis



FIGURE 5.27. Louis Breguet's collaboration with René Dorand resulted in their successful 1935 helicopter. (American Helicopter Society Copy Negative Collection, NASM, Smithsonian Institution [NASM 9A01031])

of the NACA's work on rotary-wing aircraft during this period and afterwards, see F. B. Gustafson's 1973 publication, *A History of NACA/NASA Rotating-Wing Aircraft Research, 1915–1970*. Another major reason for refocusing on the helicopter by the late 1930s involved highly publicized successes of some breakthrough powered rotary-wing machines. In 1935, French aviation pioneer Louis Breguet and associate René Dorand began flying a relatively large coaxial helicopter successfully. One of their vehicle's key innovations was its "swashplate," an assembly linked to the rotor blades that proved critical to the effective performance of a helicopter. What their swashplate did was help control the cyclic pitch of the rotor blades and thus allow the blade angles to be altered so that lift could be equalized on each side of the helicopter's central shaft. The French inventors produced a machine that not only would not tip over easily but also could be tilted effectively by the pilot to move the aircraft in

the desired direction. The Breguet-Dorand helicopter set several records in its class, one for flight duration (62 minutes) and another for nonstop flying (27 miles).

The French success was followed the next year, in 1936, by what has come to be regarded by many aviation experts as the world's first truly practical helicopter. Its inventor, Germany's Heinrich Focke (working with fellow engineers George Wulf and later Gerd Achgelis), built a steadily improving machine that did an even better job than the Breguet-Dorand of solving the essential problems of helicopter control. Focke's helicopter, designated alternately the Fw (Focke-Wulf) or Fa (Focke-Achgelis) 61, also managed to demonstrate successful autorotation—the first helicopter to do so. This modus operandi of an autogiro was vitally important for helicopters when they lost power and needed to windmill down safely to the ground. (The Breguet-Dorand machine had attempted autorotations, but not very successfully. In one attempt, the vehicle crashed. Little progress was made to get back on track before World War II broke out and discontinued all the work.) How the Focke helicopter did this can be seen in Document 5-40, a 1938 translation by the NACA of Focke's evaluation of his helicopter.

Focke's aircraft caused an international sensation in 1937 and 1938 when German aviator Hanna Reitsch flew it to become the world's first helicopter pilot. She demonstrated the machine in free flight at Bremen, Germany, in July 1937;



FIGURE 5.28. The twin-rotor Focke-Achgelis FA-61 was the first fully controllable helicopter when it flew in June 1936. (NASM, Smithsonian Institution [NASM A-2316])

the following year, she made an even more phenomenal flight inside the capacious Deutschland-Halle sports arena in Berlin.¹⁶ The Fw 61 set all new records. Not only did it manage to elevate to an astounding height of 8,000 feet (and later to 11,200 feet), an amazing improvement over D’Ascanio’s record of 60 feet in 1928, but the German helicopter also navigated at an unprecedented forward speed of 76 miles per hour (mph) and traveled a distance of 143 miles.

But it was hardly a perfect helicopter. A lateral-rotor helicopter, its rotors were positioned side by side on the ends of outrigger booms rather than longitudinally in tandem. The body of the helicopter was simply a converted airplane fuselage. Improvements were made in the Focke helicopter, leading to the Fa 226 (also designated Fa 233), a larger, three-bladed machine that first flew in 1940. Germany put it into limited production during the war. Though it could carry a crew of up to four, it did not enter combat and saw little practical use.

Another helicopter produced by Nazi Germany in the early 1940s was the Flettner Fl 282 Kolibri, or “Hummingbird.” In the 1920s, Flettner developed a form of autogiro that he called his “wind ship” or “rotor ship.” It lifted and moved

¹⁶ Gustafson’s work is a Limited-Edition Reprint (VF-70) from *Vertiflite*, a publication of the American Helicopter Society.

as a result of pressures and vacuums channeled around two rotating towers—sometimes referred to as “Flettner cylinders.” Aviation magazines touted its potential starting in 1926, with celebrated scientist Albert Einstein (still in Germany at the time) praising Flettner’s device for its future importance. By the mid-1930s, however, Flettner was focusing on the true helicopter. His major contribution to the progress of helicopter design came in the form of a side-by-side intermeshing rotor configuration in which a gearing system ensured a precise phasing of the rotors. Flettner called his machine a “synchropter” because its blades intermeshed like eggbeaters. His F1-265 synchropter of 1939 managed to do something that no helicopter had ever been able to do before: transition into autorotation and then back again into powered flight. From this basic design, Flettner derived the Hummingbird, which turned out to be the most advanced helicopter of the World War II era. In 1940, Hitler’s German navy, seeking a helicopter for shipborne anti-submarine duties, ordered a number of F1 282s. Flettner did not begin deliveries until 1942, and by 1943, only 24 prototypes had entered service. Still, the model demonstrated enough effectiveness (a speed of 150 kilometers per hour; a service ceiling of 3,300 meters; and a range of 170 kilometers) for a total of 1,000 units to be ordered. This sort of mass production never took place, though, due to lack of resources and Allied bombing of the Flettner plant (and BMW factories where the motors were being produced). Only three Hummingbird units survived the war, with the Germans destroying most of them themselves to avoid their capture. (Flettner came to the United States soon after the war ended and approached the Army with a new helicopter idea, but he instead went to work as a consultant to the Office of Naval Research. His intermeshing-blade helicopter became widely used by helicopter manufacturers in the United States and elsewhere after the war.) During the war, the German Air Force also used a few helicopters, in the form of the Focke-Achgelis Fa 223 Drache (“Kite”). This was a twin-rotor meant for transport. Nineteen of the machines saw limited service with Lufttransport Staffel 40. In September 1945, one of these helicopters, flown by its German crew, became the first helicopter to cross the English Channel, on its way into British hands.

The Allied use of rotary-wing aircraft was equally minor during the war. The British had 52 autogiros “on strength” at the start of the war in 1939. Eventually, that number went up to as high as 171, units that served with what became Royal Air Force (RAF) Coastal Command. Nearly all of these were the Avro version of the Cierva machine. As for helicopters, both the British and the Americans employed the Sikorsky R-4 “Hoverfly,” which first flew in late 1941. On the eve of the war, the United States Army had begun to take a greater interest in experimental helicopters for possible use in reconnaissance and rescue missions. In 1942, it began ordering R-4s; and, by the end of the war, 133 had been delivered. Given the helicopter’s potential for antisubmarine warfare, the Navy, curiously, was so slow to adopt the helicopter. The Army loaned some of its R-4s to the Navy in 1942, but



FIGURE 5.29. The Sikorsky R-4 proved the utility of helicopters for military operations in the Pacific and Asia during World War II. Besides reconnaissance and rescue, the Army Air Forces used R-4s as delivery vehicles between airfields and its floating repair units during the Philippines campaign in 1945. (NASM, Smithsonian Institution [SI 2001-2171])

Navy leaders relegated helicopter testing and operations to the Coast Guard, where the strongest earliest enthusiasm for the helicopter within the Navy existed.

The first combat use of helicopters took place in March 1944 when Lieutenant Carter Harman piloted an R-4 to rescue four airmen downed behind Japanese lines in Burma. The R-4 was also used by Great Britain, with the Royal Air Force employing one squadron of the helicopter for radar calibration and the Fleet Air Arm fielding one squadron for air-sea rescue. In the last year of the war, the larger Sikorsky S-5 entered service for aerial rescue operations. By the end of the war, 65 of these helicopters were operational within the United States Army Air Forces (USAAF). Document 5-41 reproduces a chapter, “The Helicopter Becomes a Reality,” from Igor Sikorsky’s autobiography, *The Story of the Winged-S*, first published in 1938. It concerns the development of his innovative VS-300 of 1939—his first helicopter and the first truly useful single-rotor helicopter ever to fly—as well as the procurement of the XR-4 by the USAAF.

Sikorsky was not the only helicopter designer active in America during World War II, just the most successful. Others included Frank Piasecki, whose small PV-2



FIGURE 5.30. Igor Sikorsky's VS-300, seen here at an early stage of development in 1940, was the first successful American-built helicopter. (NASM, Smithsonian Institution [SI 92-706])

helicopter first took to the air in mid-1943, followed by his larger tandem-rotor helicopter, called the PV-3 “Dogship,” later that same year. The twin tandem-rotor arrangement pioneered by Piasecki proved critical to helicopter development because it enabled helicopters to grow to almost twice their previous size without the difficulties of creating very large rotor blades. Two other Americans building helicopters during the war or immediately after it also made major contributions. Stanley Hiller designed the world’s first helicopter with all-metal rigid-rotor blades, the XH-44 of 1944. For his K-125A of 1947, Charles Kaman adopted Flettner’s synchropter concept and added to it his invention of servo-flaps, special control surfaces (mounted at the three-quarter rotor radius) that could be deflected cyclically for improved rotor control.

Of them all, however, Arthur Young (1905–95) may have been the most brilliant; he was certainly one of the most ingenious inventors of flight technology, but he remains mostly unknown by the general public. Starting in the early 1930s, Young started experimenting with model helicopters. So impressed with Young’s ingenuity was Lawrence D. “Larry” Bell, founder and president of Bell Aircraft Corporation, that in 1941 he set Young up in a small shop in Gardenville, New York. From there, Young devised a model that proved successful enough in tethered, “control-line”



FIGURE 5.31. Frank Piasecki's small PV-2 helicopter was the second successful helicopter to fly in the United States. (American Helicopter Society Copy Negative Collection, NASM, Smithsonian Institution [NASM 9A00979])

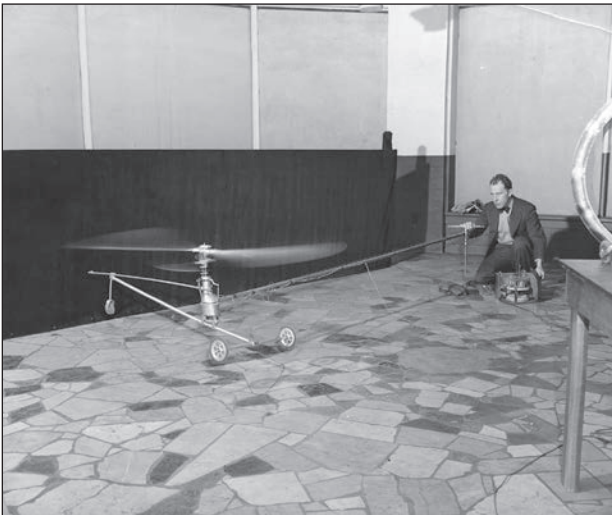

FIGURE 5.32. Arthur Young demonstrates his tethered, "control-line" helicopter model, with its teetering control rotor and stabilizer bar. (Bell Helicopter Textron via NASM, Smithsonian Institution [SI 85-3372])

flight to lead to the design of a full-size aircraft, the Bell-30 helicopter. (A control line is a line that is attached to the controls of a flying model aircraft and manipulated by an operator on the ground.) The key innovation of the Bell-30 was its teetering rotor and associated stabilizer bar. Leishman has described the advantages of Young's invention in the following way: "The bar had bob weights attached to each end and was directly linked to the rotor blades through the pitch control linkages. The idea was that if the rotor was disturbed in pitch or roll, the gyroscopic inertia of the bar could be used to introduce cyclic pitch into the main rotor system, increasing the effective damping to disturbances and giving stability to the rotor system."¹⁷ After untethering the Bell-30 in 1943, it made flights at speeds of up to 70 mph. But the major story came three years later with Bell's next helicopter,

Model 47. One of the most significant helicopters of all time, it featured an articulating two-blade rotor that was gyroscopically stabilized. On 8 March 1946,

¹⁷ Leishman, *Principles of Helicopter Aerodynamics*, p. 19.

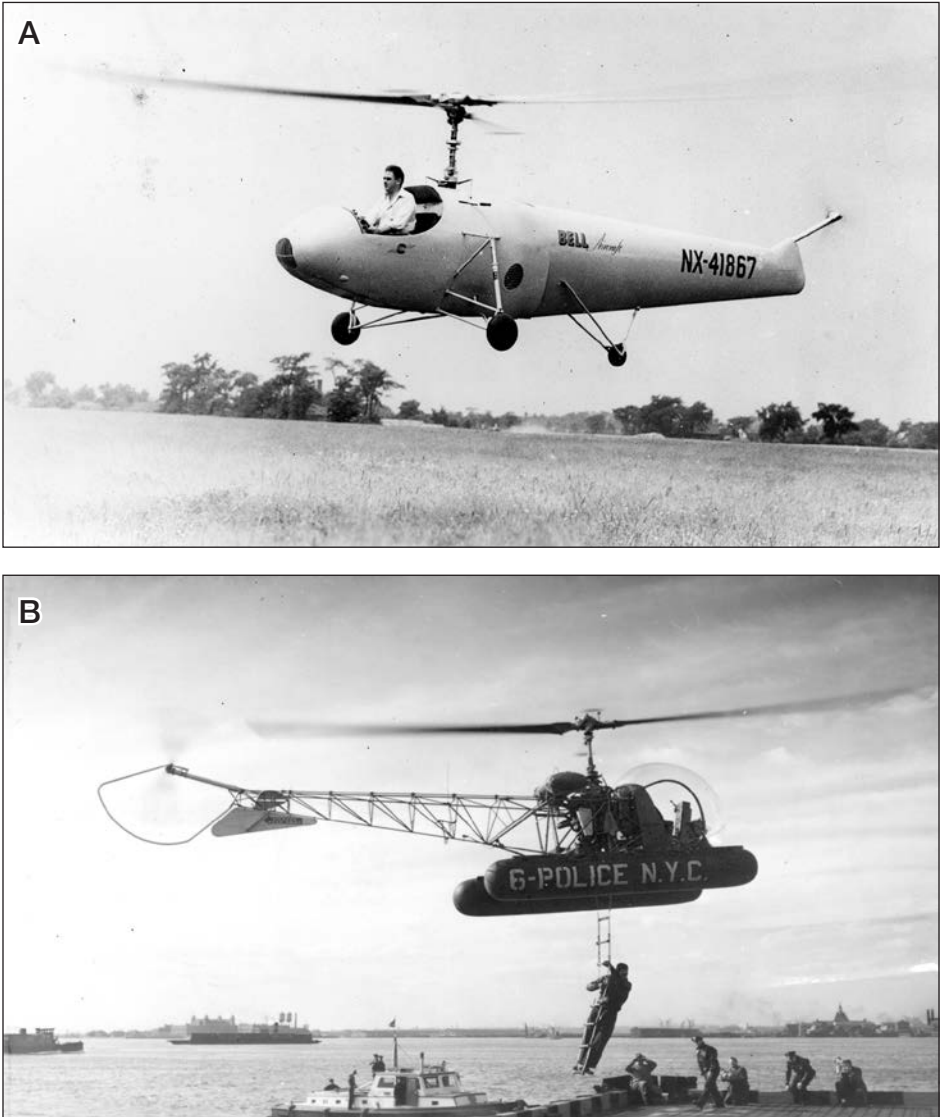

FIGURE 5.33. (A) The Bell Model 30 is shown in flight. (NASM, Smithsonian Institution [NASM 00109818]) (B) The proliferation of the Model 47 helicopter into the military and civilian fields in the late 1940s and early 1950s cemented Bell's position as the world's leading helicopter manufacturer. It also ushered in ongoing uses for the helicopter, especially as a vehicle for law enforcement. (NASM, Smithsonian Institution [NASM 92-16262])

the Model 47 earned certification from the Civil Aeronautics Board (the Federal Aviation Administration's antecedent), the first helicopter ever to be licensed. This set the stage for the birth of a whole new industry, one that Bell Aircraft Corporation and its new helicopter division (established in Fort Worth, Texas, in 1951) would dominate for many years.



FIGURE 5.34. Kaman combined a Boeing 502 gas turbine engine with his synchropter rotors and servo-flap cyclic control system to create the pioneering K-225 in 1951. (NASM, Smithsonian Institution [SI 2002-958])

Document 5-42 provides an excerpt from Arthur Young's 1979 autobiography, *The Bell Notes: A Journey from Metaphysics to Physics*.

Despite the success of World War II-era helicopters, numerous problems still plagued their operation. Compared with conventional aircraft, they just did not possess adequate power, were hard to control, and experienced dynamic stresses so high that structural and equipment failures often occurred. Before the commercial and military use of helicopters could expand greatly, these problems had to be solved.

In a process in some ways similar to, yet essentially very different from, the airplane undergoing a design revolution associated with jet propulsion and high-speed flight in the postwar era, the helicopter moved into a period of its first true maturity in the 1950s, due in large part to the introduction of the turbine engine. Much more so than fixed-wing aircraft, reciprocating engines simply could not satisfy the helicopter's special requirements for power. They were too large and weighed too much for the horsepower provided, and they performed less efficiently, especially at cruising altitude. The gas turbine offered helicopter designers the means to correct many of their machine's basic problems. The turbine was smaller and weighed less than a piston engine of comparable power. It generated much less vibration

and even used less expensive fuel. Its very application of jet propulsion had to be handled quite differently, however. In a conventional airplane, designers used the power of a jet engine primarily to increase speed. But with a helicopter, the idea was to capture the thrust of the jet via a gearbox that would then do a far better job of turning the rotor.

Charles Kaman experimented with turbine power for his K-225 helicopter of 1951. This first application of jet-engine technology to the helicopter anywhere in the world also incorporated Kaman's patented aerodynamic servo-controlled rotors in the synchropter configuration, that is, having side-by-side rotors with intermeshing paths of blade travel. (This historic aircraft—the world's first gas turbine-powered helicopter—is on display at the National Air and Space Museum in Washington, DC.) But a trend toward jet-powered helicopters did not take shape internationally until the appearance of the French SNCASE SE 3130 Alouette II helicopter in March 1955. Powered by a Turbomeca Artouste II turbine engine, this machine quickly became one of the most influential helicopters in the world. Its builder, a company that became part of Sud-Est Aviation in 1957 and a subsidiary of the huge Aerospatiale conglomerate in 1970, went on to dominate a large part of the European and worldwide market for rotary-wing aircraft by building a number of different jet-powered helicopters, from light two-person private machines to heavy-lift, twin-engine, troop-carrying versions.

In terms of the aerodynamics of the postwar generation of machines, it would take a review of literally hundreds of technical reports to survey the progress being made in helicopter design. One of the most succinct ways of following developments in the field is to follow the annual reports of the NACA from 1946 to 1958, the year the NACA turned over operations to the newly established NASA. Document 5-43 provides such a summary in the form of the NACA's brief reviews of the activities of its Subcommittee on Helicopters.

It should be clear from the contents of Document 5-43 that the NACA paid considerable attention to the aerodynamics of rotary-wing aircraft, particularly the helicopter, in the late 1940s and 1950s; in fact, Liberatore has asserted that “[p]ractically all the basic helicopter theory and testing emerged from work by this organization.”¹⁸ The NACA realized that the performance and utility of helicopters had been improving rapidly and that advocates of the machines were already beginning to use them in a variety of ways—for carrying mail and passengers, spraying agricultural crops, carrying out medical evacuations, fighting fires, performing police work, and even controlling mosquitoes. But serious problems still existed, and a substantial amount of R&D was still needed if all the unique potentialities of rotary-wing aircraft were to be fully realized. Researchers needed to refine general rotor theory and make it easier for designers to apply it. They needed to understand better the effects of blade twist, planform, and rotor-tip solidity, and they needed to

¹⁸ Liberatore, *Helicopters before Helicopters*, pp. 161–162.



FIGURE 5.35. Aerospatiale introduced the SA.341 Gazelle in 1971 as a replacement for the highly successful Alouette II. It featured a Fenestron shrouded tail rotor and high tail fin that increased high-speed performance and protected the rotor from damage. The French and British military and numerous international operators used the Gazelle around the world. (NASM, Smithsonian Institution [NASM 7A00452])

define the types of airfoil sections that worked best as rotor blades. They wanted a more complete analysis of rotor inflow, i.e., the distribution of air flowing through and about the lifting rotor. Vibrations and rotor-blade flutter concerned everyone greatly and needed to be addressed. Furthermore, rotor blades sometimes stalled and at other times produced aerodynamic instabilities that could be very dangerous to the aircraft. There was the problem of gust loads and their effects on structural fatigue. Certainly, there was room for improvements in stability and control, as well as the need for better instruments. Then there was the whole matter of properly integrating the turbine engine and seeing how jet propulsion mechanisms affected such things as autorotation in vertical descent. Once helicopters started reaching a level of high maturity, then the issue of parasite drag became more important. For the first time, starting in the mid-1950s, it became important to put helicopter prototypes through exhaustive “drag cleanup,” just as the NACA had done with dozens of new aircraft during World War II. The activities of the Subcommittee on Helicopters described in the NACA’s annual reports from 1946 to 1958 document



FIGURE 5.36. John P. “Jack” Reeder (right) and James B. Whitten before a flight to investigate the handling qualities of a Piasecki HRP-1 tandem-rotor helicopter in 1951. (NASA Image #L-71609 [LaRC])

serious attention paid to all these problems and more.

Some of the NACA’s experimental work involved a new test facility at Langley, known as the Helicopter Apparatus. Working on the old principle of the whirling arm, the apparatus consisted of a 40-foot-high cone-shaped steel tower with a drive shaft in its center for mounting a helicopter rotor. A strain gauge measured the torque and thrust on the shaft; cameras recorded the action of the rotor while it whirled around. The idea behind the device was to investigate the fundamental factors affecting the performance, stability and

control, and vibration characteristics of helicopters. Authorized in 1944, it became operational in 1946. The facility was deactivated in 1976, when NASA transferred all of its helicopter work to Ames Research Center in California.

The engineer who designed Langley’s Helicopter Apparatus was Frederic B. Gustafson. Born in 1913, Gustafson earned a bachelor’s degree in mechanical engineering in 1936, as well as a master’s degree in that field in 1938, both from the University of Kansas, before beginning work at Langley in the summer of 1938. Gustafson is a coauthor of two different NACA reports on helicopters from April 1948 and May 1953. Working with him on these papers was Langley test pilot John P. “Jack” Reeder. Born in 1916, Reeder also came to Langley in 1938, after earning a bachelor of science degree in aeronautical engineering from the University of Michigan. He would go on to become one of the most experienced test pilots and most prolific flight researchers in the history of American aeronautics. Among the many dozens of different aircraft he tested during his long career with the NACA and NASA, Reeder piloted numerous helicopters. Between April 1944 and November 1958, for instance, no fewer than 12 helicopters came to Langley for months at a time to undergo testing. At one point or another, Reeder piloted all of them.

This experience started with his flying a Sikorsky R-4 (Navy designation HNS-1, Bureau of Aeronautics No. 39034); it ended with the Hiller YH-32 (USAF No. 55-4970); and it involved a number of other Sikorsky, Bell, Piasecki, Vertol, and Hiller craft in between. When the NACA metamorphosed into NASA, Reeder

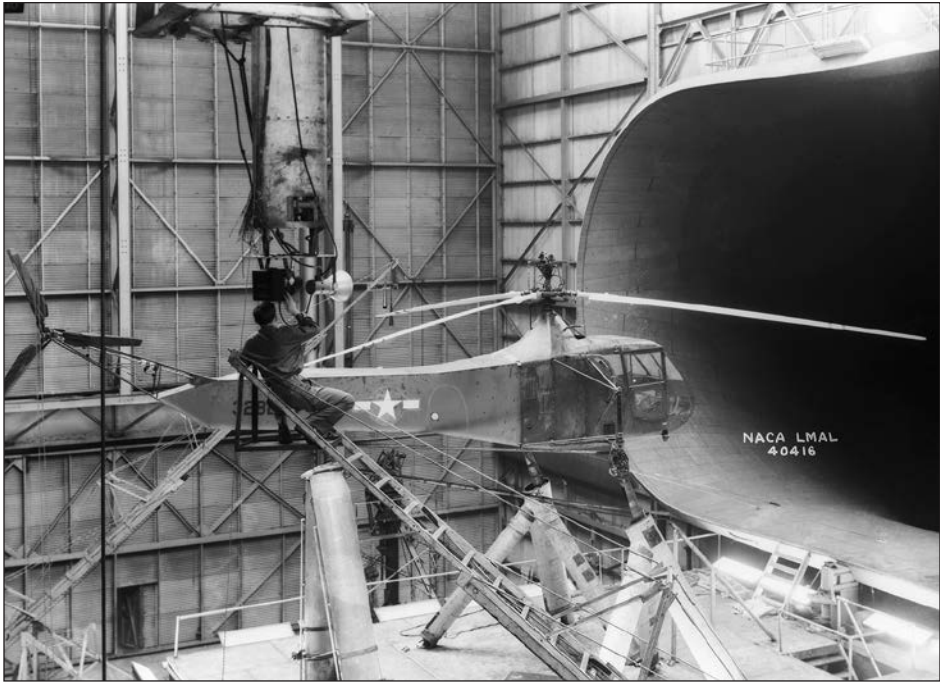

FIGURE 5.37. A Sikorsky YR-4B/HNS-1 helicopter is shown in the 30- by 60-Foot Full Scale Tunnel at Langley. The camera equipment captured images of the rotor blades as they rotated in simulated flight. (NASA Image #L-40416 [LaRC])

flew even more models, making him one of the most versatile—and most accomplished—helicopter test pilots in U.S. history. He ranks among the all-time greatest rotorcraft test pilots—a list that includes the likes of Art Smith, the well-known stunt flyer; Thurman H. Bane, the first military helicopter pilot, who flew the de Bothezat machine at McCook Field between 1922 and 1924; the Army Air Service’s Harold Harris, who piloted Berliner’s helicopter in 1923–24; James G. Ray and Fred “Slim” Soule, pilots for the Autogiro Company of America; John Miller, Dave Driskill, and Lou Leavitt, pilots for Kellett; Carl Bode and Ewald Rohlf, test pilots for Focke’s breakthrough machines; and Joe Mashman and Floyd Carlson, Bell’s first demonstration helicopter pilots, in the early 1940s. None of these other test pilots came close to publishing the number of substantive engineering analyses that Reeder produced over the course of his nearly 40 years of flying helicopters.

An even clearer indication of the NACA’s heavy involvement in rotary-wing research came with the publication in 1951 of the first major U.S. college-level textbook on the subject: *The Aerodynamics of the Helicopter*, authored by NACA researchers Alfred Gessow and Garry C. Myers, Jr. The book was written for senior and graduate engineering students and for engineers in the helicopter industry who were interested in obtaining a more thorough understanding of the rudiments of

helicopter aerodynamics. Inspired by their experience teaching an evening extension course on the principles of rotary-wing aircraft for the University of Virginia in 1946, the authors built their book of more than 300 pages primarily from a vast body of experimental and theoretical work conducted by the NACA. From 1945 on, Gessow and Myers worked in the Flight Research Division at Langley, and it was here that the duo obtained the greatest part of their training and experience in helicopters. From that time to the publication of their text in 1951, the NACA published no fewer than 15 papers by Gessow, Myers, or the two jointly. These papers included the following:

- “Flight Tests on the Sikorsky HNS-1 (Army YR-4B) Helicopter,” NACA MR L5D09a, 1945 (Gessow and Gustafson).
- “Effect of Rotor-Tip Speed on Helicopter Hovering Performance and Maximum Forward Speed,” NACA ARR L6A16, 1946 (Gessow and Gustafson).
- “Stalling of Helicopter Blades,” NACA TN 1083, 1946 (Myers and Gustafson).
- “Effect of Blade Stalling on the Efficiency of a Helicopter Rotor as Measured in Flight,” NACA TN 1250, 1947 (Gessow and Gustafson).
- “Flight Measurements of Helicopter Blade Motion with a Comparison Between Theoretical and Experimental Results,” NACA TN 1266, 1947 (Myers).
- “Effect of Blade Stalling on the Efficiency of a Helicopter Rotor as Measured in Flight,” NACA TN 1250, 1947 (Gessow and Gustafson).
- “Flight Tests of a Helicopter in Autorotation, Including a Comparison with Theory,” NACA TN 1267, 1947 (Gessow and Myers).
- “Effect of Rotor Blade Twist and Plan-Form Taper on Helicopter Hovering Performance,” NACA TN 1542, 1947 (Gessow).
- “Analysis of Flight Performance Measurements on a Twisted, Plywood-Covered Helicopter Rotor in Various Flight Conditions,” NACA TN 1595, 1948 (Gessow and Gustafson).
- “Standard Symbols for Helicopters,” NACA TN 1604, 1948 (Gessow).
- “Flight Investigation of Effects of Rotor-Blade Twist on Helicopter Performance in High-Speed and Vertical-Autorotative-Descent Conditions,” NACA TN 1666, 1948 (Gessow).
- “Bibliography of NACA Papers on Rotating-Wing Aircraft, July 1948,” NACA RM L7J30, 1948 (Gessow).
- “Flight Investigation of Effects of Rotor Blade Twist on Helicopter Performance in the High-Speed and Vertical-Autorotative-Descent Condition,” NACA TN 1906, 1949 (Gessow).
- “An Introduction to the Physical Aspects of Helicopter Stability,” NACA TN 1982, 1949 (Gessow and Kenneth B. Amer).
- “An Analysis of the Autorotative Performance of a Helicopter Powered by Rotor-Tip Jet Units,” NACA TN 2154, 1950 (Gessow).

Gessow, Myers, and their NACA colleagues grew steadily more involved in rotary-wing research as the 1950s proceeded. Gessow himself authored papers on

rotor theory (in 1952 and 1954), induced flow of a lifting rotor (1954), rotor efficiency in hovering (1954), blade flapping (1955, 1956), the effects of compressibility on helicopter rotor performance (1956), the effects of tip speed (1959), the role of the tail rotor in stability control (1955), and stall effects on lifting-rotor characteristics (1960). He also created various tables and charts, as well as a formal set of equations and procedures for estimating the performance of helicopters (1955, 1956, 1960). In 1954, the Prewitt Aircraft Company (Richard H. Prewitt, president of the company, presided over the NACA's Subcommittee on Helicopters from 1949 to 1951) also selected him to edit its volume called *Aerodynamics and Performance of Helicopters*, volume 6 in a series of 18 volumes summarizing modern work in aerodynamics and performance calculations. Alexander Klemin and Igor Sikorsky were the two major contributors to Gessow's volume. As for the Gessow-Myers textbook of 1951—for which the contents of NACA research reports provided the backbone—not only was it the first college text on helicopter aerodynamics, but it remained the most used, best-known text in the field for the rest of the century. (For a selection from this text, see Document 5-45).

Another major textbook did appear in 1980—Wayne Johnson's *Helicopter Theory* (Princeton University Press), a very complete treatment of design aerodynamics and the engineering theory of helicopters. Significantly, it, too, was a product of a government research engineer. After serving as a researcher with the United States Army Research and Technology Laboratories, Johnson went to work at NASA Ames Research Center in California in the 1960s. At Ames in the early 1970s, Johnson developed a comprehensive set of numerical specifications or “code” that evolved into the accepted standard for rotor dynamics and stability analysis. The code proved to be an important tool for predicting the aeroelastic stability margins of safety in wind tunnel and flight-test programs and, as such, was used extensively by both NASA and the aircraft industry. This code was applied not only to helicopters but also to tilting prop-rotors, a type of rotating-wing aircraft that NASA and certain sectors of the industry began to promote seriously in the 1970s. Much of Johnson's work in the 1970s, in fact, previous to his authoring *Helicopter Theory*, concerned the dynamics of tilt rotors. Document 5-46 reproduces the chapter from the text dealing with “Design.”

Given the significance of the Gessow-Myers textbook of 1951, the great extent to which it was based on NACA research going back into the 1930s, the expanding volume and scope of work carried out in the field by the NACA in the late 1940s and 1950s, the prevalence of NACA/NASA citations in Johnson's 1980 text, and the credit that the newest books on helicopter aerodynamics and design (by Liberatore in 1998 and Leishman in 2000) give to the NACA's pioneering rotary-wing research, there can be little doubt as to the significance of the contributions made by the NACA/NASA to rotary-wing aerodynamics in its critical decades after World War II, and even in the years just before the war. A full account of these

contributions and a critical appraisal of their significance is a topic that historians still need to investigate.

Into the 1960s, helicopter design, manufacture, and operation proliferated worldwide. These activities involved numerous developments in Europe and such major aircraft companies as France's Sud Aviation (later Aerospatiale), Italy's Agusta and Fiat, Germany's Messerschmitt, and Britain's Westland as well as Bristol Helicopters. Three design bureaus within the Soviet Union—Kamov, Mil, and Yak—built helicopters. Mil (founded in 1946 by Mikhail Leontyevich Mil) created no fewer than 15 different helicopter types (with more than 200 variants) and set nearly 100 global records. At the end of the 20th century, Mil built one of every four helicopters manufactured worldwide and represented 95 percent of all helicopters being used in the former Soviet Union as well as in Eastern Europe. In the 1960s, Japan's Kawasaki and Mitsubishi firms began building helicopters. Other designs were produced in Argentina, Australia, Belgium, Brazil, Canada, Czechoslovakia, the Netherlands, Poland, Romania, Spain, and—by the 1980s—even in India, South Africa, Sweden, and Yugoslavia. And not all of these aircraft involved helicopters. New types of autogiros as well as what came to be called "compound aircraft" were also produced, particularly by Britain's Fairey Aviation Company. One of the compound aircraft that Fairey pioneered was the "gyrodyne," a type of helicopter whose rotor (or rotors) provided lift only but whose motive power was provided either by a propeller or by jet. Fairey's first gyrodyne, the FB-1, which flew in the late 1940s, had a propeller on the end of a stub wing that provided both propulsion and antitorque. The company went on to develop a Jet Gyrodyne that was driven by little jets set into the tips of the rotor blade. In the late 1950s, Fairey built its Rotodyne, a huge prototype with a cabin accommodating as many as 40 passengers. Before the project was canceled in 1959, the Rotodyne set a world speed record for "convertiplanes," a category of aircraft (including autogiros and gyrodynes) coined in the early 1950s that combined certain features of the helicopter with those of a conventional airplane.

One of the most important new developments in the field of rotary-wing aircraft, and one in which NASA researchers took the lead, involved a particular form of convertiplane involving either a "tilt-wing," a wing that entirely tilted (and along with it, the rotors mounted on it), or the "tilt-rotor." The idea behind both hybrids was for the machine to take off as a helicopter but then, after lifting off, fly as a conventional turboprop aircraft. In a tilt-rotor, this was to be done by having tiltable rotors placed on a short wing that was itself stationary. A small British firm, Baynes Heliplane, conceived a tilt-rotor in the 1930s but did not build it. A number of companies experimented seriously with both types of "tilt" starting in the 1950s, many of them to the point of building flying prototypes. Some companies preferred the tilt-wing, notably Boeing and Hiller. In the mid-1950s, Boeing joined with Vertol (which it later incorporated) to produce the Vertol 76 or VZ-2. In the summer of 1958, this tilt-wing performed a successful transition from vertical to

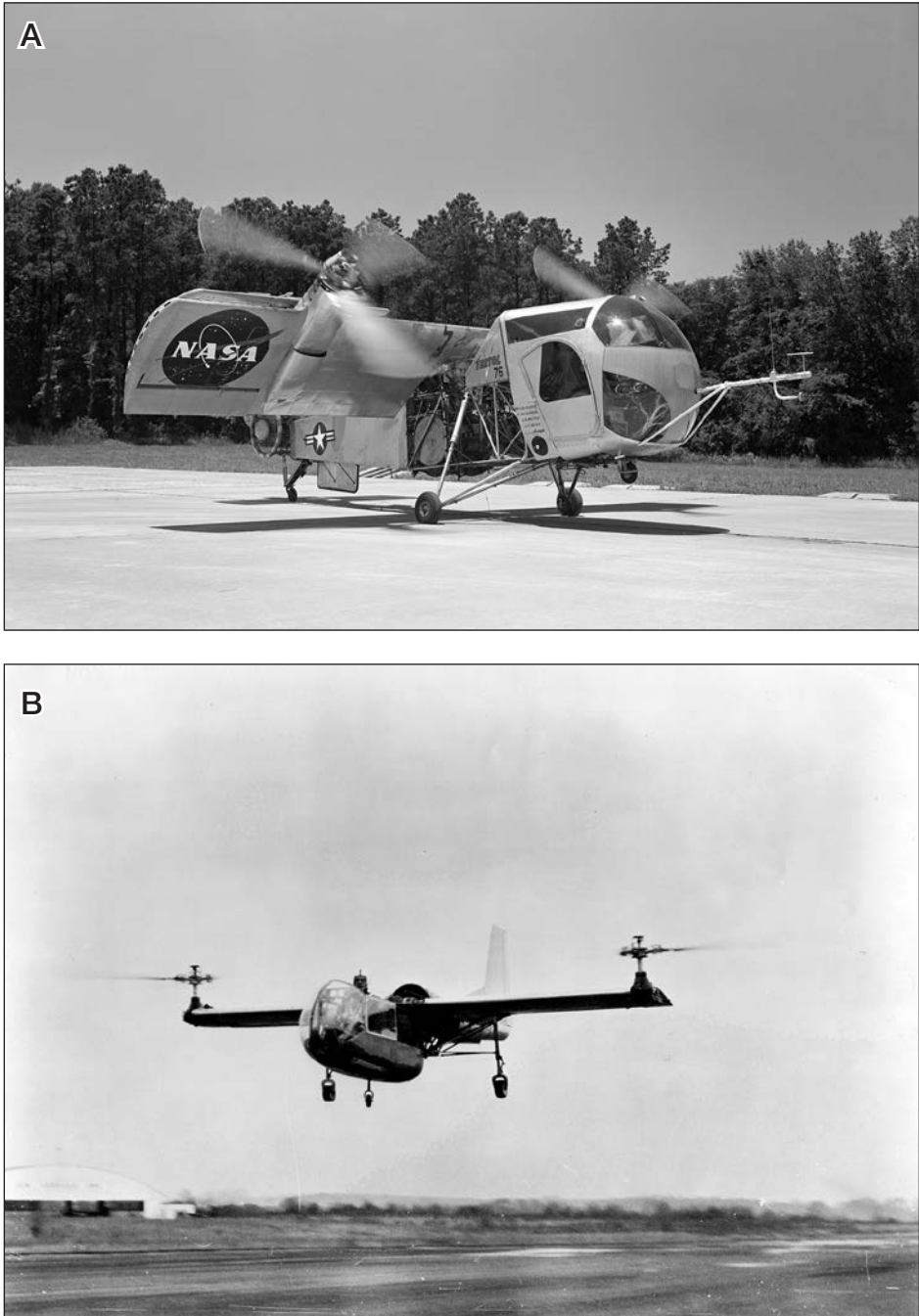

FIGURE 5.38. (A) Pictured is the Vertol 76 tilt-wing at Langley for its vertical takeoff and landing (VTOL) flight tests. (NASA Image #L-1960-04109 [LaRC]) (B) Transcendental's Model 1-G tilt-rotor is shown in hovering flight. (NASM, Smithsonian Institution [SI 2004-4104])

horizontal flight. But it experienced aerodynamic problems that were never satisfactorily resolved. During its transition or “conversion” from vertical to horizontal flight, the tilting wing stalled. This produced flow separations that were extraordinarily difficult for the pilot to handle.

Engineers had better success with the tilt-rotor. Bell Aircraft Corporation joined with Transcendental Aircraft Corporation to design the first fully articulating rotors. Transcendental was a small company formed in 1945 by former Piasecki workers led by Robert L. Lichten, who dreamed specifically of fulfilling the promise of tilt-rotor technology. Their prototype, known as Model 1-G, was a small, single-seater “convertible helicopter” with two three-bladed rotors located at the ends of short wings. These rotors acted as normal helicopter rotors for takeoff and landing, but they could be swiveled forward to work like traction airscrews on a conventional airplane for more effective cruising flight. Transcendental’s Model 1-G tilt-rotor began test flights as a helicopter in June 1954 and started flying “convertibly” six months later. It made over 100 flights but was destroyed in a crash in July 1955 due to a rotor-control failure. Two papers by Lichten—one from October 1949 and the other from October 1957—appear below as Document 5-47.

Much of the inspiration behind tilt-rotor technology came directly from industry’s interests and from military requirements, but a lot of it also came from the NACA and NASA. On 17–18 November 1960, NASA held its first major conference on vertical/short takeoff and landing (V/STOL) aircraft at Langley. The specific purpose of this meeting was “to convey to the United States military services and to the aircraft industry the results of recent NASA research pertinent to low to moderate subsonic-speed aircraft having VTOL capability.”¹⁹ Twenty-six papers were presented over two days in four sessions—Aerodynamics, Handling Qualities, Operating Problems, and Loads and Structures. The aerodynamics session featured eight papers. Summaries from five papers compose Document 5-48. In the final paper, whose summary is included, Langley’s Charles H. Zimmerman presented a “Summary of the V/STOL State of the Art.” In it, Zimmerman argued that while the conventional helicopter remained “the most desirable configuration when hovering is a major part of the mission,” its limitations in terms of cruising speed and range called for an expanded research program in other types of V/STOL aircraft, including various forms of “compound helicopter” and tilt-rotor, as well as tilt-wing and even tilting ducted fan. The latter involved an engine, mostly likely a jet, incorporating a fan or propeller enclosed in a duct. The ducted fan took in air to augment the combustion gases in the air or jet stream.

Much of the analysis taking place at the NASA conference in 1960 concerned the performance of a series of tilt-rotor prototypes developed by Bell following the experience of Transcendental’s Model 1-G machine. One of the earliest of these,

¹⁹ NASA, “Conference on V/STOL Aircraft: A Compilation of the Papers Presented,” Langley Research Center, Langley Field, VA, 17–18 November 1960.

the XV-3, had two three-bladed rotors that could convert from helicopter mode to straight and level flight like an airplane. Aeroelastic (i.e., flutter) problems plagued its rotor blades, leading to accidents—but not before the machine made the world’s first conversion of a tilting prop-rotor aircraft in 1958. Bell persisted with the tilt-rotor concept, building a second XV-3 and defining several other possible tilt-rotors. This commitment eventually led to Model 301, which became the renowned XV-15. (Document 5-49 offers a retrospective account of NASA’s involvement in the XV-3 program and its follow-on to the XV-15.) In the 1970s, a test program with the XV-15 fully demonstrated the viability of tilt-rotor operation and led in 1983 to the design of the V-22 “Osprey,” the product of a joint program between Bell and Boeing with assistance from NASA. Although kinks still needed to be worked out, so impressive was the performance of the several test and preproduction Ospreys that the United States Navy and Marine Corps decided in 1997 to put the aircraft into production. With funding for continued tilt-rotor R&D behind it, Bell announced that same year that it was planning to build a civilian tilt-rotor, one that could transport as many as nine executive passengers at a speed of 315 mph over a maximum distance of 860 miles.

For NASA, tilt-rotor R&D often went on hand in hand with efforts to develop advanced helicopters. Much of its work on rotor-systems technology took place in association with the U.S. Army. In the late 1960s, the Army established the Army Aeronautical Research Laboratory (AARL) at NASA Ames, a main part of which focused both on advanced helicopter and tilt-rotor concepts. A new Center Director at Ames, Dr. Hans Mark, moved aggressively to attract money and other support for research on short-haul aircraft, including V/STOL designs. In 1971, NASA established a V/STOL Projects Office at Ames; a year later, a Tilt Rotor Research Aircraft Project Office came to life there. In 1976, NASA Headquarters named Ames its “lead center” in helicopter research—much to the chagrin of Langley, which had gotten more heavily involved in all sorts of V/STOL as well, including helicopters. In 1978, Ames began testing Bell’s XV-15 in the 40- by 80-foot wind tunnel. In-flight demonstrations of this big tilt-rotor prototype began at Ames and at NASA Dryden Flight Research Center (now Armstrong Flight Research Center) in 1980. A complete (mostly firsthand) history of the NACA/NASA involvement in tilt-rotor research leading up and through the XV-15 research aircraft program is provided in Martin D. Maisel, Demo J. Giulianetti, and Daniel C. Dugan, *The History of the XV-15 Tilt Rotor Research Aircraft: From Concept to Flight* (2000), selections from which compose Document 5-49. Document 5-50 reproduces excerpts from a December 1981 paper by J. C. Narramore of Bell Helicopter Textron titled “Advanced Technology Airfoil Development for the XV-15 Tilt-Rotor Vehicle.” During the same time period that NASA and Bell were actively pursuing tilt-rotor systems, European companies also began exploring the technology. In 1986, several of them created a consortium called Eurofar to build a commercial tilt-rotor transport. Eurofar designed an aircraft that looked a lot like the V-22 Osprey but



FIGURE 5.39. (A) The Bell XV-15 is shown in forward flight. (Courtesy of Bell Helicopter Textron, NASM, Smithsonian Institution [SI 92-15093]) (B) The technical offspring of the XV-15, the Bell-Boeing V-22 Osprey, is shown in its vertical takeoff orientation. (NASM, Smithsonian Institution [97-15252])

never built a machine. Document 5-51 provides a Bell Textron account of the “Aerodynamic Design of the V-22 Osprey Proprotor” from May 1989.

From the 1960s on, all forms of V/STOL aircraft (including, but not limited to, tilt-rotors and helicopters) benefited from sustained R&D in the rotary-wing field. In terms of aerodynamics specifically, the many different ways found by scientists and engineers to improve rotor efficiency and augment the capacity of a rotating wing to provide lift and cruise performance in mechanically reliable ways resulted in much safer and more versatile rotary-wing aircraft. Thanks to ongoing experimental and theoretical work related to blade design, rotor articulation, rotor response to loads and controls, the effects of the boundary layer, compressibility, and viscous and unsteady aerodynamics, many of the aerodynamic limitations of rotor blades have been addressed, if not all resolved. Computational fluid dynamics (CFD) and computer-aided design made some important contributions to the progress of rotary-wing aircraft from the 1980s on, and in the 21st century, both will surely contribute even more.

A century earlier, in the 1880s, America’s greatest inventor, Thomas Edison, predicted that “[w]hatever progress the airplane might make, the helicopter will come to be taken up by advanced students of aeronautics.”²⁰ For the next 70 years, Edison’s assertion made little sense to most people. Not just helicopters, but autogiros and all other manner of rotary-wing aircraft struck most experts in the mainstream of aeronautical development as “noisy, unstable, rickety contraptions that could barely lift the pilot and a small payload”²¹ into the air. But, as we have seen, this situation changed dramatically with the end of World War II, as did so many other things about life on the planet after that conflict, especially as they related to science and technology. The aeronautics establishment began to take the potential of rotary-wing aircraft very seriously, and a whole new industry emerged to give that form of flying its own unique sort of wings.

To assess the historical significance of the helicopter during the second half of the 20th century, all one really has to do is mention its ubiquitous role in the Vietnam War. Of course, as viewers of the long-running television series *M*A*S*H* know, helicopters served earlier in the Korean War, as they also did in limited ways in the wars in Algeria and Indochina during the 1950s. Mostly, they served as aerial ambulances for medical evacuations, or “medevacs,” in Korea in the form of the Hiller UH-12/OH-23, Bell 47 (H-13 Sioux), and Sikorsky H-5; but they also saw their first limited uses in armed combat, principally the Sikorsky H-19. The U.S. military recognized that the helicopter had enormous potential as a gunship, but the technology of the piston-engine was just not yet up to the task. Effective military utilization awaited the development of the first effective turbine-powered

²⁰ Quoted in George H. Guy, “Real Navigation of the Air,” *American Review of Reviews* 38 (July–December 1908): 321.

²¹ Leishman, *Principles of Helicopter Aerodynamics*, p. 78.



FIGURE 5.40. Although the aerial evacuation of wounded soldiers is the persistent image of the helicopter's role in Korea, combat helicopters, primarily the Sikorsky H-19C Chickasaw, also delivered supplies and other valuable cargo to soldiers in the field. (United Technologies Corporation Archive via NASM, Smithsonian Institution [NASM 00088684])

machines. Even as medevacs, the Korean War–era helicopters were quite limited. Typically, the cabin of a medevac could carry no more than three people, including the wounded. The Sikorsky H-19, known as the Chickasaw, managed to carry up to 10 soldiers.²² Fifteen years later, following arrival of turbine power, the situation in Vietnam was vastly different.

Progress in helicopter performance can be gauged from a variety of noteworthy records and achievements. In June 1972, Aerospatiale's SA-315B Lama helicopter set a world altitude record of 12,442 meters (or some 40,809 feet), a record that remains unbeaten to this day. What led to its design was a request by the government of India for a helicopter capable of landing at an altitude of 6,000 meters (19,685 feet) above sea level with a 200-kilogram (over 400-pound) payload. Five years earlier, in June 1967, the Lockheed 186 (XH-51) set a world speed record for a compound helicopter of nearly 290 miles per hour. Today's absolute speed record

²² Many U.S. helicopters were named after Native Americans, generally after tribes, e.g., Chickasaw, Sioux, Kiowa, or Apache, but occasionally after chiefs, e.g., Black Hawk. A notable exception to this was the name Cobra, which Bell used for its AH-1 helicopter in the 1960s. Those who have researched the matter can find no definite rationale for using Native names.

for a true helicopter came in 1986, when a Westland Lynx with specially designed high-speed rotor blades flew to a speed of over 248 miles (400.87 kilometers) per hour. Besides altitude and speed, size can also be used as a measure. The biggest helicopter ever built to date was the Soviet Union's Mil Mi-12 Homer of 1968. What it amounted to was two Mi-6's joined together. When it was built in 1957, the Mi-6 itself, the U.S.S.R.'s first turbine-powered "helo," was the world's largest helicopter. At 41 meters long and 9.8 meters high, with a 35-meter rotor, it managed to lift takeoff weights in excess of 28,000 kilograms, or nearly 62,000 pounds. In August 1969, the monstrous Mi-12 dwarfed that achievement by lifting some 40,301 kilograms, with a maximum potential listed at over 10,432 kilograms, or 116 tons. Perhaps most indicative of the success of the helicopter in the second half of the century was its sheer numbers. By the late 1990s, the world helicopter fleet stood at roughly 56,200. It was divided almost equally between civil helicopters (about 26,500) and military helicopters (about 29,700.) Roughly 40 percent of the world's helicopters belonged to the United States, followed by another 20 percent to Europe, 15 percent to the countries of the former Soviet Union, 13 percent to Asia and the Pacific Rim, 6 percent to South America, 4 percent to the Middle East, and 2 percent to Africa.

Declining defense budgets and depressed civil markets will probably keep the overall number constant for many years to come, though a large number of helicopters may be procured to replace existing fleets. Most likely, these will include Westland's EH-1, marketed jointly by Agusta and Westland and working through European Helicopter Industries; Boeing-Sikorsky's RAH-66 Comanche; NH Industries' NH-90, whose two variants (a Tactical Transport Helicopter and a North Atlantic Treaty Organization (NATO) Frigate Helicopter) are produced at the partner companies of Eurocopter (Aerospatiale in France, MBB in Germany, Agusta in Italy, and Fokker in the Netherlands); and the Tiger attack helicopter, a joint venture of Aerospatiale and MBB that started in the mid-1980s to provide an attack helicopter to the German and French armies but that now supplies a broader international market. Most certainly, one extraordinary rotary-wing machine that is sure to be ordered in significant numbers well into the 21st century is the previously mentioned Bell-Boeing V-22 Osprey (refer to Document 5-51). The United States Marine Corps, for example, took delivery of the military version of this tilt-rotor, designated the MV-22, in 2000, and they became operational in 2007. In a speech in 1999, President Bill Clinton's Secretary of Defense, William Cohen, called the MV-22 a "revolution in military affairs" and noted that it would carry Marines into operations around the world well into the 21st century.²³ In terms of the sale of all its different models, military and civilian, Bell Helicopter Textron,

²³ Quoted in Jim Garamone, "Tilt-Rotor Technology Promises Military Revolution," *DoD News* (8 September 1999).



FIGURE 5.41. The Sikorsky UH-60A Black Hawk replaced the Huey as the American military's main air-assault, transport, and medevac helicopter in 1978. Variants of the Black Hawk will continue to serve well into the 21st century. (NASM, Smithsonian Institution [NASM 7A39190])

America's leading helicopter manufacturer, entered the new millennium with an order book valued at \$2.65 billion.

One last indication of the growing prevalence of these machines should be noted. A search of the Internet in the year 2020 for Web sites containing information about helicopters and helicopter manufacturers returned no fewer than 244 million "hits." "Rotary wing" accessed 18.4 million matches, and "tilt rotor" alone resulted in more than 10.1 million.

In the opinion of some aeronautical engineers in the early 21st century, small VTOL aircraft promises the greatest revolution in personal mobility since the automobile. In their view, personal air transportation based on some sort of helicopter or convertiplane, as revolutionary as that seems, marks "the next logical step in the development of human infrastructure and corporal communication," i.e., bodies moving around from one place to another. This is the view of one of NASA's farsighted aeronautical dreamers, Dennis M. Bushnell. In Document 5-53, which was published as part of a compendium of papers entitled "The Personal Aircraft," published by NASA in December 1994, Bushnell explored the potential of a

personal aircraft system, known as the “helo-converticar,” capable of both ground and VTOL air operation. Seconding Bushnell’s bold vision of personal helicopters is the final selection for this chapter, Document 5-54, the provocative epilogue to E. K. Liberatore’s 1998 book *Helicopters Before Helicopters*. Whether their concepts of mass personal mobility will ever come to pass is highly questionable, but it is a venturesome concept worthy of Dietrich Küchemann.

THE DOCUMENTS

Document 5-1

Excerpt from Max M. Munk, “My Early Aerodynamic Research—Thoughts and Memories,” in *Annual Review of Fluid Mechanics* 131 (1981): 1–7.

During World War I, many aerodynamicists were just as interested in the possibilities of airship travel as they were in that of airplanes. In this brief excerpt from a published autobiographical essay, Dr. Max M. Munk, one of Ludwig Prandtl’s prized students at the University of Göttingen during the war and a subsequent NACA researcher, recalled the competition between lighter-than-air and heavier-than-air in the 1910s.

After graduating from Göttingen in 1918, Munk worked a short time for the German navy and then became an employee of the airship manufacturing company Luftschiffbau Zeppelin, where he designed a small atmospheric wind tunnel and proposed the design of a much larger device for testing large airship models. This incredible 1,000-horsepower facility was never built, but, according to Munk’s plan, it would have been capable of simulating the flight of a full-size airship by having a 152-kilometer-per-hour closed-circuit airflow pressurized to an astounding 100 atmospheres.

After German air power was outlawed by the Versailles Treaty ending World War I, Munk immigrated to America, where he took a job as a “technical assistant” to the National Advisory Committee for Aeronautics. He stayed with the NACA until 1927, becoming chief aerodynamicist at NACA Langley in 1925. He was not popular with the laboratory staff, however, and was eventually forced to resign.

Over the course of his long career (he retired in the 1960s after many years in a teaching post at Catholic University in Washington, DC), Munk authored a number of significant reports related to the aerodynamics of airships. These included “The Drag of Zeppelin Airships” (NACA Technical Report [TR] 117, 1921); “The Choice of the Speed of an Airship” (NACA Technical Note [TN] 99, 1922); “Note on the Pressure Distribution over the Hull of Elongated Airships with Circular Cross Section” (NACA TN 192, 1924); “Aerodynamic Forces on Airship Hulls” (NACA TR 184, 1924); “The Flapping of Airship Covers” (*Aero Digest*, 1930); “The Computation of the Apparent Mass of Dirigibles” (*Journal of the Aeronautical Sciences*, 1935); and “On the Problems of Progressive Airship Research” (in *Report on Airship Forum*, a publication of the Daniel Guggenheim Airship Institute, 1935).

To the end of his life, Munk never gave up on the potential of the airship, though not much of his work dealt with airships after 1935.

Document 5-1, Excerpt from Max M. Munk, "My Early Aerodynamic Research—Thoughts and Memories," in Annual Review of Fluid Mechanics 131 (1981): 1–7.

Next to the boundary layer, there was also much talk about lighter-than-air and heavier-than-air, and which would win. The terms are today almost forgotten. The present generation could not understand the question. But it took many years to realize the possibilities of airplanes. They were then slow and small, with an open cockpit. It was mathematically proven that larger airplanes could never be built. The Zeppelin airships flew over England. There were no anti-aircraft guns. The airplanes are now large enough to hold 300 passengers and the dirigibles have disappeared. They could never fly fast, nor economically reach high altitudes. They could not economically cross the Rocky Mountains. I have not even seen a small blimp for a long time. But times change and we change with them. It is not absolutely certain that the dirigibles are gone for good. We have now better materials, and the frame may be made a little larger, of high grade steel. For dirigibles have one advantage over airplanes which fits present needs. They can transport heavy loads with very little energy required. They have only small engines. They need no power for keeping them aloft. And the larger they are, the more favorable is the power requirement. The last word about dirigibles is perhaps not yet spoken.

Document 5-2 (a-s)

Excerpts from *Annual Report of the National Advisory Committee for Aeronautics* (Washington, DC), 1920–36.

- (a) “Development of Rigid Airships,”
Annual Report (1920), p. 19.
- (b) “Production of Helium,” *Annual Report* (1920), p. 19.
- (c) “Helium and Airships,” *Annual Report* (1921), p. 5.
- (d) “Airship Development,” *Annual Report* (1921), pp. 21–22.
- (e) “Helium for Airships,” *Annual Report* (1921), p. 22.
- (f) “The Electrostatic Problem of Airships,”
Annual Report (1921), p. 22.
- (g) “Special Committee on Design of Army Rigid Semirigid Airship ‘RS-1’,” *Annual Report* (1924), pp. 9–10.
- (h) “The Airship Problem,” *Annual Report* (1925), p. 58.
- (i) “Airships,” *Annual Report* (1927), pp. 72–74.
- (j) “American Airship Development,”
Annual Report (1928), p. 17–19.
- (k) “Airships,” *Annual Report* (1929), p. 85.
- (l) “Airship Investigations,” *Annual Report* (1929), pp. 30–32.
- (m) “Airships,” *Annual Report* (1931), pp. 65–66.
- (n) “Airships,” *Annual Report* (1932), pp. 59–60.
- (o) “Airships,” *Annual Report* (1933), p. 15.
- (p) “Lighter-Than-Air Craft,” *Annual Report* (1934), p. 2.
- (q) “Airships,” *Annual Report* (1934), p. 17.
- (r) “Airships,” *Annual Report* (1935), p. 16.
- (s) “Airships,” *Annual Report* (1936), p. 17.

The great age of the airship should not be viewed as a strange era in aviation history, for there were solid reasons into the 1930s to believe that airships would continue to make a significant contribution to the progress of flight, both commercial and military. This long string of brief items from NACA *Annual Reports* between 1920 and 1936 reflects the strength of the American aviation community's interest in the potential of airships prior to the Hindenburg disaster of May 1937.

The NACA showed serious interest in lighter-than-air flight technology from its establishment as a federal agency in 1915, but its comprehensive involvement in lighter-than-air research dates more specifically from 1922, when the U.S. Navy Bureau of Aeronautics began to show significant interest in rigid airship development. As historian William F. Trimble has described the situation, the Navy faced "the daunting strategic problem" of operating across the vast reaches of the Pacific Ocean. Its admirals felt that if war ever broke out with Japan, the Navy might not be able to "safely move its battle fleet across the ocean without employing large numbers of scouting cruisers" for which money and naval bases were not available. "The large rigid airship seemed the obvious solution to the dilemma. It had the speed, range, and payload capacity to augment the scout cruiser in the long-range reconnaissance role, and with a complement of airplanes it could cover thousands of square miles of ocean in advance of the fleet."¹

As readers will see, one reason why the NACA, the Navy, and much of the American aeronautics community were so positive about airship development had to do with the United States' virtual monopoly on the world's helium supply. Though helium provided a little less lift than did hydrogen (roughly 60 pounds per 1,000 cubic feet under standard conditions at sea level rather than hydrogen's 65), it was much preferred for safety reasons over the more volatile hydrogen for use in balloons and airships. Not even the accidents that would continually plague airships in the 1920s and 1930s could curb their appeal. NACA director for research George W. Lewis believed that accidents like the 1922 crash of the *Roma* could not stop the development of lighter-than-air aircraft. In one respect, he was accurate: even though roughly one-third of the world's airships would be destroyed in accidents, strong support for the airship persisted. In another respect, however, Lewis was mistaken. It took only one sensational and very public disaster, the Hindenburg explosion, to end the age of the airship. Many aeronautical experts continued to believe in the potential of airships, and the U.S. Navy made extensive use of non-rigids in World War II. But systematic R&D in lighter-than-air technology came virtually to an end, certainly within the NACA, after May 1937.

¹ Trimble, *Admiral William A. Moffett: Architect of Naval Aviation* (Washington, DC: Smithsonian Institution Press, 1994), p. 13.

Document 5-2 (a), "Development of Rigid Airships,"
NACA Annual Report (1920), p. 19.

DEVELOPMENT OF RIGID AIRSHIPS

The National Advisory Committee for Aeronautics at the semiannual meeting of the full committee had under consideration the question of the development of rigid airships, which the committee considers essential for our national defense. The Army and Navy had agreed that until standard types were developed in this country, the work of development should rest with the Navy. The proper development of this type of aircraft for military purposes will unquestionably lead to the development of commercial types, but it is felt that the Government must take the lead by first developing rigid airships for military purposes.

The committee at that time submitted a special report to the President recommending that adequate provision be made in the then pending naval appropriation bill for the construction of rigid airships and suitable hangars, and that a continuing building program for this type of aircraft be authorized, extending over a period of years. The committee at this time reiterates this recommendation, and expresses its belief that this experimental development is of vital importance to the effectiveness of the Army and Navy in time of war, and particularly to the military and naval air services as combatant arms.

Document 5-2 (b), "Production of Helium," NACA Annual Report (1920), p. 19.

PRODUCTION OF HELIUM

At the semiannual meeting of the full committee, held in April, 1920, consideration was given to the question of the production of helium. Helium had such advantages over any other known gas as to make its use imperative for military and naval airships in time of war, provided it can be made available in sufficient quantity. In letters to the Secretary of War, the Secretary of the Navy, and the Secretary of the Interior, the committee stated that it is necessary to encourage the economical production of helium in order that an increased demand may bring about a greater increase in the supply, a simplification of the processes of extraction, and a lessening of the cost of production. The committee especially invited their attention to the necessity for thoroughly investigating all sources from which helium may be extracted or secured, and recommended that every practicable effort be made both to increase production and to decrease cost, having due regard for conservation of the sources of supply for military purposes.

Document 5-2 (c), "Helium and Airships," NACA Annual Report (1921), p. 5.

HELIUM AND AIRSHIPS

The United States has a virtual monopoly of the known sources of supply of helium, and these are limited. Experiments have been conducted by the Bureau of Mines with a view to the development of methods of production and storage, but as yet the problem of storage in large quantities has not been satisfactorily solved. Because the known supply is limited, because it is escaping into the atmosphere at an estimated rate sufficient to fill four large airships weekly, and because of the tremendously increased value and safety which the use of helium would give to airships, particularly in warfare, it is, in the opinion of the National Advisory Committee for Aeronautics, the very essence of wisdom and prudence to provide for the conservation of large reserves through the acquisition and sealing by the Government of the best helium-producing fields. Attention now being given to the development of types of airships to realize fully the advantages which the use of helium would afford should be continued. Such development would give America advantages, for purposes either of war or commerce, with which no other nation could successfully compete.

*Document 5-2 (d), "Airship Development,"
NACA Annual Report (1921), pp. 21–22.*

AIRSHIP DEVELOPMENT

Germany and England have produced the best demonstrations of the potential value of rigid airships, both for military and commercial purposes. Germany, in particular, has demonstrated the practicability of commercial airship passenger service. The French Government has laid out a progressive program of development. France has two rigid airships of the Zeppelin type, which were acquired from Germany through the Reparations Commission. The present French program calls for the early inauguration of a commercial airship line from Marseille or Toulon to Algiers. In Italy, the semirigid type of airship has been developed, both for military and commercial purposes.

America's first program of airship development contemplated the procuring by the Navy of a rigid airship from England—the ill-fated R-38, known in this country as the ZR-2; the procuring by the Army of the Italian semirigid airship *Roma*; and the construction by the Navy at Lakewood[,] N.J., of the first American rigid airship, to be known as the ZR-1.

The disaster to the ZR-2 in Great Britain before delivery to this country threatened for a time the discontinuance of airship development in America. The National Advisory Committee for Aeronautics, in a special resolution addressed to

the President and to the Secretaries of War and of the Navy in September, 1921, pointed out the tremendous advantage possessed by America by reason of its virtual monopoly of the known sources of supply of helium, and urged the continuance of our airship development program, stating that it would be contrary to the true American spirit to abandon a conservative program of development because of a single disaster. The committee renews its recommendations then made, that the development of airships be continued, and that sufficient funds be provided for experimental work for the[] obtaining of definite information regarding the strength qualities of materials and girders used in the construction of airships, and for the development and checking of the theories used in the general design of airships.

As the technique of airship construction has not as yet been developed in this country, the committee believes it advisable, in the interests of rapid and economical progress, that the Government procure a rigid type of airship, either of German or British manufacture, embodying the latest developments, as far as possible, of both countries. Such an airship is an indispensable part of our program, and should be obtained to fill the vacancy caused by the loss of the ZR-2. The committee also renews its recommendation that the present program for the construction of the ZR-1 at Lakewood, N.J., be prosecuted with renewed vigor.

Document 5-2 (e), "Helium for Airships," NACA Annual Report (1921), p. 22.

HELIUM FOR AIRSHIPS

Helium, next to hydrogen, is the lightest gas known. It has 92 percent of the lifting power of hydrogen and for military purposes possesses an inestimable advantage over hydrogen in that it is nonflammable. The natural-gas wells in the United States afford a practical monopoly of the known sources of supply. According to the latest estimates, helium is escaping into the atmosphere at the rate of one and a quarter million cubic feet a day, or at a rate sufficient to fill four large airships a week. At this rate, according to our present knowledge of helium-bearing gas, our great resources will have become dissipated within the next 20 years unless some appropriate measures are taken to preserve the sources of supply.

The refrigeration process is employed to obtain helium. In this process every constituent present in the natural gas is liquefied except helium, which is expelled into suitable containers for storage. The application of this process to the extraction of helium has not been perfected, but the line of development is reasonably clear. The Army, the Navy, and the Bureau of Mines, acting in close cooperation (with the limited funds available), are carrying out certain developments which promise to solve the production problem.

The Bureau of Mines is also conducting experiments to determine whether underground-chamber storage is practicable and economical. If so, the problem

may be resolved into one of conservation by the storage of helium in its natural state. Helium for current uses, however, will continue to be stored in high-pressure containers until used.

In connection with the consideration of an airship development policy, the committee presents as the crystallized opinion of the Government experts who have studied the helium problem that in helium the United States has exclusive possession of a valuable adjunct to national defense which will be wasted unless conservation is provided for without delay.

The National Advisory Committee for Aeronautics therefore recommends that the Government acquire and seal for future use the best helium-producing gas fields; that such experiments be continued as are involved in the development of an efficient and economical process for the extraction and repurification of helium; and that the Government continue experimental work in connection with the development of airships, and inaugurate without delay the use of airships inflated with helium. With large reserves of helium and the development of types of airships to fully realize the advantages to be derived from the use of helium, America would possess resources and knowledge with which no other nation could successfully compete.

Document 5-2 (f), "The Electrostatic Problem of Airships," NACA Annual Report (1921), p. 22.

THE ELECTROSTATIC PROBLEM FOR AIRSHIPS

The question of the danger to airships from static charges of electricity and from lightning was referred to the committee, and a large amount of data was collected. In the end the procedure adopted by the Navy Department was investigated and approved.

Document 5-2 (g), "Special Committee on Design of Army Rigid Semirigid Airship 'RS-1'," NACA Annual Report (1924), pp. 9-10.

SPECIAL COMMITTEE ON DESIGN OF ARMY SEMIRIGID AIRSHIP "RS-1"

At the request of the Army Air Service, the National Advisory Committee for Aeronautics appointed a special subcommittee to examine and report on the design and construction of the Army semirigid airship known as the RS-1. This special subcommittee was organized on February 15, 1923, as follows:

Henry Goldmark, chairman.

W. Hovgaard.

Max M. Munk.

L.B. Tuckerman.

W. Watters Pagon, secretary.

The RS-1 is a semirigid type airship, 300 feet in length, 71 feet in diameter, and has a capacity of 700,000 cubic feet. The contract for the design and construction of the airship was awarded by the Army Air Service to the Goodyear Tire & Rubber Co.

Following the organization of the subcommittee, one of the first meetings was held at the Goodyear Tire & Rubber Co. at Akron, Ohio. Here the members had an opportunity of thoroughly acquainting themselves with details of the design and construction of the airship. During the first meetings the discussions were largely confined to the specifications of the Army Air Service for the construction of the RS-1 airship with regard to the design, fabrication, and the flight performances.

Following the meeting at Akron, the committee confined its activities to the technical questions of design and safety of the RS-1. Many of the special problems were studied by separate members of the committee, who reported to the committee at their meetings. One important problem requiring detailed investigation was the problem of sufficient strength of the nose cap and its attachment to the keel structure. Investigation showed that a nose cap strong enough to withstand external forces, with a zero pressure in the envelope, was not feasible on account of the weight required in the structure. A very satisfactory design was agreed upon and has been completed, requiring, however, a small pressure to be maintained inside the envelope.

Another problem considered was the "breathing stresses." The problem was how the load and bending moments created were distributed to the envelope and to the keel structure. It is safe to say that both the keel and envelope take a portion of the load, but it is safer to make the keel strong enough to take the total load.

The problem of obtaining the stresses in the keel, especially considering the possibility of the changes in the shape of the envelope throwing additional stresses on the keel, does not lend itself to reliable mathematical analysis. At the request of the committee[,] the Army Air Service has had constructed a special model of the RS-1 including the keel structure. This water model will be tested at McCook Field in the near future[,] and it is expected that the results of the test will give numerical information with reference to the stresses in the keel and envelope with changing pressures. This is the first known test of this kind on a water model of an airship with a model of an elastic keel attached.

Document 5-2 (b), "The Airship Problem," NACA Annual Report (1925), p. 58.

THE AIRSHIP PROBLEM

Airships are of three types: Rigid, semirigid, and nonrigid. The value of airships for military or commercial purposes has not as yet been conclusively demonstrated. It can not be said, however, that they are without value, nor that they have no further possibilities than have already been demonstrated. The fact of the matter is that all types of airships are in the experimental stage of development. The recent regrettable loss of the rigid airship *Shenandoah* has been urged as a reason for the Government's abandoning airship development, or at least rigid airship development, on the theory that rigid airships never will be practicable.

The committee fully appreciates the seriousness of the airship situation and believes that despite all that has been done in many countries to develop airships, they are still rather delicate structures. The conclusions of the naval court of inquiry as to the causes for the destruction of the *Shenandoah* have not yet been made public. Regardless, however, of the actual technical causes, the committee is of the opinion that it would be a serious error at this time to adopt a policy of merely marking time in the development of airships. In the judgment of the committee, the time has come to decide to do one of two things, viz, either to carry on with the development of airships or to stop altogether.

The development of rigid airships in America for military and naval purposes has, by joint agreement between the War and Navy Departments, been entrusted to the Navy. The question of continuing their development, however, is not altogether a war problem, for airships of all types have probable applications also for commercial purposes. The question, therefore, whether the Navy should continue with the development of rigid airships at this time should not be determined solely upon considerations of their probable naval usefulness. The Army is directly concerned and the commercial development of airships in America may be said to be also at stake. The problem is therefore a national one. Viewed as such, the Navy becomes, in a peculiar sense, the agent of the whole people in the development of rigid airships. In the last analysis, however, it is for the Congress to determine America's policy with regard to continuing the development of airships. As between the two alternatives of carrying on or stopping altogether, the National Advisory Committee for Aeronautics, after careful consideration of the matter, is of the opinion that the development of airships should be continued.

Document 5-2 (i), "Airships," NACA Annual Report (1927), pp. 72-74.

AIRSHIPS

Technical development and present situation.—The technical development of airships continues to lag behind that of airplanes. This is only to be expected in view of the small numbers of airships which are built and the very limited opportunity for development of new ideas and methods of construction which are presented. No new airship construction has been begun in the United States. Attention has been confined to the replacement of parts of existing nonrigid airships.

A design competition was held by the Navy Department looking toward the procurement of the best designs for the 6,000,000-cubic-foot airships which have been authorized by Congress as a part of the Navy Department "five-year aviation program." A number of designs were submitted, among them a very satisfactory one, and negotiations toward a contract for the construction of one airship generally according to this design are under way. This design includes a number of features which, while novel as far as actual incorporation in airships is concerned, have been commonly discussed in that connection for many years.

Experimental investigation and research for the purpose of improving existing airships and providing improved materials and methods of construction for new airships whenever they are begun has continued[,] although at a decreased rate. The satisfactory methods for the protection of duralumin against corrosion and progress made in the obtaining of substitutes for goldbeater's skin fabric are the most notable results.

Work with the "Los Angeles."—The *Los Angeles* has been maintained in splendid condition and undoubtedly has several years of useful and active life before it. It has been used frequently in research on problems connected with the design and operation of rigid airships. One of the most important problems was the determination of the effect on the speed of the airship of fitting water recovery apparatus. For this purpose a series of deceleration tests was carried out on the airship both with and without the water recovery apparatus. The resistance coefficients of the full-sized airship were thus determined and the effect of the added apparatus was accurately determined.

The operating personnel of the *Los Angeles* has been continuously active in the improvement of methods for handling airships on the ground and in and out of the shed. The enlisted and officer personnel engaged in this work have been very highly complimented by persons who have observed the manner in which this airship has been handled by the methods now in use. As a result of study by the personnel at Lakehurst there has been developed a method using a mobile telescopic mast and a large amount of mechanical equipment which it is expected will make it possible to reduce the number of men required for landing and handling the airship to a very

notable degree. This equipment is now being constructed and[,] it is expected[,] will be tested in the coming year.

Work with "RS-1."—This airship has made several notable flights from its home station at Scott Field, including one to Langley Field and Lakehurst. It has been extremely active in spite of the handicap imposed on it by a very heavy power plant.

Steps are now being taken toward the redesign of the power plant, including the substitution of two new engines in place of the four now in use, together with the corresponding simplification and lightening in weight. No reverse gears are to be fitted but the propellers are to be made reversing.

The nose cone originally fitted, having shown indications of weakness, has been replaced by a new nose cone of an improved design which has operated with entire satisfaction. When the proposed modifications have been completed[,] this airship should be very much improved in performance.

Metal-clad airship.—Progress on the design and construction of this airship, which is being supplied to the Navy Department by the Aircraft Development Corporation of Detroit, has been reported.

New mooring masts.—The mooring mast constructed at Scott Field, Belleville, Ill., by the Aircraft Development Corporation has been tried out and found to be very successful. The construction of this type of mast has been found to be very much simpler and to be capable of being carried out with much more rapidity than any previous type. At the same time it affords complete protection to the elevator and pipe lines enclosed within it. It also has a pleasing appearance, being a slender tube much like a smokestack.

Helium.—The Army has acquired an additional helium tank car and further tank cars are being considered by both the Army and the Navy. The savings from the use of these cars are very considerable and it is obvious that the tank cars are a very valuable help in the conservation of the helium supply.

A portable helium purification plant mounted upon railroad cars has been placed in service by the Army Air Corps. With this plant all that is necessary is to connect suitable openings on the car to electric leads, water, and helium lines from the impure helium and to storage. It has operated with great satisfaction and turned out helium of high purity.

A privately owned helium plant has been constructed and is now producing helium at a cost which compares favorably with the cost of helium produced in Government-owned plants. The Navy Department is taking practically the entire production of this plant. The owners propose to increase the capacity of the plant in the near future, which will make available a still greater quantity of helium. This plant draws its supply of gas from a field in Kansas. The supply of helium from this

field will probably be limited but is large enough to be an important factor in the present available supply.

The gas production in the Petrolia field which supplies the Fort Worth plant has been somewhat improved by cleaning out wells. It has been found that many wells were badly filled and by the simple process of attaching orifice meters to each well it has been possible to select the wells to be cleaned. This has led to a very gratifying increase in the amount of raw gas supplied to the plant and a corresponding increase in the production of helium.

However, the necessity for the location of new supplies of helium and the adoption of proper measures for conservation and development still remained. Accordingly, steps have been taken by the Bureau of Mines leading toward the development of a large new field in northwest Texas. This field is practically untouched[,] and if its entire supply can be exploited in an economical manner, as planned, processing all the gas, it is estimated that it contains a quantity of helium-bearing gas amply sufficient to serve the Nation's needs for several generations.

Progress in Great Britain.—Good progress has been made on the construction of the two 5,000,000-cubic-foot airships in Great Britain. These two airships have undergone numerous changes in design as work progressed, but it is understood that they are expected to be ready for flight in the first half of 1928.

The erection of an airship shed at Karachi, India, is well under way, while the mooring masts at Karachi; Ismallia, Egypt; and Cardington, England, are completed.

At the Imperial Conference held in England in October, 1926, emphasis was laid upon the importance of air transport and a system of imperial air-communication. Airships were considered to play an important role in this matter and the data revealed by the report of the air delegates to the conference show that Great Britain has developed her airship program with great care and very thoroughly. An effort was made to interest several of the colonies in the establishment of mooring masts. Apparently Australia, Canada, and South Africa are showing considerable interest in establishing such masts. It was reported that a site for a mast has already been selected in Canada.

Progress in Germany.—The rigid airship having a capacity of about 3,500,000 cubic feet which has been under construction in Germany for the past year is reported to be near completion and may even take the air before the airships which are [being built] in Great Britain.

Progress in Italy.—Information from Italy indicates that the large semirigid airship of about 53,000 cubic meters to which reference was made in last year's report has not been begun, although plans have been prepared for it. Just when its actual construction will be begun appears uncertain.

Standardization of mooring mast equipment.—In view of the probable international character of airship navigation[,] efforts have been made looking toward the standardization of mooring masts. The amount of standardization required is not very great as it would involve primarily the mooring cone and the arrangement and method of operation of the mooring lines. With this accomplished an airship would be able to moor with facility to any mast which it might visit. This effort is still in the preliminary stages but it should lead to valuable results.

Document 5-2 (j), "American Airship Development,"
NACA Annual Report (1928), pp. 17-19.

AMERICAN AIRSHIP DEVELOPMENT

In February, 1928, the question of the Nation's policy regarding the development of rigid airships and the creation of an American rigid-airship industry was pending before the Congress of the United States. There was a difference of opinion at the time as to whether appropriations should be made for the construction for the naval service of rigid airships. On February 16, 1928, Senator Hiram Bingham, of Connecticut, addressed a letter to the committee stating that he would appreciate having the committee answer from the information available the following questions regarding the development and operation of large rigid airships:

1. In the opinion of the National Advisory Committee for Aeronautics, does the present state of the art of constructing and operating large rigid airships justify the belief that such airships can be constructed and operated successfully?

2. What, in the opinion of the committee, are the most practical steps that can be taken at this time to encourage the development of an airship industry in the United States looking toward the promotion of commercial air navigation by rigid airships?

Under date of March 1, 1928, the committee replied to Senator Bingham as follows:

HON. HIRAM BINGHAM,
United States Senate, Washington, D.C.

DEAR SENATOR BINGHAM: Your letter dated February 16, 1928, making certain inquiries as to the opinion of the National Advisory Committee for Aeronautics with reference to the construction and operation of rigid airships and the development of an airship industry in the United States, was considered at a meeting of the executive committee held March 1, 1928, and the following resolutions were adopted:

Resolved, That it is the opinion of the National Advisory Committee for Aeronautics that the present state of the art of constructing and operating large

rigid airships has progressed to the point where we are justified in believing that large rigid airships can be constructed and operated successfully.

Resolved further, That it is the opinion of the National Advisory Committee for Aeronautics that the most practical step to be taken at the present time to encourage the development of an airship industry in the United States is to begin the construction of the airships authorized under the 5-year aircraft building program. The construction of these airships will foster the development of an airship industry, and this, with the knowledge to be acquired from experience in the operation of airships, will be necessary in order to enable the United States to meet the needs for commercial airship construction and operation when they arise.

The committee appends hereto a memorandum entitled "The Present Status of the Development of Rigid Airships in the United States," which states the facts on which its opinion is based.

Sincerely yours,

NATIONAL ADVISORY COMMITTEE FOR AERONAUTICS,
JOSEPH S. AMES, *Chairman*.

The memorandum enclosed with the committee's letter follows:

THE PRESENT STATUS OF THE DEVELOPMENT OF RIGID AIRSHIPS IN THE UNITED STATES

CONSTRUCTION

No rigid airship has been built in this country since the *Shenandoah* was completed in 1923, but theoretical studies, research and practical tests have continued so that ultimately additional rigid airships might be designed and built in the United States. As a result, the United States is today as fully abreast of rigid airship development as could be expected without actual construction since 1923.

The *Shenandoah* was a remodeled copy of a 1916 German design and, when completed, was recognized as an admirable first American effort rather than as a modern rigid airship. The necessity for providing suitable materials for the *Shenandoah* led to the further development of aluminum alloys and brought to the United States expert talent who knew how to manufacture gas cells. Additional technical experts were brought to this country who were familiar with rigid airship fabrication, erection, and operation. Original thought and effort were expended along various lines connected with theoretical design, with the result that in spite of meager information as to the prototype[,] the design of the *Shenandoah* was placed upon a sound basis. A special subcommittee of the National Advisory Committee for Aeronautics checked the design and found it reasonable. Recent information confirms this opinion.

The *Shenandoah* was operated successfully by the Navy for two years. Her operation proved the practicability of mooring masts ashore and afloat. She made

a number of notable flights, including one of 9,000 miles to the west coast and return, during which she was based entirely on mooring masts for 21 days. A noteworthy flight resulted from a breakaway from the mooring mast. During this she weathered a gale in a badly damaged condition. The fact that she was finally caught in an unusually severe storm and succumbed to it is no reason to condemn her as an airship—much less to condemn airships in general. Engineering history is full of instances where final success has been reached only through lessons learned in early attempts.

The acquirement in 1924 of the *Los Angeles*, as an example of modern German airship construction, was an important step in airship development in the United States. With the *Los Angeles* there came much information about questions hitherto obscure. Shortly after the *Los Angeles* arrived[,] there was brought to this country a group of the most experienced rigid airship engineers. They still remain and represent the quarter of a century of Germany's experience in airship design and construction.

The United States began its experience with rigid airships nearly 10 years ago, and the present "state of the art" may be summarized as follows: One rigid airship was built and operated successfully; another was acquired and is still being operated successfully; much thought and effort have been applied to engineering problems connected with airships; technical personnel familiar with airship matters are available, including those self-trained in the United States; the technical knowledge and experience available in the United States for the design and construction of rigid airships is ample; satisfactory materials are available, notable examples being aluminum alloys, steel wire, cotton cloths, gas-cell materials of various kinds, engines, and power plant equipment, including water-recovery apparatus; promising development of oil-burning engines is under way; and helium, available only in the United States, gives to American airships a unique measure of safety.

From a technical standpoint it is believed the United States is prepared to design and build rigid airships to any required degree of engineering exactitude. American ingenuity and production methods applied to airship construction will cheapen their cost and offset the present high cost differential between American and foreign airships.

OPERATION

The successful operation of rigid airships depends on two factors[:] (a) trained personnel and (b) facilities available, which include weather information service. Operation is also a matter of experience. Although our experience is not as wide as that possessed by the Germans or English, it is more recent.

The American personnel engaged in rigid airship operation [are] the equal of any. They have been largely self-taught, but the foundation of the training was sound and embodied the best of German and British experiences, adapted to American conditions and to helium operation. As only one rigid airship has been in

operation at a time, competitive effort has not been possible. Development would be faster if more rigid airships were available. The large cost of rigid airships and the fact that only one is now available forced a cautious, conservative scheme of operation which, though sound, has not as yet allowed the technique of rigid airship operation to develop to the full extent of its possibilities. This situation will correct itself when more airships and better facilities are available.

The facilities for the operation of rigid airships in the United States are not the best and additional facilities are needed. There are only two large sheds—at Lakehurst and at Scott Field. The former in particular is poorly located from a meteorological standpoint. The shortage of helium and meager facilities for its transportation and storage have retarded the operation of rigid airships at intervals. Several mooring masts have been erected at strategic points, but the masts remote from the shed base have been used only once.

Arrangements and mechanical appliances for landing airships and handling them on the ground, and in or out of sheds, are being improved with experience. As a result we should be prepared to handle the larger airships now contemplated with no more difficulty, and perhaps with less difficulty, than airships of the *Los Angeles* size. There has been gratifying progress in developing the floating mast, the fixed stub mast, the mobile stub mast, mechanically operated docking trolleys, cars for supporting airships while moving in and out of sheds, [an] artificial superheat device, remote control for hauling down winches and the deck landing platform.

The operation of airships, like airplanes, is influenced by weather conditions and will be facilitated by improved weather information service. A new system for the collection and distribution of weather reports has recently been worked out by the Weather Bureau in cooperation with the telegraph companies. This will much facilitate the prompt furnishing of aerological information so necessary for the safe navigation of the air.

FOREIGN DEVELOPMENT

No survey of rigid airship development would be complete without a résumé of what is being done by other nations.

Germany, the original home of the rigid airship, and where it finds most enthusiastic support, is just completing a 3,650,000 cubic foot airship, funds for which were raised largely by popular subscription. It is proposed that this airship, after making demonstration flights, including one to the United States, will be used to start a commercial line between Spain and South America. The design is a modern and enlarged copy of the *Los Angeles*. This airship will carry a large portion of its fuel in gaseous form. This permits an important increase in cruising range. This development is being watched with interest[,] and a combination of helium and a fuel gas offers attractive possibilities without much greater risk than with helium alone and gasoline.

Great Britain, after abandoning airships for the sake of economy in 1919 and after being confirmed in her anti-airship convictions by the *R-38* disaster in 1921, executed an about face in 1923 and resumed the construction of rigid airships. Great Britain now believes airships will play an important role in linking up her outlying possessions.

Two rigid airships of 5,000,000 cubic foot volume and using hydrogen are nearly completed. One of these is being built by the Air Ministry, the other by the Airship Guarantee Co., a subsidiary of Vickers (Ltd.). From all information available the designs appear to be on a sound basis and there is no reason to doubt their success. The Airship Guarantee Co. uses a novel and ingenious type of girder which promises to simplify and cheapen the structural parts of an airship. The Air Ministry airship will use [a] considerable [amount of] alloy steel. Oil-burning engines are proposed for both airships, but they are not yet sufficiently developed to be pronounced satisfactory. Each airship is fitted with accommodations for about 100 passengers and both are intended for quasi-subsidized commercial service to India.

Great Britain has five shed berths for large rigid airships. A new shed has been erected in India and one shed in England is being enlarged. Mooring masts have been built in England, India, and Egypt. Other masts are contemplated in Canada, Australia, and South Africa.

At least one of these British airships is expected to visit the United States during the summer of 1928.

France has several sheds suitable for large rigid airships, but probably for reasons of economy has not built such craft. Designs are available and she contents herself with trying to keep abreast of development without building or operation.

Italy still operates the small rigid airship *Esperia* delivered to her in 1922 by Germany. Italy's own airship efforts, however, are concentrated on developing the semirigid type, which satisfies her geographic requirements. An enlargement of the *Norge* type is under construction. In her chosen field of moderate sized airships Italy has developed a superior technique of design, construction, and operation.

The answer of the committee to Senator Bingham's inquiry was published in the Congressional Record of March 9, 1928. Subsequently the Congress made appropriation for the construction of two large rigid airships, and construction has actually begun on the contracts executed by the Navy Department with the Goodyear-Zeppelin Corporation, Akron, Ohio. This step marks the beginning of a rigid-airship industry in the United States, and without doubt will lead to material progress in the design, construction, and use of rigid airships.

Document 5-2 (k), "Airships," NACA Annual Report (1929), p. 85.

The placing of a contract for the building of two 6,500,000 cubic foot airships for the Navy Department in October, 1928, was a definite step in the resumption of airship building in the United States and a step toward the creation of an airship industry in the United States. Progress on design has proceeded at a normal rate. Fabrication of parts has begun. The keel ring of the first of these airships was laid on November 7, 1929. The first of these airships is due for completion in 1931, the second in 1932.

The Goodyear-Zeppelin Corporation, of Akron, Ohio, the contractor for the airships ZRS-4 and ZRS-5, has practically completed the airship shed in which the airships are to be erected. The shed is 1,175 feet long, 325 [feet] wide, and 180 feet high. In the design of the shed the operating experience of the past four years has been carefully considered and the type of design is thought to be much superior to any types that have as yet been built.

Experimental investigation and research on the development of improved materials for airships have been continued.

Experimental flight operations have been continued with the *Los Angeles*. Improvements in water-recovery apparatus have been accomplished. Carrying, launching, and recovering service type airplanes have been accomplished in a more comprehensive manner than heretofore. This work is preliminary to the design of apparatus for use with the Navy Department's new airships.

Development of improved methods of mechanical aid to the handling of rigid airships has been continued. The mobile mooring mast is a reasonabl[y] satisfactory piece of equipment and is helpful in the handling of airships. Further improvements in this mast are in contemplation and should increase its utility. No difficulties have been encountered in the use of the stub mooring mast as a riding point for an airship. As yet the problem of making a flying moor to the stub type of mast has not been satisfactorily solved.

The metal-clad airship.—The Aircraft Development Corporation has completed and delivered the metal-clad airship, ZMC-2. The airship has successfully completed its flight trials. The Navy Department has placed the airship in service at the naval air station at Lakehurst, where further tests will be made to obtain more comprehensive data as to the performance and general utility of this type of airship construction.

Helium.—The new Government plant near Amarillo, Tex., has been placed in operation, making available increased quantities of helium, and with the increase in production lower costs for the helium are being quoted.

A commercial company which has been producing helium for airships announces the discovery of a new field containing a natural gas with over 6 percent

helium, a very much larger percentage than that in any gas hitherto available in production quantities. This concern has moved the major portion of its plant to this new source of helium-bearing gas.

The Navy Department purchased a new type of helium tank car which carries the helium in 28 seamless drawn pipes instead of three forged cylinders. The cost of this type of car is materially less than the cost of a car carrying forged cylinders.

Progress in Germany.—The around-the-world flight of the *Graf Zeppelin* was an outstanding achievement in airship operation.

Progress in Great Britain.—After many delays the British airship R.101 had made several flights. The second British airship, R.100, is practically complete and ready for flight trials.

Document 5-2 (I), "Airship Investigations,"
NACA Annual Report (1929), pp. 30-32.

Airship investigations.—The aerodynamic efficiency of an airship is evidently dependent on careful design, not only of the hull and control car, but also of the control surfaces. Some further work has been done during the year in connection with flight tests previously made on the U.S.S. *Los Angeles*. Data obtained in speed and deceleration tests have been prepared for publication. A report covering the pressure distribution on the hull and tail surfaces, and a report covering the investigations to determine the drag of the airship with and without water-recovery apparatus, have been published. Speed and deceleration tests for the purpose of determining the drag of a small commercial type airship have been carried out in conjunction with the Goodyear-Zeppelin Corporation, and apparatus is now being assembled for similar tests on a TC airship and on a small service type airship.

The variable-density wind tunnel and the propeller research tunnel both offer facilities for making model tests on airships at higher Reynolds Number than can be conducted in other tunnels. This fact has led to a series of tests now in progress in the variable-density wind tunnel on a model of the ZRS-4 airship and preparation for tests on a large model in the propeller research tunnel. The tests in the variable-density tunnel have consisted of lift, drag, and pitching-moment measurements of the ZRS-4 model in comparison with a model of lower fineness ratio. The tests are being made with and without a control car. It is planned in the propeller research tunnel to measure the pressure distribution over the hull of the airship model, its lift and drag at various angles of pitch, and at the same time to measure the forces and moments exerted on the elevator hinge.

Miscellaneous investigations of particular interest in connection with airship work have included some preliminary studies on gusts and also on the use of a Friez type cup anemometer for measuring the velocity of a gusty wind.

Developments in Equipment.—It is constantly necessary to make improvements in the equipment of the laboratory and to add new pieces of equipment, if the work i[s] to keep up with the advancement of the art. In connection with the work of the atmospheric wind tunnel, there had been developed an integrating manometer for use in pressure-distribution measurements. By means of a number of tubes of different cross-sectional area connecting with a common reservoir, the chord load at any particular wing section is integrated automatically and is thus measured by means of a single liquid column. This manometer has saved considerable labor in the working up of the results of pressure-distribution tests.

The balance of the variable-density wind tunnel as rebuilt is similar in principle to the old balance, but differs in some minor details. It consists of a cradle of structural steel which surrounds the lower half of the air stream and which is suspended by rods from balance beams which are visible through peepholes in the outer shell. The model is rigidly fastened to the cradle by vertical struts which are protected from the air stream as far as possible by fairings. The sliding weights on the beams, as well as coarse weights which are carried on bridges, are operated by electric motors with control switches on the outside.

It has been found possible during the past year to improve the operation of the tunnel in a number of ways. An objectionable vibration, which at times resulted in damage to the knife edges, has been greatly reduced by mounting the structure supporting the balance on rubber shock absorbers similar to those used in mounting certain aircraft engines.

A slight twist, which was found to exist in the air stream, was eliminated by installing longitudinal deflectors in the return passage, and the velocity distribution at the test section was improved by introducing resistance at certain parts of the cross section by the attachment of wire mesh to the honeycomb.

The reduction in turbulence in the new tunnel as compared to the old was effectively demonstrated by means of a series of sphere tests, a report of which has been published. The[s]e tests also served to substantiate the principle upon which the variable-density tunnel is based, since it was found possible to obtain the same drag at a given Reynolds Number whether obtained by varying the density, velocity, or sphere size.

The only alteration made in the propeller research tunnel has been in the installation of a dial type scale for the drag balance in place of the ordinary beam type previously used. This eliminates the delay formerly experienced in getting this scale in balance before each reading.

A small water channel has been found useful for studying the flow along surfaces of various contour and through model entrance and exit cones. The channel is 8 inches wide and the character of flow about a body is made visible by scattering aluminum dust on the surface of the water.

A small water tunnel having a 2½-inch throat diameter in which a speed of 45 feet per second may be obtained has been found useful for studying cavitation on

airfoils of various shape[s]. A 5-stage turbine type pump was developed for circulating the water. This has the advantage that the water can be circulated at high speed without the milky appearance which resulted from cavitation when a single driving propeller was used.

Development work on the high-speed tunnel has progressed somewhat slowly as tests are made only when the pressure in the variable-density tunnel is being reduced to 1 atmosphere. Experiments have been made with different designs of open and closed throat and with vanes for preventing twisting of the air stream. It has been possible to obtain an air speed of 1,290 feet per second in a throat 12 inches in diameter, and it has also been possible, by the use of optically recording diaphragm type manometers similar in principle to these used in flight tests, to record the pressure distribution on an airfoil section and at the same time the dynamic pressure. A balance has been designed for this tunnel, and this is now under construction. It will be possible with this balance to measure the lift, drag, and pitching moment of an airfoil which will be mounted in the stream passing directly through from one side to the other. The balance consists of a forked member which holds the two ends of the airfoil and provides means for changing the angle of attack. The aerodynamic forces are made to deflect steel beams and the deflection is recorded optically on a photographic film. Timing lines will be provided by a timer, which is standard equipment in connection with the instruments at this laboratory. Another curve on the same film will indicate the dynamic pressure in the air stream.

In connection with the design of the full-scale wing tunnel, mentioned earlier in this report, considerable study has been given to the effect of varying the shape of the entrance and exit cones of open-throat tunnels in order to determine whether it is practical to use an elongated jet, and thus make possible the testing of an airplane of large span without too great a cross-sectional area at the throat. A series of tests was carried out on a number of different shapes of entrance and exit cones in the atmospheric wind tunnel. In each pair of cones three airfoils were tested having dimensions of 3 inches by 15 inches, 4 inches by 20 inches, and 5 inches by 25 inches. Force tests were made in order to determine the effect of the change of shape of the air stream. The series consisted first of a circular cone; second, a rectangular one having a ratio of height to width of 1 to the square root of 2; third, one of the same proportions having semicircular ends; and fourth, one similar to the above having the ratio of height to width of 1 to 2. The Prandtl correction was found to apply to the circular cone, and it was found possible to derive corrections for the other cones to give the same results. A report covering this work is in preparation.

It has been decided to adopt the fourth shape of throat mentioned above, for the full-scale tunnel—that is, one having a ratio of height to width of 1 to 2 and having semicircular ends. The height of the jet will be 30 feet and the width 60 feet. A scale model of the proposed tunnel has been built and tests are in progress to study such questions as energy ratio and air-flow conditions.

The development of flight research methods and the consequent necessity for increased accuracy of measurements have called for greater refinement in the recording instruments used in flight research. Laboratory tests are being conducted almost continuously on the instruments to reduce errors caused by mechanical friction and time lag in the parts, changes in the viscosity of the damping oil, lack of balance of moving parts, etc. This work is particularly necessary for instruments used in accelerated flight, and a considerable portion of this work has been concerned with the angular-velocity recorders and recording accelerometers. For investigations where measurements must be made in a very short period of time, such as when impact loads are measured, it has been necessary to greatly increase the film speed. A new electric motor has been constructed for driving the film in order to obtain more driving torque without increasing the size or weight of the motor, and this, together with a new low-friction dynamically balanced film drum, has given speeds approximately ten times those obtainable with the standard motor and drum. A control force recorder suitable for recording stick forces in accelerated and level flight has been designed and constructed during the year and is now being tested.

Document 5-2 (m), "Airships," NACA Annual Report (1931), pp. 65-66.

Airship progress during the past year has been marked by one outstanding event, namely, the completion and satisfactory trials of the U.S.S. *Akron*. This airship of 6,500,000 cubic feet volume (helium) was contracted for by the Navy Department in October, 1928; erection of frames was started in November, 1929; and the airship was completed and ready for trials in September, 1931. Trial flights amounting to approximately 100 hours were successfully carried out within a period of four weeks and the airship was thereupon accepted by the Navy Department and commissioned as a United States naval airship.

The U.S.S. *Akron* represents a complete new design of airship conceived and built entirely within the United States. This fact is significant because it means the establishment within the borders of the United States of an industry capable of meeting probabl[e] demands, military or commercial, as to construction of airships.

The design of the U.S.S. *Akron* embodies a number of features which either are entirely new, or are new in their present form, to airship construction. Some of the more important of these features are:

- A somewhat lower fineness ratio than used in former practice.
- Inherently stiff main frames as compared with the wire type of main frames heretofore used.
- Easier and better access to all parts of the interior of the airship for inspection purposes and to facilitate repairs in flight.
- An internal hangar for housing airplanes.
- The elimination of the pendant external power cars in favor of internal engine rooms.

- An “in-line” arrangement of propellers, four propellers on each side.
- Propellers suspended from outrigger struts with means for tilting each propeller through an angle of 90°. This provision for tilting combined with the reversibility of the airship engines gives the possibility of obtaining thrust in four directions.
- The provision of a transmission shaft between engine and propeller, the design of this transmission shaft being unique in aeronautical practice.
- The provision of a “skin-type” condenser for water-recovery apparatus.
- The use of improved type of fabric for gas-cell construction and the abandonment of the gold-beater’s-skin type of fabric heretofore used.
- The use of combined automatic and manually operated gas valves.
- The use of resilient-wire bulkheads for checking the surging of gas cells in case one is deflated.
- The use of special materials in the construction of the airship, notably an aluminum alloy which has been subjected to a slight degree of cold rolling after heat treatment, thereby raising the yield point of the material at the expense of a slight reduction in elongation; and special high-strength hard-steel wire galvanized before the last drawing operation.
- Special attention to protection of all metal parts against corrosion.
- Increased strength factors.

The final results from the trial flights of the U.S.S. *Akron* have not been completely evaluated, but enough has been learned to warrant the belief that the airship design is fundamentally sound. A new set of propellers will be required before the maximum possible speed of the airship can be attained.

The second airship included in the airship program of the Navy Department, for which contract was made at the same time as that for the U.S.S. *Akron*, is scheduled for completion about January, 1933.

The material condition of the U.S.S. *Los Angeles*, as revealed by periodic inspection and check tests of representative samples, continues to be satisfactory.

Operations of small airships of the nonrigid type have been continued by the Army, the Navy, and by private interests. The performance of these airships in several instances has been noteworthy.

The small experimental metal-clad airship owned by the Navy Department has been successfully operated during the past year. Measurements have shown that superheat is created and lost very rapidly in this type of airship. Tests of samples removed from the hull plating of the airship showed practically no deterioration in the thin metal hull covering after 18 months’ operation.

Excellent progress has been made in mechanical ground-handling methods for large rigid airships and warrants the assertion that a satisfactory solution to this important problem is close at hand. The troublesome feature of how to haul the stern of an airship broadside to the wind and hold it there has apparently been solved. A circular railroad track with its center located on the shed axis extended

serves as a "turning basin." A long[,] low steel beam mounted on wheels is used to support the stern of the airship, while side guys leading from near the axis of the airship to the ends of the beam serve to restrain the airship against side forces. With the airship thus secured to the stern beam, a powerful locomotive of special design hauls the stern beam around the circular railroad track as desired. When the airship is to be moved in or out of the shed, a second set of wheels mounted on the stern beam is brought into play, and the airship, with stern beam attached, is moved by a mobile mooring mast at the bow along straight lines of railroad track into the shed. Other pieces of mechanical apparatus, notably winches, yaw-guy anchorages, and mooring-masthead mechanisms, have undergone improvements during the year.

The Government helium plant near Amarillo, Tex., continues to supply increasing quantities of helium at progressively decreasing costs. The problems of repurification of helium which has become contaminated with hydrogen or with a hydrocarbon fuel gas, are being given careful study. An experimental order has been placed for a new type of helium purity meter which, if successful, should greatly facilitate the taking of helium readings. The instrument is of such type that it can be applied to each individual cell in a rigid airship and will give a continuous record of helium purities.

Document 5-2 (n), "Airships," NACA Annual Report (1932), pp. 59-60.

Research with full-size airships has been confined largely to the evaluation and study of data obtained in the trial flights with the U.S. airship *Akron*. These data have furnished much valuable and interesting information concerning the behavior of and forces on large airships under varied flight conditions. The measurements of over-all drag and local pressures on the hull and tail surfaces not only provide data of direct importance in connection with this particular airship but they also serve the general purpose of providing a basis for determining the applicability of data obtained with models.

Through research with models, considerable progress has been made in studies concerning two major aspects of the problem of airship drag. Theories regarding the laws of frictional resistance on streamline shapes have been correlated with the results of an investigation of the boundary layer on a $\frac{1}{40}$ -scale model of the U.S. airship *Akron* and have been found to be in good agreement with fact for the range of scales attainable in the wind tunnel used in the investigation. Interference drag caused by protuberances in contact with airship shapes has been studied in the variable-density wind tunnel. In this wind tunnel the large scales attainable give fair assurance that the comparative results are free from the effect of critical changes in the nature of the boundary layer on the model and, consequently, are believed to be applicable to full-size airships. This wind tunnel is now engaged in a research concerning the effect of shape on airship drag.

The four-in-line tandem arrangement of propellers in the *Akron* has brought to light a number of problems connected with this propulsive system. Owing to wandering of the propeller slipstreams as they flow aft because of gusts and undulations of the airship, widely differing over-all propulsive efficiencies are obtained when different combinations of propellers are operating. This makes it difficult to provide a type of propeller that will be efficient over the wide range of airship speeds. The present wooden propellers on the *Akron* are to be replaced by metal propellers of changeable pitch, and the expectation is that with these propellers more efficient propulsion at normal cruising speeds will be obtained.

A satisfactory apparatus for recovering water ballast from the engine exhaust, thus permitting helium-filled airships to maintain equilibrium in flight without valving gas, continues to prove a baffling problem. The problem is one peculiar to helium-filled airships. In the *Akron* the difficulties of the problem have been accentuated by the necessity for using tetraethyl lead in the fuel which engenders corrosion in parts of the recovery apparatus. A new type of light and compact water-ballast-recovery apparatus has been developed at Lakehurst and applied experimentally to the *Akron*. Fundamentally, it is similar to a large honeycomb radiator. The cooling air passes through the tubes, and the exhaust gases flow around them within a streamline[d] casing. The drag of this type will be somewhat higher than previous types, but its weight will be materially less and its maintenance simpler.

The power plant of an airship and its installation present a number of problems for which various solutions can be obtained, and upon the solution adopted will depend the efficiency, economy, safety, and reliability of the airship operation. It is desirable, therefore, that research along various lines connected with improvements in airship power plants be prosecuted vigorously, both in laboratories and under flight conditions. Various improvements in airship power plants are under development in the United States and elsewhere.

The *Akron* is the first airship in the world to be equipped with a hangar for carrying airplanes. Hitherto airplanes have been attached to or dropped from an external trapeze on an airship, but the operation of airplanes to and from the *Akron* has become routine. Four airplanes may be stowed in the hangar and a fifth one, carried on the trapeze, may also be lifted into the hangar. New developments are under way to decrease the time interval between launching or picking up successive airplanes.

The U.S. airship *Los Angeles* has been laid up as a matter of economy, but her material condition is still good, after nearly eight years' service, and she could be recommissioned on short notice.

The experimental metal-clad airship ZMC-2 continues in successful operation. She has been deflated and reinflated only once during three years of service.

In the field of mechanical handling of airships, the Navy Department has continued to make good progress. The stern handling beam described in last year's report has been found invaluable in taking the U.S. airship *Akron* in and out of the hangar at Lakehurst. A special wind-tunnel investigation into the forces acting on

an airship when being handled near the ground has been planned for early conduct by the committee at Langley Field.

Document 5-2 (o), Excerpts from Annual Report of the National Advisory Committee for Aeronautics (Washington, DC), 1920–36. “Airships,” Annual Report (1933), p. 15.

Airship work has been confined to some miscellaneous activities such as cooperation with the Army in speed trials with the *TC-11* and *TC-13* airships, cooperation with the Navy in speed and deceleration tests with the U.S. airship *Macon*, and the emplification [*sic*] of previous reports to the Navy giving data obtained in the trial flights with the U.S. airship *Akron*.

Document 5-2 (p), “Lighter-Than-Air Craft,” NACA Annual Report (1934), p. 2.

Lighter-than-air craft.—An inquiry was propounded by the Federal Aviation Commission, to which this Committee replied, as follows:

Inquiry: “What special action should be taken to promote the development of intercontinental services by airplane or airship, or both, and their coordination with merchant marine policy?”

Reply: “In order to develop further the possibilities of lighter-than-air craft, it is believed advisable for the Federal Government to provide funds for the construction of two experimental rigid airships for intercontinental service. It is believed advisable also for the Government to encourage the private development and operation of large seaplanes for transoceanic and intercontinental air transportation.

“This Committee believes that it would be more economical to provide fast intercontinental transportation by the use of airships and large seaplanes than to engage in the competition which is now taking place among the nations of Europe in the building of high-speed superships for their merchant marine.”

Document 5-2 (q), “Airships,” NACA Annual Report (1934), p. 17.

The work during the past year has consisted chiefly in cooperation with the Army in tests of the *TC-13* airship. Accelerations in the control car during heavy take-offs and measurements of the rudder-cable tension have been made. Data previously obtained in the full-scale pressure distribution tests on the U.S. airship *Akron* are being analyzed and assembled for the preparation of a report.

Document 5-2 (r), "Airships," NACA Annual Report (1935), p. 16.

At the request of the Bureau of Yards and Docks, Navy Department, the wind pressures on a $\frac{1}{40}$ -scale model of the Lakehurst airship hangar were determined in the full-scale wind tunnel with the hangar mounted on a ground board and yawed 0° , 30° , 60° , and 90° to the wind. A screen was employed in the entrance cone of the tunnel to produce a wind gradient comparable with that previously measured in the vicinity of the landing space at Langley Field. In addition to the wind pressures on the hangar, a survey of the air velocity in its wake and a general study of the air flow about the hangar by means of smoke-flow photographs were made.

In order to determine the forces acting on an airship during handling while in proximity to the ground, an investigation was made in the full-scale wind tunnel on a $\frac{1}{40}$ -scale model of the U.S. airship *Akron* in which the lift, the drag, the cross-wind forces, and the moments about the three axes were measured with the model at four different heights above a ground board and at each height yawed 0° , 30° , 60° , 90° , 150° , and 180° to the wind. In addition to the force measurements, photographs of smoke flow were made for each condition of yaw at one height. The wind gradient that was produced for the investigation of the wind pressures on a hangar was used.

Document 5-2 (s), "Airships," NACA Annual Report (1936), p. 17.

At the request of the Bureau of Aeronautics of the Navy, a series of investigations was made in the 20-foot wind tunnel on a $\frac{1}{40}$ -scale model of the airships ZRS-4 and ZRS-5 with the object of determining:

1. the effect of the aspect ratio of the fins on the aerodynamic forces and load distribution over them;
2. the effect of fins of various aspect ratios on the pressure distribution on the hull near the tail surfaces;
3. the effect on the pressure distribution on the fin of slots between the fin and the hull; and
4. the pressure distribution on the fin when the airship was in various angles of yaw and pitch as high as approximately 24° . A supplementary investigation on the same model has been made for the purpose of determining the effect of bow elevators on the resistance and controllability in pitch of an airship. Reports on these projects are in preparation.

Theoretical studies have indicated that considerable decrease in the drag of an airship should result by proper control of the boundary layer. An investigation to be conducted in the 20-foot tunnel on the application of boundary-layer control to airships has been initiated. The models and apparatus required are now being constructed.

Document 5-3

“Reports from the NACA Subcommittee on Airships,” in *Annual Report of the National Advisory Committee for Aeronautics* (Washington, DC), 1929–38.

The NACA’s Aerodynamics Committee created a Subcommittee on Airships in 1927. Edward P. Warner, the distinguished editor of *Aviation* magazine, served as its chair until 1937. He was followed by the Massachusetts Institute of Technology’s (MIT’s) Jerome C. Hunsaker, who headed the subcommittee until it was abolished in 1940.

Each year in the *NACA Annual Report*, this subcommittee reported on its business. Provided below are the reports for 1929, 1930, 1931, 1932, 1933, 1935, 1936, 1937, and 1938, the last of which included a reference to the Hindenburg disaster. Although the Subcommittee on Airships would live on until 1940, there would be no reports from it published in the *NACA Annual Report* for 1939 or for 1940—an indication of the public disfavor for airships following the fiery demise of the great German zeppelin. This is not to say that there were not people in the NACA or in the wider American aeronautics community who remained committed to airships. In a letter to the Bureau of the Budget in 1948, the NACA’s executive secretary, John F. Victory, advised that airships still had great promise and were still far from their “zenith” (*Model Research I*: 127). To those convinced that airships had already become dinosaurs, Victory’s perspective might seem archaic. But given the refinement of airship technology that actually took place in the second half of the 20th century—albeit with nonrigids—one is not so sure today about labeling Victory’s view as silly or nostalgic.

*Document 5-3, “Reports from the NACA Subcommittee
on Airships,” in Annual Report of the National Advisory
Committee for Aeronautics (Washington, DC), 1929–38.*

AR 1929 SUBCOMMITTEE ON AIRSHIPS

In order that the committee on aerodynamics may be kept in close touch with the latest developments in the field of airship design and construction, and that research on lighter-than-air craft may be fostered and encouraged, a subcommittee on airships has been organized under the committee on aerodynamics, the membership of which is as follows:

Hon. Edward P. Warner, editor of *Aviation*, chairman.

Starr Truscott, National Advisory Committee for Aeronautics, vice chairman.

Dr. Karl Arnstein, Goodyear-Zeppelin Corporation.

Commander Garland Fulton (C.C.), United States Navy.

George W. Lewis, National Advisory Committee for Aeronautics (ex officio member).

Capt. Edgar P. Sorenson, United States Army, materiel division, Air Corps, Wright Field.

Ralph H. Upson, Red Bank, N.J.

During the past year the subcommittee on airships presented recommendations for two investigations on airship models to be conducted in the propeller research tunnel at the Langley Memorial Aeronautical Laboratory, both of which have been added to the committee's program. These two investigations were the study of the effect of appendages on airship hulls, including tests of an airship model about 40 inches in diameter with different protrusions, such as water-recovery apparatus, cars, propeller mountings, fins, and rudders of different contours; and the study of the forces on an airship entering a hangar, including the construction of models of two types of hangars and the measurement of the forces and moments on an airship model in various positions with respect to the hangar and the direction of the wind stream.

The subcommittee has continued the consideration of problems of atmospheric structure as affecting airship operation, particularly vertical air currents and gustiness, and is cooperating with the subcommittee on meteorological problems of the committee on problems of air navigation in the study of this subject.

AR 1930 SUBCOMMITTEE ON AIRSHIPS

In order that the committee on aerodynamics may be kept in close touch with the latest developments in the field of airship design and construction and that research on lighter-than-air craft may be fostered and encouraged, a subcommittee on airships has been organized under the committee on aerodynamics, the membership of which is as follows:

Hon. Edward P. Warner, editor of "Aviation," chairman.

Starr Truscott, National Advisory Committee for Aeronautics, vice chairman.

Dr. Karl Arnstein, Goodyear-Zeppelin Corporation.

Capt. Karl S. Axtater, United States Army, materiel division, Air Corps, Wright Field.

Commander Garland Fulton (C.C.), United States Navy.

George W. Lewis, National Advisory Committee for Aeronautics (ex officio member).

Ralph H. Upson, Red Bank, N.J.

During the past year the subcommittee on airships has kept in touch with the progress of airship investigations on the program of the committee's laboratory at Langley Field. These investigations are the study of airship forms, and especially of airship appendages, in the variable-density wind tunnel, including the determination of the drag, cross-wind forces, and moments at various angles of pitch and yaw and different rudder and elevator settings on a model of the ZRS-4 airship; the investigation in the 20-foot wind tunnel of the effect of appendages on airship hulls, including tests of an airship model about 40 inches in diameter with various protrusions, such as water-recovery apparatus, cars, propeller mountings, fins, and rudders of different contours; the study of the forces on an airship entering a hangar, including the construction of models of two types of hangars and the measurement of the forces and moments on an airship model in various positions with respect to the hangar and the direction of the wind stream; and the investigation in flight of deceleration on the metal-clad airship ZMC-2 to determine its drag characteristics.

As the subject of the structure of the atmosphere, especially vertical air currents and gustiness, is of particular importance in connection with the operation of airships, the subcommittee has continued its consideration of these problems with the cooperation of the subcommittee on meteorological problems of the committee on problems of air navigation.

AR 1931 SUBCOMMITTEE ON AIRSHIPS

In order that the committee on aerodynamics may be kept in close touch with the latest developments in the field of airship design and construction and that research on lighter-than-air craft may be fostered and encouraged, a subcommittee on airships has been organized under the committee on aerodynamics, the membership of which is as follows:

Hon. Edward P. Warner, editor of "Aviation," chairman.

Starr Truscott, National Advisory Committee for Aeronautics, vice chairman.

Dr. Karl Arnstein, Goodyear-Zeppelin Corporation.

Capt. Karl S. Axtater, United States Army, materiel division, Air Corps, Wright Field.

Commander Garland Fulton (C.C.), United States Navy.

George W. Lewis, National Advisory Committee for Aeronautics (ex officio member).

Ralph H. Upson, Dearborn, Mich.

The subcommittee on airships has kept in close touch during the past year with the investigations conducted at the Langley Memorial Aeronautical Laboratory on models of the U.S.S. *Akron*. At a meeting of the subcommittee held on January 10, 1931, preliminary results obtained in the variable-density tunnel on a 1/200-scale model of the airship were presented and discussed, and details of the program of

further tests, both in this tunnel and on a larger model in the propeller-research tunnel, were decided upon and action taken to expedite these tests in view of the importance of the results in connection with the design of the full-size airship. At this meeting there was also discussion of tests in the variable-density tunnel on a model of a proposed large metal-clad airship and of the problem of the ground handling of airships.

At a special meeting of the subcommittee on airships held on May 27 at the Langley Memorial Aeronautical Laboratory in connection with the sixth annual aircraft engineering research conference, results were presented from the tests in the propeller research tunnel on a $\frac{1}{40}$ -scale model of the *Akron*, including hinge moments and forces on the model for various angles of rudder setting and various angles of attack, the rudder being equipped with balancing vanes. Details of further tests to obtain the information most needed in connection with the completion of the full-size airship were agreed upon.

The subcommittee on airships has also cooperated with the subcommittee on meteorological problems of the committee on problems of air navigation in connection with the study of wind gustiness. A joint meeting of the two subcommittees for the discussion of this problem was held on January 10, 1931.

AR 1932 SUBCOMMITTEE ON AIRSHIPS

The present organization of the subcommittee on airships is as follows:

Hon. Edward P. Warner, editor of "Aviation," chairman.

Starr Truscott, National Advisory Committee for Aeronautics, vice chairman.

Dr. Karl Arnstein, Goodyear-Zeppelin Corporation.

Commander Garland Fulton (C.C.)[,] United States Navy.

Maj. William E. Kepner, United States Army, materiel division, Air Corps, Wright Field.

George W. Lewis, National Advisory Committee for Aeronautics (ex officio member).

Ralph H. Upson, Ann Arbor, Mich.

The subcommittee on airships has kept in close touch with the airship investigations under way during the past year at the Langley Memorial Aeronautical Laboratory. At a meeting of the subcommittee held on February 5, 1932, the results obtained in tests of a $\frac{1}{40}$ -scale model of the airship *Akron* in the propeller-research tunnel and in tests of the full-size airship in flight, conducted at the request of the Bureau of Aeronautics of the Navy Department, were discussed. At this meeting the subcommittee approved an investigation of airship forms to be conducted in the variable-density wind tunnel to determine the effect on the drag of variations in the nose fullness, tail fullness, and tail angle.

At a meeting held on October 10, 1932, a program of investigation of airship problems to be conducted by the Langley Memorial Aeronautical Laboratory was approved. This included model representation in the full-scale wind tunnel of ground handling of the *Akron*, as requested by the Bureau of Aeronautics of the Navy; an investigation in the NACA tank of the drag of a model of the *Akron*, for comparison with the results obtained in wind-tunnel tests; further study in the 20-foot propeller-research tunnel of the boundary layer and of the pressure distribution on an airship model; and an investigation in the propeller-research tunnel of the effect of surface roughness on the drag of the airship model. At both these meetings there was general discussion of problems of airship development and operation.

AR 1933
REPORT OF COMMITTEE ON AERODYNAMICS
SUBCOMMITTEE ON AIRSHIPS

In order that the committee on aerodynamics may be kept in close touch with the latest developments in the field of airship design and construction and that research on lighter-than-air craft may be fostered and encouraged, a subcommittee on airships has been organized under the committee on aerodynamics.

The subcommittee has kept in close touch with the airship investigations under way at the Langley Memorial Aeronautical Laboratory. The program of airship work at the laboratory includes the study in the full-scale wind tunnel of the forces on a large airship model at large angles of pitch and yaw. In cooperation with the Bureau of Aeronautics of the Navy, the Committee has also obtained information on the speed and deceleration on the full-size airship *Macon*.

AR 1934
REPORT OF COMMITTEE ON AERODYNAMICS
SUBCOMMITTEE ON AIRSHIPS

In order that the committee on aerodynamics may be kept in close touch with the latest developments in the field of airship design and construction and that research on lighter-than-air craft may be fostered and encouraged, a subcommittee on airships has been established under the committee on aerodynamics.

The subcommittee formulates and recommends programs of airship investigations for conduct at the Langley Memorial Aeronautical Laboratory, and maintains close contact with the work in progress. The airship projects on the Committee's program at the present time include the study in the propeller-research tunnel of boundary-layer control for airships, the investigation in the full-scale wind tunnel of the forces on a large airship model at large angles of pitch and yaw, and the effect of bow elevators on the resistance and controllability in pitch of an airship model.

In addition, the Committee is cooperating with the Bureau of Aeronautics of the Navy by making available instruments and personnel for an experimental investigation of the pressure distribution on the hull and fins of the United States airship *Los Angeles* while riding to a mooring mast at Lakehurst.

AR 1935 SUBCOMMITTEE ON AIRSHIPS

The Subcommittee on Airships formulates and recommends programs of airship investigations for conduct at the Langley Memorial Aeronautical Laboratory, and maintains close contact with the work in progress.

During the past year an investigation has been conducted to obtain information on the forces acting on an airship during ground handling, by means of tests in the full-scale wind tunnel on a large airship model at various heights above a ground board and at various angles of yaw with reference to the wind. The study of the theory of potential flow has been extended to the curvilinear motion of bodies of revolution, thus presenting information applicable to airships in flight.

An investigation to determine whether a sufficient amount of hydrogen could be efficiently burned in a compression-ignition engine to compensate for the increase of lift of an airship due to the consumption of the fuel oil has been completed, and the results have been published as Technical Report No. 535.

At the request of the Bureau of Aeronautics of the Navy, the Committee is conducting, for the information of the special airship subcommittee appointed by the Science Advisory Board, a study of the effect of aspect ratio on the pressure distribution on airship fins. In addition, the Committee has designed and constructed for the Bureau of Aeronautics a special accelerometer for the airship[s] use.

Other airship projects on the Committee's research program at the present time include a study in the propeller-research tunnel of boundary-layer control for airships and an investigation of the effect of bow elevators on the resistance and controllability in pitch of an airship model.

AR 1936 SUBCOMMITTEE ON AIRSHIPS

The Subcommittee on Airships formulates and recommends programs of airship investigations for conduct at the Langley Memorial Aeronautical Laboratory, and maintains close contact with the work in progress.

During the past year an investigation has been completed in the full-scale wind tunnel on a large airship model at various heights above the ground board field. Experiments with the Barnes type, which meets these requirements, indicate that the procedure to be followed is too complicated. In cooperation with an instrument manufacturer, the common-type altitude barometer has been modified to make it

possible for the tube to be filled in the field by following a relatively simple procedure. The barometer must be designed so that the end of the tube is always well covered with mercury while the barometer is tipped from the normal to the upside-down position. The usual capillary restriction in the end of the tube must be of such size that the passage of gas is not impeded by mercury sticking in the capillary.

Laboratory test methods have been developed, and data on the performance obtained, on fuel-air-ratio indicators of the thermal conductivity type. In these tests known mixtures of nitrogen and hydrogen and of nitrogen and carbon dioxide were passed through the instrument subject to various conditions, such as temperature, pressure, and voltage.

New instruments.—Instruments designed and constructed for the Bureau of Aeronautics include: a helium purity meter utilizing a porous plug of a type recently developed commercially; a superheat meter of the electrical-resistance type for a K airship; [and] an experimental pitot-static tube for installation on the wing tip of monoplanes. Development of a fuel flowmeter of the orifice type is in progress.

AR 1937 SUBCOMMITTEE ON AIRSHIPS

The Subcommittee on Airships formulates and recommends programs of airship investigations to be undertaken at the Langley Memorial Aeronautical Laboratory and maintains close contact with the work in progress.

The Committee recently published as Technical Report No. 604 the results of the investigation conducted by the laboratory at the request of the Bureau of Aeronautics of the Navy to determine the pressure distribution at large angles of pitch on fins of different span-chord ratios on a large model of the airship *Akron*. This investigation was requested by the Bureau to provide information particularly desired by the Special Committee on Airships on the Science Advisory Board, of which Dr. W. F. Durand, of Stanford University, is chairman. Mention is made here of the publication of the technical reports of this committee, which cover certain phases of airship technical problems.

Models and apparatus are being prepared for the investigation in the Committee's 20-foot wind tunnel of boundary-layer control on airship forms. This investigation will include a form with blower in the nose, and also a form with propeller in the rear with control of the boundary layer by both suction and discharge jets.

At a meeting of the Subcommittee on Airships held in January 1937, plans were discussed for the extension of the investigation of the forces acting on an airship during ground handling, as published in Technical Report No. 566, to include a study of the effect of wind gradient and also of the effect of fin angle. Consideration was also given to the desirability of conducting an investigation at the Committee's laboratory on the loads on the tail surfaces of an airship in flight, and also an

investigation of the forces on a large airship model with tail surfaces of the form used on the *Hindenburg*.

AR 1938 SUBCOMMITTEE ON AIRSHIPS

The Subcommittee on Airships formulates and recommends programs of airship research to be undertaken at the Langley Memorial Aeronautical Laboratory, and maintains contact with the work in progress.

The present program provides for an investigation in the Committee's 20-foot wind tunnel of boundary-layer control on airship forms. The investigation is to be conducted on a model approximately 20 feet in length, having a fineness ratio of 6. An arrangement with blower in the nose and an arrangement with stern propeller, with control of the boundary layer by both suction and discharge jets, will be included.

The information being obtained by the Committee's laboratory on the subject of gust intensities and gradients, in connection with the problem of structural loads on airplanes in flight, is of interest also in connection with airship design and operation. This work is described briefly in the report of the Committee on Aircraft Structures.

The subcommittee has kept informed of the latest developments in connection with airship design, construction, and operation, particularly the activities in Germany, where interest in the airship remains active, in spite of the unfortunate disaster [involving] the *Hindenburg*. A technical Note (No. 637) has been issued by the Committee giving the results of an investigation by the Goodyear-Zeppelin Corporation of the fatigue strength of aluminum-alloy airship girders of several different types. A number of translations of German papers dealing with airship problems have been issued by the Committee as Technical Memorandums.

Document 5-4

“Resume of Airship Investigations Made by the National Advisory Committee for Aeronautics,” n.d. (probably 1933), copy in Research Authorization file no. 255, NASA Historical Reference Collection (HRC), Washington, DC.

This document is an anonymously authored memorandum report—no doubt from NACA Langley—summarizing the NACA’s work on aerodynamic problems relating to airships from 1920 to 1933. It is clear from the review that most of the NACA’s airship research was done at the request of the U.S. Navy’s Bureau of Aeronautics. Although some theoretical work was done, most NACA airship investigations were experimental and involved wind tunnel or flight testing. This résumé is especially useful in that it refers to the major NACA technical reports that concerned airships.

Document 5-4, “Resume of Airship Investigations Made by the National Advisory Committee for Aeronautics,” n.d. (probably 1933).

Since 1920 the Committee has, from time to time, engaged in studies of the various phases of the aerodynamic problems relating to airships. In some few cases this work has consisted of theoretical studies only, but in general has consisted of investigations requiring wind-tunnel tests with models, and flight tests with full-size airships. The major portion of these investigations has been made at the request of the military services, particularly the Bureau of Aeronautics, Navy Department. In conducting investigations to meet the requirements of such requests the Committee has endeavored to arrange the work so as to obtain data of general application and thereby acquire for public use knowledge essential to the development of airships.

Up to the present time the Committee has published 24 technical reports relating to airships. Of this number, 13 were written by members of the laboratory staff, the remainder being written by people not in the employ of the Committee. Of the 13 reports written by members of the laboratory staff, 11 were concerned with actual tests made with wind-tunnel models or in flight, the remaining 2 being concerned with theoretical studies.

The first request for cooperation with the Bureau of Aeronautics in the performance of tests with airships was May 24, 1922. At that time the Bureau of Aeronautics requested the Committee to cooperate in an investigation of the aerodynamic pressures acting on the hull and tail surfaces of the C-7 non-rigid airship in flight. The experiments with this airship were carried out in 1923 and consisted in the measurements of the distribution of pressure over the hull and tail surfaces

of the airship in normal flight, turns, and rough air. The measurements were the most extensive pressure measurements that had ever been made in flight at that time. The results of this investigation are given in Technical Reports Nos. 208, 1925, and 223, 1926. Aside from the practical value of the pressure data obtained in this investigation, an important development was the fact that a method had been devised whereby extensive measurements of the pressures on an airship in flight could be conveniently carried out.

In 1924 the Bureau of Aeronautics, realizing the necessity for more knowledge of the forces acting on a rigid airship in flight, requested the Committee to cooperate in an investigation of the U.S.S. *Los Angeles*. In this investigation it was again proposed to measure the pressures acting on the hull and tail surfaces of the airship in flight in a manner similar to that employed with the C-7 airship. The actual experiments were carried out in 1926 and 1927. In these measurements, the distribution of pressure was measured in flight for various flight conditions, including turns in flight in bumpy air. Additional tests were also made to determine the resistance of the airship and its motion during turns. The results of this investigation are available in Technical Reports Nos. 318, 1928[;] 324, 1928[;] and 333, 1929.

In 1926, at the request of the Bureau of Aeronautics the Committee undertook an investigation of the aerodynamic characteristics of airship models of various shapes. In this group of models were four basic shapes and four intermediate shapes, obtained by the insertion of parallel midsections in the basic shapes, making a total of eight shapes. This investigation was of particular interest at that time as a guide in determining the most desirable shape for the large airships that the Navy was then proposing to build. A preliminary report giving results of wind-tunnel tests with these models was submitted to the Bureau of Aeronautics in July, 1927. Further tests were made with these models in 1927 and the additional data submitted to the Bureau November 14, 1927. The results of these tests were later published in Technical Report No. 394, 1931.

In March, 1929, at the request of the Bureau of Aeronautics, the Committee undertook a very complete investigation of the aerodynamic forces on all parts of a large model fitted with tail surfaces. A $\frac{1}{40}$ -scale model of the U.S.S. *Akron* was utilized for this investigation. Upon receipt of this model in February, 1931, tests were started and the results were made available to the Bureau in memorandum reports of July 6, 1931, October 2, 1931, and November 25, 1931. The data obtained in this investigation were published during 1932 in Technical Reports Nos. 430, 432, and 443.

At the time of making the tests with the series of eight models previously referred to, an investigation of the effect of protuberances on the drag of an airship was also planned. Owing to difficulties in obtaining a model suitable for such tests, this phase of the investigation was postponed until a later date. In the meantime the Committee had received a request from the Army Air Corps for an investigation of the aerodynamic characteristics of a model of a proposed metal-clad airship. As a model suitable for an investigation of the effect of protuberances on the hull had

been obtained in 1930, this model and the model of the proposed metal-clad airship in which the Army Air Corps was interested were tested together in January, 1931. The results of the investigation of the effect of protuberances were made available to the Bureau of Aeronautics in a memorandum report February 7, 1931. The results of the tests with both models were later made available in Technical Report No. 451, 1932.

On May 1, 1931, the Bureau of Aeronautics requested that the Committee cooperate in obtaining pressure distribution measurements on the U.S.S. *Akron* during its trial flights in a manner similar to that employed with the C-7 and the U.S.S. *Los Angeles*. These measurements were obtained during the trial flights made at Akron in September and October, 1931, in which the airship was required to undergo various flight tests to prove her airworthiness. The results of these measurements were made available to the Bureau in a series of memorandum reports dated December 11, 1931, December 17, 1931, January 12, 1932, January 13, 1932, January 26, 1932, March 28, 1932, and September 27, 1932.

From time to time the Committee has cooperated with the military services in determining the drag of various airships by means of comparatively simple speed measurements. As a result of these investigations, the Committee has acquired data concerning the drag characteristics of airships of various sizes and shapes, and has published this information in Technical Report No. 397, 1931.

At the present time the Committee is engaged in an investigation concerning the possibilities of improving the efficiency of airships by using a limited amount of hydrogen as fuel in conjunction with liquid fuel. This investigation is practically complete. In another project it is planned to measure the resistance of a model of the U.S.S. *Akron* in a water channel. The only remaining project is an investigation of the aerodynamic properties of models representing various shapes suitable for airships. This investigation is to be more general in scope and hence more conclusive than previous investigations of a similar nature.

Document 5-5 (a–g)

- (a) “Outline of Purpose and Method for Conduct of Research Authorization No. 255, ‘Study of Airship Forms, and Especially of Airship Appendages, in the Variable-Density Wind Tunnel.’ Approved by the Subcommittee on Airships, Dec. 20, 1928,” copy in Research Authorization file 255, NASA HRC.
- (b) Garland Fulton, Comdr. (Construction Corps [CC]), USN, by Direction from the Chief of the Bureau of Aeronautics, to the Inspector of Naval Aircraft, Akron, Ohio, “Wind Tunnel Models of Airship ZRS-4,” 10 January 1929, copy in Research Authorization file 255, NASA HRC.
- (c) Henry J. E. Reid, Engineer-in-Charge, NACA Langley, to NACA, “Meeting of Airships Subcommittee on January 10, 1931,” 7 January 1931, Research Authorization file 255, NASA HRC. Attached to this letter is NACA Langley’s “Report to Subcommittee on Airships,” 10 January 1931.
- (d) George W. Lewis, Director of Aeronautical Research, NACA, to Langley Memorial Aeronautical Laboratory, “Investigation of Models of Airship ZRS-4, in Propeller Research Tunnel and Variable-Density Wind Tunnel,” 15 January 1931, in Research Authorization file 255, NASA HRC.
- (e) Henry J. E. Reid to NACA, “Investigation of Models of Airship ZRS-4 in Propeller Research Tunnel and Variable-Density Tunnel,” 17 January 1931, Research Authorization file 255, NASA HRC.
- (f) C. P. Burgess, Bureau of Aeronautics, U.S. Navy, “Significance of the Tests of the Metal Models of Airships ZRS-4 and MC-38 in the Variable-Density Wind Tunnel,” Design Memorandum No. 108 (March 1931), copy in Research Archives file 255, NASA HRC.

(g) “Airship Investigations of the National Advisory Committee for Aeronautics,” 10 March 1932, copy in Research Archives file 255, NASA HRC.

Between May 1923 and June 1931, the NACA authorized no fewer than six major research authorizations (RAs) related to airships. They were RA 76, “Pressure Distribution on a ‘C’ Class Airship,” approved by the NACA Executive Committee on 23 May 1923; RA 102, “Investigation of Aerodynamic Loads on the U.S.S. Shenandoah,” 12 June 1924; RA 255, “Study of Airship Forms, and Especially of Airship Appendages, in the Variable-Density Wind Tunnel,” 20 December 1929; RA 282, “Study of the Forces on an Airship Entering a Hangar,” 22 March 1929 (modified to cover “Wind Tunnel Tests of U.S.S. Akron at Large Angles of Yaw,” 21 April 1932); RA 311, “Study of Deceleration on Metalclad Airship ZNC-2,” 24 October 1929; and RA 354, “Investigation of Aerodynamic Loads on U.S.S. Akron,” 23 June 1931. Occasionally, the NACA dispatched a team of its flight researchers to the naval air station at Lakehurst, New Jersey, as it did in 1928 to take pressure distributions and speed measurements on the U.S.S. Los Angeles as well as to photographically record and analyze the turning radii of the big zeppelin.

The documents below all come from the files of RA 255, “Study of Airship Forms, and Especially of Airship Appendages, in the Variable-Density Wind Tunnel.” This research authorization was approved by the Subcommittee on Airships on 20 December 1928 and authorized by the NACA on 22 March 1929. The flight vehicle involved was ZRS-4, better known as the U.S.S. Akron, a huge new airship that the Navy contracted with Goodyear-Zeppelin to build in October 1928. (In the Navy’s designation, *Z* stood for “airship,” *R* for “rigid,” and *S* for “scout.”) According to the RA, researchers at NACA Langley were to test scale models of Goodyear’s zeppelin design in both the Propeller Research Tunnel and the Variable-Density Tunnel in accordance with a plan upon which all parties agreed. The purpose of the tests was to measure the aerodynamic forces affecting all parts of the airship, including propeller mountings, fins, rudders and gondola car, and other protuberances. Measurements of pressure distributions also were to be made, especially on the rear part of the hull and on the fins. In the Propeller Research Tunnel, using a 1/40-scale model of the Akron, NACA researchers conducted oscillating tests to determine the most effective damping coefficient. Starting in May 1931, the NACA also cooperated in obtaining pressure distribution measurements during the Akron’s flight trials, something that it had done earlier with the C-7 and the U.S.S. Los Angeles.

One of the more interesting aspects of this NACA program turned out to be what researchers learned about the forces acting on an airship entering a hangar. The Langley staff constructed models of two different types of hangars, placed the hangar models alternately in a wind tunnel along with the airship model, and then investigated the forces and moments acting on the airship model in various

positions with respect to the hangar and to the direction of the wind stream. This research even looked into the effect of hangar doors and windscreens. As a result of these tests, the military services and the airship industry gained important insights into the ground handling of large lighter-than-air vehicles.

What the NACA basically contributed in all this testing was systematic data on airship drag. In several different ways, these data informed the design process. Not only was the overall airship form itself refined, but designers learned how to do a much better job of shaping such things as nose fullness, tail fullness, and tail angle. As readers will see in Document 5-7, the NACA's airship research also involved some critical analysis of problems associated with aerodynamic conditions in the boundary layer, and it led to some insights with implications for boundary-layer conditions on airplanes and on all other aerodynamic surfaces. Some of the NACA's earliest awareness of the effect of minor surface roughness on drag also came as a result of its airship studies.

Document 5-5 (a), "Outline of Purpose and Method for Conduct of Research Authorization No. 255, 'Study of Airship Forms, and Especially of Airship Appendages, in the Variable-Density Wind Tunnel.' Approved by the Subcommittee on Airships, Dec. 20, 1928."

1. Determine the drag, cross-wind forces, and moments, at various angles of pitch and yaw, and different rudder and elevator settings, on a model of the ZRS-4 (fineness ratio 5.9). Include various appendages, such as cars of different sizes and in different locations, and if practicable include different hull surface conditions. Extend the experiments under this paragraph over a suitable range of Reynolds numbers.
2. Carry out damping or oscillating experiments on the same model of the ZRS-4. The detailed working out of a schedule for these tests should be a subject for discussion between the Langley Field laboratory, the Bureau of Aeronautics, and the Goodyear-Zeppelin Corporation. In connection with this part of the program the theory of stability should be extended if possible to determine the efficacy of the fins and control surfaces to check turning motion once set up, or to create negative angular acceleration. The classical theory of stability seems inadequate because it is based on a condition in which the angular acceleration is zero.
3. In order to include in the investigation a hull of low fineness ratio, it is recommended to take the 1:4.8 model recently tested as one of a series and subject this model to further study, possibly in conjunction with the 1:6 model of the same series if it is considered that the 1:5.9 model of the ZRS-4 is not adapted for the purpose. If practicable it will be desirable to construct other models of 1:4.8 fineness ratio by having different meridional curves giving greater or less volumetric coefficient.

Document 5-5 (b), Garland Fulton, Comdr. (CC), USN, by Direction from the Chief of the Bureau of Aeronautics, to the Inspector of Naval Aircraft, Akron, Ohio, "Wind Tunnel Models of Airship ZRS-4," 10 January 1929.

1. At the meeting of the Airship Subcommittee of the National Advisory Committee for Aeronautics last month, at which Dr. Arnstein was present, it was decided to test models of the ZRS-4 in the 20' tunnel at Langley Field, and also in the high-pressure tunnel. A 4' diameter model was proposed for the large tunnel; but in accordance with views expressed by the aerodynamic experts, it has since been decided to reduce the size to 30" diameter. The model for the high pressure tunnel will be one-fourth that size.
2. At the meeting, Dr. Arnstein promised to furnish the Bureau the mathematical equations by which the form of the ZRS-4 is determined. These equations have not yet been received, and it is requested that you urge Dr. Arnstein to expedite these equations so that the model may be constructed as soon as possible.
3. It is understood that the control car and tail surfaces as finally designed differ from the cars and surfaces of the Goodyear-Zeppelin models previously tested in the wind tunnels of the Washington Navy Yard and the Zeppelin Company at Friedrichshafen. It is accordingly requested that the Goodyear-Zeppelin Corporation furnish dimensioned drawings of the car and surfaces, in order that the wind tunnel models may correctly represent the ZRS-4.
4. Expedition of this matter is requested.

Garland Fulton,
Comdr. (CC) U.S.N.,
By direction Chief of Bureau.

Document 5-5 (c), Henry J. E. Reid, Engineer-in-Charge, NACA Langley, to NACA, "Meeting of Airships Subcommittee on January 10, 1931," 7 January 1931. Attached to this letter is NACA Langley's "Report to Subcommittee on Airships," 10 January 1931.

1. There are enclosed herewith the programs of tests to be carried out in the Propeller Research Tunnel on the ZRS-4 airship model and in the Variable Density Tunnel on the ZRS-4 and the metal-clad airship models. There are enclosed also a sketch showing the principle of operation of the balance for measuring the forces and moments on the elevator post and a photograph of the special manometer to be used on these tests. It may be possible in redrawing the sketch to make it more effective by showing a portion of the elevator. One part of the apparatus shown is to be in the airship, of course, and the other part on the ground, but it was thought best to show them in close proximity in order that the principle could be better understood.
2. It is recommended that Messrs. Weick and Freeman be authorized to attend this meeting. Mr. Freeman has had much to do with the preparation of the program for the tests in the Propeller Research Tunnel and with the design of the special equipment to be used.

H. J. E. Reid,
 Engineer-in-Charge.
 Enc* Programs of tests, sketch and photograph.
 P.S. Photograph will be sent tomorrow.

REPORT TO SUBCOMMITTEE ON AIRSHIPS

January 10, 1931.

PROPELLER RESEARCH TUNNEL.

Airship tests contemplated in the Propeller Research Tunnel include, at present, force and pressure distribution tests on a $\frac{1}{40}$ -scale model of the ZRS-4 airship now under construction at Akron. The model is being constructed at the Washington Navy Yard, and latest reports indicate that the construction is practically finished. At the same time, manometers and a balance have been made on contract from designs prepared at the Laboratory. The manometers have been completely assembled and adjusted, and calibration tests will begin at once. The balance for measuring the forces and moments on the elevators is of rather unusual construction. The inductance bridge principle is, of course, old, but to satisfy ourselves of the practicability of the device, preliminary tests were made before final design. The actual balance is now being finally assembled after some manufacturing difficulties. The essential features of this apparatus are shown in the sketch.

Both the balance and manometers are to be mounted within the model and controlled electrically from below. The model itself will be suspended by wires, in order to reduce the tare drag to the lowest value.

CONTEMPLATED PROGRAM.

Wind Tunnel Tests on Model of ZRS-4—Scale 1:40:

Force Tests. Three component measurements of lift, drag and pitching moment at angles of pitch of 0°, and ±3°, +6°, +9°, +12°, +15°, and at 50 per cent, 70 per cent and 100 per cent of maximum permissible impact pressure, the tests at 70 or 100 per cent to be the most complete (while the tests at the other speeds may be limited to a reduced program of angles of pitch and elevator inclination). All tests to be run without empennage, as well as with empennage and with several different elevator settings, viz., 0°, ±5°, ±10°, ±15°, and ±20°.

A balance, previously discussed, is to measure the elevator force normal to the axis of the ship and torque transmitted by the elevators to the elevator cost at the various angular settings (see diagram[.])

One series of tests is to be run with the model mounted at 45° roll and at about 9° pitch in the plane of pitch, so as to represent the combined action of pitch and yaw, measuring the resultant lift, drag and pitching moment. Several rudder and elevator settings may also be tried, but the measurements of the rudder and elevator forces and torques which would be rather difficult are not considered of primary importance in this series.

Pressure Distribution Tests. The two specially constructed manometers are to record the pressures from 450 pressure orifices in the hull and 80 orifices in the fins. These manometers will accommodate 400 pressure orifices simultaneously, the remaining orifices being covered by rearranging the tubes for a separate test.

Owing to the continuous use of the tunnel with an extensive program of wing-nacelle tests, no positive statement can be made as to when the actual tests will start, but it may be possible to have the ZRS-4 in the tunnel about May 1.

VARIABLE-DENSITY WIND TUNNEL

PROGRAM OF TESTS OF ZRS-4 METAL AIRSHIP MODEL:

It is proposed to conduct drag tests of the metal model of the ZRS-4 airship in the Variable Density Wind Tunnel at zero pitch, using the auxiliary drag balance. The stern is to be modified, as requested by the Bureau of Aeronautics, and tests will be made before and after alteration. It is also planned to test the model with protuberances to determine their effects. These protuberances will simulate cars, water recovery apparatus, and similar projections which it might be necessary to

make on an airship hull. Tests will be made with a rectangular protuberance (a flat plate $\frac{1}{4}$ by $\frac{3}{4}$ inches, extending from the hull perpendicular to the airflow) placed in a series of positions along the bottom of the hull, and some of these tests will be repeated with a streamlined protuberance of approximately the same frontal area, the positions of which will be determined from the results of the previous tests. The proposed tests are listed below. These tests will follow the tests of the metal-clad airship which are now under way.

Tests	Condition of Hull	Protuberances	Tank Pressure (Atmos.)
One	Present	None	1, $1\frac{3}{4}$, $2\frac{1}{2}$, 5, 10, 20
Several	Present	Rectangular	1, $2\frac{1}{2}$, 5, 10, 20
Several	Present	Streamlined	1, $2\frac{1}{2}$, 5, 10, 20
One	Modified Stern	None	1, $1\frac{3}{4}$, $2\frac{1}{2}$, 5, 10, 20

PROGRAM OF TESTS OF METAL-CLAD AIRSHIP MODEL:

It is proposed to conduct drag tests of the metal-clad airship model in the Variable Density Wind Tunnel at zero pitch, using the auxiliary drag balance. Fins and cars will be attached, as requested by the U.S. Army Air Corps. Since the condition of the surface of the model is not considered satisfactory for tests in this tunnel, the model is to be tested with this surface and also with the surface partly and completely polished, to determine the effects of roughness. The proposed tests are listed below.

Test	Condition	Surface	Tank Pressures (Atmos.)
1	Bare Hull	Present	1, $1\frac{3}{4}$, $2\frac{1}{2}$, 5, 10, 15, 20
2	Bare Hull	None Polished	1, $1\frac{3}{4}$, $2\frac{1}{2}$, 5, 10, 15, 20
3	Bare Hull	Polished to Max. Ordinate	1, $1\frac{3}{4}$, $2\frac{1}{2}$, 5, 10, 15, 20
4	Bare Hull	Polished	1, $1\frac{3}{4}$, $2\frac{1}{2}$, 5, 10, 15, 20
5	Six Fins	Polished	1, $2\frac{1}{2}$, 5, 10, 20
6	Eight Fins	Polished	1, $2\frac{1}{2}$, 5, 10, 20
7	Six Fins and Cars	Polished	1, $2\frac{1}{2}$, 5, 10, 20
8	Eight Fins and Cars	Polished	1, $2\frac{1}{2}$, 5, 10, 20

Document 5-5 (d), George W. Lewis, Director of Aeronautical Research, NACA, to Langley Memorial Aeronautical Laboratory, "Investigation of Models of Airship ZRS-4, in Propeller Research Tunnel and Variable-Density Wind Tunnel," 15 January 1931.

1. At the meeting of the Subcommittee on Airships held on January 10, attention was called to the desirability of having available at the earliest possible date results of the tests at Langley Field on the models of the airship ZRS-4 in the variable density wind tunnel and the propeller research tunnel. Commander Fulton and Doctor Arnstein pointed out that this information is of the greatest importance at the present time, because the construction of the airship has reached a point where any modifications which our results might indicate desirable would have to be made in the very near future.
2. A summary of the preliminary report brought to this office by Mr. Freeman, on the airship model tests in the variable-density tunnel, was read, and the report was transmitted to Commander Fulton for the information of the Navy and the Goodyear Zeppelin Corporation.
3. With regard to the tests in the propeller research tunnel, it was explained that the program of work for this tunnel was very extensive, and that important investigations were at present under way.
4. After discussion, the subcommittee adopted a resolution recommending that as soon as the model of the airship is received from the Navy Department, the present program of the propeller research tunnel be interrupted immediately so as to give all possible priority to the tests of the airship model.
5. It was also agreed that it was most important for the laboratory to proceed with the tests of the model in the variable-density tunnel as rapidly as possible. It was recommended that, as soon as the tests on the model of the metal-clad airship can be completed, drag and pressure distribution tests be run immediately on the ZRS-4 model with the original form of stern and with the sharply rounded stern as recently modified, and with the bare hull and with protuberances.
6. Mr. Weick and Mr. Freeman estimated that these tests could be completed, and preliminary results available by March 1. As soon as this series of tests has been completed, it is requested that the results be forwarded to this office in preliminary form, without delay.

G. W. Lewis,
Director of Aeronautical Research.

Document 5-5 (e), Henry J. E. Reid to NACA, "Investigation of Models of Airship ZRS-4 in Propeller Research Tunnel and Variable-Density Tunnel," 17 January 1931.

1. The tests of the metal-clad airship model have now been completed in the Variable Density Tunnel, and the program on the ZRS-4 model will be started at once. In view of the urgency of this work, it is believed the results in preliminary form can be placed in your hands by February 15. It is assumed that the reference to pressure distribution tests in your letter is an error, since pressure distribution tests are not contemplated on this model, but on the one in the Propeller Research Tunnel.
2. The program of wing nacelle tests in the Propeller Research Tunnel has been interrupted a number of times and recently considerable delay has been experienced in investigating the effects of NACA ring cowlings. It had been intended to complete the tests on the two monoplane wings and the biplane arrangement before putting in the ZRS-4 model. This would have taken until approximately May 1. This section has been working recently on a two-shift basis in order to complete this work more rapidly. In view of the action of the Subcommittee on Airships, plans will be made to interrupt the wing nacelle program and start work on the ZRS-4 model when it is received. The indications now are that the special equipment for mounting this model will all be ready by March 1, so that these tests could be started if the model is received by that date.
3. It is believed that the remaining tests on the monoplane wings and nacelles can be completed previous to that time and possibl[y] some preliminary tests on the biplane can be made.

H. J. E. Reid,
Engineer-in-Charge

*Document 5-5 (f), C. P. Burgess, Bureau of Aeronautics, U.S. Navy,
"Significance of the Tests of the Metal Models of Airships ZRS-4 and
MC-38 in the Variable-Density Wind Tunnel," Design
Memorandum No. 108 (March 1931).*

The following notes indicate the principal conclusions to be drawn from the high pressure wind tunnel tests of metal models of the ZRS-4 and MC-38. The data is taken from a report dated February 2, 1931, by Eastman N. Jacobs, of the NACA:

1. The two bare hull models showed almost identical drag coefficients at high Reynolds Numbers. As the Reynolds Number diminishes, the MC-38 shows a slight advantage.
2. Snubbing the stern of the ZRS-4 increases the bare hull drag by nearly 5% at large Reynolds Numbers. The effect of snubbing is less at smaller Reynolds Numbers.
3. The cars increased the drag of the MC-38 model about 10% over the bare hull. The six-fin group added approximately another 8% to the resistance, and the eight-fin group fully 11%. The resistance of the car and fins of the ZRS-4 was not determined. The Goodyear-Zeppelin Corporation has allowed for a tail surface drag equal to 37% of the bare hull drag, and an equal amount for the control car and power plant as originally designed. These allowances make a rather startling contrast with the small drag resulting from the cars, which included large external power cars, on the MC-38. Possibly, in practice, these cars could not be of such clean design as in the model.
4. In general, protuberances added less resistance than the sum of their individual resistances. In other words, interference effects were usually negative, except for protuberances close to the bow, or at low Reynolds Numbers. This result is very interesting, and is contrary to reports from abroad that protuberances cause the total resistance to increase much more than their individual resistances. Lieutenant Diehl suggests that these reports were the results of running tests at too low Reynolds Numbers, so that the protuberances converted laminar flow into turbulent flow.

Document 5-5 (g), "Airship Investigations of the National Advisory Committee for Aeronautics," 10 March 1932.

For use at hearing on Merchant Airship Bill, H.R. 8681.
March 10, 1932.

**AIRSHIP INVESTIGATIONS OF THE NATIONAL ADVISORY
COMMITTEE FOR AERONAUTICS.**

The National Advisory Committee for Aeronautics has been very active in the study of the fundamental problems affecting the design and safe operation of airships.

Study of Airship Forms.—One of the most important factors to be considered in the design of an airship is the shape of the hull structure. The shape must first be considered from the standpoint of minimum resistance, and other factors, including structural strength, must be considered. At the request of the Bureau of Aeronautics of the Navy, the Committee made a very careful investigation in its variable-density wind tunnel of airship forms, resulting in the selection of the fineness ratio 5.9 to 1 for the new airship ZRS-4, or the *Akron*. The fineness ratio is the ratio of length to diameter. The *Akron* is 785 feet long and has a maximum diameter of 132.9 feet.

Aerodynamic Loads on Airship Hull and Control Surfaces.—Very little definite information was available as to the air loads imposed on an airship hull structure and upon the control surfaces of an airship in flight and in maneuvers. At the request of the Bureau of Aeronautics of the Navy Department, the National Advisory Committee for Aeronautics developed a special type of multiple manometer which made possible the measurement of the air pressures over the hull structure and the control surfaces.

This information was obtained on the U.S.S. *Los Angeles*, and proved very valuable to the designer and constructor in visualizing the actual loads imposed upon the airship structure.

Since the completion of the U.S.S. *Akron*, the Committee has conducted flight tests on that airship and obtained information as to the deceleration, turning characteristics, and ascent, descent, and dynamic-lift characteristics, and as to the pressure distribution or air loads over the structure.

The Committee is of the opinion that a careful and systematic study has been made of the factors involved in the safe and economical operation of airships. The results of these investigations have been incorporated in the design of the *Akron*.

Document 5-6 (a-d)

(a) “Airship Dropping’: Extract from Memorandum Dated 10/26/29, by Eastman N. Jacobs, Regarding Subject Discussed with Professor G. I. Taylor During His Visit to Langley Memorial Aeronautical Laboratory,” 2 November 1929, copy in Research Authorization file 255, NASA HRC.

(b) Eastman N. Jacobs, Associate Aeronautical Engineer, NACA Langley, to Engineer-in-Charge, “Request for Airship Test Authorization for Variable-Density Wind Tunnel,” 30 January 1931, Research Authorization file 255, NASA HRC.

(c) Eastman N. Jacobs, Associate Aeronautical Engineer, NACA Langley, to Engineer-in-Charge, “Investigation of Airship Forms in Variable-Density Tunnel,” 11 January 1932, Research Authorization file 255, NASA HRC.

(d) George W. Lewis, Director of Aeronautical Research, NACA, to Langley Memorial Aeronautical Laboratory, “Investigation of Airship Forms in the Variable-Density Wind Tunnel,” 19 February 1932, Research Authorization file 255, NASA HRC.

Sometimes, it takes a brilliant mind to come up with a harebrained idea—one that might, in fact, work. Such seems to have been the case in 1929, when Professor Geoffrey I. Taylor, England’s leading expert in fluid mechanics, proposed the following idea to Eastman N. Jacobs, the NACA’s promising young aerodynamicist. Because of the low Reynolds numbers involved in scale-model testing of large zeppelins, aerodynamicists could not be sure that designers were in fact creating the optimal, most streamlined form for an airship. Understanding the problem of scale effects, Taylor suggested to Jacobs during a meeting at Langley that an 8-foot-long model of an airship with a weighted-down nose and instrumented tail section could be dropped from a height into the sea. Reaching a terminal velocity of approximately 170 feet per second, the airship model could achieve a test Reynolds number of two to three times that which was being obtained in Langley’s Variable-Density Tunnel, the best type of ground facility available anywhere.

Jacobs obviously found the idea interesting and described it in a memo to his engineer-in-charge; the memo was then forwarded to the NACA’s Washington office. It is not known what became of it, but there is no record of any such test

ever being tried. Years later, the NACA would pioneer this sort of test in order to acquire transonic data. In its so-called “drop-body” test program, the NACA mounted wing models on bomb-shaped missiles and dropped these bodies from an airplane at great altitude. Most likely, the same type of problems that quickly ended the later drop-body testing worked against Taylor’s ideas of “airship dropping.” Not only was it difficult to measure the airflow around the models effectively, but it was just too much of a chore to find and salvage the models—from the depths of the sea in the case of the airship, or after they had sunk several feet into a muddy bombing range in the case of the transonic wings.

The second and third documents below show how Jacobs did not give up on the idea of defining a more streamlined airship form. What he proposed were systematic tests in Langley’s Variable-Density Tunnel. In his view, “spurious data” due to scale effects and the low test Reynolds numbers were being used in the design of the country’s airships. What Jacobs wanted to try was an approach based on experimental parameter variation, in which nose fullness, tail fullness, and tail angle would be systematically varied in the Variable-Density Tunnel. As the last document in this string indicates, the NACA approved of Jacobs’s idea and authorized him to carry it out using four different-scale models.

Document 5-6 (a), “Airship Dropping’: Extract from Memorandum Dated 10/26/29, by Eastman N. Jacobs, Regarding Subject Discussed with Professor G. I. Taylor During His Visit to Langley Memorial Aeronautical Laboratory,” 2 November 1929.

AIRSHIP DROPPING.

Professor Taylor described a new and very ingenious method he proposes to use for determining the drag of airship hulls. The method consists in dropping an airship model with a loaded nose into the sea. Instruments in the tail portion will record the fall, and after it ha[s] reached a sufficient depth, the nose and tail parts will become detached, and the after part with the instruments inside will float to the surface. A model 8 ft. long can be dropped to sufficient depth to reach a terminal of velocity of approximately 170 ft. per sec. The Reynolds number thus reached will be between two and three times that obtainable in the Variable Density Wind Tunnel, and of course, no support interference will be present.

Document 5-6 (b), Eastman N. Jacobs, Associate Aeronautical Engineer, NACA Langley, to Engineer-in-Charge, "Request for Airship Test Authorization for Variable-Density Wind Tunnel," 30 January 1931.

January 30, 1931.

MEMORANDUM For Engineer-in-Charge.

Subject: Request for airship test authorization for Variable Density Wind Tunnel.

1. In as much as the present airship forms have been arrived at through model tests at comparatively low values of the Reynolds Number, the optimum form that has been arrived at is probably not the optimum form for higher values of the Reynolds Number. It is believed, therefore, that a systematic investigation of airship forms in the Variable Density Wind Tunnel might give rise to a form which will give an appreciably lower drag than the present form.
2. Authorization for the construction and testing of six or eight airship forms is therefore requested. Since our previous tests have given some information concerning the effect of fineness ratio, this variable would not be included. Instead, the variables would be nose sharpness, body fullness, and the position of the maximum ordinate.

Eastman N. Jacobs,
Associate Aeronautical Engineer.

Document 5-6 (c), Eastman N. Jacobs, Associate Aeronautical Engineer, NACA Langley, to Engineer-in-Charge, "Investigation of Airship Forms in Variable-Density Tunnel," 11 January 1932.

January 11, 1932.

R.A. 255.

MEMORANDUM For Engineer-in-Charge.

Subject: Investigation of airship forms in variable-density tunnel.

1. In view of the fact that it is now recognized that the present form of airship hull is the result of low-scale tests which are practically valueless for predicting the drag of full-scale airships, we believe that airship hull forms should be investigated in the variable-density tunnel before a great deal more money is spent in the building of new airships the form of which will be based on spurious data. Our recent tests of airship models indicate that the variation of the drag coefficient with Reynolds Number is such that the results can be extrapolated to full-scale values of the Reynolds Number. No better method, short of building and testing full-scale airships, is available for determining airship form drag. Accordingly, the program of airship hull

tests authorized in N.A.C.A. letter February 3, 1931, has been laid out for the variable-density tunnel.

2. Because the cost of the metal models that are required is rather large, the number of models required for the first part of the program has been held to ten by eliminating the fineness ratio variable. Airship building practice, flight tests, and previous tests in the variable-density tunnel all point toward a fineness ratio of approximately five. The first part of the program is therefore to consist of tests of models having approximately this fineness ratio. The best form found from this investigation may be investigated later over a range of fineness ratios.
3. The airship forms have been derived by Mr. Abbott from source-sink distributions so that the potential flow about them may be calculated. A type of distribution of the sources and sinks was chosen that would permit the nose fullness, tail fullness, and tail angle to be varied. The distributions used to produce the various forms and the resulting forms are shown on the enclosed blueprints.
4. A series of ten airship forms has been developed in this way, varying systematically from the fine model (No. 111) to the blunt model (No. 332). Authority is requested to proceed with the construction and testing of these models under Research Authorization No. 255.

Eastman N. Jacobs,
Associate Aeronautical Engineer.

Document 5-6 (d), George W. Lewis, Director of Aeronautical Research, NACA, to Langley Memorial Aeronautical Laboratory, "Investigation of Airship Forms in the Variable-Density Wind Tunnel, 19 February 1932."

February 19, 1932.

To: Langley Memorial Aeronautical Laboratory.

Subject: Investigation of airship forms in the variable-density wind tunnel.

Reference: L.M.A.L. letter EWM. MEB, R. A. 255, of January 11, 1932.

1. At a meeting of the Subcommittee on Airships held on February 5, 1932, the following resolution with reference to the investigation of airship forms in the variable-density wind tunnel was passed:

“RESOLVED, That the Subcommittee on Airships recommends that a program for the investigation of airship forms in the variable-density wind tunnel, to determine the effect of variation in nose fullness, tail fullness, and tail angle on the drag of an airship, be approved, to be carried out on four models to be selected by the Langley Memorial Aeronautical Laboratory, subject to approval by the members of the subcommittee.”

2. You will note the recommendation that the tests be carried out on four models to be selected by the members of the technical staff of the Langley Memorial Aeronautical Laboratory, and that these selections be forwarded for final approval by the members of the subcommittee.
3. It is requested that the selection of the four models be made and that six blueprints indicating these models be forwarded with your recommendations.

G. W. Lewis,
Director of Aeronautical Research.

Document 5-7 (a–c)

(a) **Hugh B. Freeman, Assistant Physicist, NACA Langley, “Boundary Layer Control for Airships,” 8 January 1934, copy in Research Authorization file 255, NASA HRC.**

(b) **Floyd L. Thompson, Associate Aeronautical Engineer, “Comments Regarding Proposed Full-Scale Tests on the Airship Los Angeles,” 17 April 1934, in Research Authorization file 255, NASA HRC.**

(c) **George W. Lewis to Dr. Joseph S. Ames, c/o Morgan et Cie, Place Vendôme, Paris, France, 2 July 1932.**

Some of the earliest fundamental research carried out by the NACA into aerodynamic conditions in the so-called “boundary layer” involved airships. As described elsewhere in this documentary history, the boundary layer amounts to a thin layer of fluid next to the surface of a body in a moving stream, e.g., an airfoil in an air stream. Flow in the boundary layer possesses several distinctive characteristics due to the friction between the fluid and the surface of the body.

By the 1930s, airship designers had defined some very good streamlined shapes, but none of them benefited much from purposeful reductions in friction drag. This was the drag arising from tangential forces operating at the surface of the body due largely to the viscosity of the fluid. (Friction drag was also referred to at the time as “skin-friction drag” or “viscous drag.”)

In the first two documents in this string, from early 1934, NACA researchers Hugh B. Freeman and Floyd L. Thompson laid out a program of boundary-layer control for airships that they hoped could be carried out in association with upcoming full-scale tests of the Navy’s rigid airship U.S.S. Los Angeles. The NACA approved the tests, and they soon got under way in the 20-foot test section of Langley’s Propeller Research Tunnel. In brief, the NACA’s approach to boundary-layer control involved a combination of suction and blowing in the boundary layer. Researchers tested one airship form with an experimental blower in its nose and another form with a propeller in the rear that tried to control the boundary layer by using both suction and discharge jets. This research continued at least until 1938, when, in the wake of the Hindenburg disaster, virtually all of the NACA’s airship research ground to a halt. As indicated in the final document in the string below, a letter of July 1932 from the NACA’s director of research, George W. Lewis, to NACA chairman Dr. Joseph S. Ames, the boundary-layer control work at Langley actually dated back to a few years earlier. It is important

to note in Lewis's letter to Ames that Dr. Theodore von Kármán expressed a very favorable opinion of the NACA's boundary-layer control research. According to Lewis, von Kármán considered it "the finest work of this kind that had been brought to his attention."

Much of the NACA's early boundary-layer research was conducted under the authority of Research Authorization 201, "Investigation of Various Methods of Improving Wing Characteristics by Control of the Boundary Layer," approved by the NACA Executive Committee on 21 January 1927. Although this RA explicitly concerned the improvement of airplane wing characteristics, administratively it also covered some of the boundary-layer control research done on airships. Anyone interested in the history of airship R&D at the NACA laboratory should peruse the contents of RA 201, along with the six other RA files mentioned in the header to Document 5-5. In appendix F of volume two of his NACA history (pp. 529–550), Alex Roland presented an intriguing case study of RA 201, an authorization that stayed in force for nearly two decades, until 1946.

*Document 5-7 (a), Hugh B. Freeman, Assistant Physicist, NACA Langley,
"Boundary Layer Control for Airships," 8 January 1934.*

NATIONAL ADVISORY COMMITTEE FOR AERONAUTICS

*Langley Memorial Aeronautical Laboratory
Langley Field, Hampton, Va.*

January 8, 1934.

MEMORANDUM

Subject: Boundary layer control for airships.

1. The following tentative program for the investigation of boundary layer control for airships is presented:
 - (a) Construction of an airship model for boundary layer control.
 - (b) Control of air expelled at stern, discussed later.
 - (c) Design and construction of a centrifugal blower for Slate-type propulsion tests.
 - (d) Wind-tunnel tests in the P.R.T. to determine—
 1. Drag of model without boundary layer control.
 2. Drag of model with boundary layer control.
 3. Thrust and efficiency of Slate-type propulsive unit.

MODELS FOR THE TESTS:

(a) *Shape*.—Two airship forms are shown in figure 1 and compared to the shape of the metal-clad Z.M.C.-2. Shape (A) is obtained by cutting a prolate spheroid in

half and inserting a cylindrical section in between the two ends. The cross section of the nose and tail is an ellipse whose equation is

$$(y/L)^2 = 1/36 - 1/4 (x/L)^2$$

where L is the length of the hull and x and y are the coordinates of a point on surface. Shape (B) has the same bow as (A) but the after portion is given by the ellipse

$$(y/L)^2 = 1/36 - 1/16 (x/L)^2$$

Shape (A) is considered more suitable for the boundary layer control tests because the boundary layer control system may be confined to the extreme after portion of the hull. This will allow fewer and larger slots to be used, decreasing the slot losses and increasing the scale of the slot arrangement. From the viewpoint of practical application to the full-scale ship[,] the consideration of the area over which the flow must be controlled becomes of even greater importance.

Shape (B) is probably more suitable for the Slate-type propulsion tests. If these tests are considered of sufficient importance[,] two after portions should be provided for the model. An interesting comparison could be had by making boundary layer control tests on both types of hull.

(b) *Structure.*—A previous memorandum suggested that the hull structure consists of a framework of wood covered with doped airplane fabric. Because of the bulkiness of such a wooden structure near the extremities of the model it is suggested that the frame of the bow and stern be built of welded steel tubing. This will allow greater space inside the hull for the installation of apparatus.

(c) *Size.*—It is suggested that the model be 1/25-scale of a ship with a displacement equal to that of the U.S.S. *Macon* but of fineness ratio 3 (i.e., 19.3 feet long and 6.44 feet in diameter). An additional straight section 3.21 feet long will allow a fineness ratio of 3.5 to be obtained.

(d) *Method of suspension in wind tunnels.*—The model is to be suspended by two sets of V-wires in such a manner as to allow it to swing downstream under the action of the air force. The drag can then be determined from the downstream movement. For damping, two small wires, one extending forward from the nose and one aft from the tail, will be brought down over ball-bearing pulleys to counterweights. The front wire will be fitted with a dash pot.

CONTROL OF THE COLUMN OF AIR EXPELLED AT THE STERN OF AN AIRSHIP:

It is believed that the forces created by deflecting a jet of air expelled from the stern of the ship can be more accurately computed than they can be determined by these small model tests. The maximum turning force would occur when the jet was deflected through an angle of 90°. Assuming that the air may be turned through

this angle without loss of energy, the force would be equal to the momentum of the jet. A measurement of this force on a model would only indicate the effectiveness of the tube in turning the stream around the corner. On such a small model the scale effect would be great and the forces small, hence it is suggested that this part of the program be omitted.

SLATE-TYPE PROPULSION TESTS:

Figure 2 presents a suggestion for the design of a centrifugal blower for the subject tests. This type of blower should be more efficient than a conventional blower for this particular purpose.

CONCLUSION:

The above paragraphs contain an outline of the proposed tests, with certain recommendations. After this is discussed with the Bureau of Aeronautics, Navy Department, and approved, detail designs of the models will be prepared and construction can proceed.

Hugh B. Freeman,
Assistant Physicist.

Document 5-7 (b), Floyd L. Thompson, Associate Aeronautical Engineer, "Comments Regarding Proposed Full-Scale Tests on the Airship Los Angeles," 17 April 1934.

NATIONAL ADVISORY COMMITTEE FOR AERONAUTICS

*Langley Memorial Aeronautical Laboratory
Langley Field, Va.
April 17, 1934.*

MEMORANDUM.

Subject: Comments regarding proposed full-scale tests on the airship LOS ANGELES.

1. There are four major subjects that I would like to mention as being of importance in a program of research.
 - a. Improve performance predictions.
 - b. Improve propulsive efficiency.
 - c. Improve serviceability as regards ability to withstand rough weather.
 - d. Decrease resistance.
2. It seems to me that measurements of the boundary layer would come under item (a), in that they would supposedly throw some light on scale effect so that resistance of the full-size airship might be more reliable [*sic*] predicted from model tests. After reading over the attached memorandums it seems to be a little doubtful that the measurements would prove to be of any great value.
3. Items (b) and (c) seem to come under the heading of structural problems to a large extent. Improving the propulsive efficiency would seem to depend largely on constructing propellers of sufficient size to have inherently good efficiency. The possibility of decreasing the drag of blunt shapes by means of boundary layer control, as proposed by Mr. Freeman, would appear to be important in connection with improvements in serviceability, a blunt shape probably being an advantage in that respect.
4. The only way in which the resistance of good airship shapes can be appreciably reduced is by reduction in the frictional drag. That any marked improvement in this respect can be obtained seems doubtful, although I believe there still remains some question as to whether polishing the surfaces would make an improvement.
5. It seems to me that if boundary layer measurements are likely to shed any real light on scale effect, the LOS ANGELES might be profitably used for such measurements and also for experiments with propulsive systems.

Floyd L. Thompson,
Associate Aeronautical Engineer.

*Document 5-7 (c), George W. Lewis to Dr. Joseph S. Ames,
c/o Morgan et Cie, Place Vendôme, Paris, France, 2 July 1932.*

July 2, 1932.

Dr. Joseph S. Ames,
c/o Morgan et Cie,
Place Vendome,
Paris, France.

Dear Doctor Ames:

I spent yesterday at Langley Field with Dr. von Karman and Dr. Clark Millikan. They were in the East to attend the dedication of the Guggenheim Airship Institute at Akron. I attended the dedication, which was very impressive, and was presided over by Dr. R. A. Millikan. About a hundred aeronautical engineers and others especially interested in airship design and construction were present. They had available for the construction for the building, the installation of the wind-tunnel, workshops, conference rooms, etc., about \$350,000. The equipment consists of a large vertical wind tunnel, a small two-foot wind tunnel, and a materials laboratory for the investigation of airship structures, together with a machine shop and other laboratory facilities. The Institute is under the direction of Dr. Troller, a former assistant of Dr. von Karman at Aachen.

Dr. von Karman and Dr. Millikan were very much impressed with the investigations we have been conducting on airships at Langley Field, especially the study of the boundary layer flow. Dr. von Karman stated that it was the finest work of this kind that had been brought to his attention. This work, as you will recall, was done in the twenty-foot wind tunnel on the large model of the AKRON. We are planning to extend the investigation to include the study of the boundary layer flow over a large airfoil in the same wind tunnel.

At the present time we are planning to carry on one airship investigation during the summer, and that is the handling of airships near the ground. The Navy Department is very much interested in this, and the only apparatus in which this problem can be studied is the full-scale wind tunnel. We are planning to place a horizontal platform extending from the entrance to the exit cone, and with the twenty-foot model of the AKRON study the character of the flow about the airship in different attitudes and different distances from the horizontal platform.

After talking with Dr. von Karman and Dr. Arnstein I am convinced that we have the only equipment in which accurate studies can be made of airship problems. Studies made in small wind tunnels are almost useless owing to the very large scale effect.

The only airship problem we are planning to take up in the fall is the study of the form of airships to determine the possibility of decreasing the drag. This work

will be done in the variable-density wind tunnel, and four metal models are being constructed for the investigation.

Dr. von Karman showed some very interesting results obtained in the wind tunnel at the California Institute of Technology, which when operated at maximum speed, has a Reynolds Number of about sixty per cent that obtained in our variable-density tunnel. The results of tests on various models check very well. However, there is some discrepancy in the results on certain airfoil models, which was the subject of discussion between Jacobs, Miller, and Dr. Millikan.

In the afternoon Dr. von Karman gave a lecture to the members of the aerodynamics staff, on boundary layer flow and skin friction.

I received a letter from Mr. Ide this morning from London, and he will be in Paris to attend a special conference of the International Commission for Air Navigation at the request of the Department of State and Commerce, July 5 to 9. He also asked for your address in Europe.

I hope you had a very pleasant voyage, and are thoroughly enjoying yourself.

Sincerely yours,
G. W. Lewis

Document 5-8 (a–b)

(a) Max M. Munk, “On the Problems of Progressive Airship Research,” in *Report on Airship Forum, July 25–26, 1935* (Akron, OH: The Daniel Guggenheim Airship Institute, Publication No. 3, 1935), pp. 89–96.

(b) Theodore von Kármán, “Lighter Than Air,” in *The Wind and Beyond: Theodore von Kármán, Pioneer in Aviation and Pathfinder in Space* (Boston and Toronto: Little, Brown and Co., 1967), pp. 159–168.

In these two documents, two of the world’s great aerodynamicists—both of them former Prandtl students at Göttingen—evaluated the problems and potentialities of airships, one (Dr. Max M. Munk) from the vantage of 1935, the other (Dr. Theodore von Kármán) from the retrospective of 1962. It is interesting to find that both men remained generally quite positive about the potential of lighter-than-air vehicles.

Both documents connect to the Daniel Guggenheim Airship Institute, established at the University of Akron in 1932. Munk presented his paper at a meeting held at the Akron facility in July 1935. The chapter on lighter-than-air from von Kármán’s autobiography deals with the Caltech aerodynamicist’s many associations with the Airship Institute from its establishment in the early 1930s through the time of the Hindenburg explosion in 1937.

Both papers are fascinating: von Kármán’s for its anecdotes and personal insights into the airship developments and tragedies of the 1930s; Munk’s not only for its enumeration of airship research problems of the day, but for his unique definition of what he called “progressive” research. By this term, he meant a “scientific” approach that anticipated “future discoveries and achievements” and what “someone will find” rather than an engineering approach, one “that is not science, but merely requires science.” The latter, in Munk’s view, focused more on what was currently being found “along trodden paths” that stimulated industrial improvements “by emphasizing what seems to be harmful, combining what harmonizes, and eliminating what is at variance.” Not only is Munk’s preference for what “someone will find” over what “I found” essential to a proper understanding of Munk himself, but it also adds fuel to the fire of the ongoing historiographical debate over appropriate distinctions between scientific and engineering approaches to technological knowledge and understanding.

Document 5-8 (a), Max M. Munk, "On the Problems of Progressive Airship Research," in Report on Airship Forum, July 25–26, 1935 (Akron, OH: The Daniel Guggenheim Airship Institute, Publication No. 3, 1935), pp. 89–96.

I am very grateful to the Daniel Guggenheim Airship Institute for this opportunity to talk to you, and through you to the rest of the country, about the problems of progressive airship research, for it seems to me very necessary that something be said about it at this moment. By the term "progressive" research I mean that studying, meditating, investigating, and experimenting in scientific spirit, the results of which are intended to inspire the engineer and designer to venture upon and enter into new paths of industrial progress. Advancing along trodden paths, making industrial improvements by emphasizing what seems to be harmful, combining what harmonizes, eliminating what is at variance—that too requires careful studying and experimenting, and a high expert training to do it well. Research along that line is also very necessary and praiseworthy, no laudable attributes like "fundamental" and the like are too high and too dignified for describing and characterizing it. Only, gentlemen, that is not science, but merely requires science, and I will not talk about that now as not being progressive research. There exists, indeed, no sharp demarcation line between the two kinds of research, and the distinction has to be illustrated by extreme cases. Take this for instance. I am informed that the Navy, or Army, I have forgotten which (probably both of them), requires a wind-tunnel test with a model of every airplane type it purchases. It has now happened that the airplane was delivered long ago and was found satisfactory and was performing well, and everything was fine except that the model test was still missing. The model test was then made after the airplane was already in commission. Very good. I personally see no reason why not, and the Navy and the Army generally have good reasons why they do things they are doing; and in this case the belated model test may still be of great value, in keeping up the statistics and for preparing for a reversal of the process, to make better conclusions from tests to airplanes. What I want to say is merely that that is not progressive research as I now intend to use the word.

Discussing progressive research in a general and broad way is not exactly what a true scientist is fond of doing, and I have always tried to be such a scientist. Neither the polemical nor the speculative is the domain of science, but rather the positive and definite. Speaking of progressive airship research savors of anticipating future discoveries and achievements; not the "I found" but "someone will find" is the keynote of it. A scientist dislikes to assume the part of a prophet, dislikes to predict in such intangible manner. Only strong and forceful reasons can induce him to overcome his dislike and to take a larger view of his subject.

Such reasons are now, however, present. These are critical days for the future of American lighter[er]than[er]air development. With exceedingly bright prospects on one hand, with dire and costly disappointments on the other, the country needs

the fullest information possible on all pertinent points influencing the decision on how much national assistance the airship should be accorded. Airship designers and airship operators are expected to give their fullest testimony. Airship scientists are now likewise under the obligation to speak out on what may be helpful in arriving at the soundest decision. Science should not remain silent at such a grave moment for mere reasons of modesty and of nicety of feeling. Science alone is in a position to illuminate one most important aspect which must not be overlooked before making a decision on our future national airship policy. Science does not shirk its duty, it now relaxes its usual reserve, and I will now, accordingly, enter into the discussion of the side of the lighter[-]than-air question belonging to science.

Namely, when earnestly reflecting on what really is at stake, one particular aspect which is easily overlooked, becomes outstanding. When we speak of lighter[-]than[-]air our thoughts naturally turn to the airships we have seen or have heard of, and to what they have achieved; also in what respects they failed and how, how they performed, what they accomplished, and how much they cost. That which is bodily before our eyes easily takes hold of our attention. There is now real danger that it may do so too much in this case. The great and important decision which has to be made does not really have reference to the present airship; what is at stake is not the future of the present airship, but it is the future of the future airship. Present airships are not future airships, they are impressive witnesses regarding the future airship, but not more than that. The future airship with its future performance and characteristics has to be weighed, whether that be worth further sacrifices. Whether we like it or not, we must appraise the value of the future and so far non-existent airship, so that we may decide on the price we are willing to pay for it now. And the eyes of the nation naturally turn to science for helpful clues in making that appraisal.

Some bitter criticism has been advanced against the airships so far built. I personally do not think that that criticism is well founded; the airships such as they are appear to me a miracle of achievement. I think they are already wonderful. Just that, however, is controversial, and I wish to leave the question as I found it. What I want to bring out is that this is not the primary question. Even those dissatisfied with the present airships admit that they serve the function of guiding us to other airships. The only way to create an airship industry is to build experimental airships in the best way we can—for instruction, for development, and as a bridge to a more perfect type. The crux of the question in issue is therefore what prospects we have for essential improvement of the present type. That now is the question about which science should not remain silent. While nobody can know exactly what to expect from future lighter[-]than[-]air craft, the scientist is a better appraiser of its prospects than anybody else. It is from science that inspirations for fundamental improvements must come. While science does not like to talk about the future, it constantly has the future in mind, and in such exceptional cases as this one should not withhold its advice.

One clue will be enough, and that refers to the status of airship science. The status of any industrial science indicates the status of the corresponding industrial development dependent on it. The simple question to be answered is merely whether airship science appears to be fulfilled, accomplished, having substantially given all it will ever give, and solved all the problems it will ever solve. Steam engine science, for instance, is old, and seems to be in that condition. Or is airship science still young, with many solvable progressive problems which have not been solved yet, with much scientific treasure in store that has not yet been handed out? Gentlemen. The sole contribution of this paper to the complex airship problem is the assertion that airship science is still young, virile, and has many problems of progressive research not touched, or hardly touched, which are highly pregnant of important airship improvements. This paper is exclusively devoted to that assertion, and to giving color to it by enumerating a list of such problems. Let everybody draw his own conclusions from such status of airship science to the probability for future airship improvements.

I wish the purpose for which I enumerate some airship research problems to be kept clearly in mind. This is not the time for concentrating on any one particular problem. Not whether one rivet is better than another rivet, but whether there is something in the airship or not, is now the question. The thing I wish to bring home is that there exist abundant airship problems not yet investigated. It matters less what they are. The list I am going to give is decidedly incomplete, for it is only what occurs right now to one man who has followed up the development. To other investigators naturally other and additional problems will occur. Neither do I want it understood that the problems I am going to mention are necessarily the most important ones or the most promising ones. Finally, I wish it to be clear that I am pointing out a list of problems merely for the purpose explained, but am not even trying to indicate the solution of these problems. If the solution would be known to me, the problems would no longer be problems. Things of the future are necessarily visionary, and I do not wish it to be understood that I recommend any particular new airship design principle. The decision on which scientific result to adopt in practical design rests with the designer anyhow, and is beyond the domain of science.

Before entering into the list of problems, I wish to dispose of one auxiliary question which has a close bearing on the subject. Most people are easily inclined to turn down new technical ideas, and do not even like to see them thoroughly investigated. I do not know whether this is for mere want of imagination, or whether it proceeds from laziness, because it is easier and more convenient not to do new things than to do them. Leaving things as they are may also often be more profitable for the immediate future. At an early stage this resistance to new ideas is particularly strong, thus the old antagonizes the new and bids defiance to it even before it is born. Now the favorite argument against the new is complication. A few words on complication are therefore pertinent.

Not each scientific inspiration and technical progress involves an increase of complication. Concrete highways are simpler than a rail system. But even if the improved product is more complicated than the old one, it may still be preferable to the simpler one. We prefer walking in shoes rather than to go barefooted. Our whole industrial development is co extensive with the gradual introduction of more and more complication. The great strides made by heavier-than air craft during the last decade are intimately tied up with the introduction of more complicated devices.

The great truth, then, seems to be that technical complication is not a pure evil, but is a necessary ingredient of technical progress. It is only relatively evil, it is the price to be paid for the gain. The fact that a new device is more complicated should not be enough to deter us from adopting it, as long as it can be shown that the greater complication is not out of proportion to the advantage gained. Neither does larger complication necessarily make a device less reliable.

How complicated a machine is allowed to be is indeed a difficult question, and depends on many intangible circumstances. How capable are we to cope with complication? If complication is the price, how rich are we to pay in that coin? The question is particularly important in connection with airships, because present day airships are essentially a German product, developed for German mentality, and adapted for German trends of action. What may have the proper amount of complication for a foreign nation may be entirely too primitive for America. We may require more ease of operation and be entirely prepared to pay the price for it in way of more complication. German mentality is very different from American mentality. Their social structure is different. Their system of education is very different. It all brings about the result that Germans are better fitted and prepared to assume the functions of machines, and Americans are better fitted and prepared to operate machines and to cope with their complications. An airship ideal for German requirements may be too primitive for the needs of this country. The question of complication should be carefully weighed with this in mind, before new design principles for airships are condemned.

I enter now into the discussion of specific problems of progressive airship research, which discussion, I hope, will demonstrate the abundance of such problems, and the corresponding brightness of the prospect for airship improvement. I begin with the problems most engineering-like in character, and gradually advance towards more abstract science.

I mention first the question of automatic control of airships. Surface ships and airplanes have been successfully and advantageously controlled automatically, and this may also be desirable for airships. It may result in smaller airloads on the structure and in larger security and comfort of travel. This large research project is still untouched in many respects, and recommends itself to the attention of the research engineer.

The broad idea is not new. There is a patent issued to Dr. Klemperer having reference to automatic control. Dr. Klemperer in his specification recommended

employing pressure effects near the bow or stern for actuating the controls. It seems to me well worth while to look closer into the question of whether a point midships would not be more suitable for that purpose. The question of dynamic stability comes in. It is not enough that there are static forces brought into being, tending to turn the ship's axis into its normal flying position. It is also necessary to dampen and diminish any angular velocity the hull may have assumed. Mathematical analysis will show that with respect to angular velocity effects, the nose position for control actuating pressure devices introduces unstable effects, and conversely the stern position introduces stiffening effects.

The question of automatic control is closely connected with that of bow control. Placing a portion of the fin areas at the bow rather than at the stern would relieve the structural loads both with respect to air forces and static weights, and would improve the steering technique. Such bow control should then also be used for stabilizing the ship longitudinally. For such purpose it would probably have to be automatically operated. Among the questions associated with the problem of bow control is the one whether such bow controls should also be automatic while the ship is turning, or only while it is flying straight ahead. The general dimensions of such control surfaces, the time requirements for their operation, are among the quantities to be determined.

The question of dynamic lift in connection with bow control should not be overlooked. If the control is evenly divided between bow and stern, no dynamic lift would result naturally, but would have to be specially provided for. The control arrangement would have to be modified for that purpose.

The bow control is closely connected with the question of best propeller position. Relieving the stern of the weight of the fins, or part of it, may make it possible to place propellers in the wake of the airship, thereby increasing the efficiency considerably, and getting either more speed or saving fuel and engine power. Technical data on that question should be welcome.

It has also been seriously proposed to place the propellers inside the hull, in a tunnel extending from bow to stern. There are obstacles to that scheme, but also reasons for it. All objects of large air resistance, such as the power plants, the radiators, the water recovery apparatus, could be arranged inside of the tunnel, and thus the propellers would operate in their wake, with the corresponding gain in efficiency.

The question of tunnel or no tunnel centers about the air resistance of the air flowing through the tunnel. In large pipes the resistance per unit surface is generally smaller than the corresponding figure of the hull resistance. Furthermore, the aerodynamics of large pipes has hardly been studied, and such pipes or tunnels may lend themselves to aerodynamic improvements not applicable to the outside hull.

The slipstream loss of the entunneled propellers is an important item. That question should receive a prominent place in any program of progressive airship research. Means likely to cut down that loss should be studied.

This leads us to the propeller itself. Aerial propellers are among the most efficient devices human ingenuity has invented. There is not much margin left for an increase in their maximum efficiency, but even a little counts much in this case. The propeller could, however, be adapted to give its high efficiency to a larger range of flying conditions than it does now. It could be better adapted to the needs of the engine. Variable pitch propellers are a step in the former direction.

With entunneled propellers, the question of the necessary dimensions and revolutions comes up. The thrust of the propeller is then not necessarily equal to the effective thrust of the drive. This may lead to more favorable diameters and revolutions.

It seems to me very worth while, in this connection, to study the question of reduction of propeller noise. This is a most important problem of aviation, on which little progress has been made in the past.

Once a propeller tunnel is provided, it could also be used for ground control of the airship, that is for its motion and control at very low speeds, at which speeds the ordinary controls fail. The necessary forces and time factors need study.

The air flowing through such tunnel is too scarce in volume to affect the outside flow primarily. It may, however, affect the hull drag just the same. All cars and obstacles are removed from the vicinity of the hull surface, which certainly will be reflected in a smaller drag. The drawing of the air into the tunnel entrance may secondarily affect the hull flow by boundary layer effects, and some unexpected advantages may be gained.

It is very likely that the tunnel may also lend itself to a practical boundary layer control of the hull flow. The use of boundary layer control for creating control forces and for creating dynamic lift should be seriously studied. The hull has an immense surface; it seems absurd, in some respects, to add surface thereto by the provision of fins. An entirely finless airship, with boundary layer control taking the place of fins and rudders, is a distinct potentiality. That would be an ideal way to eliminate the weights and structural loads inherent in the fin system, and also to save resistance.

It is probably more difficult to use boundary control directly for a successful diminishment of the hull drag. The energy needed for such control may be too large, for it must always be kept in mind that the kinetic energy absorbed by the boundary layer effects is of the same order of magnitude as the horsepower available. However, as long as it is not conclusively demonstrated that such method is unpractical, hope should not be abandoned. The airship lends itself better to such schemes than the airplane does, because its drag problem is its major problem, the dimensions are larger and the shape is simpler. Streamlining is carried to greater length. I see possible ways which may work out all right in the end. In their present state they still look absurd, so much so that I am ashamed to describe the ideas. Nobody likes to be laughed at as a fantastic dreamer.

So was I once laughed at when I brought forward the autogyro idea, before the advent of De La Cierva's autogyro. Today it is in the air. So, no doubt, was that

inventor laughed at, who proposed to tie inflated rubber hose around the rims of carriage wheels. Complicated, unreliable, absurd that idea then appeared, but the whole city of Akron testifies particularly to the fact that the idea worked out not so bad after all.

The boundary layer problem naturally reminds us of the turbulence problem, a fundamental scientific problem on which much effort has been spent and little clearness obtained. Much would be gained by the solution of this most basic problem of aerodynamics. The efforts to solve it should not be diminished. It seems to me in that connection that the airflow studies so far have been too much concentrated on potential flows. The vortuous air motions of many descriptions should also be carefully studied and their physical laws explored. This should be done in both ways, theoretically and experimentally. The ordinary wind-tunnels are not the only instruments of flow research, and merely making them larger and larger requires the least imagination, but it is not enough.

I am engaged in giving evidence for the proposition that aerodynamic science is still far from being brought to anything resembling its conclusion. In that connection it is important to show that even the most general foundation of that science is still in the state of vigorous growth. I myself, only during the past year, have been privileged to discover a very broad and fundamental theorem relating to fluid motion, of geometric nature, and as broad as all geometry. This gathering seems to me a worthy occasion to announce that theorem publicly for the first time.

My theorem relates to the momentum of a body of fluid of constant density. It states that that momentum is always equal to the static moment of the source and sink system of the body of fluid, regarding the flux through the boundary of the fluid as part of such system too. The remarkable feature of the theorem is that it holds always, whatever the motion of the fluid may be. No matter whether this is the motion of an ideal or of a viscous fluid, whether it move[s] regularly or irregularly, steadily or unsteadily, whether the motion has a potential or not, if only the motion is conceivable by human intellect and continuous enough to compute the sources and sinks, that theorem must hold and can be employed with profit. In order to have in this paper something more than a mere enumeration of problems, I will indicate how the correctness of the problems may be demonstrated.

Imagine one pair of a source and sink of equal strength. Let all fluid being delivered flow to the sink through a narrow straight tube. Let this tube like region have constant cross-section. The velocity within is then constant and the momentum easily computed, being equal to the product of the density of the fluid, of the volume of the tube, and of the velocity of the fluid.

Now double the volume by doubling the cross section of the tube. The velocity then drops to one half, and hence the above product, the momentum, remains the same. The same for any other ratio of cross section increase. The same is true if only a portion of the tube is thus increased or diminished. It follows, then, that each straight tube, of whatever variable cross-section, will give the same momentum. But

the shape of the tube axis may also change, it must not be straight. All components at right angles to the connecting straight line cancel each other so far as the contribution to the momentum is concerned. All thin tubes taking care of the delivery volume and connecting the pair of sink and source have equal momentum.

From that to a three dimensional problem is only a small step. The whole space can be divided up into a plurality of tubes, as just discussed. A three dimensional source and sink system can be divided up into a plurality of pairs of equivalent sources and sinks. The arguments broaden in application, but not in content. In such way the theorem stands demonstrated.

I consider the arguments just sketched in the nature of an illustration, rather than in the nature of a proof. Simple as the illustration seems to be, the theorem was not found that way, and neither does the illustration amount to a rigorous proof. Such fundamental theorems stand out like pinnacles in mountains of geometry. In the mountains, the shortest way is directly from peak to peak, but for that it requires a strong pair of wings. In geometry, we have a method serving the same end. Vector analysis is such a pair of wings, which connects outstanding propositions directly along the shortest path. By means of vector analysis I discovered my momentum theorem, and by means of vector analysis can it be proven positively and without doubt. I cannot go deeply into questions of mathematics at this opportunity, the proof I am now referring to is reserved for another paper. Merely to illustrate the vigor and conciseness of vector analysis, I will write down here the one simple equation, which contains in a nutshell the entire proof:

$$V.v; r = V.v r + v.V; r$$

Only a few simple letters and symbols take the place of the long story required before, and the certainty obtained is far superior. Vector analysis should be given more attention by future scientists who intend to contribute to theoretical advances of aerodynamics. The turbulence problem may some day be solved by means of it.

All these were aerodynamic problems. They occur most naturally to me, aerodynamics being my special line. With respect to structural questions, it just occurs to me that a little more may be done to obtain light on the question of how to prevent crinkling of thin walled structural members. A mere exploration as to what conditions solid smooth cylinders crinkle under is not sufficient. More such problems will naturally occur to structural research experts. Many other problems will occur to the respective experts in other technical sciences which are also used in airship building and operating. What has been enumerated should be enough to show the abundance of problems that wait for solution.

The existence of a vast progressive airship research program conceded, there still remains a serious question, which may at least be touched. Are we in this country prepared, organized, and actually in a position to undertake successfully such a program necessary for perfecting the airship? Up to now, most progressive research

was imported from Europe, and I myself am an incarnation of that principle. We can no longer depend on that source of information. At best, we could only obtain information fitted for foreign needs, and even as far as that is concerned, the policies in Europe are becoming more and more nationalistic and seclusive; what scientific work can still be done under the political conditions of today will be kept secret. If adequate progressive research results are to become available to us at all, they must come from within our country.

The problem is only partly a question of how to secure the necessary funds. That is not even the main problem. Progressive research is comparatively cheap, much cheaper than industrial routine research. Superabundance of funds is even harmful, as tending to attract those not qualified for progressive research work, but smart enough to usurp the place of the genuine investigators. Even if the money is provided, it must also be conducted to the right men. Only to few is it given to see the mysteries of science, and only these are qualified to carry out successfully and efficiently progressive research work. Unskillful will-be or make-believe investigators do more harm than merely to squander the funds unprofitably; they give wrong information to the designers. They not only fail to advance science, they actually retrovert it, turning clearness into confusion, light into darkness, and if that happens too often, the entire respect for the prestige of science and research will at last be fully undermined, and we will then have no such endeavor in our country. The main problem is to turn the progressive research work over to the capable, honest, and really fitted men, and to provide a dignified and permanent haven for them, so that they may entirely concentrate on that sublime work.

I would venture to say that in that connection there seems to me to be no reason for pessimism. Many American universities and similar institutes, such as this one the hospitality of which we are just enjoying, are in a condition to supply that principal need for progressive research. There is also a strong trend on the part of agencies of the Federal Government to undertake research work. There too the necessary conditions for success can be created. There is no reason why federal agencies cannot be organized so as to provide permanent and dignified positions for capable and constructive scientists. On the contrary, there is abundant evidence that they can very well. Many of them have done that for many years—the Department of Agriculture, the Department of Commerce, the Library of Congress, the Army, the Navy, and the National Bureau of Standards have done so. Others who have not done it so far will no doubt follow eventually.

I see all conditions present, therefore, for expecting fundamental improvements of the lighter-*than*-air art during the next decade, provided a demand for it is exhibited. I have tried to explain in this paper what causes me to harbor such an opinion. Impassionately considered, such improvements appear to be a distinct potentiality.

This potentiality should be given due and deserving weight when laying down authoritative recommendations regarding the future American lighter-*than*-air

policy. In case of doubt, when the pro and con hang in balance, the thought of this potentiality should resolve the doubt for, and turn the opinion in favor of, a strong national policy for airship development. We, who have seen more of the possibilities of the airship than the general public has, and who know its possibilities better than they do, let us stand together at this moment to procure to the American people complete information on airships and advice that is really for the best of the nation.

DISCUSSION:

DR. KLEMPERER:

Bow elevators have been tried on early airships, and experimentation with them was recently resumed on our blimp *Defender* and in extensive wind tunnel tests. The flight tests show that it is feasible to control an airship by the bow, and that bow controls help in hurdling ground obstacles. However, the dynamic lift or climb which can be produced by inclining both bow and stern control surfaces in parallel, with the ship held at zero pitch, is small as compared with the conventionally pitched ship; to create much lift in this fashion the control surfaces would have to be very large. Bow control surfaces cast a wake, or downwash, upon the tail empennage of an airship.

Automatic control will eventually be adopted in airships, without doubt. A certain type of automatic control has already given encouraging results on the *Graf Zeppelin* and the same is true of various types of servo controls on the *Defender*.

Dr. Lewis then introduced Lieutenant Commander F.W. Reichelderfer, U. S. Navy.

Document 5-8 (b), Theodore von Kármán, "Lighter Than Air," in The Wind and Beyond: Theodore von Kármán, Pioneer in Aviation and Pathfinder in Space (Boston and Toronto: Little, Brown and Co., 1967), pp. 159–168.

One day in 1930 I received a letter from my old Aachen friend and assistant of the glider days, Wolfgang Klemperer. He advised me that he and his boss, Karl Arnstein, a leading airship designer, were developing some new and interesting lighter-than-air craft designs for Goodyear Tire and Rubber Co. in Akron. Goodyear, I knew, had bought the lighter-than-air patents from the German Zeppelin Company six years earlier. The sale had included the German scientists.

Now that I was in the States, Klemperer and Arnstein wanted to know whether I would like to assume my former role as consultant to the new American Zeppelin manufacturers.

In my mind the handsome gas filled bags of the skies were one of the great products of early aeronautical engineering. I believed in them. I thought they were graceful and practical exhibitions of what man could do in the way of comfortable long distance transport. From a technical point of view I thought they were highly efficient vehicles and I believed at the time they were unnecessarily losing out to the airplane, which was faster but not as efficient or as comfortable for long journeys. On top of that the memory of pleasant visits to Lake Constance near the Swiss-German border gave me an added warm feeling toward Zeppelins.

I did not hesitate to say yes to the offer. Thus began one of the most unusual episodes in my long association with the U.S. aircraft industry. I love continuity and I thought it a good sign for the future that my first industrial association should be with old friends and with a development that appealed to me.

Goodyear's involvement in Zeppelin manufacture stemmed from the company's interest in transoceanic travel and to a larger extent from the U.S. Navy's interest. The Navy had taken charge of military Zeppelins at the end of World War I. From 1919 to 1923 they built the USS *Shenandoah*, the first American rigid dirigible, based in part on the design of two World War I German Zeppelins, the L-33 and L-49. Unfortunately, just two years after her maiden voyage the *Shenandoah* tore apart and was destroyed in midair during a storm over Ohio. Captain Zachary Lansdowne, the commanding officer, and thirteen of his men lost their lives.

The Navy investigated the tragedy thoroughly and concluded that the ship had not been strong enough to resist gusts. They suggested improvements, but expressed faith in the basic design. A year later Congress authorized construction of two larger and stronger Zeppelins.

Experimental research on Zeppelin behavior and design was left largely in private hands, which in this case were those of my friend Harry Guggenheim, who early saw the need for basic study in this pioneer field. Because he planned to make the city of Akron the world center of airship research, he had supplied funds to establish a four-story airship research institute at Akron Airport. The Institute

was to be guided and operated from Pasadena under my direction, although it was attached to the University of Akron. This was actually part of Millikan's grand plan, which he had indicated he would put into effect when he first asked me to head the Guggenheim Laboratory.

I placed the design and construction of the Institute in charge of Dr. Theodor Troller, one of my senior assistants, whom I called from Aachen in January 1931. I also brought in Hans Bucken, the chief designer at Aachen, while Frank Wattendorf was borrowed from Cal Tech for the year 1930–1931 to assist in aerodynamic design. When the job was completed in 1932, Troller accepted the position of Resident Director of the Airship Institute.

No special problems were encountered in building the Institute, but I do remember an amusing incident that occurred during the construction. I had proposed that we build a vertical wind tunnel instead of the usual horizontal one. To some designers this was as radical as suggesting a square football to a coach. A few laboratories used small vertical tunnels to study airplane spin, but nobody had considered this type of tunnel for investigating the aerodynamics of an airship. Yet it had a strong advantage. The airship model could be suspended like a plump sausage on relatively simple supports, making experiments easier and saving considerable laboratory space. So a vertical tunnel was designed and installed in the Institute early in 1932.

One day I noticed that an air show in town featured a girl parachutist, so I promptly suggested, half in jest, that we should hire her to break in the tunnel. She could float in the updraft while we determined the effectiveness of various wind forces on her chute. I was always in favor of such direct and pleasant experimentation. Unfortunately the pretty young aerialist took one startled look into the dark throat of the thirty foot long wind tunnel and quickly turned us down. She said it didn't look safe. I didn't have the heart to tell her that jumping from a balloon into free air could be even more dangerous. Anyway, since the press wanted to take her picture in the airship institute, we put up a safety screen at the opening of the tunnel and she proceeded to pose with great safety for the newsreel cameras.

Our first official project in the new institute was to investigate the nature of the wind forces that act on an airship in flight. One of the forces, of course, is turbulence, the main source of drag. To design airships scientifically with regard to the dynamic conditions in the air[,] we knew from the outset that we would have to go much deeper into the anatomy of turbulence than had the Germans in the early Zeppelin days.

Turbulence was an old friend. Indeed, as the reader will remember, it had been the focus of an international competition in 1930—just before we began work in Akron—between me and my old Gottingen professor, Ludwig Prandtl. The turbulence I had been working with then was on a small scale—such as one finds when air or water goes through tubes. Now for purposes of contributing to airship design it was necessary for me to extend my horizons—to think in terms of thick turbulent air masses that cling to the airship and cause skin friction.

We looked toward making appropriate tests in Akron, but in view of the large scale the thought occurred to me that I might find in nature a system of turbulence such as occurs when a Zeppelin is in motion.

My attention finally became centered on the air movements over Pikes Peak as revealed by the motion of the clouds. This was actually more representative of air movements to which an airship might be subjected under certain meteorological conditions than anything I could create in the laboratory at Cal Tech or at Akron.

Slow motion pictures of clouds passing over Pikes Peak showed the creation of turbulence on the grand scale, and when speeded up on the screen, the vortices looked like those I had seen when the air moved past a model in the wind tunnel. Size in itself is not important. Nature is wonderfully harmonious in big and little things, in the heavens and in the narrow confines of a syringe or an oil pad for the Palomar telescope. Some years later I wrote a paper entitled "Heavenly Turbulence" to demonstrate that even the motions of great star galaxies far out in space are similar to the motions of submicroscopic molecules in a gas or a whirling spray of water.

Unfortunately and somewhat ironically[,] the two great American airships, the ill fated *Akron* and *Macon*, which were being built contemporaneously with the Institute, were born too early to benefit from these investigations.

The USS *Akron* was christened in 1931 and was then the world's largest airship, having captured this title from her predecessor, the *Los Angeles*. I went on one of the *Akron's* trial flights over Lake Erie, and traveling at a good cruising speed of seventy knots, I felt there was something magnificent and luxurious about this huge cigar shaped balloon. Everything I had felt about the Zeppelins was crystallized here. The ship was comfortable, noiseless, and smooth. You had an abundance of space. You weren't restricted in movement as in an airplane. I recall sitting back in the vertical fin and enjoying through the window an unobstructed panoramic view of the Great Lakes and the beautiful surrounding countryside. It was exhilarating.

Lieutenant Commander Charles E. Rosendahl ("Rosie"), one of the few survivors of the *Shenandoah* disaster of 1925 and America's best-known dirigible skipper, was in charge of the ship that day, but after a year or so he relinquished the command to Commander Alger H. Dresel, who in turn gave it to Commander Frank C. McCord. On the fateful day—April 4, 1933—the ship was taken out on maneuvers with Rear Admiral William Moffet, Chief of the Navy Bureau of Aeronautics, aboard. Moffet was a great fan of airships. "She's the safest dirigible ever built," Moffet said to the press.

But he was overoptimistic. Off the Jersey coast a storm blew up and grew more violent by the hour. The *Akron* was hurled about, shaken, and twisted like a toy that has fallen into disfavor. The radio went dead. Rain battered the silver skin and gusts of wind slammed the hull like heavy breakers. Nothing could withstand the fury. The *Akron* crashed into the Atlantic. In minutes the beautiful ship was gone, and seventy[-]three men of the crew of seventy[-]six lost their lives. Three men managed to cling to wreckage until help came.

I was deeply concerned with the cause of this disaster, especially since the U.S. Weather Bureau had reported for that day a storm intensity below the danger level for flight. What had gone wrong? Was it poor workmanship? Was it an aerodynamic failure? Or a meteorological mistake?

Back in Pasadena I called in several Cal Tech experts, but no one was able to contribute more than I already knew. Shortly thereafter I received a phone call from a young graduate student working in the Geology Department for Professor Beno Gutenberg, the earthquake expert. The caller said he believed he had information that could uncover the secret of the crash.

I told him to come right over. A personable young man soon appeared at my door and identified himself as Irving Krick. Spreading out charts and maps, he explained that an atmospheric condition had appeared off the New Jersey coast which was not fully considered in the official U.S. Weather Bureau forecasts. Air masses traveling in opposite directions at great speed had collided head on exactly above the spot where the *Akron* had crashed. The fronts of these masses had met like two powerful armies. The *Akron* was the unwitting victim of a gigantic air battle.

I was delighted with the explanation. Here was the return of an old friend—a beautiful double vortex, one powerful cylinder of pressure turning upward, the other counter-rotating, creating between them incredible forces that the poor *Akron* had never been designed to withstand. I called in Tollmien. We agreed that this explanation of Krick's was not perfect, but I thought that it was perhaps eighty per cent right. For me that was enough for a decision. That day I released to the papers Krick's explanation of the *Akron* crash. It brought Krick and his meteorological methods a great deal of attention.

At Cal Tech we concluded that better meteorology would be an important adjunct in airship travel, as well as for many military purposes. I suggested to Millikan that one of the future applications of fluid mechanics would be the establishment of a "reasonable meteorology" and that we ought to begin to teach it at the Institute. Actually, very few academicians accepted meteorology because it was regarded as a guessing science. I thought, however, that it had a good chance of becoming respectable. Millikan agreed with me, and added the study of weather to the curriculum.

I also suggested that we send Krick to Bergen, Norway, to study under Professor Bjerknes, the leading advocate of the new "scientific meteorology." After his return Krick was made head of the newly formed Cal Tech meteorology department. General H. H. (Hap) Arnold, Chief of the Army Air Corps, was attracted to the new course and sent some of his officers to enroll in the classes.

Later during World War II, as Air Force meteorological specialists, Krick and his associates were responsible for selecting the day for General Eisenhower to launch the Normandy invasion. They also picked the time for the Battle of the Bulge and the crossing of the Rhine. Krick's prediction that the Rhine wouldn't

flood enabled the Allies to cross into Germany more than two months ahead of schedule. After the war Krick broke with Cal Tech and went on to become an internationally known commercial weather forecaster.

One of my other recommendations was to establish an objective theoretical and experimental study of the forces that could influence air-ships in different conditions of flight. This led to the comprehensive experimental program on turbulence, some of whose results were discussed earlier.

But in spite of all our efforts, forces beyond our control were operating against the future of lighter-than-air craft.

On February 12, 1935, we were stunned by the news that the *Akron's* larger and more elegant sister ship, the USS *Macon*, had met with a catastrophe. The ship was cruising at 1250 feet off Point Sur, California, on the way to her berth in Sunnyvale when a blast of wind (as it was described later) ripped away the upper fin leaving a gaping hole in the frame. Commander Wiley, a survivor of the *Akron* disaster, managed to maneuver the crippled airship to the sea surface. As her tail slipped into the waves, a panic stricken crewman leaped from the *Macon's* nose, 125 feet down to the sea. He was killed on impact with the water. Another crew member also lost his life trying to reach the water. The rest of the crew—eighty[-]one men in all—were saved.

After the *Macon* accident, many people, including President Roosevelt, became dubious about the worth of airships. The situation had changed overnight. Unlike the *Akron* accident, which was regarded as unavoidable, the *Macon's* demise could not be easily explained. Even the naval Court of Inquiry, convened to determine the causes of the accident, could not readily point to a clear-cut explanation. The *Macon* had been in duty condition. The commander handled the ship well. The ship had been designed by the best available talent, and all the normal forces likely to act on the structures were calculated on rational principles (except for gust effects, whose study I had pushed hard). Finally, even the weather which the *Macon* encountered could not be regarded as violent enough to endanger the airship. Yet the *Macon* had joined the long list of lost airships.

I again called in Krick in the hope that he could recreate the weather at the time of the disaster and see whether anything had been overlooked. We discovered an interesting phenomenon. The *Macon* had actually run into hidden turbulence, or what modern meteorologists call an occluded front. We issued a press statement explaining how this phenomenon might have contributed to the cause of the accident.

The statement, I recall, unexpectedly played an important role in my personal life. I was applying for American citizenship at this time and had carefully prepared myself on United States history and the Constitution.

When I appeared in court, the judge said: "So you are Professor Theodore von Karman. I read about you in the papers. Tell me what happened with the *Macon*."

As I explained the phenomenon of the occluded front, the judge listened intently and nodded. Without further questions he asked me to hold up my hand

and I was sworn in. I never did get a chance to show off my hard won knowledge of American history.

Controversy over the *Macon* disaster raged for some time, and the Navy was growing pessimistic about the future of the lighter-than-air program.

Before abandoning the program entirely, however, Secretary of the Navy Claude Swanson asked Dr. Karl T. Compton, Chairman of the Science Advisory Board, to appoint an impartial committee to review the situation and to determine future policy in general on lighter-than-air craft. I was a member of that Special Committee on Airships, as it was called, and my colleagues included such leading engineers and scientists of the day as William Hovgaard of M.I.T., R. A. Millikan, Stephen Timoshenko, the structures expert from Stanford, F. B. Jewett, President of Bell Telephone Laboratories, C. F. Kettering of General Motors, W. F. Durand of Stanford, and A. V. de Forest of M.I.T. Durand was chairman.

The committee's work did not always take place in an atmosphere of academic calm. I recall that in May 1935 Professor de Forest, who was in charge of the investigation into materials, reported to Durand that while the materials used in the airship were on the whole quite reliable, the fins were imperfectly constructed. He laid the blame on the Navy. He accused them of failing to listen to Dr. Arnstein of Goodyear Zeppelin, who had made an exhaustive study of the fins and recommended reinforcements. In July, de Forest blurted out these feelings to an Akron newspaperwoman, saying that the Navy was at fault "especially the Washington go betweens." A furor was created. Secretary Swanson demanded an explanation from Durand, and Captain Rosendahl and others talked about a Congressional investigation.

I was indignant. Not only did I think Congress or any other group of laymen was unqualified to investigate and pass judgment on technical problems, but I had great personal faith in Commander Garland Fulton, the naval officer in charge of the lighter-than-air section. In August I wrote Dr. Millikan a letter, pointing out that the Navy had accepted Arnstein's suggestions for reinforcements of the fin and its supporting frame, but that the work was not completed at Sunnyvale because the Navy, upon consultation with Goodyear, saw no emergency and thought it more important for the ship to continue on Pacific maneuvers.

I suspected that de Forest's attack on the Navy had to do with the Goodyear Zeppelin Corporation interests, which may have wished to place the blame elsewhere to avoid possible criticism of themselves. My own conclusion was that nobody could really be blamed for these airship tragedies, because our knowledge of airship aerodynamics was incomplete at the time the ships were designed. Whether or not reinforcements in the fins were absolutely necessary was a matter of judgment alone.

Durand thought of firing de Forest for talking out of turn and embarrassing the committee. I suggested that he be retained, since his removal might be construed as a whitewash of the Navy, with de Forest possibly emerging as the only

committee member with courage. Durand finally decided to keep de Forest in his post to prevent problems with “yellow journalism.”

During the deliberations of our committee, an international conference was held in Akron to discuss the status of airship development from a scientific and engineering standpoint and to assess the general outlook for Zeppelins. At this conference the adherents of lighter-than-air collided with the supporters of heavier-than-air craft, which was then making big strides. The discussion was quite vigorous and I do not remember all the impassioned speeches, but I do recall that Sir William Farren of Cambridge, a well known British aviation expert, lightened the tense atmosphere by beginning his talk with the anecdote of a visitor to Dublin who finds two Irish groups fighting violently in the streets. He goes up to one of the participants and says: “Excuse me, is this a private fight, or can anybody join in?”

Farren then went on to say that he was doubtful of the worth of the airship.

I must say that I agreed with him up to a point. At that time one could not foresee that airship speeds would ever be much greater than seventy knots. Since the wind could easily exceed this speed, an airship flight was in danger of missing a time schedule in stormy weather and the ship might easily run out of fuel. Even though the airship was basically economical as a means of transport, it looked doubtful for Atlantic crossing where windstorms are strong and frequent.

Our Special Committee on Airships wound up the bulk of its work at the end of 1935 and reported to Secretary Swanson on January 16, 1936. We said it was our general feeling that the Navy and others had been too complacent about the airworthiness of the ships and that they were given their regular naval assignments too soon without treating them as full scale models for further study. Our study indicated that with the lessons drawn from the casualties we could now build airships with the probability of a repetition “reduced to a point acceptable in comparison with the promise of useful service.” We recommended that the Navy continue with a “considered program of airship construction.” I was very much in favor of this, as I didn’t think it wise for the Navy to leave dirigible research and construction entirely to the Germans.

Unfortunately for advocates of lighter-than-air craft, Germany’s *Hindenburg*, the largest rigid airship ever built, burned to the ground in 1937 on its arrival at Lakehurst, New Jersey. As many people know, the devastating fire could have been avoided if the Germans had used helium instead of the highly inflammable hydrogen. But helium was available only in the United States, and a law had been passed in 1927 which prohibited sale of the scarce gas to foreigners. I recall that my old friend, Dr. Hugo Eckener of the Zeppelin Company, spent ten years of his life trying to influence the United States to change its law, so that his dream of a transatlantic airship line could become a reality.

He was finally successful in 1937, when Congress changed the law. But by then it was too late. Hitler’s rise to power, and the overriding fear of a new war, made the

U.S. government change its mind about selling helium to the Germans. Eckener pleaded with the Secretary of the Interior, Harold Ickes, but to no avail.

The final humiliating blow to the Zeppelins occurred in 1942, when Hitler ordered the great *Graf Zeppelin* dismantled and used the aluminum for airplanes. A year later, in a gesture of contempt to the grand old airships, Goering, the Nazi Minister of Air, ordered the hangars blown up at Friedrichshafen, where the Zeppelin was born.

Physically, the failure of the *Hindenburg* was not an outright condemnation of airships, but psychologically they were through. The public could no longer support these accident prone giants.

Despite this, I have always felt kindly disposed toward the airship, and even now in 1962, I believe it may yet be possible to save them by combining jet propulsion with propellers so that the airship speed would increase with higher efficiency. One could put the drive in the rear, using "shrouded" propellers, which are more efficient than the three propellers of the Zeppelin. I think an airship of this design could conceivably do two hundred miles an hour—three times greater than the maximum speed of the Zeppelin when it was at the height of its popularity. If so, it could be a useful, quiet, and economical method of transporting heavy freight and many people across long distances.

Recently, airships were suggested as a means of transporting the huge thousand ton sections of the *Saturn*, the moonship, from the factory to Cape Canaveral, a thousand miles away. But the Air Force turned down the idea, saying the method was not economical. Instead they used river going barges, which I believe ran into trouble when one of the locks on the Tennessee River collapsed because it could not support the heavy weight of the cargo. I am not at all sure that airships should be abandoned, and I felt a twinge of pain when recently I read in the papers that the great Akron center, where so many of my days in the early thirties were spent, was being torn down for a real estate subdivision. Thus the past glories slip into oblivion.

Document 5-9 (a–b)

(a) Max M. Munk, “Preface: Aerodynamics of Airships,” in *Aerodynamic Theory: A General Review of Progress, Under a Grant of the Guggenheim Fund for the Promotion of Aeronautics*, vol. 6, ed. William F. Durand (Berlin: Julius Springer, 1934), pp. 32–33.

(b) Karl Arnstein and Wolfgang Klemperer, excerpts from “Performance of Airships,” in *Aerodynamic Theory: A General Review of Progress, Under a Grant of the Guggenheim Fund for the Promotion of Aeronautics*, vol. 6, ed. William F. Durand (Berlin: Julius Springer, 1934), pp. 69–80 and pp. 88–102.

One of the greatest aerodynamic publications of any time period was the six-volume *Aerodynamic Theory*, edited by eminent Stanford University professor William F. Durand in 1934. “Division Q” and “Division R” of this series, which appeared in volume 6, both concerned airships. For the former, Dr. Max Munk, lecturer in aerodynamics at Catholic University of America in Washington, DC, and technical editor of *Aero Digest* magazine, wrote an essay entitled “Aerodynamics of Airships.” Because most of the ideas in it were repeated in a more popular and less mathematical fashion in his 1935 paper before the Daniel Guggenheim Airship Institute (see Document 5-8), we have only included the preface and introduction to his “Division Q” contribution here. Following that are long excerpts from “Division R,” a paper titled “The Performance of Airships” by Dr. Karl Arnstein, chief engineer of the Goodyear-Zeppelin Company, and Wolfgang Klemperer, Arnstein’s leading research engineer in Akron. Both men came to work in the United States from Germany following World War I. What will be found below are sections from this paper relating most directly to aerodynamic concerns—notably thoughts on resistance of the hull, resistance of “accessories” (i.e., outside appendages and protuberances), and experimental determination of drag. The excerpting concludes with a long section on “dynamic lift.” For an airship, this sort of aerodynamically derived lift was generated primarily due to the large size of the exposed surfaces involved, notably the airship hull but also the fins and control surfaces.

Document 5-9 (a), Max M. Munk, "Preface: Aerodynamics of Airships," in Aerodynamic Theory: A General Review of Progress, Under a Grant of the Guggenheim Fund for the Promotion of Aeronautics, vol. 6, ed. William F. Durand (Berlin: Julius Springer, 1934), pp. 32-33.

Airship design leans more heavily on aerodynamic theory than does airplane design. Individual airships are much larger and more expensive than airplanes; the completed airship structure can much less readily be modified after its completion, so that the trial and error method is practically not as available for airships as for airplanes; furthermore, there is available comparatively much less experience from earlier airships because not many have been built, and even wind tunnel tests, although they have always been diligently undertaken, carry less persuasion in consequence of the larger scale effect and the larger sensitivity to such effect and to other doubt-inviting factors. All this is indicative of the need of a further development of airship aerodynamics as a foundation for further progress in the construction of large airships. Moreover, since airship design draws on the whole domain of aerodynamics and since special airship aerodynamics should contain as its most notable problem the full analysis of airship drag, it seems quite possible that from airship theory may some day come forward such fundamental progress in aerodynamics as shall revolutionize our technique of air travel.

Airship design involves, as a special field, the investigation of air forces brought into existence by the motion through the air of large, bulky, streamlined solids. The theory of the influence of air friction on these forces, in spite of strenuous efforts, has not yet been developed to a satisfactory status and has not been included in the treatment of the present Division. For this aspect of the general problem, the reader is referred to Division G. The present Division deals only with the theoretical motion of a perfect fluid, and constitutes an application of the principles and results developed in Division C.

The author presents herewith the results of an effort to organize airship aerodynamics along certain well defined logical steps, leading to a unitary, complete and convenient system of mathematical procedure. During the last decade this system has been received and used in the mathematical computations for the design of large airships built during that period. It is hoped that it may thus constitute a permanent nucleus for the development of applied airship aerodynamics.

The basic subdivisions for such foundation for an applied theory are as follows: (A) The resultant or integral aerodynamic effect of the entire airship structure is approximated by a superposition of the air forces on the bare hull, deduced from the laws of classical hydrodynamics, and of the air forces on the fin and control surfaces, assumed to follow the laws of modern airfoil theory. (B) The local distribution of the air forces along the axis and the pressure distribution is computed on the basis of a large elongation of the airship hull, thus reducing the actual three-dimensional flow around the hull to a superposition of two-dimensional flows. (C) The errors

introduced by these assumptions are taken care of by the introduction of constant correction multipliers. (D) A three-dimensional flow for a mathematically simple shape is used for the computation of the pressure distribution over the bow region. (E) The general results of strict theory, valid for certain mathematically simple shapes, are generalized by means of engineering rules to cover practical shapes.

In studying the developments of the present Division, the reader will find it helpful to keep in mind these successive steps or stages, as guides or connecting links between the successive sections.

1. Introduction. The aerodynamic theory of airships deals with the loads imposed on the structural system of airships by the air forces, and with the problem of stability and the required fin areas. As a basic assumption the theory assumes the substitution of a perfect, non-viscous fluid for air, and for this reason fails to be of use for the computation of the performance, since solids moving in a perfect fluid experience no resistance. The actual resistance of airship hulls, while not indeed zero, is, however, surprisingly small relative to their bulk, and arises almost entirely from the direct action of viscous forces.

The present treatment is based chiefly on the theory and the solutions discussed in Division C.

The exact results comprised in that Division are confined to a very small number of shapes, all of great mathematical simplicity. It is the object of the present section to discuss the application of these results to airship shapes empirically given. This must be carried out through approximations in accordance with the usual procedure when applying the results of rigorous mathematical methods to the problems of nature. Indeed, improvements in the mathematical methods would be of little further use. The main source of the disagreement between the computed air forces and pressures and the actual ones is not the lack of better mathematical methods, but the incorrectness of the physical assumptions, especially the neglect of the viscosity. In view of the discrepancy between computation and observation caused by the viscosity of the air, the methods discussed in Division C are exact enough, and are furthermore sufficient for most practical purposes.

We proceed then with some discussion of approximate methods for the computation of the numerical values of such aerodynamic quantities as we shall need.

Document 5-9 (b), Karl Arnstein and Wolfgang Klemperer, excerpts from "Performance of Airships," in Aerodynamic Theory: A General Review of Progress, Under a Grant of the Guggenheim Fund for the Promotion of Aeronautics, vol. 6, ed. William F. Durand (Berlin: Julius Springer, 1934), pp. 69–80 and pp. 88–102.

2. Resistance of Hull. The knowledge of the drag of an airship is of principal importance for the prediction in the design stage of its speed or power requirement. The most important single item of drag is that of the huge hull, although through careful streamlining it has become possible to reduce this drag to such a low figure that the sum of the drag contributions of the inevitable appendages and accessories of the ship, though themselves much smaller in size, may be of equal order of magnitude. The problem of aerodynamic improvement in hull shape would seem to resolve itself into finding the form of least drag for a given volume which latter [*sic*] dictates the gross lift obtainable.

Designers have not yet standardized on any particular shape or form of airship hull as "the best" for all purposes. It is commonly understood, however, that a smooth meridional curve preserving continuity up to derivatives of the second order, all along from stem to stern is desirable. Several simple mathematically defined curves, chosen for individual portions of the hull, are often combined for the sake of simplicity in mathematical calculations of such items as the buoyancy and pitching moments of various compartments when empty or partly deflated. If cleverly done, so as to match inclination and curvatures at the junction points, only negligible increase of drag may be incurred and the procedure justified. On the other hand, some investigators have tried to develop formulae from which an entire meridional curve of a good shape smooth in all derivatives can be developed. Such formulae, especially when based on relatively simple source and sink concepts, may have practical advantages in the design office, but to what degree they can insure low drag for a given volume beyond securing smoothness, is problematical. However, there seems to be general agreement that the bow may, to good advantage, be somewhat blunter than an ellipsoid, although if mooring equipment requires a conical nose, no serious harm is done by such form. The insertion of a short cylindrical midship section does not seem to appreciably harm an otherwise good continuously curved shape. The curvature, usually decreasing from bow to master section[,] is usually increased again toward the stern. This latter change, however, should be very easy and gentle. To what degree the tail end may be cut off more or less bluntly without serious harm is a matter of some uncertainty.

The question of the best fineness ratio (Diameter to Length) cannot be decided in a general way either. The history of airship design shows uncertain tendencies alternating between fuller and slenderer forms. Many ships, however, may have become more slender than their designers wished, either because they were to fit into available hangars, or because they were subsequently lengthened after some

service in order to increase their useful load for more ambitious journeys. As the very slender form implies more surface per volume, it must cope with more frictional drag, whereas the more plump form introduces more severe curvature of the stream lines, thus giving rise to more rapid growth of boundary layer in the rear and earlier separation of flow. In general there is but little to choose, as far as drag is concerned, from $L/D = 4$ to 8. The optimum is broad with reference to this ratio so that structural considerations which depend upon the details of the design may govern the choice. As a rule non rigid airships are advantageously made more plump, rigid ships built of annular frames and longitudinals, more slender.

While with many other vehicles the ratio of resistance against motion to the gross weight carried represents the "frictional coefficient" or "gliding angle" which constitutes a measure of the degree of mechanical perfection, with airships this measure depends greatly upon both size and speed.

If the air resistance were always proportional to the exposed area and the velocity head, the refinement of any shape would be truly reflected by a drag coefficient C_D referred to unit velocity head and to the two thirds power of the volume according to the formula

$$D = C_D \frac{\rho V^2}{2} Q^{2/3} \quad (2.1)$$

where $D = \text{drag}$ $V = \text{speed}$
 $C_D = \text{drag coefficient}$ $Q = \text{volume}$
 $\rho = \text{density of air}$

The $2/3$ power of the volume is preferable to the master section area commonly adopted in airplane fuselage aerodynamics, since the best shape for housing a given volume is not necessarily the same as that providing the best fairing for a given master section. The former is more slender than the latter. In some scientific publications a drag coefficient is determined by reference to the hull surface exposed.

The drag coefficient is, of course, not a true constant, but depends on the Reynolds number R for the ship's size and speed. Reynolds numbers are usually referred either to the cube root of the volume or to the length of the ship. Reynolds numbers of large rigid airships at commercial speeds are of the order of 10^8 to 10^{10} and from ten to several hundred times larger than can at present be obtained in model experiments in wind tunnels. Insofar as the hull drag is essentially skin friction, its mechanism may vary sensitively with change of Reynolds number. Therefore the extrapolation from the value of the resistance for any known limited range of R to much higher ranges is quite uncertain, and even if data are available for one type of hull shape, it would be quite unsafe to presume similar relations for other shapes. For very large models tested in atmospheric tunnels giving a value of $L \times V$ greater than 100 m.² per second, as well as in the moderate and high compression range of the N.A.C.A. variable density wind tunnel, and for full size airships

of slender stream-line shape, a steady drop of the resistance coefficient varying at a rate somewhere between $R^{-0.17}$ and $R^{-0.08}$ has often been observed. A ship may thus have as little as half the drag coefficient shown by its model tests.

All this appears quite reasonable in the light of modern theories of the variations of turbulent boundary layer friction drag, postulating either an exponent of -0.20 or more recently a logarithmic law which expresses a lesser influence than an exponent of -0.20 with increasing Reynolds number.

Tests seem to indicate that the more slender the ship's form the more beneficial the "scale effect" to be expected. The more plump form apparently gives rise to an element of the drag due to actual flow detachments at the tail, the magnitude of which would more nearly follow a velocity square law. Small scale model tests are severely handicapped and many show freak drag coefficients quite unsuitable for such extrapolation.

While there has been a great deal of airship model testing in various wind tunnels[,] many discrepancies were noted in the early data. In 1920 an international program was instigated for the testing of two small airship models in many laboratories throughout the world. Even the results of these tests showed wide variations proving that there were obscuring influences due to the air flow in these laboratories or to the experimental technique employed.

Since that time knowledge has been greatly advanced and it appears that there are six major phenomena which are apt to obscure comparative model test results unless their influence is carefully determined and proper corrections made for them.

The first of these phenomena is the presence of a pressure gradient dp/dx in most closed wind tunnels. This causes an axial buoyancy of the order of Qdp/dx or more accurately, $K_x Qdp/dx^6$, by which the measured drag appears too high. Where the pressure gradient is not constant along the region occupied by a long model, or in open jet tunnels where it is usually confined to a small region near the jet entrance nozzle, the product Qdp/dx is more logically replaced by $\int_0^L S dp$ where S is the cross sectional area of the model at the station where, in its absence, the pressure p would prevail. This integration can be readily carried out as indicated in Fig. 7 especially if the gradient pressures vary in proportion with the tunnel velocity head without change in characteristics.

The second argument concerns the measurement of the effective velocity head of the test. In an open jet tunnel obviously the difference between the total dynamic head and the static pressure prevailing in the

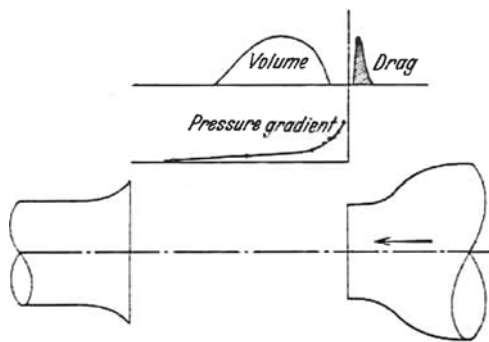

FIGURE 7. Correction for pressure gradient.

experiment chamber surrounding the jet is a representative measure for the effective velocity head although not necessarily exactly identical with that of free flight conditions. In a closed tunnel, however, the velocity head varies over the entire space surrounding the model, so that a definition of speed measurement becomes necessary, or corrections may have to be computed if the tunnel speed is measured at an arbitrary place in the tunnel and referred to a different standard station. The different degree of flow constraint offered by the open and by the closed tunnel make it doubtful if the drag of any one model should be expected to appear the same in both tunnels. In the open tunnel a given model may act like a fatter one in free air; in the closed tunnel like a slimmer one in free air.

The third phenomenon apt to obscure model drag test results is the tare drag and flow interference caused by the suspension system connecting the model to the balances. The determination of the net drag of airship models by wind tunnel experiment requires great experimental skill. The forces are small and it is often difficult to keep the suspension tare drag sufficiently low to prevent the final value resulting as the difference between two large quantities. Where the model is suspended by wires, it is necessary to exercise great care to avoid flow obstructions or disturbances at the attachment points without at the same time introducing mechanical constraint. In addition the tare drag area of the wires may vary with the tunnel speed.

The earlier method of determining the tare drag by means of a test with all suspension members doubled is usually less accurate than the dummy method in which the model is independently suspended in place while the original suspension system is alone acting on the balance without contact with the model. Spindle or jig suspensions are very treacherous unless the utmost care is taken to avoid mutual influence of flow. Even if only a tail spindle protrudes from the model, its anchorage on a strut or rig downstream may cause sufficient stagnation of the flow upstream to obscure the delicate drag of the model, as was discovered at the Langley Memorial Laboratory.

The fourth obscuring influence is inherent in small Reynolds number experiments where a large part of the boundary layer is laminar while with increasing Reynolds number the transition point from laminar to turbulent boundary layer creeps forward on the model until turbulent flow prevails throughout, as it undoubtedly does in full size. Jones has demonstrated that the peculiar and seemingly erratic drop and rise of the drag coefficient observed in many small scale tests can be readily interpreted as due to such a travel of the inception of turbulence. He also demonstrated that the magnitude of the lowest observed drag values fits well a theoretical laminar friction of a flat plate of similar extension as the exposed surface and that for higher Reynolds number[s] the theoretical turbulent friction of an equivalent flat plate is approached. Millikan has refined this picture very much by reconciling these measured drags with those to be computed for a body of revolution retaining from the flat plate theory merely the $\frac{1}{7}$ th power profile law.

The next step along this line is the substitution of the Kármán-Prandtl logarithmic profile law, with possibly the introduction of the influence of the surface taper and curvature upon this profile law.

The fifth obscuring influence is the turbulence inherent in the tunnel. It has a bearing on the prevalence of turbulence in the boundary layer. In more turbulent air, naturally more of the layer is turbulent than in smooth air at the same Reynolds number. This has been demonstrated by introducing artificial turbulence into the tunnel air either by annular protuberances placed on the bow of the model or by wire screens placed upstream. It has therefore been suggested that airship model tests, if they must be done at Reynolds numbers insufficiently large to ensure essentially turbulent boundary layer, be made with the air stream rendered artificially turbulent and this turbulence measured by the sphere drag or other methods. However, Jones questions the adequacy of this artifice.

The last of the six factors to be considered is the smoothness of the surface. While some investigators have found large variations of drag with surface conditions, others have found practically none. These differences may be due to different turbulence regimes. Smooth wax-polished model surfaces seem to give the lowest and most consistent drag results. In full size the skin of both metal clad and well doped or rubberized fabric covered airships can probably be considered as aerodynamically "smooth".

For unusually rough hulls the theory of friction on rough surfaces would apply. Th v. Kármán has shown that in order to be aerodynamically smooth the hull of airships should not have a roughness exceeding .03 to .04 mm over the greater part of their length, the very bow being the most sensitive. Well doped taut fabric and thin sheet metal under pressure are smooth within this specification. However, in actual service, fabric may flap when not taut and metal sheet may be wrinkled and studded with rivet heads. To what degree such surface irregularities may influence the mechanism of impulse transmission in the boundary layer is still problematical.

In summarizing it may be said that while an injudicious application of wind tunnel test drag measurements to a full size project can be quantitatively and qualitatively grossly misleading, the prediction of full size drag need not necessarily depend solely on a digest of actual flight experience and service performance. On the contrary careful model tests at suitable Reynolds number[s] under controlled turbulence and surface conditions are quite apt to reveal the degree of perfection of a proposed shape with respect to skin friction and pressure drag. For good shapes the full size drag can then be calculated with a satisfactory degree of reliability, confirmed by actual flight performances of ships built.

Theoretically it is interesting to compare the measured drag with the impulse left in the wake which is a large portion of the whole; and with the pressure drag from normal pressure measurements by integration over the projected area elements which, with efficient shapes, is a very small portion of the whole.

3. Resistance of Accessories. It has not yet been found feasible to house all of the equipment of an airship within the streamlined hull, although there prevails a decided tendency to eliminate more and more of the outside appendages and protuberances. So long as individual propellers are disposed about the ship there are outriggers or complete power cars outside which require individual fairing. The control car accommodating the navigating crew is usually located in the forward lower part of the hull. An empennage is carried at the tail. Furthermore, ground handling and mooring attachments usually protrude from the hull. Last but not least there are items of equipment such as radiators and other devices for the exchange of heat, and likewise hoods and vents for the intake or expulsion of ventilation air and again certain navigational instruments, all of which depend upon exposure to the outside air for their proper operation.

Evidently the drag of such protuberances and appendages can be calculated from model experiments made on much larger scale than for the ship as a whole. In all of this, allowance must of course be made for any local excess or deficiency of airspeed due to the potential flow or the boundary layer about the ship.

Occasionally, relatively small protuberances, especially on the forebody on a model tested at [a] low Reynolds number, have shown an apparent influence by way of an increase of drag far beyond any normal expectation based on the drag of the protuberance itself. That similar freak influences would occur in full dimension seems rather doubtful in the light of experiments made with artificial "spoilers" on full size ships and in high Reynolds number model tests.

The drag of nacelles or power cars can be estimated from experiments on similar objects occurring in heavier than air design provided allowance is made, if necessary, for the proximity to the airship hull which acts as a mirror surface of the wash of the propeller slip stream, and if need be, of the flow through such a car containing a radiator vent, or the like.

Undoubtedly the most favorable location, from the viewpoint of drag, for a radiator, water condenser, or other heat exchange device, would be just inside the hull so that the skin of the ship, the friction of which is inevitable, could be utilized as a heat radiating surface without adding parasite resistance. The area required in such case is, of course, much larger, since the heat must traverse the entire boundary layer of the hull. However in view of the fact that the heat transfer varies with a fractional power of the velocity head, the handicap is not necessarily insurmountable. Just how far the finning of a heat exchange apparatus should protrude into the ship's boundary layer is a matter of design compromise into which considerations of space available, weight, complication and maintenance enter, aside from the mere question of drag.

The drag of the fins of an airship can be computed from model experimental data with a similar degree of accuracy as in the case of airplanes, excepting only that their huge size renders a beneficial scale effect of frictional resistance of importance. For conservative estimates, however, it is well to add a certain average of induced

drag to the form drag of fins and control surfaces, because in flight they are, for reasons to be explained later, almost continuously under some attack—a condition which entails the development of induced drag along with the forces of control. The more stable the ship the less the allowance required in this respect.

A sample list of accessories drag is given in Table 1 for three typical rigid airships as estimated under certain experimental conditions, without water recovery apparatus. The accuracy of any analysis of the gross drag of an airship into various parts is naturally dependent upon the availability of uniformly accurate data on the contributions of all these parts. By attributing different degrees of importance to the various component data derived from indirect evidence, conclusions can be shifted somewhat.

TABLE 1.

Estimated Drag Area Breakdown Without Water Recovery	Bodensee		U.S.S. Los Angeles		U.S.S. Macon	
	Sq. M.	Sq. Ft.	Sq. M.	Sq. Ft.	Sq. M.	Sq. Ft.
A. Bare Hull	9.4	101	21.8	235	39.0	420
B. Fins and Rudders	2.5	27	4.9	53	14.0	151
C. Wing Power Cars or Outrigger Gears, Their Suspension, Ladders, Struts, Hoods, Radiators, Exhaust Mufflers	2.8	30	6.8	73	10.7	115
D. Rear Power Car with Handling Rails and Bumpers	2.4	26	2.2	23.5		
E. Control Car or Passenger Car with Handling Rails and Bumpers	2.4	26	4.5	48	2.8	30
F. Miscellaneous Protrusions-Mooring Mast Equipment, Hoods, etc.	0.5	5	0.8	8.5	1.8	19
	20.0	215	41.0	441	68.3	735
(Volume) ^{3/4}	790	8500	1845	19852	3528	37978
Resistance Coefficient C_D	0.25		0.22		0.19	

4. Experimental Determination of Drag. The combined drag of the hull and of the accessories—the gross drag—enters into speed and performance computations. Measurement of this gross drag may be attempted by direct experiment full size. It would be interesting to measure this drag directly by towing from another airship. So far this has not yet been accomplished, but undoubtedly will be some day. Measuring the thrust of the propellers would also furnish a measure of the drag. However, consideration must be given to the force reactions due to the presence of the propeller wake impinging on part of the structure. An analysis of the problem has been given by Durand. Successful thrust dynamometers to be inserted between shaft and propeller hub have been constructed and it would be only a

matter of carrying out such a test program to obtain exhaustive data. However, the costs and elaborate preparations necessary have thus far prevented such a test. Thrust measurements on one of the five propellers of the U.S.S. *Los Angeles* were made by the Zeppelin Company and served to confirm the resistance estimates under various operating conditions and engine combinations. However, the experimental error multiplied by 5 and the uncertainty regarding the degree to which the five propellers could be considered identical and equally loaded, limit the accuracy of the conclusions.

There is, however, an indirect method available for the determination of the gross drag, the so-called “deceleration” or “coasting” test. The ship is flown at its top speed and then suddenly on signal all engines are stopped. The ship gradually slows down and the deceleration process is recorded by suitable airspeed meters. The underlying theory of the evaluation of the deceleration records is based on the equilibrium between the aerodynamic drag and the inertia force.

$$D = -M(1 + k_1) \frac{dV}{dt} \tag{4.1}$$

where M is the ship’s mass, k_1 the contribution of the virtual longitudinal mass due to potential flow and boundary layer, and V the velocity at the time t . If the ship is in buoyancy equilibrium, $M = \rho Q$ and if the drag is expressed as in (2.1) we have immediately

$$C_D = -2Q^{1/2} (1 + k_1) \frac{dV}{V^2 dt}$$

However, since $-d V/V^2 = d(1/V)$ this becomes,

$$C_D = 2Q^{1/2} (1 + k_1) \frac{d}{dt} \left(\frac{1}{V} \right)$$

If then $1/V$ is plotted against time, the slope of the curve is indicative of the drag coefficient. Figure 8 shows a sample record of an original coasting test, and Fig. 9 its evaluation in terms of $1/V$.

In some instances the curve of $1/V$ versus t appears quite straight, thus revealing no variation of the drag coefficient with speed. In other tests the curve appears concave as though indicating the regular “scale effect” of turbulent friction. Others invite interpretation as a broken line, as though two distinctly different slopes and drag coefficients prevail above and below a critical speed. Again others show more erratic

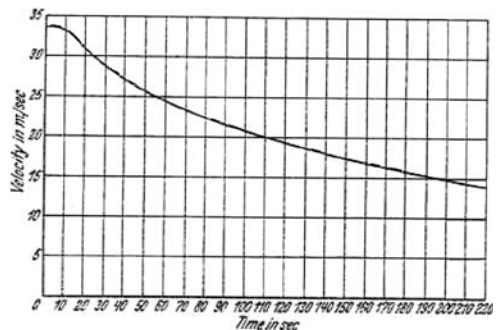

FIGURE 8. Deceleration test, velocity on time.

interpretation as a broken line, as though two distinctly different slopes and drag coefficients prevail above and below a critical speed. Again others show more erratic

behavior. However, all such detailed conclusions must be taken with due reserve considering the serious experimental difficulties which attend tests of this nature. The lag in the speed recorders, the influence of gusts and slight pitching or yawing of the ship, the drag due to rudder and especially to elevators, as well as the time required to bring the propellers to a stop often prevent experiments on even the same ship in the same flight repeated after only a short interval or with different measuring instruments, from giving duplicate results. For any accurate evaluation, automatic records of elevator angle, ship's inclination and altitude are indispensable. Proper correction for the drag due to pitch, elevator and propellers and the influence of possible lightness or heaviness of the ship have been found to straighten out the $1/V$ curves very remarkably in deceleration tests made in calm air, as shown in Figs. 10 and 11, taken from a typical experiment on a large rigid airship. In evaluating coasting tests the drag of the dead (or idling) propellers must be separately determined and subtracted from the experimental result in order to obtain the ship's own drag.

If the ship was not in perfect buoyancy equilibrium at the time the coasting test was run, a correction for the induced drag of the dynamic lift (L) or dip ($-L$) and for the difference between the ship's actual mass and that of the air displaced, *viz.*, $\pm L/g$, is required.

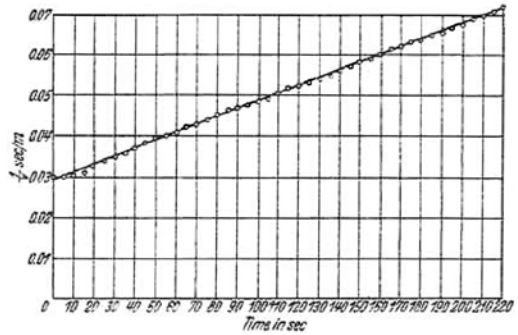

FIGURE 9. Deceleration test $1/V$ on time.

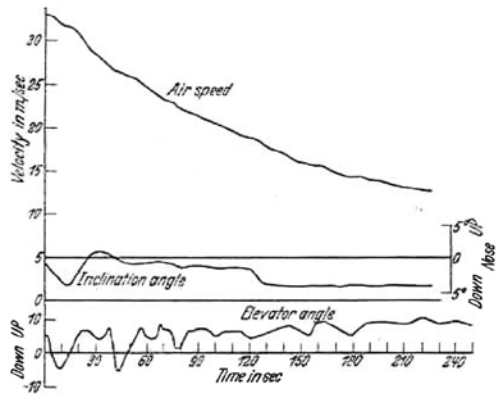

FIGURE 10. Deceleration test, velocity on time with records of inclination (pitch) and elevator angles.

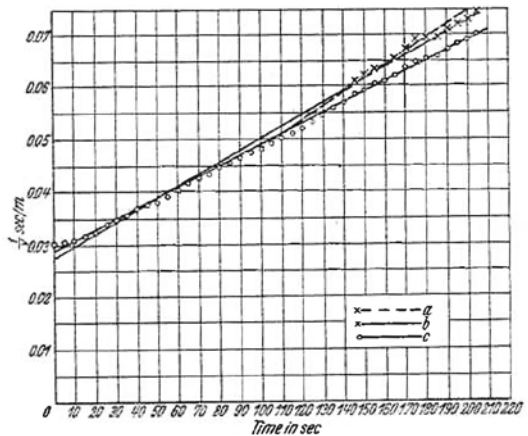

FIGURE 11. Deceleration test, $1/V$ on time. Observations corrected for pitch and elevator angles. a. Interpreted as a critical region, uncorrected. b. Faired average, uncorrected. c. Corrected for pitch and elevator action.

CHAPTER III DYNAMIC LIFT

1. Flight with Dynamic Lift. When an airship is propelled at an angle of attack, lift forces are created in a similar manner as by the wing of an airplane. It is true that the airship's shape as a wing is very poor and its aspect ratio extremely small; but the size of the exposed surfaces is so great that tremendous aerodynamic force components at right angles to the flight path can be evoked. A part of this "dynamic lift" is produced by the hull of the airship proper (not embraced by the classical treatment of the flow about the ship neglecting friction and circulation) and the rest by the fins and control surfaces which in appearance resemble stubby airplane wings and function to some degree as such.

Dynamic lift (upward) is resorted to whenever the ship becomes "heavier than air" or "heavy" as it is called in airship parlance. This may happen in various ways accidentally, or it may be brought about deliberately. Precipitation in the form of rain, snow or ice on the surface of a large ship may result in an added load of several tons. Running into a layer of warmer air will make the ship heavy due to the lag of the gas inside the ship in assuming temperature equilibrium. These are usually temporary conditions. Loss of buoyant gas through accidental injury of gas cells or in consequence of climbing above pressure height with resultant valving causes a permanent loss of buoyancy. On the other hand an overload may be taken aboard deliberately in the form of mail, passengers, or airplanes. In all these cases the ship flies "heavy", up by the nose at an angle of pitch which must be the larger the less the airspeed. In a similar manner a ship may become "light" and must be flown down by the nose (at a negative angle of pitch) when for instance load or ballast is dropped, or when radiation "superheats" the gas and air inside the ship; or again when liquid fuel is consumed.

It is the practice to avoid these conditions in any marked degree. Well planned navigation will usually succeed in anticipating their causes and in meeting them at least part way. However, they may occur on short notice or they may be accepted deliberately, and in consequence a study of their aerodynamic aspects assumes a definite importance. Transport economy is, of course, reduced by the induced drag accompanying the production of dynamic lift and it is easily seen that, if the voyage is long enough, the fuel consumed to overcome this induced drag might outweigh the increase of useful load so carried. However, for ships burning liquid fuel, which gradually become lighter as fuel is consumed, there would be a distinct advantage in taking off heavy and accepting the drawback of the induced drag for a short while, until equilibrium is regained. For instance if the "overload" at any time t is L , the time rate of change of L is given by

$$\frac{dL}{dt} = -fP \quad (1.1)$$

where f is the fuel consumption per unit of power and time and P is the instantaneous value of the motor horsepower. Assuming as a first approximation that the induced drag is proportional to the square of the lift and that the equivalent "wing aspect ratio" of the ship, so to speak, can be expressed by some "equivalent span", s , which may differ somewhat from the ship's maximum diameter, then the additional power which must be spent in excess of that due to the normal drag of the ship in equilibrium would be:

$$P_1 = \frac{L^2 V}{q \pi s^2 E}$$

where L = lift produced

q = velocity head = $(1/2)\rho V^2$,

s = equivalent span, i.e., the span of a wing (assuming elliptical distribution of the lift) which would give rise to the same drag increase and which must be known from experimental data,

E = propeller and drive efficiency.

Then referring to II (5.1), equation (1.1) takes the form:

$$\frac{dL}{dt} = -\frac{fV}{E} \left(qA_D + \frac{L^2}{q\pi s^2} \right)$$

This can be readily integrated and furnishes the gain in range $S = \int V dt$ for L from L_0 to 0 in the form

$$S = \frac{E_S}{f} \sqrt{\frac{\pi}{A_D}} \tan^{-1} \left(\frac{L_0}{q s \sqrt{\pi A_D}} \right)$$

or

$$S = \frac{E}{f} \sqrt{\frac{A'}{A_D}} \tan^{-1} \left(\frac{L_0}{q \sqrt{A' A_D}} \right)$$

where $A' = \pi s^2$ the "influence" area. Without the induced drag the range would have been

$$S_0 = \frac{E}{f} \frac{L_0}{q A_D} \quad (1.2)$$

The reduction of the range due to the induced drag can be expressed by the series

$$1 - \frac{1}{3} \frac{L^2}{q^2 A' A_D} + \frac{1}{5} \frac{L^4}{q^4 (A' A_D)^2} - \dots$$

The reduction becomes a noticeable percentage only for large overloads. The problem of carrying these during the take-off is a serious one. However, by taking off with artificial superheat secured from a heat source ashore it is possible to start with considerable overload provided the route does not require a high ceiling

at the beginning of the flight and before the gas has cooled down. The possibility of airships with heavy overloads taking off like airplanes has been demonstrated with small ships. However, the idea of a combination airship airplane, which so frequently fascinates inventors, would seem to have only very limited possibilities, unless means may be found for providing a very large wing spread which moreover must admit of folding in close to the body of the ship. Otherwise problems of housing would be complicated beyond any conceivable advantage to be gained.

The dynamic lift of airships is limited by the power available in a way similar to that of airplanes. There is an optimum combination of angle of attack and speed for which the maximum load can be carried with given power which is indicated by the maximum value of C_L^3/C_D^2 in a manner similar to that for the same problem with the airplane. This maximum carrying capacity would be attained at the angle of pitch for which the "induced" drag is three times the parasite drag, thus

$$C_L = \sqrt{3\pi\lambda C_D}$$

where λ = the equivalent "aspect ratio" which would have the same induced drag characteristic. Naturally C_L and C_D must be expressed with reference to the same area, for instance $Q^{2/3}$. In reality the maximum lift is much less than would appear from the λ valid for small angles of attack, because the validity of the parabolic induced drag law does not extend to sufficiently high angles, i.e., λ is not constant.

Beyond the angle of pitch corresponding to the condition of maximum lift for given power looms the "stall". If the dynamic lift were proportional to the angle of attack up to the stalling angle, the latter would be

$$\alpha^* = \sqrt{\frac{C_D}{dC_L/d\alpha}}$$

and the stalling speed would be $\sqrt[3]{1/4}$ (63%) of the top speed attainable under the same power in the absence of dynamic lift.

In reality the power available drops with the reduction of speed. Rather, it is the engine torque which remains essentially unaltered. Insofar as the actual propeller thrust T available at any speed V is approached by a parabola, $T = T_0 - C_T v^2 (\rho/2)$ $Q^{2/3}$, the power drop expresses itself in the form of an additional drag which makes the formula for the stalling angle α^* (in radians)

$$C_L = (C_D + C_T) dC_L d\alpha$$

or

$$\alpha^* = \sqrt{\frac{C_D + C_T}{dC_L/d\alpha}}$$

and the stalling speed in level flight would become $\sqrt{1/2} = 71\%$ of the top speed attained with the same engine throttle position in the absence of dynamic lift.

Similar to the airplane, the approach to the stall is essentially governed by the aerodynamic attack, and associated with a definite stalling angle of attack (pitch). However the overload that can be carried at this angle of attack depends on the slope ε of the ship's path. In a climb, less overload can be carried. The difference is in first approximation.

$$\frac{\Delta L}{L} = - \frac{\varepsilon}{(\alpha + \varepsilon) + (C_D + C_T)/C_L}$$

When a "heavy" ship, not yet heavy enough in level flight to approach a stall, is made to climb, it may prematurely stall; similarly a light ship, when it is made to descend. On the other hand when a heavy ship is allowed to descend or a light ship allowed to rise, an imminent stall is (temporarily) averted.

It is interesting to note that a heavy ship carrying its overload dynamically, when actually nosed down, ($-\varepsilon/\alpha > 1$) can "glide" and thereby pick up speed exactly as an airplane can. When light, and flying with dynamic down-dip it will "glide up" and pick up speed in so doing when permitted to nose up, unless the added drag of the elevator predominates.

On ships of conventional design, dynamic lift is associated with unwelcome stresses and demands upon controllability. This is due to the manner in which dynamic lift distributes itself unevenly over the length of the ship—a large part at the bow and a considerable amount at the stern, the two not necessarily in equilibrium about the center of buoyancy. In order to appreciate this it is convenient to consider the dynamic lifts of the hull and of the empennage separately as well as their mutual interference.

2. Dynamic Lift of the Hull. In a non-viscous fluid an elongated body (of volume Q) such as an airship hull moving at an acute angle of attack (α) between its longitudinal axis and its path would experience no force such as dynamic lift, but only an unstable deviating moment $(k_2 - k_1)Q \cdot q \sin 2\alpha$ where $(k_2 - k_1)$ denotes the difference of the virtual mass coefficients for the transverse and axial flow components and q the velocity head. This moment tends to increase the angle of attack and is largely concentrated on the bow and stern parts of the ship, the components acting there in opposite directions. For the detailed distribution of these transverse forces along the axis of the ship a first approximation is given in Division Q [equations (8.6), (8.7)]

$$b = (k_2 - k_1) \frac{dA}{dx} \sin 2\alpha \quad (2.1)$$

In wind tunnel tests the pitching moment weighed on the balances appears from 15 to 30 per cent smaller than this, and much less concentrated at the nose, especially for ships having a blunt bow. This is due to the fact that where the taper is pronounced, the equivalence between adjacent length elements and cylindrical slices acting upon the flow independent of each other is no longer valid. For an

ellipsoid of revolution for which the exact pressure distribution is known the integration around any conical slice at a station where the local taper angle between the tangent of the generatrix and the axis is τ and the local radius or ordinate to the generatrix is r , has the value

$$b = r \pi \sin 2 \alpha \sin 2 \tau$$

This is equivalent to the substitution of the variable $\cos^2 \tau$ for the constant $k_2 - k_1$ and even for ships whose bow is somewhat blunter than an ellipsoid gives a much better approximation, as pressure distribution measurements both on wind tunnel models and on ships in flight have shown.

A closer investigation and digest of wind tunnel results may require the introduction of corrections for the influences of the finite wind stream dimensions in the laboratory. In the open jet tunnel, at the jet boundary, the pressure influence due to the model is offset, so that there, actual velocity increments have faded out. In the closed tunnel there can be no radial velocity component at the tunnel walls in spite of the presence of the model, which at such distance in a free stream would, in most cases, still give rise to such a component.

For various reasons some designers prefer to choose a hull shape which is expressed by a relatively simple formula for the cross sectional area (S) in terms of the abscissa station (x) rather than for the ordinate r of the generatrix. For contours of this class it is sometimes convenient to express the transverse force breadth in terms of S and $S' = dS/dx$.

This is done by:

$$b = \frac{\sin 2 \alpha}{1/S' + S'/4 \pi S} = \frac{S' \sin 2 \alpha}{1 + S'^2/4 \pi S}$$

In order to accurately determine the theoretical distribution of the transverse force breadth for any given shape of hull, recourse may be had to methods given by v. Kármán or Kaplan and by Lotz of which the principal features are as follows:

A system of sources is determined and so distributed along the ship's axis or its hull surface as to represent the shape for the axial component flow and upon these is superimposed a system of doublets in such manner as to maintain the hull form against the cross component flow.

The pressures may then be computed and integrated around successive slices or zones from station to station, and the longitudinal distribution of transverse force thus determined.

For ships that are not very slender, the pitching moment is slightly smaller than the integral of the moments of the transverse forces, *viz.*, $q \int b x dx$ because the longitudinal components of the pressure contribute a restoring moment. Theoretically this reduction should amount to $-2\pi q r^2 \sin 2 \alpha \sin^2 \tau$ so that the total moment at

any station is reduced in the proportion $1:(1 - (r/x) \tan \tau)$. Again expressed in terms of cross section only, this zonal moment correction is

$$dM = \left(\frac{2\pi x - S'}{2\pi/S' + S'/2S} \right) q \sin 2\alpha dx$$

However, in reality, in model size as well as full size, the superposition of axial and transverse potential flows gives a faithful picture only in the front windward and midship region as can be readily visualized. When flying at an angle of pitch one longitudinal will be to the leeward; with a heavy ship the top one, with a light ship the bottom one. In this region and with actual fluids, the stream lines will be unable to close in behind, and in consequence the pressures will depart from those for a purely potential flow. The skin friction imparts vorticity to the flow and the trailing vortices form the counter part of a circulation which builds up mainly aft of the master section. Pressure distribution experiments on models show that in the rear part of the hull the negative forces (due to defect of pressure) fall considerably short of theoretical values. Figures 13a and 13b show a comparison between calculated pressure distributions and those measured on a wind tunnel model. This pressure deficiency is one of the causes of the difference between the theoretical moment of the hull and that weighed on the wind tunnel balances. It accompanies the development of a lift force. Th. v. Kármán has begun a theoretical treatment of this hull lift adducing plausible assumptions concerning the shedding of circulation.

For higher angles, both pressure distribution and model balance measurements indicate a quicker increase than in the ratio of the sine of the angle of pitch (see Fig. 14). It would therefore appear that the phenomenon of the detachment of

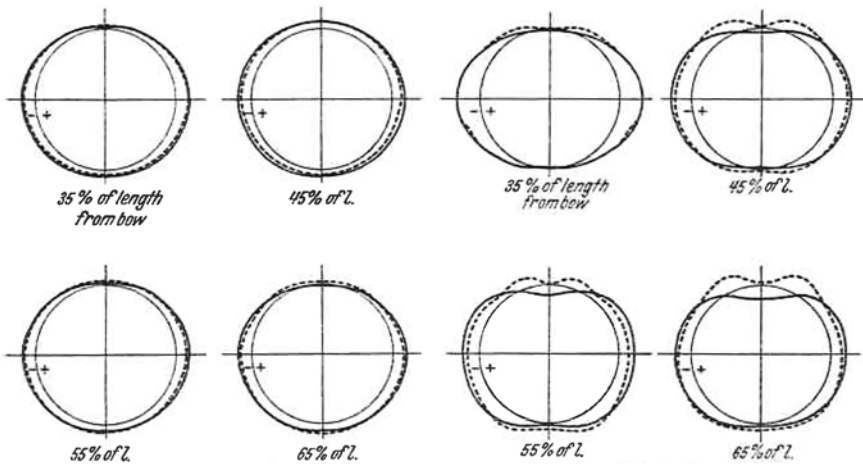

FIGURE 13A. Pressure distribution (circumferential) on airship model at pitch angle of 12° . Full lines, calculated values. Dotted lines, measured values.

FIGURE 13B. Pressure distribution (circumferential) on airship model at pitch angle of 18° . Full lines, calculated values. Dotted lines, measured values.

vortices on the lee side of an inclined streamlined body is controlled by a sensitive mechanism and that the area subject to it gradually expands upstream, both forward and circumferentially as the angle of attack is increased.

It is reasonable to expect that more insight into the mechanism of the lift of the hull or of the deviation of the pressure distribution from potential flow may be gained from a study of the vorticity in the wake of the acutely attacked hull. An elaborate study of this nature has been begun by Harrington. A survey of the velocity vector field in the wake reveals the presence of two vortex systems trailing downstream through the wake and showing many traits in common with the tip vortices of wings. Figure 15 is a typical example of the results of

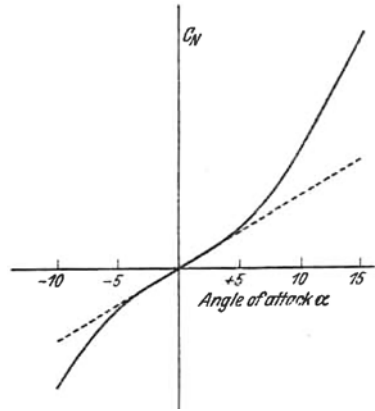

FIGURE 14. Diagram showing typical increase of dynamic lift with angle of attack.

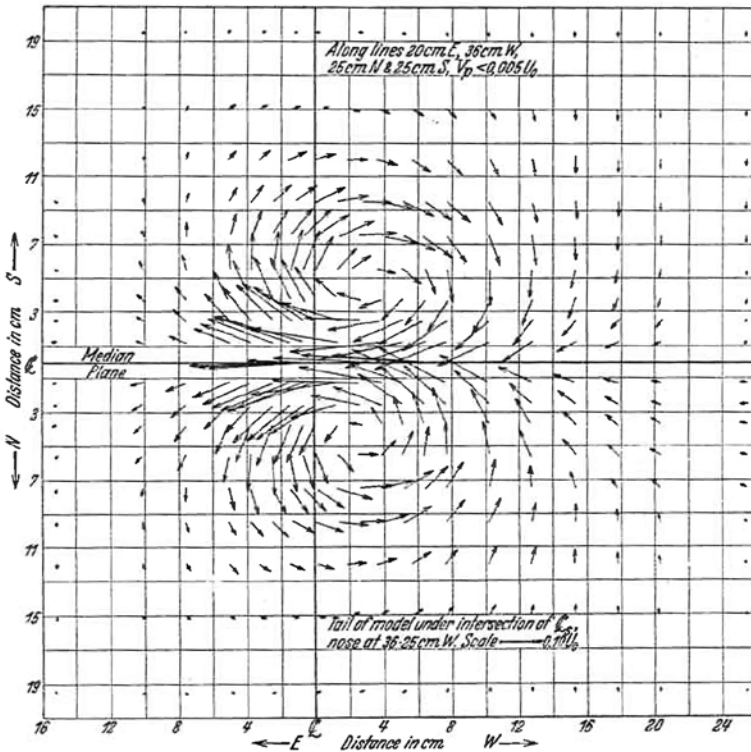

FIGURE 15. Velocity field in the wake of an airship. Induced velocity V_p in plane normal to U_0 located 20 cm. behind ellipsoid at $\alpha = 21.5^\circ$. $V^2 = v^2 + w^2$. Length of model = 99 cm. $U_0 = 22.3$ m./s. Fineness ratio = 6. Scale: $\text{---} = 0.10 U_0$.

Harrington's measurements. It is a picture of the transverse velocity components in a section of the wake 20 cm. behind the tail end of an ellipsoid of 99 cm. length and 16.5 cm. diameter attacked at an angle of 21.5° at an air speed of 22.3 m./sec.

To what degree the analogy of model and full size laws of hull lift are obscured by scale effect and turbulence is a question needing still further study.

At very large angles of attack, wind tunnel tests on conventional airship model sizes are likely to run into scale effect troubles as indicated by experiments on round and elliptical cylinders of such width and ellipticity as would correspond to the slant section of an airship parallel to the plane of flow at very high incidence.

The dynamic lift characteristics are also somewhat influenced by details of the form—whether round or polygonal or heart or pear shaped; likewise by unsymmetrical arrangements of form such as a pronounced keel structure or other features on the under side of the ship. In such cases the lift may not be zero for zero angle of attack.

The drag D of the bare hull (and indeed also of the ship with empennage) increases with the angle of pitch α , very approximately as the product of lift and $\tan \alpha$ or in other words the axial component T is, within wide angle limits, unaffected and the action of oblique attack is essentially the evocation of a force N normal to the ship's axis.

$$N = L \cos \alpha + D \sin \alpha$$

$$T = D \cos \alpha - L \sin \alpha$$

3. Lift Due to Fins. In order to neutralize the inherent directional instability of the elongated streamlined hull, airships are equipped with tail empennages in manner similar to an arrow. The action of these fins can, in first approximation, be approached by the airplane wing theory. They are airfoils, usually of either flat or biconvex symmetrical airfoil section, mostly tapered toward the rim. Their aerodynamic properties are somewhat difficult to compute and predict in terms of the classical wing theory because of five important secondary influences.

1. Their shape is usually, for engineering reasons, long, rather than wide, so that in terms of wing theory their aspect ratio is extraordinarily low. Therefore the spill over the edge becomes an important rather than negligible factor. The whole fin is a wing tip rather than a wing.
2. The part of the hull between opposite fins is usually so large that its size and shape have an important influence upon the flow about and the forces exerted upon the fins.
3. The angle of attack of the fins is influenced in marked degree by the induced "downwash" which trails off the preceding parts of the ship's hull. The magnitude of this downwash will further vary over the span of the fin.

4. The presence of fins when the ship is under an angle of attack influences again the pressures on the rear part of the hull, not only between and to the rear of the fins, but also considerably forward of them.
5. The roots of the fins are in a region of diminished velocity within the boundary layer of the hull.

It is, of course, conceivable to develop a specific method for introducing all these influences properly into a fin theory. For instance the presence of the hull between the fins can be accounted for by the substitution of a fictitious system of sources and sinks or doublets in its place, as is done in v. Kármán's method for dealing with monoplane wings rooted on a fuselage. However, if accurate representation of the actual facts is attempted, any such procedure suffers from the well known difficulties, attending the necessity of preserving the actual fore and aft distribution of lift, and, for the present, the problematic points regarding the generation of lift by the stern of the hull and its attendant downwash.

Many efforts have therefore been made to secure reliable experimental data. Full size experiments are very difficult and very expensive and have been limited largely to pressure distribution measurements. Many of the results are of limited value because of the extreme difficulties of measuring simultaneously the pressures at a sufficiently large number of distant orifice points while the aerodynamic condition of the ship is steady, though departing in marked degree from the simple condition of straight flight equilibrium. There is the further requirement that all parameters of the flight condition must be accurately determined. On the other hand most of the model tests suffer from uncertainty regarding the possible scale "effect". The larger the Reynolds number of the experiment the more valuable the results may appear. The least angular irregularity of flow in a wind tunnel when varying along the length of the experimental section may cause a first order error in the pitching moment measured on a long airship model, whereas with short airplane models, the corresponding error may appear negligibly small. In cases of large models, corrections for tunnel or jet wall influences upon induced drag and effective angle of attack as well as downwash may become in order, as with airplane models. In a closed tunnel the determination of the effective wind speed in the tunnel, as it is increasingly obstructed at larger angles of attack, deserves attention.

Practical experience has shown that a wide variety of fin forms and arrangements may be reasonably satisfactory and there are evidently a great number of variable parameters which may enter into any detailed appreciation of the actual aerodynamic characteristics of an airship empennage. A first approximation to the lift on a fin may be taken on the basis of the conventional airplane wing theory,

$$L = \frac{2\pi q S \alpha}{1 + 2S/b^2}$$

where S is the fin area, b its (effective) span, q the velocity head and α the angle of attack. According to the more trustworthy among model tests in wind tunnels (and

probably in a similar manner full scale), the actual stabilizing empennage force, as indicated by the difference of the lift with and without fins, is of the theoretical order of magnitude for very small angles of attack only, whereas for angles of practical interest and importance the force is much greater. Much of the surplus is of course borne by the part of the hull between the roots of the fins and even ahead of them. This share can be measured by

pressure distribution experiments, an example of which is presented in Fig. 16. The center of this stabilizing force is therefore not actually at the theoretical quarter chord point (a point not easily defined with fins whose leading edge gradually merges into the rim), but it may be farther forward when computed by dividing the

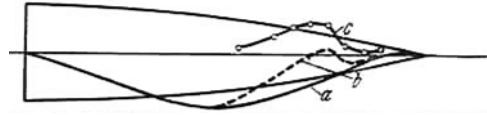

FIGURE 16. Distribution of pressure about the empennage. (a) Zonal force integrated from typical pressure distribution without empennage. (b) Zonal force integrated from typical pressure distribution with empennage. (c) Difference due to empennage.

difference in the stabilizing moments with and without fins by the difference of lift with and without fins. For the airship model of the U.S.S. *Los Angeles* to which Fig. 16 referred, this leverage is of the order of 78 m. from the center of buoyancy whereas the fins extend about 75 m. to 97-½ m. aft of this point. That neither the stabilizing force nor the stabilizing moment due to the fin appear to be even approximately proportional to the angle of attack may perhaps be regarded as an indication that this part of the hull which, between the fins, has the form of a well rounded body and thus does not offer a definite trailing edge, begins to build up its own contribution to the force only when higher angles of attack are reached.

Of the innumerable varieties of fin forms proposed or used on airships, only the major features can be here indicated. For details, reference must be made to the general literature of this subject. Flat fins produce slightly greater forces than fins built up of thick sections tapering from root to tip. The latter, however, offer structural and engineering advantages and are under certain circumstances preferred. Larger aspect ratio of a fin of otherwise fixed shape and location increases its action per unit area. Changing the shape mainly influences the location of the center of action and the pressure distribution. More pronounced leading edge and receding rim moves the center of action forward; a more slanting leading edge gradually flaring into the rim moves it aft. The pressure distribution is similar to that of wing tips. Most of the force is concentrated along the rim. Pressure distribution near the rim is influenced by an angle of yaw simultaneously present with an angle of pitch. Some sample pressure distributions are represented in Fig. 17. For further details reference may be made to the publications here noted. Moving a given set of fins farther forward or aft will increase or reduce respectively the fin forces but within certain limits may scarcely change the stabilizing moment. The most conventional form of empennage is an essentially symmetrical cruciform set of two pairs of fins, one upper and lower in the keel plane for directional

stabilization and the other, port and starboard, for stabilization against pitching. Many other arrangements such as box frames, ring shapes or more than four radial fins have also been tried. Problems of slant attack and mutual shielding from tip-spilling as well as biplane influences come into question in connection with these arrangements.

It is not necessary (nor held desirable by many) to make the fins so large that the moment about the C.B. of the empennaged ship shall be stable for all angles or even for moderate angles of attack, without the aid of the movable control surfaces or even with their aid. Floating without air speed, there is usually a certain small aerostatic stability due to a positive metacentric height. However[,] the elasticity of bulkheads and the floating of lower gas cell levels permit some surging of gas and reduce the metacentric height to less than the

value indicated by the level difference of the centers of buoyancy and gravity. As air speed is acquired, an additional (dynamic) metacentric height comes into play, subtractive when the aerodynamical moment is unstable. This dynamic term can, as H. R. Liebert has proposed, be expressed in terms of the velocity height $h = v^2/2g$, viz., $H^* = 2(k_2 - k_1)h(m/m_0)$ where m/m_0 is the ratio of the aerodynamic moments of the actual empennaged ship to the theoretical moment of the bare hull.

Finally there is always the expedient of shifting ballast so that equilibrium can be established. Just how much fin area is desirable for flying with dynamic lift is therefore largely dependent on navigational problems and on the mechanical and control apparatus provided aboard. It may be mentioned as significant, however, that, with large rigid airships, the first sign of growing heavier usually appears as a tendency to become tail-heavy so that the ship must fly nose up in order to maintain altitude, but with the need of "down elevator" to hold the ship in this attitude. With the ship growing light, corresponding indications, reverse in character, appear. In small nonrigid airships this phenomenon is rarely observed.

4. Dynamic Lift Experiments. The experimental determination of the dynamic lift characteristics of the complete ship, full size, is a very delicate problem. Aside from the difficulty of correctly measuring and averaging the observed angles of pitch and with airspeeds continuously fluctuating as they are, the exact amount of lightness or heaviness is a very elusive quantity. Theoretically the test program is simple, as follows.

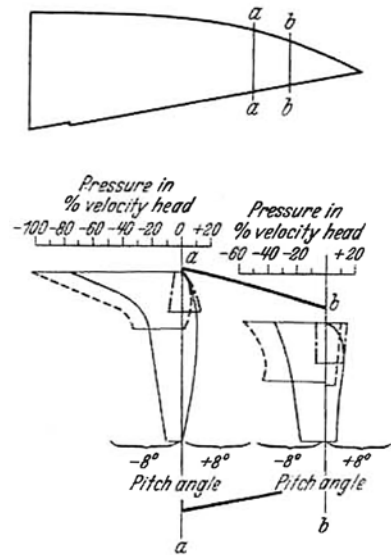

FIGURE 17. Distribution of pressure on fin. Dotted line +6° angle of yaw. Full line, 0° angle of yaw. Dot-dash line, -6° angle of yaw.

(a) Weigh off to make sure that buoyancy equilibrium is established and then either valve a measured quantity of gas or better, drop a measured amount of ballast and determine a set of corresponding pairs of values of air speed and angle of pitch for which the ship will neither rise nor fall; or otherwise:

(b) First valve a suitable amount of gas and then go through the above measurements and at last see how much ballast must be released in order to reestablish equilibrium. The latter method, especially when valving automatically by deliberately overclimbing the pressure height provides a check when the air density at the ceiling is observed.

An accurate record of elevator angles and of the ship's inclination oscillations must be kept during the experiments because the elevator contributes a considerable amount to the dynamic lift. Corrections required for variations of temperatures inside and outside, for fuel consumed and weights shifted during the time of the tests, render the procedure less simple. This and the reluctance of deliberately putting the ship through the ordeal are the main reasons for the scantiness of data available. Some are compiled in Table 2. When high dynamic loading occurs unexpectedly in practical navigation, the conditions are usually unfavorable for scientific investigations with neither time nor personnel available.

Attempts have been made to develop instruments to indicate currently the magnitude of the dynamic lift of a ship. Such instruments can be based upon the differences of pressures or airstream velocities prevailing on strategic stations above and below the ship's bow. A calibration must be obtained either from dynamic lift tests or from model tests.

Airships are known to have carried huge loads dynamically on various occasions. Thus the Graf Zeppelin was drenched by a torrential rain upon her start from Brazil in 1930. The rain-load thus carried was estimated to be of the order of five tons. The U.S.S. *Akron* once went through severe winter storms and collected 18,000 pounds of ice on her hull. She continued on her mission which lasted fifty-six more flight hours. The U.S.S. *Macon* on part of a transcontinental trip carried 30,000 pounds by dynamic lift.

It is not without interest that, at a given speed, small ships can carry a larger dynamic lift in proportion to their gross aerostatic lift because the former is proportional to the square of the linear dimensions and the latter to the cube. However, larger ships are usually faster, and loads due to rain and sleet are also proportional to the square of the linear dimensions, so that the proportion does not vary very widely.

TABLE 2. Some Dynamic Lift Experiments, Abstracted.

Experiment	Dynamic Lift kg.	Pitch Angle Degrees	Elevator Angle Degrees	Air Speed m./sec.	Temperature °C	Barometric Pressure mm. Hg	Altitude by aneroid m.
British R-33. of 55000 m. ³ nom. capacity Trial Flight on May 23, 1921, from Br. A.R.C. R. and M. 815	1100	-.8	8 up	23.	8.1		760
	1100	-.2	7 up	24.3	8.3		780
	1000	-1.5	16 up	14.5	8.0		740
	1150	-2.8	9 up	15.5	11.1		780
	1100	-1.7	6 up	22.9	11.7		765
	2050	-3.1	8 up	22.4	11.7		780
	1950	-9.5	3 down	14.7	12.9		785
	1950	-8.1	0	14.7	12.9		760
	1900	-4.1	6 up	22.9	13.8		795
	2700	-6.2	6 up	21.2	14.0		815
2800	-10.0	3 down	16.2	14.0		790	
U.S.S. Los Angeles (LZ 126) of 70,000 m. ³ nom. capacity, Trial Flight over Lake Constance, Germany, on Sept. 11, 1924	1700	~+2	2 up	25	11.5	685	895
	2600	+ 3 to 4	7 up	25	10.1	670	1030
	3300	+ 4 to 5.5	11 up	24	9.3	664	1150
	4000	+ 6 to 7	12 up	22	8.7	652.5	1300
	4800	+ 8 to 10	8 to 10 up	20	8.1	645.5	1400

Document 5-10 (a–b)

- (a) “Across the Ocean by Airship!” Deutsche Zeppelin-Reederei advertising brochure, 16 pp., 1937,
<http://www.airships.net/airship-travel-brochure>.
- (b) “Hindenburg Burns in Lakehurst Crash,”
New York Times (7 May 1937): 1.

No two documents together from the same critical year, 1937, could better capture the romance and the tragedy of airship travel. On the one hand, we read in an advertising brochure from Deutsche Zeppelin-Reederei, the company operating the Graf Zeppelin and the Hindenburg, how “[t]he modern Zeppelin Airship is awakening in us a new conception of those great trans-oceanic distances which we still associate with long sea voyages.” On the other hand, we confront the horrible front-page headlines announcing the Hindenburg disaster: “21 Known Dead, 12 Missing”; “64 Escape”; “Ship Falls Ablaze”; “Giant Dirigible Bursts into Flames as It Is About To Land”; “Victims Burn to Death”; “Some Passengers Are Thrown from the Blazing Wreckage, Others Crawl to Safety”; “Ground Crew Aids Rescue.”

Although neither of these documents relates to aerodynamics directly, it is impossible to close the door on any discussion of the great age of airships without references to the Hindenburg disaster. The gaseous explosion of Germany’s greatest zeppelin killed 36 people—of whom 13 were passengers, the only passengers ever lost in almost 30 years of commercial travel by airship. The tragedy became one of the greatest news events of its time. Stark public memory of the big dirigible going down in flames, and of the extraordinarily emotional live reporting of an eyewitness radio announcer, guaranteed the death of lighter-than-air flight as the losses of all the other airships had not. In his 1973 book *Giants in the Sky: A History of the Rigid Airship* (Seattle: University of Washington Press), Douglas H. Robinson wrote that “the gruesome photographs of the ‘Hindenburg’ burning at Lakehurst, faithfully reprinted by the newspapers yearly on May 6, have served powerfully to convince the American public that the rigid airship was an inflammable death trap, and at this late date they are unlikely to believe otherwise” (p. 324).

*Document 5-10 (a), "Across the Ocean by Airship!" Deutsche
Zeppelin-Reederei advertising brochure, 16 pp., 1937.*

Dedicated by the
DEUTSCHE ZEPPELIN-REEDEREI
to call its passengers, and to those who are interested in Travel by Air.

ACROSS THE OCEAN BY AIRSHIP!

The modern Zeppelin Airship is awakening in us a new conception of those great trans-ocean distances which we still associate with long sea voyages.

Now, we are realizing that, just as the modern aeroplane can bridge the distances between the capitals of States in a few hours, so does the Zeppelin Airship reduce the time in transit over trans-ocean voyages from weeks to days.

The prophetic vision of Jules Verne has been realized. The new experience of a voyage across the ocean above the clouds can be added to others in this age of wonders.

To all our passengers, the safety, comfort, freedom from sickness, and tranquillity in motion are a revelation, and these features no doubt are the reason for the increasing popularity of travel by Airship. The one regret expressed by our passengers—with which we are so familiar—is that the voyage is over so soon.

The purpose of this little booklet is to give hints and information which will enable you to obtain the maximum enjoyment from a voyage by Airship.

WHERE "AIRSHIP" INFORMATION CAN BE OBTAINED!

There need be no difficulty in obtaining information with regard to sailing dates, times of departure and arrival, airports, ports of call en route, together with aeroplanes and railway connections, particulars of fares, and all other details. All first-class travel agencies will be pleased to give you this information together with descriptive handbills and booklets issued by the Deutsche Zeppelin-Reederei. No obstacle need exist in the booking of a passage by airship.

All established travel agents can book your passage for you. The important thing is to secure a cabin in advance. The number of your cabin will be allotted to you on the day of departure, and this is of no importance as all cabins are identical. Owing to the great demand for passages, we advise you to book your passage well in advance of the date in which you intend to travel. A berth can be reserved for you by the payment in advance of half the fare. The booking agent will give you a receipt together with the Deutsche Zeppelin-Reederei's Rules and Regulations. It is important to safeguard this receipt, as on completing payment it will be exchanged for the final passage contract. All passengers are required to fill in carefully the official questionnaire handed to them by the travel agent at the time of reserving their berths. We suggest that this is done before the day of departure, as a great deal

of time will be saved in embarking. In the case of family parties it is sufficient if all members are included on the one questionnaire.

PREPARATIONS FOR TRAVEL

A passport is indispensable to all subjects of a country traveling to a country foreign to their own. As the preliminaries in obtaining a passport sometimes take several days, we advise our passengers to apply for their passports well in advance of the date of departure of the airship. In those countries where visas are required, these should be obtained from the consular authorities before leaving, as otherwise the passenger may find difficulty in landing. Each State has certain regulations governing the entry of foreigners, and our passengers will be well advised to make themselves familiar with these. If this advice is followed, passengers will have no difficulty in obtaining the necessary authority to travel. Once again we suggest that passengers should make these travel arrangements in plenty of time.

WITH REGARD TO BAGGAGE

Let us think of packing trunks! Of course, we have to distinguish between small baggage, such as suit-cases, handbags, etc., and our heavy baggage, such as trunks. In our hand-baggage we carry certain necessaries and personal belongings, in our heavy baggage we pack away belongings which will not be required until we reach our new destination. Passengers will appreciate that certain restrictions with regard to the volume and weight of all baggage are in force for journeys by airship. The contract fare entitles the passenger to free transport of 286 lbs of baggage, of which 66 lbs may be carried in the airship as personal baggage. Care should be taken that all usual articles required by the passenger for his daily use should be included in the personal baggage to be taken on board the airship. Usually, an ordinary light suit-case is found sufficient for this.

Should the passenger wish to take more than 66 lbs of personal baggage, the Company are obliged to charge for the extra weight. Prices will be found in the printed tariff of baggage rates. The other heavy baggage will be collected and forwarded to the passenger's place of destination by fast mail steamer. This year, 1937, the rates for extra baggage carried on the airship have been reduced to RM 2.—per lb between Europe and North America, and RM 3.—per lb between Europe and South America. The booking agent can make all arrangements for the passenger for the collection and forwarding of his baggage through any of the well-known agents.

WHAT IS WANTED ON BOARD?

Naturally, you yourself will decide on the things which you will consider as necessary for your everyday requirements. Nevertheless, perhaps you will allow us

to give you some little advice from our past experience. You will find that you do not need any special dress, because life on board an airship is similar to staying in a large hotel or on board a passenger liner. Lady passengers are well aware that a dozen frocks or gowns will weigh scarcely more than one suit of clothes for a man. But the difference in climate at the port of departure and that of the port of arrival should not be forgotten, and, therefore, it is advisable at all times to take with you a light overcoat.

The modern central heating and ventilation system installed on board the airship renders the change of climate almost imperceptible. One hint to the men; a lot of time is spent in looking out of the window at passing ships and other scenes of interest below. Many will find a comfortable cap an advantage. The wearing of a dress-suit or dinner-jacket is, of course, quite optional. Nevertheless, we advise that one dark suit should be carried in the personal baggage for convenient and suitable evening wear. Passengers need not worry about writing materials. In the comfortable writing and reading room they will find a plentiful supply of note-paper, picture post-cards, and attractive souvenirs [that] can be obtained from the saloon stewards.

THE MONEY PROBLEM MADE EASY

How to avoid difficulties with the German foreign currency regulations.

The fare charged for the passage covers "full board" and tips. But naturally, passengers will want to purchase little odds and ends, such as souvenirs of the ship, an occasional bottle of wine from the excellent "cellar" on board, Eau de Cologne, chocolates, cigarettes or even a good Havana cigar.

Sometimes, a party of friends may wish to celebrate some special event with a bottle of champagne from the ship's expertly chosen wine list. Often, a passenger may wish to send a telegram from mid-air, half-way across the ocean. All these facilities are at the passengers' disposal. Passengers, of course, have their own individual tastes, and incur their various expenses accordingly. To facilitate the passenger's convenience and to eliminate minor troubles, the Company has created a "Board Credit", which permits of each passenger opening a personal "Credit Account" for use on board ship, and in cases where the passenger intends to return by Airship after a short stay, may include a fixed sum in the currency of the country which you are visiting, sufficient to cover their daily expenses during their stay. The German currency regulations permit you to open a "Credit Account" for any sum of money up to 30 Reich Marks per day, which experience has shown is ample to meet the needs of the average passenger. In fact, you will find when calculating your expenses, that you will need to be really extravagant to exceed this daily expenditure, bearing in mind that your full board and tips, while in the Airship, are already covered by the passage money. Of course, your "Credit Account" must be estimated and purchased before going on board, preferably, at the time of booking

your passage. Your booking agent or banker can do this for you without putting you to any inconvenience, but do not leave it too late.

HOW DOES ONE GET TO THE AIRSHIP?

The Frankfurter Hof Hotel is the Headquarters for Airship passengers arriving at the historic old town on the banks of the Main. A fleet of fast buses connects the Hotel with the Airport. Passengers who make the journey to Frankfurt from England may travel in the Continental Expresses leaving Victoria and Liverpool Street Stations where through connections will bring them to Frankfurt within twenty[-]four hours. Hotel porters in uniform and representatives of the Deutsche Zeppelin-Reederei meet the principal trains on arrival prior to the Airship's departure, so that no trouble will be experienced in reaching the Hotel or in the transportation of the Passengers' luggage. To avoid any possibility of mistakes, the passenger may write or wire to the Frankfurter Hof Hotel, advising the time of arrival in Frankfurt, when the train will be met without fail. For motorists, who prefer to make the journey by car, excellent garage accommodation is provided by the Frankfurter Hof Hotel. The quickest means of transit from England, however, is by the fast Cabin planes of the Deutsche Lufthansa Company which, from the month of May, leave Croydon Aerodrome direct for Frankfurt and land at the airport where the Airship will be found waiting to receive them. Likewise, at Rio de Janeiro, a special train conveys passengers to the Airport at Santa Cruz, from which the fast, best and quickest air-service to and from all the capitals of the South American Republics is in operation. In New York, the special planes of the American Air Lines convey passengers to the Lakehurst Airport within the half-hour.

THE VOYAGE BEGINS

Your ticket for the Zeppelin is handed to you, the passport and Customs formalities are quickly over, and from now on you can relax and become completely at your ease, for the staff of the Deutsche Zeppelin-Reederei think and act for you. Everything that can be done, is being and will be done, to make your stay on board the Airship as enjoyable as possible. You are conducted inside the hangar, there is the majestic Airship, you are dazzled by its immense size and the beauty of its silver[-]grey form. A steward receives you and you are conducted on board up a comfortable gangway into the ship, completely protected from the weather. There is no discomfort or confusion such as one often meets with in boarding an ocean liner on a wet day. On entering the ship, you are requested to hand over your matches and automatic lighter, as smoking on board is confined to the smoking saloon, where all accessories for the smoker are at hand and where there are no restrictions. Here you will find a well-equipped bar for cocktails and other drinks, and plenty of good companionship. The existing air-navigation laws of most countries compel

another request. This is not a very serious one. You are asked to hand over your camera until the Airship has passed outside the three-mile limit. As soon as this is passed your camera will be returned to you and, of course, you are now free to start your collection of holiday snaps on board the airship, or to take pictures of passing ships and other sights in mid-ocean. Any jewelry and valuables may be handed to the chief steward for safe custody during the trip.

At the beginning, it is hard to realize you are on board a Zeppelin: the comfort and protection from the weather, the spaciousness, the elegance and neat equipment, the well-appointed cabins, the courtesy and deference of the ship's company who are only too ready to help, awake in you a new conception of pleasurable travel. A new anticipation of excitement mingles with the atmosphere of farewell. You are conscious that in a few days, thousands of miles will be traversed and you will arrive in a new country. Instinctively you approach the large windows and become interested in the preparations for departure. There is no delay, you have felt no shock, no tremble or vibration, and yet you notice the ship is moving. The towering walls of the hangar glide by and at last you are out in the open. Slowly and carefully, the airship swings into the wind, you hear words of command and occasionally a shrill whistle. You notice the groups of men at the tow ropes are moving back and then, while a farewell song is broadcast from the loud speakers, you see the earth getting more distant. It seems to drop quietly from beneath you. The ease and certainty of everything are incredible for you have felt nothing. While you are still wondering, the earth beneath you commences to slip by and you realize that the voyage has commenced. You turn to a passing steward with an apprehensive enquiry, "Suppose one is sick! Is it dangerous to lean—?" "Please do not worry" is the reassuring answer. "People are never sick on board an Airship."

FIRST IMPRESSIONS

You make your way past your fellow passengers to your cabin. Here the lamps are lit and water is ready in the wash-basin. (In the "Hindenburg" each cabin is equipped with hot and cold water, while in the "Graf Zeppelin" there are separate toilet rooms for Ladies and Gentlemen.) You open your suit case and arrange your clothes in the wardrobe. At last, your shaving kit, hair brushes and other articles of toilet are displayed upon the toilet stand. At once, your cabin acquires a homely personal atmosphere. You listen for the roar of the engines, or the fierce rush and vibration of the air, but apart from a distant quiet murmur, everything is tranquil and peaceful. You feel that nothing will disturb your sleep. Your steward appears and explains to you the arrangement of the handles and switches for light, heat, and ventilation. You are shown the bell-push in your cabin which will bring him to your side at any time during the day or night. Before he leaves, he reminds you to leave your shoes outside your cabin door for cleaning. You begin to feel that nothing has been overlooked to ensure your comfort.

If you have any particular wish regarding seating arrangement at meals, the First Steward will do his best to accommodate you. Your survey of the Airship commences with a short inspection of the spacious Dining Saloon, Drawing room, and Reading and Writing Room; then down the wide companionway to the comfortably furnished Smoking Saloon. You murmur to yourself, "Here one has the luxury of an ocean liner and yet within two and a half days we shall arrive in the United States."

For the last eight years, the famous "Graf Zeppelin" has carried passengers and has become a favorite ship on the South American route. There are passengers who still prefer the old "Graf Zeppelin" to the more modern "Hindenburg", but there is no doubt that passengers soon feel completely at home in both of these Airship[s], and a trip across the ocean in either of them is an experience the enjoyment of which one will never forget.

A FEW HINTS REGARDING LIFE ON BOARD

Those who are accustomed to steamship travel will soon find themselves at home in an Airship. There is something familiar in the printed passenger-list you receive, the passage contract is similar; and then, the life on board is subject to those rules and regulations such as are usual on a well-run steamship, and which make for order and safety. Everyone finds the ship's officers ready to explain and to help in every way. The First Steward is always at hand with advice and general information. He knows and understands the passengers' wishes and difficulties through his long experience during years of service aboard ocean steamers and airships. The sounding of a gong is the signal that meals are ready, and that in the Dining Saloon the tastefully laid-out tables are waiting. Breakfast is served from 8 a.m. to 10 a.m., Mid-day dinner at noon; afternoon tea or coffee from 4 p.m. to 5 p.m., and then, as the healthy sea air will be sure to increase your appetite, sandwiches and fruit are served until late in the evening.

The large and varied assortment of foods which form the Menus, the variety of wines and other beverages, as well as the excellent cuisine and attentive service, vie with the best one is accustomed to find in first-class Hotels and Restaurants.

Outward, and homeward bound, passengers should alter their watches to agree with the ship's clock which is put back or advanced each day in accordance with the time difference between the ship's position and Greenwich. If this is realized, there will be no misunderstanding with regard to a seeming alteration in the hours of the meals.

Time on board passes quickly. There are many things to hold the passenger's interest. The news bulletins are displayed on a board in the reading room. Each day, a small newspaper is printed in English and German giving the latest and most important news from all parts of the world. Games, such as cards, chess and draughts[,] can be placed at your disposal by the steward. For those of a quiet or

studious disposition, the reading and writing saloon will be popular. Letters can be posted on board the Airship, and at any time you may dispatch wireless telegrams to friends or business relations in all parts of the world. Each day there is the excitement of the well-known "sweepstake" on the ship's run, and another popular feature is a conducted tour over the whole of the Airship.

All passengers must abide by three important regulations. These are:

1. To throw nothing overboard, as by doing so you may cause damage to the Airship's propellers or hull.
2. Not to carry matches, automatic lighters, or to smoke in any part of the Airship, except the Smoking Saloon.
3. Not to leave the passengers' quarters except by permission and accompanied by a member of the ship's company.

Throughout the night and day, the officers and crew of the Airship keep unceasing watch over the safety and welfare of both ship and passengers. The most modern fire extinguishing installations and other safety devices are a guarantee of absolute security. These well-thought[-]out precautions are one of the main reasons why Airship travel has proved most reliable in the last few years, and are a justification of its increasing popularity.

A DAY ON BOARD

What a wonderful night's rest you have enjoyed after your first day on board! The soft murmur from the distant engines seems to have lulled you to sleep. Now the sunshine is streaming in through the windows and you take your place in the dining saloon for a breakfast of crisp appetizing rolls and aromatic coffee. Already, the free and easy companionship of ship-board travel is in evidence. The enjoyment of airship travel makes people sociable, friendships are being formed. You finish breakfast and walk to the windows. Down below, you see the long shadow of the airship passing swiftly over the sparkling foam-crested waves of the blue Atlantic, and the joy of experiencing this wonderful achievement in modern travel surges through you. No people are confined to their cabins, for as yet no passenger has ever been sea-sick on board a Zeppelin Airship. Even in storms and squally weather, the ship's movements are quiet and steady except for the slight shock of the first onslaught. There is no noise beyond the distant murmur of the engines and the sigh of the wind on the outer hull. No dust, no soot to trouble you, the whole atmosphere is one of tranquility and peace. The air is delicious and fresh, in fact you seem to have been transported into another and more beautiful world. For a long time you are content to watch the marvelous cloud formations or the effect of the wind on the sea and waves beneath, and then perhaps you recline in a comfortable chair to read, join a party in a game of bridge, or chat with some new and interesting friends. Occasionally someone will call from the windows, and you will join your fellow passenger in witnessing the passing of a great liner far beneath,

her rails lined with waving passengers, or the inspiring spectacle of a man-of-war or destroyer flotillas.

Mid-day arrives as if by magic, and with it the welcome sound of the dinner gong. After dinner, smokers repair to the smoking saloon. Gradually and amidst many distractions and pleasant activities the evening advances, and the stars appear. If inclined, you take a shower bath before supper, and then a round of cocktails with some friends in the bar, followed by supper, and to end the day, a game of bridge. As you retire to your cabin it seems a miracle that already you are nearer your destination by over 1,000 miles.

A TOUR THROUGH THE AIRSHIP

Some of the secrets disclosed.

Your request to be conducted through the Airship never meets with refusal. A time has been arranged and you meet your guide. Leaving the passengers' quarters you are conducted along a small gangway which runs throughout the length of the ship. This is the keel gangway. On either side are numerous metal tanks and fabric receptacles containing the water, ballast and fuel. In addition, you are permitted to peep into the tent-like quarters of the crew. Above you are the immense gas-bags enclosed in the dainty network of duralumin frames, supports, counter-supports and tension wires forming the skeleton of the Airship. You wonder at the science and ingenuity which have contrived this marvel of lightness and strength.

The cargo is stowed in a network of suspended platforms, and a great variety of cargo is carried.

Lateral gangways lead up to the motor gondolas outside the ship, which are attached to the hull by tension wires and compression arms. You pass the Wireless cabin, where the weather forecasts are received, and from which messages are dispatched to all parts of the world. Now you reach the Control and Navigation car in the front of the ship, which is equivalent to the Captain's bridge on a steamer. From this car an uninterrupted view can be had on all sides. A mass of gauges, telegraphs and other apparatuses are cleverly grouped and situated so as not to impede the view. You watch the men on duty and feel confident that you are in good hands. You can scarcely hear the noise of the engines which are driving forward this "Flying Town". Many of the ship's company have served under Graf Zeppelin, the creator of the modern airship.

The officers explain the controls which appear very complicated, and also introduce the passengers to some of the secrets of aerial navigation. They learn particulars about the steering of the ship, the different gauges and altimeters, and garner some ideas on the study of meteorology.

Perhaps you will be surprised at the quantities of fuel, water and stores consumed on a voyage across the ocean, but do not forget, the "Hindenburg" is carrying 70 passengers as well as a crew of 52 men.

Your admiration for this masterpiece of German patience, thoroughness and technique, will leave an impression which you will carry through life.

What is more, you will feel proud of having realized yourself the prophecy of Jules Verne, by crossing the ocean by the most modern means of rapid transport.

*Document 5-10 (b), "Hindenburg Burns in Lakehurst
Crash," New York Times (7 May 1937): 1.*

HINDENBURG BURNS IN LAKEHURST CRASH; 21 KNOWN DEAD, 12 MISSING; 64 ESCAPE; NOTABLES ABOARD; MERCHANTS, STUDENTS AND PROFESSIONAL MEN ON THE DIRIGIBLE; LEHMANN IS A SURVIVOR; VETERAN ZEPPELIN COMMANDER, ACTING AS ADVISER ON TRIP, IS SERIOUSLY BURNED; CAPTAIN PRUSS IS ALSO SAFE; C.L. OSBUN, SALES MANAGER, WHO SURVIVED A PLANE CRASH, ESCAPES SECOND TIME.

Notables from many walks of life were among the passengers on the ill-fated Hindenburg. They included merchants, students and business and professional men and women.

Many of the survivors owed their lives to the fact that they were apparently near windows in the dirigible when the accident happened and were able to leap through them to the ground in safety.

Among the survivors listed were Captain Ernst Lehmann, veteran Zeppelin commander; Captain Max Pruss, the new Hindenburg commander; Herbert O'Laughlin of Chicago, employed by the Consumers Company of Elgin, Ill.; Clifford L. Osbun, export sales manager of the Oliver Farm Equipment Company of Chicago, and Ferdinand Lammot Belin Jr. of Washington D.C.

LEHMANN'S CONDITION GRAVE

Early this morning Dr. E. G. Herbener, staff surgeon at the Paul Kimball Hospital in Lakewood, said that Captain Lehmann was on the doubtful list. Captain Lehmann is suffering from shock and second and third degree burns of the face and body. Captain Pruss is suffering from second and third degree burns of the face, forehead and arms and will probably recover, Dr. Herbener said.

Among the passengers who were still unaccounted for were John Pannes, passenger traffic manager of the Hamburg-American Line and North German Lloyd at New York, and his wife; Ernst Rudolf Anders, partner of the firm of Seelig & Hille, tea merchants of Dresden, Germany, and his son, R. Herbert Anders[;] and Hermann Doehner of Mexico, D. F.

Captain Lehmann and Captain Pruss were in the control gondola when the crash occurred. Both officers, together with several other members of the crew, leaped through the gondola windows to safety.

LEHMANN AS ADVISOR

Captain Lehmann, who was serving as adviser aboard the Hindenburg, had been commander of the ship until this year. He has had long experience with the lighter-than-air craft, and has been associated with Hugo Eckener, world-famous authority on Zeppelins, since 1931.

He was born March 12, 1886, at Ludwigshafen, on the Rhine, the son of a chemist. He became a naval cadet in 1905 and later entered the Polytechnic Institute at Charlottenburg, a borough of Berlin.

During the World War Captain Lehmann receive[d] the German Iron Cross award. After the war, as second in command to Eckener, he brought the dirigible Los Angeles to Lakehurst in 1924. When the Hindenburg was completed in 1936 Captain Lehmann was placed in command, a position he held until recently, when Captain Pruss was elevated as commander of the ship.

Mr. Osburn's escape from the disaster marked the second time that he had narrowly missed death as the result of a flying accident. Last year he was aboard a transport plane when it was forced down en route from Puerto Rico to Buenos Aires. Soon after he was transferred to a motorboat with other passengers and the motorboat blew up. Mr. Osburn escaped injury, but two other passengers were seriously burned.

Mr. Osburn declared that he was talking to fellow passengers in the dining salon, looking down through the observation window watching the ship being moored, when the disaster occurred. He was apparently blown through the window and thrown to the ground, suffering injuries. He was taken to the Paul Kimball Hospital in Lakewood, where his condition was said to be not serious.

SHIP FALLS ABLAZE

Great Dirigible Bursts into Flames as it is About to Land

Naval Air Station, Lakehurst, N.J., May 6.—The zeppelin Hindenburg was destroyed by fire and explosions here at 7:23 o'clock tonight with a loss of thirty-three known dead and unaccounted for out of its ninety-seven passengers and crew.

Three hours after the disaster twenty-one bodies had been recovered, and twelve were still missing. The sixty-four known to be alive included twenty passengers and forty-four of the crew. Many of the survivors were burned or injured or both, and were taken to hospitals here and in near-by towns.

The accident happened just as the great German dirigible was about to tie up to its mooring mast four hours after flying over New York City on the last leg of

its first transatlantic voyage of the year. Until today the Hindenburg had never lost a passenger throughout the ten round trips it made across the Atlantic with 1,002 passengers in 1936.

TWO THEORIES OF CAUSE

F. W. von Meister, vice president of the American Zeppelin Company, gave two possible theories to explain the crash. One was that a fire was caused by an electrical circuit "induced by static conditions" as the ship valved hydrogen gas preparatory to landing. Another was that sparks set off when the engines were throttled down while the gas was being valved caused a fire or explosion.

Captain Ernst Lehmann, who commanded the Hindenburg on most of its flights last year and was one of tonight's survivors, gasped, "I couldn't understand it," as he staggered out of the burning control car. Captain Max Pruss, commanding officer of the airship, and Captain Albert Stanapt were also among the survivors.

Captain Lehmann was critically burned and injured; the other officers were also burned, but less seriously.

Experts in lighter-than-air operations who saw the accident said tonight that when the two landing lines were dropped by the dirigible at 7:20, they were immediately made fast to the mooring cars on the circular track about the mooring mast. The crew began to make the lines taut, but the ship had gathered too much momentum, according to these observers, and drifted several hundred yards past the mast. The starboard lines pulled hard as the nose of the ship passed over the mooring mast at the top.

ORDER NOT HEARD

Captain Pruss, making his first trip in command of the dirigible, signaled and shouted, "Pay out!"

This order was heard by the operator on one mooring car, but not by the other, as the shout went against the wind and could not be heard. Consequently, one mooring car paid out and the other did not. The result was that the ship was thrown off its balance and lost the perfect equilibrium it had previously had.

Its nose dipped, forward ballast was dropped and the elevators were set to raise the ship. Instead the ship was held tight by one yaw line. The nose was pulled over and the elevators had an effect opposite to that which they were intended to have, according to his version.

Document 5-11

Excerpt from Dr. Hugo Eckener, *Im Zeppelin über Länder und Meere*, p. 559, translated in Douglas H. Robinson, *Giants in the Sky: A History of the Rigid Airship* (Seattle: University of Washington Press, 1973), p. 324.

No one was a greater advocate of lighter-than-air travel than Dr. Hugo Eckener, the renowned German zeppelin pilot and pioneer of transatlantic commercial airship travel with Deutsche Zeppelin-Reederei. It was Eckener who in October 1924 had flown the zeppelin designated ZR-3 (later renamed Los Angeles) to the United States as part of the Versailles Treaty reparations agreement. No proponent of airships was more celebrated than Eckener. In 1931, the Fédération Aéronautique Internationale presented him with its gold medal for his contributions to airship travel. Six years later, in 1937, he won the Daniel Guggenheim Medal.

Eckener published his autobiography in 1949. A brief selection from it follows. In it, Eckener comments insightfully on how the airplane came to win out over the airship and on the role that World War II played in that decisive process. One of Eckener's greatest admirers and supporters, F. Willy von Meister, who served as Deutsche Zeppelin-Reederei's representative in the United States during the Hindenburg era, believed that four political "mistakes" ultimately made it impossible for the transoceanic zeppelin to compete with the airplane. First, Germany's use of zeppelins in World War I bombing raids against England forced the United States and its allies to demolish the German airship industry following the war; if airships had not been used in such a negative way against civilians, the United States might instead have fostered expansion of this industry for international commerce. Second, the U.S. government refused to permit the export of helium, which seriously undermined the safety of passenger-carrying airships, forcing Germany to use the much more dangerous hydrogen. Third, Hugo Eckener's decision to use hydrogen for the Hindenburg before the U.S. Congress had adequate time to consider a special helium permit led directly to the Lakehurst disaster on 6 May 1937. Fourth, the fact that Nazi Germany had instigated the horrors of World War II added greatly to the general prejudice against rigid airships as an aggressive, unstable "German" technology. If not for these "politics," in Meister's view, transoceanic zeppelin travel could have stayed technically and economically viable into the 1950s.

Document 5-11, Excerpt from Dr. Hugo Eckener, Im Zeppelin über Länder und Meere, p. 559, translated in Douglas H. Robinson, Giants in the Sky: A History of the Rigid Airship (Seattle: University of Washington Press, 1973), p. 324.

A tremendous war which, as always in life-and-death struggles between great peoples, had forced the rapid technical development of the weapons of victory without regard to cost and effort, had furthermore forced an enormous development and improvement in aeroplane performance, so that planes were now in a position to carry on a transoceanic service. The airship's monopoly was broken. And, since the aeroplane is much faster and can fly a given distance in half the time or less than is needed by an airship, the role of this aerial vehicle in commerce seems to have been ended after a brief period of glory, just as it had been developed to the point of acceptance, for speed and time-saving are trump cards in today's hurried age, which has almost completely discarded space and distance as obsolete concepts in its plans and undertakings. What does the airship have to offer now to the businessman or statesman in a hurry to cross the Atlantic Ocean?

Document 5-12 (a–e)

(a) “Welcome to Worldwide Aeros,”

[https://web.archive.org/web/20000118123253/
http://aeros-airships.com/DOCS/1/index.html](https://web.archive.org/web/20000118123253/http://aeros-airships.com/DOCS/1/index.html).

(b) “Interface Airships,”

[https://web.archive.org/web/20000301021312/
http://www.ecoblomp.com/](https://web.archive.org/web/20000301021312/http://www.ecoblomp.com/).

(c) “Prospective Concepts AG,”

[https://web.archive.org/web/20010303185735/
http://myairship.com/database/prospect.html](https://web.archive.org/web/20010303185735/http://myairship.com/database/prospect.html).

(d) “Welcome to Advanced Technologies Group:
Revolutionary Aerospace Solutions and
Telecommunications in the 21st Century,”

[https://web.archive.org/web/20010124161800/
https://www.airship.com/](https://web.archive.org/web/20010124161800/https://www.airship.com/).

(e) “The Easy Solution to the Problem of
Transporting Heavy Loads,” Press Release from
CargoLifter AG, Frankfurt, Germany, May 2000,

[https://web.archive.org/web/20000510070652/
https://www.cargolifter.com/](https://web.archive.org/web/20000510070652/https://www.cargolifter.com/).

If anyone thinks that the age of airships ended with the Hindenburg and that the only airships flying by the end of the 20th century were the Goodyear and Met-Life blimps flying over football games and parades, all one needs to do to correct that view is check out the dozens of Web sites related to airships currently available on the Internet. Even a quick perusal of some of them will demonstrate just how much activity still takes place in the lighter-than-air field. In fact, as the century ended, airship R&D and airship business were both definitely on the upswing.

What readers will find below is textual content from a sampling of Web sites online in the year 2000 related to airship manufacturing and operation. One will see not only that a wide assortment of lighter-than-air vehicles were in fact being built and used for a variety of commercial, scientific, and military purposes, but also that many more missions were envisioned for various types of advanced airships in the future.

*Document 5-12 (a), "Welcome to Worldwide Aeros."***WELCOME TO WORLDWIDE AEROS**

Worldwide Aeros Corp. is one of the world's leading lighter-than-air production firms. The company's operation involves research, development and marketing of a variety of airships. These include rigid airships, commercial non-rigid airships and advanced manned or unmanned tethered aerostatic systems. The airships are available for utilization for a variety of civil and military missions.

The Company's technical expertise is based on more than 20 years of research into the lighter-than-air technologies.

AEROS PRODUCTS**RIGID AIRSHIPS**

Aeros[s] immediate goal is to bring the rigid airship models to full-scale production in order to satisfy rapidly growing demands for LTA technologies in various sectors of the marketplace both domestically and worldwide. This will help to strengthen and expand the U.S. aerospace industry. The company has established its name as an innovative, reliable and capable leader in the airship industry. Aeros institutes high-level maintenance services to its customers and maintains an edge in the market through innovations in products and product applications. The unique features of airships, such as aerostatic lift capability, VTOL capability, capability to hover for extended periods of time, lack of need in airport facilities, all-weather operations and superb safety demonstrate their unique place in the market. There is a definite need for the airship industry.

The incorporation of the cargo airship into the existing transportation infrastructure allows for the effective solution to the following problems:

1. To considerable [*sic*] reduce shipping costs and costs of air transport, to allow simpler flight operations, possibly to use one type of vehicle for various jobs.
2. Air freighting very large, oversized and heavy objects without airport facilities.
3. To considerable [*sic*] increase safety and reliability of the airborne freightage.
4. Shipment during periods of low ceiling or other poor weather conditions.
5. To transport passengers from door to door, land within any city limits (which is possible because there is no need for an airport, also lower weather minima and lower noise level)[.]
6. To reduce noise in passenger cabins and increase comfort for passengers (close to that of cruise ships).

Segments of the market where the need for the cargo airship is most acute today:

ENERGY AND ELECTRIFICATION

Transportation from the manufacturing plant and installation of assembled units of nuclear power plants, hydroturbines, electric generators, transformers and other large-sized equipment. Electric transmission cable marking and laying, shipping and assembly of towers, cables and equipment. Delivery and installation of small wind, solar and diesel power plants.

CONSTRUCTION

Shipment from manufacturing plants of large ready-made units to be assembled on-site. Shipment of assembled complex equipment from one site to another.

OIL AND GAS INDUSTRY

Shipment and installation of towers and other large and heavy equipment. Shipment of complex mechanisms, cars, construction teams and mobile settlements along oil and gas lines being constructed. Delivery and laying in trenches of long pipes for oil and gas. Economical shipment of oil and natural gas from poor deposits.

MACHINE INDUSTRY

Shipment of large assembled units. Installation of large assembled units at plants being built or expanded.

TIMBER INDUSTRY

Forest fire fighting, forest planting, fertilization, marking of felling zones. Commercialization of inaccessible forests. Airlift (timber and crews).

GEOLOGY AND MINING INDUSTRY

Shipment of geological survey parties and equipment. Facilitation of fast analysis of samples in flying geological laboratories and supervision of geological survey. Magnitometric, radiometric and other types of survey of the ground. Delivery of ores of precious minerals, diamonds and metals from mines to the industrial areas, or unloading them at the storage facilities.

AGRICULTURE

Delivery of fertilizers and other chemicals from manufacturing plants to the field. Fertilization, aerochemical weed, pest and plant disease control. Fast and economical movement of agricultural machinery and machine-operators from one crop to another, cutting the time and cost on agricultural work. Delivery of perishable agricultural goods. Shipment of sheep between mountain pastures and valley pastures. Dispersion of chemical reagents in the clouds to facilitate rain.

FISHING INDUSTRY

Ocean fish survey and fleet direction. Changing of crews on expeditionary fishing vessels.

Taking the catch from fishing boats to the shore storages. By using higher altitudes en route the temperature of the fish can be lowered. Development of fresh-water fishery in remote and scattered rivers and lakes.

ENVIRONMENTAL PROTECTION

Air pollution control of the terrain and water surfaces, identification of sources of pollution, analysis and forecast of ecological situations.

TOURISM AND PASSENGER TRAFFIC

Tourist flights with spectacular viewing and high level of comfort. Delivery of passengers directly to downtown and from the city to the airport.

EXPLORATION OF REMOTE AND INACCESSIBLE AREAS

Development of reliable and effective transportation network for all-year operation. Development of new methods of exploration. Ice patrol and leading ocean vessels and fishing boats. Shipment of equipment for repairs.

EMERGENCY RELIEF/MILITARY OPERATIONS

Delivery of rescue teams and equipment to the area of natural disasters. Evacuation of large numbers of personnel. Repair of damaged highways. Disaster relief operations.

The military interests indicate that cargo airships appear to offer significant appeal from the standpoint of cost and capability and are currently under serious consideration within the DOD.

The D-Series Table

Ship Type	Volume cu.ft./cu.m.	Length ft./m.	Cargo Capacity lbs./kg.	Speed kts./km. per hr.
D-1	972,000	276	28,000	152
	27,500	84	12,700	280
D-4	7,720,000	552	280,000	152
	222,000	168	127,000	280
D-8	39,746,000	976	1,653,500	118
	1,125,500	297.5	750,000	218

AEROS PRODUCTS

Worldwide Aeros offers a variety of lighter-than-air products for commercial, civil, advertising, military and scientific applications. From passenger[-]carrying tourships to tethered lighter advertising blimps, Aeros can deliver the solution.

TETHERED AEROSTATS

Worldwide Aeros is the leading production company for tethered balloon systems (Aerostats). For your particular needs like data transmission, communication, monitoring or simple air lifter, [our] engineering team will design for you the perfect platform, best in the quality and the value.

For your promotion and marketing needs, Worldwide Aeros offers a large variety of the helium Advertising Aerostats. Very visible, our Aerostats can also carry additional advertising items like banners, flags or inner lightning systems. All advertising aerostats are custom made to fulfill the most challenging requirements.

TETHERED MANNED BALLOONS

One of the many applications for Tethered Manned Balloons is amusement rides. The MB-4500 is designed to carry 20 passengers, providing to them stunning views and a breathtaking ride. Tethered Manned Balloons are an excellent business opportunity, because of the minimal operating cost and easy maintenance.

NON-RIGID AIRSHIPS

For Advertising and Promotion airship operation the best solution on the market is airships AEROS 40-A and AEROS 40-B. The reliable vehicle with low cost in operation, our airship today is the most advanced advertising airship. For your promotional needs the airship offers inner lighting system for a night time advertising and fast and easy changeable banners.

AEROS-40B is designed to carry different types of surveillance and monitoring equipment, including TV broadcasting and infrared cameras. This ability makes the airship the perfect platform for Surveillance Operations both for military and civil applications.

AEROS-40C is primarily designed for Tourism Applications. This airship features a large gondola with a capacity of up to 12 passengers. The AEROS-40C is a revolutionary vehicle, utilizing the most advanced equipment on the market, which has allowed a new market to open.

RIGID AIRSHIPS

AEROS D-1 Cruiseship features a rigid composite hull and complete active control system. The Royce Powered engines allow the airship to reach speeds [of] up to 152 knots, which makes the D-1 an excellent vehicle for short distance charter flights. It is the next generation in short and long-term luxury air tours. The D-1

will seat 80 passengers at a comfort level currently paralleled with cruise ships. The construction, size, and multiple options of the D-1 makes it the most attractive form of transportation for those who enjoy top class travel with a combination of safety, fun and luxury. It is not the speed to your destination, it is the luxury of a great experience.

The missions of both Cargo Airships, the AEROS D-4 and AEROS D-8 airships, are designed for moving inseparable assemblies that ordinarily could not be transported intact, oil derricks, building frames, bridges, etc. With cargo capacity up to 1.6 min. lb. the cargo airship could change forever the logistical operations in commercial and military use.

Document 5-12 (b), "Interface Airships."

Interface Airships, Inc. is a Florida Corporation formed in 1994 to provide airship services to the scientific research community.

OUR MISSION

Interface Airships was created to be more than just an airship development, production and training business. We're working to transform the way humans see, feel and act regarding global environmental protection and restoration. By integrating environmental research, the lively arts, media and education—with our corporate partners—every species wins by having healthy habitat in which to thrive and survive.

DESIGN RATIONALE

Scientists studying the marine environment have traditionally used small airplanes and helicopters to survey marine mammals (manatees and dolphins), sea turtles, coastal habitats (including sea grasses, micro-organisms and water quality), and fishery[—]and in cost, are limited by the higher speeds and altitudes required by such aircraft. Helicopter surveys are expensive and tend to disturb the study area. Recent opportunities to conduct research from large blimps have given these scientists justification for using airships in research projects. Although scientists feel the airship, with its stable, slow, and low altitude flight, is an ideal platform for aerial observation, the operating costs of most commercial airships are too expensive for current research funding levels. *Interface Airships* believes that smaller airships can fulfill the scientists' needs for a superior cost effectiveness, and is currently operating an experimental two person airship for testing of airship design and coastal research concepts.

FUNDING

Interface Airships has developed a pilot program to use the prototype airship for coastal oceanographic research in Florida, with primary emphasis on manatee identification, behaviors and habitats. The company is soliciting financial support from government agencies and corporate sponsors to fund the airship research costs. Research groups are then able to request airship time for feasibility testing of their concepts.

POTENTIAL AIRSHIP ROLES

The prototype is classified as experimental and its use is regulated by the FAA for non-commercial purposes by government agencies. Design and construction of a small airship certified for commercial operation by the Federal Aviation Administration will open the door to many other future enterprises. Although environmental and scientific research will remain the primary marketing focus for this company, additional long-term opportunities exist in such areas as: TV/movie/documentary filming, sports broadcasting, advertising, land surveying, and high resolution mapping. *Interface Airships* will provide such services to clients unable or unwilling to pay the high costs associated with the large airships. Such FAA certified airships could also play a valuable role as a primary pilot trainer for the growing U.S. commercial airship fleet, providing far less expensive flight experience than the larger airships.

Document 5-12 (c), "Prospective Concepts AG."

The media talked about a "flying stingray" when Prospective Concepts AG finally unveiled its secretive technology demonstrator in May 1998. Stingray is indeed an appropriate name for the groundbreaking aircraft designed by this small Swiss company. The Stingray has a revolutionary wing that derives its rigidity from compressed air. Later versions will be filled with helium. The second radical concept developed especially for the Stingray is a pneumatic catapult to be placed in the aircraft's tail. The concept has been tested on the "Kangarou," a light airplane with slow flight characteristics similar to the Stingray's: a cylinder that extends to 5 m catapults the craft right into the air and accelerates it from standstill to flying speed at 1.5 g[s].

As the founder and president of Prospective Concepts Andreas Reinhard notes, the Stingray constitutes the high end in the use of pneumatic structures. It is thus a showcase and the pioneer of a technology which uses high strength fiber materials and air pressure as its components. With the use of this technology, rigidity and flexibility can be combined, a union that seemed contradictory up to now. The Stingray was developed as a people moving concept taking off from standstill and

landing on the spot and it is a hybrid between an airplane and an airship. According to the company, a significantly larger successor to the Stingray is also planned. It will derive 25 percent of its lift from helium in its wing and integrate propulsion and the gondola into the wing. Development of the Stingray was supported by the German pneumatic conglomerate Festo.

Technical Data for the Stingray

Stingray	
Wingspan	13 m
Length overall	9.4 m
Wing surface	70 m ²
Volume	68 m ³
Max. speed	130 km/h

Document 5-12 (d), “Welcome to Advanced Technologies Group: Revolutionary Aerospace Solutions and Telecommunications in the 21st Century.”

We are acknowledged by the British Government and others as the world’s leading exponent of “Lighter-than-Air” (LTA) technology. We have the world[’]s most experienced team, specializing in designing and building LTA systems.

New technologies have brought new challenges and new opportunities. On this site, you will find out more about our vision for the future—the application of new technology to heavy lift transportation and to the ever growing telecommunications market.

ABOUT ATG

The design and administration team operate from offices in Bedford, the development and production facilities from the huge Cardington hangars historically associated with British airship production. We also have a subsidiary company in California, USA, near Silicon Valley, the world[’]s leading center of the electronics and software industries.

The Chief Executive and founder, Roger Munk[,], established the company in February 1996, and reassembled many of his colleagues who have been involved in design and engineering of LTA systems, in the previous three decades. His own background makes interesting reading.

In the early seventies, Munk, a qualified naval architect, realized that by applying new composite materials, modern technology and design practices to the airship concept a commercially viable LTA vehicle could be produced with few of

the disadvantages associated with early airships. His efforts were rewarded with a contract from Shell International Oil Company to study whether natural gas could be transported in bulk by very large airships from their Alaskan fields.

The resulting work, carried out by Aerospace Developments, his first company, did much to establish the airship as a practical and economically viable vehicle. Out of this research program came new designs for smaller general purpose airships, including, crucially, the first even application of vectored thrust on an airship. He led the team that developed what is generally accepted as the world's first modern technology airship, the Skyship 500, and when Airship Industries was formed in 1982, designed the Skyship 500HL, Skyship 600 and Sentinel 1000 airships and saw them into service and certification around the world. Munk also headed the project team which won the contract for the prestigious US Navy anti-cruise missile program even though there was powerful domestic opposition from Boeing and Goodyear/Loral.

In 1996, Airship Technologies Services was created. The company reassembled the original design team, having acquired the rights to develop a new range of large airships. In June 2000, the company changed its name to Advanced Technologies Group, reflecting a[n] increasing diversification into related areas such as diesel engines and Unmanned Aerial Vehicles (UAVs). Modern, high technology airship manufacture has now been definitely established.

ACHIEVEMENTS OF LTA TECHNOLOGY DESIGN TEAM, LED BY ROGER MUNK FROM 1971 TO PRESENT DAY.

- Initiated major design study for the world's first Ultra Large Airship Natural Gas System for Shell International Gas.
- Designers and builders of the world's first modern technology airship, the Skyship 500.
- Responsible for the first full authority vectored thrust system.
- Winners of the \$170 million US Navy Airship Contract in 1986.
- Prime contractors for several high altitude balloon world records.
- Design of more transport category passenger certified airships than any other airship company.
 - 1979—Skyship 500, Skyship 500HL
 - 1984—Skyship 600
 - 1990—Sentinel 1000
 - 1996—Skyship 600B
- Operators of more civil transport category airships around the world than any other airship operator (as Airship Industries) including the award of Air Operators Certificate and approval by the Queen's flight (for carriage of members of the UK Royal family).
- Design of the world's first Fly-by-Light powered flight control system.

- Design of successful airship systems—advanced air management, weight-on-wheels, helium purity/contents, equipped flight decks.
- Design and manufacture of advanced lightweight water recovery systems for airship propulsion systems.
- Design of the world's first successful mechanical ground handling system.
- Development of the world's highest longevity fabric technology.
- Won, in 1996, design and certification contract for the world's most advanced airship for the Atlanta Olympic Games.
- Appointed Design, Maintenance and Operating Authority in 1996 for the UK Ministry of Defence's airship program.
- Awarded in 1997, a prime system engineering contract for the Round-the-World Balloon record attempt.
- Awarded in 1998, the UK Ministry of Defence's airship test platform contract for the testing of an airborne radar system.
- Awarded a major UK government grant to develop an advanced technology aircraft diesel engine in 1998.
- Awarded a major LTA system, design and engineering contract by Lockheed Martin.

LOCATIONS

Advanced Technology Group's head office and design center are at Bedford, England[,] with manufacturing and flight testing facilities nearby at Cardington in a giant purpose-built hangar and adjacent airfield. ATG now has a West Coast office in California and business partners in North Carolina, USA[,] and Romania.

ATG, along with its associated companies and business partners[,] are heavily involved in the development and manufacture of components at locations throughout the United Kingdom, in support of the whole range of the company's LTA operations.

CIVIL ROLES

ATG's LTA vehicles are ideally suited to a number of roles in a civilian context:

ADVERTISING

The smaller craft (the AT-10 and the SkyCat 15) are very suitable for the traditional role as advertising vehicles. Modern daylight-visible moving picture images will revolutionize this application.

TOURISM AND CORPORATE ENTERTAINMENT

These applications can be combined with the above, which will significantly improve the commercial possibilities. (The AT-10 will carry 7 passengers, and the SkyCat 15 will carry 80 in VIP conditions.)

SURVEILLANCE

Police forces regularly use airships at large public gatherings (e.g.[,] at the Olympics) for crowd control, surveillance and law-enforcement functions. These can also be combined with the above two functions, as most police surveillance is carried out remotely from the ground.

DE-MINING

Experiments carried out by DERA have shown that she [*sic*] smaller airships are ideal platforms for mine-detecting radars, since they are stable and can fly safely at low altitude. Existing equipment enables all mines, including the small plastic anti-personnel variety, to be accurately identified.

FREIGHT CARRYING

The larger models in the SkyCat range will be employed for heavy-lift operations. The SkyCat 200, for example, can carry twice as much as any existing cargo aircraft.

HUMANITARIAN OPERATIONS

The SkyCat's ability to operate over land or water, and land on any reasonably flat surface, including sand, snow, sea or marsh, make it the ideal vehicle for bringing aid to disaster areas and for rescue operations (cf. recent disastrous floods in Mozambique and India). Furthermore the SkyCat needs no ground handling crew and can return to base without refueling.

TELECOMMUNICATIONS

The unique StratSat stratospheric airship is designed as a geo-stationary telecommunications platform which will remain on station for up to five years and be recoverable when its equipment needs replacing.

Document 5-12 (e), “The Easy Solution to the Problem of Transporting Heavy Loads,” Press Release from CargoLifter AG, Frankfurt, Germany, May 2000.

CargoLifter is developing an airship, designed to transport heavy, oversized loads, weighing up to 160 tons, “the flying crane” requires practically no infrastructure[.]

MAY 2000

Berlin/Brand—The transportation of large, heavy or bulky goods is one of the major problems facing industry. Irrespective of whether they are sent by road, rail, air or ship, the transportation of oversized goods is expensive, time-consuming and problematic. The aim of CargoLifter AG, Berlin, is to provide a solution to this ‘weighty’ problem. The Company is developing an airship in Brand, Brandenburg, designed to transport large, heavy loads, weighing up to 160 tons.

The ‘flying crane,’ the airship known as the CargoLifter CL 160, has been designed to take over the international transportation of heavy loads as from 2003. The airship has a maximum range of 10,000 kilometers and makes almost no use of existing infrastructure, whilst offering significant advantages over traditional methods of transportation, in terms of cost and transportation times. Its future dock, which includes one of the largest, self-supporting hangars in the world, will be ready by the end of 2000 in Brand, to the south of Berlin, where the first prototype of the large airship will be built.

The CargoLifter, which will be 260 meters long, with a maximum diameter of 65 meters, will have a 550,000 cubic meter capacity and will be filled with non-inflammable helium gas. “The size and performance of the CargoLifter will help to significantly increase the scope of the existing transportation network”, explains Dr. Carl von Gablenz, Chairman of the CargoLifter AG Board. “We aim to use this airship as the basis for a new logistics system based on lighter-than-air technology.”

A NEW, FULLY-COMPATIBLE TRANSPORT OPTION

CargoLifter is designed to solve the major problems facing the mechanical engineering and plant manufacturing sectors. Up to now, low and narrow underpasses, hairpin bends, load restrictions on bridges, sharp inclines and steep slopes have slowed down heavy, oversized loads and increased transportation costs. These obstacles do not exist for the CargoLifter. Costly and time-consuming distribution procedures, i.e., transfers from truck to ship or train[.] are superfluous. According to von Gablenz: “the CargoLifter improves transport efficiency and is able to enhance the competitiveness of the entire industrial sector by reducing delivery times.”

The airship is not designed to replace conventional forms of transport, i.e. road, rail, ship or air[.] but is intended to act as a sensible supplement. “The combination of traditional forms of transport and CargoLifter can produce completely

new logistical networks”, explains Dirk Steffes, Chief Executive of CargoLifter Network GmbH. The specific strengths of different forms of transportation can be optimally deployed, taking account of cost/benefit ratios, using the method best suited to the job. According to information currently available, it appears that a combined option, involving sea ports, would be best.

A ‘FLYING’ CRANE...

The principle behind the CargoLifter is as simple as it is logical. The ‘flying’ crane picks up the load from its location and sets it down right at its destination. What is special about it: thanks to a newly-developed loading and unloading procedure, the CL 160 does not need to land. The airship is moored to four anchor pylons and hovers approximately 100 meters from the ground during landing. A specially designed lifting device is used for loading and unloading. The load is lifted using a special loading frame, which is winched up into the loading bays, all of which are 50 meters long and 8 meters high. When one load is set down, either a new load is picked up or a counter-weight, in the form of an appropriate volume of water, is pumped into a specially designed tank. The overall weight of the airship and consequently its handling features remains stable. This special loading procedure minimizes the ground infrastructure required. The CargoLifter requires neither bridges nor roads or runways. Four anchoring pylons on the ground and an open area the size of a standard football pitch is all that is required.

BENEFITS IN TERMS OF TIME AND COST

In many cases, it is quicker and, usually, cheaper to transport loads by CargoLifter than by current modes of transport. “CargoLifter has the flexibility to overcome traditional logistical limitations and can drastically reduce transportation costs and capital tie-up,” explains Steffes. The average flying speed of the CargoLifter is approximately 80 to 100 kilometers an hour, a drastic improvement on the average, current, eight kilometers per hour speed of conventional heavy transporters. As a result, CargoLifter reduces one of the major logistical cost factors to a minimum: the time during which goods are underway from production site to place of use. . . . The advantages are clear: there are financial consequences if a power station or company has to delay the start of production for two months rather than for three days. “Time is money”, is the calculation made by von Gablenz.

But that’s not all: only with the arrival of CargoLifter will a number of processes and products be possible at all. Currently, the design concepts used for oversized machinery and components, must allow them to be dismantled and transported by road. The CargoLifter puts an end to all that: finally engineers have the flexibility to manufacture and assemble everything from oversized turbines to prefabricated buildings and entire manufacturing plant components optimally”, explains Steffes.

As a result, the transporter airship will have an effect on the total net product chain from construction to assembly and delivery, and maintenance as well.

A LOOK AT THE MARKET

Detailed market studies, including those conducted by the Universities of Frankfurt/Main and Mainz and the Institute for the Shipping Trade and Logistics (Institut für Seeverkehrswirtschaft und Logistik—ISL) in Bremen, confirm the concept behind the transporter airship. The ISL forecasts a potential transport volume of at least three million tons a year, which represents a requirement for roughly 200 transport airships. The Company itself cannot meet this requirement with the series of four airships per annum from 2004 which it plans to build in Brand and a possible additional American location. “We will be able to produce a total of approximately 50 ships by 2015”, says Steffes.

However, the airship experts are not relying on theoretical forecasts alone. The development of the new logistics service is taking place in close consultation with future product users. For this purpose, CargoLifter has developed the lead user concept. Within the framework of a longer term partnership[,] the company and its potential customers, or lead users[,] are jointly producing a detailed concept of how the CargoLifter will be deployed for the individual customer. The purpose of this is to lay the technical, administrative and economic groundwork for the initial commercial deployment of the transporter airship. Some time ago, CargoLifter recruited, as lead users, 22 potential customers who are excellently placed within the target markets for the transporter airship. These lead users include ABB, Linde, Hochtief, Mitsui and Siemens. “The confidence shown by the lead users is an indication that there is both a requirement for and acceptance of the role of the ‘flying crane’ as a future logistical option”, sums up von Gablenz.

Document 5-13 (a-d)

- (a) Octave Chanute to Wilbur Wright, 13 March 1903, quoted in H. F. King, *Aeromarine Origins: The Beginnings of Marine Aircraft, Winged Hulls, Air-Cushion and Air-Lubricated Craft, Planing Boats and Hydrofoils* (London: Putnam, 1966), pp. 19–20.
- (b) Orville Wright to Commander Holden C. Richardson, date unknown, quoted in H. F. King, *Aeromarine Origins*, pp. 24–25.
- (c) Story in *Dayton Daily News*, date unknown, quoted in H. F. King, *Aeromarine Origins*, p. 25.
- (d) Bishop Milton Wright, diary entry, 1907, quoted in H. F. King, *Aeromarine Origins*, p. 37.

Although not well known for any interest in flying boats, the Wright brothers did spend some time designing aircraft that could operate from water. Perhaps the most notable instance of this came in 1907, when they contemplated building a “hydroaeroplane” at their old camp at Kitty Hawk and then making a surprise appearance flying over the U.S. fleet at the Jamestown Exposition being held to the north at Hampton Roads in Virginia. As this document string indicates, Orville and Wilbur first conducted experiments with floats and hydrofoils on the Miami River in Dayton in early 1907. One might guess they picked a secluded stretch of the river to make their tests, but according to published accounts and to photographs taken, their experiments took place near the city’s Third Street Bridge, with dozens of spectators watching. As the Dayton newspaper reported, the Wrights “would not state the exact purpose of the hydroplane,” wanting to keep their plan for a surprise appearance over the fleet at Jamestown a secret. Unfortunately, their dream of participating in the Jamestown Exposition came to naught. As Orville recalled in one of the documents provided below, “Immediately following these experiments negotiations with a foreign syndicate called us to Europe, so that the project of flying at Jamestown had to be given up.”

Given the growing popularity of the concept of hydroaeroplanes, the Wrights never gave up on the idea of pursuing them. After Wilbur died from typhoid fever in May 1912, Orville continued to work on the design of a seaplane, making his first successful water takeoff and landing (and this time on a *secluded* stretch of the Miami River) in 1913. Essentially the machine involved a Wright Model C airplane

fitted with a 240-pound pontoon. Wright's clumsy seaplane was a very ineffective machine compared to Glenn Curtiss's Model E flying boat of 1912, which was a genuine flying boat with a carefully designed—some even thought, dashing—hull. Nor was the flying boat that Grover Loening designed for the Wright Company in 1913–14, the Model G, much better. “Reluctant to adopt innovations pioneered by men whom he had accused of infringement on his ideas,” especially Curtiss, Orville insisted that Loening design a flying boat that looked in no way like Curtiss's. “The result,” according to aviation historian and Wright biographer Tom D. Crouch, “was much inferior and fell short of U.S. Navy requirements” (*The Bishop's Boys: A Life of Wilbur and Orville Wright* [New York and London: W. W. Norton & Company, 1989], p. 458).

Document 5-13 (a), Octave Chanute to Wilbur Wright, 13 March 1903, quoted in H. F. King, Aeromarine Origins: The Beginnings of Marine Aircraft, Winged Hulls, Air-Cushion and Air-Lubricated Craft, Planing Boats and Hydrofoils (London: Putnam, 1966), pp. 19–20.

‘Today I spent with Wm. Kress, who experimented with a flying boat last year. You may remember that pictures of it were published at the time, and that it came to grief; turned over and sunk [*sic*] upon the first trial. It has since been rebuilt.... It seems to me to possess some excellent points in construction, and that it may actually fly if a motor lighter than the present one can be obtained. The latter is a Daimler weighing some 30 lbs. per H.P....’

Document 5-13 (b), Orville Wright to Commander Holden C. Richardson, date unknown, quoted in H. F. King, Aeromarine Origins, pp. 24–25.

‘In 1906 after our Government and some of the European governments had shown little inclination to take our invention seriously we thought a way to impress them of its importance would be to make a flight over the parade of battleships to be held at the Jamestown Exhibition in 1907. At that time we contemplated assembling a new machine at our old camp at Kitty Hawk, flying it from there to Jamestown, and after taking an unexpected part in the parade, flying it back.... As such a project could not be carried out safely in a single flight we decided to put hydroplanes and floats on the machine so that starts and landing could be made from the water.

‘As soon as the weather permitted in 1907 we began experiments with the hydroplane on the Miami River at Dayton.... The cambered steel hydroplanes, located a few inches beneath the forward and rear ends of the floats, and extending between them, do not show in the picture [in the Dayton Herald of March 21, 1907] as they are under water.... In these tests on the river we used the motor, transmission and propellers from our 1905 aeroplane.... That motor when functioning

properly developed a little over 20 horsepower. But the experiments...terminated before we succeeded in getting more than two thirds of that power.

'With 14 horsepower the apparatus quickly raised until only the bottom of the floats dragged on the water. But we failed with this power to get the front edges of the planes entirely out of water and thus let the planes skim on their rear edges as we had expected. Just as the front edges reached the surface the planes seemed to lose a part of their lift with a consequent sinking back into the water. This was due to the loss of the lift on the upper side when the water ceased to flow over the top, but we did not understand the cause of it at the time....

'Immediately following these experiments negotiations with a foreign syndicate called us to Europe, so that the project of flying at Jamestown had to be given up.'

*Document 5-13 (c), Story in Dayton Daily News, date unknown,
quoted in H. F. King, Aeromarine Origins, p. 25.*

'The balustrades of the Third Street Bridge were lined Thursday morning with curious spectators.... The object of interest was the hydroplane which Wilbur and Orville Wright, inventors of the airship, were tampering with in preparation for its initial experimental run.

'Although the inventors, who are being branded as geniuses, would not state the exact purpose of the hydroplane it was intimated that it is to be used in connection with their airship....

'The present machine which is uniquely constructed from water boilers, an old gasoline engine and numerous strips of wood and sheet iron, with the water planes of copper, made its sail down the Miami River amid the encouraging cheers of the assembled spectators.'

*Document 5-13 (d), Bishop Milton Wright, diary entry, 1907,
quoted in H. F. King, Aeromarine Origins, p. 37.*

Among the least-known work which I have recorded in this chapter was that put in hand by the Wrights in 1907, and of which Bishop Milton Wright recorded in his diary: "The boys rigged up their floats and hydroplanes and tried them on the Miami."

Document 5-14 (a–d)

- (a) Gabriel Voisin on Henri Fabre's hydroaeroplane, date unknown, quoted in H. F. King, *Aeromarine Origins*, pp. 28–29.
- (b) Anonymous report on Fabre's hydroaeroplane, October 1909, quoted in H. F. King, *Aeromarine Origins*, p. 29.
- (c) E. Holt-Thomas on Fabre hydroaeroplane, June 1912, quoted in H. F. King, *Aeromarine Origins*, p. 30.
- (d) Article in *The Yachting World*, 1911, quoted in H. F. King, *Aeromarine Origins*, p. 31.

This string of documents concerns Henri Fabre, the French engineer and hydrodynamics expert who designed the first full-scale airplane to lift off from water, which occurred on 28 March 1910 at a place called Martigues. Perhaps the most problematic aspect of Fabre's approach was that he paid considerably more attention to the design of his floats than he did to design of the airplane itself. Getting clear of the water, he felt, was mainly a hydrodynamic or "marine" problem, not an aerodynamic one. Such an approach resulted in a vehicle that could do no more than make it off the water at a height of 6 feet. In truth, the machine he built was more hydroplane than airplane. Still, it pointed the way for Glenn Curtiss and others interested in the design of genuinely practical flying boats.

Document 5-14 (a), Gabriel Voisin on Henri Fabre's hydroaeroplane, date unknown, quoted in H. F. King, Aeromarine Origins, pp. 28–29.

'Fabre,' Gabriel recollected, 'who was living in Marseilles, was our friend. He often came to Paris and our discussions were always about flying machines. He was building a hydro-aeroplane—a seaplane, as the type was later called—close to the Berre lake. It can be seen in the French Musee de l'Air at Chalais-Meudon. It is an admirable machine, designed with the greatest care and made like a masterpiece.'

Document 5-14 (b), Anonymous report on Fabre's hydroaeroplane, October 1909, quoted in H. F. King, Aeromarine Origins, p. 29.

'M. Henri Fabre has completed at Marseilles, and hopes to try shortly, a new combination hydro-aeroplane. The machine is of the tandem monoplane type, and mounted on two air chambers, so that it can start from and, if necessary, skim along the surface of the water. It is fitted with four 12-h.p. two-cylinder Anzani motors.

'These particular floats are so designed that when the machine is moving either through the air or on the surface of the water, or with the floats completely submerged, there is always a vertical lift on them due to the speed. When a hydroplane is traveling over a rough sea, if its speed is sufficiently high and the waves large enough, there will come a moment when the forward part will be submerged in a wave into which at that moment the main body is just entering; that is to say, in spite of the vertical lifting effect due to the buoyancy of the float, there is also a contrary vertical force acting on its upper surface, which tends to cause such portion to dip, and the whole of the hull to pass under water. When this vertical downward thrust is greater than the upward thrust, a wreck would almost inevitably result, and the aim of the present invention is to prevent this.'

Document 5-14 (c), E. Holt-Thomas on Fabre hydroaeroplane, June 1912, quoted in H. F. King, Aeromarine Origins, p. 30.

'It has always seemed to me that too little attention has been paid to the flying part of the hydro-aeroplane machine, i.e., to the planes of the waterplane. What I mean is this; no matter how good the floats may be, an efficient waterplane can only be evolved by using an efficient aeroplane. The floats should be regarded as a landing chassis and a landing chassis only.... I have known Monsieur Fabre for a very long time, and we have often discussed his early experiments at Marseilles...he was quite convinced that he must evolve an extraordinary machine to get over the holding power of the water; whilst I was convinced, and I think events prove me right, that if he had taken a very efficient biplane and attached floats to it, he would have flown successfully two years ago.'

*Document 5-14 (d), Article in The Yachting World, 1911,
quoted in H. F. King, Aeromarine Origins, p. 31.*

April 12—‘There was an alarming incident at Monaco this morning, M. Fabre, the owner of the aero-hydroplane *Goeland*, nearly losing his life. *Goeland* is a novel kind of machine.... It is driven by a Gnome engine, and the inventor’s idea is that, after skimming for a certain distance on the surface of the water, the plane should gradually rise up into the air. It has caused one of the competitors to remark that he thought of carrying a punt-gun mounted vertically on his craft in case the long-legged monstrosity looked like hopping over him and securing the prize. [Previously it had been suggested that the craft would compete as a motor boat, rigged so that it could not fly.]

‘Since the weather conditions seemed perfect and the sea was quite smooth, M. Fabre determined on a trail [*sic*] run. The machine crossed the harbor in perfect style, skimming along the surface; nearing the harbor mouth, it rose up into the air to a height of about 30 yards, and soared along beautifully, greatly admired by thousands of spectators. As soon as it cleared the harbor, however, and encountered the full force of the wind outside, the machine became unmanageable and to the horror of the onlookers was swept along at a terrific pace towards the rocks and stone walls below the terraces. Fortunately, M. Fabre, with great presence of mind, managed to throw himself clear of the machine into the sea, and was promptly picked up, none the worse for his startling experience.’

Document 5-15

Grover Cleveland Loening, “Keels,” in *Monoplanes and Biplanes: Their Design, Construction, and Operation* (New York: Munn & Co., 1911), pp. 255–259.

So immature was the distinction between an airplane and a boat as late as 1911 that pioneering American aircraft designer Grover C. Loening (1888–1976) thought it necessary to explain the disadvantages for an aircraft to have a “keel.” On an aircraft, a keel, i.e., the longitudinal ridge along the center bottom of a boat’s hull, represented a “dead surface,” according to Loening. It raised drag while not adding to stability and control. Flying boats’ hulls would have keels, of course, as would rigid airships. In the latter, the ridge served to prevent hogging or sagging and helped to better distribute structural loads.

The following document is from Loening’s 1910 master’s thesis, *Monoplanes and Biplanes: Their Design, Construction, and Operation; The Application of Aerodynamic Theory with a Complete Description and Comparison of the Notable Types*, which New York publisher Munn & Company issued in 1911. Loening earned an M.A. degree in aeronautics from Columbia University, the first such degree conferred in the United States.

Loening became a very notable person in American aviation, and not just for his many contributions to the design of flying boats. More information on Loening will be provided in the header for Document 5-18, a set of documents in which Loening recalled some of his early flying boat designs and the significance of flying boats in aviation history.

*Document 5-15, Grover Cleveland Loening, "Keels,"
in Monoplanes and Biplanes: Their Design, Construction, and
Operation (New York: Munn & Co., 1911), pp. 255-259.*

Keels on aeroplanes, like keels on a boat, aid in the stability. But on an aeroplane they are "dead surfaces," and as such have the disadvantage of offering greater expanse of surface for wind disturbance to act upon. Furthermore, they unquestionably deaden the motion and decrease the speed. Tapering keels such as used on the Antoinette, Pelterie, Nieuport, Etrich and the latest Bleriot XIV, offer a maximum of "entering edge" with a minimum of area, and are for that reason more advantageous than rectangular shaped ones.

Separate keels are entirely absent in the Wright and Santos Dumont. The tapering bodies on the Breguet and many of the monoplanes are a distinct advance.

In the old Voisin type use was made of several vertical keels, partitions, placed not only at the rear, but also between the main surfaces themselves.

Keels add to the resistance of a machine[,] the skin friction and consequent power absorption of such surfaces being considerable, and it is generally conceded now, that control by rudders is becoming so perfected that any inherent stability to be attained by use of keels at the expense of power is hardly worth the while. No special form or combination of keels that have so far been designed and tried have really succeeded in giving any kind of complete inherent stability.

Keels at the rear of a machine somewhat on the order of a bird's tail are nevertheless found advantageous, and we can expect to see such surfaces on aeroplanes for many years to come.

Actual practice shows that they do increase stability and tend to hold the machine to its course.

The reason for this is that they act like the tail of an arrow. If the rear has a high resistance and directive surfaces, and the front is heavily weighted, like the head of an arrow, then the stability is much more perfect. The Antoinette is designed in this way, and in its dart-like flight certainly gives an impression of unusual steadiness.

Many of the present types are equipped with lifting tails. In the Farman, as in many others, the propeller blast causes the tail to lift. This is considered by many to be a bad provision, because if the propeller suddenly stops, the tail at once sinks, and this causes the dangerous condition of loss of headway.

IV. POSITION OF SEATS, MOTOR, ETC.

The position of the seat and the motor is an important point in aeroplane construction. On monoplanes, generally, the seat is placed in the *fuselage*, between the main planes and well to the rear. In the Antoinette and the Breguet, the seat is placed in the frame at a point that is deemed the safest, i.e., almost everything else will break before the aviator is touched. On the Wright, Curtiss, Farman, etc., the

aviator sits at the front of the main cell. He commands here an uninterrupted view of the air about him, and the land below him.

In the old Antoinette and many of the Bleriot's provision for seeing clearly below was not made. This was very detrimental, and the collision that occurred at Milan, when Thomas on an Antoinette, crashed into Dickson's Farman below him, merely because he could not see him, made this defect so patently evident, that the wings of the new Antoinette at once were notched at the rear, so that the aviator could obtain a view of the region below him.

The position of the seat on the Pischof, Bleriot XII, and Dornier is advantageous in that the aviator has a clear view below and on every side, can also watch the motor in front of him, and yet is comfortably placed, inside the frame, at a point that is in front of the propeller and fairly safe.

The position of the motor at the back of the aviator as on the Curtiss is now generally considered an undesirable one. In case of a sudden plunge to the ground, and a consequent breakage, the motor would fall out of the frame and very likely pin the aviator under it.

Similarly its position above the aviator as on the Grade, Bleriot "Aero-bus," and Santos-Dumont is dangerous, in that it would very likely crash through the frame and fall on the aviator's head, if the machine were suddenly to lose headway and sink to the ground.

In many cases aviators strap themselves into their seats, and the recent tragic death of Moisant, who was pitched head-long out of his seat when the machine suddenly dove down, bears out the wisdom of this measure.

The Maurice Farman and the Voisin were among the first prominent biplanes to have the seats and *fuselage* enclosed, and it is now recognized as quite necessary, especially for long duration flights, to protect the aviators from the head wind. The enclosed *fuselage* of the Paulhan and the new Farman "type Michelin," are as luxurious and as comfortable as "torpedo" body automobiles.

When the propeller is placed at the front there is still more reason for protecting the aviator as the air stream from the propeller is very disagreeable and likely to carry with it fine particles of oil, etc. McArdle in his flight of July 19th, 1910, on a Bleriot, because of the film of oil that had formed over his eyes, thought he was in a heavy mist, lost his way, and failed to find the Beaulieu grounds, whither he was bound.

In fact, the provision of a proper degree of comfort for the aviator and his passengers is becoming so important that within a few years we may actually see in use completely enclosed bodies, resembling the cabins on motor boats. Certainly such a provision would enable aviators to guide their aeroplanes to much higher altitudes. A light canvas, aluminum, and mica-glass body shaped in stream line form is looked forward to as a very practical innovation.

V. POSITION OF CENTER OF GRAVITY

The most advantageous position of the center of gravity is being actively discussed at present, and it appears that no really definite conclusions can be reached. It is recognized in long flights, that the gradual diminution of the gasoline supply affects the equilibrium of the machine, unless the gasoline tank is placed over the center of pressure. On some of the "long-distance" Bleriot XI. machines it is deemed necessary to put the gasoline tank low in the frame, in order not to bring the center of gravity too high; this position of the tank requires a pressure feed system. The idea in the new disposition of surfaces on the Farman "Michelin" seems to have been to raise the center of pressure so as to be able to carry an increased quantity of fuel in the usual position on the top of the lower plane, without any pressure feed to the engine.

The frequent *pique nez* of the Santos Dumont monoplanes, when, on landing, they stand right up on their nose, seems altogether to be due to a position of the center of gravity that is much too high. This, of course, is due to the placing of the motor above the plane.

A low center of gravity, as on the Pischof, is said by some to add greatly to the natural stability because of the pendulum effect, and by others it is thought to be detrimental to turning maneuvers and transverse stability. Actual observation of machines with a low center of gravity in flight shows that they are far more difficult to incline transversely than a machine with a center of gravity about in line with the propeller axis. Machines with the latter provision are easier to handle in almost every way.

Document 5-16

Lieutenant T. G. Ellyson, U.S.N., “Safe Flying and the Flying Boat,” *Transactions of the New York Electrical Society* (New Series, 1913, No. 6): 69–79.

Theodore G. “Spuds” Ellyson, a 1905 graduate of the U.S. Naval Academy, is a legendary figure in U.S. naval aviation history, as he was the first naval officer ever to receive flight training. This occurred in late 1910, under the direction of aviation pioneer Glenn H. Curtiss.

In this excerpt from a 1913 paper he presented at an annual meeting of the New York Electrical Society, Ellyson, then a lieutenant, narrated his associations with the development of the first Curtiss flying boat, from its delivery to the U.S. government in July 1911, through design refinement at Curtiss’s facility on Keuka Lake near Hammondsport, New York, to warm-water training operations set up on North Island in San Diego, to further development of the “hydroaeroplane” back in Hammondsport. Without question, Ellyson became a great fan of Curtiss and of the flying boat. In earlier sections of his 1913 paper (not published here), Ellyson wrote the following:

- “It is an undisputed fact that Mr. Glenn H. Curtiss was the first person in the world to rise from and land, on both land and water, using the same machine. This was accomplished in 1911 and to him alone is due all credit for the beginning of safe flying as it is considered in this paper, or hydroaviation as it has been called” (61–62).
- “The hydro-aeroplane does away with the necessity of large land aerodromes, which are comparatively scarce, for any large body of water is a natural and ideal aerodrome” (62).
- “Over water the worst that can happen is a ducking” (63).
- “There is always a safe and unobstructed landing place, hence it is not necessary to fly at a greater height than a few feet or not to leave the water at all” (63).
- “It has been my experience that the ‘Flying Boat’ can be used in weather as rough as that in which one would ordinarily care to operate a small motor boat” (64).

Not only did Ellyson become one of the strongest proponents of flying boats, he was also one of the naval officers most committed to what would come to be called “carrier operation.” In November 1912, he became the first naval aviator to make a successful catapult launch, from a makeshift arrangement atop a barge in the Washington Navy Yard.

A biography of Ellyson (but a rather spotty one) is available in George von Deurs, *Anchors in the Sky: Spuds Ellyson, the First Naval Aviator* (San Rafael, CA: Presidio Press, 1978). William F. Trimble also discussed Ellyson's career in *Admiral William A. Moffett: Architect of Naval Aviation* (Washington and London: Smithsonian Institution Press, 1994), pp. 84–85, 204, 244–245. Following service during World War I in command of sub-chaser units in England and outfitting captured German passenger liners for the return home of American servicemen after the conflict, Ellyson in January 1921 became executive officer of the Naval Air Station at Hampton Roads, Virginia. Ten months later, Admiral William Moffett brought Commander Ellyson to Washington, DC, to head up the Plans Division of the Navy's new Bureau of Aeronautics. He became executive officer of the carrier U.S.S. Lexington at the ship's commissioning in Boston on 14 December 1927.

Tragically, but perhaps fittingly, Ellyson died at sea. On 27 February 1928, he and two other officers disappeared over the Chesapeake Bay in their aircraft, apparently after an engine failure. It took days for the Navy to find the plane's wreckage and more than a month to recover what remained of Ellyson's body. Ironically, the aircraft was a Loening amphibian. Obviously, the worst that could happen over water was far more than a ducking, as he had pronounced in his 1913 paper. Of course, even long before Ellyson's tragic death (he was on his way from Naval Air Station Hampton Roads to Annapolis to visit his bedridden daughter), no one associated with naval aviation had to be told how dangerous it was. Just in training at Naval Air Station Pensacola between 1914 and 1917, for example, dozens of men had died or were seriously injured. The Curtiss pushers (which were not seaplanes) used to train naval aviators were wickedly tricky to handle and deadly in crashes. One of the Navy's priorities coming out of the war was coming up with a safer trainer.

*Document 5-16, Lieutenant T. G. Ellyson, U.S.N.,
"Safe Flying and the Flying Boat," Transactions of the
New York Electrical Society (New Series, 1913, No. 6): 69-79.*

Now to come to the subject of the development of the "Flying Boat." It was in July, 1911, that the first hydro-aeroplane, a Curtiss, was delivered to the Government. Through the courtesy of Mr. Curtiss, and owing to the fact that the Navy aerodrome was not completed at that time, this machine was kept at Hammondsport and experimental work conducted there in developing minor details, and in thoroughly trying out the machine to determine what its limitations were. We found to our surprise that it handled as easily as a land machine, and that it banked and assumed a gliding angle quite as easily; then we began to note the defects. The machine did not leave the water in a calm with the weight we thought necessary; in rough water we occasionally broke a propeller; if there were any sort of a sea we would be wet to the knees; it was easy to make a bad landing especially in a side wind; it did not handle as well as we desired on the water, and it was not fitted with a self-starter.

Mr. Curtiss took hold of these problems as they presented themselves and solved all of them before the machine was sent to Annapolis in September. Then he wished to know what sort of a machine the Navy wanted, but our experience was limited, and we only suggested a boat hull with enclosed hood for aviator and instruments. It was at this time that he outlined to us his idea of the "Flying boat"; and although we listened with respect and enthusiasm, we feared that for once he was attempting the impossible, for it must be remembered that at this time, with the exception of Mr. Curtiss himself, the Navy fliers were the only persons operating a hydro. As a matter of fact, we were so skeptical that I am afraid that we did not give the matter serious thought.

It was not until we arrived in San Diego, Cal., early in January, 1912, that we again thought of the matter, and only then when we saw the model of one of the boats under construction. This was later fitted to one of the Curtiss speed machines, being the only aeroplane available at the time. These surfaces are small and very flat, and hence known to be inefficient for the weight to be lifted. A double tractor was decided on, to be chain driven, for it was thought that the efficiency gained from geared down propellers of large diameter and pitch would in a measure overcome the inefficient plane surfaces, at least enough for experimental purposes. The motor used was a standard Curtiss 50-60 h.p. This was the first development. The bow of the boat extending as far back as the front edge of the plane is the same as that used in the old pontoons. The Curtiss bamboo tail is the same, but the boat is ten feet longer, and the operator's seat is well back between the planes. The engine is low and easily accessible to either the operator or passenger. Trouble was experienced with the chains from the start, and they were continually

breaking, which led to the conclusion that the chain drive was not dependable for the amount of power needed.

The arguments in favor of this type were as follows: Efficiency due to propellers of large diameter and pitch and hence less power required with the reduction of power[;] less weight, owing to the lower consumption of gasoline and oil; low center of gravity; accessibility of the engine to the operator and passenger; greatest clearance from the water for the propellers, and hence danger of breaking them reduced to a minimum; protection of the aviator from wind and water. Many runs over the water and several short jumps in the air were made with this machine, but difficulties with the chain drive and other more important disadvantages led to the abandonment of the type. Some of the disadvantages were that the pilot was in the rear of and close to the exhaust, which was hard on both the hearing and the eyesight; the chain drive was unsatisfactory; the line of vision was very much obscured; [and] the safety factor was greatly reduced, for in case of a sudden plunge into the water, the operator would be thrown through the framework, chains, or propellers, and probably become entangled therein.

The next experiment reverted to the direct-drive propeller, and in order to obtain sufficient clearance from the boat it was necessary to allow the engine to extend above the top plane. Experiments with this type showed that the center of thrust was too high; that the tail stabilizers and controls made fast to the boat were placed too low, and were easily damaged by the waves, though this position greatly improved the maneuvering qualities of the machine; that a hood was necessary for the bow of the boat to keep the operator dry; that a step would have to be used in order to allow the boat to leave the water easily; and that the boat would have to slant upward towards the stern, because at high speeds the stern dragged and brought undue strains on the rear controls as well as tending to hold the boat on the water.

By this time sufficient data had been obtained to warrant the construction of a machine. Special plans were manufactured with a different camber and different curvature, and the chord and separation of the planes were increased. Triangular extensions were added and given a slight dihedral angle, and these with the increased amount of surface due to the larger planes, greatly increased the lifting capacity. The greater separation of the planes allowed the engine to be properly mounted, and at the same time give the propeller enough clearance. A step was built in the boat which enabled it to leave the water more quickly, and vent tubes were led from abaft the step to the top of the boat, to relieve the suction which was found to be appreciable when running at high speeds. The front control was used for the first experiments but this was later discarded as useless.

Practically the entire development work was accomplished with this model after innumerable experiments. The factors hardest to determine were the location, shape, and depth of the step in the boat, the lines of the body of the boat abaft the step, and the location and design of the rear controls. A change in any of

these factors generally resulted in a change [in all] of them, which was instructive but tedious.

All of the determining factors had been obtained, but surfaces of a different camber and curvature and the trailing aileron were used and the size of the boat was increased. The hood for the protection of the aviator was developed on this model, and also the proper location of the rear controls. These were so placed that when the machine was running on the water, the air rudder was used as a water rudder, and at the same time the other controls were raised so that they would not be endangered by the waves. No advantage was found in the use of the trailing aileron and it was abandoned.

The original model was again rebuilt and the results of all the experiments embodied in it. This was then tried out at Hammondsport over Lake Keuka, under all conditions of wind and weather obtainable there, and was found to handle perfectly. I tried the machine out at this time and was more than pleased with it, but still not thoroughly convinced that it would handle well under bad weather and bad weather conditions, and suggested that it be shipped to some place where these could be obtained. As a result the machine was shipped to Charlotte, a suburb of Rochester, N.Y., on Lake Ontario, and for the first time I prayed for wind and rough water before flying, but even that brought no results for five days. Then there came a northeaster and after this had subsided the water remained rough, about a four-foot sea, and the wind was blowing between twelve and fifteen miles an hour. The machine was then given a thorough test, and found to be dry on the water, easily handled in the water, and satisfactory in every respect.

Some of the tests were: running on the water at full speed headed into the wind and sea; with wind and sea following; in a cross sea; turning both into and away from the wind, at both high and low speeds. Next came rising from and lighting on the water, with the wind ahead, astern, and on the beam. This was easily accomplished, but would have surely meant a spill in the old type hydro-aeroplane. The final and hardest test was stalling the machine and allowing it to drop from low altitudes, to determine if it was structurally strong enough. This was started very close to the water, but the last drop was from a height of nearly fifteen feet, and nothing was strained or broken.

Here was tested the invention of Mr. Curtiss for enabling the aeroplane to ride safely on the water with the engine stopped and a strong wind blowing. If some means were not employed, when there is both wind and sea, and the machine is dead in the water, the wind will get under the weather wing and cause the machine to capsize. I have referred to the triangular extensions at the ends of the upper planes. These extensions are hinged and connected to a lever [on the] back of the operator's seat, and a movement of this lever drops these extensions to an angle of forty-five degrees with the main planes, and rigidly holds them in that position. Now the pressure of the wind on the windward wing will be on top of this extension and tend to keep this wing down. On the lower wing it will be under this

extension and tend to hold this wing up. Upon trial it functioned well and kept the machine on practically an even keel.

Immediately after these tests the Curtiss Aeroplane Company Flying Boat was offered to the public, and the construction of one for the Navy and one for the Army was started. For his development of the Flying Boat, Mr. Curtiss was awarded the Collier Trophy by the Aero Club of America, for the greatest achievement in aviation during the year 1912.

In Fig. 2 [*not reproduced*] is shown the machine delivered to the Navy. Note the wheels for use on land, the high hood for the protection of the passengers and instruments, the hand crank above the seat for starting the motor, and the solid appearance of the whole machine.

As to the general characteristics of this machine: In appearance it is a blue or slate color, the same as the war color used on battleships, which wears well and gives the machine a neat clean look. It is one of the first machines in this country that has been scientifically built—that is, extra strong in the engine section where strength is needed, and tapering to the wing tips where there is less strain. Heretofore it has been the custom to make the wing beams and ribs the same size and strength as those of the center section, with the result that the latter were overloaded. The operator's and passenger's seats are low down, with a clear field of vision both ahead and below, well protected from both water and wind. There is a feeling of security similar to that of riding in an automobile. The machine can be operated from either seat, and by simply turning a knob between the seats either set of controls can be disconnected, but not both sets at the same time. This gives the person not driving a chance to rest or to make observations without the controls interfering with him.

The instruments, which are mounted under the hood and well protected from the wind and weather, are as follows: Electrical speedometer, showing revolutions of the engine; chart roll; compass; inclinometer, to show climbing or gliding angle; gasoline and oil gauges; clock; barograph. All of these instruments are visible to both operator and observer.

In order to keep the weight as low as possible and to reduce the head resistance, the main gasoline tank (42 gallons) is situated in the hull of the boat. There is an auxiliary feeder tank, eight gallons capacity, attached to the side of the engine bed, in order to get a head of gasoline for the carburetor. Gasoline is pumped from the main to the feeder tank by means of a plunger pump driven from the water pump shaft, there being an overflow to the main tank which takes care of any excess. In case the pump should break down, a small electric light under the hood is automatically lighted as soon as the gasoline in the feeder tank drops to four gallons. Then it is only necessary to close the vent on the main tank, and by means of a hand air pump accessible to the operator, put pressure on this tank, which forces gasoline to the feeder tank. For rising from and landing on the water when it is not advisable to release the controls even for an instant, the engine is controlled by a foot throttle; but since in the air this may become tiresome, especially on a long glide, a hand

throttle is fitted for this use. Between the seats and accessible to both passengers is the lever for operating the wheels, which fold up close under the planes. This is necessary, as the machine will not rise from the water if the wheels are allowed to drag, and once in the air the head resistance is greatly reduced if the wheels are raised. When it is desired to alight on the land, the lever is simply released and the wheels fall into place and are rigidly locked, and then a landing can be made on fairly rough ground as easily as with an ordinary aeroplane. The engine is fitted with a muffler which adds greatly to the comfort of the aviators.

As to the handling of the Flying Boat: It can be turned on the water in shorter spaces than a motor boat of the same length, but it turns better at low than at high speeds, because in the former case the boat settles in the water, and the air rudder becomes an effective water rudder. In the air it handles as easily as an aeroplane, on banks, turns and glides, and is very much steadier. George Beatty, one of the veteran Wright fliers, made his first flight in a Flying Boat, and incidentally in a Curtiss machine, a short time ago. After the flight he expressed his opinion that it was steadier, there was less vibration, and that it was more comfortable than any machine he had ever been in, and also as easily handled. At no time does the operator or passenger become wet by the spray as was the case in the old hydro, nor is there any chance of breaking a propeller due to striking the water, or coming to grief as the result of landing in a side wind. When flying at the Washington Navy Yard, it was the common practice to stop the machine in the river, have a motor boat come alongside and transfer passengers, and start again without outside help. The same thing could be easily done if it was desired to tie up to a buoy. In brief, in these respects it is brought into a class with the motor boat.

In the accompanying illustrations, Fig. 5 [*not reproduced*] shows the "flying boat" starting out as a motor boat. Fig. 3 [*not reproduced*] shows a rear view of the "flying boat" starting out as a motor boat at twenty-five miles an hour. The "boat" is shown in Fig. 6 [*not reproduced*] with the planes slightly raised. With her tail only resting on the water[,], the "boat" is traveling at fifty miles an hour. In Fig. 7 [*not reproduced*] the machine has risen from the water and is traveling at sixty miles an hour. Fig. 4 [*not reproduced*] shows the contour of the "boat" in full flight. In Fig. 8 [*not reproduced*] she is returning before the wind at seventy-five miles an hour.

Other designs have been and are being produced in this country, but so little flying has been done with any other type up to the present time, that it is hard to criticize them impartially. The Donnet-Leveque was developed abroad about the same time that the Curtiss Flying Boat was developed here. This machine is very similar to the Curtiss, except that it is designed for one passenger only, and is very light, the total weight with fuel being under one thousand pounds. The Gnome motor is used. It climbs very fast, nearly three hundred feet a minute, which is partly due to the very light boat used. This boat will not stand use in rough water, as was proved by the flights made by Beaumont; and in every instance where rough water was encountered the boat was wrecked.

The Benoist Company have lately placed a Flying Boat on the market, which is shown in Fig. 9 [*not reproduced*]. The power plant is placed in the boat, the propeller being chain-driven, but it seems that this would place the center of gravity too low. In describing the boat, Mr. Robinson, who has been operating the machine, states that it banks itself without use of the ailerons, and that in a puffy wind it oscillates to some extent. The two seats are placed tandem, and the Roberts motor is used at present.

Fig. 10 [*not reproduced*] shows a Flying Boat now being built for the Navy by Burgess Co. & Curtis, which develops a speed of about forty-five miles per hour on the water and sixty-eight miles in the air. It is equipped with a 70-h.p., eighty-cylinder, air-cooled Renault motor and has a spread of forty-six feet in the upper plane and thirty-eight feet in the lower plane, the planes being covered with Burgess specially prepared linen. The construction is interesting on account of the fact that it is the first aeroplane ever built using the warping system, having the lower plane constructed rigidly and the entire surface of the upper plane warping.

This plane is staggered forward of the lower plane and is supported by one central steel tubular beam, running through the center of the plane, just forward of the center of pressure. By the removal of the four bolts, the aeroplane can be released entirely from the boat section, and by the removal of two other bolts the rear section of the boat can be separated from the front section. The wings fold almost automatically together for shipment. It is estimated that the machine can be entirely dissembled by four men in from twenty to thirty minutes.

The Washington Aeroplane Co. has developed a Flying Boat, now being tried out at Washington, which is well constructed and promises well. The Gyro motor is used. One of the chief features is the long trailing edge of the plane, which is intended to give great lift at the start, and high speed once in the air. Mr. Loening, of New York City, has experimented with the Flying Boat for the past four years, and the engineering features of this machine are among the best yet developed.

These are only a few of the manufacturers interested in this subject, but the enthusiasm which is being exhibited bids fair to make the Flying Boat a popular sport before the coming summer is over.

In conclusion I wish to show a picture of a race between a hydro and two Flying Boats (Fig. 11) [*not reproduced*]. On crossing the finish line both boats have forged ahead of the hydro which they are leaving far behind. This race was over a three mile course, and was more exciting than any other race I have ever witnessed.

Document 5-17 (a–c)

(a) Samuel W. Stratton, Secretary, National Advisory Committee for Aeronautics, 2722 Navy Building, 17th and B Streets NW, Washington, DC, to Dr. J. C. Hunsaker, Member, Committee on Aerodynamics, NACA, Washington, DC, 17 May 1920, in Jerome C. Hunsaker Papers.

(b) J. C. Hunsaker, Commander, Construction Corps, U.S. Navy, to Dr. Joseph S. Ames, National Advisory Committee for Aeronautics, Room 2722, Navy Building, Washington, DC, “Letter from N.A.C.A. to Dr. Hunsaker dated May 17, 1920, No. 3261,” 1 September 1920, in Jerome C. Hunsaker Papers.

(c) Ludwig Prandtl, “Applications of Modern Hydrodynamics to Aeronautics,” NACA Technical Report 116 (Washington, DC, 1921).

At the conclusion of World War I, the fledgling U.S. aeronautical establishment sought to find out as much as possible about what the Germans had been doing to advance the science and technology of flight during the war. Much of that focus was on work occurring at the aerodynamic research institute under Dr. Ludwig Prandtl’s direction at the University of Göttingen. As historian Paul Hanle has noted in his 1982 book *Bringing Aerodynamics to America*, “a spate of reports on the Göttingen institute appeared in English-language aeronautical journals” soon after the war’s end. The National Advisory Committee for Aeronautics was so interested in what had been discovered at Göttingen that it actively pursued different personal contacts with Prandtl and several of his students. The NACA, in fact, hired one of them, Max M. Munk, as a technical assistant. Moreover, it published a series of reports from 1920 to 1924 that catalogued the aerodynamic characteristics of all known airfoil shapes. Of the 503 airfoil sections included in these reports (TR 93 [1920], TR 124 [1921], and TR 182 [1924]), data from nearly one-third of them came from the Göttingen laboratory.

The following string of documents shows how the NACA in 1920 specifically solicited and paid (\$800) for a report from Professor Prandtl on “the state of the art of hydrodynamics as applied to predicting the aerodynamic forces on bodies shaped like airplane wings and airship envelopes.” The resulting treatise, “Applications of Modern Hydrodynamics to Aeronautics,” was published by the NACA as Technical Report No. 116 in 1921. In this paper, Prandtl explained, among other things, his rational, engineering-oriented “lifting-line” theory for calculating the lift and

induced drag of an airfoil section. This quickly became one of the basic ways of estimating the aerodynamic behavior of a wing.

The reaction to this paper was extremely significant in that it essentially introduced the genius of Prandtl and his theories to the English-speaking world. John D. Anderson, in his *A History of Aerodynamics* (p. 292), argues that the appearance of the paper caused a “major culture shock within the American aeronautical-engineering community.” In place of cut-and-try testing, Prandtl’s paper showed American engineers how very far they still had to go to advance and assimilate theory while integrating theory and experiment. In essence, it introduced the mentality and methods of what came to be called “engineering science” into the U.S. aeronautics research community.

Document 5-17 (a), Samuel W. Stratton, Secretary, National Advisory Committee for Aeronautics, 2722 Navy Building, 17th and B Streets NW, Washington, DC, to Dr. J. C. Hunsaker, Member, Committee on Aerodynamics, NACA, Washington, DC, 17 May 1920.

Dear Sir:

In accordance with [the] resolution adopted by the Executive Committee of the National Advisory Committee for Aeronautics at its meeting held on May 10, 1920, I hereby authorize you to act as an agent of the Government of the United States and of the National Advisory Committee for Aeronautics for the purpose of entering into [a] contract with Prof. L. Prandtl, of the University of Gottingen, Gottingen, Germany, for a report upon the state of the art of hydrodynamics as applied to predicting the aerodynamic forces on bodies shaped like airplane wings and airship envelopes, the report to contain at least twenty thousand words, giving the experimental evidence and mathematical analysis upon which conclusions are based; the report to be submitted typewritten in duplicate, in German text complete with originals of all illustrations, diagrams, etc., necessary to illuminate the text, together with an abstract of the report in English, typewritten in duplicate. The report is to be delivered immediately upon completion to the National Advisory Committee for Aeronautics, Office of the Technical Assistant in Europe, 10 Rue Victorien Sardou, 16°, Paris, France.

You are authorized to negotiate with Professor Prandtl for this report, and to enter into [a] contract to pay not more than \$1,000 for same, payment to be made by the Committee’s Technical Assistant in Europe within ten days after delivery of the report in satisfactory condition. A blank form of contract is attached, and it is requested that five copies be prepared: one to be left with Professor Prandtl, one to be sent to our Technical Assistant in Europe, and the remaining three copies to be sent to this office.

Respectfully,

NATIONAL ADVISORY COMMITTEE FOR AERONAUTICS

Document 5-17 (b), J. C. Hunsaker, Commander, Construction Corps, U.S. Navy, to Dr. Joseph S. Ames, National Advisory Committee for Aeronautics, Room 2722, Navy Building, Washington, DC, "Letter from N.A.C.A. to Dr. Hunsaker dated May 17, 1920, No. 3261," 1 September 1920.

Subject: Professor Prandtl.

Reference: (a) Letter from N.A.C.A. to Dr. Hunsaker dated May 17, 1920, No. 3261.

Enclosures (herewith): [*not reproduced*]

(A) Four (4) copies of contract with Prof. Prandtl dated July 22, 1920.

(B) Letter from Prof. Prandtl dated July 26, 1920, to Dr. Hunsaker.

(C) Copy of letter from Dr. Hunsaker to Prof. Prandtl dated August 6, 1920.

In accordance with reference (a), I went to Gottingen, met Professor Prandtl and came to an agreement with him which is embodied in a contract signed by me on behalf of the Committee and by Prof. Prandtl. Four (4) copies of this contract are enclosed, herewith, enclosure (A). It will be noted that the contract calls for delivery of Prof. Prandtl's report to the Committee's office in Paris. I, therefore, recommend that a copy of this contract be sent to the Paris office with instructions to pay Prof. Prandtl \$800 upon delivery of his report.

I found Prof. Prandtl very ready to resume friendly relations and believe that he will make a very fine employed [*sic*] by the Zeppelin Company until the end of this year when he will be without a job. In another letter I have recommended the employment of Dr. Munk by the Advisory Committee.

Dr. Prandtl would be very much pleased if he could undertake further work for our Committee, either of a theoretical nature involving mathematics or experimental wind tunnel research.

There is enclosed, herewith, enclosure (B), a letter outlining the problems which he thinks will be most important and which he is in a position to undertake for the Committee with estimated cost. I recommend that this letter be translated and submitted to the Aerodynamics Committee for consideration. I believe that a small amount of money can be spent with Prandtl to very good advantage as he is unquestionably the only man in his particular field. Prof. Prandtl also inquired as to the notation and units he should use in his report and I enclose, herewith, enclosure (C), a copy of my reply which I trust is satisfactory to the Committee.

The best presentation of Prandtl's work on theory of aerofoils is given in the following publications, the first of which is a semi-popular survey:

Tragflächen—Auftrieb und—Widerstand in der Theorie—L. Prandtl.

(Jahrbuch der wissenschaftlichen Gesellschaft für Luftfahrt V. Band 1920).

Tragflugeltheorie, I. Mitteilung, von L. Prandtl.

(K. Gesellschaft der Wissenschaften zu Gottingen Mathematisch—physikalische Klasse. 1918).

Tragflugeltheorie, zweite Mitteilung, von L. Prandtl.

(K. Gesellschaft der Wissenschaften zu Gottingen Mathematisch-physikalische Klasse. 1919).

It is understood, but not specified in the contract, but is nevertheless a moral obligation on the Committee, that the report prepared by Prof. Prandtl will be published by the Committee in the usual way under Prof. Prandtl's name and will receive the usual distribution that such publications receive. Prof. Prandtl consulted with his friend Prof. Runge before agreeing to accept the proposition I made to him and in arriving at the price of \$800. Prof. Prandtl appeared to be pleased that the Advisory Committee had selected him to explain for American readers the German advances in aerodynamical matters. As a matter of fact, all of the theoretical work in aerodynamics done in Germany during the past few years appears to have been done either by Prof. Prandtl or by his students and assistants.

Document 5-17 (c), Ludwig Prandtl, "Applications of Modern Hydrodynamics to Aeronautics," NACA Technical Report 116 (Washington, DC, 1921).

PREFACE

I have been requested by the United States National Advisory Committee for Aeronautic[s] to prepare for the reports of the committee a detailed treatise on the present condition of those applications of hydrodynamics which lead to the calculation of the forces acting on airplane wings and airship bodies. I have acceded to the request of the National Advisory Committee all the more willingly because the theories in question have at this time reached a certain conclusion where it is worth while to show in a comprehensive manner the leading ideas and the results of these theories and to indicate what confirmation the theoretical results have received by tests.

The report will give in a rather brief Part I an introduction to hydrodynamics which is designed to give those who have not yet been actively concerned with this science such a grasp of the theoretical underlying principles that they can follow the subsequent developments. In Part II follow then separate discussions of the different questions to be considered, in which the theory of aerofoils claims the greatest portion of the space. The last part is devoted to the application of the aerofoil theory to screw propellers.

At the express wish of the National Advisory Committee for Aeronautics I have used the same symbols in my formulae as in my papers written in German. These are already for the most part known by readers of the Technische Berichte. A table giving the most important quantities is at the end of the report. A short reference list of the literature on the subject and also a table of contents are added.

PART I
FUNDAMENTAL CONCEPTS AND THE MOST IMPORTANT
THEOREMS.

1. All actual fluids show internal friction (viscosity), yet the forces due to viscosity, with the dimensions and velocities ordinarily occurring in practice, are so very small in comparison with the forces due to inertia, for water as well as for air, that we seem justified, as a first approximation, in entirely neglecting viscosity. Since the consideration of viscosity in the mathematical treatment of the problem introduces difficulties which have so far been overcome only in a few specially simple cases, we are forced to neglect entirely internal friction unless we wish to do without the mathematical treatment.

We must now ask how far this is allowable for actual fluids, and how far not. A closer examination shows us that for the interior of the fluid we can immediately apply our knowledge of the motion of a nonviscous fluid, but that care must be taken in considering the layers of the fluid in the immediate neighborhood of solid bodies. Friction between fluid and solid body never comes into consideration in the fields of application to be treated here, because it is established by reliable experiments that fluids like water and air never slide on the surface of the body; what happens is, the final fluid layer immediately in contact with the body is attached to it (is at rest relative to it), and all the friction of fluids with solid bodies is therefore an internal friction of the fluid. Theory and experiment agree in indicating that the transition from the velocity of the body to that of the stream in such a case takes place in a thin layer of the fluid, which is so much the thinner, the less the viscosity. In this layer, which we call the boundary layer, the forces due to viscosity are of the same order of magnitude as the forces due to inertia, as may be seen without difficulty. It is therefore important to prove that, however small the viscosity is, there are always in a boundary layer on the surface of the body forces due to viscosity (reckoned per unit volume) which are of the same order of magnitude as those due to inertia. Closer investigation concerning this shows that under certain conditions there may occur a reversal of flow in the boundary layer, and as a consequence a stopping of the fluid in the layer which is set in rotation by the viscous forces, so that, further on, the whole flow is changed owing to the formation of vortices. The analysis of the phenomena which lead to the formation of vortices shows that it takes place where the fluid experiences a retardation of flow along the body. The retardation in some cases must reach a certain finite amount so that a reverse flow arises. Such retardation of flow occurs regularly in the rear of blunt bodies; therefore vortices are formed there very soon after the flow begins, and consequently the results which are furnished by the theory of nonviscous flow can not be applied. On the other hand, in the rear of very tapering bodies the retardations are often so small that there is no noticeable formation of vortices. The principal successful results of hydrodynamics apply to this case. Since it is these tapering bodies which

offer specially small resistance and which, therefore, have found special consideration in aeronautics under similar applications, the theory can be made useful exactly for those bodies which are of most technical interest.

For the considerations which follow we obtain from what has gone before the result that in the interior of the fluid its viscosity, if it is small, has no essential influence, but that for layers of the fluid in immediate contact with solid bodies exceptions to the laws of a nonviscous fluid must be allowable. We shall try to formulate these exceptions so as to be, as far as possible, in agreement with the facts of experiment.

2. A further remark must be made concerning the effect of the compressibility of the fluid upon the character of the flow in the case of the motion of solid bodies in the fluid. All actual fluids are compressible. In order to compress a volume of air by 1 per cent, a pressure of about one one-hundredth of an atmosphere is needed. In the case of water, to produce an equal change in volume, a pressure of 200 atmospheres is required; the difference therefore is very great. With water it is nearly always allowable to neglect the changes in volume arising from the pressure differences due to the motions, and therefore to treat it as absolutely incompressible. But also in the case of motions in air we can ignore the compressibility so long as the pressure differences caused by the motion are sufficiently small. Consideration of compressibility in the mathematical treatment of flow phenomena introduces such great difficulties that we will quietly neglect volume changes of several per cent, and in the calculations air will be looked upon as incompressible. A compression of 3 per cent, for instance, occurs in front of a body which is being moved with a velocity of about 80 m./sec. It is seen, then, that it appears allowable to neglect the compressibility in the ordinary applications to technical aeronautics. Only with the blades of the air screw do essentially greater velocities occur, and in this case the influence of the compressibility is to be expected and has already been observed. The motion of a body with great velocity has been investigated up to the present, only along general lines. It appears that if the velocity of motion exceeds that of sound for the fluid, the phenomena are changed entirely, but that up close to this velocity the flow is approximately of the same character as in an incompressible fluid.

3. We shall concern ourselves in what follows only with a nonviscous and incompressible fluid, about which we have learned that it will furnish an approximation sufficient for our applications, with the reservations made. Such a fluid is also called "the ideal fluid."

What are the properties of such an ideal fluid? I do not consider it here my task to develop and to prove all of them, since the theorems of classical hydrodynamics are contained in all textbooks on the subject and may be studied there. I propose to state in what follows, for the benefit of those readers who have not yet studied hydrodynamics, the most important principles and theorems which will be needed for further developments, in such a manner that these developments may be grasped. I ask these readers, therefore, simply to believe the theorems

which I shall state until they have the time to study the subject in some textbook on hydrodynamics.

The principal method of description of problems in hydrodynamics consists in expressing in formulas as functions of space and time the velocity of flow, given by its three rectangular components, u , v , w , and in addition the fluid pressure p . The condition of flow is evidently completely known if u , v , w , and p are given as functions of x , y , z , and t , since then u , v , w , and p can be calculated for any arbitrarily selected point and for every instant of time. The direction of flow is defined by the ratios of u , v , and w ; the magnitude of the velocity is $\sqrt{u^2 + v^2 + w^2}$. The "streamlines" will be obtained if lines are drawn which coincide with the direction of flow at all points where they touch, which can be accomplished mathematically by an integration. If the flow described by the formulas is to be that caused by a definite body, then at those points in space, which at any instant form the surface of the body, the components of the fluid velocity normal to this surface must coincide with the corresponding components of the velocity of the body. In this way the condition is expressed that neither does the fluid penetrate into the body nor is there any gap between it and the fluid. If the body is at rest in a stream, the normal components of the velocity at its surface must be zero; that is, the flow must be tangential to the surface, which in this case therefore is formed of stream lines.

4. In a stationary flow—that is, in a flow which does not change with the time, in which then every new fluid particle, when it replaces another particle in front of it, assumes its velocity, both in magnitude and in direction and also the same pressure—there is, for the fluid particles lying on the same stream line, a very remarkable relation between the magnitude of the velocity, designated here by V , and the pressure, the so-called Bernoulli equation

$$p + \frac{\rho}{2} V^2 = \text{constant} \quad (1)$$

(ρ is the density of the fluid, i.e., the mass of a unit volume). This relation is at once applicable to the case of a body moving uniformly and in a straight line in a fluid at rest, for we are always at liberty to use for our discussions any reference system having a uniform motion in a straight line. If we make the velocity of the reference system coincide with that of the body, then the body is at rest with reference to it, and the flow around it is stationary. If now V is the velocity of the body relative to the stationary air, the latter will have in the new reference system the velocity V upon the body (a man on an airplane in flight makes observations in terms of such a reference system, and feels the motion of flight as "wind").

The flow of incident air is divided at a blunt body, as shown in figure 1. At the point A the flow comes completely to rest, and then is again set in motion in opposite directions, tangential to the surface of the body. We learn from equation (1) that at such a point, which we shall call a "rest-point," the pressure must be greater by $\frac{\rho}{2} V^2$ than in the undisturbed fluid. We shall call the magnitude of

this pressure, of which we shall make frequent use, the “dynamical pressure,” and shall designate it by q . An open end of a tube facing the stream produces a rest point of a similar kind, and there arises in the interior of the tube, as very careful experiments have shown, the exact dynamical pressure, so that this principle can be used for the measurement of the velocity, and is in fact much used. The dynamical pressure is also well suited to express the laws of air resistance. It is known that this resistance is proportional to the square of the velocity and to the density of the medium; but $q = \frac{\rho}{2} V^2$; so the law of air resistance may also be expressed by the formula

$$W = c \cdot F \cdot q \quad (2)$$

where F is the area of the surface and c is a pure number. With this mode of expression it appears very clearly that the force called the “drag” is equal to surface times pressure difference (the formula has the same form as the one for the piston force in a steam engine). This mode of stating the relation has been introduced in Germany and Austria and has proved useful. The air-resistance coefficients then become twice as large as the “absolute” coefficients previously used.

Since V^2 can not become less than zero, an increase of pressure greater than q can not, by equation (1), occur. For diminution of pressure, however, no definite limit can be set. In the case of flow past convex surfaces marked increases of velocity of flow occur and in connection with them diminutions of pressure which frequently amount to $3q$ and more.

5. A series of typical properties of motion of nonviscous fluids may be deduced in a useful manner from the following theorem, which is due to Lord Kelvin. Before the theorem itself is stated, two concepts must be defined. 1. The circulation: Consider the line integral of the velocity $\int V \cos(V, ds) \cdot ds$, which is formed exactly like the line integral of a force, which is called “the work of the force.” The amount of this line integral, taken over a path which returns on itself[,] is called the circulation of the flow. 2. The fluid line: By this is meant a line which is always formed of the same fluid particles, which therefore shares in the motion of the fluid. The theorem of Lord Kelvin is: In a nonviscous fluid the circulation along every fluid line remains unchanged as time goes on. But the following must be added:

1. The case may arise that a fluid line is intersected by a solid body moving in the fluid. If this occurs, the theorem ceases to apply. As an example I mention the case in which one pushes a flat plate into a fluid at rest, and then by means of the plate exerts a pressure on the fluid. By this a circulation

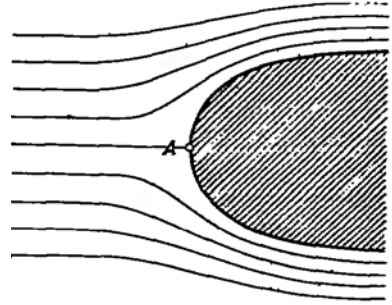

FIGURE 1. Flow around a blunt body.

arises which will remain if afterwards the plate is quickly withdrawn in its own plane. See figure 2.

2. In order that the theorem may apply, we must exclude mass forces of such a character that work is furnished by them along a path which returns on itself. Such forces do not ordinarily arise and need not be taken into account here, where we are concerned regularly only with gravity.

3. The fluid must be homogeneous, i.e., of the same density at all points. We can easily see that in the case of nonuniform density circulation can arise of itself in the course of time if we think of the natural ascent of heated air in the midst of cold air. The circulation increases continuously along a line which passes upward in the warm air and returns downward in the cold air.

Frequently the case arises that the fluid at the beginning is at rest or in absolutely uniform motion, so that the circulation for every imaginable closed line in the fluid is zero. Our theorem then says that for every closed line that can arise from one of the originally closed lines the circulation remains zero, in which we must make exception, as mentioned above, of those lines which are cut by bodies. If the line integral along every closed line is zero, the line integral for an open curve from a definite point O to an arbitrary point P is independent of the selection of the line along which the integral is taken (if this were not so, and if the integrals along two lines from O to P were different, it is evident that the line integral along the closed curve OPO would not be zero, which contradicts our premise). The line integral along the line OP depends, therefore, since we will consider once for all the point O as a fixed one, only on the coordinates of the point P , or, expressed differently, it is a function of these coordinates. From analogy with corresponding considerations in the case of fields of force, this line integral is called the "velocity potential," and the particular kind of motion in which such a potential exists is called a "potential motion." As follows immediately from the meaning of line integrals, the component of the velocity in a definite direction is the derivative of the potential in this direction. If the line-element is perpendicular to the resultant velocity, the increase of the potential equals zero, i.e., the surfaces of constant potential are everywhere normal to the velocity of flow. The velocity itself is called the gradient of the potential. The velocity components u , v , w are connected with the potential Φ by the following equations:

$$u = \frac{\partial \phi}{\partial x}, \quad v = \frac{\partial \phi}{\partial y}, \quad w = \frac{\partial \phi}{\partial z}, \quad (3)$$

The fact that the flow takes place without any change in volume is expressed by stating that as much flows out of every element of volume as flows in. This leads to the equation

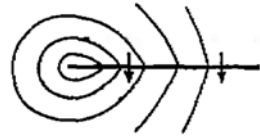

FIGURE 2. Production of circulation by introduction and withdrawal of flat plate.

$$\frac{\partial u}{\partial x} + \frac{\partial v}{\partial y} + \frac{\partial w}{\partial z} = 0 \tag{4}$$

In the case of potential flow we therefore have

$$\frac{\partial^2 \phi}{\partial x^2} + \frac{\partial^2 \phi}{\partial y^2} + \frac{\partial^2 \phi}{\partial z^2} = 0 \tag{4a}$$

as the condition for flow without change in volume. All functions $\Phi(x, y, z, t)$, which satisfy this last equation, represent possible forms of flow. This representation of a flow is specially convenient for calculations, since by it the entire flow is given by means of the one function Φ . The most valuable property of the representations is, though, that the sum of two, or of as many as one desires, functions Φ , each of which satisfies equation (4a), also satisfies this equation and therefore represents a possible type of flow ("superposition of flows").

6. Another concept can be derived from the circulation, which is convenient for many considerations, viz, that of rotation. The component of the rotation with reference to any axis is obtained if the circulation is taken around an elementary surface of unit area in a plane perpendicular to the axis. Expressed more exactly, such a rotation component is the ratio of the circulation around the edge of any such infinitesimal surface to the area of the surface. The total rotation is a vector and is obtained from the rotation components for three mutually perpendicular axes. In the case that the fluid rotates like a rigid body, the rotation thus defined comes out as twice the angular velocity of the rigid body. If we take a rectangular system of axes and consider the rotations with reference to the separate axes, we find that the rotation can also be expressed as the geometrical sum of the angular velocities with reference to the three axes.

The statement that in the case of a potential motion the circulation is zero for every closed fluid line can now be expressed by saying the rotation in it is always zero. The theorem that the circulation, if it is zero, remains zero under the conditions mentioned, can also now be expressed by saying that, if these conditions are satisfied in a fluid in which there is no rotation, rotation can never arise. An irrotational fluid motion, therefore, always remains irrotational. In this, however, the following exceptions are to be noted: If the fluid is divided owing to bodies being present in it, the theorem under consideration does not apply to the fluid layer in which the divided flow reunites, not only in the case of figure 2 but also in the case of

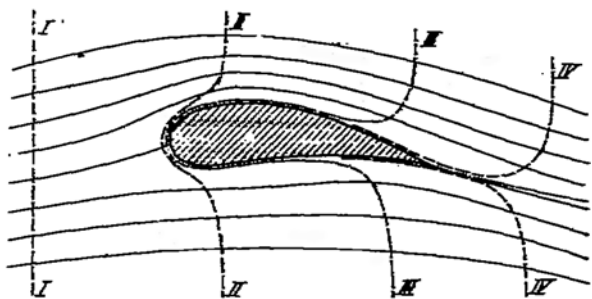

FIGURE 3. Successive positions of a fluid line in flow around a solid body.

stationary phenomena as in figure 3, since in this case a closed fluid line drawn in front of the body can not be transformed into a fluid line that intersects the region where the fluid streams come together. Figure 3 shows four successive shapes of such a fluid line. This region is, besides, filled with fluid particles which have come very close to the body. We are therefore led to the conclusion from the standpoint of a fluid with very small but not entirely vanishing viscosity that the appearance of vortices at the points of reunion of the flow in the rear of the body does not contradict the laws of hydrodynamics. The three components of the rotation ξ , η , ζ are expressed as follows by means of the velocity components u , v , w .

$$\xi = \frac{\partial w}{\partial y} - \frac{\partial v}{\partial z}, \quad \eta = \frac{\partial u}{\partial z} - \frac{\partial w}{\partial x}, \quad \zeta = \frac{\partial v}{\partial x} - \frac{\partial u}{\partial y} \quad (5)$$

If the velocity components are derived from a potential, as shown in equation (2), the rotation components, according to equation (5) vanish identically, since

$$\frac{\partial^2 \Phi}{\partial z \partial y} = \frac{\partial^2 \Phi}{\partial y \partial z}$$

7. Very remarkable theorems hold for the rotation, which were discovered by v. Helmholtz and stated in his famous work on vortex motions. Concerning the geometrical properties of the rotation the following must be said:

At all points of the fluid where rotation exists the direction of the resultant rotation axes can be indicated, and lines can also be drawn whose directions coincide everywhere with these axes, just as the stream lines are drawn so as to coincide with the directions of the velocity. These lines will be called, following Helmholtz, "vortex lines." The vortex lines through the points of a small closed curve form a tube called a "vortex tube." It is an immediate consequence of the geometrical idea of rotation as deduced above that through the entire extent of a vortex tube its strength—i.e., the circulation around the boundary of the tube—is constant. It is seen, in fact, that on geometrical grounds the space distribution of rotation quite independently of the special properties of the velocity field from which it is deduced is of the same nature as the space distribution of the velocities in an incompressible fluid. Consequently a vortex tube, just like a stream line in an incompressible fluid, can not end anywhere in the interior of the fluid; and the strength of the vortex, exactly like the quantity of fluid passing per second through the tube of stream lines, has at one and the same instant the same value throughout the vortex tube. If Lord Kelvin's theorem is now applied to the closed fluid line which forms the edge of a small element of the surface of a vortex tube, the circulation along it is zero, since the surface enclosed is parallel to the rotation axis at that point. Since the circulation can not change with the time, it follows that the element of surface at all later times will also be part of the surface of a vortex tube. If we picture the entire bounding surface of a vortex tube as made up of such elementary surfaces, it is evident that, since as the motion continues this relation remains unchanged, the

particles of the fluid which at any one time have formed the boundary of a vortex tube will continue to form its boundary. From the consideration of the circulation along a closed line enclosing the vortex tube, we see that this circulation—i.e., the strength of our vortex tube—has the same value at all times. Thus we have obtained the theorems of Helmholtz, which now can be expressed as follows, calling the contents of a vortex tube a “vortex filament”: “The particles of a fluid which at any instant belong to a vortex filament always remain in it; the strength of a vortex filament throughout its extent and for all time has the same value.” From this follows, among other things, that if a portion of the filament is stretched, say, to double its length, and thereby its cross section made one-half as great, then the rotation is doubled, because the strength of the vortex, the product of the rotation and the cross section, must remain the same. We arrive, therefore, at the result that the vector expressing the rotation is changed in magnitude and direction exactly as the distance between two neighboring particles on the axis of the filament is changed.

8. From the way the strengths of vortices have been defined it follows for a space filled with any arbitrary vortex filaments, as a consequence of a known theorem of Stokes, that the circulation around any closed line is equal to the algebraic sum of the vortex strengths of all the filaments which cross a surface having the closed line as its boundary. If this closed line is in any way continuously changed so that filaments are thereby cut, then evidently the circulation is changed, according to the extent of the strengths of the vortices which are cut. Conversely we may conclude from the circumstance that the circulation around a closed line (which naturally can not be a fluid line) is changed by a definite amount by a certain displacement, that by the displacement vortex strength of this amount will be cut, or expressed differently, that the surface passed over by the closed line in its displacement is traversed by vortex filaments whose strengths add up algebraically to the amount of the change in the circulation.

The theorems concerning vortex motion are specially important because in many cases it is easier to make a statement as to the shape of the vortex filaments than as to the shape of the stream lines, and because there is a mode of calculation by means of which the velocity at any point of the space may be determined from a knowledge of the distribution of the rotation. This formula, so important for us, must now be discussed. If Γ is the strength of a thin vortex filament and ds an element of its medial line, and if, further, r is the distance from the vortex element to a point P at which the velocity is to be calculated, finally if α is the angle between ds and r , then the amount of the velocity due to the vortex element is

$$dv = \frac{\Gamma ds \sin \alpha}{4 \pi r^2}; \quad (6)$$

the direction of this contribution to the velocity is perpendicular to the plane of ds and r . The total velocity at the point P is obtained if the contributions of all the vortex elements present in the space are added. The law for this calculation agrees

then exactly with that of Biot-Savart, by the help of which the magnetic field due to an electric current is calculated. Vortex filaments correspond in it to the electric currents, and the vector of the velocity to the vector of the magnetic field.

As an example we may take an infinitely long straight vortex filament. The contributions to the velocity at a point P are all in the same direction, and the total velocity can be determined by a simple integration of equation (6). Therefore this velocity is

$$v = \frac{\Gamma}{4\pi} \int_{-\infty}^{+\infty} \frac{ds \cdot \sin \alpha}{r^2}$$

As seen by figure 4, $s = h \operatorname{ctg} \alpha$, and by differentiation, $ds = -\frac{h}{\sin^2 \alpha} d\alpha$. Further $r = \frac{h}{\sin \alpha}$; so that

$$v = \frac{\Gamma}{4\pi h} \int_0^x \sin \alpha d\alpha = -\frac{\Gamma}{4\pi h} [\cos \alpha]_0^x = \frac{\Gamma}{2\pi h} \tag{6a}$$

This result could be deduced in a simpler manner from the concept of circulation if we were to use the theorem, already proved, that the circulation for any closed line coincides with the vortex strength of the filaments which are enclosed by it. The circulation for every closed line which goes once around a single filament must therefore coincide with its strength.

If the velocity at a point of a circle of radius h around our straight filament equals v then this circulation equals a "path times velocity" = $2\pi h \cdot v$, whence immediately follows $v = \frac{\Gamma}{2\pi h}$. The more exact

investigation of this velocity field shows that for every point outside the filament (and the formula applies only to such points) the rotation is zero, so that in fact we are treating the case of a velocity distribution in which only along the axis does rotation prevail, at all other points rotation is not present.

For a finite portion of a straight vortex filament the preceding calculation gives the value

$$v = \frac{\Gamma}{4\pi h} (\cos \alpha_1 - \cos \alpha_2) \tag{6b}$$

This formula may be applied only for a series of portions of vortices which together give an infinite or a closed line. The velocity field of a single portion of a filament would require rotation also outside the filament, in the sense that from the end of the portion of the filament vortex lines spread out in all the space and then all return together at the beginning of the portion. In the case of a line that has

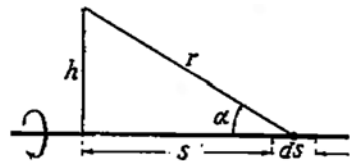

FIGURE 4. Velocity-field due to infinite rectilinear vortex.

no ends this external rotation is removed, since one end always coincides with the beginning of another portion of equal strength, and rotation is present only where it is predicated in the calculation.

9. If one wishes to represent the flow around solid bodies in a fluid, one can in many cases proceed by imagining the place of the solid bodies taken by the fluid, in the interior of which disturbances of flow (singularities) are introduced, by which the flow is so altered that the boundaries of the bodies become streamline surfaces. For such hypothetical constructions in the interior of the space actually occupied by the body, one can assume, for instance, any suitably selected vortices, which, however, since they are only imaginary, need not obey the laws of Helmholtz. As we shall see later, such imaginary vortices can be the seat of lifting forces. Sources and sinks also, i.e., points where fluid continuously appears, or disappears, offer a useful method for constructions of this kind. While vortex filaments can actually occur in the fluid, such sources and sinks may be assumed only in that part of the space which actually is occupied by the body, since they represent a phenomenon which can not be realized. A contradiction of the law of the conservation of matter is avoided, however, if there are assumed to be inside the body both sources and sinks, of equal strengths, so that the fluid produced by the sources is taken back again by the sinks.

The method of sources and sinks will be described in greater detail when certain practical problems are discussed; but at this point, to make the matter clearer, the distribution of velocities in the case of a source may be described. It is very simple, the flow takes place out from the source uniformly on all sides in the direction of the radii. Let us describe around the point source a concentric spherical surface, then, if the fluid output per second is Q , the velocity at the surface is

$$v = \frac{Q}{4 \pi r^2}; \quad (7)$$

the velocity therefore decreases inversely proportional to the square of the distance. The flow is a potential one, the potential comes out (as line-integral along the radius)

$$\Phi = \text{const.} - \frac{Q}{4 \pi r} \quad (7a)$$

If a uniform velocity toward the right of the whole fluid mass is superimposed on this velocity distribution—while the point source remains stationary—then a flow is obtained which, at a considerable distance from the source, is in straight lines from left to right. The fluid coming out of the source is therefore pressed toward the right (see fig. 5); it fills, at some distance from the source, a cylinder whose diameter may be determined easily. If V is the velocity of the uniform flow, the radius r of the cylinder is given by the condition $Q = \pi r^2 \cdot V$. All that is necessary now is to assume on the axis of the source further to the right a sink of the same strength as the source for the whole mass of fluid from the source to vanish in this, and the

flow closes up behind the sink again exactly as it opened out in front of the source. In this way we obtain the flow around an elongated body with blunt ends.

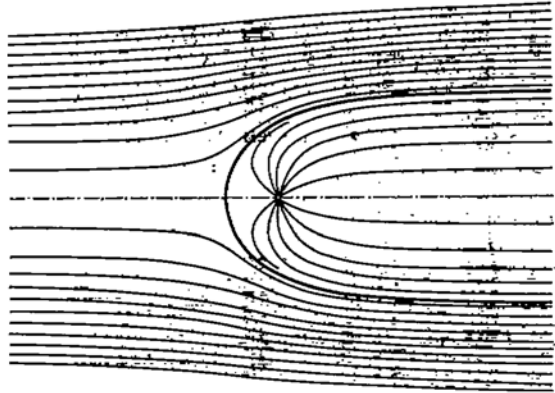

FIGURE 5. Superposition of uniform flow and that caused by a source.

10. The special case when in a fluid flow the phenomena in all planes which are parallel to a given plane coincide absolutely plays an important role both practically and theoretically. If the lines which connect the corresponding points of the different planes are perpendicular to the planes, and all the streamlines are plane curves which lie entirely in one of those planes, we speak of a uniplanar flow. The flow around a strut whose axis is perpendicular to the direction of the wind is an example of such a motion.

The mathematical treatment of plane potential flow of the ideal fluid has been worked out specially completely more than any other problem in hydrodynamics. This is due to the fact that with the help of the complex quantities $(x + iy, \text{ where } i = \sqrt{-1}, \text{ is called the imaginary unit})$ there can be deduced from every analytic function a case of flow of this type which is incompressible and irrotational. Every real function, $\Phi(x, y)$ and $\Psi(x, y)$, which satisfies the relation

The mathematical treatment of plane potential flow of the ideal fluid has been worked out specially completely more than any other problem in hydrodynamics. This is due to the fact that with the help of the complex quantities $(x + iy, \text{ where } i = \sqrt{-1}, \text{ is called the imaginary unit})$ there can be deduced from every analytic function a case of flow of this type which is incompressible and irrotational. Every real function, $\Phi(x, y)$ and $\Psi(x, y)$, which satisfies the relation

$$\Phi + i\Psi = f(x + iy), \tag{8}$$

where f is any analytic function, is the potential of such a flow. This can be seen from these considerations: Let $x + iy$ be put $= z$, where z is now a "complex number." Differentiate equation (8) first with reference to x and then with reference to y , thus giving

$$\begin{aligned} \frac{\partial\Phi}{\partial x} + i \frac{\partial\Psi}{\partial x} &= \frac{df}{dz} \frac{\partial z}{\partial x} = \frac{df}{dz} \\ \frac{\partial\Phi}{\partial y} + i \frac{\partial\Psi}{\partial y} &= \frac{df}{dz} \frac{\partial z}{\partial y} = i \frac{df}{dz} = i \frac{\partial\Phi}{\partial x} - \frac{\partial\Psi}{\partial y} \end{aligned}$$

In these the real parts on the two sides of the equations must be equal and the imaginary parts also. If Φ is selected as the potential, the velocity components u and v are given by

$$u = \frac{\partial\Phi}{\partial x} = \frac{\partial\Psi}{\partial y}; v = \frac{\partial\Phi}{\partial y} = -\frac{\partial\Psi}{\partial x} \tag{9}$$

If now we write the expressions $\frac{\partial u}{\partial x} + \frac{\partial v}{\partial y}$ (continuity) and $\frac{\partial v}{\partial x} - \frac{\partial u}{\partial y}$ (rotation)

first in terms of Φ and then of Ψ , they become

$$\left. \begin{aligned} \frac{\partial u}{\partial x} + \frac{\partial v}{\partial y} &= \frac{\partial^2 \Phi}{\partial x^2} + \frac{\partial^2 \Phi}{\partial y^2} = \underbrace{\frac{\partial^2 \Psi}{\partial y \partial x} - \frac{\partial^2 \Psi}{\partial x \partial y}}_{= 0} \\ \frac{\partial v}{\partial x} - \frac{\partial u}{\partial y} &= \frac{\partial^2 \Phi}{\partial y \partial x} - \frac{\partial^2 \Phi}{\partial x \partial y} = -\frac{\partial^2 \Psi}{\partial x^2} - \frac{\partial^2 \Psi}{\partial y^2} \\ &= 0 \end{aligned} \right\} \quad (10)$$

It is seen therefore that not only is the motion irrotational (as is self-evident since there is a potential), but it is also continuous. The relation $\frac{\partial^2 \Phi}{\partial x^2} + \frac{\partial^2 \Phi}{\partial y^2} = 0$ besides corresponds exactly to our equation (4a). Since it is satisfied also by Ψ , this can also be used as potential.

The function Ψ , however, has, with reference to the flow deduced by using Φ as potential, a special individual meaning. From equation (8) we can easily deduce that the lines $\Psi = \text{const.}$ are parallel to the velocity; therefore, in other words, they are streamlines. In fact if we put

$$d\Psi = \frac{\partial \Psi}{\partial x} dx + \frac{\partial \Psi}{\partial y} dy = 0, \text{ then } \frac{dy}{dx} = -\frac{\partial \Psi / \partial x}{\partial \Psi / \partial y} = \frac{v}{u}$$

which expresses the fact of parallelism. The lines $\Psi = \text{const.}$ are therefore perpendicular to the lines $\Phi = \text{const.}$ If we draw families of lines, $\Phi = \text{const.}$ and $\Psi = \text{const.}$ for values of Φ and Ψ which differ from each other by the same small amount, it follows from the easily derived equation $d\Phi + id\Psi = \frac{df}{dz} (dx + idy)$ that the two bundles form a square network; from which follows that the diagonal curves of the network again form an orthogonal and in fact a square network. This fact can be used practically in drawing such families of curves, because an error in the drawing can be recognized by the eye in the wrong shape of the network of diagonal curves and so can be improved. With a little practice fairly good accuracy may be obtained by simply using the eye. Naturally there are also mathematical methods for further improvement of such networks of curves. The function Ψ , which is called the "stream function," has another special meaning. If we consider two streamlines $\Psi = \Psi_1$ and $\Psi = \Psi_2$, the quantity of fluid which flows between the two streamlines in a unit of time in a region of uniplanar flow of thickness 1 equals $\Psi_2 - \Psi_1$. In fact if we consider the flow through a plane perpendicular to the X -axis, this quantity is

$$Q = \int_{y_1}^{y_2} u dy = \int_{y_1}^{y_2} \frac{\partial \Psi}{\partial y} dy = \int_{y_1}^{y_2} d\Psi = \Psi_2 - \Psi_1.$$

The numerical value of the stream function coincides therefore with the quantity of fluid which flows between the point x, y and the streamline $\Phi = 0$.

As an example let the function

$$\Phi + i\Psi = A(x + iy)^n$$

be discussed briefly. It is simplest in general to ask first about the streamline $\Psi = 0$. As is well known, if a transformation is made from rectangular coordinates to polar ones r, φ , $(x + iy)^n = r^n (\cos n\varphi + i \sin n\varphi)$. The imaginary part of this expression is $ir^n \sin n\varphi$. This is to be put equal to $i\Psi$. $\Psi = 0$ therefore gives $\sin n\varphi = 0$, i.e., $n\varphi = 0, \pi, 2\pi$, etc. The streamlines $\Psi = 0$ are therefore straight lines through the origin of coordinates, which make an angle $\alpha = \pi/n$ with each other, the flow is therefore the potential flow between two plane walls making the angle α with each other. The other streamlines satisfy the equation $r^n \sin n\varphi = \text{const}$. The velocities can be obtained by differentiation, e.g., with reference to z :

$$\frac{\partial\Phi}{\partial x} + i \frac{\partial\Psi}{\partial x} = u - iv = An(x + iy)^{n-1} = Anr^{n-1} \{ \cos (n-1)\varphi + i \sin (n-1)\varphi \}$$

For $r = 0$ this expression becomes zero or infinite, according as n is greater or less than 11, i.e., according as the angle α is less or greater than $\pi (= 180^\circ)$. Figures 6 and 7 give the streamlines for $\alpha = \pi/4 = 45^\circ$ and $3/2 \pi = 270^\circ$, corresponding to $n = 4$ and $2/3$. In the case of figure 7 the velocity, as just explained, becomes infinite at the corner. It would be expected that in the case of the actual flow some effect due to friction would enter. In fact there are observed at such corners, at the beginning of the motion, great velocities, and immediately thereafter the formation of vortices, by which the motion is so changed that the velocity at the corner becomes finite.

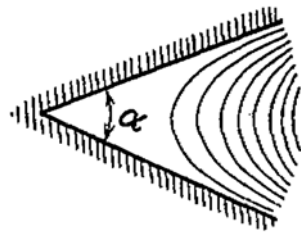

FIGURE 6. Uniplanar flow between plane walls making an angle $\alpha = 45^\circ$ with each other.

It must also be noted that with an equation

$$p + iq = \phi(x + iy) \tag{11}$$

the x - y plane can be mapped upon the p - q plane, since to every pair of values x, y a pair of values p, q corresponds, to every point of the x - y plane corresponds a point of the p - q plane, and therefore also to every element of a line or to every curve in the former plane a linear element and a curve in the latter plane. The transformation keeps all angles unchanged, i.e., corresponding lines intersect in both figures at the same angle.

By inverting the function ϕ of equation (11) we can write

$$x + iy = \chi(p + iq)$$

and therefore deduce from equation (8) that

$$\Phi + i\Psi = f[\chi(p + iq)] = F(p + iq) \tag{12}$$

Φ and Ψ are connected therefore with p and q by an equation of the type of equation (8), and hence, in the p - q plane, are potential and stream functions of a flow, and further of that flow which arises from the transformation of the Φ , Ψ network in the x - y plane into the p - q plane.

This is a powerful method used to obtain by transformation from a known simple flow new types of flow for other given boundaries. Applications of this will be given in section 14.

11. The discussion of the principles of the hydrodynamics of nonviscous fluids to be applied by us may be stopped here. I add but one consideration, which has reference to a very useful theorem for obtaining the forces in fluid motion, namely the so-called “momentum theorem for stationary motions.”

We have to apply to fluid motion the theorem of general mechanics, which states that the rate of change with the time of the linear momentum is equal to the resultant of all the external forces. To do this, consider a definite portion of the fluid separated from the rest of the fluid by a closed surface. This surface may, in accordance with the spirit of the theorem, be considered as a “fluid surface,” i.e., made up always of the same fluid particles. We must now state in a formula the change of the momentum of the fluid within the surface. If, as we shall assume, the flow is stationary, then after a time dt every fluid particle in the interior will be replaced by another, which has the same velocity as had the former. On the boundary, however, owing to its displacement, mass will pass out at the side where the fluid is approaching, and a corresponding mass will enter on the side away from which the flow takes place. If dS is the area of an element of surface, and v_n the component of the velocity in the direction of the outward drawn normal at this element, then at this point $dm = \rho dS \cdot v_n \cdot dt$. If we wish to derive the component of the “impulse”—defined as the time rate of the change of momentum—for any direction s , the contribution to it of the element of surface is

$$dJ_s = v_s \frac{dm}{dt} = \rho dS \cdot v_n v_s \tag{13}$$

With this formula we have made the transition from the fluid surface to a corresponding solid “control surface.”

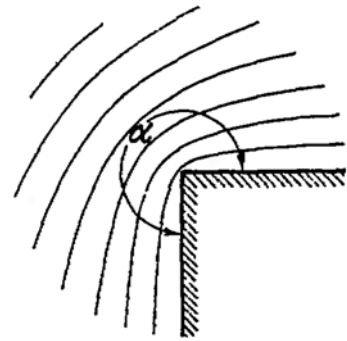

FIGURE 7. Uniplanar flow around plane walls making an angle 270° with each other.

The external forces are compounded of the fluid pressures on the control surface and the forces which are exercised on the fluid by any solid bodies which may be inside of the control surface. If we call the latter P , we obtain the equation

$$\Sigma P_s = \iint p \cdot \cos(n, s) \cdot dS + \rho \iint v_n v_s dS \quad (14)$$

for the s component of the momentum theorem. The surface integrals are to be taken over the entire closed control surface. The impulse integral can be limited to the exit side, if for every velocity v_s on that side the velocity v'_s is known with which the same particle arrives at the approach side. Then in equation (13) dJ is to be replaced by

$$dJ - dJ' = (v_s - v'_s) \frac{dm}{dt} = \rho dS v_n (v_s - v'_s) \quad (13a)$$

The applications given in Part II will furnish illustrations of the theorem.

Document 5-18 (a–h)

Selections from Grover Loening, *Our Wings Grow Faster* (Garden City, NY: Doubleday, Doran & Co., Inc., 1935).

- (a) “The N.C.’s,” p. 103.
- (b) “The Flying Yacht,” pp. 112–113.
- (c) “A Goal Achieved,” p. 114.
- (d) “New York to Newport,” pp. 119–122.
- (e) “The Crisis,” pp. 123–126.
- (f) “Cutting too Close,” pp. 130–131.
- (g) “Off to a Good Start,” pp. 137–138.
- (h) “Orders and Orders,” pp. 139–140.

As stated back in Document 5-15, Grover C. Loening is one of the most important figures in the history of flying boats. After graduation from Columbia University with the country’s first-ever master’s degree in aeronautics, 22-year-old Loening joined the Queen Aeroplane Company as chief engineer. For this small New York-based outfit, he built Blériot airplanes (mostly for exhibition pilots) and also constructed the first flying boat of his own design. Having met Wilbur Wright in 1909, Loening became a good friend of the Wrights; in 1913–14, Orville (Wilbur had died on 30 May 1912 from typhoid fever) chose Loening to design the first Wright flying boat, the Model G, an ineffective machine due largely to the fact that Orville would not allow Loening to imitate his arch-rival Glenn Curtiss’s flying boats in any way. In 1915, Loening published a second book, entitled *Military Aeroplanes*, which was officially used by the U.S. Army and U.S. Navy, the Royal Air Force, and the Canadian Armed Forces, among others. Also in 1915, he became vice president of the Sturdevant Aeroplane Company, for which he pioneered the first American steel-framed airplane. In 1917, he formed the Loening Aeronautical Engineering Corporation. Its first job was to produce a small plane for the Navy that could be launched from ships. In the same year, he started on an Army contract for a two-seat pursuit monoplane, the M-8. This machine used a novel form of rigid wing strut brace patented by Loening.

Though his first attempts at flying boat design had resulted in rather inferior machines, Loening eventually came up with some very successful and highly

innovative flying boat designs. As readers will see in the autobiographical selections below, in 1921, he won the Collier Trophy for his Flying Yacht, a five-seat monoplane boat that established a few world records and opened the first significant market for private-owner seaplanes. Three years later, in 1924, his OA-1C Amphibian became very popular. Not only could it operate from both land and water, a much-desired capability in an age of few airports, but the vehicle also performed extremely well aerodynamically in comparison to less versatile landplanes of the era. One reason for this was that it employed the first practical retractable undercarriage. Among those who used the Amphibian were the U.S. Army, Navy, Marines, and Coast Guard, along with airlines and private owners throughout the world. The army's famous Pan American Goodwill Flight of 1926 took place with this aircraft. It was also in 1926 when three Loening amphibians operating from the U.S.S. Gannet made aerial maps of Alaska as part of the Navy Alaskan Survey Expedition.

In 1928, Loening's company merged with the Curtiss-Wright Corporation. He subsequently created the Grover Loening Aircraft Company, a firm that built several research aircraft and consulted for other companies. During World War II, he served as a chief consultant to the War Production Board. Over the years for the National Advisory Committee for Aeronautics, he chaired two important subcommittees: on Seaplanes (1946–52) and on Helicopters (1943–48). Loening died in 1976 at age 88.

Document 5-18 (a), "The N.C.'s," selection from Grover Loening, Our Wings Grow Faster (Garden City, NY: Doubleday, Doran & Co., Inc., 1935), p. 103.

Commander H. C. Richardson had asked me if I cared to fly in the N.C. 3 at Rockaway in an endurance test just prior to its take-off for Europe on May 16, 1919.

I assented gleefully, little knowing what I was in for.

We took off fine, all four Libertys working smoothly and making a terrific racket. I was in the hull with three of the crew and soon learned that in the hull I was going to stay for ten solid hours, with no lunch, which was bad enough, but with nothing but a coil of rope to sit on, which was worse.

At any rate, Big Dick, as we called him, convinced me of one thing, that the endurance of the crew was a far more difficult thing to test than was the endurance of the plane.

It got so tedious and monotonous at one point—I was able to see very little outside, and no instruments within, and there were little drafts crawling through every notch—that I became seriously air sick for the first and last time in my life.

Finally we landed, and of course "I liked it a lot."

Like hell I did!

*Document 5-18 (b), "The Flying Yacht," selection from
Grover Loening, Our Wings Grow Faster (Garden City, NY:
Doubleday, Doran & Co., Inc., 1935), pp. 112–113.*

It was August 19, 1921.

We were up about 10,000 feet and climbing strong—David H. McCulloch pilot, Ladislas d'Orcy, of the Aero Club, my assistant, LeRoy Grumman, and myself.

"Dave," I yelled, "we have an official barograph and observer on board. Let's make an altitude record out of this."

So Dave pointed her up, and at 18,500 feet we began to realize that, while we might have broken Caleb Bragg's record of two years before, it was getting pretty cold for a crew that had gone up in their shirtsleeves.

At 20,000 feet we had had enough, and down we came.

The new Loening Flying Yacht, the fastest flying boat in the world, had established a new passenger-carrying world's altitude record.

Equipped with a 400 h.p. Ford Liberty engine, this new five-seat monoplane Flying Yacht was the most recent pride of our production. We had built it on speculation in order to get a market that would succeed the market for the monoplanes, which we knew would be rapidly getting out of date.

All that summer McCulloch, popular ex-commander in the navy, who had latterly become our agent for the domestic commercial sales of this plane, flew around, with me along, making demonstrations. Clifford Webster, the famous flying-boat pilot, also flew the plane a lot. We went to the New London crew races, to Southampton, Newport, to the army maneuvers at Aberdeen, Maryland, and in fact all over the eastern part of the country.

In the fall there was a contest held by the Aero Club for the Wright Efficiency Trophy, and Dave and I set out to demonstrate this remarkable plane's paces.

The idea of the contest was to show how much a plane could earn per day by carrying passengers.

So we set about doing it.

The first day we made three complete round-trip flights between New London and New York (Port Washington terminus).

The second day we made four complete round trips between Southampton, Long Island, and New York.

The New London trips, 100 miles' distance, were averaged in 55 minutes each.

The Southampton trips, 78 miles' distance, averaged 41 minutes each.

We could have carried 56 different passengers on trips those two days.

It was a striking and convincing demonstration, and the people along the route who saw us going and coming again and again thought we would never stop.

We won the Wright trophy.

*Document 5-18 (c), “A Goal Achieved,” selection from
Grover Loening, Our Wings Grow Faster (Garden City, NY:
Doubleday, Doran & Co., Inc., 1935), p. 114.*

“Awarded for the year 1921, to Grover C. Loening, for the most meritorious development successfully proven during the year, in the design, development, and demonstration of the Loening Flying Yacht.”

So the inscription read, and the Collier Trophy was ours.

At its presentation I got a real thrill: a long-standing ambition had been satisfied. Our Flying Yacht business grew apace. Dave sold quite a few of the Flying Yachts for commercial purposes, notably to Vincent Astor, Harold S. Vanderbilt, and Ross Judson, of Detroit.

In addition, the army, finding in this fast boat a useful adjunct to their cost-defense stations, bought a large quantity, and for two or three years this product of our factory was the most popular.

On November 7, 1924, Lieutenants Victor Bertrandias and George MacDonald, with one of the army’s Loening Flying Yachts, established at Langley Field, Virginia, a new world’s seaplane speed record of just under 103 miles an hour for 1,000 kilometers distance. The maximum high speed of this plane was 130 m.p.h.

This was not its greatest flight, because in the spring of 1923 Clifford Webster with Fred Golder had flown one of these planes from Palm Beach to New York, 1,200 miles in nine hours, a wonderful trip that received well-deserved acclaim. And eleven years later when the nine-hour trips of the Douglas airliner[s] from Miami to New York receive such acclaim, let us not forget this historic and significant flight.

*Document 5-18 (d), “New York to Newport,” selection from
Grover Loening, Our Wings Grow Faster (Garden City, NY:
Doubleday, Doran & Co., Inc., 1935), pp. 119–122.*

The Air-Yacht business was tapering off pretty seriously in 1923, and owing to troubles with our other designs we had nothing to replace it, and here we had our swell factory facing a shortage of work, even though we had some reserve funds.

The flying of Vincent Astor and “Mike” Vanderbilt in our planes had been very successful, so that when a group of Newport residents, headed by the enterprising and far-sighted T. Suffern Tailer, broached the idea of running an airline to Newport, I thought it would be a wonderful outlet for our product and an excellent development to take up—but independently of the factory.

So in due course Vincent Astor was interested and the New York–Newport Air Service Company was organized, with me as president and manager.

There had always been a great deal of interest in such an airline, and in this case it had a wonderful chance. It still had.

Two things about our old air service are not generally known:

One is that I myself put in quite a lot of cash, although Astor put in more.

The other is that Astor did not stop the airline's operations. The responsibility for that is entirely mine.

Here is the story:

We opened on June 27, 1923, with three air yachts, a hangar and a float at 31st Street in New York, and a landing stage at Newport loaned by the navy. The publicity was always plentiful. The subscribing residents whose advance ticket purchase acted like an additional subsidy had all paid up in full.

America's first fixed-schedule airline started with a blaze of glory, including the usual gestures of breaking a record on the first flight and, of course, a letter from the mayor of New York, Mr. Hylan, delivered by me to the mayor of Newport, the popular and genial Mr. Mortimer Sullivan.

Upon our arrival at Newport we were greeted by a band and a large crowd, and there were speech-making and newspaper photographs and the usual formal lunch.

Then for many weeks we ran a serious air service. I saw no flaw. We had excellent motors, knew the planes thoroughly, the planes were in perfect condition, and we had pilots who had had a splendid record. There was no reason that we could think of for this line not running without trouble. But we didn't think enough, in the light of what happened.

One day, July 20th, the "Fleetwing" on a regular trip was arriving at Newport. I was at the station there with several friends and onlookers. The plane came in sight exactly on schedule, piloted by Lieutenant Thorburn, and carrying, as we had been advised from New York, two passengers, Harold Fowler and H. Cary Morgan. When the plane was coming in, I ruminated on its punctuality and on the fact that perhaps we were putting it over pretty successfully.

Then, as Thorburn was about to land, I sensed something wrong in his gliding approach and was horrified when I saw that he never leveled off at all but just went right on into the water. I remembered exactly every detail of the approach, and it was fixed in my mind then that the elevators were stuck! That's the way the plane acted.

The resulting crash caused a big splash, and then came that sickening moment when the plane disappeared, and presently we saw a floating mass of wreckage and two or three bobbing heads.

Every craft available rushed to the rescue. Harold had dived for both Thorburn, who was stunned, and Morgan, who was obviously injured, and they all clung to the wreckage until pulled out—and, of course, it seemed an endless time till a navy boat got there.

Harold Fowler was entirely uninjured. So was Thorburn. But Cary Morgan had a badly fractured left leg. He died four days later.

We fished out the wreckage, and that night I inspected every detail to try and find a cause. I could find nothing.

On questioning Thorburn, he could remember nothing—only that he intended leveling off; but, as happens in many cases of shock, he remembered merely that something was wrong.

I was at my wit's end and under terrific strain. If I had known what had caused the accident it would have been much easier. I puzzled, worked over it, questioned Thorburn again, witnesses, Fowler, and yet learned nothing that seemed to be of any importance. I did learn that Cary Morgan had been slouched down asleep in the plane. He was just taking a nap—and he always slouched and stretched out his legs as a habit, anyway.

Still looking for a solution, I realized that the temporary shutdown of the line called for action one way or another.

I went to Astor and told him that, as I was unable to solve the mystery of the accident, I would not resume the airline service until we knew why the accident had happened. He expressed the thought that it was unlikely to happen again and that the planes had flown a lot and proven to be all right; and he was entirely ready to resume the service.

But I insisted—and I think I was right—that until we knew the cause of that accident, we should carry no more passengers.

And it was so announced.

One day, months later, I was sitting in an air yacht in the shop and happened to think of Cary Morgan as I had seen him in the hospital, and of the places where his leg had been fractured.

I stretched out in the seat behind the pilot and found that the cross tubes of that seat corresponded exactly to the places where Cary Morgan's leg had been fractured. So, obviously, when he was thrown forward his leg had caught in the framing there, even though there was ample room to slide out. I called a mechanic in the ship to sit in the pilot's seat. And then I had an idea and asked him to pull back the elevator control while I had my feet and legs in that stretched-out position.

And my foot got caught in the control, and the stick could not be pulled back!

Here was the solution:

Thorburn had pulled the stick to level out and couldn't.

Because Cary Morgan's foot was caught fast!

Many years of further study convinced me this is the only explanation. If Morgan had sat upright, the accident would never have happened, and if I had doped this solution out at the time, instead of much later, the New York–Newport Air Service would probably still be running.

*Document 5-18 (e), "The Crisis," selection from
Grover Loening, Our Wings Grow Faster (Garden City, NY:
Doubleday, Doran & Co., Inc., 1935), pp. 123–126.*

Things seemed to get steadily worse after this crash. Our monoplanes had become pretty unpopular. Several fast seaplanes, notably Vought's, were getting all the navy business. Our reserve funds were being dug into. I ceased drawing any salary, and it was becoming increasingly clear that the Loening Aeronautical Engineering Corporation was fast getting near the rocks.

I retired for a week in the country to get away from the strain and to think it all out. Apparently I am more sensitive than it seems, for the Newport accident hit me pretty hard, and I also felt the responsibility of not having had enough wisdom to provide the work that the shop needed to keep my loyal men, with the families dependent on them, at work and being paid for it.

Earlier that year I had made a very instructive tour of Europe and was quite up to date on aviation over there. So I reviewed the possibilities of every kind of ship and finally came to this conclusion:

That is we could build an amphibious plane that looked like a land plane, and felt like it in the air, and had the motor in front, we could sell it to such a large field that it would last for more years than our other designs, and also that there was no destructive competition in this field and lots of interest in Washington. Furthermore our flying-boat experience could all be used. But we had to have a radical change in appearance!

Looking over the field, the two popular planes of the day were the Vought and the final, modified, highly developed D.H.4B. The Vought was too small for an amphibian. Why not get out a nautical D.H., about the same size—perhaps even use the same wing arrangement, but with a new wing section and advanced, refined details of construction? The wings of the new design might even be used on D.H.'s and, more important still, when the flying pilots sat looking at those wings with the same angle and gap and stagger, they would feel familiarly at ease in the air. Thus the pilot would be fooled and the strangeness of a new amphibian would be greatly moderated. And one more point: the army having just succeeded in running a Liberty in the inverted position where the propeller axis was high, where it ought to be anyhow (it would have been there years ago if we hadn't had so many automobile people unconsciously thinking of placing the crankshaft low so as to get road clearance for a car), why not use this engine and build the whole body as a unit (patent-able) and thus have a ship just like a tractor land plane, only with the body of a hull into which the landing gear folds?

That's how the Loening amphibian was born.

THE WORLD FLIGHT

We tried to get our work on the amphibian speeded up enough to get the army to consider our plane for the round-the-world flight. But by early 1924 we saw the case was hopeless, as they wanted to, and did, leave in April of that year. Our plane would have been ideal for just such a trip and, in fact, would have saved a great deal of time, which the Douglas seaplanes lost in being changed from seaplanes to land planes and vice versa. The Douglas world cruisers were much slower, but they were excellent planes, as was evidenced by their successful mission.

We watched this epic with especial interest, as we felt that it was just the dish for the amphibians and we had missed our timing badly in not even being ready for a try at it.

*Document 5-18 (f), “Cutting Too Close,” selection from
Grover Loening, Our Wings Grow Faster (Garden City, NY:
Doubleday, Doran & Co., Inc., 1935), pp. 130–131.*

Then another great tragedy happened that was, if anything, harder to bear than the others.

Brookley and I were taking this amphibian through our last remaining tests, measuring speeds on the course we all use out on Long Island South between Stepping Stone and Execution lighthouse. He wanted to get the maximum speed and also liked as a stunt to fly absolutely close to the water. I was busy with my stop watch but realized we were pretty close. Suddenly we hit probably a wave, maybe a log, and the effect was just like that of a great, powerful brake. We slowed to almost an instantaneous stop, sinking in as we did so, and then, as we both jumped, the plane turned over.

The entire front bottom had been ripped off by the suction of the water hitting it at such a high speed—an accident that has often happened before and continues to happen again and again to the most expert pilots, who just get one inch too “fresh” with the water at high speed.

We swam around and clung, entirely unhurt, to the wreckage, until a fishing boat came and rescued us, towed the plane to shallow water, and tied a buoy to the plane so that we could find it, as it was sinking fast.

My assistants, Roy Grumman, John Laustra, Julie Holpit, and Harry Larson, worked away into the night, delicately salvaging the wreck in so competent a way that there was a great deal of it left intact and almost usable.

I felt pretty sick, and Brookley felt bad, too, but chiefly because of the hard luck it was for us. The plane had not yet been accepted, and the Engineering Division had not even seen it. And there weren't any more inverted Libertys immediately available.

Things looked pretty black—and all the more so because of what a swell airplane it had been.

And we had entirely run out of money.

*Document 5-18 (g), "Off to a Good Start," selection from
Grover Loening, Our Wings Grow Faster (Garden City, NY:
Doubleday, Doran & Co., Inc., 1935), pp. 137-138.*

The first amphibian of the order for ten was ready for delivery in January, 1925, and Brookley was sent by the army to test it.

Many improvements over the first plane had been incorporated in this latest one, but, bearing in mind our disastrous experience with the first plane, and the fact that the construction of the other nine on the order, for which we had many parts made, depended on the success of this new one, I was pretty much worried and apprehensive.

If this one cracked up, we would be entirely through. I knew the army would then cancel the order, and, having risked so much money in advanced construction of the remaining planes, we would have been broke for fair.

To add to our concern, it was midwinter, with terrible weather and ice in the river, and there was so much ice in all near-by bays that the river was the only place in which we could make the test. In addition, the fields all over the East were in impossible shape, full of ruts, ice, and holes.

A further cause for worry was the possibility that water would so freeze on the landing gear after the take-off as to jam the gear when it was raised or lowered. So we literally poured an anti-freeze grease on everything.

Fate was kind to us.

Brookley and I started off. No ice hit the hull, nothing froze, we found a reasonably good runway at Mitchel Field for landings on our acceptance trials, and in a quick day or so the plane was through with every test and off to Washington in bitter cold weather, to land at Bolling Field amid considerable acclaim, including that of the Congressional investigating committee before whom I had testified so tartly.

From then on it was easy sailing, and we had gotten off with lots of good luck to a swell start.

*Document 5-18 (h), "Orders and Orders," selection from
Grover Loening, Our Wings Grow Faster (Garden City, NY:
Doubleday, Doran & Co., Inc., 1935), pp. 139-140.*

The orders came in so rapidly through the ensuing years that at times we thought we were dreaming: twenty from the navy, twenty-seven from the army, three from the Coast Guard, twelve from the Marines, twenty-seven more from the navy, nineteen more from the army—and so it went. And in due course we went into the commercial field, with my old friend Beckwith Havens as sales manager, and started to pick up still more business. The reason was simple: Our amphibian was a good land plane. It was a good seaplane. And it lost nothing in being the combination of both.

Under the able management of my brother, Albert, Roy Grumman, and Harry Larson, amphibians fairly poured out of our well-equipped, efficient plant on East 31st Street, New York City. And meanwhile my eldest brother Rudolph steered us straight and true through all legal matters.

Probably no airplane in the history of the art has had so many different uses. Loening amphibians covered the following diversified fields:

They were used by the army:

- For coastal and insular artillery control;
- For cross-country flying by the high command;
- For rescue purposes;
- For surveying purposes;
- For the Pan-American Good Will Flight;
- For carrying Lindbergh on his official arrival in New York.

They were used by the navy:

- For surveying Alaska, the Caribbean, Venezuela, etc.;
- For the Byrd Arctic Expedition;
- For high-command staff work;
- For cross-country flying;
- For battleship spotting, launched by catapult;
- For deck landing carriers.

They were used by the Marine Corps in China, Nicaragua, and Haiti.

They were used by the Coast Guard for anti-rum-running and life-saving work.

They were used by airlines: Gorst (Seattle), Kohler (Lake Michigan), Thomson (Lake Erie), San Francisco Air Ferry, China National Airways, Pan-American Airways.

They were used by such individuals as Howard Borden, Marshall Field, Richard F. Hoyt, Donald Woodward, Townsend Ludington, Bernarr Macfadden, *et al.*

Document 5-19 (a–c)

- (a) Henry S. Conklin, Associate Aeronautical Engineer, Naval Aircraft Factory, “Development of Navy Patrol Planes,” *Aero Digest* 6 (May 1925): 242–244, 288.
- (b) Commander W. W. Webster (CC), U.S.N., “The Navy PN-12 Seaplane,” *Aviation* 24 (14 May 1928): 1366, 1404.
- (c) Rear Admiral W. A. Moffett, U.S.N., Chief of the Bureau of Aeronautics, to Chief of Naval Operations, “Fleet Patrol Plane,” 17 August 1932, File VP (Air Cruiser), Box 1541, BuAer [Bureau of Aeronautics] Confidential Correspondence, 1922–1944, Record Group 72, National Archives, Washington, DC.

At the end of World War I, the United States Armed Forces’ entire air armada numbered 10,420 machines. Of these, 8,403 belonged to the Army Air Service (of these, 4,865 were based in the United States) and 2,017 belonged to the U.S. Navy. Of the Navy airplanes, over half (1,172) were flying boats. In other words, flying boats made up over 58 percent of all naval aircraft and over 11 percent of all U.S. combat aircraft. With these seaplanes, the Navy patrolled a total of over three million air miles. Along the way, they attacked 25 German U-boats and sank 12 of them.

In the years after the war, this naval force quickly dissipated, as did the power of the U.S. military establishment generally. By 1925, only 117 flying boats could be counted, mostly obsolete designs from the war such as H-16, HS-2L, and F-5L, all built by Curtiss. The one organization that worked energetically through this period of military retrenchment to advance the design of flying boats and other types of naval aircraft was the Naval Aircraft Factory in Philadelphia. (For a history of the Naval Aircraft Factory, see William F. Trimble, *Wings for the Navy: A History of the Naval Aircraft Factory, 1917–1956* (Annapolis, MD: Naval Institute Press, 1990.) From its establishment in 1916, the Naval Aircraft Factory worked with particular effort to refine the flying boat.

This string of documents provides historical insights into the Navy’s quest for a much-improved aerial patrol boat. The first document, an *Aero Digest* article from 1925, concerns a prototype flying boat developed at the Naval Aircraft Factory known as the PN-9. What it represented was the Navy’s desire to move toward an all-metal hull, something with which Naval Aircraft Factory engineers began

experimenting in 1921. The PN-9 essentially grew out of the PN-5, but with a hull made from aluminum alloy rather than wood (and with new Packard engines). If the author of the first document, Naval Aircraft Factory engineer Henry S. Conklin, had waited a few more months to write his article, he could have given it much more drama. On 31 August 1925, Commander John Rodgers and a crew of five took off in the PN-9 biplane from San Francisco, hoping to set a record by flying nonstop to Hawaii. Unfortunately, the aircraft used considerably more fuel than planned, a situation made worse by the lack of anticipated tail winds. The flying boat went down at sea. Ingeniously, Rodgers and his crew fashioned crude sails from fabric they tore from the lower wings. They then literally sailed the boat a distance of 450 miles to the island of Kauai. (If it had not been so hard to steer the “boat,” they could have made it to Maui instead, which was considerably closer.) As one student of this remarkable adventure has noted, “Whatever may have been lacking in flight planning or in understanding of engine performance, the seaworthiness of the new all-metal hull and the seamanship of the crew were clearly demonstrated” (Loftin, *Quest for Performance*, p. 180).

The second document below concerns the Navy’s PN-12, dates from 1928, and was also authored by an engineer working at the Naval Aircraft Factory in Philadelphia. The PN-12 was a much better design and, unlike the PN-9, actually went into production—with several manufacturers, including Martin (models designated “PM”), Douglas (“PD”), Keystone (“PK”), and Hall Aluminum (“PH”). The PN-12 models built by these manufacturers all differed in a number of details, but they served the Navy’s purposes much better than any previous flying boat. As the May 1928 article from *Aviation* magazine emphasized, the PN-12 design featured not only some powerful new air-cooled engines but also some much-improved aerodynamics. Unlike the Navy’s earlier flying boats, it had fewer drag-producing interplane struts and wires, plus the messy arrangement that had been used to brace the wingtips had been eliminated. Moreover, thanks to some streamlined cowlings, the new engines produced less drag as well. The result was an aerodynamically cleaner flying boat that was capable of flying nearly 30 miles per hour faster than the Curtiss F-5L it was designed to replace, reaching 119 mph instead of just 90 mph. The Navy flew boats based on the PN-12 design, such as the Martin PM-1, well into the 1930s. The U.S. Coast Guard did as well, ordering PH-3s (produced by Hall Aluminum) as late as 1938. In 1935, the one-of-a-kind experimental XP2H-1, the largest flying boat ever developed for the U.S. Navy, made a nonstop flight from Norfolk, Virginia, to the isthmus of Panama. Later that same year, the XP2H-1 sank in the Atlantic while trying to land in open sea.

The final document concerns the origins of the Navy’s PBY flying boats; it is an August 1932 memo from Rear Admiral William A. Moffett, chief of the Bureau of Aeronautics, to the chief of naval operations concerning the proposed design of a long-range battle fleet patrol plane known early on as the “Air Cruiser.” What this memo eventually led to was the development of the most successful patrol boat

ever built, the Consolidated PBY Catalina of 1935. Its configuration would also be one of the most innovative, barely resembling that of earlier flying boats. It had a semicantilever monoplane wing and was made almost entirely from metal (except for the trailing edge of the wing and the control surfaces, which were covered with fabric). Its two engines were mounted neatly into the leading edge of that wing on streamlined pylons. The form of the hull was hydrodynamically quite refined. Perhaps most interesting were its floats, which could be retracted to form part of the wingtip when not extended for lateral stability during taxiing, takeoff, and landing. Aerodynamically, the entire PBY family enjoyed unusually clean performance for a flying boat. With a maximum lift-drag ratio of 11.9 and zero-lift drag coefficient of 0.0309, the PBY-5A Catalina of the World War II era, if pushed, could reach a maximum speed of 179 mph. Compared to 8.6 and 0.0694, respectively, for the Curtiss F-5L flying boat of the World War I era, this represented a huge improvement, the result of a synergy of a number of major technological improvements in airplane design during the 1920s and 1930s.

The various PBY aircraft (including the four-engine PB2Y Coronado, another effective design but one that was tremendously more expensive and without nearly as clear an operational mission) saw extensive action in World War II, as they were used not just by U.S. forces but by British, Canadian, French, Australian, and Dutch forces as well. A number of countries, including the Soviet Union, built Catalinas under license. Not only did the Catalina serve in patrol operations and with a maximum range of over 2,500 miles, but it was also effective in actual combat. Depending on how it was loaded, it dropped a 2,000-pound load of bombs, expelled two torpedoes, or splashed down four 325-pound depth charges. Assorted other information on the PBY and other World War II-era flying boats will be presented in subsequent documents in this chapter.

Document 5-19 (a), Henry S. Conklin, Associate Aeronautical Engineer, Naval Aircraft Factory, "Development of Navy Patrol Planes," Aero Digest 6 (May 1925): 242-244, 288.

The development of the PN-9 began with the desire of the Bureau of Aeronautics to give to the Service a heavy duty patrol plane with improved performance over that of the H-16 and F-5-L types used during the late war. These latter mentioned planes are designed for a complement of four men, but the Service more frequently requires five or even six. Equipped with Liberty engines, these planes are greatly overtaxed. The principal difficulties are in taking off and maintaining altitude during flight. The maximum speed of the F-5-L is less than 90 miles per hour.

The Naval Aircraft Factory was selected in 1923 as being best fitted to design and construct the PN-7 plane around the F-5-L hull and tail. The first important changes considered were the provision of high lift wings and the increase of about 200 H.P. The wing section is changed from the RAF 6 to the USA 27; the chord

from 8 to 9 ft.; and the aspect ratio from 12 plus to 8. The interplane struts are reduced from 7 sets of front and rear to 2 sets on PN-7 exclusive of the engine mountings. Wooden tapered struts are retained for the outer interplane struts and alloy steel struts used for the engine supports. The high tensile value of spruce as compared with the low compressive value was recognized in the development of the beam sections. Beams are tapered towards the ends so that all possible weight may be saved in beams and fittings. The sides of the beam are planked with two layers of spruce, running in opposite directions to each other, and at 45 deg. to the center line of the beam. The rib is a built up truss. Mahogany plywood forms the base to which cap strips, posts and diagonal members are fastened. This construction results in a very light strong rib. The plywood is used to overcome the tendency of single ply to split. The leading edge of the wing is covered with plywood to insure a uniform and efficient section. Fittings are made from low carbon steel. Drag struts are aluminum alloy and wires are hard swaged wire. The small number of struts and the enclosing of fittings gives a very clean appearance to the wings.

POWER PLANT AND HULL OF PN-7

With the design under way, a change in the power plant was made to two Wright engines of 525 H.P. each. This change gives an advantage of the PN-7 over the F-5-L of about 350 H.P. The water radiators are suspended from the upper front wing beam. These radiator cores are made of extruded tubing 9 inches in length. The oil system is patterned after the F-5-L, but simplified and lightened where possible. The gas system is designed to carry the lines through streamline fairing on the struts. Great care was taken to keep the construction clean and thus reduce the resistance. The engine nacelles are made of steel tubular members. These nacelles are streamlined carefully from propeller spinner to include most of the engine and parts of the power plant between wings. Aluminum alloy of .051 is used in the cowling, and it makes a most satisfactory and durable fairing. The hulls allotted to these planes were taken from stock which had been manufactured five years previously; and with the exception of the steps it was found unnecessary to make any replacement of the structure or planking except as was necessary to take the new wings. The first of these planes was finished the following December, and performed creditably with the Service during the winter maneuvers.

DEVELOPMENT OF METAL HULL

The Bureau of Aeronautics and the Factory were meanwhile in constant communication concerning the elimination of an undesirable factor tending to reduce flying boat and seaplane performance, namely, the water logging of the hull. This water logging has been reported in various amounts from time to time. It was found later, in connection with this PN-7, that four months' service added 500 pounds

to the weight of the plane, mainly soakage. The trend of this discussion was that it would be necessary to develop a metal hull in order to overcome this trouble. Subsequently, the Factory was authorized, in the fall of 1923, to develop a metal hull following the lines of the F-5-L. The general construction follows very closely the structural type of the wooden hull. A slightly greater beam is adopted so that the displacement will be at least equal to that of the wooden ones. It is entirely of aluminum alloy, excepting for certain highly stressed fittings; and the covers over the gas compartment, where wood framing with plywood or fabric covering is retained. All transverse bracing is done by bulkheads instead of stick and wire. The principal shapes used are the Z, C and L. The Z shapes are used for longerons, and vertical and cross bracing posts. The keelson is a built-up "I" section, weighing about 45 pounds. On either side of this rolled "C" sections are used as longitudinal stringers. These carry the loads to main cross frames, spaced approximately 36 inches on center. Five water tight bulkheads are provided for strength and buoyancy, in case of leakage if disabled at sea. The bottom is especially rugged, the main portion being made from .081 inches heat treated aluminum alloy. The provisions for accommodating the crew do not vary greatly from that used on the F-5-L. The navigating compartment is forward; the pilots come next, seated side by side. Following the pilots there is a space approximately 15 ft. x 5 ft. x 4 ft. for gasoline cargo. An inside passageway is provided through the hull. The radio operator and his apparatus is stationed next, followed by a cockpit for machine gun operation. The weight of the hull is reduced from 2325 to 1740 pounds, while the strength is not decreased. Thus, a considerable saving in weight is effected along with the elimination of soakage.

THE PN-8 DESIGN

The wings and power plant, as developed for the PN-7, are used with the metal hull. Tail surfaces of aluminum alloy frame with fabric covering complete the structure. In this design, the importance of clean appearance, rigid construction and weight saving is stressed. The numerous struts and wires, which are found necessary on the F-5-L arrangement, are eliminated. Channels are the predominating shapes used, and these have their free edges turned away from the surface. The fin is designed as an internally braced structure entirely. The horizontal surfaces are provided with one set of supporting struts on either side. A powerful radio receiving set completes the improvements authorized for this plane, known as the PN-8.

THE PN-9 LONG DISTANCE PATROL PLANE

While the resulting performance of the PN-7 gives universal satisfaction, the desire to improve the cruising range of this class of plane prompts the development of a power plant around the Packard 1A-1500 engines, with reduction gearing of

2:1. These engines have transmitted very great power, with a minimum of vibration, and have a very low unit weight per horse power. The engines are rated at 480 H.P. and weigh but 850 pounds, including the reduction gears. The gasoline storage capacity is enlarged to approximately 1200 gallons, with about 40 gallons of oil. Aluminum alloy tubing is used in the gasoline piping for the first time. The main tanks are of aluminum, and have a capacity of 116 gallons each, there being 10 such tanks in the hull. The remainder of the gas is stored in the upper wings. The radiators are mounted on the engine foundation about the hub of the propeller, and the general cowling of the engine and oil tank is retained. Another development consists of the oil regulating apparatus which is used in heating the oil at starting and cooling in operation. The Aeromarine inertia hand starter is used. These changes in the power plant, together with the resulting changes in the structure to accommodate the power plant, are the distinctive feature of the PN-9. The development of the PN-9, then borrows the following features of design from its predecessors:

First, the hull lines from the F-5-L; second, the wings from the PN-7; and third, the hull, tail and radio from the PN-8. The new design consists of the power plant, improvements in the engine nacelles, and new navigating equipment.

GENERAL DIMENSIONS

The general dimensions of the plane are:

General	
Span upper wing	72' 10"
Span lower wing	67' 2"
Height approx.	16' 6"
Length	49' 2"
Wing Group	
Gap (at center)	9' 4"
Stagger	0
Dihedral (upper wing)	0°
Dihedral (lower wing)	3°
Sweepback	0
Chord (upper and lower wings) normal section	9' 0"
Chord at ailerons	9' 11½"
Span of aileron	19' 3"
Chord of aileron	3' 3 7/8"
Incidence (upper wing)	2°
Incidence (lower wing)	2°

Tail Group	
Span	20' 0½"
Incidence stabilizer (horizontal)	1 ¾°
Body Group	
Length of nacelle	8' 4"
Length of hull	45' 0"
Beam of hull	10' 2¼"
Height of hull	7' 0"
Distance from step to bow of hull	21' 8½"
Gross displacement of hull	46,000 lbs.
Gross displacement of each wing tip float	1,605 lbs.
Displacement of wing float with wing tip touching water	1,380 lbs.
Clearance of wing tip float at full load	6"

SOME POSSIBLE FUTURE DEVELOPMENT

The aluminum alloy construction indicates that a saving of about 25 percent in weight can readily be made over wooden construction. It would seem, therefore, that the next logical development in the patrol class of planes would be the construction of metal wings, fabric covered. Experimentation is under way from which it is believed successful duralumin tank construction will be accomplished. The difficulties of this later lie in the inexperience in welding and the necessity of developing new methods of heat treating after the welding operation. Considerable saving in weight may be looked for upon the successful solution of this problem. Fuel pumps offer another field for experimentation. It is generally recognized that fuel pumps should be operated from the engines the same as oil and water pumps. Satisfactory pumps have been developed with engine drive where the gasoline supply is about on the same level as that of the pump. In flying boat types, the source of power, however, is remote from the main gas supply, and for this reason wind driven pumps have had to be used to date. It is believed also that the greater accessibility provided in the newer types of inverted engines will be taken advantage of in later development. Structural improvements for mounting and replacing the engines will result. The mounting of the radiator about the propeller axis has contributed to the efficiency of the propeller. At the same time the cowling of the engine nacelle is less satisfactory, and the head resistance of this unit remains large. It is believed probably that a development of the tunnel type of radiator may be made, which will reduce the cross sectional resistance and restore the clean appearance of the nacelles. It also seems quite probable that a change in the lines of the hull, following the NC type, would increase the performance of the plane both in

the water and in the air. In such a development it is considered that the mounting of the tail unit should be made on an extension of the hull rather than upon outriggers, and the stowage capacity of the hull would be considerably increased by the change in lines.

The success of this development work may in some measure be understood by citing the performance of the PN-7. The maximum speed of this plane over the speed course at the Factory is 113 miles per hour. The increased horse power has accordingly improved the take off qualities of the patrol planes. The Service has reported that the planes have been taking off with an over load approximating 3,000 pounds. This, of course, would have been absolutely impossible with the F-5-L plane. The plane has no difficulty in maintaining its altitude, and the service ceiling has been greatly improved. The first PN-7 was with the Scouting Fleet from January to May of 1924, and in that time had service of approximately 150 hours in the air, and covered 15,000 miles. The flight began at Philadelphia, extending along the Atlantic Coast, to the islands of West Indies, where the winter maneuvers were held. The plane was made the flag ship of Capt. Gerardi, and gave universal satisfaction in the Service. The plane was then returned to the Factory in May for very minor reconditioning; and was again returned to the Service until the Fall, when a more general reconditioning was performed, prior to the transfer of these planes to the Pacific Fleet. While the specifications retained a complement of four, the plane is constantly carrying six and seven persons, and a great deal of equipment. It was not possible to secure a service test of the PN-8 in the same manner as was done with the PN-7, since it was decided that this plane should be converted to the PN-9 to go along with another having the Packard engines. However, the tests that were conducted at the Factory indicated that the lighter hull and tail materially improved the performance; and better still that the performance will not be progressively decreasing due to soakage of the hull. With the new power plant, the structural weight of the PN-9 is approximately 9,000 pounds and an equal weight of useful load will be carried. The increase in the gas system is expected to give nearly three times the range that can be obtained from the PN-7. The first tests of these planes indicate a marked improvement in the maximum speed which is obtained. This maximum speed with ordinary patrol loads is now raised until a speed of 128 miles per hour is possible. The cruising performance of the PN-9 awaits demonstration.

The performance of these planes amply justifies the design, and is a tribute to the technical skill and ability incorporated in the Factory as an experimental station.

*Document 5-19 (b), Commander W. W. Webster (CC), U.S.N.,
"The Navy PN-12 Seaplane," Aviation 24 (14 May 1928): 1366, 1404.*

**FIRST PATROL PLANE FITTED WITH AIR COOLED ENGINES HAS
TOP SPEED OF 107 M.P.H. AND A CRUISING RANGE OF 1,350 MI.**

BY COMDR. W. W. WEBSTER (CC), U.S.N.
Chief Engineer, Naval Aircraft Factory

The PN-12, the Navy's first patrol plane with air cooled engines, has completed its preliminary tests at the Naval Aircraft Factory, Philadelphia, Penn. This airplane, for some unknown reason, has been referred to in the press as a mystery plane. As a matter of fact, this airplane is merely another step in the Navy's development of the twin engine, heavy boat type of plane for patrol work with the fleet, coastal patrol, submarine patrol, etc. This type started with H-16 and F-5-L during the World War, and has been developed step by step as indicated by the following table. The development of this type has been in charge of H. S. Conklin, senior aeronautical engineer at the Naval Aircraft Factory:

Model	Year	Hull Construction and Tail Surfaces	Wings			Engines	Hp.
			Constr.	Profile &	Span		
F-5-L	1918	Wood	Wood	RAF-6	104'	2 Liberty Direct	400
PN-7	1923	Wood	Wood	USA-27	73'	2 Wright T2 Direct	525
PN-8	1924	Metal	Wood	USA-27	73'	2 Wright T2 Direct	525
PN-9	1925	Metal	Wood	USA-27	73'	2 Packard 1A-1500 Geared	475
PN-10	1926	Metal	Wood	USA-27	73'	2 Packard 3A-1500 Geared	550
PN-12	1927	Metal	Metal	USA-27	73'	2 Wright Cyclone R-1750 Direct	525

Note: The PN-11 is of a different design not included in this series.

Practically the same hull lines and displacement have been maintained throughout this development.

As will be seen from the above, the principal advance in the PN-12 over the PN-10, is the substitution of metal wings for wood wings and two Wright R-1750 air cooled engines for the former Packard water cooled engines. With the latter change a saving of 1450 lb. was effected in power plane weight, with but a small loss in horsepower.

In the PN-12, therefore, is incorporated all of the latest proven structural and aerodynamic features applicable to this type of plane, including metal construction throughout air cooled engines, and complete navigational and radio equipment, including radio compass and arrangements for sending and receiving when on the water. The metal construction of this plane includes two complete and two partial watertight bulkheads and all possible arrangements for remaining afloat at sea, in case of a forced landing. An additional feature on the PN-12 is an adjustable stabilizer.

Since the trials of the PN-12 have not been completed, it is not possible to give actual performance data at this time. However, the calculated design data, based on the engines developing 525 hp. each at 1900 r.p.m., and a conservative service weight of only 14,100 lb. is given in the following table. For the purposes of comparison, the corresponding data of the F-5-L is given in the second column:

Service Condition as Patrol Planes

	PN-12	F-5-L
Gross Weight, lb.	14,100	13,260
Weight Empty, lb.	7,500	8,720
Useful Load, lb.	6,600	4,540
Gasoline, gal.	750	475
High Speed, m.p.h.	107	90
Stalling Speed, m.p.h.	58	52
Service Ceiling, ft.	10,900	5,500
Endurance, hr. (cruising)	18	12
Range, mi. (cruising)	1,350	800

Based only on this table, however, the useful load has been increased 50 percent over that of the F-5-L, and is now 48 percent of the gross weight. This increase has been effected by a combination of lighter weight, due to metal construction and air cooled engines, increased aerodynamical efficiency, and increased engine power. At the same time there has been a considerable increase in the fixed equipment item of the weight empty, due to additional navigational, electrical and other equipment.

The peacetime crew of this plane consists of four men as follows: Pilot, navigator-bomber, radio operator, and mechanic-gunner. In wartime, however, the crew would be increased to at least five, in order to properly handle the armament provided which is as follows: Bomb racks capable of carrying 1,000 lb. of bombs of various sizes up to two 500 lb. bombs; and gun mounts for six Lewis machine guns, two in the forward cockpit, two aft and two in the side aft.

This plane is designed so that it can readily be fitted with extra fuel capacity in case it is desired to use it as a long distance scout plane, in which case most of the armament weight would have to be removed. During the preliminary trials, it has shown that the plane can readily take off with 17,000 lb. gross load. Experience with the PN-10 and consideration of load factors show that this can be done with safety. This would allow an extra load of about 450 gal. of gasoline or 1200 gal. in all, with which the endurance as a long distance scout should be about 27 hr. and the range about 2,000 mi. at cruising speeds. Trials are now being conducted to obtain accurate data as to these performances.

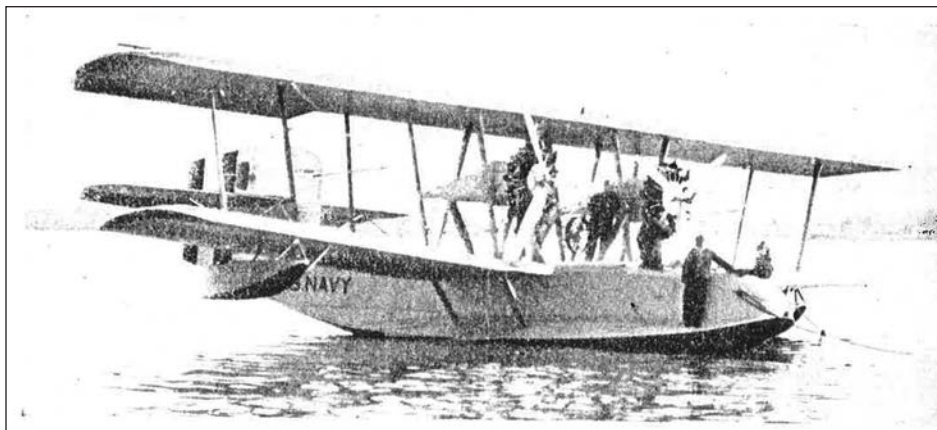

Document 5-19 (c), Rear Admiral W. A. Moffett, U.S.N., Chief of the Bureau of Aeronautics, to Chief of Naval Operations, "Fleet Patrol Plane," 17 August 1932.

NAVY DEPARTMENT BUREAU OF AERONAUTICS
WASHINGTON
AUGUST 17, 1932

From: The Chief of Bureau of Aeronautics.

To: The Chief of Naval Operations (Material).

SUBJECT: (Herewith)

- (A) Three-view Drawing of Bureau Design 121.
- (B) Artist's Photograph of Battle Fleet Patrol Plane.

1. For about two years the Bureau of Aeronautics has seriously considered the advisability of building patrol planes which could readily cruise 3000 miles with a full military load, land or takeoff under any reasonable weather conditions, and be able to operate on their own resources about a week with reasonable comfort for the crew.
2. Such a type plane, which may vary in size from 50,000 to 100,000 pounds gross load, is not new in its conception. The DOX having a gross weight of over 100,000 lbs., although built as a commercial airplane with a much shorter range, may be considered the prototype of this class of airplanes. The British have already built an airplane along this line, the Short six-engine flying boat (gross weight about 70,000 lbs.), and there are evidences that other foreign governments are seriously considering similar developments.
3. The military advantages and additional uses for such a type airplane over any patrol planes now in service or under development in this country should be obvious. For long range patrol and scouting purposes, especially for operating across the Pacific, such a type would be invaluable. In operations with the Fleet, one such plane should be able to replace a destroyer, or even a cruiser under some conditions. In addition, this type can be used for heavy bombing purposes at a reduced range. In the larger sizes they should be able to take off in, land in, or ride out a rough sea, and would have living quarters with galley, shower, ice box, etc., comparable with a small destroyer.
4. Design studies of such a patrol plane, or rather a series of such planes varying in size, weight and performance, have been prepared by this Bureau. Enclosures (A) and (B) illustrate the general design and dimensions of one of the larger sizes, a 100,000-pound boat. For other sizes, the same general design, scaled up or down, could be used. The following approximate performance figures appear possible of attainment in the size illustrated, based on a normal load stalling speed of 70 MPH:

Weight	100,000 lbs.
Span	190 ft.
Length	110 ft.
Height	38 ft.
Maximum Speed	160 MPH
Range at 100 MPH	3500 miles
Endurance	35 hours

It will be noted that the above range compares favorably with the range of a destroyer. It is believed that a boat of this size can be successfully refueled at sea under conditions almost as severe as those under which a destroyer can be refueled.

5. With regard to other variations of the general design, if the stalling speed is lowered, the maximum speed and range will also be less. With the same stalling speed, approximately the same performances can be obtained in an airplane one-half of the above weight, but a considerable degree of seaworthiness, habitability and military efficiency would be sacrificed.
6. It is estimated that the cost of the first airplane of this class will be between \$500,000 and \$800,000 depending upon the size. Funds for this purpose are not available from this Bureau's regular appropriations. In production in any numbers the cost would be about 50% to 60% of the cost of the first airplane.
7. The probable value of this class of airplane to perform the duties of destroyers or cruisers, in addition to its undoubted value for long range patrol or scouting, is such that its use must seriously be considered both from an economical standpoint and from the standpoint of possible treaty restrictions on cruisers and destroyers. It is believed that the lack of such airplanes against an enemy equipped with such planes would be a serious handicap under any circumstances. It is therefore urgently recommended that the building of an experimental airplane of this class be authorized as early as practicable. It is suggested that this could logically be included in the New Construction Program of the Navy.

W. A. MOFFETT
 Rear Admiral, U.S.N.
 Chief of the Bureau of Aeronautics

Document 5-20 (a–c)

(a) Walter S. Diehl, “Seaplane Floats,”
chapter 15 in *Engineering Aerodynamics* (New York:
The Ronald Press Co., 1928), pp. 253–265.

(b) William Nelson, “Take-Off of the Seaplane,”
chapter 9 in *Seaplane Design* (New York and London:
McGraw-Hill Book Company, Inc., 1934), pp. 102–121.

(c) Marcus Langley, “Flying Boat Hull Design,”
chapter 5 in *Seaplane Float and Hull Design* (London:
Sir Isaac Pitman & Sons, 1935), pp. 80–92.

By the late 1920s, the design of flying boats had achieved sufficient maturity to become textbook material. This string of documents provides excerpts from three different textbook treatments of flying boats and their aerodynamics.

The author of the first selection, published in 1928, was Lieutenant (Construction Corps) Walter S. Diehl, a member of the Scientific Section of the U.S. Navy Bureau of Aeronautics. Diehl was the officer in charge of liaison between the Bureau of Aeronautics and the National Advisory Committee for Aeronautics. A CC engineer who in his insistence on remaining a technical man refused throughout his career to pursue promotions via sea duty, Diehl was a great friend to and promoter of NACA research—and not just through his membership on the NACA’s Aerodynamics Committee. Diehl’s relationship with the NACA was regular and quite personal. For example, he often approached his superiors at the Bureau of Aeronautics with the news that the NACA wanted to borrow a certain type of airplane for some sort of test. Because he met regularly with the NACA’s director for research, George W. Lewis, and his assistants in the Washington office (both Diehl’s and the NACA’s offices were in the Navy Building) and frequently visited Langley laboratory, he always knew exactly what the NACA was doing and what it wanted to do in the future. If he could pass on the Committee’s assurance that the laboratory would make immediate use of the aircraft in question and that the proposed research had a good chance of producing data valuable to the general or specific development of naval aircraft, Diehl usually received permission to process the necessary papers. Besides arranging the loan of aircraft, Diehl was also the NACA’s best means of getting Navy support for the authorization of a new research program or the permanent transfer of equipment and spare parts. In return for such support—and because his supervision was friendly and occasional and did not put the staff to the trouble of preparing replies and discussions—the NACA seems to have permitted

him on-the-spot authority to terminate any Navy-requested test that in his opinion had run its course.

In this selection from his 1928 textbook *Engineering Aerodynamics*, Diehl focuses on the aerodynamic design of seaplane floats, a topic that the NACA's new hydrodynamics division would soon come to explore in depth in a \$649,000 seaplane towing tank that became operational in early 1931 and for which Diehl's support was critical for authorization. In this chapter of his textbook, Diehl expresses a serious interest in reducing the aerodynamic drag of flying boat hulls and seaplane floats. Curiously, the Navy made little progress in this area into the mid-1930s, when NACA researchers became much more involved in this objective (see Document 5-21).

Diehl kept the same position within the Bureau of Aeronautics for many years, until he retired from the Navy as a captain in the 1960s. In 1940, the Navy abolished the Construction Corps to which he had belonged, after which specialist officers like him were designated "Engineering Duty Only." He died in 1971. He is a little-known figure who played a great part in aiding the progress of aerodynamic research in the United States.

As the author of the second selection, Lieutenant Commander William Nelson, also of the U.S. Navy's Construction Corps, makes clear, the takeoff of a seaplane posed many special problems because it was a time when the machine had to operate as a watercraft and an aircraft combined. As Nelson explained in this chapter of his 1934 textbook, *Seaplane Design*, in takeoff, a seaplane should head into the wind with power applied. At first, the bow of the vehicle would fall due to the high thrust, but as speed increased, the bow rose and the stern depressed. The flow at the hull's transverse step started to jump across to the bottom aft, and the air filling in that space was admitted either by the chines or by vent tubes. As the speed increased, the point of contact moved farther and farther back until, at the point of planing, the bottom aft of the step was entirely out of the water. The speed at planing needed to be about one-third of the takeoff speed, and it was at this point that the aerodynamic controls started to function. Peak resistance or drag occurred just before planing and was known as the "hump." Heavily loaded machines in smooth water and very little wind sometimes failed to get over the hump because wing lift did not help much at lower speeds. Due to increased water resistance and increasing lift of the wings, the speed increased rapidly from planing up to takeoff. Usually, it was wise in Nelson's view for a pilot to keep the elevators depressed to keep the machine on the water until well above takeoff speed, so that there would be less chance of stalling. Raising the elevator and dropping the tail should make the machine take off with the tail end of the floats or hull remaining clear of the water. Nelson suggested that it was sometimes advisable to take off at stalling speed when the wind was strong and the seas rough. In his analysis, Nelson made reference not only to Walter Diehl's 1928 textbook but also to NACA studies of drag resistance.

At the time his text was published, Nelson also served as a lecturer in the Guggenheim-sponsored aeronautics program at New York University. He later became a commander with responsibilities at the Naval Aircraft Factory in Philadelphia.

The final selection is a chapter on flying boat hull design from Marcus Langley's 1935 text, *Seaplane Float and Hull Design*. Little is known about the author other than that he was a British aeronautical engineer with a degree in naval architecture who served at the time of this publication as an "Instructor in Design" at the De Havilland Aeronautical Technical School in England. Besides this textbook, he also authored a book titled *Metal Aircraft Construction: A Review for Aeronautical Engineers of the Modern International Practice in Metal Construction of Aircraft*, also published by London's Pitman & Sons earlier in the 1930s.

*Document 5-20 (a), Walter S. Diehl, "Seaplane Floats,"
chapter 15 in Engineering Aerodynamics (New York:
The Ronald Press Co., 1928), pp. 253–265.*

The naval architect describes floats with a number of technical words and phrases peculiar to his profession. For the benefit of the student and engineer who is unfamiliar with these terms, a short list of definitions has been prepared, limited to the most frequently used words and phrases.

Afterbody. That part of a float between the main step and the stern.

Bottom. The area included between chines and keel from below to stern.

Bow. The extreme forward point, or portion of a float.

Buoyancy. The displacement (in lbs. of sea water) to a given water line.

Buoyancy, center of. The center of gravity of the displaced volume of water.

Buoyancy, excess. The difference between the total or submerged and normal or load water line displacements. Usually expressed as a percentage of the normal displacement.

Chine. The line of intersection of the bottom with the sides or deck.

Deadrise. The angle which each side of the bottom makes with the horizontal, as measured in a transverse plane.

Deck. The upper surface between the sides. If the sections are rounded without flat or vertical portion, then all of the upper surface between the chines is called the deck.

Deck line. The upper boundary of the float in a side elevation.

Displacement. The weight of the sea water displaced to a given water line, or simply the load carried by a float under given conditions.

Displacement submerged. The weight of the sea water displaced when the float is completely submerged.

Draft. Usually refers to the maximum depth below water surface of any part of the float under given conditions.

Forebody. That part of the float between the main step and the bow.

Keel. The main longitudinal and continuous strength member located along the bottom and on the center line.

Keel, false. A protective member attached along the bottom center line on the outside, to prevent damage from handling or grounding.

Metacenter. A point through which the resultant vertical buoyant force passes for all small displacements from the position of equilibrium.

Metacentric height. The distance from the center of gravity to the metacenter.

Porpoising. Any pronounced pitching oscillation in a moving float.

Speed, getaway. The speed at which the entire weight of the seaplane is carried by the wings.

Speed, hump. The speed or speeds at which the water resistance is a maximum.

Sponsons. Lateral projections added to the sides of a float or hull to increase planing area or transverse stability.

Spray strips. Thin longitudinal strips of triangular cross-section attached to the bottom along the chine to “beat down” the spray.

Squatting. A pronounced tendency to trim by the stern.

Step. A line of discontinuity in a surface. In its usual form, a sudden change in transverse sections.

Stern. The extreme rear point, or portion of a float.

Trim. The angle of pitch, usually measured between the deck line and the water line.

Trim by bow. An angle of trim produced by depressing the bow and raising the stern and measured in the same manner as trim by stern.

Trim by stern. An angle of trim produced by raising the bow and depressing the stern and measured from a level position of some reference line, usually the deck line.

Model tests—corresponding speeds. The only way to determine the water resistance of a float or hull is by actual test, either full scale or on a model. Since most of the resistance is “wave-making,” comparisons must be made on the basis of $\frac{V^2}{L}$ or $\frac{V}{\sqrt{L}}$. That is, the “corresponding speed” is proportional to the square root of the length.

Froudes' Law of Comparison states that at corresponding speeds the full-scale wave-making resistance is equal to the model wave-making resistance multiplied by the cube of the linear scale ratio of full size to model.

Letting V_1 = model speed and V = full-scale speed

R_1 = model resistance and R = full-scale resistance

and L = linear scale ratio $\frac{\text{full size}}{\text{model}}$

the following relations hold

Corresponding speeds $V = V_1\sqrt{L}$

Resistance at corresponding speeds $R = R_1 L^3$

If a model is $\frac{1}{9}$ full scale, i.e., if $L = 9$, then the corresponding speeds on the model are one-third of the full-scale speeds, and at corresponding speeds, the full-scale resistance is $9^3 = 729$ times the model resistance. Since both the displacement Δ and the resistance R vary as the cube of the scale ratio, it follows that the ratio $\frac{\Delta}{R}$ is the same for the model and full-scale at corresponding speeds. Model test data on seaplane floats and hulls are usually given in the form of curves of $\frac{\Delta}{R}$ against the ratio $\frac{V}{V_G}$ where V_G is the "getaway" speed at which the float leaves the water.

A given model test representing a definite full-scale seaplane, also represents the infinite number of full-scale getaway speeds and linear scale ratios giving the same value of model getaway speed. For example, the corresponding getaway speed for a linear scale ratio of 12 and a full-scale getaway speed of 52 knots, is 15 knots. A model tested under these conditions would represent any geometrically similar full-scale getaway but to a different scale ratio, which is obviously $L = \left(\frac{V_G}{15}\right)^2$. That is, it would represent a 45 knot getaway to the scale ratio 9, or a 60 knot getaway to the scale ratio 16, etc.

In addition to resistance at various trims, model tests should include, measurements of righting moments at rest, trimming moments underway, planing and spray characteristics. The righting moments at rest give the metacentric heights, while the trimming moments under way bring out any undesirable or uncontrollable tendency to dive or "squat." The planing characteristics are rather general, and include items such as tendency to "porpoise" or "sticking at high speed." The spray characteristics are observed ordinarily to avoid an arrangement that allows spray to enter the propeller disc, or perhaps more exactly in some cases, to reduce this spray to a minimum.

Model basin methods. Since the model basin equipment and general methods of testing seaplane floats at the Washington Navy Yard have been fully described elsewhere, the following résumé has been prepared chiefly for the benefit of aeronautical engineers to whom the original papers are not readily available.

The model basin is simply a tank about 42 ft. in width by 470 ft. in length and 15 ft. in depth at the center. A "carriage" extending across the basin, is driven on carefully aligned tracks by four electric motors using the Ward-Leonard speed control. The carriage is fitted with all of the speed control and dynamometer gear; it weighs approximately 75,000 lbs. Its maximum speed is approximately 18 knots, but testing is very rarely ever done at speeds greater than 15 knots, chiefly on account of the short run available and the arresting difficulties at the higher speeds.

In testing seaplane models, certain assumptions are necessary in order to arrive at practical methods. First, the model is attached to the dynamometer by means of an arm about 8 ft. in length. This arm is hinged at the dynamometer attachment

and guided so that it is free to move in a vertical plane. The model attachment to the dynamometer arm is such as to allow the model to pitch freely about the full-scale center of gravity on the “free-to-trim” runs. On the “fixed trim” runs the attitude of the model relative to the arm is fixed. It is assumed that the angular changes due to vertical motion of the model are negligible and this is easily verified. Second, the model displacement at rest is adjusted by means of weights carried on an extra flexible wire cable passing over two pulleys to the model. These weights also counterbalance the dynamometer arm. Obviously, all of these weights in the system seriously affect any comparison of model oscillations with full scale. Third, it is assumed that the wing lift varies directly as the speed so as to lift the model entirely clear of the water at the “corresponding” model getaway speed. This lift is automatically applied directly to the counterbalance cable by a small vane which is calibrated by trial runs to determine the correct setting. When this setting is once determined, it is not changed during the test although the wing lift is proportional to the angle of attack as well as to the square of the speed. It may be shown, however, that the error introduced by this approximation is negligible, and some allowance is made by taking the getaway speed from 5% to 10% higher than the calculated actual value.

That these assumptions do not seriously affect the validity of test data has been amply proved by a number of comparisons between model and full scale. The best method yet found for an approximate check is in the comparison of predicted and actual maximum loads that can be taken off by a given seaplane, in a calm or in a wind of known velocity. The agreement in every case investigated has been uniformly close, indicating less than 5% difference.

Typical model basin data. Table 21 contains the average values of $\frac{\Delta}{R}$ against the ratio $\frac{V}{V_G}$ for single floats, twin floats, and flying boat hulls as given by Captain H. C. Richardson in his historical paper “Naval Development of Floats for Aircraft.” These average values may be used for any general purpose, but too much dependence should not be placed on their use in a performance calculation that indicates a low margin of thrust, because the possible deviation from the average is considerable.

Take-off in a calm. The resistance due to the floats or hull in a take-off is readily obtained by the following steps:

1. Calculate getaway speed V_G
2. Assume a series of speeds V
3. Find ratio $\left(\frac{V}{V_G}\right)$ for each speed
4. Read $\left(\frac{\Delta}{R}\right)$ at each $\left(\frac{V}{V_G}\right)$ from model basin curves
5. Calculate Δ at each speed: $\Delta = \left(W_1 - \frac{V}{V_G}\right)^2$
6. $R = \frac{\Delta}{\left(\frac{\Delta}{R}\right)}$

TABLE 21. Average Ratio (Displacement/Resistance) from Model Basin Tests.

Speed % Getaway Speed	Average Ratio of $\frac{\Delta}{R}$		
	Single Floats	Twin Floats	Boats
20	8.05	8.10	10.30
25	6.50	6.60	7.40
30	5.10	5.30	6.10
35	4.30	4.50	5.30
40	4.10	4.10	4.90
45	4.05	4.10	4.80
50	4.30	4.25	5.05
55	4.70	4.65	5.25
60	5.15	5.15	5.50
65	5.55	5.45	5.50
70	5.75	5.50	5.35
75	5.55	5.30	5.00
80	5.00	4.70	4.50
85	4.15	3.90	3.90
90	3.20	3.05	3.05
95	2.00	2.30	1.80
100	0		0

lift no longer follows the curve assumed in making the Model Basin test. For take-off into wind, the wing lifts are greater and for take-off down wind they are less than the assumed values. This is simply equivalent to changing the load on the float at a given speed. Let us consider the effect of changes in load and changes in getaway speed on the values of $\frac{\Delta}{R}$. Figure 154 is a plot of $\frac{\Delta}{R}$ against $\frac{V}{V_G}$ for an NC type of boat hull with three loads and with constant getaway speed, as obtained in tests at the Washington Navy Yard. The values of $\frac{\Delta}{R}$ fall upon a single curve, indicating that with constant getaway speed the effect of a 25% change in load carried by the float is negligible. Figure 155 is a plot of $\frac{\Delta}{R}$ against $\frac{V}{V_G}$ for an F₅ type of

The total resistance is found by adding the air resistance of the airplane to each value of R . The air resistance is found by assuming a constant angle of attack in take-off, say 8°, and calculating (or simply estimating) a value of $\frac{L}{D}$ corresponding to this angle. The air resistance is $D = \frac{L_W}{\left(\frac{L}{D}\right)}$ where L_W is the wing lift = $W\left(\frac{V}{V_G}\right)^2$. If the total resistance and maximum propeller thrust are plotted against speed on the same diagram, the margin of thrust available for acceleration is easily obtained and from this one can obtain the probable take-off performance.

Take-off in a wind. The take-off may be made either into or down wind, but the effect of the wind is so great that few seaplanes can take off down wind when the wind velocity V_0 is large. If there is any wind at all, the air speeds and water speeds are no longer equal, and the wing

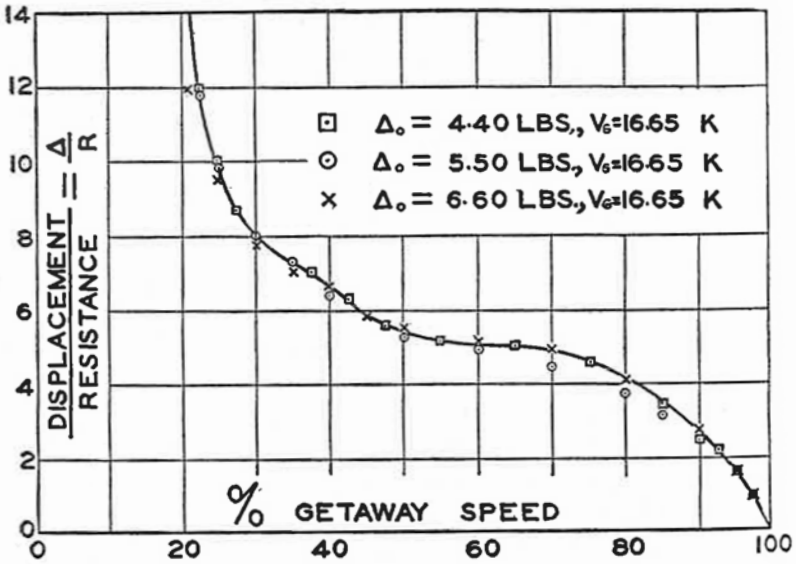

FIGURE 154. Effect of Variable Load on Δ/R with Constant Getaway Speed.

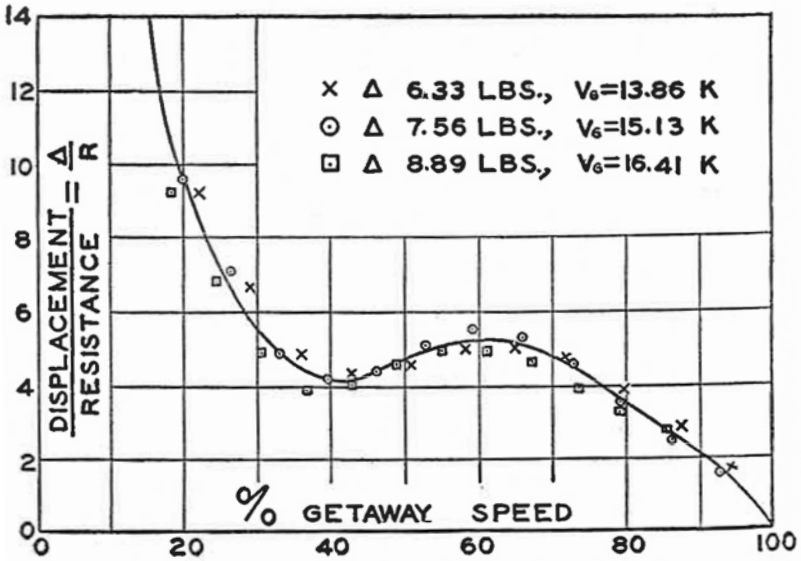

FIGURE 155. Effect of Variable Load and Getaway Speed on Δ/R .

hull with three loads and with getaway speed varied according to the load, also from Washington Navy Yard test data. As might be expected, there is a slight decrease in the values of $\frac{\Delta}{R}$ as the load and getaway speed are increased, but the changes are negligible for engineering purposes. Values of $\frac{\Delta}{R}$ may therefore be read

directly from the standard curve, if the ratio $\frac{V}{V_G}$ is determined from the water speeds. Resistances are found from these values of $\frac{\Delta}{R}$ and the corresponding displacements. The procedure will be outlined in detail, for clarity.

Take-Off into Wind: Denoting wind velocity by V_0 and the getaway air speed by V_G , the getaway water speed is $V_{GW} = V_G - V_0$. If the water speed is V_w , then the values of $\frac{\Delta}{R}$ are determined by the ratios of $\frac{V_w}{V_{GW}}$, and resistances are obtained as follows:

1. Calculate getaway air speed, V_G
2. Assume value of wind velocity V_0
3. Calculate $V_{GW} = V_G - V_0$
4. Assume a series of water speeds, V_w
5. Find ratios $\frac{V_w}{V_{GW}}$
6. Read $\frac{\Delta}{R}$ from standard curve, assuming $\frac{V_w}{V_{GW}}$ equivalent to $\frac{V}{V_G}$
7. Obtain air speed, $V = V_w + V_0$
8. Find wing lift at each water speed, assuming $L_w = W \left(\frac{V}{V_G} \right)^2$
9. Load carried by float $\Delta = W - L_w$
10. Water resistance $R = \frac{\Delta}{\left(\frac{\Delta}{R} \right)}$
11. Air resistance $D = \frac{L_w}{\left(\frac{L}{D} \right)}$

Take-Off Down Wind: In this case the water speeds are greater than the air speeds and it is necessary to consider V_0 negative.

The method just outlined must be considered as an approximation for use in the absence of more exact data. It gives results which agree quite closely with observed full-scale maximum loads which can be taken off in a wind of known velocity.

Thrust may be assumed to vary linearly with speed, making it necessary to calculate the thrust at two speeds only, one of which may be the static thrust. (See Chapter VI.)

Metacentric height. Metacentric height may be defined by considering a floating prism having its c.g. at a point G and its center of buoyancy at a point B . A line perpendicular to the water surface and passing through B will also pass through G . If the prism be inclined through a small angle θ while retaining the same volume of displacement, the center of buoyancy will shift to a point B' . A vertical through B' will intersect the original vertical BG at a point M , which is called the metacenter. The distance GM is called the metacentric height.

It is easily shown that the metacentric height is a measure of static stability. Considering a slight inclination θ and taking moments about the original center of buoyancy B , it is seen that the disturbing moment is $W \cdot BG \cdot \sin \theta$ and the righting moment is $W \cdot BM \cdot \sin \theta$. The total resultant moment is

$$\begin{aligned} M &= W \cdot (BM - BG) \cdot \sin \theta \\ &= W \cdot GM \cdot \sin \theta \end{aligned}$$

and the slope of the resultant moment curve is

$$\frac{dM}{d\theta} = W \cdot GM \cdot \cos \theta$$

from which

$$GM = \frac{dM}{d\theta} \cdot \frac{1}{W \cdot \cos \theta} \quad (\text{for } \theta \text{ in radians})$$

or

$$GM = \frac{57.3}{W} \frac{dM}{d\theta} \quad (\text{for } \theta \text{ in degrees}) \quad (180)$$

This relation is used to determine metacentric heights from inclination tests on models.

The metacenter may be found by the use of the formula $BM = I/V$, where I is the moment of inertia of the waterplane about its center line and V is the total volume of displacement (see any book on Naval Architecture). I varies as L^4 , and V varies as L^3 , so that BM and the metacentric height vary directly as the length, or scale ratio.

Approximate metacentric heights for seaplane floats and hulls may be obtained from the empirical formulas given below.

Metacentric height required. Analysis of the performance of a great number of seaplanes indicates that satisfactory static stability is obtained when

$$\text{Transverse } GM = \text{longitudinal } GM = 1.4 (\Delta)^{1/3} \quad (181)$$

where Δ is the gross weight of the seaplane.

Transverse metacentric height of twin floats. It has been shown that with the design proportions in common use, the transverse metacentric height for twin floats is given closely by the empirical formula

$$GM = \frac{K_1 L s^2 B}{\Delta} \quad (182)$$

where L is the length and B the beam of each float in ft., s the spacing on center lines in ft., Δ the gross weight of the seaplane, and K_1 a constant varying from 17.7 to 20.8 with an average value 19.5. Equation (182) may be used to determine the spacing necessary for stability by substituting the average value of GM from equation (181). That is

$$s = \left(\frac{1.4 \Delta^{4/3}}{19.5 LB} \right)^{1/2} = \frac{0.28 \Delta^{2/3}}{\sqrt{LB}} \quad (183)$$

Longitudinal metacentric height. It has been shown in N.A.C.A. Technical Note No. 183 that the longitudinal metacentric height for either single or twin floats is given with sufficient accuracy by the empirical equation

$$GM = \frac{K_2 n L B^3}{\Delta} \quad (184)$$

where n is the number of floats (i.e., one or two), B the beam of each float in ft., L the length in ft., Δ the gross weight of the seaplane, and K_2 a constant normally varying between 1.90 and 2.40 with an average value of 2.10.

Equation (184) may be used to determine the minimum length of a seaplane float for longitudinal stability by substituting the value of GM from equation (181)

$$L^3 = \frac{1.4 \Delta^{4/3}}{2.10 n B} = \frac{0.67 \Delta^{4/3}}{n B} \quad (185)$$

Transverse stability—single floats and flying boats. Single float seaplanes and flying boats require the use of auxiliary floats on the wing tips in order to secure transverse stability. The usual method is to install the tip floats so that at normal trim and draft they clear the water from 3 in. to 8 in. according to the span, and make the volume large enough to give a righting moment which is greater than twice the upsetting moment when one float is just submerged.

The equation of moments about the c.B. is obviously

$$\Delta_1 l \cos \theta = C \cdot W h \cdot \sin \theta$$

from which, the wing tip float displacement is

$$\Delta_1 = C \cdot W l \cdot \tan \theta \quad (186)$$

where W is the gross weight, h the height of the c.g. above the center of buoyancy ($h = BG$), l the distance from the c.B. of the tip float to the c.B. of the main float or hull, θ the angle of inclination required to submerge the tip float, and C a constant greater than 2.0 and preferably between 2.5 and 3.5.

Section coefficients. The ratio of maximum cross-section to the product of beam by depth varies according to type as follows:

	<i>A/BD</i>
Average single float	.78
Average twin float	.78
Average boat hull, no sponsons	.70
Average boat hull, with sponsons	.55

These values are useful in making performance estimates. They should be regarded simply as averages, for this or similar purposes.

Prismatic coefficients. The ratio of total (submerged) volume to the product of length L , beam B , and depth D is the prismatic coefficient. This coefficient is variable with the type of float or hull, and has the following average values:

Type	Prismatic Coefficient, C_v
Single floats	.70
Twin floats	.72
Boat hulls, no sponsons	.50
Boat hulls with sponsons	.32
Wing tip floats	.55

The submerged displacement in sea water weighting 64 lbs./cu. ft. is given by

$$\Delta s = 64 C_v LBD \quad (187)$$

L , B , and D being in ft.

Document 5-20 (b), William Nelson, "Take-Off of the Seaplane," chapter 9 in Seaplane Design (New York and London: McGraw-Hill Book Company, Inc., 1934), pp. 102-121.

40. GENERAL

The seaplane during its take-off from the water is a water craft and an aircraft combined. Afloat, it must retain the water characteristics of stability and buoyancy. In the take-off, it combines these with certain air characteristics and also introduces two other features—water resistance and trimming moment of the float system. These latter items are not particularly difficult to handle if the seaplane is fitted with sufficient power and if control over the trimming moment can be exercised by the air controls. But if a balance between the power required to overcome the water resistance and that required to attain maximum speed in the air is sought, the take-off problem requires careful analysis in the design stage. This condition may be brought about by the maximum load that the seaplane is to carry or by a limit on the take-off distance with a fixed load.

Seaplanes ordinarily take off into the wind. When conditions of sea warrant it and when the wind is light, they may be taken off in the trough of the sea. It is desirable and sometimes necessary that the take-off be as short as practicable to reduce the dangers incident to rough water. And even where smooth waters are available, limitations may be imposed by land, shallow depth of water, or other restrictions. It is the designer's responsibility to provide a seaplane with a float having air-worthy and seaworthy characteristics and permitting the seaplane to take off with the specified load in the shortest distance possible.

The take-off, aside from float characteristics, depends on the arrangement of that float relative to the rest of the seaplane. It depends on the wing and the wing area. It depends on the power available and also upon the control that can be exerted over the forces extant. Aerodynamic considerations and performance of the seaplane in the air govern most seaplane features other than the float and its position. A good float has a low water resistance and is so situated that control over its trim can be handled by the ailerons, wings, and elevators. It must not take off before the seaplane has reached stalling speed, and it must not "porpoise" or stick to the water.

The limits to the take-off performance are fixed by the wing loading and the power loading of the seaplane as a whole.

Starting at rest, when the power is applied the seaplane is accelerated by the propeller thrust. As this thrust overcomes the water resistance, the seaplane gains velocity. Air resistance of the seaplane comes into play. Then, during the remainder of the take-off, the thrust of the propeller in excess of the air resistance and the water resistance tends to accelerate the seaplane until it takes off the water. Several points are of special interest in this take-off. When the speed has reached about 40

per cent of the take-off speed, the water resistance is a maximum. Also, up to this speed the surface controls are not fully effective. This means that the float is practically free of trim.

Owing to the nature of the bottom of the forebody of the float, the relative motion between the floats and the water tends to lift the bow of the former. This produces a tail-heavy moment on the float. At some point, the longitudinal righting moment and the thrust balance this tail-heavy moment so that the float assumes a maximum trim angle just before the seaplane is put on the step. Some floats may have a bottom shape so that the bow is held down instead of being lifted. Naturally, such a condition is not desirable, for it is difficult to overcome this suction with the air controls at low speeds.

Owing to some cause that has not yet been analyzed satisfactorily, some floats porpoise in the take-off run. It has been suggested that this may be due to the heaving and pitching action of the float, causing it to bury its bow and then to repeat this movement with the tail so as to make take-off impossible. Whether or not it can be identified by causation, it is known that longitudinal movement of the float relative to the c.g. of the seaplane tends to reduce porpoising. This is not a solution to the problem, for it may be undesirable to relocate a float for other reasons. In any case, porpoising of a hull or a float cannot be permitted as an attribute of result by the designer.

At the hump speed, the air resistance is about one-tenth the water resistance. It increases proportionally to the square of the speed.

After the hump resistance is overcome, the float is put in the planing attitude. From here to take-off, the surface controls must be effective in controlling the trim. The water resistance decreases. It can be controlled by adjusting the float to the trim angle giving maximum resistance.

The take-off problem of a seaplane then resolves itself into determining the time and distance of take-off and analyzing the factors affecting the take-off with a view to improving the performance.

41. TAKE-OFF CALCULATIONS

The calculation of the take-off problem of a seaplane is similar to that of a landplane. The take-off time and distance depend upon the acceleration of the craft from rest up to the minimum flying speed. The force tending to produce acceleration is the thrust of the propeller. The forces opposing acceleration are those due to air and water resistance. The difference between these forces at any instant is the actual accelerating force.

The minimum speed of flight of the seaplane is fixed by the formula

$$V_{\min} = \sqrt{\frac{W}{L_{C_{\max}} \cdot S}}$$

All of the parts determining this velocity are selected for aerodynamic considerations. The airfoil section is established with due regard to the usual factors. This fixes the lift coefficient at all angles of attack. The limit on the landing speed and the maximum speed compromise in fixing the wing loading. Consequently, the stalling speed is more or less a quantity that is not influenced by the take-off considerations. It should be noted, however, that the designer has it within his power to change the wing in order to change the take-off, if he so requires and, also, that slots, flaps, and similar devices are equally effective in affecting the seaplane performance as they are in altering the performance of a landplane in this respect.

In practice, a seaplane may or may not be stalled off the water in take-off. The designer plans on a velocity higher than the minimum in the take-off, because the maximum lift coefficient is at a high angle of attack. As the seaplane accelerates during the take-off run, the wing is at an angle of attack corresponding to a low float resistance and a low seaplane drag. Although the angle between the wing and the float can be altered by the designer, the angle is a compromise as finally established. Near the end of the take-off, the wing can be pulled up so as to stall off the water at minimum speed, but the afterbody of the float must not touch the water in doing so, and care must be exercised that the seaplane does not fall back into the water owing to the low flying speed. In a sea, it may be necessary to stall off the top of a wave. Otherwise, it is customary to consider the minimum speed at take-off at an angle of attack lower than that of maximum lift coefficient. Some reserve lift then exists after the float has left the water.

The rate of acceleration of the craft during the take-off run depends on the amount that the propeller thrust exceeds the combined water and air resistance and on the mass accelerated. The propeller characteristics are established from factors other than take-off, excepting when take-off is critical. For fixed-blade propellers, good climb and high speed are likely to be more important than the take-off. But in case the hump resistance of the float is so great that excess thrust is not available with a certain propeller set to a definite pitch, a change in propeller design, a change in propeller efficiency, or a change in pitch setting may give the desired results. The propeller diameter is limited by the position of the power plant with respect to the other parts of the airplane and with respect to the water. The pitch setting of the propeller blades can be adjusted to give some change in static thrust without affecting the other characteristic too much, and this means is resorted to usually in case of difficulties. A large pitch gives a large static thrust. Controllable pitch propellers with pitch settings varying 8 to 10° permit the variations between the static thrust and the cruising-speed thrust desired.

The propeller design, diameter, and pitch setting having been determined, it is necessary that the propeller thrust be calculated for the speeds concerned in the take-off. It is assumed that the static thrust exists up to 20 or 30 miles per hour, and in this range it is constant. Diehl gives the following empirical equation for static thrust:

$$T_o = 6,000 \left[18.7 - 9.5 \left(\frac{p}{D} \right) \right] \frac{BHP}{(\text{r.p.m.}) \cdot D} \text{ lb.}$$

where p is the nominal pitch and D is the diameter of the propeller. The static thrust per horse power can also be determined from a calculation assuming that it is equal to a constant divided by the product of r.p.m. and propeller diameter. The constant is 49,000 for $VN \cdot D$ of 1.1 and 79,000 for $VN \cdot D$ for 0.5. The variation is assumed to be linear between these two coefficients. The r.p.m. of the engine on the ground is 100 to 200 r.p.m. less than that attained with full throttle aloft. This must be taken into account. The thrust at speeds above 30 miles per hour is obtained from ratio curves, the speed for maximum propeller efficiency being known.

The air drag of the seaplane at each of the various speeds up to take-off speed and at each of the various angles of attack of the wing is obtained from the wind-tunnel data on the seaplane. For certain portions of the take-off run, the angle of attack can be assumed as an average value without serious error. The drag of the float or hull is deducted from the drag of the seaplane as a whole, since this is included with the water resistance.

The lift and drag coefficients of the seaplane (less the hull) can be corrected for ground effect by allowing for it in the aspect ratio. These coefficients being plotted for the various angles of attack, the lift and drag at any speed can be determined by the formulas

$$\text{Lift: } C_L \cdot \frac{\rho}{2} \cdot V^2 \cdot S$$

$$\text{Drag: } C_D \cdot \frac{\rho}{2} \cdot V^2 \cdot S$$

These formulas are common to aerodynamics, and no explanation is necessary.

The water resistance of the hull varies with the trim angle of the hull. The latter is constant for small portions of the take-off run where the least resistance is desired. The wing is set at a fixed relation to the hull; and, as a consequence, varying the trim angle changes the angle of attack of the wing. This, in turn, varies the lift and drag coefficients. In the hydrovane method of testing models, the lift coefficient is assumed constant and is fixed at the value corresponding to the take-off speed chosen. The error due to this is large at take-off speed. The angle of wing setting, being the only variable available, is established so that the angle of attack and the trim angle are such as to give the least total resistance near the take-off speed. A setting giving this least resistance at 80 to 90 per cent of the stalling speed is satisfactory. A study of Fig. 37 will show the relationship between the trim angle of the float and the angle of attack of the wing. To obtain the wing-setting angle, it is necessary to calculate the total resistance (water and air) at 90 per cent of the stalling speed for several angles of attack. The stalling speed being known, the take-off speed can be established. Using 90 per cent stalling speed as a criterion, the lift coefficients at various angles of attack, and the wing area, the lift for each

angle of attack can be calculated. The lift being known, the displacement at that angle of attack is the difference between the weight of the seaplane and the lift. The drag for each angle of attack is calculated. The water resistance for each displacement at each angle of attack considered is taken from the basin data. The resulting water resistance plus drag at each angle of attack gives a series of total resistances from which the least total resistance can be selected. The angle of attack corresponding to the smallest total resistance is that angle of attack desired at 90 per cent stalling speed. The displacement corresponding to that angle of attack gives the clue to the trim angle corresponding thereto. The difference between the angle of attack and the trim angle is the angle of wing setting. This angle is subject to minor variation after the complete take-off calculation is made, since it may be that a slight change will give a better result.

Now, having established the wing setting and selecting the trim angles corresponding to low water resistance, the angles of attack at the various speeds up to take-off can be determined. The drag at each of these angles of attack and its corresponding speed can be calculated and plotted. The water resistance is taken for the various speeds from the model-basin-test data. The hull can be assumed to be held at the trim angle giving least resistance throughout the run, which gives fixed-trim angles, or the hull can be assumed to be free to trim up to the hump speed and at fixed trims beyond the hump speed. In any case, the trim angle may vary with the speed, as is indicated by Fig. 35.

By plotting thrust and the two resistances against the speed or against a percentage of the take-off speed, a set of curves such as Fig. 32 is obtained. As plotted in this figure, the air resistance is deducted from the propeller thrust. It might have been added to the water resistance instead. The result is the same—the accelerating force is the difference between the net thrust and water resistance.

The equation for take-off is derived from the well-known formula

$$F = m \cdot a = \frac{W}{g} \cdot a = \frac{W}{g} \cdot \frac{dV}{dt}$$

The time of take-off is expressed:

$$t = \frac{W}{g} \int_0^{v_k} \frac{1}{F} \cdot dV$$

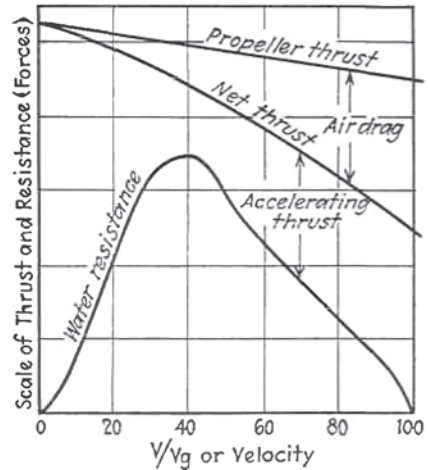

FIGURE 32. Thrust and resistance during take-off.

The distance of take-off is expressed:

$$s = \frac{W}{g} \int_0^{V_g} \frac{1}{F} V \cdot dV$$

- where F = acceleration force.
- W = seaplane weight.
- $g = 32.2$ = acceleration of gravity.
- V = velocity (subscript g refers to take-off speed).
- t = take-off time.
- s = take-off distance.

One method of calculating t is to plot $1/F$ against V between zero and take-off speed. The area under the curve multiplied by W/g gives the time of take-off (see Fig. 33a).

Likewise, by plotting V/F against V , another curve is obtained for determining the take-off distance. The area under the curve multiplied by W/g gives the take-off distance (see Fig. 33a).

Suitable scales and units are used throughout.

Another graphical method which is quite simple is based on one-half the weight's being accelerated to 32.2/2 ft. in one second by the force of acceleration. In Fig. 33b, an isosceles triangle is drawn having a base 32.2 ft. per second and $W/2$ high. Triangles are added, their sides being parallel to the sides of the first triangle drawn. These latter triangles terminate on the curves of net thrust and water resistance. The take-off time in seconds is twice the number of triangles. The take-off distance can be calculated from the mean velocities for each second.

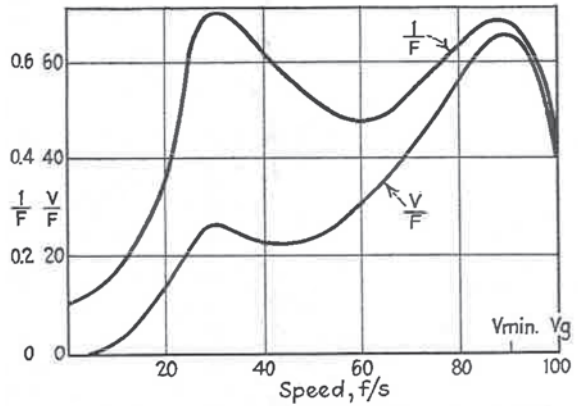

FIGURE 33A. Curves for take-off time and distance calculations.

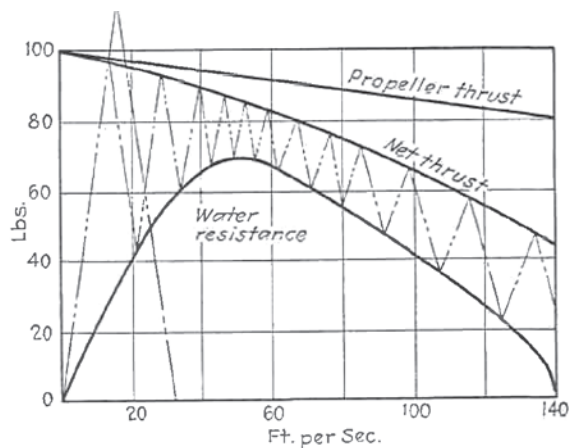

FIGURE 33B. Graphical calculation of take-off time. (Result = 22 sec.)

42. TAKE-OFF CALCULATIONS FROM COMPLETE TANK TESTS

In the previous chapter, the complete tank tests of a model was described briefly. One of the features of this type of test is that the data have general application to various sizes of seaplane (within limitations). These data can be used by applying it to a specific seaplane to determine if the float has satisfactory characteristics. Such a change in the beam dimension can change this relation by changing the resistance. The smallest beam that does not make the hump resistance too high is the best, since weight is less and drag and water resistance at higher speeds are less. Then, a suitable value of C_Δ being selected from the curves and the gross weight being known, the beam can be calculated.

The determination of the wing setting is made through knowing the desired angle of attack of the wing and the desired trim angle. The speed of the seaplane at the time that the float leaves the water in take-off should be about 110 to 115 per cent the minimum flying speed. The total resistance at this time must be near minimum. The water resistance depends on the trim angle. The best trim angle is desired so as to give the lowest resistance. The aerodynamic calculations of the lift coefficient C_L and the drag calculation are carried out in detail by Shoemaker and Parkinson in the reference. A curtailed explanation will be given here to indicate its application. Also, it shows the effect of various float features which are applicable to the general problem of take-off.

In Fig. 31 are shown typical resistance and moment curves for a model at a fixed-trim angle. Similar curves are obtained for other fixed-trim angles. Now, at each displacement and each speed there is a minimum resistance at some one trim angle. By plotting these trim angles for each displacement coefficient as ordinates and using the speed coefficient as abscissas, a set of curves results giving variation of the angle for minimum resistance with speed coefficient (see Fig. 35). Likewise, we can get curves of resistance coefficients with speed coefficients at best trim angles and curves of resistance coefficients against displacement coefficients at best trim angles. Armed with these curves, we can make various plots for comparisons.

In order to fix the float dimensions, the best beam is first determined from the resistance data and the coefficients. The ratio Δ/R plotted against the load coefficient C_Δ for various speed coefficients will give the relations desired. Two speeds are particularly interesting—that at maximum resistance and that near the take-off speed. Beam effects $C_\Delta = \Delta/w \cdot b^3$, as is evident by inspection. The effect of beam on Δ/R and finally on resistance at the various speeds can be noted from the plotted curves (see Fig. 34). If a trial calculation shows a low excess of thrust at the hump speed

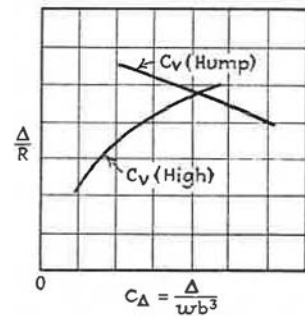

FIGURE 34. Relation Δ/R and displacement coefficient at fixed-speed coefficient.

and sufficient excess of thrust at higher speeds, or vice versa, a coefficient C_D , the water resistance curves, and the displacement, speed, and resistance coefficients give the means for the determination.

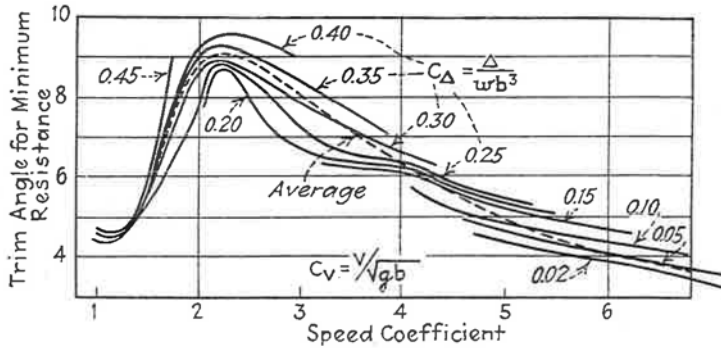

FIGURE 35. Best trim-speed curves.

The values of lift and drag coefficient are corrected

for ground effect and for the omission of the float. The minimum speed of flight being known, the take-off speed can be calculated. This gives the speed coefficient $C_v = V/\sqrt{gb}$. This permits the calculation of the lift and the drag at each of various angles of attack. The displacement at each angle of attack equals the total displacement less the lift. The water resistance at each of these displacements is taken from the curves of water resistance. The air drag is calculated for each of the angles of attack. The water resistance plus the drag gives the total resistance at each angle of attack. A curve of total resistance against angle of attack permits the choosing of the angle of attack giving the minimum resistance.

The average of minimum-resistance trim angles against speed coefficient C_v (fig. 35) gives the value of desired trim angle. The difference between angle of attack chosen above and the trim angle is the angle of wing setting.

In order to calculate for the take-off time and the take-off resistance, it is necessary to determine the resistance at each speed from rest up to the termination of the take-off. The curves of minimum-resistance trim angles against the speed coefficients C_v using the displacement coefficient C_Δ as a parameter are disposed to scatter slightly. A mean trim angle can be drawn on these curves (see Fig. 35).

Using this mean curve, at any speed coefficient C_v and consequently at any speed, we can determine the angle of attack, the lift coefficient at that angle of attack, the lift, and the displacement; thence, the displacement coefficient. The cross curve of displacement coefficient C_Δ against the resistance coefficient C_R , having the parameter of speed coefficient C_v , permits determining the

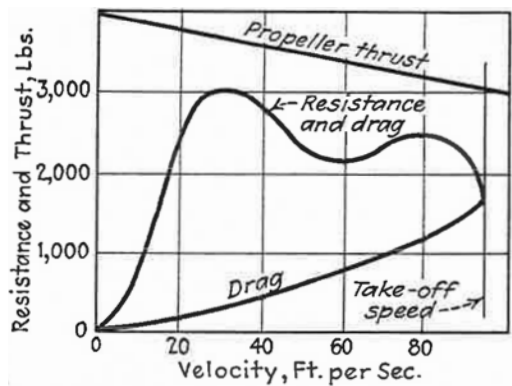

FIGURE 36. Resistance-thrust-speed curve for take-off.

resistance coefficient for the speed coefficient concerned; thence, the water resistance, the drag, and finally the total resistance. Doing this for a whole series of speeds gives the total resistance at each speed.

Now, plotting resistance and thrust against speed, we have a set of curves similar to that previously given for the take-off problem (see Fig. 36).

Here, again, $F = ma$

$$t = m \int_0^{V_g} F \cdot dV$$

t is determined by graphical means as before, and take-off distance is calculated as before.

43. TRIMMING ANGLE IN TAKE-OFF

In all recent model tests, records have been made of the angles of trim in the free-to-trim tests and of the trimming moments in the fixed-trim tests. These data are necessary to locate the position of the float relative to the c.g. of the seaplane as a whole, to locate the relative setting of the wing and the float, and to determine the effect of the elevators. The trim angle affects the water resistance of the float, particularly at the time that the float goes on the step. It has another degree of importance near the end of the take-off run. If these trimming moments are not taken into account with care in adjusting the location of the forces acting, the elevators are likely to be called upon to perform a function beyond their control.

The purpose of the stepped hull is to reduce the time of take-off and the resistance of the submerged part of the hull by lifting the hull on to the step early in the take-off run. As the seaplane is accelerated from rest, speed increases, and frictional resistance increases as the square of the speed. Frictional resistance being one-third to one-half the total water resistance, it can be seen that it would be beyond the normal power-plant thrust at about 60 per cent of the take-off speed where the lift of the wings has not yet been effective in reducing the displacement of the hull. This, of course, would ruin a good take-off, and it might make take-off practically impossible. After the float or hull has been put on the step at 35 to 40 per cent of the take-off speed, control on the trim is necessary to prevent the afterbody of the float from becoming immersed again. Immersing the afterbody increases the water resistance, and it may pull the float back into the water. It should be noted that the trim angle of least resistance just above the hump speed determines the angle of rise of the float bottom aft of the step. As speed of the seaplane increases, the float rises out of the water owing to lift, until the afterbody of the float has no chance of entering the water. From this stage up to the take-off, the water resistance is kept down by selecting the proper trim angle and reducing the area of the float in contact with the water. The frictional resistance is high at higher speeds, and any tendency to nose down increases the immersed portion of the float, and this in turn

gives a high resistance. At the finish of the take-off, all of the water forces acting are concentrated in and near the step, so that trimming moments become reduced and finally disappear altogether. The resistance of the float at the final stages of take-off acts considerably below the c.g. and tends to pull the nose of the float down.

The designer must consider all of the factors involved in order to approach a condition of moment equilibrium without being dependent upon the surface controls. The value and the location of the propeller thrust, the value of lift and the c.p. of the wings and of the horizontal tail surfaces, the weight of the seaplane and the location of the c.g., the location of the c.b. of the float, the drag of the seaplane, the water resistance of the float, the location of the step, and the trimming moment have a bearing on the moment equilibrium desired. Surface controls can be brought into action to overcome the variations encountered, and they should be limited to a few degrees; but since they are essential to capitulate with wind and sea conditions, dependence thereon should be minimized.

The location of the c.g. relative to the step of the float (usually just forward of the step) and the angle of the float relative to the wing are the factors most readily available to the designer to give variations to the moment diagram that may be desirable. Changing the step location on the float may serve. Changing the vertical distance between the c.g. and the thrust line is effective. Changes in the power and in the wing can be resorted to, but as a rule these features are fixed for other reasons, and it is not considered advisable to utilize changes therein for float performance unless it becomes absolutely necessary. There are a large number of secondary matters that ought to be taken into consideration for an accurate solution of the problems involved; for the purposes herein concerned, they are not necessary.

The procedure that appears rational, as given by Schroder in a reference, is to select an arrangement that ought to satisfy the requirements of a good take-off and establish that as the original. Model tests and take-off calculations are made for that original condition. Calculation of the effect of changes therein can then be made until the best arrangement is established. This requires an investigation of the various forces and the moments of those forces during the take-off.

The resistance and trimming moments of the float model are obtained from the basin tests. The moments due to wings and tail surfaces come from tunnel tests or by calculations. The propeller thrust at various speeds can be calculated. These moments and forces are reduced to comparative moments to suit the model size. The moments are plotted for various speeds. Comparisons can then be made directly with those produced by the float. Where these moments are the same at a given speed, equilibrium exists. These two sets of moment curves will also show the angle of trim of the float if left free to trim, and in turn the resistance in the free-to-trim condition can be recorded.

Aerodynamic computations can be made of the moments which can be produced by the elevators at the various settings. The difference between this elevator moment and that due to the combined effect of wing, tail surfaces, and propeller

thrust shows the moment available to overcome that due to the float. Inspection will reveal whether or not it is adequate for all reasonable angles of trim or for which angles of trim it is satisfactory. Forces on the tail surfaces may be downward, in which case the displacement of the float is augmented and resistance is affected accordingly. The amount is small, but it can be reckoned and the proper resistance curve used in the take-off calculation for accuracy.

Changes in the location of the c.g. relative to the float change the moments. Their effects can be calculated, and the effect on the trimming moment noted. Inspection will reveal which combination gives the best results. Similarly, it can be ascertained whether or not beneficial results are available through changes in the wing setting. The float form may be subject to alteration; for instance, a sharper V bottom tends to reduce the tail-heavy moment.

In the determination of the wing setting, it was assumed that the trim angle giving the least total resistance near take-off was the correct basis for completely satisfactory results. In an analysis made by the N.A.C.A. in a reference, it has been shown that this method of procedure gives minimum resistance at other speeds up to the 90 per cent of stalling speed. At stalling speed, the angle of wing setting can be made smaller for least resistance. In this same reference, it is shown that deviations from the best trim angle of 1° caused unfavorable effects on the accelerating force. At the end of the take-off, the trim angle should not drop so much as $\frac{1}{2}^\circ$ below the best trim angle. The effect of variations in the wing setting can be determined readily by making several take-off calculations with the wing settings chosen for a particular problem.

In the practical take-off, the pilot can, on account of the difficulties involved, only approximate the theoretical calculation. However, the theoretical fixing of the trim angle gives him a basis of selection that should result in improved take-off over that which would result without taking selected trim angles into account. So far, in this discussion of take-off, the effect of wind has been assumed to be nil. The effect

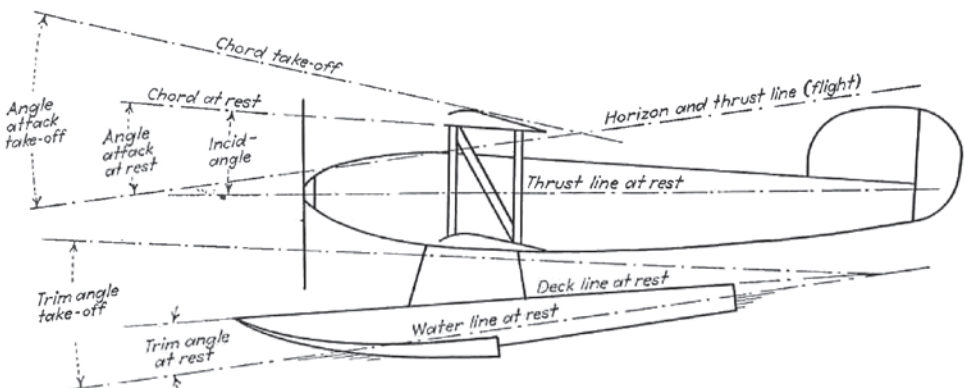

FIGURE 37. Float and wing angles at rest and at take-off.

of wind is to change the aerodynamic factors and indirectly the water resistance. The propeller thrust is a function of air speed and must be corrected for wind. The lift and drag are dependent on air speed, and the velocities used in their determination must be the air speed and not the water speed. The increase in lift due to wind reduces the displacement and also the resistance. The increase in drag effect varies with the speed. In so far as trim angle is concerned, the effect is less than 1° for winds up to about 20 m.p.h.

The attention of the reader is called to the effect of engine torque in causing listing during the take-off. In a twin-float seaplane, this may warrant special aerodynamic control during the take-off run.

The following explanation regarding the construction of Fig. 37 will give a clear understanding: Horizon and thrust line in flight are coincident with the water line at rest. This is the reference line. Angle of attack at take-off is fixed. Trim angle of float (deck line to water line) at take-off is fixed. That fixes wing angle and float angle at take-off relative to horizontal. Knowing incidence angle (between wing and thrust), we can fix thrust line at take-off. Knowledge of how float will be at rest will give deck line at rest. Thence, since wing, float, and thrust move through equal angles, they can be located in the rest attitude.

Document 5-20 (c), Marcus Langley, "Flying Boat Hull Design," chapter 5 in Seaplane Float and Hull Design (London: Sir Isaac Pitman & Sons, 1935), pp. 80-92.

The previous chapter having dealt with general principles and their application to float design, it is of interest to consider some of the particular problems of flying boat design.

NOTES ON HULL FORM

It is impossible to dogmatize about hull forms. A certain type of curve in the lines of one hull may have a different effect when associated with other lines in another hull. Some broad tendencies are, however, noticeable and these are dealt with below.

THE PROFILE SHAPE

Tests were carried out on two models at the N.A.C.A. tank, Langley Field, U.S.A., which indicated that a relatively flat forebody profile with a deep forefoot gave a better all-round water performance than the more sloping curve which was the usual American practice.

The two shapes are shown in (a) and (b), the second being the better. British designers have more generally favored the second, not only for its lower resistance

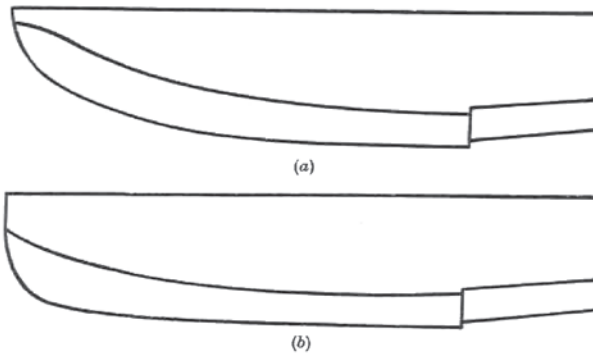

FIGURE 38. Typical forebody profiles.

but also for its much cleaner running characteristics.

The reduction in resistance is particularly noticeable at the lower hump speed, but does actually extend throughout the whole speed range. From this the American report concludes that the superior performance would allow a smaller hull to be used for the same gross weight. This

would reduce both structure weight and air drag.

The position of the main step relative to the Centre of Buoyancy has a considerable effect on the resistance, running angle, trimming moments and longitudinal dynamic stability. Comparative experiments have not been made on this specific problem. The British practice is to put the main step just at or slightly behind the C.B. In America, however, it may be about $\frac{1}{16}$ th of the hull length further back. An American test made between hulls, which were, however, not the same in other respects, showed that the one with the more forward position of step had a higher resistance and required bigger control moments to hold it to the angle of least resistance. The running angles corresponding to least resistance were similar throughout the speed range, except at the hump speed, when the British type trimmed slightly more by the stern.

Gouge has given the appropriate length of the forebody as $2\frac{3}{4}$ times the maximum beam, and the distance between main and rear steps as being the same as the forebody length. Munro makes the forebody length about $2\frac{1}{2}$ times the beam, whilst the American designers appear to use slightly more than $2\frac{3}{4}$, with however the forward C.B. position already mentioned.

The position of the C.B. relative to the step must be considered in its effect on longitudinal stability. There appears to be a range of positions for the C.B. outside which the hull will porpoise, and the British practice of putting the C.B. over the step seems in general to be sounder.

The distance between the two steps also affects the dynamic stability very considerably, and in this respect the greater distance used on British boats has given very satisfactory results.

The angle of the keel line in profile should be about 7° to the horizontal. There is considerable difference in opinion as to the best shape for the rear step. One school of thought favors the flat vertical transom (Fig. 39(a)), whilst another uses a short vertical sternpost with a pointed step (Fig. 39(b)).

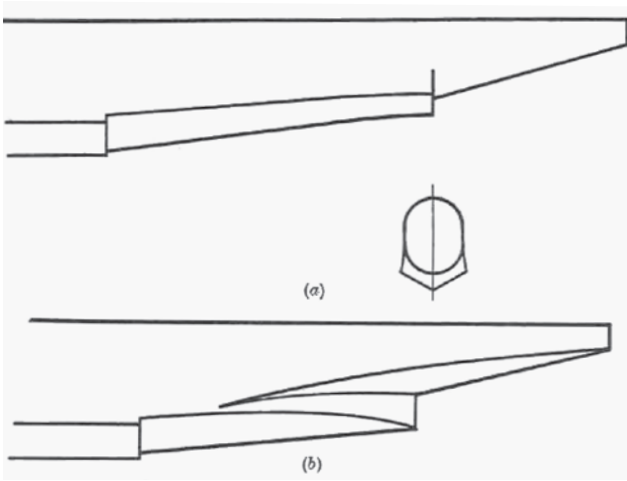

FIGURE 39. Typical rearbody profiles.

The second type may give less air drag. When, however, the main step has been made pointed in this way it has resulted in directional instability on the water, particularly at low speeds.

Behind the rear step the only function of the hull is to carry the tail unit. The keel line should rise clear of the water as quickly as possible. There is usually a

stern wave at this point which, if allowed to impinge on the rear body, will create a considerable amount of extra and unnecessary drag.

The profile shape of the upper works or deck line is of no importance hydrodynamically. The high position of the engines on a flying boat usually leads to a high position of the tail plane. Some designers have therefore made a practice of turning up the tail end of the hull. (Fig. 40.)

The dorsal line should be kept horizontal except at the forward end where it is stepped to form a windscreen of the conventional type.

Forward of the windscreen it slopes down towards the chine thus improving the pilot's view. (Fig. 41).

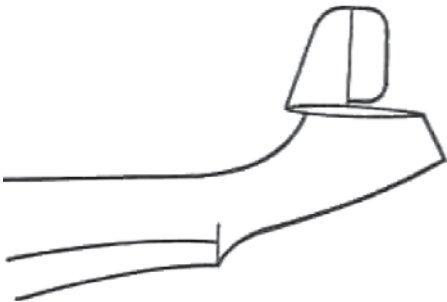

FIGURE 40. Turned-up tail end.

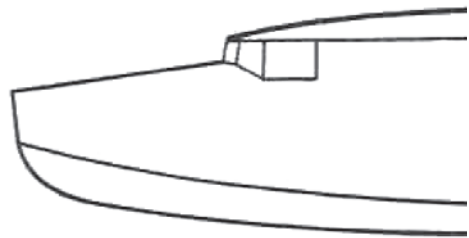

FIGURE 41. Typical fore-deck profile.

THE TRANSVERSE SHAPE.

The principal reason for the popularity of the Vee-bottom is the reduction in alighting shock which it gives. The flat bottom is thought to be more efficient hydrodynamically and the best compromise is one using a steep Vee associated with the deep forefoot, grading down to a shallow Vee of 120° to 140° at the main step.

A straight line from keel to chine is found to throw out a considerable “blister” of water. As with seaplane floats...a “flare” or curve down in the line as it approaches the chine gives cleaner running. The width of beam at the main step, the widest part of the hull, is usually taken as the datum dimension and as has been shown, the length of forebody and the distance between the steps may be expressed as multiples of this. Lower gives the width of beam for reasonable efficiency as

$$b = .36W^{1/3},$$

where W is the normal design weight of the machine in pounds, and b is the beam in feet.

The American method is to use a load coefficient $C\Delta$ such that

$$C\Delta = \frac{W}{63.4b^3}$$

The tank results may be quoted in terms of $C\Delta$ and other similar non-dimensional coefficients so that it is possible to work out the water resistance curves for different beams. The practical range of $C\Delta$ is between 0.35 and 0.50.

Tests quoted show that a wide beam will, in general, give a low resistance at the hump speed, but an excessive resistance at high water speed. A narrow beam, whilst reducing the resistance in the high speed range, will increase it at the hump speed, other dimensions bearing a constant geometrical ratio to the beam.

From the points of view of structure weight and air drag, the small hull is desirable and therefore the narrower beam should be used. A variable pitch airscrew may then be necessary to give a reasonable excess thrust at the hump speed.

The shape above the chine is largely decided by the cabin accommodation. Flat sides are desirable to prevent excessive workshop costs in panel beating. If, however, this would result in a relatively big frontal area and more cabin space than is necessary the sides may be flared out to the chine. (Fig. 42.)

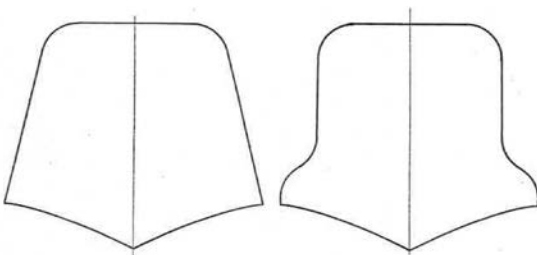

FIGURE 42. Flat side hull—Flared side hull.

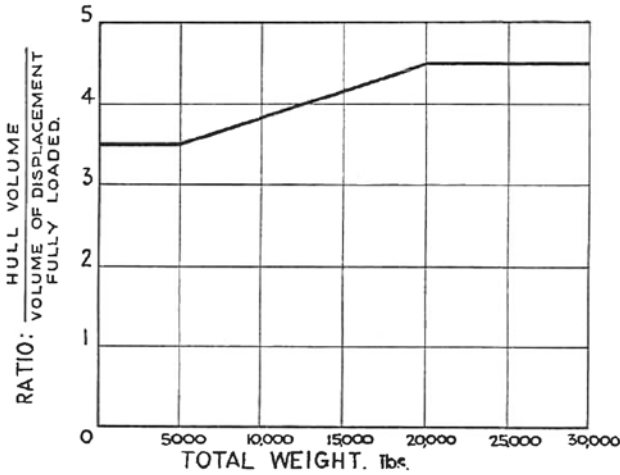

FIGURE 43. Minimum permissible ratio of hull volume to fully loaded volume of displacement.

The narrower beam will reduce the transverse stability of the boat at rest on the water. This is dealt with [later].

The Air Ministry requires that the total volume of the hull shall never be less than a certain multiple of the displaced volume. Fig. 43 illustrates this requirement which is given in A.P. 1208, "Airworthiness Handbook for Civil Aircraft," Design Leaflet H.1.

RELATIONSHIP BETWEEN AERO-STRUCTURE AND HULL.

By "Aero-structure" is meant the main planes, engines, and tail unit, which are of particular importance when the boat is in flight. They may have a great influence on the water performance and will be considered from that point of view.

An examination of the $R + D$ curve in Fig. 27 shows a pronounced second hump just below the take-off speed. If the R and D curves are taken separately it will appear that whereas the first hump is due to water resistance and shows itself in the R curve, the second hump comes from the increment in the air drag, curve D , at the higher speeds. The curves as shown are characteristic of a monoplane boat having a high wing loading. A more lightly loaded wing would lift the boat out of the water at a lower speed and the second hump would not appear, or in a much less pronounced form. But a high wing loading is desirable in a commercial flying boat. For a given power it will allow a higher cruising speed to be reached and will give a longer range and lighter structure weight for the same gross weight.

Wing flaps are useful in this case, as they will allow a higher lift to be developed, giving the same effect as a larger area of unflapped wing. The higher lift will show its benefit throughout the entire speed range in the water, reducing the draught and consequently the resistance. Flaps do, of course, increase the air drag but to a lesser degree. The alighting speed will be reduced, though perhaps at the expense of an increased vertical rate of descent, which is not of particular benefit to the planing bottom structure.

The main plane angle of incidence relative to the hull datum is of great importance. The hull datum of course varies its own angle relative to the water throughout take-off, and a typical curve for the angle of least resistance is shown in Fig 44.

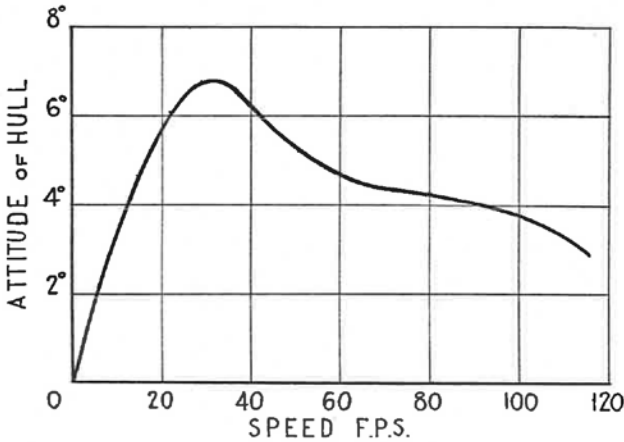

FIGURE 44. Typical curve of hull attitude against speed.

In this example it will be seen that the trimming angle of the hull settles down to about 4° as the take-off is approached. If the same procedure were followed as in the float seaplane case [...] the main plane would be set at an angle of 9° to the hull datum, so that the plane was 2° below stalling angle at the take-off. At top flying speed however when the main

plane incidence was perhaps 1° , the hull would then be 8° down by the nose. Its air drag at this attitude would be much larger than the minimum drag. On account of this loss at top speed it is now usual to put the plane at a much smaller angle relative to the hull and to get the additional lift by means of flaps.

Considering both the advantages and disadvantages of flaps, one concludes that they are of particular value on a flying boat.

The vertical position of the engines is largely determined by consideration of the propeller tip clearance above the water. The following table shows the clearances actually provided in a range of Dornier flying boats—

Type	Engines			Span		Prop. Clearance above Water	
	No.	B.H.P. of Each Unit	Wing Area (sq. ft.)	ft.	in.	ft.	in.
Libelle	1	80	167	32	2	2	4½
Do.E.	1	450	570	57	6	4	7
Wal	2	450	1026	73	9½	5	11½
Superwal	4	500	1549	93	9	7	4
Do.X.	12	500	5045	157	4	21	2

There is a temptation to put the engines high, but this would have the effect of raising the center of gravity, and the argument for using a small diameter airscrew with an ungeared engine is strong. There is even more reason for using a variable pitch airscrew on a flying boat than on a land plane. A high wing loading puts up the top speed but reduces the lift during take-off, and a relatively narrow beam and small hull has a similar and additive effect. The resistance at hump speed may be considerably greater as a result. The higher the top speed the lower will be the

efficiency of a fixed blade airscrew at the hump speed. All these conditions acting together may prevent the boat accelerating beyond the hump speed and so failing to get off, unless the pitch can be set to a low angle for low speed.

TRANSVERSE STABILITY OF A FLYING BOAT

The principles underlying the transverse stability of a flying boat at rest on the water have already been dealt with... where it was shown that $B.M. = I/V$ and that for positive stability the Centre of Gravity must be below the Metacentre. It is impossible to achieve positive stability in practice without using some auxiliary means. Owing to the super-structure weight being well above the load water line the Centre of Gravity is lifted much higher than that of the hull alone. Further, the metacentre is relatively low because of limits to the value of I , or Transverse Moment of Inertia of the load water plane. I is the function of the maximum beam at the main step, which, as was shown on page 84, has a big influence on the resistance during the take-off. A very big beam would be necessary to lift the metacentre above the Centre of Gravity. But increase in beam increases the resistance at the higher planing speeds when the thrust is falling off.

Three methods of lateral stabilization are normally used—

1. Floats mounted out along the wing on each side, one or other of which makes contact with the water when the boat is at rest. This implies a slight lolling over. (Figs. 45 and 46.)
2. Stabilizing Stubs built off the hull on each side at about mid length. (Fig. 47.)
3. Twin Hulls some distance on each side of the center line. (Fig. 48.)

Each of these methods has been used successfully, but there has been considerable discussion as to which is the best. The first two are more popular and the third is the practice of only one firm—Societa Idravolanti Alta Italia “Savoia.” Whilst the twin hull arrangement provides the necessary stability the hulls must be well spaced to avoid interference. This is liable to increase the control loads, to reduce maneuverability, and at the same time to cause heavy wracking loads across the centre section of the wing.

A comparison between wing stabilizing floats and stubs has been made by the Air Ministry. A model of a Short “Singapore I” hull was taken as being typical and the take-off was estimated from tests when

- (a) Wing Tip Floats,
- (b) Inboard Floats,
- (c) Stubs

were fitted as alternatives. The order of merit was in the same order as given above. The loss of efficiency with inboard floats was equivalent to a reduction in load of 9%, and with stubs of 17%, for a take-off time of 60 seconds in calm conditions. This loss is serious, particularly as both inboard floats and stubs are heavier than

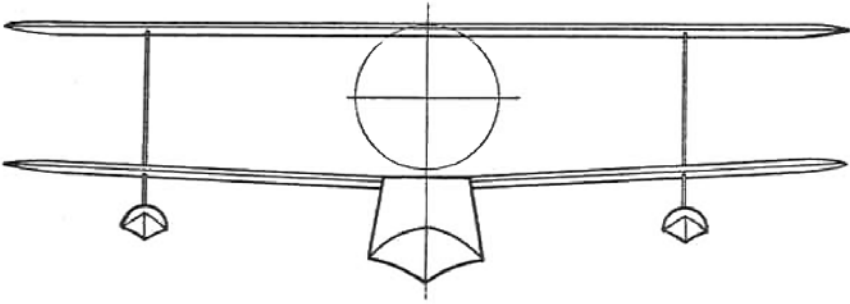

FIGURE 45. Outboard wing floats.

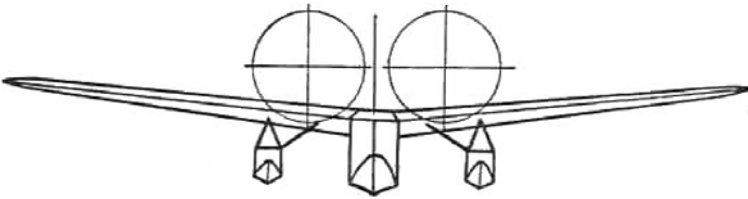

FIGURE 46. Inboard wing floats.

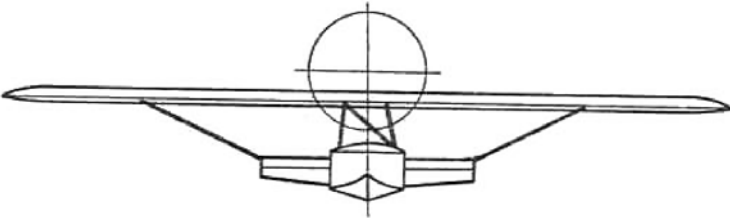

FIGURE 47. Stabilizing stubs.

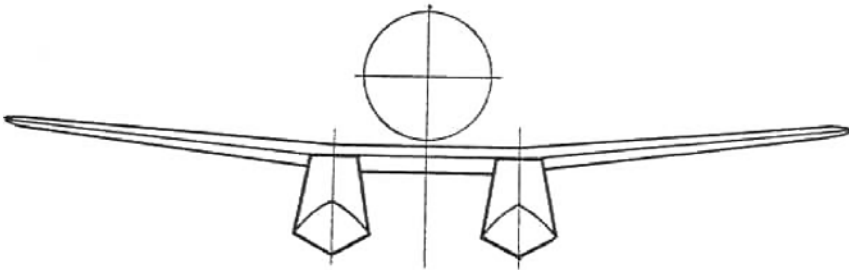

FIGURE 48. Twin hull flying boat.

wing tip floats. Stubs are claimed to give greater seaworthiness owing to the rigidity of their attachments, but the price to be paid is great.

The Air Ministry require that the buoyancy of the wing tip floats shall be such that when they are completely submerged their righting moment shall not be less than

$$RW(h + \sqrt[3]{W}) \sin \theta \text{ lb. ft.}$$

- where W = all up weight of machine in lb.
 h = negative metacentric height of hull in upright condition, in feet.
 θ = angle of heel or roll to submerge completely a wing float (if θ is less than 7° , the value $\theta = 7^\circ$ is to be used in the above formula).
 R = is a coefficient depending on the value of W , determined from the following table—

W	R
Up to 2000 lb.	.75
2000–5000 lb.	Varies linearly from .75–1.0
Above 5000 lb.	1.0

Example

A certain flying boat is of 6100 lb. all up weight. The negative G.M. of its hull equals 1.53 feet. The wing floats are 18 feet out from the center line and the angle of heel fully to submerge either is 6° . What must be the volume of each float?

- $W = 6100$
 $h = 1.53$
 $\theta = 7^\circ$
 $R = 1.0$

Minimum Righting Moment of one float

$$= 1.0 \times 6100 (1.53 + \sqrt[3]{6100} \times 0.12187$$

Minimum Displacement of one float

$$= \frac{1.0 \times 6100 (1.53 + \sqrt[3]{6100} \times 0.12187}{18}$$

= 818 lb. salt water
 = 12.8 cubic feet

The vertical position of the stabilizing floats is important. If too low they will drag in the water as the boat is accelerating; if too high they will allow the boat to roll over violently and without support for a wide range from neutral until stopped by the immersion of one float or the other. The position is usually found by assuming the boat floating at its load water line and then allowing 1° of roll either way before the keel of the wing tip float touches water.

As the boat drifts backwards there should be no tendency of the rear end of the float to dig in.

The proportions of such floats vary widely, some being short and wide, others long and narrow. The lightest float, however, for a given volume would be a sphere and although this shape is impractical it suggests that the short wide float is better. The maximum depth and breadth may be made equal to each other and each 25% of the length. If a block coefficient of 0.50 is assumed the dimensions to suit the example above would be—

$$0.5 (L \times B \times D) = \text{Volume}$$

$$0.5 (4B \times B \times B) = 12.8 \text{ ft.}^3$$

$$2B^3 = 12.8$$

$$B = (6.4)^{1/3}$$

$$= 1.857 \text{ ft.}$$

$$= 22.3 \text{ inches}$$

also

$$D = 22.3 \text{ inches}$$

$$L = 4 \times 1.857 \text{ feet}$$

$$= 7.428 \text{ feet}$$

$$= 7' 5'' \text{ (nearly).}$$

Popular shapes are shown in Fig. 49, the stepped kind being more use on large craft.

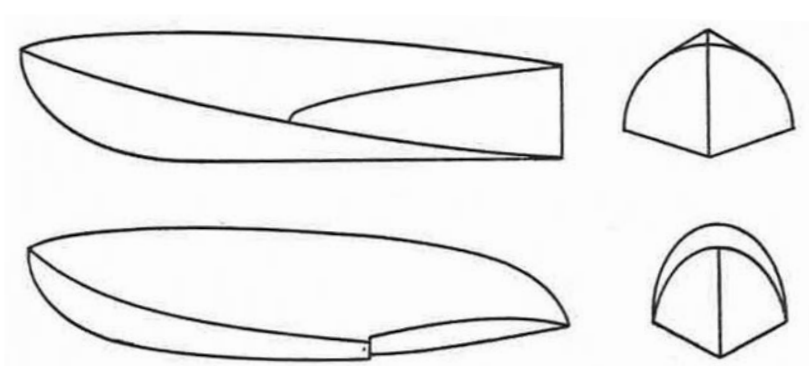

FIGURE 49. Alternative wing tip float shapes.

Document 5-21 (a–f)

- (a) H. J. E. Reid, Engineer-in-Charge, Langley Memorial Aeronautical Laboratory (LMAL), to NACA, “Extension of Work on Seaplane Floats and Flying-Boat Hulls To Include Aerodynamic Tests and Necessity for Tests and Reports on Propellers at Low Speed of Advance,” 26 September 1933, in Research Authorization file 433, NASA HRC.
- (b) G. W. Lewis to LMAL, “LMAL Letter of September 26, 1933,” 29 September 1933, Research Authorization file 433, NASA HRC.
- (c) “Outline of Purpose and Method for Conduct of Research Authorization No. 433, ‘Investigation of the Air Drag of Seaplane Floats and Flying Boat Hulls,’” 7 October 1933, Research Authorization file 433, NASA HRC.
- (d) G. W. Lewis to LMAL, “Drag of Floats and Hulls—Work of Bureau of Aeronautics in Reducing,” 10 January 1934, in Research Authorization file 433, NASA HRC.
- (e) Starr Truscott, Head Aeronautical Engineer, to Engineer-in-Charge, LMAL, “Proposed Program on Forms Suitable for the Hulls of Large, High-Speed Flying Boats—Including Both Aerodynamic and Hydrodynamic Tests To Determine the Optimum Combination of Qualities,” 8 March 1938, Research Authorization file 433, NASA HRC.
- (f) Starr Truscott, Head Aeronautical Engineer, to Engineer-in-Charge, LMAL, “Proposed Program of Research on Forms of Hulls Suitable for Use in Flying Boats of Large Size and High Speed—Conversation with Commander Diehl,” 5 May 1938, Research Authorization file 433, NASA HRC.

This string of documents concerns the genesis and conduct of NACA research authorization number 433, "Investigation of the Air Drag of Seaplane Floats and Flying Boat Hulls." The NACA Committee on Aerodynamics approved this RA on 9 October 1933 for action at Langley Memorial Aeronautical Laboratory.

Surprisingly, given how much work had been done on various types of seaplanes prior to 1933, very little published information existed on the air drag of seaplane floats and flying boat hulls. And very little had been done to correlate their aerodynamic and hydrodynamic characteristics or to find ways of reducing their drag. This situation motivated NACA researchers to instigate the special research program that became RA 433.

What made this research possible was the NACA "Tank No. 1," a unique 2,000-foot-long, 28-foot-wide, and 26-foot-high indoor seaplane towing basin built at NACA Langley between 1929 and 1931 at a cost of \$649,000. Prior to the construction of this tank, the NACA had no hydrodynamic research facility per se. Whatever research it conducted relevant to seaplanes resulted from the work done at Langley laboratory to improve wings, propellers, engine cowlings, and such for landplanes, which could then be extrapolated for the design of seaplanes. But by the late 1920s, the NACA staff realized, in large part because of its close working relationship with the Navy Bureau of Aeronautics, that airplanes operating on or from water posed a number of major problems not shared by the landplane. In this big water tank, which would be lengthened to 2,900 feet in 1937, NACA researchers would come to study the design characteristics of most American seaplanes built in the 1930s and 1940s—and nearly all of the U.S. Navy flying boats that would be used for air-sea rescue, antisubmarine patrol, and troop transport in World War II. Data gained from this facility contributed also to the development of the famous Clipper flying boats (see Document 5-23), the romantic ocean-hoppers that before World War II trailblazed air routes and carried hundreds of paying passengers over the oceans of the world.

In 1942, the NACA built a second, shorter (1,800-foot-long) tank adjacent to the first at Langley and updated the auxiliary equipment that went with Tank No. 1. Both tanks were equipped with an overhead electric carriage from which a dynamic model could be suspended and towed at up to 80 miles per hour, which was sufficient to make a model take off from the water and fly at scale speed. As the model was moving along the surface, researchers took motion pictures and recorded measurements demonstrating the aircraft's stability, controllability, water resistance, drag, and spray characteristics. The tanks were equipped with catapult devices, for the study of the free-launched landing characteristics of airplanes, and with mechanical wave-makers, for the simulation of takeoff and landing in rough water. In Tank No. 2, Langley engineers also discovered ways to ease the shock on a landplane when crash-landing or ditching in the water. More information about the NACA's towing tanks will be presented in Document 5-26.

Document 5-21 (a), H. J. E. Reid, Engineer-in-Charge, Langley Memorial Aeronautical Laboratory, to NACA, "Extension of Work on Seaplane Floats and Flying-Boat Hulls To Include Aerodynamic Tests and Necessity for Tests and Reports on Propellers at Low Speed of Advance," 26 September 1933.

Langley Field, Va.,
September 26, 1933.
From LMAL
To NACA

Subject: Extension of work on seaplane floats and flying boat hulls to include aerodynamic test and necessity for tests and reports on propellers at low speeds of advance.

1. A regular suggestion of persons interested in the construction of seaplanes and flying boats who have visited the N.A.C.A. tank is that tests should be made to determine the air drag of the various types of floats and hulls. It has always been explained to them that such tests were contemplated and would be made in due time. It is believed that such tests should now be undertaken as a part of the program for obtaining information regarding the characteristics of floats and hulls. It is possible that insignificant changes, from the aerodynamic standpoint, may have large effects on the hydrodynamic properties, and vice versa. The effects of such changes certainly should be investigated before the work on any type of hull can be considered to be complete.
2. Two methods of investigation suggest themselves: the first, the testing of the models used in the N.A.C.A. tank in a wind tunnel; and the second, the testing of small, new models in the variable-density tunnel. The first would have the advantage that existing models could be used, but the proper Reynolds Numbers probably could not be reached. The second would require the making of new models but would make possible a more perfect approach to the full-size Reynolds Numbers.
3. Testing of the floats or hulls alone would, of course, give no indication of the effect of interference between wing and hull. For flying-boat hulls it might be possible to devise a sort of "standard" wing which might be fitted to each hull in turn and thus give the effect of interference between each hull and the same wing arrangement. In the case of seaplanes the floats are so much smaller relative to the body and wings, and also so much further away, that in the case of the two floats now available the effect of interference might well be neglected.
4. In the course of the aerodynamic tests proposed, the air drag and moments in pitch and yaw for the bare hull and hull and wings would be determined. It probably would not be necessary to carry measurements in yaw up to

beyond 5°. Possibly yaw measurements would not be needed at all for the hulls of flying boats, but they would surely be of value in the case of sea-plane floats.

5. The effect of changes in depth and plan form of the steps should be investigated. This can be done using the large separable models from the tank. Just what it would mean in the way of new models for the variable-density tunnel might be determined after tests of the larger models. It might develop that there is a range of depth of step which would be less resistant aerodynamically than others. The hydrodynamic application of these could then be investigated. This would give better criteria for the proper depth of the step than any now available.
6. Much is made in British literature of the "fairing" of the after step by Short Brothers. How real a gain this gives could be determined by fitting fillets of different form in the wind-tunnel tests and checking the least resistant of these in a tank for their hydrodynamic effect.
7. Aerodynamic tests of Models Nos. 2 and 6 (both floats for high-speed seaplanes) are especially desired. The former is of the Macchi racer float and the latter a design prepared by the N.A.C.A. tank that has a radically different distribution of the volume. Hydrodynamically, it is considerably better than the Macchi float. It would be of value to know how it rates aerodynamically.
8. A second group of aerodynamic investigations might well center on the stub wing or sponson. The use of this type of stabilization by the Glenn L. Martin Company, and the confidence which they express in the success of their application, which seems to be justified by their reports, would indicate that more general information regarding it will be worth while. If the large Pan American boat proves a success, and especially if it out-does the Sikorsky, we may expect to be deluged with requests for information on this type of stabilizer.
9. The making of a series of tests in the N.A.C.A. tank on models using this type of stabilizer has been on our program for some time.
10. A third group of aerodynamic investigations has been assuming increasing importance as our work on the "family" of models and its derivatives has proceeded. This is the problem of the thrust of propellers at low speeds of advance. The propeller research tunnel has some data on this point but it has not been published. It relates mostly to the more usual type of 2-bladed propellers, and, as the application of the data was not foreseen at the time it was being obtained, it does not completely cover the range in which it is desired.
11. It is believed that the data now available should be prepared and published as soon as practicable, and that additional data should be secured from further tests to complete it. These should include tests of 3-bladed propellers,

both direct driven and geared. The latter are particularly important for flying boats.

12. Supplementing the fixed-pitch propellers, tests of variable-pitch propellers, as actually built[,] would be of great interest.
13. The whole of this work on propellers is intended to make the study of the take-off of flying boats easier and the prediction of performance during take-off more accurate. It is known that it will be appreciated by designers; if available, it would help in the study of performance.
14. The Research Authorizations, Nos. 376 and 388, under which the work in the tank on seaplane floats and flying-boat hulls is being carried on, do not specifically cover the making of the aerodynamic tests which have been discussed. It is believed that they should be modified to include this work. The information regarding a given hull or certain general features will then be complete with the reciprocal effects of changes known.
15. Information is requested as to whether the existing Research Authorization 376 and 388 can be interpreted as covering the aerodynamic tests, or whether requests for suitable modification should be prepared. It is believed that the propeller tests are included in existing Research Authorization No. 199.

H. J. E. Reid,
Engineer-in-Charge.

*Document 5-21 (b), G. W. Lewis to LMAL, "LMAL Letter
of September 26, 1933," 29 September 1933.*

Washington, D.C.
September 29, 1933.
From NACA
To LMAL

Subject: Extension of work on seaplane floats and flying boat hulls to include aerodynamic tests and necessity for tests and reports on propellers at low speeds of advance.

Reference: LMAL letter of September 26, 1933, ST. DW.

1. In my opinion, it is desirable that the subject of aerodynamic tests of seaplane floats and flying boat hulls be discussed at the forthcoming meeting of the Aerodynamics Committee on October 9. At this meeting requests will be made for approval of a new research authorization covering such investigations.
2. It is requested that Mr. Truscott attend this meeting and present the subject matter of letter of reference together with a draft of a research authorization.

It would also be desirable for Mr. Truscott to present a progress report at this meeting.

G. W. Lewis,
Director of Aeronautical Research.

Document 5-21 (c), "Outline of Purpose and Method for Conduct of Research Authorization No. 433, 'Investigation of the Air Drag of Seaplane Floats and Flying Boat Hulls,'" 7 October 1933.

Purpose. To obtain information as to the air drag of seaplane floats and flying boat hulls, models of which have been tested in the N.A.C.A. Tank, and to provide information as to the effect on the air drag of various departures from the more common forms.

Among the reasons for this investigation are:

1. There is an almost total lack of published information on the air drag of seaplane floats and flying boat hulls, especially of recent forms, and none of what does exist was obtained from tests of large models such as are now available.
2. Very little has been done to reduce the air drag of such hulls by suitable minor changes in the form of the bottom. Short Brothers' "fairing" of the after step is advertised widely, but what could be done on American hulls appears to be unknown.
3. So far as is known, there has been no previous attempt at the correlation of the air and water characteristics of seaplane floats and hulls.

Method. Models of seaplane floats and hulls which have been tested in the N.A.C.A. Tank will be fitted with the additional structure to give them the form actually used in the full-size craft. The air drag and pitching moments of these models will be determined in the propeller research tunnel. Modifications of the underwater form which will reduce the drag will be made and tested. If a material reduction in drag is obtained, the model will be again referred to the N.A.C.A. Tank for further tests to determine the effect of the changes on the water performance. Eventually a hull with low air drag and good water performance should be obtained. The results will be correlated and reported on as developments warrant.

*Document 5-21 (d), G. W. Lewis to LMAL, "Drag of Floats and Hulls—
Work of Bureau of Aeronautics in Reducing," 10 January 1934.*

Washington, D.C.
January 10, 1934
From NACA
To LMAL

Subject: Drag of floats and hulls—work of Bureau of Aeronautics in reducing.

Reference: LMAL let. Jan. 2, 1934, ST. IT.

1. The Bureau of Aeronautics has not made any investigation to reduce the air drag of flying boat hulls and seaplane floats except what has been published in Commander Diehl's book, "Engineering Aerodynamics." The only work approaching it in nature was done with a PD-1 on the west coast to note the difference in performance by fairing such items as the hand-hole covers and anchor.

G. W. Lewis,
Director of Aeronautical Research

Document 5-21 (e), Starr Truscott, Head Aeronautical Engineer, to Engineer-in-Charge, LMAL, "Proposed Program on Forms Suitable for the Hulls of Large, High-Speed Flying Boats—Including Both Aerodynamic and Hydrodynamic Tests To Determine the Optimum Combination of Qualities," 8 March 1938.

Langley Field, Virginia.
March 8, 1938.
MEMORANDUM for Engineer-in-Charge.

Subject: Proposed program of research on forms suitable for the hulls of large, high-speed flying boats—including both aerodynamic and hydrodynamic tests to determine the optimum combination of qualities.

1. At various times opportunity has been taken to have the models of the hulls of flying boats and seaplane floats that have been tested in the N.A.C.A. tank tested in one of the wind tunnels to determine the aerodynamic drag and how it varied with pitch. A prime reason for this work was that all aerodynamic tests of hull forms that had been made previously were of considerable age and made on small models. The first series of tests was issued as N.A.C.A. Technical Note No. 525 and a report on a second large series is in progress.

2. It became evident some time ago that the size and speed of flying boats was on the verge of a great increase. At the high speeds that were contemplated the smallest departures from a form of minimum air drag would cause much larger increases in resistance than had been experienced in the past, and it was going to be of the greatest importance that whatever form of hull was adopted should depart from the form of minimum air drag by the smallest possible amount.
3. Unfortunately the form of minimum air drag is absolutely impossible from the hydrodynamic viewpoint and each improvement in hydrodynamic qualities promised to injure the aerodynamic qualities. It appeared desirable to see what could be done in the way of devising a form of hull that would have reasonably good hydrodynamic qualities and yet have a low air drag. Two such forms were designed and tested and were found to have answered the requirements laid down for them quite well. A report on tests of these models (N.A.C.A. models Nos. 74 and 75) is in preparation.
4. These tests only emphasized, however, the need for more complete information (1) as to the manner in which the air drag of a form increased as the transition from a streamline body to a boat hull took place and (2) as to the manner in which the water performance changed during the transition. In other words it was high time we learned just how much had to be paid in the form of increased drag of the hull for each of the features of form that made it suitable for use as a hull for a flying boat.
5. The proper procedure seemed to be to select a good streamline form of low aerodynamic drag and by successive modifications change it into a good boat hull making tests of each modification in both wind tunnel and tank. There appeared to be no use in testing those modifications that had no chine or step in the tank; wind tunnel tests should be made—to give what might be called zero readings.
6. The program should include the effect of various depths of step and angle of afterbody keel. It should also include the effect of changes in dead-rise and in length-beam ratio. To begin with all these changes were left out and a program was prepared based on a single streamline form and one angle of dead-rise. The streamline form was distorted longitudinally by curving the axis and vertically by adding parallel sides at the half height. The purpose of these modifications was to determine the effects, on a form without other aerodynamic disturbers, of radical changes such as would be included in a flying boat hull.
7. Certain of the forms obtained in the previous stage would be fitted with chines and step—there seemed no purpose of trying to put the one on and not the other. The chines would follow diagonal planes as nearly as was feasible. These models would be tested in wind tunnel and tank.

8. From experience the bows of the forms of the previous stage probably would have poor seagoing qualities so at least two forebodies should be made with bows more suited to actual service.
9. A large part of the aerodynamic drag of a hull is generated at the bow. Chines at that point must help to increase the drag. Accordingly, the chines should be removed from two or more models at the bow to determine how the aerodynamic drag was affected.
10. In the next stage the chines on the models should be changed successively from sharp angles to large radii and the effects of these changes on air drag and water performance should be determined.
11. Although no facilities now exist in the N.A.C.A. tank for testing in waves, all the models of the foregoing stages should be tested in waves—either in the tank or by towing from a launch—to observe their performance in rough water.
12. The foregoing program has been put in the form of a diagram, a copy of which is enclosed. As will be seen there have been many combinations omitted that might well be tried but it was decided to make the work to be done rather exploratory than complete because of the cost of the models and the length of time required for making the tests and working up the results. The representatives of the respective modifications were selected with a view to suitability in actual practice. This influence also caused the selection of the 20 degree dead rise.
13. It will be noted [that] the changes in angle of afterbody keel and in depth of step have been added, one case of each. These changes are proposed in a form that it is felt might be benefited by such changes.
14. Another addition is that of a chine on the tail extension of one model. This has been added because in many cases the smooth round tail extension seems to increase water resistance if it once gets wet, and it will be of value to learn how much the chine would cost in added drag, if any.
15. The last column on the chart shows two models on which the vee at the keel is successively cut away as a flat. These tests have been included because we have heard that violent yawing sometimes occurs on landing. A probable reason was that although landing into the wind there were heavy cross currents in the water. A sharp edge at the keel would produce cross flows with heavy eddies and yawing forces of considerable magnitude. “Braking” the sharp vee might reduce these cross eddies and the yawing forces. Another reason for this modification is that in very large craft the natural tendency would be to follow ship practice and make the keel a plate instead of the extruded sections or angles used in smaller craft. If a flat can be used on the bottom of the keel without injury to air or water characteristics it should be helpful to the designer.

16. It should be emphasized that a program, such as is described here and is shown on the chart, must be flexible and subject to addition or omission. Actual tests may show some combinations better and others worse and suggest other combinations. The chart is for 20° dead rise only. Another chart with most of the hulls might be prepared for 15° and another for 25°. Such tests would undoubtedly be profitable. In like manner charts for forms based on other ratios of length to diameter would give programs of value. It is believed however that it is desirable to start with combinations that have been found to work and extend as a result of experience. The streamline form used in the present case was used for models 74 and 75 and they have shown remarkably low air drag combined with reasonably good water performance.
17. As will be inferred, it is proposed to make the models sectional so that tops and bottoms of like curvature may be exchanged and forebodies and afterbodies may be combined in different manners. Construction plans showing these features are now in progress and will be completed shortly. Lines for several of the forms have been prepared and the rest will be completed as rapidly as is feasible.
18. The program outlined is not intended to be complete, as has been stated, but it is believed it is sufficient in its present form to justify the expediting of work on the preparation of models for the part that is reasonably complete and the making of the tests at as early a date as feasible.

Starr Truscott.

*Document 5-21 (f), Starr Truscott, Head Aeronautical Engineer,
to Engineer-in-Charge, LMAL, "Proposed Program of Research on
Forms of Hulls Suitable for Use in Flying Boats of Large Size and High
Speed—Conversation with Commander Diehl," 5 May 1938.*

Langley Field, Va.

May 5, 1938

MEMORANDUM For Engineer-in-Charge.

Subject: Proposed Program of Research on Forms of Hulls suitable for use in Flying Boats of large size and high speed—Conversation with Commander Diehl.

1. On Monday, May 2, I had an opportunity to talk to Commander Diehl regarding the subject program. As a result of this discussion, I came to the conclusion that he does not approve of the program, but I also concluded that this attitude may be explained by the fact that either he does not perceive the purpose of the program, or he does not agree with that purpose. In the very beginning of the discussion Commander Diehl said he thought we were starting from the wrong end; we should first develop a good form of hull—one with a good bottom form, and then fit that to various forms of upper works for the purpose of reducing the air drag. In reply to the argument that the very best form of bottom probably would have fairly high air drag, he replied that it was not necessarily true; the PBY's were making 280 m.p.h. and that did not indicate a high air drag. In reply to the argument that we should attempt to do more than just fair and should try to make the air drag approach as nearly as possible that of a streamlined body, he remarked that the Bureau had tried a similar program that had not been successful. There were already aerodynamic tests of hulls and airship forms. When the point was made that our program had tried to take account of the fact that hulls could not always be circular, or even approximately so, in section he replied that we had to remember that a wing had to be attached to the hull. The argument that the interference effect of a wing and hull would be pretty much the same whatever the shape of the lower part of the hull, if the top of the hull and the structure joining wing and hull was the same in each case, brought the reply that my logic was defective. After one or two more attempts to put forward arguments and their demolishing in a similar manner, I gave up.
2. It is my opinion that Commander Diehl has not considered the proposed program as one intended to provide data for use in designs to be built 5 or 10 years from now, but as one intended to develop as quickly as possible a form suited to his present needs and having a good water performance with a reasonable low air drag. This attitude is diametrically opposed to the precept under which the subject program was prepared, which was to

anticipate the probable future needs of the builders of large high speed flying boats for fundamental information as to the effect of various changes in form on the aerodynamic and hydrodynamic properties of the hulls of such craft. I still believe the subject program is the better method of obtaining that information.

3. In order, however, to obtain the support of the Bureau for at least a part of the program a sort of compromise is possible. We could accept the form selected by Commander Diehl as most suitable for the large flying boats now under consideration as meeting his requirement of a good form, and proceed from that as he suggests, but incorporating in the alterations to the model the same changes as we have in our program. I believe we could fit one of our axis curves to the model—or a variation of it—and eventually connect the two series directly.
4. It is my opinion, however, that we should carry our own program from its beginning as we have planned until the two meet and blend.

Starr Truscott,
Head Aeronautical Engineer.

Document 5-22 (a–h)

Excerpts from *Annual Report of the National Advisory Committee for Aeronautics* (Washington, DC), 1933–40.

- (a) “Seaplanes,” *Annual Report* (1933), pp. 15–16.
- (b) “Seaplanes,” *Annual Report* (1934), pp. 20–22.
- (c) “Subcommittee on Seaplanes,” *Annual Report* (1935), pp. 20–21.
- (d) “Subcommittee on Seaplanes,” *Annual Report* (1936), pp. 19–20.
- (e) “Subcommittee on Seaplanes,” *Annual Report* (1937), pp. 22–23.
- (f) “Subcommittee on Seaplanes,” *Annual Report* (1938), pp. 20–22.
- (g) “Subcommittee on Seaplanes,” *Annual Report* (1939), pp. 19–21.
- (h) “Subcommittee on Seaplanes,” *Annual Report* (1940), pp. 10–11.

It is interesting that it took until 1935 for the NACA to create a Subcommittee on Seaplanes, given the importance of floatplanes and flying boats well before that time. The first person to head this group was Bureau of Aeronautics Captain Holden C. “Dick” Richardson, who chaired it on two different occasions, from 1935 to 1937 and again from 1941 to 1945. A 1907 recipient of a master’s degree in engineering from MIT, Richardson was one of the NACA’s original members. Having honed his skills in the fields of hydrodynamics and aerodynamics at the Philadelphia and Washington Navy yards (at the latter working with Captains David W. Taylor and Washington I. Chambers on the wind tunnel in the experimental model basin), Richardson became one of the Navy’s leading aircraft designers. Flying boats were his expertise. Along with Dr. Jerome C. Hunsaker, who chaired the NACA’s Subcommittee on Seaplanes from 1938 to 1940, and Captain George C. Westervelt, Richardson was one of the designers of the Navy’s famous NC-4 (NC for Navy-Curtiss) flying boats, a 25,000-pound aircraft that successfully flew

the Atlantic in 1919. In the mid-1920s, as head of the design section of the Navy's Bureau of Aeronautics' materiel division, he was one of the Navy leaders working hardest to bring about the design of metal flying boats, notably the PN class.

In *Model Research*, historian Alex Roland found it worth noting that the NACA populated this particular subcommittee "with government members under the chairmanship of a naval officer." Roland's point was that the NACA's emphasis, typically, was on military applications rather than commercial potential. But one can hardly question the choice of Richardson and Hunsaker to head this subcommittee, given that no one in the United States knew more about seaplanes than these two men. Hunsaker was a formal naval officer, but he had gone on to a prestigious career in academe as professor and head of the mechanical engineering department at MIT. Moreover, the third chair of the subcommittee, from 1946 to 1952, was Grover C. Loening, a flying boat manufacturer with many diverse commercial interests. Ernest G. Stout, the next subcommittee chair, from 1953 to 1955, designed flying boats for Consolidated Aircraft Corporation. Neither Loening or Stout ever served in the Navy. In the same year Stout started chairing this subcommittee, the Institute of the Aeronautical Sciences presented him with its Sylvanus Albert Reed Award "for contributions to the design and development of high-speed, water-based aircraft." The professional situation of Robert S. Hatcher, who presided over the group from 1956 to the end of the NACA in 1958, is not known.

It is clear from the following items on seaplanes in the NACA annual reports from 1933 to 1940 that military applications were critically important but that commercial potential was also important to, and being addressed by, the NACA.

*Document 5-22 (a), Excerpts from Annual Report of the National Advisory Committee for Aeronautics (Washington, DC, 1933-40).
"Seaplanes," Annual Report (1933), pp. 15-16.*

A description of the National Advisory Committee for Aeronautics tank, or seaplane channel, has been prepared and issued as Technical Report No. 470. Reference is made in the report to the important items of equipment and the satisfactory behavior of the rubber tires, the towing carriage, and the towing gear. The research program has followed quite closely the program outlined in last year's report. Although emphasis has been placed on investigations which have immediate application, the addition of wave suppressers [*sic*] has greatly expedited the carrying out of the research program.

Effects of variation in dimensions and form of hull on take-off of flying boats.—The effects of variation in dimensions are being studied by tests of a series of five models derived from a parent form by systematic variations in dimensions. The five models were investigated according to the general method in which the resistance, rise, and trimming moment of the model are determined at various fixed trims over a range of speeds. The results show that the performance of the parent model

could be improved by changing its form to give a longer and flatter forebody. A new forebody was made and tested with the original afterbody, and the improved model equals in performance the best flying-boat hull. Tests of two models, nos. 11 and 11A, are described in Technical Notes Nos. 464 and 470.

Observation of the behavior of the models of hulls tested suggested the possibility of improving performance by a radical change in the form of the main step. A model was prepared in which the step was much deeper than usual and was pointed in plan form instead of square across the hull. This model, no. 22, showed a general performance much superior to the previous model. These results will be issued as a technical note and it is hoped that a full-scale test of this form may be made to determine its behavior under operating conditions.

A model of a flying boat hull having one form of stub wings or sponsons to provide lateral stability was investigated. Other forms of sponsons have been made for tests with the same main hull, and in view of the later development of this type of lateral stabilization, it is planned to extend the application of hulls of other shapes.

Floats for seaplanes.—In order to obtain information regarding the performance of a good high-speed seaplane float, tests were made of a model of a float used on the Macchi racer 1926. As a result of the tests a float designed to be an improvement of this float and to be used as a parent of future series was tested. This model showed a marked improvement over the Macchi float. The results of the two tests are compared in Technical Note No. 473.

Fundamental information regarding planing surfaces.—For a large part of the take-off run of the seaplane, that part of the weight of the craft not supported by the wings is supported by the hydrodynamic reaction of the water on the bottom of the float or boat. By testing surfaces that skim along the top of the water simulating only the bottom of a float, much valuable fundamental information can be obtained. A series of tests of planing surfaces consisting of flat surfaces at 0°, 10°, 20°, and 30° dihedral has been completed, and the results are being prepared for issue as a technical note. A series of somewhat similar models consisting of two surfaces with transverse curvature set at various dihedrals is being constructed for use in further tests. It is also planned to test surfaces with fore and aft curvature at a later date.

The results of the tests of these models may make possible the separation of the pure planing phenomena from the other factors encountered in tests of complete models and thus give valuable clues as to the proper form of bottoms.

Frictional resistance of boat surfaces.—Frictional resistance of those surfaces of a boat hull which are exposed to the passing water has not been determined for speeds from 30 to 60 miles per hour. The surfaces for a series of tests of frictional resistance, with their supporting gear, are completed, and the surfaces for another series nearly ready for investigation.

Specific tests for Government agencies.—A number of investigations specifically requested by the Bureau of Aeronautics have been conducted. An investigation of

methods for the control of spray was made on a model of a Navy flying boat. It was found that the addition of spray strips gave some improvement, but in this particular case not as much as was desired.

At the request of the Army Air Corps, extensive tests were made of models of the hull of an amphibian flying boat to obtain information as to the water performance of the craft with various modifications.

Document 5-22 (b), Excerpts from Annual Report of the National Advisory Committee for Aeronautics (Washington, DC, 1933-40). "Seaplanes," Annual Report (1934), pp. 20-22.

The quantity of work that can be done in a model basin is determined in part by the time required for the waves produced during one test run to become so small that they will not affect the performance of the model during the next test run. A new type of wave suppresser [*sic*] has been developed in the N.A.C.A. tank for the purpose of reducing the size of the waves with a maximum of rapidity. It consists of a series of narrow frames covered with fine-mesh screen and placed along the side of the tank with the screen horizontal and about 1 inch under water. A set of these wave suppressers [*sic*] about 24 feet long is now located every 50 feet on both sides of the tank. They have proved so effective that the limit on the number of runs that can be made in a day is now set by the speed with which the towing carriage can be returned to begin the succeeding run.

In most ship-model towing basins the models are made of wax, usually paraffin wax with some hardener such as beeswax or carnauba wax. The wax models are shaped with the aid of a machine that cuts guide lines in the block and the time and cost of making models are much less than for wooden models made with templates in the usual manner. The high temperatures prevailing at Langley Field during much of the year made it impracticable to use paraffin wax for models, and a search was therefore made for a suitable wax that would retain its form in hot weather. An experimental model has been made of a wax that melts at 270° Fahrenheit and that appears otherwise suitable. This model has been tested in the tank and by exposure to the heat of the sun in the shop and has retained its form about as well as a wooden model.

In order to take full advantage of the savings that may result, a model-cutting machine is being designed for use in making both wax and wooden models.

Effect of variation in dimensions and form of hull on take-off of flying boats.—Reduction in the water resistance of flying-boat hulls will always be a principal subject of investigation, for a reduction in water resistance at a given gross load means that the maximum gross load with which the machine can take off will be increased and the increase in gross load may be utilized by the operator as increased pay load, increased range, or otherwise, as he desires. For the purpose of finding the effect of systematic changes in the form and proportion of the hulls of flying boats

on the water resistance and general performance, a series of models has been tested in the N.A.C.A. tank, the members of which have been derived from a parent form by a process of proportional extension and contraction in both longitudinal and transverse directions. A first result of these tests, as was mentioned last year, was the deriving of a form (Model 11-A) that was a considerable improvement over the parent form.

Analysis of the completed tests showed that the method of deriving the forms was not entirely suitable for use with models of flying-boat hulls. Such craft do not have a constant displacement, or weight on the water, as do surface craft. Instead it varies continuously with the speed and is radically affected by the form and dimensions of the bottom below the chines. Hence the effects of changes in any one dimension were obscured by the effects of other changes. This conclusion had been anticipated somewhat and the investigation was in effect conducted to find what could be done by the method used. Among other things, the results showed that increasing the dimensions of a hull for a given design load led to a decrease in resistance at hump speed and increases in the resistance at speeds near get-away. A further conclusion immediately applied to designs for new models, as in Model 11-A, was that fore-and-aft curvature of the bottom of the forebody, as frequently found in earlier designs, led to increased water resistance, and that the keel line and bottom should be carried as far forward of the step in a straight line as other conditions of the design made feasible. This work is reported in Technical Note No. 491.

Model no. 22, the first with a pointed main step, had shown a gratifying reduction in water resistance over the more usual form, but when its performance was examined in the light of the results from the tests referred to above, it was concluded that increasing the length of the straight forebody would improve the performance. A new model (no. 22-A) incorporating this change was made, together with another (no. 35) having a still greater length-beam ratio, to represent a possible application of the type as a seaplane float. Both models showed consistently lower resistances for all conditions than conventional forms, especially at the hump speeds. When used in take-off computations for a typical design having a gross load of 15,000 pounds, two engines totaling 1,000 horsepower, and a wing area of 1,000 square feet, a reduction in take-off time and run of 4.5 seconds and 490 feet was obtained with model 22-A, and of 6.5 seconds and 550 feet with model 35. This work is reported in Technical Note No. 504.

Take-off tests of the Navy P3M-1 flying boat had shown that large quantities of spray were thrown while taking off and landing, and that the propellers suffered erosion from the spray that they encountered. A model of the hull and side floats of this craft was tested with and without several types of spray strips, but not enough to overcome the handicap produced by the engines being set too low. However, it was concluded that spray strips could be used quite effectively to reduce the spray thrown by a hull with floats set quite close to it. This work is reported in Technical Note No. 482.

A more extensive and more general series of tests to determine the effect of spray strips on the take-off performance of a flying boat was made with the model of the hull of the Navy PH-1 flying boat (model no. 1) and is described in Technical Report No. 503. Spray strips were fitted along the chine in four different widths and at three different angles at the step for each width. In the neighborhood of the hump speed the general effect of the spray strips was to reduce the resistance, the widest strip (3 percent of beam) giving the greatest reduction. The resistance at the higher speeds nearing get-away seemed to be practically unaffected by the spray strips. A notable effect was the reduction in the trimming movements in the region of the hump, which promised to make the aerodynamic controls effective at lower speeds. The reduction in spray thrown seemed to parallel the reduction in resistance, but a downward angle of 30° to 45° at the step seemed to give the best results.

The desirability of holding a seaplane during take-off to the best trim angle—those that give minimum resistance—has been generally recognized, but accurate quantitative data on the effect of deviations from that angle have been lacking, nor has it generally been possible to define the angle throughout the run from the tests usually made. The general method of testing models as used in the N.A.C.A. tank makes it possible to determine the best angle for water resistance throughout the entire run. From the data obtained in tests of models nos. 11-A, 16, and 22, a study was made of the effects of trim angle on the take-off performance of flying boats. The trim angle giving lowest water resistance was found to give lowest air resistance also, and hence lowest total resistance. Deviations from best angle of more than 1° in the region of low excess thrust (hump speed) and more than 2° to 3° during the remainder of the take-off run will produce increases in the time and distance required.

In the report on this work (Technical Note No. 486) a simple instrument is described which will indicate the trim, so that if the pilot of a seaplane desires, he may control the trim to those angles that have been found by tank tests of a model to give minimum resistance for each speed and thus may obtain the quickest take-off. Hydrovanes, fitted either below or at the sides of a hull of reduced dimensions, have been proposed by many as a substitute for a hull with the usual planing bottom and have been applied in practice on seaplane floats by Guidoni. The results of the applications have not convinced designers generally that the method has merit, but the idea remains attractive. In Technical Note No. 490 comparative tests are described of a model of the hull of the U.S. Navy PN-8 flying boat and of a model of a modification of this hull in which the "sponsons" providing the wide beam of the hull were removed and replaced by lifting vanes projecting from the chines. The modification was not successful, for the substitution of the vanes caused a large increase in resistance and in spray thrown.

Tank tests on models of the hulls of several well-known and typical flying boats have already been described in reports and others will be added as the data are made available to the Committee. Such tests are always of particular interest

as they show the effects on take-off performance of the measures adopted by individual designers and thus permit useful comparisons to be made. By courtesy of the Sikorsky Aviation Corporation, the lines and other data necessary for a tank test of the hull of the Sikorsky S-40 (American Clipper Class) flying boat were obtained. The results of these tests, together with a study of the take-off as computed from the tank tests, is being published in Technical Note No. 512.

The successful application of trailing-edge flaps to the wings of land types of airplanes brought the natural suggestion that fitting flaps on the wings of seaplanes should result in improved take-off performance. It was anticipated that the increase in the lift of the wing would reduce the weight on the water and thus reduce the water resistance and total resistance. A study of this possible use of trailing-edge flaps is reported in Technical Note No. 510. From the data obtained in a "general" tank test of a model hull, the effect on the water performance of a typical flying boat of fitting the flaps at three different settings was investigated in detail. The large increase in drag that accompanied the increase in lift resulting from the use of the flaps proved to be the disturbing element. Despite a reduction in water resistance the total resistance might easily increase until it exceeded the thrust. The principal conclusion is that the take-off performance of a flying boat in a condition in which it has a large excess of thrust over resistance will be improved by the use of flaps; but if heavily loaded, with little excess thrust, the improvement will not be obtained and take-off may be prevented.

Fundamental information regarding planing surfaces.—The bottoms of flying-boat hulls in the neighborhood of the step are usually made up of two surfaces that meet at a dihedral along the keel. These surfaces may be planes or may be curved transversely or fore and aft in different manners according to the ideas of the designer. In model tests the effects on the performance of the model of the form of bottom that has been selected is usually masked more or less by the effects of other elements of the form of the hull. For the purpose of obtaining information on the characteristics of the form of the bottom alone it is planned to test an extensive series of planing surfaces that will include, among others, surfaces with different angles of dihedral, different transverse curvature, and different longitudinal curvature. Technical Note No. 509 has been issued describing the tests of a part of the series of planing surfaces, consisting of flat Vees at 0°, 10°, 20°, and 30° angle of dead rise. The surfaces having transverse and longitudinal curvature have not yet been tested. The tests of the complete series will be described in a technical report.

Document 5-22 (c), Excerpts from Annual Report of the National Advisory Committee for Aeronautics (Washington, DC, 1933-40). "Subcommittee on Seaplanes," Annual Report (1935), pp. 20-21.

The Subcommittee on Seaplanes was organized for the purpose of providing special consideration for research problems relating to seaplane design, and the research work conducted in the N.A.C.A. tank is under its direction.

The subcommittee held its first meeting at the Langley Memorial Aeronautical Laboratory on September 6, 1935, at which a general survey was made of the results obtained in the researches in the tank and the investigations at present under way. The future program of research and possible methods of adding to the value of the data obtained in the tank were discussed. In connection with the meeting, an inspection was made of the facilities of the tank and methods of making tests and of the models used. Motion pictures of the spray and wake characteristics of several models of floats and hulls were exhibited and a demonstration was made of the towing of a model through the water.

A statement of the research under way in the tank during the past year is given below.

Seaplanes.—The definite promise of air transport across the Pacific by means of flying boats and the belief that, once the trans-Pacific service is established, trans-Atlantic service will be developed very rapidly has led to a general increase in the interest in seaplanes and flying boats. The development of very large flying boats, of gross loads of 50 to 150 tons, is discussed with confidence. It also appears that private owners have become more interested in seaplanes as such, while new and larger amphibians are already under test or are being designed.

A recent development is the appreciation by pilots of the importance of holding the trim of a seaplane that is taking off to the best angles, i.e., the angles that give the least resistance. The N.A.C.A. trim-angle indicator described in Technical Note No. 486 has been successfully used by test pilots and improved take-off performances are reported to result from its use. An improved form of the instrument is now being designed.

Among the advantages derived from the great length of the N.A.C.A. tank is the ability to obtain several sets of readings in the course of a single run of the towing carriage. In order to use this advantage to the full, it was necessary to devise wave suppressors that would very quickly reduce the waves produced by a model to magnitudes that would not affect the next run. The wave suppressors now in use are described in Technical Note No. 513. They are so effective that test runs may safely be made in immediate succession and all the data for a general test of a model can easily be obtained in 2 days of operation.

The design of a model-cutting machine for use in making both wax and wooden models has progressed to the point where detailed plans have been started. This machine is designed to cut water lines, buttock lines, and transverse sections

on the block from which the model is being made and should produce a substantial reduction in the time required to make a model, as well as in its cost.

Further experiment with wax as a material for models is being postponed until the model-cutting machine is available.

For years it has been the general practice in naval tanks to make all observations and to take all records while the model is at constant speed. This method is entirely satisfactory for ship models because the main interest is in economy at constant speeds and also because, as a result of the large inertia of the ship, the speed changes relatively slowly while the weight on the water changes not at all. In the case of seaplanes, however, accelerations are high, the speed changes rapidly, and the weight on the water also changes rapidly. It is an attractive possibility that for the many constant-speed runs that are made at present there might be substituted a very few runs, or possibly a single run, in which the speed is accelerated from zero to a maximum and in which all the information desired could be obtained. The momentary values from such tests have so far shown poor agreement with those from constant-speed tests. The discrepancies are believed to be caused, in part at least, by the greater energy required to change from one type of flow pattern at one speed to another at a slightly higher speed as compared with the energy required to maintain either flow pattern.

Although the development of this type of testing is going very slowly, it has been found that observation of the continuous variations in the spray pattern is frequently more informative than observation of a succession of spray patterns at constant speeds. As a result of this observation[,] motion-picture records of the spray during runs that were continuously accelerated from rest to get-away have been made and found to be of great value to student and designer. This process has been extended to dropping the model into the water while decelerating, thus simulating a landing. The two sets of pictures are not claimed to be accurate reproductions of the spray of the full-size seaplanes, but they do give more information than can be obtained from the usual constant-speed runs.

In the course of the take-off or the landing run of a seaplane there sometimes appears a combination of vertical and angular motions that is aptly termed "porpoising." This complex phenomenon appears to be the combined result of hydrodynamic, inertial, and aerodynamic forces although the hydrodynamic and inertial forces seem to be the more influential. The tendency to porpoise sometimes appears in tests of models and usually is considered an indication that the actual machine will have the same tendency. A special towing rig has been constructed and a special light-weight model that may be ballasted to have the proper mathematical ratios of mass and moment of inertia to the full size is now available. This equipment is expected to make it possible to study the causes of porpoising and it is hoped to obtain information that may lead to a curve in specific instances.

Effect of Variations in Dimensions and Form of Hull on the Take-off of Flying Boats.—Improvement in the water performance of flying boats has remained

the principal object of the work of the N.A.C.A. tank during the past year. The effect of longitudinal flutes on the bottom, a construction that has been thought to have several advantages, was investigated for the Bureau of Aeronautics, Navy Department, on a model supplied by the Bureau (N.A.C.A. model 19). As received, the model had two longitudinal flutes on each side of the keel on both forebody and afterbody. The model was tested as received and then the flutes were replaced by the more conventional form on first the afterbody and then the forebody. When compared with the performance of an equivalent hull of conventional form, such as that of the PN-8, the performance of the original or modified model 19 was definitely poorer. The work with this model is described in Technical Note No. 522.

It is not enough that a seaplane float or hull have a good water performance; the form of the hull must be such as not to produce excessive resistance while in the air. Accordingly, it is part of the program on the improvement of the form of hulls and floats to determine the air drag of the various models that are tested in the N.A.C.A. tank and, in newer models, to try to combine low air drag with good water performance. A first group of 11 models have been tested in the N.A.C.A. 20-foot wind tunnel and the results are given in Technical Note No. 525.

The forms of hulls derived at the tank from tests of the series of related forms and exemplified in model 11-A, tests of which were reported in Technical Note No. 491, have been characterized by relatively simple forms of the bottom, usually with relatively straight cross sections and without flare or downward curvature at the chines. It was suggested that the form of model 11-A might be modified by the addition of a flare at the chine with a reduction in the spray and in the resistance. A new forebody was constructed incorporating a flare that increased the step forward in a manner that was believed to offer the most promise. When tested with the original afterbody form of model 11-A, it was found that although the spray had been reduced the resistance had been increased, as had also the trimming moments. The tests of this model (N.A.C.A. 11-G) are described in Technical Note No. 531.

Document 5-22 (d), Excerpts from Annual Report of the National Advisory Committee for Aeronautics (Washington, DC, 1933-40). "Subcommittee on Seaplanes," Annual Report (1936), pp. 19-20.

The Subcommittee on Seaplanes was organized in 1935 to guide and direct the research on seaplanes and the work in the N.A.C.A. tank. With the continual improvement in the performance of seaplanes and the rapidly increasing demand for large, long-range flying boats, the work of the tank has become of greater and greater importance. The equipment at Langley Field permits the testing of larger models at higher speeds than can be done in other ship or seaplane tanks; hence there are many requests for quantitative information from agencies concerned with the problem of high speeds on the water. This year, as before, new fundamental data from a number of tests of large models have been made available to seaplane designers while tests of a specific nature have been conducted for the military services and for private concerns.

THE N.A.C.A. TANK

Plant and equipment.—After five years of continuous operation, the tank was emptied, cleaned, and thoroughly inspected. Despite the extremely severe conditions of salt water and moist air to which they are subjected, the concrete and structure were found to be in excellent condition. During the past year, the rails and steelwork were cleaned and painted. Truck-type guide wheels were substituted for the original single guide wheels of the towing carriage to reduce the magnitude of lateral movements and, as a safety measure, the original pneumatic tires on the main wheels were replaced with new ones.

Historic series.—It is of great assistance to the designers of present-day seaplanes and to the Committee's staff in planning future research to know accurately the characteristics of hull forms that have been used and have proved successful in the past. As a part of a program to obtain such information, a $\frac{1}{7}$ -size model of the hull of the famous NC flying boat was tested over a wide range of operating conditions. This model was approximately twice the size of those originally tested in the experimental model basin of the Washington Navy Yard in 1917, when the form of the hull was developed. Its performance in the N.A.C.A. tank was found to compare favorably with that of many hulls of more modern design. The data obtained are published in Technical Note No. 566.

Effect of variations in dimensions and form of hull on take-off.—In spite of the increased facility in taking off the water given by more powerful engines and controllable propellers, the resistance to motion offered by the water remains a most important limitation of the performance of large seaplanes. The reduction of this resistance is, therefore, one of the primary objectives of the work at the tank[,] and the development of forms having low water resistance has been continued. The

N.A.C.A. pointed-step hull has shown definite promise in this direction but a valid criticism of the earlier forms was that the small angle of dead rise might result in heavy impact loads on the bottom in alighting on the water. Tank tests of a family of these hulls having three different angles of dead rise are described in Technical Note No. 551. It is shown that, while the high-speed resistance is somewhat greater for higher angles of dead rise than for low angles, the low-speed operation and spray characteristics are not impaired, and that, in spite of the increase in resistance at high speeds, the apparent advantages of the pointed-step form over conventional hulls are retained.

The single-float system for small seaplanes has certain aerodynamic and structural advantages. It is used extensively by the United States Navy but very little by private and commercial operators. Last year, $\frac{2}{7}$ -size models of two typical Navy floats were tested in the tank to obtain information to be used in attempts to design an improved form of float for this type of service. The results of these tests are published in Technical Note No. 563 and afford designers an opportunity to consider the single-float arrangement from the standpoint of water performance. A comparison of the test data of the conventional floats with those of a generally similar float having a pointed step is included in this note.

The form of the planing bottom of a hull forward of the step has in general a marked effect on water resistance. A previous investigation having established the superiority of a planing bottom longitudinally straight over the pronounced convex or "rocker" type, tests were made of a model of a flying-boat hull having a slightly concave bottom forward of the step. The results of these tests, reported in Technical Note No. 545, indicate that there is no great advantage in the concave type of planing bottom as tested, although the high-speed resistance was slightly less than that of the straight bottom.

Design data for hulls for small flying boats and amphibians.—The problems encountered in the design of hulls for small flying boats or amphibians are in some ways more difficult than those encountered in large craft. The combination of adequate strength, light weight, and good water performance with small size does not permit the elaborate structure that may be used where dimensions are not restricted. Under these conditions simplicity of form with good water performance becomes of the greatest importance. Technical Report No. 543 furnishes hydrodynamic data for five forms designed to be suitable for hulls of small flying boats and amphibians. The types used are simple in form and were tested in the tank for all values of speed, load, and trim which it was believed would apply. The data obtained are intended to aid the designer in selecting the most suitable size and type of hull as well as in verifying take-off performance in the early stages of a proposed design. Included in the series is a novel form of forebody the bottom surface of which can be expanded into a flat surface and hence can be fabricated without shaping the plating or planking near the bow. The tank tests indicated that

this simplified form compared favorably with the conventionally shaped bottom, at least for the smooth-water conditions simulated in the tank.

Work for private concerns.—From time to time the tank has interrupted its regular work to perform tests for the manufacturers when such tests could not be satisfactorily done elsewhere.

Document 5-22 (e), Excerpts from Annual Report of the National Advisory Committee for Aeronautics (Washington, DC, 1933-40). "Subcommittee on Seaplanes," Annual Report (1937), pp. 22-23.

World-wide interest in seaplanes has grown at an accelerated rate and almost every month has brought word of the launching of new craft of greater size and speed. Designers are discussing with confidence the construction of flying boats of magnitudes that would have been considered impracticable a few years ago and are looking forward to the construction of even larger and faster flying boats within a relatively short time.

With the increase in size and range have come increased get-away speeds and heavier loads on the hulls. The power required for the take-off of such large flying boats is sometimes 100 percent greater than that ordinarily used in flight, and in such cases the designer is confronted with the necessity of choosing between the use of larger engines involving a serious increase in weight and the possibility of shortened engine life as a result of running at excessive power during take-off.

The cost of these large flying boats makes it essential that the form of hull selected shall be the best possible compromise between the requirements of low drag in flight and good performance on the water. Research in the N.A.C.A. tank has therefore been directed toward the improvement of the over-all performance of flying boats and seaplanes by the reduction of the resistance on the water and the general improvement of the form of the hull. In contrast to previous work, the aerodynamic improvement is being given consideration at the same time.

Improvements to N.A.C.A. tank.—In anticipation of the demand for tests of models of larger hulls at higher take-off speeds, the Committee is enlarging the N.A.C.A. tank and increasing the speed of the towing carriage. When the work now under way is completed the tank will have 2,880 feet of water at a depth of 12 feet, which is an increase of 900 feet. The extension has been specially constructed to permit the generation and propagation of waves for use in testing models in waves and the simulation of operation in rough water.

The increase in length has been matched by an increase in the speed of the towing carriage. It is expected that when the alterations are completed the carriage will have a maximum speed of about 80 miles per hour. The carriage will also be able to tow much larger models.

At lower speeds, with models of the same size, it will be possible to increase the amount of testing per day because the ratio of the distance that can be used in

testing and obtaining readings to the distance required for stopping and starting the carriage will be considerably increased.

A two-story office building has been built at the southern end of the tank and the shop spaces have been extended 100 feet.

Effect of variation in dimensions and form of hull on take-off.—The result of incorporating longitudinal steps on the forebody of a V-bottom hull was determined by an investigation of a series of models in which the form and number of steps were systematically varied. In general, the longitudinal steps were found to decrease resistance at high speeds by reducing the area in contact with the water, but to increase resistance at low speeds where the bottom is wetted out to the chines. One longitudinal step on each side of the keel was superior to two longitudinal steps, except at high speeds and very light loads. Spray strips fitted along the steps reduced both the resistance and spray if they were set at the proper angle. This investigation is described in Technical Note No. 574.

Various methods of artificial ventilation of the step were investigated on two typical hull forms, one having straight V sections and one having chine flare on both forebody and afterbody. In both cases the chines aft of the step were clear of the water at the hump speed and above. When the chines were clear the step was ventilated by air flowing in from the sides and the introduction of additional air through ducts or slots produced no further change in resistance or trim. In the case of the form with chine flare, natural ventilation was delayed at speeds below the hump speed and artificial ventilation through ducts aft of the step resulted in an appreciable reduction in resistance and trim. The results of this investigation have been published in Technical Note No. 594.

Tests of models of representative flying-boat hulls.—The hull of the U.S. Navy PB-1 flying boat, which was built by the Boeing Aircraft Company in 1925, had two transverse steps very close together and a long extension carrying the tail surfaces. The forebody was much like that of the NC hull, from which it was apparently derived. Comparisons of its water performance as obtained in the N.A.C.A. tank with that of the NC hull and the Sikorsky S-40 hull are presented in Technical Note No. 576.

A model of the hull of the British Singapore II-C flying boat was investigated in the N.A.C.A. tank in response to suggestion of the Director of Research, British Air Ministry. This investigation made it possible to determine the hydrodynamic characteristics of a typical British hull form over an extensive range of loadings and speeds. It was found that the Singapore hull had higher resistance at the hump speed and lower resistance at higher planing speeds than the American hull with which it was compared. The results of this investigation, together with a comparison with similar results obtained in the British R.A.E. tank with the same model, are presented in Technical Note No. 580.

A large model of the hull of the British Short Calcutta flying boat was made from lines supplied by the British manufacturers and investigated in the N.A.C.A.

tank. The form is the immediate predecessor of the Singapore hull, and is representative of British flying-boat design in 1928. The results of these tests, together with calculated comparisons of its take-off performance with that of typical American forms, are published in Technical Note No. 590.

Trim-angle indicator.—The importance of holding a seaplane at the trim angles that would give least resistance during the process of take-off was described in Technical Note No. 486, issued in 1934. In that publication there is described and illustrated a trim indicator for showing the pilot of a seaplane the trim angle at which the craft is traveling. Several versions of this type of trim-angle indicator have since been constructed and tested in service. It has been found that if a pilot has a trim-angle indicator and the information obtained from tank tests of the hull as to the trim angles that give least resistance during the take-off, it is possible for him regularly to take off in much shorter time than he requires when no such instrument and data are available. The pilot of a heavily loaded amphibian operating in the tropics reported that he attributed the uniformly successful operation of his craft, especially the ease with which it took off in smooth water, to the use of a trim-angle indicator that had been supplied by the Committee. In another case the use of a trim-angle indicator by a test pilot is credited with so greatly improving the take-off characteristics that a seaplane which at first appeared very unsatisfactory gave very good performance.

Document 5-22 (f), Excerpts from Annual Report of the National Advisory Committee for Aeronautics (Washington, DC, 1933-40). "Subcommittee on Seaplanes," Annual Report (1938), pp. 20-22.

The world-wide interest in seaplanes of large size has been intensified by the serious discussion of the possibility of replacing the very large and very fast luxury liners by fleets of large flying boats as proposed in the report of the United States Maritime Commission on "Aircraft and the Merchant Marine." The full effects of this proposal, together with those of the announced intention to build machines of practically double the size of existing machines for this country's own transoceanic services, have not yet appeared, but that they will have an important bearing on both domestic and foreign developments cannot be doubted.

In the case of such large craft, with the high wing loadings proposed, the aerodynamic drag of the hull becomes an important part of the total drag, even though the size of the hull may be reduced somewhat by putting accommodations in the wings. The air speed and the fuel required for a given voyage may be quite seriously affected if the requirements for taking off from the water are considered without reference to the more important requirement of low drag in flight. Work on the improvement of the forms of hulls suitable for flying boats of large size is being conducted with these facts in mind.

A large part of the hydrodynamic research in the past year has been devoted to investigations of a specific nature at the N.A.C.A. tank in connection with the development of projected seaplanes. These investigations were chiefly concerned with the effect of changes in hull form on water resistance and spray and required the use of larger models than may be towed in other tanks in the United States. The N.A.C.A. tank therefore has an important relation to the present development of large military and commercial flying boats.

In the specific investigations as well as the general research program, the projects of immediate interest to the military services have been given first priority. Tests of models of fifteen flying-boat hulls have been completed in the past year. Tank tests of a special nature, not applying to aeronautics but requiring high towing speeds, have also been conducted for the Bureau of Construction and Repair, the Bureau of Ordnance, and the Bureau of Engineering of the Navy Department. The magnitude of the work on these projects caused a reduction in the time devoted to fundamental hydrodynamic problems but gave an opportunity for a more detailed study of some accumulated data and the preparation of the data for publication.

Plant and equipment.—The enlargement and improvement of the N.A.C.A. tank, begun last year, have been completed and a very definite improvement in the operation of the tank has been observed. The basin now has a length of 2880 feet and the towing carriage is powered to travel at speeds [of] up to 80 miles per hour. As anticipated, these features have increased the speed and efficiency of routine testing. In addition, a reserve capacity has been created for hydrodynamic research at speeds greater than are obtainable elsewhere.

The enlargement of the tank has required parallel improvement of the associated equipment. The great length of the basin has necessitated the development of new methods of aligning and leveling the rails, and the suppression of waves and surges. Various refinements and additions have been made to the carriage and the towing gear for the purpose of improving the ease and accuracy of recording the results of tests. A number of auxiliary devices have been constructed for use in the special tests that have been made and the range of adaptability of the equipment has been greatly increased.

Tests of models of representative flying-boat hulls.—In the investigation of the effect of form of hull on hydrodynamic resistance, tests have been made of large models of the hulls representing a variety of methods used to obtain satisfactory take-off performance.

N.A.C.A. model 36 was originally designed to be used in tests of stub-wing stabilizers and, in order to facilitate fitting different types of stubs, was given a rather long parallel middle-body. This form has proved to be of considerable interest to seaplane designers, not only because the parallel body gives a form of hull that makes it possible to use a convenient arrangement of the interior, but also because the aerodynamic drag as measured in the Committee's twenty-foot wind tunnel over a wide range of angle of attack is quite low. The general tank tests indicate

that the hydrodynamic characteristics are favorable and that the water resistance at the hump speed is exceptionally low. The results of these tests are presented in Technical Note No. 638.

Effect of rivet heads on frictional resistance.—The increasing use of flush riveting in the construction of all-metal aircraft has led to a need for information as to the effect of rivet heads on hydrodynamic resistance during take-off. The increase in frictional resistance caused by typical rivet heads was determined at the N.A.C.A. tank by tests of planing surfaces fitted with full-size rivets. The surfaces were towed at the high water speeds encountered by seaplanes during take-off and the relative resistance of the various shapes of head were measured. An analysis of the data, published in Technical Note No. 648, shows that for the rivet heads investigated the increase in frictional resistance is directly proportional to the height of the head. The order of merit of commonly used heads for seaplane hulls is therefore flush countersunk, oval countersunk, brazier, and round. The magnitude of the increase in hydrodynamic resistance depends, of course, on the number of rivets required in the structure.

Use of tank data.—Investigations of resistance in the N.A.C.A. tank are made general in application by the fact that the models are tested over a wide range of speed, load, and trim. The results are intended to be used as a basis for design calculations to determine take-off resistance and to compare the advantages and disadvantages of various forms of hull. A discussion of possible uses of the “general” test data is presented in Technical Report No. 625. Among the subjects treated in this report are selection of best beam, importance of maximum trim, location of the center of gravity, and comparison of hull lines. It is concluded that the ranges of load and speed employed in the general tests are ample to cover future increases in the size of seaplanes.

In Technical Note No. 643 it is shown that in the solution of some design problems the normal resistance curve for a flying boat may be approximated by two straight lines. By the use of this approximation, charts are developed to aid in the rapid solution of certain problems involving the effect of the shape of the resistance curve on take-off time and distance or the determination of the accelerating forces required to meet specified take-off performance.

The N.A.C.A. trim indicator.—Further experience with the N.A.C.A. trim indicator has emphasized the importance of holding a seaplane at the trims that give least resistance during take-off.

The Committee has constructed and made available for loan to operators and manufacturers a form of trim indicator based on the principle described in Technical Note No. 486. The instruments have proved to be of great assistance in the test flying of large flying boats of new design, particularly those designed for commercial transoceanic service. It is in these types of service and on long-range military seaplanes, which, heavily loaded, must take off with comparatively little reserve power, that a “precision” take-off is essential. A relatively small increase in

the total load with which a seaplane may safely take off represents a large increase in payload. Accordingly, it appears that a trim indicator of some form is essential to economical operation of seaplanes in transoceanic service.

In seaplanes that have a large excess power that may be used for take-off, the use of a trim indicator is of much less importance for routine service.

For test flying and in the training of pilots to fly a particular design[,] the optical type of instrument is very useful and is simple and easily adapted to almost any arrangement of instrument board and windshield. An interesting application of the N.A.C.A. trim indicator in this manner was its installation and use for 100 hours of testing in an experimental flying model of a large flying boat.

Document 5-22 (g), Excerpts from Annual Report of the National Advisory Committee for Aeronautics (Washington, DC, 1933-40). "Subcommittee on Seaplanes," Annual Report (1939), pp. 19-21.

The relative importance assigned to the various hydrodynamic problems connected with the design and construction of seaplanes, which are under the cognizance of the Subcommittee on Seaplanes, has changed radically during the past year. For several years the major hydrodynamic problem has been that of resistance, and the possibility of successfully getting into the air was considered to be largely determined by that factor. Today the major hydrodynamic problems appear to be (1) dynamic stability while in motion on the water, (2) spray, and (3) seaworthiness. This almost sudden change has come about because of the pressure on the designers of demands for extreme performance in the way of speed, range, and pay load. In the endeavor to produce hulls having minimum air drag and structural weight, the almost universal tendency has been to adopt forms having relatively narrow and deep cross sections.

This form also gives the familiar arrangement of the passenger accommodation in civil craft. But narrow hulls have meant heavily loaded hulls; the high position of wings and engines—and, in many cases, fuel—has caused the center of gravity of the whole craft to rise to surprisingly high positions; the heavily loaded wings and high air speeds have caused landing speeds to be considerably increased. As a result of these changes, the difficulties associated with obtaining adequate longitudinal stability (freedom from “porpoising”), freedom from excessive spray and from spray thrown into the propellers, and moderate impacts of the bottom on the water while landing and taking off have been greatly increased. At the same time, the use of engines with greatly increased power needed for flight at higher speeds, and the general use of automatic or controllable propellers with greater efficiencies in the range of take-off speeds, have made the water resistance of the hull of much less importance in determining whether a seaplane can get into the air. This situation has made it necessary to broaden the scope of the Committee’s work and to undertake the provision of additional facilities to enable adequate consideration of the new problems.

Apparatus and technique to conduct the investigations made necessary by the new problems have been developed and expanded as rapidly as possible. Equipment of a semi-permanent type has been constructed, and appropriate methods of operation have been developed for testing dynamically similar models of complete flying boats for the purpose of studying their dynamic stability. Methods of constructing the very special type of models required for this work have been devised. Accurate methods of ballasting the models so that the weight and the moment of inertia about the center of gravity will correspond to those of the full-size craft have been developed. The theory on which a mathematical study and a determination of the stability may be based has been investigated and a revised treatment, based on that of Perring and Glauert, has been begun. A sound theoretical treatment will be very helpful in the understanding of this very complex problem and in the direction of the broad fundamental research that must be carried out if the problem is to be solved.

With the limited equipment already at hand, it has been possible to investigate the dynamic stability of two specific machines for the Bureau of Aeronautics and of one for a private corporation.

Work for the military services of the Government has continued to receive first priority in the work of the tank. Four investigations of specific flying-boat projects and two investigations of novel devices have been completed. Several projects requiring the high towing speeds available only at the N.A.C.A. tank were completed for the Navy.

The fundamental researches completed and under way were of interest because of the use in several cases of large families of related models to study influences of form on the hydrodynamic qualities because the scope of the investigations was extensive to include aerodynamic effects as obtained in N.A.C.A. wind-tunnel tests on the same models.

Plant and equipment.—The efficiency of routine tests in smooth water has been increased by the installation in the tank of devices that damp out the surges caused by the operation of the carriage and by the perfecting of more durable wave suppressors. The development of these devices, as well as the design of a wave-making device, has been facilitated by the construction of a small tank one-eighth the cross section of the N.A.C.A. tank and 50 feet long. This tank has large glass panels in the sides and in it large models of the devices can be operated while the motions of the water about the models are observed.

Hulls for long-range flying boats.—In a long-range aircraft, small increases in air drag have a large influence on pay load and the best form of hull for such a craft presumably is one that approximates a streamline body and departs from such a form only by the amount required to give satisfactory hydrodynamic qualities. It is anticipated that the trend of design will be toward such forms, and both tank and wind-tunnel data are being accumulated to aid in their further development.

Technical Note No. 668 describes tests in the tank and in the 20-foot wind tunnel of two models of the planing type of hull, the forms of which are derived

from a body of revolution and which represent extreme dynamic refinement as compared with existing hulls. The tank tests showed that the models were generally satisfactory but under certain conditions developed a tendency to behave unsatisfactorily. Take-off calculations for an assumed giant flying boat indicated that its take-off characteristics would be satisfactory if the trim was properly controlled. These models had lower air drag for the same volume than any models previously tested in the 20-foot wind tunnel. They possessed the desirable characteristics of having smaller than usual increases in drag with departures from the angle for minimum drag.

It was apparent from the tank tests that there is in general no sharp line between good and poor water performance to determine the practical limits of aerodynamic refinement. A family of models has therefore been devised having systematic variations in the degree of departure from a streamline body. Tests of this family, now in progress, will provide further information on the best compromise between desirable dynamic and hydrodynamic qualities.

Outboard floats.—The best form of outboard float represents a compromise between the requirement of low aerodynamic drag and satisfactory characteristics on the water. As part of a program for the investigation of outboard floats, four models of typical floats were tested in the tank and in the 20-foot wind tunnel (Technical Note No. 678). From the data obtained, the forms were compared on the basis of aerodynamic drag, spray, and yawing moments for given righting moments. Other factors, such as relative angle of heel, possible impact loads, and structural simplicity, were also considered in the analysis. It was concluded that the best form for an outboard float, when all its requirements are considered, is one having a transverse step for good planing characteristics and having its buoyancy distributed horizontally rather than vertically.

Tests of models of representative flying-boat hulls.—A one-sixth size model of the hull of a Navy flying boat was investigated in the tank as part of the general program of tests of typical hull forms. This hull was a more recent adaptation of the NC type and was of special interest because of several features intended to improve take-off performance. These features included pronounced chine flare on both forebody and afterbody, a downward hook in the surface of the bottom at the step, and a tail extension shaped to provide additional hydrodynamic lift at low speeds. The hydrodynamic characteristics were found to be very satisfactory over a wide range of loadings and speeds. The results of the general test have been published in Technical Note No. 681.

In this publication a new type of chart was introduced for use in calculations of take-off performance based on the data from the general test. Since at a given speed, load and resistance are functions of the trim, the data are plotted in the form of resistance coefficient against trim with load coefficient as parameter. A number of such plots are made for a succession of speed coefficients such as would be used in a step-by-step calculation of take-off events. The curves of trimming-moment

coefficient are superposed on these plots in the form of contours of constant trimming-moment coefficient. Experience with these charts has shown that they are preferable to the previous charts plotted against speed coefficient because of the greater ease of interpolation and the wider application to problems involving arbitrary conditions of trim or trimming moment.

Document 5-22 (b), Excerpts from Annual Report of the National Advisory Committee for Aeronautics (Washington, DC, 1933-40). "Subcommittee on Seaplanes," Annual Report (1940), pp. 10-11.

During the past year the facilities of the NACA tank have been almost continuously in use for the study of specific problems and the testing of specific models submitted either by the military services or by manufacturers. In the latter category were two models of commercial transport seaplanes in which the Navy was interested, and two for use in connection with designs being prepared for the military services. The work was so urgent that NACA projects were carried on only to fill in between these tests; consequently, the only other model tested was one forming a part of the NACA program of research devoted to the development of improved forms of hulls for flying boats.

Plant and equipment.—The dynamically similar models used in investigations of the dynamic stability of seaplanes while taking-off and landing must accurately reproduce not only the form of the hull but also the aerodynamic structure (wings and tail surfaces). In these tests, the air in the tank should be perfectly still, corresponding as nearly as possible to the condition of take-off with no wind. Unfortunately, the towing carriage generates large turbulence and this turbulence in turn causes disturbance of the air well ahead of the carriage. A new auxiliary carriage made of steel tubing was constructed and put into service during the past year. This carriage was designed to give better air conditions and to improve the facility with which tests could be made. Although completely still air has not been obtained, there has been a considerable improvement.

The methods of constructing the very special dynamic models have been continuously improved, and the information gained from the test of each new model has been used to check the operation of the various features incorporated in it and to indicate the desirability of further changes. There have been almost no fundamental changes but many changes in detail.

Effect of angle of dead rise on resistance and drag.—The effect of the angle of dead rise of the bottom on the hydrodynamic resistance and the aerodynamic drag has been investigated on a series of three models of seaplane floats. The angles of dead rise investigated were 20°, 25°, and 30°.

Effects of chine flare on water resistance and spray.—The cross section of the bottom of most flying-boat hulls now shows a recurved portion, or flare, at the chine. Its primary purpose is to cause the wave coming from under the hull to be

deflected and thus be kept from rising until it strikes the propellers or the wings, as it sometimes will if no such flare is provided.

Models of 22 flying-boat hulls were tested in the NACA tank for the purpose of determining the effect on water resistance and spray of 13 variations in the transverse section of the bottom of the forebody and 3 variations in the form of the bottom of the afterbody. The chine flare was found to reduce the height of the part of the spray that originated where the chine was below water level. The first type of spray comes from a sheet of water that travels across the bottom at high speed and may be termed a "velocity" spray. The second type is produced by water that escapes under the chine from the high pressure generated at the chine and may be termed a "pressure" spray. The chine flare causes an increase in the pressure on the bottom at the chine, and the addition of certain types of chine flares actually increases the height of this latter type of spray.

Study of the flow of water along the bottom of a model of a flying-boat hull.— Knowledge of the manner in which the water encountered by the bottom of a flying-boat hull moves over the bottom is of great value in understanding the effects of the various changes in form that are investigated. Observation of the flow, as it issues from beneath the bottom at the chines and the steps, indicated that changes in the direction of flow have marked effects on spray and resistance but, as long as it was possible to observe only the end effects, it was impossible to do much in the way of determining where the changes originated or what were the fundamental causes. Obviously direct observation of the flow throughout the entire length of the bottom would give much valuable information. In order to verify this observation, a model with a transparent bottom was constructed.

Document 5-23 (a–c)

- (a) Carl J. Wenzinger and Joseph A. Shortal, “Aerodynamic Tests of $\frac{1}{25}$ -Scale Model of Boeing Airplane No. 314 in the N.A.C.A. 7- by 10-Foot Wind Tunnel (Modified), *NACA Confidential Memorandum Report for Boeing Aircraft Company* (Seattle, Washington, 2 September 1936), copy in Boeing Archives, Seattle, WA.
- (b) Wellwood E. Beall, Engineer in Charge of All Commercial Projects, Engineering Department, Boeing Aircraft Company, “Design Aspects of the Boeing Trans-Atlantic Clipper,” presented at the Air Transport Meeting of the Institute of Aeronautical Sciences, Chicago, IL, 18–19 November 1938, copy in Boeing Archives, Seattle, WA.
- (c) Wellwood E. Beall, Chief Engineer, Boeing Aircraft Co., “Clipper of the ’40’s,” *Yale Scientific Magazine* (Winter 1940): 2–4, 29–31.

These three documents from 1936, 1938, and 1940 concern the design of the famous Boeing “Clipper Ships,” the large, four-engine flying boats that pioneered long-range commercial flights across the Atlantic and Pacific Oceans in the years leading up to World War II. Pan American Airways borrowed the name “Clipper Ships” from the fast American wooden sailing ships of the 19th century, which crossed the Pacific to China. All three of the documents below relate to the flying clipper ship built by the Boeing Aircraft Company, designated Model 314. It should be remembered, however, that two other companies, Sikorsky and Martin, also built clipper-type flying boats in the form of Model S-42 and Model 130, respectively.

In some respects, the flying clipper ships should be compared technologically with the Douglas DC-3 landplane transport of the same era, because all represented the high stage of design maturity that came along with the reinvention of the airplane during the interwar period. Among the significant design features of the Boeing 314, Sikorsky S-42, and Martin 130, one would include the following:

- Four radial air-cooled engines enclosed in drag-reducing NACA cowlings.
- Side-by-side engine mounting within the wing’s leading edge.
- Variable-pitch propellers.
- Advanced wing flaps.
- Metal construction (with only certain small portions covered with fabric).

- Either tip floats (Sikorsky S-42) or “sponsons” (Boeing 314 and Martin 130) used for lateral stability. (A sponson is a structural projection appearing as a kind of ridge along the side at the bottom of the hull, providing additional planing surface and increased lateral stability.)
- Either full cantilever wings (Boeing 314) or a limited number of supporting struts (Sikorsky S-42 and Martin M 130).
- Either a hull with two transverse steps (Sikorsky S-42 and Martin 130) or a single-step hull with an afterbody tapering to a sharp stern post (Boeing 314).

The Boeing 314 was by far the largest of the three clipper ships, with a gross weight of 84,000 pounds compared to 48,000 for the Sikorsky and 52,252 for the Martin machine. It was also the most advanced. It could reach a maximum of 201 mph, compared to 182 and 180 mph for the Sikorsky and Martin machines, respectively. It possessed the best lift-to-drag ratio, achieving a maximum lift-drag coefficient of 13.0 compared to 12.2 and 11.9, as well as the best zero-lift drag coefficient, 0.0274 compared to 0.0362 and 0.303, respectively. Boeing built 12 of these flying boats, the first of which flew in June 1938. (The Sikorsky S-42 had started making flights with passengers between Miami and Rio de Janeiro in 1934 and across the Atlantic in 1937; the Martin 130 began its 60-flying-hour, 8,210-mile transpacific service—via Hawaii, Midway Atoll, Wake Island, and Guam—in late 1936.) On 28 June 1939, just a little over two months before Nazi Germany invaded Poland to begin World War II, Pan American Airways (Pan Am) inaugurated its transatlantic clipper service with a Boeing 314 flight from New York City to Lisbon, Portugal. The big boat accommodated 74 “day” passengers and a crew of 10. Pan Am advertised a range of 3,685 miles, but this could only have been done with much less than a full load. A more realistic number for the Boeing 314’s maximum range was about 1,900 miles.

Passengers who flew in these great flying clipper ships loved their comfort and spaciousness. But their safety record was not all that great—especially in the case of the Martin Clippers. In July 1938, Martin’s Hawaii Clipper disappeared between Guam and Manila, with no trace of wreckage ever found. In January 1943, its Philippine Clipper crashed into a mountain east of San Francisco while trying to navigate bad weather on its way in from Hawaii. Two years later during the same month, the famous China Clipper crashed while trying to land in Trinidad. In all three cases, all on board lost their lives. No such tragedies plagued the Boeing 314, but it made some dramatic forced landings at sea. Pan Am discontinued its use of the big boats in 1946, in clear preference for the new, large, high-performance landplanes becoming available, notably the Douglas DC-4 and DC-6 and the Lockheed Constellation.

For a dramatic fictional portrayal of what it was like to fly across the ocean in one of these great clipper ships, read Ken Follett’s novel *Night over Water* (New York: Signet, 1991). It tells the story of an imaginary last flight of the Pan Am Clipper, just a few days before the outbreak of World War II.

*Document 5-23 (a), Carl J. Wenzinger and Joseph A. Shortal,
"Aerodynamic Tests of 1/25-Scale Model of Boeing Airplane No. 314
in the N.A.C.A. 7- by 10-Foot Wind Tunnel (Modified),
NACA Confidential Memorandum Report for
Boeing Aircraft Company (Seattle, Washington, 2 September 1936).*

INTRODUCTION

At the request of the Boeing Aircraft Co. (reference 1) and upon authorization contained in reference 2, tests were made in the N.A.C.A. 7- by 10-foot wind tunnel (modified) of a model of the Boeing 314 flying boat. The main object of the tests was to determine the aerodynamic characteristics of the complete model and of component parts of the model, and to measure the effects of two difference types of "hydrostabilizers" or sponsons.

Simultaneous with the wind-tunnel investigation, tests were also conducted of a large model of the boat hull in the N.A.C.A. tank. This arrangement was made in order to coordinate the two types of test, and so obtain the best aerodynamic as well as hydrodynamic setting and design of the hydrostabilizers. The wind-tunnel tests were carried out during the period of August 10 to August 24, 1936.

WIND TUNNEL

For the present investigation it was considered desirable to modify the existing tunnel (see reference 31) by adding upper and lower walls (fig. 1) [*not reproduced*], thus partially closing the previously open throat. Such a modification eliminated the necessity for jet-boundary corrections for a model of the size tested and also improved the longitudinal pressure gradient (fig. 2) [*not reproduced*]. The lateral dynamic pressure distribution is shown in figure 3 [*not reproduced*].

MODEL

General.—The 1/25-scale model of the Boeing 314 airplane was built by the Boeing Aircraft Co. in accordance with their drawings no. 15-4209, sheets 1 and 2. (See figs. 4 and 5 [*not reproduced*].) The model was constructed mainly of laminated mahogany, well finished, and was equipped with removable hull, wing, engine nacelles, tail surfaces, spray strips, and with two types of adjustable hydrostabilizers. Partial-span split flaps were also furnished for mounting on the wing at angles of 20°, 40°, and 60°.

Dimensions used for the model tests		Dimensions of full-scale airplane	
Wing area	660.6 sq. in.	Wing area	2,867 sq. ft.
Wing span	72.960 in.	Wing span	152.0 ft.
m.a.c.	10.35 in.	m.a.c.	21.6 ft.
Center of gravity locations (see also fig. 4):		Gross weight	80,000 lb.
c.g. 1 (forward)	is 18.2 in. aft nose and 5.9 in. above base	C_L for cruising	0.65
c.g. 2 (intermediate)	is 18.53 in. aft nose and 5.9 in. above base		
c.g. 3 (normal)	is 18.9 in. aft nose and 5.9 in. above base		
Angle of wing setting	$4\frac{1}{2}^\circ$ to base line		
Airfoil sections,	0018 at root		
N.A.C.A.	0009 at tip		

TESTS AND RESULTS

Test Conditions.—The model was mounted on the standard force-test tripod of the balance in the 7- by 10-foot wind tunnel. Moments were measured for the wing alone about the axis shown on figure 4 (tunnel moment axis, wing alone) and for all arrangements with the hull, about an axis also shown on figure 4 (tunnel moment axis). The measured moments were later transferred to other desired axes (c.g. locations).

Lift, drag, and cross-wind forces, and pitching, yawing, and rolling moments were all measured at an air speed of about 80 miles per hour ($q = 16.37$ pounds per square foot). The average test Reynolds Number was 630,000 based on the air speed of 80 miles per hour and on the mean aerodynamic chord. On the same basis the "effective" Reynolds Number (turbulence factor of wind tunnel \times test R. N.) was $1.4 \times 630,000 = 883,000$.

The angle-of-attack range covered was from below zero lift to a few degrees beyond the stall for practically all arrangements tested.

α , angle of attack, is measured with respect to the m. a. c.

Ψ , angle of yaw, is measured about c. g. of the model with respect to the tunnel axis and center line of the model.

δ_s , stabilizer angle, is measured with respect to the wing m. a. c.; positive with leading edge up.

δ_e , elevator angle, is measured with respect to stabilizer; positive with trailing edge down.

δ_r , rudder angle, is measured with respect to fin; positive with trailing edge left.

δ_f , flap angle, is measured with respect to wing; positive with trailing edge down.

δ_h , hydrostabilizer angle, is measured with respect to the base line; positive with leading edge up.

Coefficients.—The measured values were calculated in the form of standard N.A.C.A. nondimensional coefficients all based on the model wing area, wing span, and mean aerodynamic chord. The data are given in the form of tables and graphs.

$$C_L, \text{ lift coefficient,} = \frac{\text{Lift}}{q s}$$

$$C_D, \text{ drag coefficient,} = \frac{\text{Drag}}{q s}$$

$$C_o, \text{ cross-wing force coefficient,} = \frac{\text{Cross-wind force}}{q s}$$

$$C_{m,c}, \text{ pitching-moment coefficient,} = \frac{\text{Moment about c. g. } c}{q c s}$$

$$C_{n,c}, \text{ yawing-moment coefficient,} = \frac{\text{Moment about c. g. } c}{q b s}$$

$$C_{l,c}, \text{ rolling-moment coefficient,} = \frac{\text{Moment about c. g. } c}{q b s}$$

Where q is dynamic pressure (16.37 lb./sq. ft. at 80 m. p. h.).

s , total wing area (4.59 sq. ft.).

c , mean aerodynamic chord (0.863 ft.).

b , wing span (6.08 ft.).

Moments may be computed about c. g. 1, c. g. 2, or c. g. 3 shown on figure 4, or about the $\frac{\text{m. a. c.}}{4}$ for the wing alone.

The measured forces and moments have all been corrected for tares due to the tripod support. Corrections have also been applied to the angle of attack and to the drag forces for the effects of a small upflow in the air stream caused by the model support and fairing system. No corrections have been applied for the effects of the jet boundaries because, with the size of model and jet used and the arrangement of wind tunnel having top and bottom boundaries but sides open, the correction factors are theoretically zero. (See reference 4.) This condition has also been checked previously by other tests, and satisfactory agreement obtained with corrected results from the completely open jet.

For convenience in locating test results, a table of tests arranged in chronological order is given:

BOEING MODEL 314 (1/25-SCALE) 7- BY 10-FOOT WIND-TUNNEL TESTS

Table of Tests

Test No.	Description of Model	Results presented in:	
		Table	Figure
1	Wing alone	I	7, 14, 15
2	Wing alone, $\delta_f = 60^\circ$	I	7
3	Wing and nacelles	I	14, 15, 16
3a	Test 3 with nacelle baffles closed	I	16
3c	Hull alone	I	14, 15
3d	Hull and tail, $\delta_s = -4.5^\circ$	II	
4	Wing, nacelles, and hull	III	14, 15
5	W + N + H + tail, $\delta_s = -4.5^\circ$	III	14, 15
6	W + N + H + T + Std. Hy. S. $4\frac{1}{2}^\circ$, $\delta_s = -4.5^\circ$	III	14, 15, 17
6a	W + N + H + T + Std. Hy. S. 6° , $\delta_s = -4.5^\circ$	III	17, 24
7	W + N + H + T + Alt. Hy. S. $4\frac{1}{2}^\circ$, $\delta_s = -4.5^\circ$	IV	17
7a	W + N + H + T + Alt. Hy. S. 3° , $\delta_s = -4.5^\circ$	IV	17, 19, 21
7b	Test 7a with trailing edge of Hy. S. removed	IV	17
8a	Test 7a with modified windshield	IV	19
8a-2	Test 7a with filleted windshield	V	19
8c	Test 7a with small tail fillet	V	21
8d	Test 7a with large tail fillet	V	21
8e	Test 8d with Std. Hy. S. 6° and Alt. rear step	V	24
9	Test 8e with spray strips		24
8b	Test 9 with wing fillet	VI	24, 25, 26, 28
8f	Test 8b with step fillet	VI	25
8g	Test 8f with Hy. S. fillet	VI	25
10a'	Test 8b with $\delta_c = +5^\circ$	VI	26
10b'	Test 8b with $\delta_c = -5^\circ$	VII	26
10c'	Test 8b with $\delta_c = -16^\circ$	VII	26
10d'	Test 8b with $\delta_c = -25^\circ$	VII	26
11a'	Test 8b with $\delta_f = 60^\circ$, $\delta_c = -16^\circ$	VII	26
11d	Test 8b with $\delta_f = 60^\circ$, $\delta_c = +5^\circ$	VIII	26
8b-1	Test 8b with $\delta_s = -1.5^\circ$, $\delta_c = 0^\circ$	VIII	28, 31, 38, 39
10a	Test 8b-1 with $\delta_c = +5^\circ$	VIII	28
10b	Test 8b-1 with $\delta_c = -5^\circ$	VIII	28
10c	Test 8b-1 with $\delta_c = -16^\circ$	IX	28

Test No.	Description of Model	Results presented in:	
		Table	Figure
10d	Test 8b-1 with $\delta_c = -25^\circ$	IX	28
11a	Test 8b-1 with $\delta_f = 60^\circ$, $\delta_c = 0^\circ$	IX	31
12a	Test 8b-1 with $\delta_f = 20^\circ$, $\delta_c = 0^\circ$	IX	31
13a	Test 8b-1 with $\delta_f = 40^\circ$, $\delta_c = 0^\circ$	X	31
14a	Test 8b-1 with $\delta_f = 15^\circ$	X	32
14b	Test 8b-1 with $\delta_f = 25^\circ$	X	32
15a	Test 8b-1 with $\psi = -5^\circ$	X	33, 34, 41
15b	Test 8b-1 with $\psi = 2^\circ$	X	33, 34, 41
15c	Test 8b-1 with $\psi = 5^\circ$	X	33, 34, 41
15d	Test 8b-1 with $\psi = 10^\circ$	X	33, 34, 41
15e	Test 8b-1 with $\psi = 20^\circ$	X	33, 34, 41
18	Test 8b-1 with hooked setup	XI	36
19	Test 18 with faired hull nose	XI	36
20	Test 8b-1 with tail raised $\frac{1}{2}$ in. $\delta_s = -1.5^\circ$	XI	38, 39, 40
23	Test 20 with Alt. Hy. S. 4.5°	XI	40
23a	Test 23 with $\psi = 5^\circ, 10^\circ, 20^\circ$; $\alpha = 8^\circ$	XI	41
21	Test 20 with Std. Hy. S. 7°	XII	40
21'	Test 21 with $\psi = 90^\circ$, $\alpha = 6^\circ$	XII	
24	Check test on 21 after reassembly	XII	44
25	Test 24 with faired hull sides	XII	44

Wing alone.—(Figs. 6 and 7 [*not reproduced*]; tests 1 and 2.) The $\frac{1}{25}$ -scale model of the wing alone is shown mounted in the modified 7- by 10-foot wind tunnel in figure 6. Plots of lift and drag coefficients, ratios of lift to drag, and pitching-moment coefficients about the quarter chord of the mean aerodynamic chord are given in figure 7.

Three conditions are shown: plain wing; wing with partial-span split flaps deflected down 60° including center section; and wing with the same flaps but without the center section of the flap (normally covered by the hull).

The plain wing gives a $C_{L_{\max}}$ of 0.851, which is increased by $\Delta C_{L_{\max}}$ of 0.637 to $C_{L_{\max}}$ of 1.488 with the flap. Removing the center section of the flap reduces this latter $C_{L_{\max}}$ to 1.371. Previous tests have shown that the increment of $C_{L_{\max}}$ due to simple split flaps or to ordinary flaps is practically independent of scale effect (reference 5). Because of this characteristic it is possible to estimate satisfactorily the $C_{L_{\max}}$ of wings with simple flaps, provided that the scale effect on the plain wing is known, and that increments due to the flaps are available at either low or high scale.

Components of model.—(Figs. 8, 9, 10, 11, 12, 13, 14, and 15 [*not reproduced*]; tests 1, 3, 3c, 4, 5, and 6.) Component parts of the complete model as combined one at a time for test are shown in the photographs as figures 8 to 13. Lift and drag coefficients, ratios of l/b , and pitching-moment coefficients about c. g.₂ are plotted against angle of attack in figure 14 for the various arrangements noted. Polar curves and l/b against C_L are plotted in figure 15.

Effect of closing nacelle baffles.—(Fig. 16 [*not reproduced*]; tests 3 and 3a.) The effect of completely closing the baffles in the nacelles is shown by means of a polar curve and a plot of l/b against C_L in figure 16.

Aerodynamic effect of various hydrostabilizers.—(Fig. 17 [*not reproduced*]; tests 6, 6a, 7, 7a, and 7b.) Two hydrostabilizers were tested: one with a step (standard hydrostabilizer) and the other plain (alternate hydrostabilizer). The effect of these hydrostabilizers at various angles with respect to the hull base line is given in figure 17.

Different windshields.—(Figs. 18 and 19 [*not reproduced*]; tests 7a, 8a, and 8a-2.) In an attempt to reduce the drag by eliminating adverse interference effects in the vicinity of the windshield and wing juncture, the top of the hull was widened at this point and faired with modeling clay. Sections of the hull at two stations are given in figure 18, showing the modified windshield. The filleted windshield was formed by merely fairing the corners slightly. The effect of these two modifications to the windshield is shown in figure 19.

Tail fillets.—(Figs. 20 and 21 [*not reproduced*]; tests 7a, 8c, and 8d.) Two sizes of tail fillets were tested, both of which are shown on figure 20. The effect of these fillets on the drag is shown in figure 21.

Spray strips and various fillets.—(Figs. 22, 23, 24, and 25 [*not reproduced*]; tests 6a, 8e, 9, 8b, 8f, and 8g.) The standard hydrostabilizer was set at 6° to the base line and the rear step altered by fairing with wax into the hydrostabilizer line. The complete polar for this condition with the large tail fillet is given on figure 24. The spray strips furnished were attached to the forward chine as shown on figure 22. The effect of the spray strips on the drag is shown in figure 24. The wing was filleted as shown on figure 23. The effect of this fillet is shown on figure 24. A small fillet was faired around the hydrostabilizer-hull juncture and then the rear step was faired rather completely into the afterbody. The effect of these fillets is given in figure 25.

Longitudinal balance.—(Figs. 26, 27, and 28 [*not reproduced*]; tests 8b, 10a', 10b', 10c', 10d', 11a', 11d', 8b-1, 10a, 10b, 10c, and 10d.) The effect of the elevator on balance was determined with the stabilizer at -4.5° with and without the flap. These results are given on figure 26. The stabilizer angle was increased positively to -1.5° as shown on figure 27 and the elevator tests repeated. The results of these tests are shown on figure 28.

Flow observations.—(Figs. 29 and 30 [*not reproduced*].) The air flow over the various parts of the complete model was studied by observing and photographing the motion of small white silk tufts attached to the model. The characteristics of

the flow are shown on figures 29 and 30 at several angles of attack. It will be noted that the tips of the wing stall first and that the flow inboard of the outboard nacelle is hardly disturbed up to 14° angle of attack. The complete motion picture record of the behavior of the tufts when the angle of attack is changed is available on loan from the NACA.

Effect of flap.—(Fig. 31 [*not reproduced*]; tests 6b-1, 11a, 12a, and 13a.) The effect of various flap deflections on the lift, drag, L/D , and pitching-moment coefficients is given in figure 31. It will be noted that the $\Delta C_{L_{\max}}$ with 60° flap deflection is about the same as with the wing alone with center section of flap removed in figure 7. The trim of the airplane is affected very little by flap deflection.

Rudder.—(Fig. 32 [*not reproduced*]; tests 14a and 14b.) The effect of rudder deflection on yawing- and rolling-moment coefficients about wind axes is shown on figure 32. The results are plotted against angle of attack and also cross-plotted against rudder deflection at two angles of attack ($\alpha = 3^\circ, 8^\circ$).

Yaw.—(Figs. 33 and 34 [*not reproduced*]; tests 15a, 15b, 15c, 15d, and 15e.) The effect of yaw on rolling- and yawing-moment coefficients is shown on figures 33 and 34. The moments are plotted against angle of attack in figure 33 and against angle of yaw in figure 34. It will be noted that the effective dihedral is rather large.

Hooked step and faired hull.—(Figs. 35 and 36 [*not reproduced*]; tests 18 and 19.) The forward step was deepened by adding a "hook" as shown in figure 35. The forward portion of the hull was faired completely as shown in figure 35. The effect of these modifications is shown on figure 36.

Raised tail.—(Figs. 37, 38, and 39 [*not reproduced*]; tests 8b-1 and 20.) The tail (stabilizer, elevator, and fin) was raised $\frac{1}{2}$ inch and the rudder faired into the fin as shown on figure 37. The effect of this change is shown on figures 38 and 39.

Effect of raised tail on moments due to yaw.—(Figs. 40 and 41 [*not reproduced*]; tests 20, 23, 21, and 23a.) The alternate hydrostabilizer was attached to the hull at 4.5° and tested. The rolling- and yawing-moment coefficients due to yaw were measured at an angle of attack of 8° and are compared with the previous yawed tests on figure 41. The standard hydrostabilizer was then attached to the hull at 7.5° and tested. The results of the tests of the alternate at 4.5° and the standard at 7.5° are compared with the previous results of the standard at 6° in figure 40.

Effect of faired hull sides.—(Figs. 42 and 43 [*not reproduced*]; tests 24 and 25.) The hull sides were faired out with modeling clay as shown on figures 42 and 43. The overall width of the hull was increased $1\frac{1}{2}$ inches at the maximum width. The effect of this fairing is shown on figure 44 [*not reproduced*].

Langley Memorial Aeronautical Laboratory,
National Advisory Committee for Aeronautics
Langley Field, Va., September 2, 1936.
Carl J. Wenzinger, Associate Aeronautical Engineer.
Joseph A. Shortal, Junior Mechanical Engineer.

Document 5-23 (b), Wellwood E. Beall, Engineer in Charge of All Commercial Projects, Engineering Department, Boeing Aircraft Company, "Design Aspects of the Boeing Trans-Atlantic Clipper," presented at the Air Transport Meeting of the Institute of Aeronautical Sciences, Chicago, IL, 18-19 November 1938.

Although most of you are more or less familiar with the general characteristics of the Boeing Model 314 long-range flying boat, it is believed that you will be interested in knowing the original design criteria for this boat, or in other words, the problem that the Boeing engineers had before them when they started on this design.

The primary requirements for the 314 were principally *fourfold*: **First**, to transport 10,000 lbs. of payload 2400 statute [*sic*] miles against a 30-mile[-]per[-]hour head wind at a cruising speed of 150 MPH at an altitude of 10,000 feet,

Second, to produce a machine which can be efficiently operated with a minimum of fatigue to the crew and a minimum of maintenance,

Third, to provide efficiently, unprecedented comfort, spaciousness and luxury for the passengers,

Fourth, and not least in importance, to develop an aircraft which will be as inherently safe as it can possibly be made with the existing knowledge of materials, equipment and the science of aviation.

With these objectives in mind, the Boeing engineers set out to design an aircraft capable of fulfilling these criteria.

In order to fulfill the first requirement of payload, speed and range it was soon determined that the aircraft's gross weight would have to be something greater than 80,000 pounds. At the outset it was decided to use four engines. This meant that engines larger than any then in commercial operation would be necessary. Fortunately, the Wright Aeronautical Corporation was just concluding tests on their new 14-cylinder double-row engine which would easily develop 1500 horsepower for takeoff and would have a "maximum except takeoff" rating of 1200 horsepower. These new Wright GR-2600-A2 engines just filled the bill and so they were selected for this aircraft by Pan American Airways. At this same time, the Hamilton Standard Propeller Company was ready to present to the industry their Hydromatic Full-Feathering Propeller. Three-bladed fourteen-foot[-]diameter Hydromatics were selected.

The design took shape and we found that it had a span of 152 feet, a length of 106 feet, a hull beam of 12½ feet, and a maximum hull depth of just under 19 feet. The final design gross weight turned out to be 82,500 pounds. The maximum fuel tankage turned out to be 4300 gallons and maximum oil tankage 300 gallons. Naturally, these quantities are more than enough to meet the payload, speed and range requirement.

In order to fulfill the performance requirements it was necessary to develop a design, efficient aerodynamically, and yet not too heavy in weight or too expensive.

This is, of course, the old, old story, but the problem becomes really serious on long-range aircraft because of the larger amount of fuel required for every extra pound of drag. In other words, the savings in weight of fuel required must be balanced against the cost in weight of any refinement in design which will reduce the drag. Naturally, the design speed and range are important factors in this computation.

Thus, it was decided that all surfaces were to be cantilever and that the ship must be as clean as practicable. The aerodynamic and hydrodynamic design then progressed and a brief description follows.

An aspect ratio of 8.05 was chosen for the wing because it was a balance between aerodynamic and structural considerations. Primarily, in order to keep the structural weight down the wing was tapered in both plan and thickness, the taper in plan form being approximately 4 to 1. Even with this amount of taper in plan, no adverse tip stalling has been experienced. These tapers had other advantages in that they produced a thicker wing section near the root, allowing passageways for the crew to get to the engine nacelles and also allowing space for large cargo holds in the wing stub. The symmetrical NACA 0018 section was used at the root and was tapered in thickness to the 0010 section of the same series at the tip. The aerodynamical advantages of using a symmetrical section are that it has low profile drag and high L/D ratio in the cruising range and from a structural viewpoint is easier to jig and construct because of the identical contours on both the upper and lower surfaces. Although the maximum lift coefficient of a symmetrical section without flaps is usually lower than that of many high lift sections, the addition of flaps to the symmetrical section usually improves the lift coefficient to that equal to the best of the so-called high lift sections.

The Model 314 utilizes a split trailing edge wing flap along these portions of the span not occupied by the hull and ailerons. During landings, the full flap deflection of 60 degrees is usually utilized; while for take-off, an angle of 20° is beneficial.

The hull is designed so that the center section of the wing passes through the upper portion of the hull in such a manner as to produce a clean intersection between the hull and the wing, thus reducing the interference drag usually found with cabane arrangements where the wing is mounted above the hull. This arrangement also allows, without much increase in weight, additional volume for passenger and crew accommodations.

The hull bottom has an athwartship main step and a pointed rear step. The pointed rear step produces less aerodynamic drag than the usual athwartship rear step, yet has excellent water running characteristics and allows the practical installation of a water rudder so necessary on large flying boats.

The hull bottom lines and chines were designed to keep the bow wave as clean and low as possible in order to keep the hull dry, and to give quick takeoff characteristics. Flight and taxi tests have shown that this hull is remarkably dry, has exceptionally clean running characteristics and has extremely low takeoff time.

Takeoff times range from 17 to 58 seconds, depending on the loading, condition of wind and water, and on the technique used for the takeoff.

The lines of the after portion of the hull upper body were rather difficult to fair because of the desire to keep sections large in order to provide ample room inside as far aft as possible for passenger accommodations and to allow for a good stiff attachment of the tail surfaces. A suitable compromise was made and although these lines were found satisfactory in the wind tunnel, we afterwards learned during our flight tests that these lines interfered somewhat with the satisfactory function of the original fin and rudder.

Lateral stability on the water was obtained by the use of hydrostabilizers, sometimes referred to as sponsons or sea wings. Hydrostabilizers have long been used in Europe and are being used by a contemporary American aircraft. They have some very definite advantages as compared to wing tip floats, such as excellent characteristics for taxiing or maneuvering on the water at high speeds; turns can be made at any direction to the wind in any normal wind velocities; they are more seaworthy in rough water; they provide excellent loading platforms; are a better place to store fuel than in the hull; and are structurally sounder and safer. Naturally, they have some disadvantages, such as greater weight and aerodynamic drag, and, with the aircraft traveling at slow water speeds they allow greater heeling angles in strong side winds.

The form of the hydrostabilizers and their exact location on, and angles to, the hull are somewhat critical. Inasmuch as there were no tank test data on hydrostabilizers available for study and comparison with full-scale results, we had no definite method of correcting our towing model test results to full-scale performance. During taxi tests, we found it desirable to reduce the dead rise of the hydrostabilizers from $7\frac{1}{2}^\circ$ to $4\frac{1}{2}^\circ$. This reduced angle provides the same righting moment at 3° less angle of heel. This change was easily made because of the nature of the design. The tests following this change have indicated satisfactory lateral stability [*sic*] on the water has been obtained. We have towed our model many hours on Lake Washington and have compared it with our full-scale tests and now believe the changes made could have been avoided if more related full-scale test data and model test data had been available.

The control surfaces and flight control systems on such a large aircraft are always, needless to say, great design problems. However, these problems have been effectively solved by the use of the regular Boeing system of trim and control tabs. The control system was designed as follows.

The ailerons are of the Frieze balanced type operated differentially thru a semi-irreversible gear segment and worm, connected directly to the aileron cable system. Incidentally, each aileron is divided half way along its span, so that in reality there are two ailerons on each side of the aircraft. The purpose of this is to prevent any possible binding of the hinges due to wind deflection. The two ailerons on the same side are connected together thru the control cables and operate as a unit. Only

trim tabs are used on the ailerons, one being mounted on the inboard end of each inboard aileron.

The elevators are comparatively large and would be difficult to control by any conventional system. However, they are quite easily operated by means of control tabs which are directly connected to the elevator control system. The elevator surfaces themselves are also connected to the control system thru spring links so that a slight movement of the controls moves the control tab and also applies a slight pressure directly to the elevator surface thru the spring links. For large movements of the controls, the control tabs are moved thru their maximum deflection, in which event the springs in the links are deflected to such an extent that the link becomes, in effect, a solid link and any further force on the controls is transmitted directly to the control surfaces. This later *[sic]* phenomenon only occurs during stalled landings. Each elevator is also equipped with a trim tab. No aerodynamic balance is required. Each control tab is, of course, made nearly twice as effective as the corresponding trim tab so that adequate control may be obtained at any trim setting. By altering the initial spring loadings in the spring links, by adjusting the deflection angles and by altering the areas of the control tabs, nearly any desired amount of control force may be produced. The elevators are dynamically mass balanced to a zero coefficient and are statically balanced to 85%. These balances are produced by one counterweight in the center of the hull and a mass balance at the tip of each elevator.

The rudders are each equipped with a control tab and spring link system similar to that provided on the elevators. The rudders are slightly aerodynamically balanced by small portions of surface ahead of their hinge lines.

Originally, this aircraft was equipped with a single fin and rudder and, although the original wind-tunnel tests indicated that this installation would be satisfactory, flight tests indicated that the flight characteristics would be improved by a change in the tail surface design. Although the original specifications stated that the aircraft should be only slightly stable directionally, it was found, during flight tests, that this requirement was in error because the great amount of lateral stability inherent to this type of aircraft necessitated considerabl[y] more directional stability in order to keep the ratio of lateral and directional stabilities within a reasonable range. A low ratio of directional to lateral stability produces an annoying flight characteristic known as the 'Dutch Roll'. This, and the effect of the after hull lines are the reasons for the change to three fins and two rudders. The final design of the empennage has produced excellent flying characteristics, resulting in an aircraft which will stay almost dead on course for protracted lengths of time and yet has the lightness of control of a pursuit plane.

Having determined the original design as just now described, a program of model testing was laid out. A one-twenty-fifth size wind-tunnel model and a one-tenth size towing tank model were constructed and shipped to the NACA where extensive tests were conducted. We were indeed very fortunate in that the NACA

found it possible for the first time in American aeronautics to run the wind tunnel and the towing-tank tests simultaneously. All changes in the design were made on both models and tested simultaneously and it was possible to determine optimum compromises between water and air characteristics. Both models were so constructed that the angle, and the vertical and horizontal positions of the hydrostabilizers[,] could be changed. Several different forms and shapes of hydrostabilizers were tested and the optimum compromise design selected. In addition to the tests on those two scale models a one-fourth size model of the wing was tested in the NACA full-scale tunnel.

After completion of the tunnel and tank tests, the detail engineering was rushed and in twenty-two months from the signing of the contract the first ship was flown.

All through the design and construction periods of this boat, accurate weight control has been maintained. Strange as it may seem, we have been able, even with the changes in tail surfaces, to meet our design payload; not only that, but the weight of the aircraft on its actual weighing was within approximately fifty pounds, or about one-tenth of one per cent, of the estimated weight empty.

During these last few months of test flying, a tremendous amount of full-flight performance data has accumulated. These data and the actual weight figures show that the design requirement of payload, speed and range has been adequately met.

Now we come to the next item on our list of criteria. This item relates to the *efficiency of operation*. Each airline operator will propound a different definition for the *efficiency of operation* but the definition to which we refer here, we believe, will cover points generally conceded to be included in all such definitions.

Efficiency of operation, disregarding the actual aerodynamic performance of the aircraft, embraces, first, the ease by which the crew can handle the aircraft in the air and on the water and, second, the ease of maintenance. Factors contributing to the ease of handling include proper distribution of responsibility among the crew, the arrangement and convenience of all controls, equipment, and instruments, the comfort and accommodations provided for those members of the crew, both on and off duty, efficient and simple methods for loading fuel, cargo and passengers, arrangement of mooring devices, and methods of beaching. The designer strives to reduce maintenance by providing good initial design that requires a minimum of attention and by providing good access for inspection and repair to parts that will require maintenance.

At the outset it was recognized that this aircraft was primarily a long-range transport and that every effort should be made to provide the crew with every conceivable aid, not only in equipment, but in comfort and accommodations. It was decided that the duties of the crew should be so delegated that a flight crew of six would be on duty at all times. This crew consists of a Master, or Watch Officer, whose duty it is to correlate the functions of the other crew members, a first pilot, a second pilot, a navigator, a radio operator, and a flight engineer. Briefly, the pilots' duties are to fly in a given direction at a given altitude and speed in accordance

with data furnished by the navigator. The flight engineer is responsible for the proper functioning of the powerplants, including the calculation of power and fuel required to fly under the conditions set by the navigator and the pilot. The radio operator is assigned the responsibility of maintaining contact with the ground stations and to furnish radio bearings to the navigator.

With these duties in mind the Boeing engineers set out to design a control cabin to accommodate this crew in such a manner that they might operate most efficiently. The result is a control cabin which has an average head room of six feet one and one-half inches, it is twenty-one feet four inches long and is nine feet six inches wide and which would put many a good ocean surface vessel to shame. At its forward end are located the two pilots' stations with an aisle between which leads under the instrument board and through the collision bulkhead into the bow compartment.

On the left side of the control cabin just behind the first pilot's station is the navigator's station. Still further aft on the same side is the watch officer's seat and table and the navigator's seat. Immediately behind the second pilot's station is a spiral staircase leading down to the passenger's deck. Aft of this is located the radio operator's station and still further toward the rear is the flight engineer's station.

Recently, during flight tests, eleven men were busily engaged taking test readings and there was no crowding or inconvenience. The other day during a broadcast, while still on the water but with all engines running, I counted seventeen men in the control cabin. It is believed that a brief description of these stations would be of interest.

The pilots' stations were designed to provide a maximum of comfort, visibility and simplicity. Comfort is obtained by making each pilot's seat deeply upholstered and adjustable as to height, fore and aft position, and angle of back. In addition, these seats are equipped with padded and upholstered arms which may be swung out of the way for easy entry. So that even a pilot with a bad case of gout could be comfortable, the angle of the rudder pedal faces has been made adjustable, in addition to a large range of fore and aft adjustment.

Both flight and powerplant controls are duplicated at each pilot's station. The engine and trim tab controls provided for the first pilot are mounted on a stand located to the left of his seat, while a duplicate set of these controls is located to the right of the second pilot's seat. Mounted on each control stand are the elevator, aileron, and rudder trim tab wheels, with indicators for each, four throttles, a master control lever for mixtures, a master control lever for the automatic manifold pressure regulators, and a master control switch for the propeller speed controls. This master propeller speed switch is, incidentally, mounted ingeniously on one of the throttle levers in such a position that, with the hand on all throttles, this switch may be easily operated in either direction by the pilot's thumb.

You perhaps have noted that all the engine controls available to the pilots, except the throttles, are master controls: that is, controls which function at all

engines simultaneously. Individual throttles are, of course, necessary to the pilots for maneuvering on the water. An attempt has been made to relieve the pilots of as much work in connection with the powerplants as possible and for this reason the full responsibility of the powerplants has been charged to the flight engineer, except that, however, the pilots may take full control of the power output at any time by means of their master controls. The reasons for this are obvious. Either pilot may change the propeller speed of all four engines at one time, but they must be synchronized by the flight engineer, who has the individual controls. The same applies to the mixture and automatic manifold pressure controls.

The pilot's instrument board is very much simplified as compared to contemporary aircraft. Each pilot has ahead of him an identical group of six flight instruments, altimeter, airspeed indicator, rate of climb indicator, bank and turn indicator, artificial horizon and directional gyro. Between these two groups is mounted the gyro pilot and above the gyro pilot are located the only engine instruments on this board: two dual tachometers and two dual manifold pressure gages. The other instruments on the board are two compasses, an outside air temperature indicator, a clock, two pressure gages for the gyro pilot, and an instrument vacuum gage.

An interesting innovation is the remote controls for the gyro pilot. At a comfortable position beside each pilot are mounted two little wheels at right angles to each other: one for making turns and one for operating the elevators. With the gyro pilot in operation, either pilot may sit back and may, for example, turn the ship any number of degrees to the left or right by simply rotating the turn wheel a few revolutions. This is a mechanical device which accomplishes this result by rotating the "follow-up pulleys" of the gyro pilot on their shafts.

The next important station in the control cabin is that of the flight engineer. He sits in a deeply upholstered swivel chair in front of a rather large table. Above the table and on the wall is a large shock mounted instrument board carrying twenty-six instruments of which twenty[-]one are dual indicators and one which is a precision potentiometer, reading the temperatures of the heads and bases of two cylinders on each engine. To the right of this instrument board are six large hand wheels which control the fuel systems. To the left of the instrument board is mounted a panel which carries a bank of warning lights and the electrical switches which are to be operated by the flight engineer.

As mentioned before, the flight engineer has individual controls for each engine, some of which are interconnected to the pilot's master controls. The flight engineer's controls consist of propeller feathering, propeller speed, cowl flap, automatic manifold pressure regulator, and mixture controls. These are all located along the outboard edge of the table in easy reach of the flight engineer.

The radio operator's station is also equipped with a deeply upholstered swivel chair and a table upon which is mounted a certain portion of the radio equipment.

The navigator's station consists of a large chart table equipped with two large chart drawers and a cabinet with six compartment [*sic*] for stowing instruments,

books and supplies. Navigation instruments permanently mounted include an aperiodic compass, chronometer, altimeter, airspeed indicator, outside air temperature indicator, and a Gatty drift indicator.

In addition to these instruments which are all located at the navigator's station, there are provided two drift sight stations for taking the ship's drift with a pelorus. These drift sight stations are accessible from the crew's quarters through doors in each side of the hull and are located in the lower surface of the wing near the trailing edge. Also, a streamlined observatory for making celestial observations is built into the large cargo loading hatch in the top of the hull. A folding seat is mounted under this observatory so that the navigator may comfortably take his observations. Incidentally, this observatory is just over the center of gravity of the aircraft and therefore is in an ideal location.

The control cabin is completely lined and trimmed in the same fashion as the passenger compartments, even to the window shades and the rug on the floor. No plumbing or wiring is visible and we believe this control cabin is unprecedented in appearance, comfort, arrangement and utility. In producing such accommodations for the crew to work in, we believe we have minimized their fatigue, conserved their energy, and thus increased their efficiency for long-range operation.

During the period of preliminary design it was decided that the ship should have two decks: one entirely for the passengers and the other to be the flight deck accommodating the crew and cargo. The flight deck is comprised of three main sections: the control cabin which has already been described, the baggage, mail and cargo compartments, and the crew's quarters.

Behind the control cabin and in the center section of the wing and hull may be found the baggage, mail and cargo compartments. Still farther aft are the crew's quarters in which there are three berths, provisions for stowing clothes and crew's personal equipment and part of the ship's radio equipment. In addition to the three berths provided in the crew's quarters, four more folding bunks are located in the bow compartment so that[,] in all[,] there are seven berths available for the crew.

In order to facilitate maintenance and thus increase the efficiency of operation no effort has been spared to make every part as accessible for inspection and repair as possible. In order to do this we decided it would be necessary to make the design such that the engines would be accessible in flight. Access to all engines is made through two doors, one on each side of the control cabin, which lead to passageways just forward of the front spar. These passageways lead to two nacelles on each side. Slight men can transverse these passageways in a crouched position, while heavier man [*sic*] travel more easily on their hands and knees.

Each engine nacelle is sixty-nine inches in diameter and holds four men comfortably. A stainless steel firewall, which can be easily removed in two sections in flight, is mounted behind each engine, thus permitting access to the rear of engines and engine accessories in flight. It has been said that the advantages of having access to the engines and powerplant installation in flight are only problematical [*sic*], but

flight tests to date indicate that the advantages realized far exceed even our expectations. An example or two may be of interest: One time the ship was moored out in Lake Washington and an attempt was made to start the engines. Three engines started nicely but the fourth engine refused to respond. The flight engineer soon determined that the engine was not getting prime, so one of the crew members went out into the nacelle, removed the primer solenoid, operated the valve by hand, and the engine started immediately and the flight test program was carried out. This all happened so quickly that some of the other crew members and those on shore had no idea that there had been any trouble. Another time some changes had been made in the engines and the engine service men had no opportunity before flight tests to accurately set the relief pressure of the relief valve in an engine oil pump before flight tests. After we had been in the air several minutes that engine was stopped, the relief valve removed, reset, reassembled, and the engine started again. Our scheduled test flight would have been delayed had we not been able to make the final setting in the air.

There can be no doubt that the mere fact that you may diagnose the trouble, even though no repairs can be made, is of tremendous value. For example, on one flight quite a quantity of hot engine oil was found leaking on the deck. It would be natural to suppose that one of the engine oil systems had failed, but with all lines accessible, it was quickly discovered that there was a loose connection on the vacuum system oil separator drain line. A method of catching this oil was quickly rigged up and the flight continued. If no diagnosis could have been made, the crew would have been obliged to land the aircraft under the circumstances.

All tanks, valves and the greater portion of the plumbing for the engine lubrication, deicer fluid, hydraulic oil, water vacuum and fuel systems are accessible in flight. This means that inspections may be made periodically during flight and trouble discovered before it reaches dangerous proportions. It is believed this type of design contributes immeasurably to the efficiency and safety of operation so necessary for long-range flights.

Based, in part, on the provisions for the crew and on the ease of inspection and maintenance, we conclude that the second requirement for efficiency of operations is fulfilled.

We now come to our third design criteria [*sic*] and, naturally, the one which most concerns the traffic departments: the passenger accommodations. The design problem was to provide passenger accommodations which embodied unprecedented comfort, spaciousness, and luxury at reasonable weight and cost.

The passengers' deck is divided into eleven sections: five standard compartments seating ten and sleeping six, one special compartment seating four and sleeping two, one deluxe compartment seating six and sleeping two, and a dining salon seating fourteen at five tables, a galley, a dressing room for men, a dressing room for the ladies, and three toilet compartments.

Thus, for this standard arrangement, seventy-four passengers can be seated in the daytime, at night thirty-four berths may be set up, still leaving fourteen seats

available in the dining salon and three in the deluxe compartment. For the stewards, there are two additional folding seats located in the aisle by the galley.

Incidentally, the dining salon furniture is quickly interchangeable with a set of lounge furniture which, in the daytime, seats eleven and which, at night, sleeps six. Using this arrangement, seventy-one passengers may be seated in the daytime and at night forty berths may be made up, leaving two seats still available in the deluxe compartment.

It is expected that the Model 314 will be certificated for a total of eighty-nine places: seventy-four passengers and fifteen crew.

The passengers on the Model 314 have an exceptional amount of room at their disposal. In the past the amounts of cabin area and volume per passenger, and the weight of the cabin furnishings and equipment per passenger, have been fair measures of the passenger's comfort. These figures have been increasing steadily as each new aircraft is designed.

A rough idea of these increases are shown by the following approximate comparisons. A Boeing Model 80-A provided 7.3 square feet of floor space, 45.7 cubic feet of cabin volume, and 47.5 pounds of furnishings and equipment per passenger. These figures were, respectively, 8.0 square feet, 48.8 cubic feet, and 77.3 pounds for the Model 247-D and 17.9 square feet, 112 cubic feet and 130 pounds per passenger for night operations for the Model 307. On the other hand, the Model 314 provides 22 square feet of deck space, 164 cubic feet of cabin volume, and 175 pounds of furnishings and equipment per passenger for night operations. From these comparisons you may see what progress has been made.

Most of the seats are of the davenport type, especially suitable for long-range flying. These seats are low, deep and wide, with adjustable back cushions. The occasional chairs and the seats in the dining salon are of the upright variety, deeply upholstered and cushioned with rubberized curled hair. The intention has been to duplicate the types and comfort of the chairs and furnishings found in the passenger's own home.

The berths are made up from the davenport type seats and are designed to be very comfortable, utilizing the four-inch[-]thick, rubberized, curled-hair seat cushions and backs as mattresses. Most of the berths are six feet 3 inches long and 32 inches wide, and many are 7 feet 4 inches long and 38 inches wide. All have at least 35½ inches head room. All berths are equipped with an outside window, individual ventilator, reading light, steward's call button, clothes rack, and hangers, as well as the necessary pillows, linen, blankets and spreads.

The deluxe compartment is furnished with a love seat, an occasional chair, a coffee table, a combination dressing table and writing desk, a dressing table seat and a folding wash stand, with attendant light fixtures, mirrors, waste containers, etc.

The galley is not only equipped with an icebox, but with a steam table[,] and boasts a bar which may be rigged up across the galley doorway. The galley equipment is very complete and weighs 234 pounds, while the estimated weight of the

foodstuffs and galley supplies is 256 pounds[,] making a total of 490 pounds. In addition, there are two drinking fountains, one on each end of the passengers' deck. Incidentally, the galley equipment was designed and built by Pan American Airways.

The ladies' dressing room is furnished in the modern style and is equipped with a hand lavatory with hot and cold running water, a dental lavatory and a large double dressing table complete with four lights, two large plateglass mirrors, two benches, receptacles for Kleenex, etc. A ladies' toilet compartment opens from this dressing room. Incidentally, each toilet on this ship is equipped with standard size toilet seat and is of the flushing type. The flushing water is the waste water from the hand and dental lavatories. As the toilet top is raised, a cylinder is filled with this water and when the lid is lowered this cylinder discharges the water, flushing the toilet bowl[,] and then the contents are dumped outside the aircraft.

The men's dressing room is fitted with two hand lavatories with hot and cold running water, one dental lavatory and, believe it or not, a stand up urinal. This urinal will no doubt be an interesting innovation to the passengers. A separate toilet compartment opens off the men's dressing room.

The interior decorations throughout the passenger deck are in keeping with the present-day trend of modern design, simple, functional, and in refreshing color arrangement. Fabrics for both upholstery and lining are interesting in texture and design and are all flameproofed. All compartment lining and soundproofing is quickly removable for inspection and cleaning and, therefore, can be kept in excellent condition.

Time will not allow me to go further into the details of this interior, but there can be no doubt to those who have seen the actual installation that the design objective of unprecedented passenger comfort, spaciousness and luxury has been realized.

Although safety appeared fourth on the list of design criteria, it was by no means the least important and was, in fact, uppermost in our minds during the design and construction processes. No compromise with safety was ever made. Naturally, all manufacturers and operators strive to make and operate their equipment as safe as possible and both the Pan American Airways and Boeing organizations set out to embody safety in the fundamental design and to make the 314 one of the safest aircraft possible with present-day knowledge of the science of aviation. We believe we have accomplished this aim, and in order to illustrate the extent and thoroughness of our endeavor along this line a few safety provisions will be discussed.

No doubt many of the items which will be mentioned have long since been considered and incorporated in certain equipment, but the thoroughness with which we have attacked them may be interesting.

Roughly speaking, aircraft accidents come under two general headings—mechanical failures and personnel errors. Obviously, accidents under both these headings are more or less the joint responsibility of the manufacturer and operator. Therefore, we as a manufacturer have attempted to reduce mechanical failures by producing conservative structures; trouble free mechanical accessories; simple and

sturdy installations for fuel, oil, hydraulic, vacuum, and electrical systems; and have attempted to provide a maximum of accessibility so that all parts may be easily inspected and maintained. We also have attempted to reduce the personnel errors by eliminating as much fatigue from the crew as possible, by dividing up their duties so that no man is overloaded, and by giving them proper tools with which to work.

It is outside the scope of this paper to discuss the relative safety merits of multi-engined aircraft, but at this time it is generally conceded that for long range operations four engines are very desirable.

Early in the initial stages of the design it was decided even at considerable expense to payload and performance to use hydrostabilizers instead of outboard floats for lateral stability on the water. Certain advantages and disadvantages of hydrostabilizers have already been mentioned, but the main reason for selecting hydrostabilizers as the means of lateral stability on the water was safety. There can be no doubt that hydrostabilizers are structurally more sound and allow greater maneuverability for this size aircraft on the water than floats. One of the few disadvantages of the hydrostabilizers is that they allow greater heeling angles in high side winds during a certain narrow range of water speeds. These large heeling angles may be easily eliminated in operations by merely staying out of the speed range and wind angles in which they are produced. This technique is current practice in operating all flying boats using hydrostabilizers. This disadvantage was recognized at the outset because it is inherent in all designs using this means of lateral stability. Knowing this, the wing tip sections of the Model 314 wing were made into flotation tanks. Hence, the instant a wing tip contacts the water a large lateral righting moment comes into action. In addition, certain reinforcements and provisions were made so that no damage would result from wing dipping, should it occur.

As a precaution against the loss of buoyancy in the hydrostabilizers each is divided into five fuel[-] and watertight compartments, two of which are used as fuel tanks. Thus, damage to a part of a hydrostabilizer will not greatly reduce its buoyancy or lateral righting moment.

A boat of this size will no doubt sometime[s] encounter rough water and adverse weather, and in anticipation of those events it carries a 91 pound anchor with 150 feet of 3 inch line, a 6 foot sea anchor, two sway buckets which may be rigged to hang in the water from a point half-way out on the wing, and a quantity of special oil to calm the water. Thus, we believe a great deal has been done to combat nearly any condition of wind and wave which might be encountered.

Similar to large surface vessels the 314 hull uses a system of flotation tanks—a so-called double bottom, instead of having semi-watertight bulkheads with doors at intervals across the passengers' accommodations. In an actual emergency it is doubtful if these doors would ever be found, much less rigged into place. It is believed that this hazard has been eliminated by the use of hull flotation tanks.

The hull is divided into three main sections, the bow compartment, the passenger cabin, and the tail section. This division is made by two completely watertight bulkheads—one about 13 feet from the bow and called the collision bulkhead—and another called the tail bulkhead, located just ahead of the stabilizer. The passenger accommodations and the flight deck above are entirely between these two bulkheads. The space below the passengers' deck is divided into 9 watertight flotation tanks. The bottoms of these flotation tanks are formed by the bottom plating of the hull; their sides by the sides of the hull; their tops by the watertight passengers' deck; and their ends by the main two aforementioned bulkheads plus 7 intermediate watertight bulkheads. Located in a convenient position in the deck above each flotation tank is a quickly operable inspection door large enough to allow a quick and thorough inspection of the whole flotation tank.

Each one of these flotation tanks as well as the watertight compartment is positively vented by a forced ventilation system. In order to produce actual continuous air flow each tank or compartment has two vent connections—one for air under positive pressure, and one under negative pressure.

Then, in the event that something does happen to the aircraft, unusual provisions have been made for the egress of passengers and crew. Each standard passengers' compartment has two 19 by 25 inch rectangular auxiliary exits—one on each side. The de luxe compartment is also equipped with one of these large exits and those passengers in the dining salon may use either one of the two main entrance doors which are located one on each side. In addition, there is an escape ladder leading to an auxiliary exit in the top of the hull, located just forward of the de luxe compartment. Counting the stairway up to the flight deck, there are 15 well-distributed and accessible avenues of escape. It is our belief that at least some of these avenues would be available for use in case of an accident on the water no matter what position the aircraft assumes.

The flight deck is also equipped with many well[-]distributed exits. At the forward end of the control cabin there is a door through the collision bulkhead into the bow compartment where there are available two outside doors. Above the first pilot's seat is an auxiliary exit. The sliding side windows of the cockpit enclosure might also be used. Behind the copilot's station is the staircase leading down to the passengers' deck. At the rear of the control cabin are three doors—one on each side, leading to the engine nacelles which in turn have two outside doors each—and another, leading to the baggage, mail and cargo compartments. These compartments are equipped with three outside doors—the main cargo loading hatch, through the top of the hull[,] and two other hatches opening through the bottoms of the outboard cargo compartments on to the hydrostabilizers. Egress from the crew's quarters can be made through the bottom surface of the wing by means of the two drift sight stations or forward into the baggage, mail and cargo compartments.

Now that we have the passengers and crew out of the ship, we find that they have available eight 10-man collapsible life rafts, one of which is equipped with a

sail, navigation instruments, and a water distiller. Although these boats are stowed near auxiliary exits, they may be overlooked by the passengers during their hurried exit, and against that eventuality four of these boats have been so stowed that by ripping a panel in the wing they may be obtained from outside the ship.

Although each passenger's seat is equipped with a life jacket, an extra 40 jackets may be stowed with the life boats in the wings and are accessible from both inside and outside the ship. In addition to the above described equipment there are two ring buoys, signal lights, a Very pistol, a bucket, axe, heaving lines, etc.

Particular attention was given to the powerplants from a safety angle; it was decided that the failure of any one engine should not cause any of the aircraft's energy systems, such as the gyro pilot hydraulic system, to cease to operate; and it was also decided to isolate and make each engine as independent as possible from the others, yet be able to assist each other in operating if necessary. For example, each engine has its own independent lubricating oil system, yet it is possible while in flight to transfer oil from one tank to another. Another example is that of the fuel system. There are two 600 gallon fuel tanks in the fuel feed system, each of which normally supplies two engines. However, if necessary, all engines may be operated from either tank. Also, in the case of an engine driven fuel pump failure, auxiliary cross feeds are provided so that fuel may be transferred to that engine from a pump on another engine. Also, of course, there are the normal hand wobble pumps—one of which is provided for each engine.

The fuel transfer system, used for transferring fuel from the hydrostabilizer tanks to the wing tanks, is equipped with two electric pumps and one hand pump so that the failure of any two pumps will not put this sy[s]tem out of commission.

Because of its simplicity and reliability, a 12–24 volt direct current single wire electrical system was chosen. The current source consists of two 80-ampere 15-volt generators so connected to two large 12-volt batteries that each or both generators may be used to charge either battery. The instrument lighting and radio power supply were kept at 12 volts so that this current may be drawn from either battery. For extreme emergencies a small auxiliary gasoline engine driven generator will be carried on board to operate the radio equipment.

Just as a matter of precaution, all the radio equipment is not located in one place—rather it is divided into three parts—portions of it being located in the crew's quarters, at the Radio Operator's station, and in the bow compartment. Thus, in the case of an emergency all radio equipment may not be put out of commission.

The failure of instruments can be a great hazard and it is believed the maximum of safety has been provided in this connection by installing three each of every important flight instrument and two each of every important powerplant instrument. Every instrument is shock mounted and shielded against damage in every way.

One hazard and a source of grief on nearly all aircraft is the heating system. It is believed that the system provided is simple, sturdy, effective, and safe; and

since its design is rather unusual, you may be interested in the brief description which follows:

Although this aircraft uses exhaust stack stoves for heating the air for the ventilating system, it is believed that it is as safe as any system can possibly be made. The exhaust pipes through these stoves are extremely heavy and will resist burning out or cracking. However, in the event there is some sort of failure, the positive pressure on the hot air and the depression in the exhaust system produce a differential pressure so that any leakage will be from the ventilating system into the exhaust system. Also, the ventilating system is equipped with a CO analyser which not only automatically shuts off the heating system and lights the warning lights, but actually indicates the amount of CO concentration. A total of four exhaust heating stoves are installed; two mounted on engine No. 1 and two on engine No. 2. These stoves are equipped with by-pass valves which may be operated manually but which are designed, in case an exhaust stack burns through, to be operated by a fusible link. This allows the stoves in either nacelle to be cut out of the system in case of a stove failure. Incidentally, this heating system is rated 360,000 BTU's per hour and can handle a volume of about 170,000 cubic feet of air per hour. On a long range flight, the lack of heat and ventilation would be a definite hazard, and it is believed that the exhaust heated hot air system is the most reliable type, especially when protected in the manner described.

All of the hazards which have been discussed, although important, are not the hazards that most concern the flight crew and passengers. These hazards are *fire* and *structural failures*.

Obviously, the primary structure has been designed to meet the strength requirements required by the CAA, but it is believed that attention to the structural details plays a most important part in the elimination of failures. A description of the structural details of this ship is outside the scope of this paper, but it is believed that the structural details of the 314 are extremely well designed. For example, no intercostal stringers are allowed in the primary structure; and there are no angle structural clips using only one rivet in any leg. These structural details may seem small in themselves, but they are indicative of the overall design methods. As an example of the extreme precautions taken to insure the proper strengths, an entire wing panel of the identical type used in the 314 was built purely for test purposes and was tested to destruction.

Vibration and flutter are great threats to any aircraft structure and consequently, all fixed and control surfaces and the hull have been thoroughly explored for resonant vibration frequencies. Natural frequencies of each part are computed during the design process and proper divergence in frequencies maintained. Later, after construction and assembly, these surfaces are vibrated throughout the ranges encountered in flight and records taken of resonant and relative frequencies. Design changes are made when necessary. Then, during flight tests records of engines and other inducing frequencies are obtained. By all these means it was made certain that the Model 314 was free from vibration and flutter.

Fire—probably the greatest of all hazards[—]has been treated with the greatest of respect and considerable effort has been expended to eliminate it. As an example—all fabrics used in the aircraft, including curtains, rugs, upholstery, and sound-proofing[,] have been flameproofed. Incidentally, at least two dozen flameproofing processes were tried before we found one that would meet our specifications.

Wherever explosive fumes may be present, electric motors are enclosed in ventilated fume-tight cases. In addition, those electric motors driving fuel pumps are explosion-proof and have been actually tested by the Underwriters Laboratories and have received their approval.

The fire hazard from the fumes of stored fuel is always great and therefore, no fuel is stored in the hull. All fuel storage tanks are located in the hydrostabilizers and are separated from the hull by at least one flotation tank. The wing fuel tanks are separated from the hull by solid sheet metal partitions so that[,] at least for a time[,] a gasoline fire would be isolated and more easily combated. Not only that, but these wing tanks are accessible in flight so that any leaks may be detected before they reach dangerous proportions.

All fuel and oil tanks are fitted with Protectoseal fillers which consist of a pair of concentric screens extending from the filler cap down into the tank. Working on the Davie lamp principle, they prevent fire from getting into partially empty fuel and oil tanks. The filler cap of each fuel tank is equipped with a pressure relief valve to relieve any accumulation of fumes or explosion in the tank.

The generous use of stainless steel in the engine sections and in the vicinity of the exhaust systems helps to isolate fires and to protect adjacent aluminum alloy structure.

Inasmuch as the trailing edge of the wing is covered with fabric, those sections behind the exhaust stacks of the engines are painted with an effective flameproof paint discovered only after making many, many tests.

Since the main fire hazard on an aircraft is due to the inflammable fuel it carries, the most effective way to eliminate this hazard would be to develop and use a *non-inflammable* fuel. This is an appeal to the whole aviation industry to back a concerted drive to develop a safe fuel. We know that such a fuel is possible. Doubtless, the development of economical methods of producing such a fuel and the development of the proper engines cannot be accomplished without the consolidated effort of the whole aviation industry. It is believed that every aircraft operator and manufacturer joins me in an appeal to the engine manufacturers and the oil companies to seriously attack this problem.

But we must get back to the 314. Having done all possible to make the crew comfortable and able to operate with a maximum of efficiency and a minimum of fatigue, we believe a great deal has been done to eliminate personnel errors. This, together with the mechanical precautions which have been taken, produces[,] we believe[,] an aircraft which is as safe as any manufacturer can possibly make. Add this to the safety which is inherent to all four-engined equipment and in particular to large flying boats and we present a product which we are proud to show to the world.

Thus we have shown that we have met the four primary requirements of: first, payload, speed, and range; second, efficient operation; third, luxurious passenger accommodations; and fourth, and most important, safety.

In conclusion, the author would like to point out that he believes that although this is the largest and no doubt one of the finest air carriers in production in the world, it is hoped that it will be an inspiration and challenge to other designers to have courage to design even larger and finer aircraft. The Model 314 has lived up to all expectations of its purchaser and has proven that large aircraft can be successfully built. It is hoped that this design will be the stepping stone to even larger, higher performance, more efficient, more luxurious, and safer aircraft.

Document 5-23 (c), Wellwood E. Beall, Chief Engineer, Boeing Aircraft Co., "Clipper of the '40's," Yale Scientific Magazine (Winter 1940): 2-4, 29-31.

"It can't fly—not anything this big! It looks too big to be an airplane!" Such was the comment, scarcely more than a year and a half ago, of more than one visitor whose eyes popped wide and incredulous as they viewed the first of six-41-ton [*sic*] Boeing 314 Pan American Clippers under construction at the Boeing plant in Seattle.

And it did look big, even to those of us who had been with it from the inception of the design. It's [*sic*] inside volume, equivalent to the volume of a five-room house with basement and all, was far more than had ever before been hung on wings in America. But we shared none of the lay visitors' skepticism as to its ability to fly. The art of aeronautical engineering has advanced to the point where it is possible to design a plane to fill a given job and predict quite accurately the plane's flight performance before its throttles have ever been opened. Hence we knew that the airplane would fly, and fly well, and that at most it would require merely some amount of adjustments in its many mechanical details and functions. These would be worked out in the airplane's actual flight test program to make it fulfill the high standards that had been set for it.

Succeeding events have borne out our confidence in the practicability of this large 74-passenger flying boat design. It has made possible the long-sought transatlantic [*sic*] air passenger service to Europe. Already, since the beginning of this service in the mid part of 1939, the 314 Clippers have made more than 100 Atlantic crossings with passengers and mail, and many Pacific crossings. Now Pan American has ordered the construction of six more of the Model 314's to supplement the original six in transatlantic and transpacific operations.

The designing of this airplane, as with most new type airplanes, began with the outlining of the primary requirements which were desired. The study of Pan American's operating needs dictated the following requirements:

- First, the transportation of 10,000 pounds of payload 2,400 statute miles against a 30-mile per hour head wind at a cruising speed of 150 miles per hour at an altitude of 10,000 feet.

- Second, a machine which could be efficiently operated with a minimum of fatigue to the crew and a minimum of maintenance.
- Third, unprecedented comfort, spaciousness and luxury for the passengers.
- Fourth, and not least in importance, the development of an aircraft which would be as inherently safe as it could possibly be made with the existing knowledge of materials, equipment and the science of aviation.

GIGANTIC SPECIFICATIONS

It is interesting to retrace, step by step, the main points of the design program that led to the realization of these objectives.

In order to fulfill the first requirement of payload, speed and range, it was soon determined that the aircraft's gross weight would have to be something greater than 80,000 pounds. It was decided at the outset to use four engines, and calculations showed that they would have to be more powerful than any then in commercial operation. The new 14-cylinder double-row Cyclones which had just been developed by the Wright Aeronautical Corporation filled the bill exactly. They would develop 1500 horsepower each for takeoff and had a normal rating of 1200 horsepower for the altitude. Fourteen-foot propellers of the new Hamilton Standard hydromatic full-feathering type were selected to translate this power into action.

Based on the power available from these power plants, the design of the airplane took form. Calculations showed that the requirements would be filled by a wing of the same large scale as had been developed for the huge Boeing B-15 superbomber, the "big brother" of the Boeing B-17 Flying Fortresses. This wing had already been fully engineered and tested. One complete wing panel had even been built separately for test purposes and had been tested to the destruction point with lead weights—to prove the absolute accuracy of engineering calculations. This wing also had the great advantage of allowing access to the engines during flight, by way of a catwalk through the leading edge of the wings to the engine nacelles.

So, substantially this same wing was adopted for the 314 Clipper design. The hull proportions were then arranged to provide maximum room for passenger accommodations and control quarters. When the design took final shape we found that the airplane would have a span of 152 feet, a length of 106 feet, a hull beam of 12½ feet, and a maximum hull depth of just under 19 feet. The final design gross weight turned out to be 82,500 pounds. The maximum fuel tankage turned out to be 4200 gallons and maximum oil tankage, 300 gallons. Naturally, these qualities were more than enough to meet the payload, speed and range requirements.

To fulfill the performance requirements it was necessary to develop a design which would be efficient aerodynamically and yet not too heavy in weight or too expensive. This becomes of great importance on long-range aircraft because of the larger amount of fuel required for every extra pound of drag.

BOMBER PAVES WAY

Thus it was decided that all surfaces were to be cantilever, without outside bracing of any kind, and that the ship was to be just as “clean” aerodynamically as practicable. Already the way had been paved for this type of construction by the four-engine Flying Fortress bombers.

The hull was designed so that the center section of the wing would pass through the upper portion of the hull in such a manner as to produce a clean intersection between the hull and the wing, rather than to have the wing supported above the hull. This arrangement also allowed additional volume within the hull and it became possible to provide two full decks, the upper deck to be devoted entirely to spacious control rooms, cargo space, and crew living quarters[;] the lower deck to be given over completely to passenger accommodations. Thus the passenger deck could be divided into square-walled rooms with a good ceiling height for upper berths, as there would be no narrowing at the top for upper curvature of the hull.

It was decided to provide lateral stability on the water by means of hydrostabilizers rather than wing-tip floats. Former usage had shown the hydrostabilizers to have some definite advantages, such as excellent characteristics for taxiing or maneuvering on the water at high speeds, seaworthiness in rough water, and structural soundness. In addition they provided convenient loading platforms and proved a better place to store fuel than in the hull proper.

The hull bottom lines were designed to keep the bow wave as clean and low as possible, in order to keep the hull dry and to give quick take-off characteristics. As a result the plane was able to show extremely low takeoff time, ranging from 17 to 58 seconds, depending on the loading, condition of wind and water, and the technique used for the takeoff.

Control surfaces were designed to incorporate the Boeing-patented “tab control” system which the company has employed on all its large planes, using the natural effect of airflow on small “tabs” to aid the pilot in moving the larger control surfaces. As a result, the Clipper, despite its great weight, could be handled with the ease of a small sport plane—could be managed with two fingers on the control column and less force on the rudder pedals than normally used in driving a car.

When the initial design had thus been laid out, a program of model testing was begun. A $\frac{1}{25}$ size wind-tunnel model and a $\frac{1}{10}$ size towing tank model of the hull were constructed and shipped to the NACA at Langley Field, Virginia, where extensive tests were conducted. For the first time, in the design of a new flying boat, it was possible to run wind tunnel and the towing-tank tests simultaneously. All changes in the design as the tests progressed were made on both models and tested concurrently, so it was possible to determine the best compromises between water and air characteristics.

HYDROSTABILIZERS

In these model tests, together with subsequent water and flight tests of the actual airplane, the final details of design were determined. In the case of the design of hydrostabilizers, one item on which comparatively little data was available as to relationship between model and full-scale results, several different positions and angles were tested in the tow basin and the best was selected; then a further modification of this angle of attachment was found desirable to give the best results when tests of the full-scale airplane were conducted.

A modification of vertical tail surfaces was also made on the basis of flight research. Originally the plane was designed to have a single fin and rudder, and although the original wind-tunnel tests indicated that this installation would be satisfactory, flight tests indicated that the flight characteristics would be improved by a change in the tail surface design. Although the original specifications stated that the aircraft should be only slightly stable directionally, it was found during flight tests that this requirement was in error because the great amount of lateral stability inherent to this type of aircraft necessitated considerably more directional stability in order to keep the ratio of lateral and directional stability within a reasonable range. This, and a certain amount of interference with fin and rudder effectiveness caused by the large proportions of the after part of the hull, led to a change to three fins and two rudders. The final tail design produced excellent flying characteristics, resulting in an aircraft which would stay almost dead on course for protracted lengths of time and yet retain the lightness of control of a pursuit plane.

Throughout the design of the mechanical details and arrangements of the Clipper we had kept in mind the second point in our list of objectives—efficient operation with a minimum of fatigue to the crew and a minimum of maintenance.

Factors contributing to the ease of handling include proper distribution of responsibility among the crew[;] the arrangement and convenience of all controls, equipment and instruments[;] the comfort and accommodations provided for the members of the crew, both on and off duty[;] efficient and simple methods for loading fuel, cargo and passengers[;] arrangement of mooring devices[;] and methods of beaching.

At the outset it was recognized that this aircraft was primarily a long-range transport and that every effort should be made to provide the crew with every conceivable aid, not only in equipment, but in comfort and accommodations. It was decided that the duties of the crew should be so delegated that a flight crew of six would be on duty at all times, and that spacious quarters should be provided for their use. These crew positions were to be: the master, whose duty it is to correlate the functions of the other crew members; the first and second pilots, whose duties are to fly in a given direction at a given altitude and speed, in accordance with data furnished by the navigator whose position is self explanatory; the flight engineer, responsible for the proper functioning of the power plants, including the

calculation of power and fuel required to fly under the conditions set by the navigator and pilot; and the radio operator, who is assigned the responsibility of maintaining contact with the ground stations and to furnish radio bearings to the navigator.

The control room design that was laid out for these functions had the unprecedented dimensions of 21½ feet long by 9½ feet wide by 6 feet 1½ inches high. A full size “mock-up” in wood was built and provided with dummy equipment so the arrangements could all be tried out in advance. The pilots were given comfortable seats adjustable in many ways and were given only the essential instruments and controls, leaving other work to other crew members. The controls were arranged on convenient stands beside the pilots. An interesting innovation was the remote control system for the automatic gyropilot. At a comfortable position beside each pilot, two little wheels were mounted at right angles to each other: one for making turns and one for operating the elevators. As simply as though he were operating an armchair control of a modern home radio set, either pilot could sit back and govern the action of the ship by merely rotating the little wheels a few revolutions.

The navigator’s station, with navigating instruments and a chart desk large enough to accommodate full size nautical charts, was located just behind the first pilot; and the master’s desk was given the position immediately aft of the navigator. The radio operator was located behind the second pilot. Aft of this post the flight engineer’s station was placed, with an elaborate panel of instruments and controls for power plant operation, thus relieving the pilots of this concern. The entire control room was thoroughly soundproofed so the men could talk with each other in conversational tones, although an interphone system is also provided.

In order to reduce maintenance in an aircraft, the designer strives to provide good initial design that will require a minimum of attention and to provide good access for inspection and repair to parts that will require maintenance. These factors were given utmost attention in planning the Clipper. The greatest innovation in this direction was the provision of access into the wings and engine nacelles during flight, by way of two doors in the control room leading to right and left wing passageways. Subsequent flight operations have shown again and again the advantages of this engine accessibility. Likewise, oil tanks, valves, and the greater portion of the plumbing for the engine lubrication, deicer fluid, hydraulic oil, water vacuum and fuel systems were also made accessible in flight. This means that inspections may be made periodically during flight and any malfunction can be immediately diagnosed.

The design objective of unusually large and luxurious passenger accommodations in the Clipper was readily realizable because of the great space allowed in the passenger deck. The whole was divided into a series of adjoining passenger cabins, equipped with davenport-type seats convertible into upper and lower berths, deluxe compartment with special furnishings and complete privacy, roomy and modern dressing rooms, a completely equipped galley, [and] a large centrally-located dining salon and recreation center, where passengers can mix and enjoy social pastime.

The fourth design criteria [*sic*]*—safety—*was one that was continually kept uppermost in the design process. Both Pan American Airways and the Boeing organization set out to embody safety in the fundamental design and to make the 314 one of the safest aircraft possible with present-day knowledge of the science of aviation. We believe this aim has been accomplished.

Roughly speaking, aircraft accidents come under two general headings—mechanical failures and personnel errors. Obviously, accidents under both these headings are more or less the joint responsibility of the manufacturer and operator. As a manufacturer, therefore, we have attempted to reduce mechanical failures by producing conservative structures; trouble-free mechanical accessories; simple and sturdy installations for fuel, oil, hydraulic, vacuum and electrical systems; and have attempted to provide a maximum of accessibility so that all parts may be easily inspected and maintained. We also have attempted to reduce the personnel errors by eliminating as much fatigue from the crew as possible by dividing up their duties so that no man is overloaded, and by giving them proper tools with which to work.

The fact that the Clipper has four power plants, any two of which can sustain flight, and that these power plants can be reached by mechanics during flight, is a highly important safety factor in itself. The hydrostabilizers were selected as part of the design primarily for safety reasons. As a precaution against loss of buoyancy in the hydrostabilizers, each was divided into five watertight compartments, two of which are used as fuel tanks. Wing tips were also made into buoyant water-tight compartments. The hull bottom below the passenger deck level was divided into nine separate water-tight flotation tanks, and water-tight bulkheads fore and aft separate the passenger deck from the bow and tail compartments.

In the event that it should ever be necessary to abandon ship on the water, auxiliary exits were provided on both sides of each passenger compartment, as well as at well-distributed points on the flight deck, which was connected with the lower deck by a spiral stairway. Each passenger's seat was equipped with a life jacket and eight 10-man collapsible life rafts were provided in which extra jackets could also be stowed.

Particular attention was given to the power plants from a safety angle; it was decided that the failure of any one engine should not cause any of the aircraft's energy systems, such as the gyro pilot hydraulic system, to cease to operate; and it was also decided to isolate and make each engine as independent as possible from the others, yet be able to assist each other in operating if necessary. As one example, each engine has its own independent lubricating oil system, yet it is possible while in flight to transfer oil from one tank to another. The heating system was designed throughout to be simple, sturdy, effective and safe, and it incorporates many safeguards against malfunction. Structures were designed on the conservative side, and all thoroughly tested. Fuel tanks were all placed outside the hull and separated from it by solid sheet metal partitions. All fabrics used in the aircraft, including furnishings and soundproofing, were flameproofed. Throughout the design there

appear many other safety devices and precautions too numerous to mention. Add to all this the safety which is inherent to all four-engine equipment and in particular to large flying boats, and the reliability and practicality of the big Clippers becomes apparent.

Some conception of the intricacies of the project of designing and manufacturing these flying boats can be gained from the fact that each of the ships embodies approximately 50,000 different parts. This number does not include some 15,230 bolts and approximately one million rivets. All through the design and construction process, it was naturally necessary to maintain accurate weight control, and it is interesting to note that the weight of the aircraft on its actual weighing was within approximately fifty pounds, or about one-tenth of one percent, of the estimated weight empty.

The project, in all, required 17,500 square feet of original engineering drawings, and 385,000 square feet of blueprints. Spread on the ground, these blueprints would cover eight acres. The electrical system contains 11½ miles of wiring, installed in 400 runs of conduit. The plumbing system involves 3,000 feet of tubing and the control system includes 5,000 feet of cable. The hull itself has an outside surface area of 4,000 square feet—one-tenth of an acre.

Because of the size of the component parts of the plane, a good deal of larger shop equipment had to be installed in the various manufacturing shops of the plant; and assembly methods in many ways approached ship-building technique. The hulls were assembled in giant jigs much like ship-building cradles, encircled by a maze of scaffolding and walkways allowing workmen to work at five different levels simultaneously. Wings were assembled in a separate building. At the final stage each of the Clippers was moved outside on a movable "drydock," where wings, hydrostabilizers and engines were attached, and where the ship was launched upon completion.

Large as these Clippers may have appeared at the time, the public has already become quite accustomed to their size and no longer views them with such wonderment. They have taken their place as a standard part of America's transportation system. Their transoceanic flights have become a routine operation, and have well proven that large aircrafts can be successfully built for regular commercial use. It is hoped that the design of these planes will be the stepping stone to even larger, higher performance [and] more efficient, more luxurious and safer aircraft.

Document 5-24 (a–b)

(a) E. G. Stout, Consolidated Aircraft Corp., San Diego, CA, “Flying Boat Development,” *Report No. ZH-011* (August 1943), in File ZH-011, GD/Convair, Design Proposals/Seaplanes, Convair Collection, San Diego Aerospace Museum.

(b) L. D. Coates, Comdr., USN, Memorandum of a Conference, Bureau of Aeronautics, Navy Department, “Trend of Future Design in VPB Types,” 10 February 1944, in File VPB, Vol. 1, Box 1541, Bureau of Aeronautics, Confidential Correspondence, 1922–1944, Record Group 72, National Archives, Washington, DC.

Even as World War II came to an end, aeronautical engineers refused to give up on the potential of the flying boat. As long as these amphibians performed the missions assigned to them, the Navy would keep asking the aircraft industry to come up with superior designs. But it was clear to everyone by 1943–44 that the performance of the flying boat needed some significant upgrading if it was continue making contributions well into the future. Some bold new approaches to design would have to be tried if the seaplane was to survive the war as a viable form of aircraft.

The two documents below reflect what really amounted to a last-ditch effort to improve flying boat performance. In the first document, from August 1943, Consolidated Aircraft Corporation’s chief flying boat designer, Ernest G. Stout (who would chair the NACA’s Subcommittee on Seaplanes from 1953 to 1955), summarized 10 different proposals for coming up with an effective 180,000-pound flying boat. His bottom line: “To attain a marked improvement in flying boat performance it will be necessary to deviate from established conventional design practice.” A major change in hull form seemed necessary to him, with deeper research into hydrofoils and the type of advanced hulls (e.g., the Ventnor hull) coming into use for hydroplane racing. Stout also recommended looking into the elimination of the propeller and the use of jet propulsion for seaplanes.

The second document reports on a conference titled “Trend of Future Design in VPB Types,” held at the Navy’s Bureau of Aeronautics on 4 February 1944. (In naval aviation terminology, “VPB” stood for “Patrol Bombing Squadron.”) In looking at the Navy’s present and prospective patrol flying boats, the Bureau recognized, as Stout did in the preceding document, that “[i]t will be necessary to go over 100,000 pounds to get a real advance” in flying boat performance. Much of this conference dealt, however, with the Navy’s most immediate need, which was a

successor to Consolidated PB4Y-2. Like the PB4Y-1 that had preceded it, this was a land-based, over-water reconnaissance aircraft, not a patrol boat, derived from the Army's B-24 Liberator. Eventually, nearly one thousand PB4Y-1s flew for the Navy. The PB4Y-2, another variant of the B-24 known as the "Privateer," started flying for the Navy in early 1944. It had a longer fuselage than the PB4Y-1 and a single vertical stabilizer. The "4Y-2s" patrolled the central Pacific out to Borneo, Indochina, Singapore, and the southern coast of China. Their mission was to conduct long-range reconnaissance to prevent the undetected approach of enemy forces and to destroy enemy ships. Several VPB squadrons earned citations for outstanding heroism in action against the Japanese late in the war. But, again, these were not seaplanes. The only flying boat mentioned in this conference was the PBM-5, built by Martin late in the war as part of its Mariner series of patrol boats. Most PBM-5s served in the Pacific, where their better speed, range, and payload compared to earlier flying boats were much appreciated in the final days of the war. The PBM-5A amphibian was the last of the Mariners; its production finally shut down in March 1949, nearly a decade after the PBM-1.

Although some experts felt by the end of the war that the flying boat had grown militarily obsolete, its record in combat was noteworthy. Equipped with new Norden bombsights, the speedy new patrol bombers of World War II did much more than scout for the fleet; they could—and often did—fight their way through to deliver heavy blows to enemy targets on both sea and land. By war's end, Navy flying boats were responsible for saving countless American lives, sinking several hundred thousand tons of enemy ships, and making invaluable contributions to the Allied cause in the Pacific. But this performance did, in fact, mark the twilight of an era. After the war, uses for flying boats would diminish greatly. Following the Martin P5M "Marlin" flying boat (see the header for Document 5-25), which first flew in 1948, no large, multi-engine propeller-driven flying boat would ever again be developed in the United States. The Navy accepted the last of these production aircraft in 1960 and retired it from service in 1967.

Document 5-24 (a), E. G. Stout, Consolidated Aircraft Corp., San Diego, CA, "Flying Boat Development," Report No. ZH-011 (August 1943).

FOREWORD

The contemporary form of flying boat is inherently of lower performance than the equivalent land plane due to hydrodynamic requirements of relatively deep hulls and lateral stability on the water. There is no indication of marked performance improvement as long as design practice adheres to present conventional standards. The following report has been prepared to outline in general terms a logical, basic procedure for developing a series of flying boat arrangements wherein these disadvantages are minimized or in some cases eliminated.

As airplane size increases this inherent performance discrepancy decreases to a considerable extent. However, basic improvements, other than size alone[,] are necessary for the immediate future development. While the studies reported herein, at a gross weight of 180,000 pounds, may not achieve parity, it is believed that some of the principles outlined will narrow the choice of land plane or boat primarily to consideration of utility.

It must be realized that much of the substantiating technical information upon which these designs are based is inadequate or wholly lacking. Based upon experience and such data as are available, the proposals are believed to be consistent and subject to rigorous experimental substantiation.

It has been considered inadvisable to present all possible combinations of form and principles at this stage of the development. However, sufficient combinations have been proposed to crystallize the trend. The most promising fundamentals will be thoroughly studied theoretically and experimentally, which will result in the gradual emergence of a new, improved design trend.

SUMMARY

Presented herein are ten proposals of a 180,000 pound gross weight flying boat depicting possible avenues of approach toward improving flying boat performance. Technical basis, for the most part, is lacking. It is the purpose of this survey to establish certain trends and promote discussion. The more attractive features of certain proposals will be further studied and technical background will be accumulated to form a basis for a specific design proposal.

The studies are broken down into four general classifications: Conventional and unconventional, single and twin hull arrangements. As the studies proceed, additional arrangements will no doubt be suggested. However, it is believed that this report in itself indicates that marked improvement in flying boat performance is possible.

CONCLUSIONS

1. To attain a marked improvement in flying boat performance it will be necessary to deviate from established conventional design practice.
2. Aside from the advantage of size alone, inherent in the flying boat, it is indicated that the hull form and means of hydrodynamic sustentation is subject to marked improvement.
3. Due to the lack of adequate technical information, and the improvements believed possible through their use, a thorough research program is required to establish basic design information on hydrofoils of both high and low aspect ratio, the Ventnor principle and high length-beam ratios.

4. Additional studies are justified of a practical means of eliminating the propeller during the early stages of take-off through the use of jet propulsion or similar device.

DISCUSSION

In recent years there has been considerable discussion concerning the relative merits of the land plane versus the flying boat. This discussion has taken an added impetus during the war because of the anticipated surge in long range air commerce at the war's conclusion. In most cases these discussions have concluded that the flying boat has a definite sphere of use provided the inherent disadvantages in performance can be minimized or eliminated so that the choice depends upon utility rather than performance.

The factors influencing this situation in current design are: (a) The flying boat is inherently a large airplane and parity based on size alone is still dependent upon general growth in airplane size, and (b) The contemporary flying boat hull form has progressed but little from that used in 1919 on the NC-4. This penalty has not allowed the flying boat to take full advantage of rapid strides in aerodynamic design which have been utilized to the fullest extent by the land plane due to its relative freedom from under-carriage problems.

While item (a) will be gradually realized as the land plane under-carriage presents increasingly complex problems, it is necessary that immediate steps be taken to investigate the possibilities of improvement through redesign so that parity can be more nearly realized in current design. It is the object of this report to initiate a sound development problem resulting in marked improvement in hull form and hydrodynamic sustentation using a currently practical airplane design of 180,000 pounds gross weight as an example.

The ten proposals that follow can be roughly divided into two basic categories: Single hull and twin hull. These proposals are intended to show basic trends and not to reflect a definite design. It is intended to study the more promising designs or combinations of designs in more detail, leading to a sound, specific design proposal.

PROPOSAL NO. 1

CONVENTIONAL SINGLE HULL

This proposal is included only for the purpose of providing a basis of comparison for the designs to follow. Proposal No. 1 illustrates contemporary good design practice utilizing four Pratt and Whitney X Wasp Major engines, having a wing loading of 50 lbs/sq.ft., a beam loading of $C_{D_0} = .90$ for a length-beam ratio of 6.0 and a take-off time of 60 seconds. The remaining characteristics are summarized in Table I for comparison purposes. To be consistent, the remaining designs maintain the same gross weight, wing loading and power.

**SINGLE HULL FLYING BOAT
PROPOSAL NO. 1**

TABLE OF CHARACTERISTICS
4-P&W R-4360 Engines
3250 BHP @ 2700 RPM @ T.O.

Design Gross Weight, lbs.	180,000	Hull Depth, ft.	19.0
Wing:		Step Depth, Ins.	12.0
Wing Area, Sq. ft.	3,600	% Beam	6.85
Wing Span, ft.	208	Angle Forebody Keel, deg.	0
Aspect Ratio	12	Angle Afterbody Keel, deg.	7
Root Chord, ft. (21%t)	27.7	Draft @ step, Ins.	48
Tip Chord, ft. (14%t)	6.91	Static Trim, deg.	3.0
Taper Ratio	4:1	Deadrise Angle, deg.	20.0
MAC	19.4	Static C _Δ	.90
L.E. MAC aft L.E.W. @ Root, ft.	3.0	Tail:	
Centerline to Inboard Nacelle, ft.	16.0	Area Horizontal, Sq. ft.	562
Centerline to Outboard Nacelle, ft.	34.0	Span Horizontal, ft.	45
Incidence, deg.	5.0	Area Vertical (total) sq. ft.	560
Wing Loading, lbs/sq. ft.	50	Span Vertical, ft.	21
Hull:		Tail Length, ft.	65
Beam, ft.	14.6	MAC. Lengths	3.5
Over-all length, ft.	115	Power Plant:	
Length Bow to 2nd Step ft.	87.6	Propeller Diameter, ft.	18.0
Length Beam Ratio	6.0	No. Blades	4
Length Forebody, ft.	48.3	Static Propeller Clearance, Ins.	48
Length Beam Ratio	3.31	Nacelle Diameter, ft.	5.0
Length Afterbody, ft.	39.3	Angle Thrust Line, deg.	5.0
Length Beam Ratio	2.69	Gear Ratio	.381
Distance Step, Aft L.E.W., ft.	13.3	Power Loading (T.O.), lbs/BHP	13.85
Over All Height, ft.	36.5		

PROPOSAL NO. 2

HYDROFOIL TYPE (HIGH A.R.) CONVENTIONAL SINGLE HULL

This proposal indicates the advantages that could be attained by incorporating a conventional high aspect ratio main hydrofoil and smaller trimming foil on the conventional "V" type bottom hull. Tests (Ref. 1) conducted on a 1/8-scale powered dynamic model of the XPB2Y-4 airplane indicated a marked improvement in spray characteristics at and near hump speed. Preliminary estimates indicate that a 20% reduction in the geometric beam would be possible with this arrangement.

Due to surface cavitation, this arrangement results in violent instability just beyond the hump speed, requiring that the hydrofoils be retracted prior to the start of planing. Because of the violent unporting characteristics of this system, it is not believed that the full advantage of hydrofoil assistance can be realized. Additional dynamic tests are scheduled to more fully investigate the stability characteristics and the feasibility of foil retraction during the take-off run. These tests will be reported at a later date.

PROPOSAL NO. 3

VENTNOR TYPE SINGLE HULL

Little is known regarding the Ventnor type arrangement. Preliminary tests, reported in Reference 2, conducted on a hull of very low length-beam ratio, indicated very clean spray characteristics and low resistance. If subsequent tests, scheduled to be run by C.V.A.C., indicate the stability characteristics are satisfactory[,] this arrangement will result in not only a 20% reduction in beam but a much more shallow hull due to reduced propeller clearance requirements.

Disadvantages of this system may be high landing loads due to the flat planing surfaces and severe wetting of the tail due to the channelized high velocity jet in the tunnel. As a result of the spray concentration through the tunnel, there is little or no spray at the outer chines. Complete data on the questionable characteristics of this arrangement will be obtained during tests scheduled for the near future.

PROPOSAL NO. 4

HIGH LENGTH-BEAM RATIO SINGLE HULL

Figure 5 [*not reproduced*] presents resistance data for single hulls of varying length-beam ratio. The advantages of high length-beam ratio are obvious; however, in Figure 4 where a typical design, having an L/B ratio of 10.5, is presented, it is readily seen that forebodies of unusual proportions result. This is dictated by the fact that the wing is located by the step and therefore cannot be moved forward. If the balance problem can be met satisfactorily, tests conducted by the DVL tank in

Hamburg (Reference 3) indicate the performance will be high and the hull will run very clean despite the high load coefficients used.

This study presents a very promising field for flying boat improvement and a program of further tests and studies is under way. The results will be presented in a separate report at a later date.

PROPOSAL NO. 5

CANARD TYPE—HIGH LENGTH-BEAM RATIO SINGLE HULL

To offset the disadvantages, discussed in Proposal 4, of using high length-beam ratio single hulls, one interesting solution is presented in Figure 6 [*not reproduced*]. Due to the continued growth in forebody length with increasing L/B ratio, we find that for an L/B of 10.5 adequate tail length now exists ahead of the c.g., and the tail plane is moved forward utilizing the “Canard” principle. This eliminates the tail extension and allows a very smooth fairing of the afterbody.

It is believed that this arrangement is practical and additional studies will be made. One great disadvantage of high beam loadings on conventional airplanes is the great amount of water thrown over the horizontal tail even though the propellers can be made to run clean. This proposed arrangement overcomes this difficulty by placing the horizontal tail in an undisturbed region of no spray. With this arrangement, balancing problems will be minimized. Additional studies will be necessary to determine hydrodynamic stability characteristics of such an arrangement.

Unless an arrangement, similar to that presented in Figures 4 or 6 [*not reproduced*], is used, it will probably be necessary to go to a twin hull boat if the large gains possible with high length-beam ratio are to be realized. A twin hull proposal employing two hulls of 10.5 L/B ratio is presented in Proposal 8 (Reference—Figure 9 [*not reproduced*]) for direct comparison. The three proposals (Nos. 4, 5 and 8) have identical hydrodynamic resistance (see Figures 5 and 10 [*not reproduced*]).

PROPOSAL NO. 6

HYDROFOIL TYPE (HIGH A.R.) UNCONVENTIONAL SINGLE HULL

In this proposal an attempt has been made to utilize high aspect ratio foils in an unconventional form resulting in reduced frontal area. To provide static lateral stability, the wing is gulled sharply. Due to cavitation and unporting instability, inherent with this type of hydrofoil, it must be retracted at or near hump speed. To provide a planing surface for sustentation from hump speed to getaway, the special anti-spray retractable floats, located in the apex of the gull, are extended just prior to the retraction of the main foils. Take-off is attained by planing on these auxiliary planing surfaces to getaway.

The anti-spray float consists of a conventional hull form that has been split longitudinally so that the conventional keel becomes the inboard chine. The

conventional chine flare and deadrise extend only outboard from the keel. A float of this type throws no spray on the keel side, allowing a possibility of many unique installations where unilateral spray formation is desired. Tests, reported in Reference 4, show no increase in resistance for this arrangement. For some conditions this form is shown to have improved characteristics over the conventional hull.

While this arrangement has several interesting features, it is believed that the critical timing of retraction and transition from foil to planing surface would prove unsatisfactory. For hydrofoils to be practical it is believed necessary for them to provide the sole means of dynamic support throughout the take-off run. From the information, now available, this is impossible with the conventional high aspect ratio hydrofoil. Aside from this objection, the structural requirements become exceedingly critical resulting in foils of very high weight.

PROPOSALS NOS. 7A & 7B

HYDROFOIL TYPE (LOW A.R.) UNCONVENTIONAL SINGLE HULL

Proposal 7 is presented in an attempt to overcome the disadvantages listed in Proposal 6. Basically circular hydrofoils of low aspect ratio are proposed. Surface cavitation and unporting instability should be eliminated in this arrangement, allowing the foils to be used throughout the take-off to getaway. The following advantages are predicted:

- a. Due to the inherent low slope of the lift curve, the foil will operate at higher angles of attack facilitating smooth transition to planing.
- b. Through incorporation of the planing tail on the basically circular foil of moderate deadrise, the emergence of the well-rounded tips is anticipated to disturb the equilibrium but little.
- c. A basically circular foil is infinitely superior from a structural and weight standpoint, particularly when high aspect ratio foils of the order of 20-foot spans or more are under consideration.
- d. In order to satisfy the obvious trend in design, if hydrofoils are to be practical, a form similar to that proposed must be employed if retraction is to be accomplished into forms other than the current "V" bottom type hulls which, through necessity, will be eliminated.
- e. Due to the inherently physically thick foil resulting from the long chord, even though the percent thickness remains low, the foil will have high well-rounded entries conducive to good planing characteristics in rough water.
- f. While it is apparent there will be some compromise with regard to L/D ratio, it is anticipated this value will remain sufficiently high to be attractive when compared to current values of hull Δ/R ratio.

In the typical arrangement illustrated, the wing root is used for static displacement and lateral stability at rest. A tricycle system of foils provides the hydrodynamic sustentation while in motion.

In Proposal 7b, the wing is gulled quite abruptly in order to provide adequate propeller clearance for conventional take-off technique. This incorporates the serious disadvantage of increased wing structural weight. A solution to this problem has been presented in Proposal 7a where jet propulsion is used to provide all of the thrust over the hump until planing is established. In this case the engines are started but remain declutched from the propellers which are locked in the position for maximum clearance. When planing has been established, the propellers are engaged and take-off proceeds in a normal fashion.

This later arrangement is probably more suited for very large designs where auxiliary tugs or power are provided for maneuvering on the water into take-off position.

Due to the promising nature of this low aspect ratio type of hydrofoil, a series of towing basin tests and models are being prepared for test in the near future.

PROPOSAL NO. 8

CONVENTIONAL TWIN HULL

This arrangement shows considerable promise, particularly in the larger sizes where the wing center section can be used to advantage to house cargo and crew. Here it is possible to utilize hulls of very high length-beam ratio and low resistance. Figure 10 presents the resistance characteristics for twin hulls of high length-beam ratio and includes a conventional single hull of $L/B = 6.0$ for comparison. Table II lists the characteristics for comparison with the basic single hull proposal.

Aside from a marked decrease in hump resistance, the aerodynamic drag of the wing tip floats is eliminated completely. As flying boats increase in size, these floats become extremely large and the wing weight is increased appreciably to support their weight and reactions.

As a result of the favorable wing beam characteristics due to the twin hull reactions, it is possible to utilize higher wing aspect ratios with this arrangement and still maintain the same maximum bending moments. This will result in a decrease in aerodynamic drag.

Due to the inherently high transverse static stability, this arrangement will be exceptionally seaworthy in the event of forced landings.

Additional studies are being made of the aerodynamics and hydrodynamics of this arrangement.

PROPOSAL NO. 9

VENTNOR TYPE TWIN HULL

Proposal 9 is similar to Proposal 3 except that the twin hull system is utilized. Because of the inherent favorable spray characteristics, it is possible to locate the propellers close to the static water surface.

By utilizing the twin hulls, it is believed that the hydrodynamic resistance of the hulls can be reduced considerably over the conventional single hull or Ventnor single hull.

Upon obtaining additional basic test data on the Ventnor type hull, tests of a twin arrangement will be made if the anticipated improvement seems likely.

PROPOSAL NO. 10

MODIFIED VENTNOR TYPE TWIN HULL

As in Proposal 9, there is little technical background to substantiate this arrangement. The anticipated improvement lies in utilizing the space between the hulls for channelizing the spray. In this manner, the actual beams may be reduced. This arrangement in effect is Proposal 3 (Ventnor Type Single Hull) with the planing surfaces spread sufficiently to provide static lateral stability, thereby eliminating the wing tip floats.

As no spray will be projected outboard, it is possible to lower the propellers to a very low static clearance. This results in a decrease in hull height and consequently frontal area. If the Ventnor principle is found to be sound for flying boat application, this arrangement has many advantages. Through the elimination of the outboard floats and general reduction in interference drags, the aerodynamic cleanliness is attractive.

Further tests and studies of this arrangement are contingent upon satisfactory results from current basic studies on the Ventnor principle.

Document 5-24 (b), L. D. Coates, Comdr., USN, Memorandum of a Conference, Bureau of Aeronautics, Navy Department, "Trend of Future Design in VPB Types," 10 February 1944.

NAVY DEPARTMENT BUREAU OF AERONAUTICS
WASHINGTON
10 February, 1944

MEMORANDUM OF A CONFERENCE

Date: 4 Feb., 1944

Present: Capt. L.C. Stevens, USN
Comdr. J.S. Russell, USN
Comdr. P. Foley, USN
Comdr. L.D. Coates, USN
Comdr. E. O'Beirne, USN
Comdr. H. Keopka, USNR
Lt. (jg) C.T. Ray, USNR
Mr. W.Z. Frisbie

Sub: Trend of Future Design in VPB Types.

1. There was a general discussion of all new design studies submitted to date, including three seaplane studies and two large landplane studies by Glenn L. Martin, one tailless and one conventional large landplane by Convair, and three masthead bombers by Lockheed. The problem of manufacturing facilities, design facilities, and relative priorities among new developments was also discussed.
2. It was generally agreed that Convair and Martin are the only contractors with design experience and manufacturing facilities to do a good job on a very large seaplane unless and until Boeing facilities are released by the AAF, which seems unlikely at present. Both Martin and Convair have expressed interest in continuing in the seaplane business. Convair and Martin are also the only Navy contractors capable of building very large landplanes unless and until the AAF takes the B-17 out of Lockheed's plant, or releases some of Boeing's capacity.
3. It was agreed that present and prospective seaplanes generally meet the Navy's broad requirements for this type except that there is a demand for a limited number of amphibians better defended than the PBV-5A and having longer range. However, the development time for large seaplanes is so great that a new design will have to be started soon if it is to replace the

PBM-5 before the latter becomes obsolescent. It was further agreed that the Navy cannot afford to design a seaplane solely for sea rescue but must convert combat or utility types to this employment where expedient. It therefore appears that interest in seaplanes is limited to:

- a. a successor to the PBM-5
- b. a large combat amphibian
- c. a medium utility amphibian successor to the JRF

It further appears that seaplane designs of less than 100,000 pounds gross weight do not offer such substantial improvements in armament or performance over the PBM-5 as to justify bringing out an entirely new design. It will be necessary to go over 100,000 pounds to get a real advance.

4. The most immediate need in the VPB field is for a successor to the PB4Y-2, that is, a well defended reconnaissance landplane with considerable increased range. No existing airplane meets this need, although the B-29 or B-32 could meet it with some rather extensive design changes in fuselage, power plant, and armament.
5. In summary, the following priority was set up for future design development:
 - (1) *A successor to the PB4Y-2.* Martin is currently revisiting his two large landplane proposals and will soon present the result, which lies between the two in gross weight. This will be considered in comparison with the Convair designs. A Navy version of the B-29 will be considered if and when the AAF cancels out the B-17 at Boeing.
 - (2) *A large amphibian.* Martin will be asked to submit a study of an amphibian version of the PBM-5.
 - (3) *A large amphibian.* Martin will be asked to submit a study of an amphibian of about 125,000 pounds gross weight.
 - (4) *A successor to the P2V-1.* The Lockheed masthead bomber proposals will be studied and given further consideration.

L.D. Coates,
Comdr., USN.

Document 5-25 (a–b)

(a) E. G. Stout, “Proposal for Hydrodynamic Test Program of CVAC Long Range Flying Boat Development,”

Report No. ZH-017, revised July 1944, copy in Vol. 1, Box 1394, File NOAS 4472, Records of Divisions and Offices, Contract Records, 1940–1960, Records of the Bureau of Aeronautics, Record Group 72, National Archives, Washington, DC.

(b) Campbell C. Yates and John M. Riebe,

“Effect of Length-Beam Ratio on the Aerodynamic Characteristics of Flying-Boat Hulls,”
NACA Technical Note 1305 (Washington, DC, June 1947).

Of all the geometrical dimensions affecting the drag of flying boats, the most critical parameter turned out to be length-beam ratio, i.e., the ratio of the length of the hull to its beam. By the 1940s, NACA research confirmed that increasing the length-beam ratio could reduce resistance significantly. Researchers did this by systematically varying the shape of a hull and then measuring the results of each change. The NACA's goal was to help industry identify the very best hull design possible for any given requirement. Effective hydrodynamic performance had to be assured. By the end of the war, industry developed some very effective high-length-beam-ratio hulls, with hull lengths over eight times the beam width (compared to what customarily had been around five to six times). The design of these hulls dramatically lessened water resistance at hump speed, thereby narrowing the performance gap between seaplanes and landplanes, but hardly eliminating it.

Given how late this discovery about high length-beam ratio was made, few flying boats benefited from the new geometry. The most noteworthy exception was the Martin P5M “Marlin,” which first flew in 1948. Although based on Martin's earlier PBM configurations, the “5M” featured an entirely new, high-length-beam-ratio hull. This new hull resulted in large part from extensive testing in NACA Langley's towing tanks and wind tunnels. Langley researchers found that by maintaining the same mathematical product for the length of the beam times the length of the hull, and by increasing the value of the length-beam ratio, they could keep the same effective water drag and spray characteristics yet significantly improve aerodynamic drag. Along with the new hull came a planing-tail afterbody, which gave the machine more lateral stability and helped it to avoid porpoising and skipping in the water. The P5M hull had a length-beam ratio of 8.5. Thanks to its

advanced design, the P5M could reach a speed as high as 251 mph and actually cruised at 159; these speeds were 49 and 24 mph faster, respectively, than the most advanced PBM Mariner flying boat's. Its range was also greater—4,800 miles compared to 3,500 for the Mariner. This was made possible not only by its improved Wright R-3350 engines, but also by its cleaner aerodynamics. The Marlin's zero-lift drag coefficient (0.0275 compared to 0.0327) was 19 percent lower than the PMB's, and its maximum lift-drag ratio (14.4 to 13.2) was 9 percent higher.

The two documents below, from 1944 and 1947, both relate to hydrodynamic test programs dealing with length-beam ratio. In the second one, readers will find that the NACA tested some experimental hull shapes soon after the war with ratios as high as 15.

Document 5-25 (a), E. G. Stout, "Proposal for Hydrodynamic Test Program of CVAC Long Range Flying Boat Development," Report No. ZH-017, revised July 1944.

FOREWORD

Studies conducted by the Consolidated Vultee Aircraft Corporation on a long range flying boat proposal embodying the most recent principles of engineering design and development have indicated that certain hydrodynamic information available is neither sufficiently complete nor conclusive to justify the optimum selection of hull form or proportion about which a specific design can be proposed. Due to the absolute dependency of specific aerodynamic and structural design, as well as the selection and arrangement of power plant, functional equipment, and other related items, on the form and performance of the hydrodynamic elements, their determination preclude[s] all other studies of a specific nature.

It is the purpose of this test program to establish, with the minimum of time and experimental effort, the information necessary to design a modern flying boat of maximum utility and performance. Due to the necessary delay that will be imposed upon the aerodynamic and structural aspects of a new proposal pending the determination of the hydrodynamic design[,] the Consolidated Vultee Aircraft Corporation has developed testing equipment and facilities which, in coordination with the facilities of established towing basins[,] will greatly accelerate the experimental determination of optimum hull form.

Each phase of the test program has been assigned a project number to facilitate analysis and coordination. A weekly status report will be issued to the Bureau of Aeronautics for each active project[,] and a final report, including all test results and conclusions, will be submitted in triplicate within two weeks of the completion of each project. In addition to the above test reports[,] the contractor will furnish to the Bureau all reports pertaining to the development and technique of operation of

any test equipment developed for the purpose of securing the information covered by this proposal. These latter reports will be submitted at the time of, or prior to, the final report covering the results of the project wherein the equipment was used.

HYDRODYNAMIC TEST PROGRAM

A. DETERMINATION OF LENGTH-BEAM RATIO AND HULL PROPORTION

In all available technical literature on length-beam ratio every effort has been made to rigorously isolate the academic effects of length-beam ratio as an independent parameter. While this is necessary in early stages of development it is necessary to combine these effects with the other major variables of hull proportion before the designer can utilize any of the information for a specific design. There is reason to believe that there is an optimum arrangement of hull proportion and step depth for each stage of hull fineness. The proposed test program of projects 2 and 3 has been so set up that the coordinated effect of these other variables on resistance and stability can be quickly determined. With these data known it is believed an optimum hull form can be designed.

All length-beam ratio families in the past have been arbitrarily expanded about the familiar proportions of a fineness of approximately 6.0. As the forebody and afterbody of a hull serve to fulfill different functions, it is not to be assumed that they should be expanded in this manner. The contractor believes that the specific tests included in this program will provide the information necessary to design a high performance hull suitable for a specific long range flying boat proposal.

The stability characteristics of this family of hulls will be obtained on a four-engined radio controlled free flight model and the results will be correlated in detail with the stability resistance and moment data as obtained from the towing basin. Spray pattern in rough and quartering waves will be obtained on the radio model and correlated with the smooth water results of the tank.

It should be noted that project 1 is merely an extension of Sottorf's DVL standard float family which, even though being a seaplane float, presented the best data available for immediate use. The hulls of project 2 incorporate a new parent hull which uses the extremely successful lines tested on the modernized PB2Y-4 model. This parent hull is ideally suited for flying boat development as it incorporates the cruiser type sea bow and has excellent stability characteristics in the parent form.

PROJECT 1

Purpose:

1. To determine the resistance, moment and spray characteristics for a length-beam ratio of 10.5 with 20° and 25° deadrise and step depths of 5% and 10% beam. (DVL Standard Hull Series)

Models: (Supplied by contractor)

1. One resistance hull, $L/B = 10.5$, deadrise = 20° , step depth = 5% beam.
2. One resistance hull, $L/B = 10.5$, deadrise = 25° , step depth = 5% beam.
3. One resistance hull, $L/B = 10.5$, deadrise = 25° , step depth = 10% beam.

Type of Test:

1. "General" resistance tests up to and including $C_{\Delta o} = 4.0$ or absolute spray limit.

Note: These hulls are at Langley Field and the tests were conducted during the period 2/16/44 to 3/16/44.

PROJECT 2

Purpose:

1. To determine from a coordinated family of flying boat hulls of 3 length-beam ratios the correlated effects of hull proportion and step depths as affected by hull fineness.

Models: (supplied by Stevens Institute of Technology to the Bureau of aeronautics)

1. Three hulls, L/B ratio of 6, 8 and 10 with 5.40" beam, forebody 0.55L and variable step depth.
2. Three hulls, L/B ratio of 6, 8 and 10 with 5.40" beam, forebody 0.58L and variable step depth.
3. Three hulls, L/B ratio of 6, 8 and 10 with 5.40" beam, forebody 0.61L and variable step depth.

Type of Test:

1. "General" resistance tests to determine resistance, moment and spray envelopes.
2. "General" stability tests on optimum arrangements of part 1 above to provide correlation between towing basin and free flight radio model characteristics.

PROJECT 3

Purpose:

1. To determine the correlated effects of hull proportion and step depth, as affected by hull fineness, on the takeoff and landing stability characteristics and spray. (Smooth and rough water, quartering waves).
2. To determine stability, spray and racking characteristics of a high length-beam ratio twin hull arrangement. (Smooth and rough water, quartering waves).

Models: (Supplied by contractor)

1. One four-engined free flight radio model with provision for interchangeable hulls.
2. Six interchangeable hulls of varying L/B ratio and proportions utilizing same parent lines as defined in Project 2.

Type of Test:

1. Dynamic takeoff and landing stability, c.g. and trim limits.
2. Stability tests in smooth, rough and quartering waves to determine effects of spray and racking.

B. APPLICATION OF AUXILIARY HYDRODYNAMIC SUSTENTION

Due to the inherent possibilities of hydrofoils as a means of hydrodynamic sustention it is believed that any new specific design proposal should give serious consideration to the application of such a system. As monoplane hydrofoils of low aspect ratio appear to be the only form that has promise of practical utilization and adequate information, particularly concerning the stability characteristics, is lacking[,] a brief program of tests on promising arrangements appears to be justified. As stability is the major consideration in any hydrofoil system the majority of the studies will be confined to tests of a free flight radio model equipped with various arrangements of hydrofoil sustention. Force tests will be limited to the final system of foils resulting from the stability investigation.

PROJECT 4***Purpose:***

1. To determine basic takeoff and landing stability characteristics for four typical planing hydrofoil systems. (Smooth and rough water, quartering waves).
2. To determine basic spray characteristics for typical hydrofoil systems. (Smooth and rough water, quartering waves).

Models: (Supplied by contractor)

1. One four-engined free flight radio model with provisions for typical hydrofoil arrangements.
2. Four model hydrofoil systems for radio model with provisions for remote retraction, pressure control, etc.

Type of Test:

1. Dynamic takeoff and landing stability, c.g. and trim limits.
2. Stability tests in smooth, rough and quartering waves to determine effects on stability and spray.

PROJECT 5***Purpose:***

1. To determine the physical characteristics of the optimum hydrofoil system of Project 4.

Models: (Supplied by contractor)

1. One main foil of optimum Project 4 system, area 1.5 sq. ft.
2. Auxiliary foil of optimum Project 4 system, area 1.5 sq. ft.

Type of Test:

1. Standard hydrofoil dynamometer tests to determine lift, drag and moments throughout submerged, immersion and planing ranges.

*PROJECT 6**Purpose:*

1. To study on a free flight model miscellaneous auxiliary devices designed to enable higher loadings, wave suppression, general improvement in performance etc. Such improvements to be applicable to service aircraft.

Models:

1. Use of models previously authorized.

Type of Tests:

1. General handling and stability on a free flight radio model.

COST ESTIMATES AND MATERIAL LIST FOR PROPOSED HYDRODYNAMIC TEST PROGRAM

I. COST ESTIMATE

Project 1:		
A. Engineering Costs	500 hrs. @ \$2.00/hr.	\$1,000.00
	Eng. Overhead @ 100%	1,000.00
		\$2,000.00
B. 3-Resistance Hulls	1500 hrs. @ \$1.50/hr.	2,250.00
	Overhead @ 130%	2,925.00
	Material	225.00
		5,400.00
C. Direct Expense	(Traveling expenses, shipping expenses, etc.)	1,000.00
Total Estimated Cost:		\$8,400.00
Project 2:		
A. Engineering Costs	400 hrs. @ \$2.00/hr.	\$800.00
	Eng. Overhead @ 100%	800.00
		\$1,600.00
B. Models built by	Stevens Institute of Technology	
C. Direct Expense	(Traveling expenses engineering representative)	1,500.00
Total Estimated Cost:		\$3,100.00

Project 3:			
A. Engineering Costs (including flight research)	6000 hrs. @ \$2.00/hr.	\$12,000.00	
	Eng. Overhead @ 100%	12,000.00	
		\$24,000.00	
B. One Radio Free Flight Model	(1) Powered with complete (including prop. blades, hubs, etc.) and empennage 6000 hrs. @ \$1.50/hr.	9,000.00	
	Overhead @ 130%	11,700.00	
	(2) 6 Interchangeable hulls for Item (1) above. 7500 hrs. @ \$1.50/hr.	11,250.00	
	Overhead @ 130%	14,625.00	
	(3) Material Radio receiver and relays	1,800.00	
	4 motors @ \$500.00	2,000.00	
	7 Control motors @ \$30.00	210.00	
	Raw material & misc. parts	725.00	
			51,310.00
	C. Testing costs other than engineering (operation of boat, transmitter, gasoline, film, etc.)		1,500.00
Total Estimated Cost: \$76,810.00			
Project 4:			
A. Engineering Costs (including flight research)	400 hrs. @ \$2.00/hr.	\$ 8,000.00	
	Eng. Overhead @ 100%	8,000.00	
		\$16,000.00	
B. One Radio Free Flight Model	(1) Powered wing complete (including prop. blades, hubs, etc.) and empennage 6000 @ \$1.50/hr.	9,000.00	
	Overhead @ 130%	11,700.00	
	(2) One body and four model hydrofoil arrangements 2000 hrs. @ \$1.50/hr.	3,000.00	
	Overhead @ 130%	3,900.00	
	(3) Material radio receiver and relays	1,800.00	
	4 motors @ \$500.00	2,000.00	
	8 control motors @ \$30.00	240.00	
	Raw materials and misc. parts	725.00	
			32,365.00
	C. Testing costs other than engineering (operation of boat, transmitter, gasoline, film, etc.)		1,500.00
Total Estimated Cost: \$49,865.00			

Project 5:		
A. Engineering Costs	250 hrs. @ \$2.00/hr.	\$ 500.00
	Eng. Overhead @ 100%	500.00
		1,000.00
B. Two Hydrofoils	800 hrs. @ \$1.50/hr.	1,200.00
	Overhead @ 130%	1,560.00
	Material	80.00
		2,840.00
C. Direct Expense	(Traveling expenses shipping expenses, etc.)	1,000.00
		Total Estimated Cost: \$4,840.00

Project 6:		
A. Engineering Costs (including flight research)	500 hrs. @ \$2.00/hr.	\$1,000.00
	Eng. Overhead @ 100%	1,000.00
		\$2,000.00
B. Use of models previously authorized	(1) Minor modifications and construction 400 hrs. @ \$1.50/hr.	600.00
	Overhead @ 130%	780.00
	(2) Raw materials and misc. parts	120.00
		1,500.00
C. Testing costs other than engineering (operation of boat, transmitter, gasoline, film, etc.)		500.00
		Total Estimated Cost: \$4,000.00

Total Cost Projects 1-6	\$147,015.00
Fixed Fee	1.00
Total Cost plus Fixed Fee	\$147,016.00

II. MATERIAL LIST

In conjunction with the proposed test program of CVAC Report ZH-017 (revised July 1944), the contractor agrees to supply, at the times specified, the following reports, data and material to the Bureau of Aeronautics.

1. *Reports and Technical Data*

- A. Weekly status report covering progress of each active project.

- B. Final report for each project to be submitted not later than two weeks after completion of the project. Such report to contain all test results and conclusions.
- C. Development reports pertaining to the development and technique of operation of any test equipment developed for the purpose of securing the information covered by this program will be submitted to the Bureau at the time of, or prior to, the final report covering the project wherein the equipment was used.
- D. Such other preliminary reports that may be required to cover a specific phase of tests from which conclusions can be drawn prior to completion of the entire project.

2. *Material*

- A. Project 1, to be supplied on the date of the contract by the contractor. Three resistance hulls of $L/B = 10.5$, namely
 - (a) deadrise = 20° , step depth = 5% beam
 - (b) deadrise = 25° , step depth = 5% beam
 - (c) deadrise = 25° , step depth = 10% beam
- B. Project 2, to be supplied July 24, 1944 by the contractor.
 - (a) Lines [*size*] drawings and hull offsets for the construction of hulls of Project 2 by Stevens Institute of Technology.
 - (b) Tentative test program including estimated full scale aerodynamic and hydrodynamic design characteristics.
- C. Project 3, to be supplied by the contractor, items (a) and (c) to be supplied 3 months and item (b) 6 months from date of contract.
 - (a) One four-engined free flight radio wing complete (including prop blades, hubs, power plant accessories, gas tanks, etc.) and empennage.
 - (b) Six interchangeable hulls of varying L/B ratio and proportions, as determined from Project 2.
 - (c) Seven channel radio receiver and relays; 4 two-cylinder, two-cycle gasoline motors; 7 servo control motors; raw materials and miscellaneous parts.
- D. Project 4, to be supplied by the contractor 8 months from date of contract.
 - (a) One free flight radio wing complete (including prop blades, hubs, power plant accessories, gas tanks, etc.) and empennage.
 - (b) One body and four model hydrofoil arrangements.
 - (c) Seven channel radio receiver and relays; 4 two-cylinder, two-cycle gasoline motors; 8 servo control motors; raw material and miscellaneous parts.
- E. Project 5, to be supplied by the contractor 12 months from date of contract, contingent on Project 4.

- (a) Two hydrofoils representing optimum arrangement of Project 5, including supports.
 - (1) One main foil, area 1.5 sq. ft.
 - (2) One auxiliary foil, area 1.5 sq. ft.
- F. Project 6, all items of investigation authorized by this project and started up to and including 12 months after the date of contract will be completed and reported.
 - (a) Miscellaneous parts and modifications to models previously authorized.

NOTE: Estimated completion dates are for completion of the models and equipment listed. Tests are scheduled to start on or before such date, and test results will be reported weekly. Projects contingent on towing basin tests are subject to towing basin schedules.

Document 5-25 (b), Campbell C. Yates and John M. Riebe, "Effect of Length-Beam Ratio on the Aerodynamic Characteristics of Flying-Boat Hulls," NACA Technical Note 1305 (Washington, DC, June 1947).

SUMMARY

A wind-tunnel investigation was made to determine the effect of length-beam ratio on the aerodynamic characteristics of a family of flying-boat hulls in the presence of a wing. The hulls were designed to have approximately the same hydrodynamic performance with respect to spray and resistance characteristics regardless of length-beam ratio.

The investigation indicated a reduction in minimum drag coefficient of 0.0022 (29 percent) with fixed transition when length-beam ratio was extended from 6 to 15. Minimum drag generally occurred in the angle-of-attack range from 2° to 3° for all length-beam ratios. Increasing length-beam ratio from 6 to 15 increased the hull longitudinal stability by an amount corresponding to a rearward aerodynamic-center shift of about 2½ percent mean aerodynamic chord on a flying boat; at an angle of attack of 2° the same change in length-beam ratio increased the hull directional instability by increasing the variation of yawing-moment coefficient with angle of yaw from a value of 0.0009 to a value of 0.0014.

Incorporating a hull step fairing, which extended longitudinally about 9 times the depth of the step at the keel, resulted in a reduction [of] up to 16 percent in minimum drag coefficient.

INTRODUCTION

In view of the requirements for increased range and increased speed in future flying-boat designs, the Langley Laboratory of the NACA is making an investigation of the aerodynamic characteristics of flying-boat hulls as affected by hull dimensions and hull shape.

Hydrodynamic tests have shown that at the same gross load the length-beam ratio may be varied without appreciably altering the hydrodynamic performance with respect to resistance and spray characteristics provided that the product of the beam and the square of the length is held constant. This criterion was used in designing a family of hulls with length-beam ratios of 6, 9, 12, and 15 which are applicable to a flying boat for which gross weight, power, center of gravity, tail length, and all geometries except the hull itself are held constant. The hydrodynamic performance with respect to spray and resistance characteristics would therefore be similar regardless of length-beam ratio in the aforementioned range; thus, the relative aerodynamic performance of the hulls would be an important factor in determining the length-beam ratio used in the flying-boat design.

The present investigation was made in the Langley 300 MPH 7- by 10-foot tunnel to determine the effect of length-beam ratio on the aerodynamic characteristics of the family of hulls previously described. The effect of wing interference is included in these characteristics.

COEFFICIENTS AND SYMBOLS

The results of the tests are presented as standard NACA coefficients of forces and moments. Rolling-moment, yawing-moment, and pitching-moment coefficients are given about the location (30-percent-chord point of wing) shown in figure 1. Except where noted, the wing area, mean aerodynamic chord, and span of a hypothetical flying boat derived from the XPBB-1 flying boat (fig. 2) are used in determining the coefficients and Reynolds number. The data are referred to the stability axes, which are a system of axes having their origin at the center of moments shown in figure 1 and in which the Z-axis is in the plane of symmetry and perpendicular to the relative wind, the X-axis is in the plane of symmetry and perpendicular to the Z-axis, and the Y-axis is perpendicular to this plane of symmetry. The positive directions of the stability axes are shown in figure 3.

The coefficients and symbols are defined as follows:

- C_L lift coefficient (Lift/ qS where Lift = $-Z$)
- C_D drag coefficient (Drag/ qS where Drag = $-X$ when $\psi = 0$)
- C_X longitudinal force coefficient (X/qS)
- C_Y lateral-force coefficient (Y/qS)
- C_i rolling-moment coefficient (L/qSb)

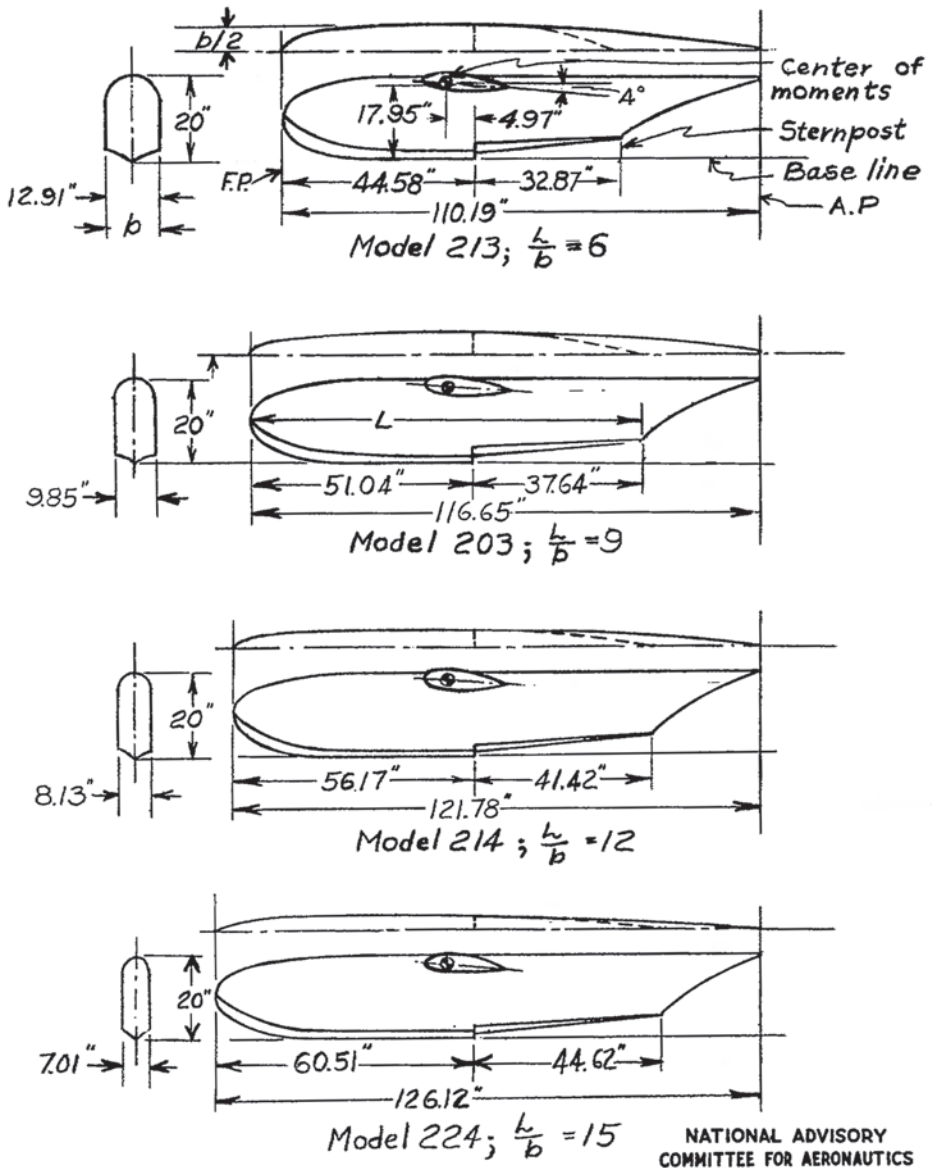

FIGURE 1. Lines of Langley tank models 203, 213, 214, and 224.

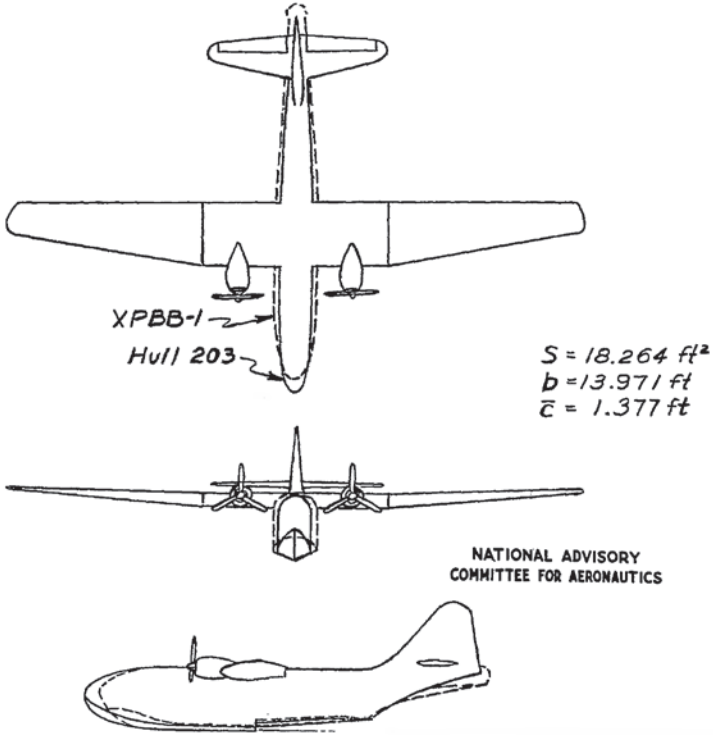

FIGURE 2. Comparison of $\frac{1}{10}$ -scale models of the XPBB-1 flying boat and hypothetical flying boat incorporating hull 203 ($L/b = 9$).

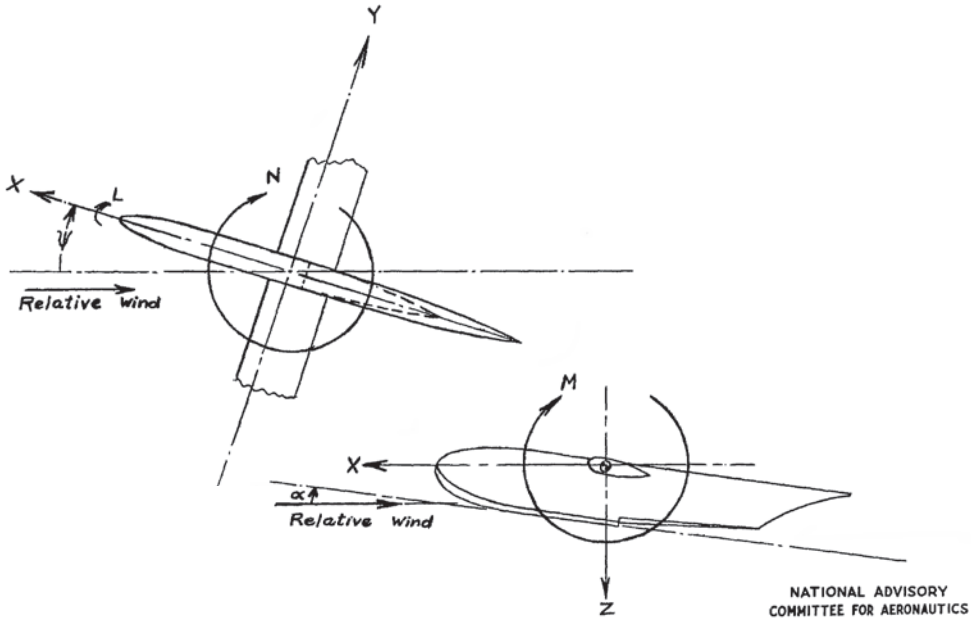

FIGURE 3. System of stability axes. Positive values of forces, moments, and angles are indicated by arrows.

C_m	pitching-moment coefficient (M/qSc)
C_n	yawing-moment coefficient (N/qSb)
X	force along X-axis, pounds
Y	force along Y-axis, pounds
Z	force along Z-axis, pounds
L	rolling moment, foot-pounds
M	pitching moment, foot-pounds
N	yawing moment, foot-pounds
q	free-stream dynamic pressure, pounds per square foot ($\frac{1}{2}\rho V^2$)
S	wing area (18.264 sq ft for $\frac{1}{10}$ -scale model of hypothetical flying boat, fig. 2)
c	mean aerodynamic chord of wing (1.377 ft for $\frac{1}{10}$ -scale model of hypothetical flying boat, fig. 2)
b	wing span (13.971 ft for $\frac{1}{10}$ -scale model of hypothetical flying boat, fig. 2)
V	air velocity, feet per second
ρ	mass density of air, slugs per cubic foot
α	angle of attack of hull base line, degrees except where otherwise noted
ψ	angle of yaw, degrees
L/b	length-beam ratio, where L is distance from forward perpendicular (F.P.) to sternpost and b is maximum beam (fig. 1)
R	Reynolds number, based on mean aerodynamic chord of wing of $\frac{1}{10}$ -scale model of hypothetical flying boat
M	Mach number (Airspeed/Speed of sound in air)
$C_{D_{\min}}$	minimum drag coefficient
$C_{D_{A_{\min}}}$	minimum drag coefficient based on maximum cross-sectional area A of hull (Drag/ qA)
$C_{D_{V_{\min}}}$	minimum drag coefficient based on volume v of hull (Drag/ $qv^{2/3}$)
$C_{D_{W_{\min}}}$	minimum drag coefficient based on surface area W of hull (Drag/ qW)

$$C_{m\alpha} = \frac{\partial C_m}{\partial \alpha}$$

$$C_{n\psi} = \frac{\partial C_n}{\partial \Psi}$$

$$C_{Y\psi} = \frac{\partial C_Y}{\partial \Psi}$$

MODEL AND APPARATUS

The hulls were designed by the Langley Hydrodynamics Division. Dimensions of the hulls are given in figure 1 and offsets are given in tables I to IV. Langley tank model 203 ($L/b = 9$) was derived from a hypothetical flying boat, Langley tank model 203A, essentially similar to the Boeing XPBB-1 flying boat (fig. 2). The form and proportions of hull 203 (all Langley tank models are referred to herein as hulls because only the hulls of the models were used for the tests) are the same as those of hull 203A except that the tail extension was refaired and the depth of step at the keel was increased from 0.89 inch to 1.16 inches. The depth of step was increased to permit adequate hydrodynamic stability at the lowest length-beam ratio. Because the depth of step is to remain a constant throughout the series, it is not to be assumed that the hydrodynamic stability is similar for the several models but it may be assumed that the change in stability is not such as to make any of the hulls unsatisfactory.

Langley tank models 213, 214, and 224 were derived from model 203 by keeping constant the product of the beam and the square of the length, the depth of step at the keel, and the maximum height of the hull. The location of the wing with respect to the step and the length of the hull aft of the step (afterbody plus length of tail extension) are the same for all models. The change in over-all length due to variation of L/b is accomplished by varying the forebody length. The volumes, surface areas, maximum cross-sectional areas, and side areas for the four hulls are compared in the following table:

Langley tank model	L/b	Volume (cu in.)	Surface area (sq in.)	Maximum cross-sectional area (sq in.)	Side area (sq in.)
213	6	14,831	4540	226	1639
203	9	12,916	4581	182	1752
214	12	11,528	4654	150	1870
224	15	10,653	4760	130	1985

The models were mounted on a wing which was designed either to span the tunnel test section vertically as shown in figure 4 (two-dimensional mounting) or to be mounted horizontally as shown in figure 5 (three-dimensional mounting). Transformation from one mounting to the other was achieved through the use of end caps and suitable cover plates. On all models, the wing was set at an angle of incidence of 4° to the base line, had a 20-inch chord, and was of the NACA 4321 airfoil section.

The hulls and wing were of laminated-wood construction and were finished with pigmented varnish.

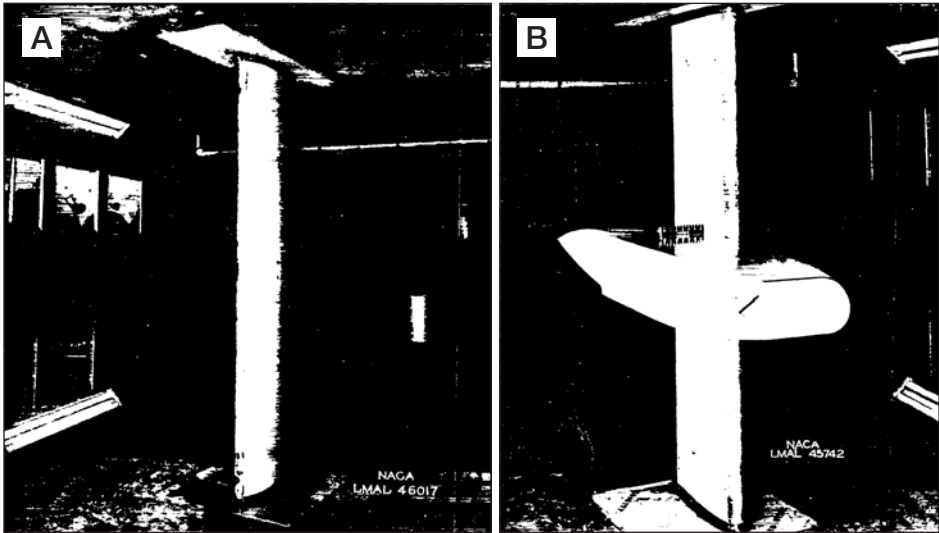

FIGURE 4. (A) Wing alone. Two dimensional mounting of flying-boat hulls in the Langley 300 MPH 7- by 10-foot tunnel. (B) Hull 203 ($L/b = 9$) with wing.

Step fairings that extended 9 times the corresponding depth of step at the keel were made of wooden blocks for the hulls of $L/b = 6$ and $L/b = 12$. The general proportions of the fairings are shown in figure 6.

TESTS

TEST CONDITIONS

The tests were made in the Langley 300 MPH 7- by 10-foot tunnel at dynamic pressures ranging from 25 to 200 pounds per square foot, which correspond to airspeeds ranging from 100 to 290 miles per hour. Reynolds numbers, based on the mean aerodynamic chord of the wing of the hypothetical flying boat, ranged from 1.25×10^6 to 3.40×10^6 . Corresponding Mach numbers ranged from 0.13 to 0.39 (fig. 7).

CORRECTIONS

Blocking corrections have been applied to the wing and wing-plus-hull data. The drag of the hull has been corrected for horizontal buoyancy effects caused by a tunnel static-pressure gradient. Angles of attack have been corrected for structural deflections caused by aerodynamic forces.

TEST PROCEDURE

The aerodynamic characteristics of the hulls were determined with the interference of the mounting wing by testing the wing alone and the wing-plus-hull

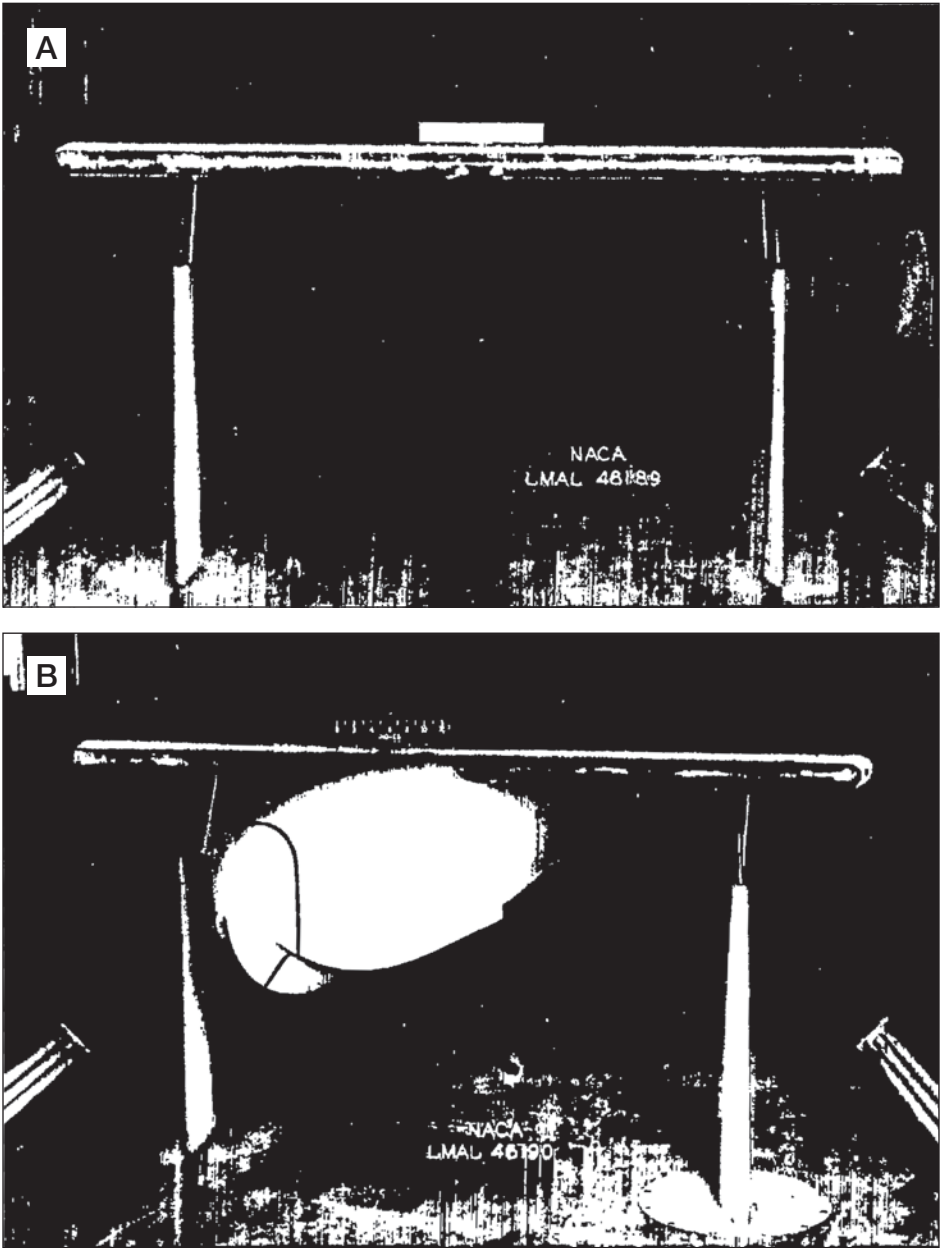

FIGURE 5. (A) Wing alone. Three-dimensional mounting of flying-boat hulls in the Langley 300 MPH 7- by 10-foot tunnel. (B) Hull 203 ($L/b = 9$) with wing.

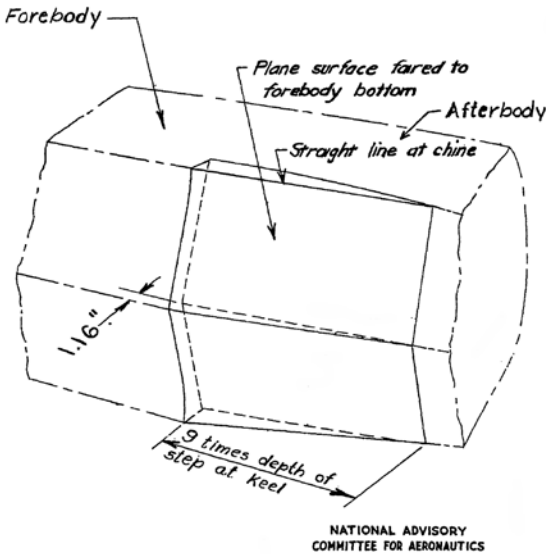

FIGURE 6. General details of step fairings. Bottom view of hull.

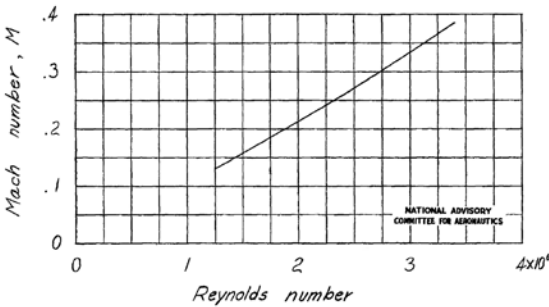

FIGURE 7. Variation of Mach number with Reynolds number of the 1/10-scale hulls of a hypothetical flying boat.

combinations under the same conditions. The aerodynamic coefficients of the hull were then determined by subtraction of wing-alone coefficients from wing-plus-hull coefficients.

In order to minimize possible errors that result from transition shifting on the wing, the wing transition was fixed at the leading edge for all tests by means of roughness strips of approximately 0.008-inch-diameter carborundum particles. The particles were applied for a length of 8 percent chord of the mounting wing measured along the airfoil contour from the leading edge on both upper and lower surfaces.

The hulls, with the exception of hull 224, were tested with fixed and free transition. For the fixed-transition tests, a transition strip 1/2 inch wide was located approximately 5 percent of the hull length aft of the bow. Carborundum particles of approximately 0.0008-inch diameter were used for this strip also.

With the exception of hull 224 ($L/b = 15$)[,] pitch tests were made with the model mounted horizontally and vertically to obtain data with different tunnel-wall conditions and different mountings. Hull 224 was tested at a later date than were the hulls of lower length-beam ratios and was tested only with the horizontal mounting. All yaw tests were made with the horizontal mounting.

RESULTS AND DISCUSSION

The effects of length-beam ratio on the variation of hull aerodynamic characteristics with angle of attack are presented in figures 8 and 9 and with angle of yaw in figure 10. The effects of length-beam ratio on drag and on the stability parameters C_{ma} , C_{ny} , and $C_{y\dot{y}}$ are summarized in figure 11. Comparison of data (figs. 8 and 9) from the two-dimensional and three-dimensional mounting setups under similar test conditions shows fairly good agreement. An increase in the length-beam ratio resulted in a reduction in the drag coefficient throughout the angle-of-attack range tested. The minimum drag coefficient for most conditions occurred in the angle-of-attack range between 2° and 3° . Because of structural limitations of the mounting wing, it was necessary to limit the data obtained at the higher Reynolds number conditions to the angle-of-attack ranges shown. With transition fixed, the minimum drag coefficient for the hull of $L/b = 9$ was less by a value of 0.0009 (12 percent) than the minimum drag coefficient for the hull of $L/b = 6$ (fig. 11). Smaller reductions in minimum drag coefficient, 0.0007 and 0.0006, occurred when L/b was extended from 9 to 12 and from 12 to 15, respectively. The over-all

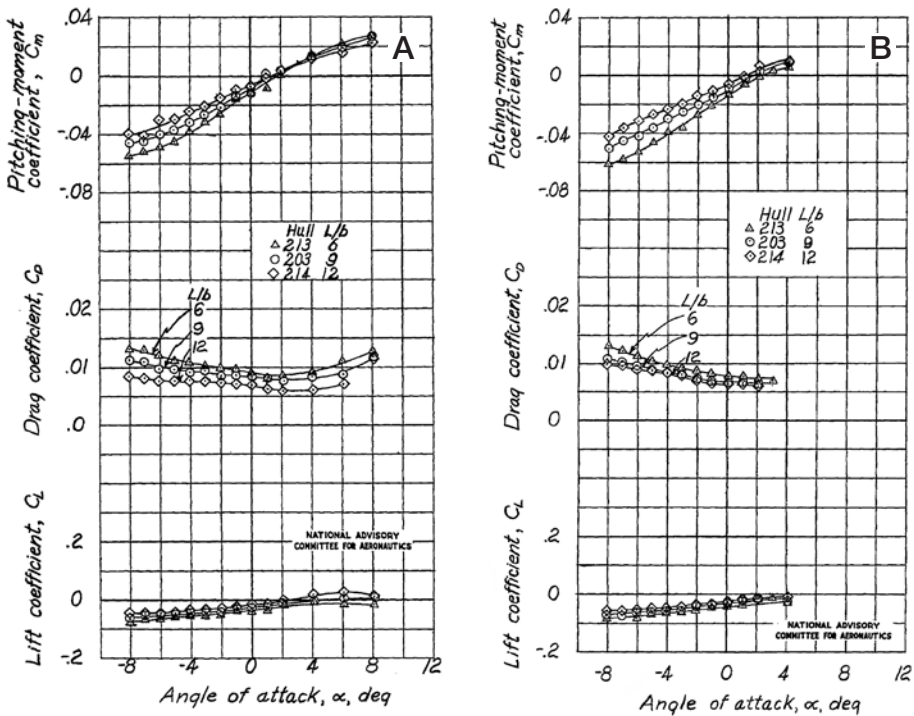

FIGURE 8. Effect of length-beam ratio on the aerodynamic characteristics in pitch of the $1/10$ -scale hulls of a hypothetical flying boat. Two dimensional mounting. (A) $R = 1,250,000$; transition fixed. (B) $R = 2,450,000$; transition fixed.

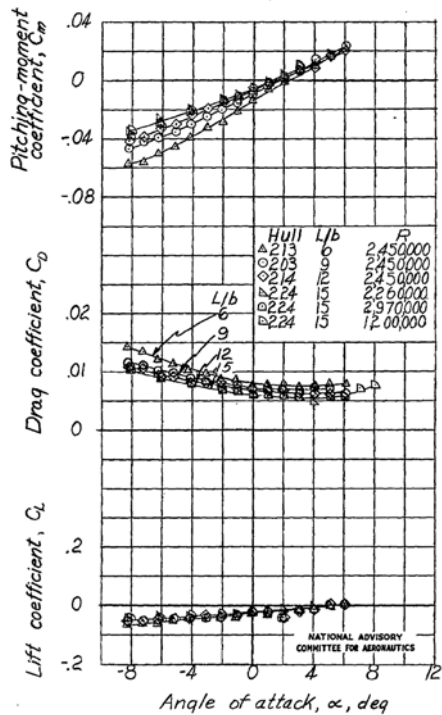
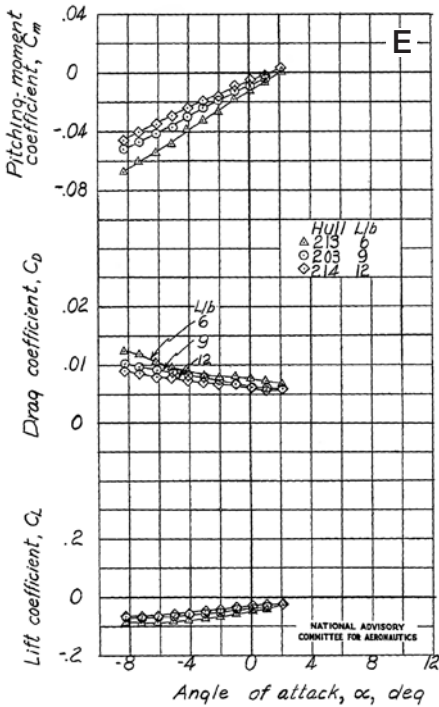
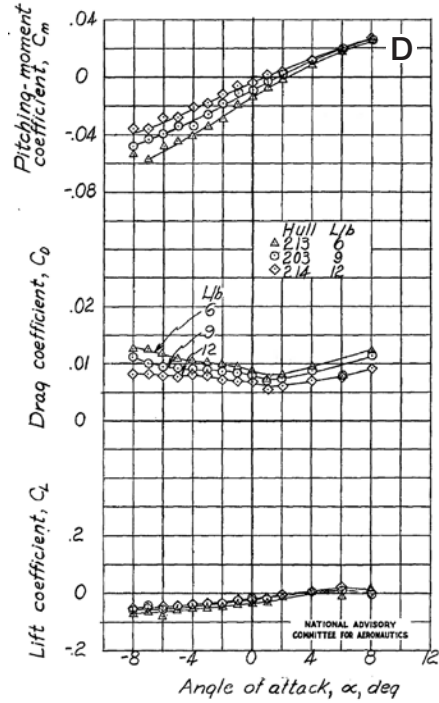
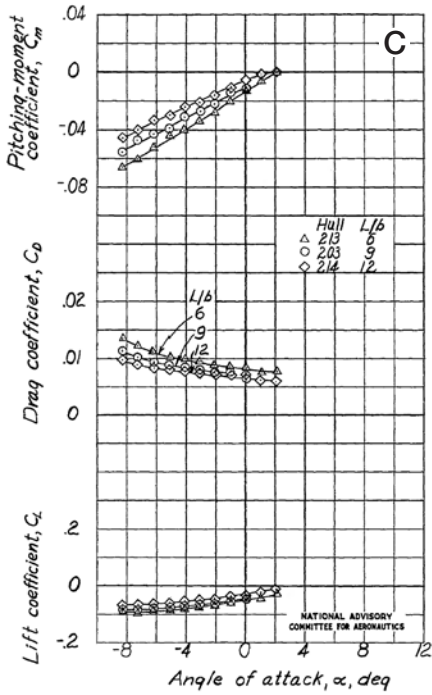

FIGURE 8. Continued. (C) $R = 3,400,000$; transition fixed. (D) $R = 1,250,000$; transition free. (E) $R = 3,400,000$; transition free.

FIGURE 9. Effect of length-beam ratio on the aerodynamic characteristics in pitch of the $1/10$ -scale hulls of a hypothetical flying boat, transition fixed. Three-dimensional mounting.

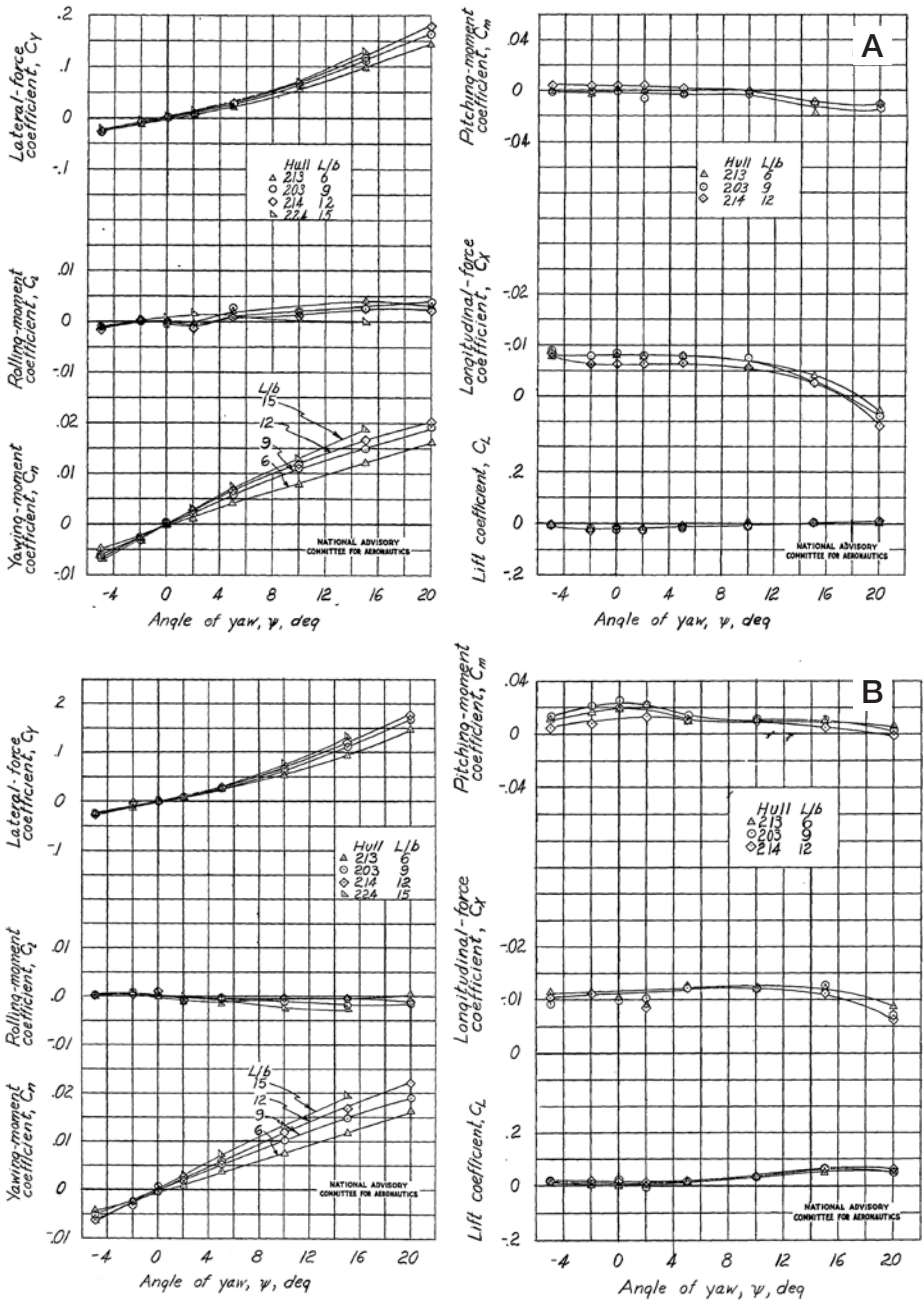

FIGURE 10. Effect of length-beam ratio on the aerodynamic characteristics in yaw of the $1/10$ -scale hulls of a hypothetical flying boat. Three-dimensional mounting. (A) $\alpha = 2^\circ$; $R = 1,250,000$; transition fixed. (B) $\alpha = 6^\circ$; $R = 1,250,000$; transition fixed.

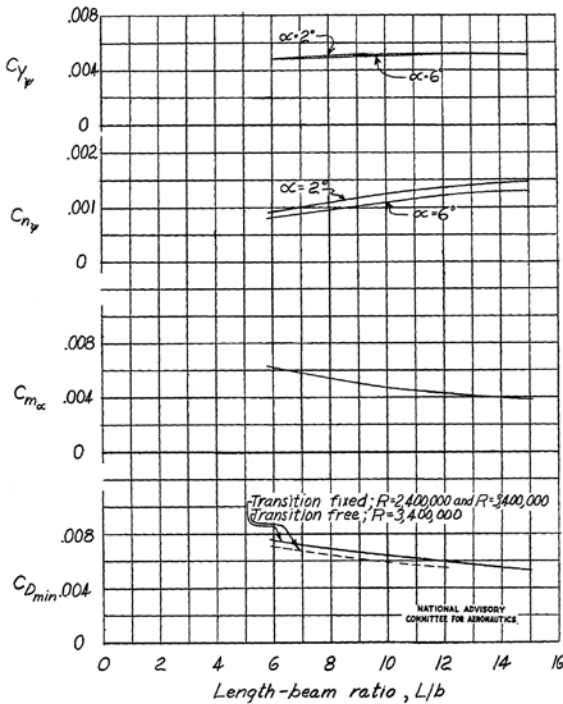

FIGURE 11. Effect of length-beam ratio on $C_{D_{min}}$ and the parameters C_{m_z} , C_{n_z} , C_{y_z} for the $1/10$ -scale hulls of a hypothetical flying boat.

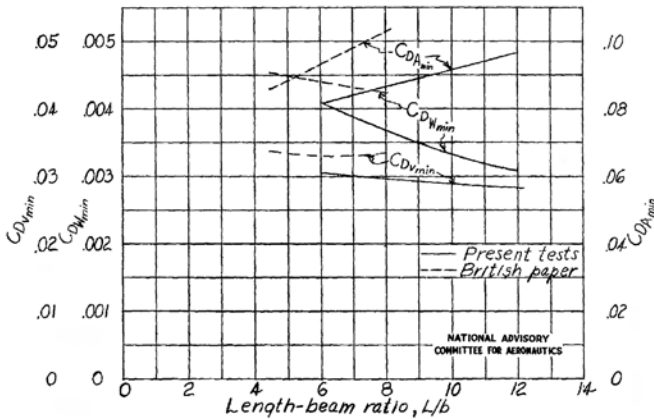

FIGURE 12. Effect of length-beam ratio on the minimum drag coefficients $C_{D_{min}}$, $C_{D_{min}}$, $C_{D_{min}}$ for the $1/10$ -scale hulls of a hypothetical flying boat and for hulls tested by the British. Transition free.

reduction for an extension of L/b from 6 to 15 was 0.0022, a reduction of 29 percent. The data for the free-transition tests show the same general variation of $C_{D_{min}}$ with L/b , and the value of $C_{D_{min}}$ is about 0.0005 lower than for the fixed-transition tests throughout the range of length-beam ratio. Reference 1 indicates that the same general trend of $C_{D_{min}}$ with L/b will probably occur for a hull without wing interference although the absolute values will differ.

The characteristic of drag reduction with increase in length-beam ratio is similar to that reported in a British paper of limited distribution by Clark and Cameron. A comparison with data from the British paper of drag coefficients (transition free) based on cross-sectional area, volume, and surface area is presented in figure 12. Variations of the drag coefficients with L/b generally compare favorably. It must be remembered, however, that the hulls tested by Clark and Cameron were not designed from the same hydrodynamic criterion used in the present investigation and were tested at a lower Reynolds number. The British results are, therefore, not directly comparable with the results of the present investigation but indicate the same trends. The effect of Reynolds number on $C_{D_{min}}$ as indicated

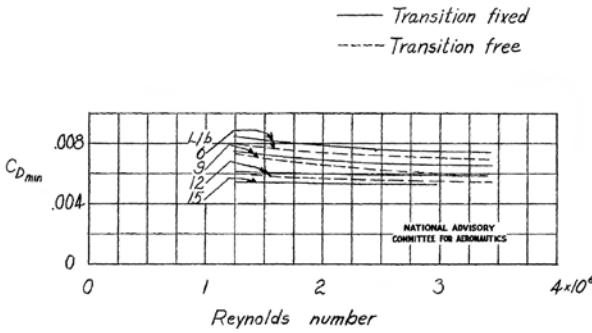

FIGURE 13. Effect of Reynolds number on $C_{D_{min}}$, for the $1/10$ -scale hulls of a hypothetical flying boat.

shown in figure 6. A comparison of these data (fig. 14) with those of the original step condition shows a similar reduction in drag coefficient for both length-beam ratios; thus the same general variation of $C_{D_{min}}$ with L/b exists. The reduction in drag coefficient was approximately 13 percent for the hull of $L/b = 6$ and 16 percent for the hull of $L/b = 12$. These data agree in general with the data of the British paper in which the drag coefficient of a hull of $L/b = 7$ ($L/b = 5.7$ as defined in the present paper) was decreased 16 percent by the addition of a step fairing.

Increased length-beam ratio had a beneficial effect on hull longitudinal stability but caused an increase in directional instability (fig. 11). The change in longitudinal stability corresponds to a rearward aerodynamic-center shift of about $2\frac{1}{2}$ percent mean aerodynamic chord on a flying boat when L/b was changed from 6 to 15. Calculations made from reference 2 for the hulls without wing interference gave values of C_{ma} approximately the same as those of figure 11, which fact indicates that the geometry of the hulls probably accounted for most of the variation of C_{ma} with L/b . Reynolds number and transition had very little effect on C_{ma} .

herein (fig. 13) was generally small; however, some reduction did occur with Reynolds number, especially for the transition-free condition.

In order to obtain some indication of the effect of aerodynamic refinement on the variation of $C_{D_{min}}$ with length-beam ratio, the hulls of $L/b = 6$ and $L/b = 12$ were tested with step fairings as

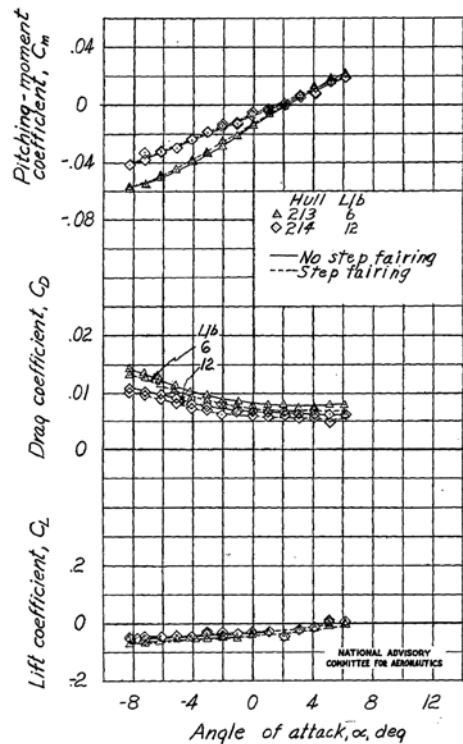

FIGURE 14. Effect of step fairing on the aerodynamic characteristics in pitch of the $1/10$ -scale hulls of a hypothetical flying boat, $R = 2,450,000$; transition fixed; three-dimensional mounting.

At an angle of attack for minimum drag of 2° , the directional instability, measured by $C_{n\psi}$, was greater for $L/b = 15$ than for $L/b = 6$, the values of $C_{n\psi}$ being 0.0014 and 0.0009, respectively. Increasing the angle of attack to 6° resulted in a less unstable condition; the values of $C_{n\psi}$ were generally reduced about 0.0002 throughout the range of length-beam ratio.

An estimate was made to determine the drag reduction with increasing length-beam ratio for the hulls fitted with vertical tails, the sizes of which were adjusted to give the same directional stability. Calculations indicate that the increase in vertical-tail size would have a small effect on the variation of drag with length-beam ratio; as a result, the drag coefficient contributed by the vertical tail would be about 0.0002 greater for $L/b = 15$ than that for $L/b = 6$. This increase in vertical-tail size would be somewhat compensated for by an allowable decrease in horizontal-tail area at the higher length-beam ratios provided that sufficient horizontal-tail area were available for trim. The decrease in horizontal-tail area with L/b , however, would probably be less than the increase in vertical-tail area.

The parameter $C_{Y\psi}$ was slightly more positive at the higher length-beam ratios. Increasing the angle of attack from 2° to 6° had a negligible effect on $C_{Y\psi}$. These variations of the parameters $C_{Y\psi}$ and $C_{n\psi}$ with L/b probably result from the increase of hull length and side area ahead of the center of moment at the higher value of L/b as shown in figure 1. For convenience the stability parameters for each value of L/b are presented in table V. In order to compare the results of these tests

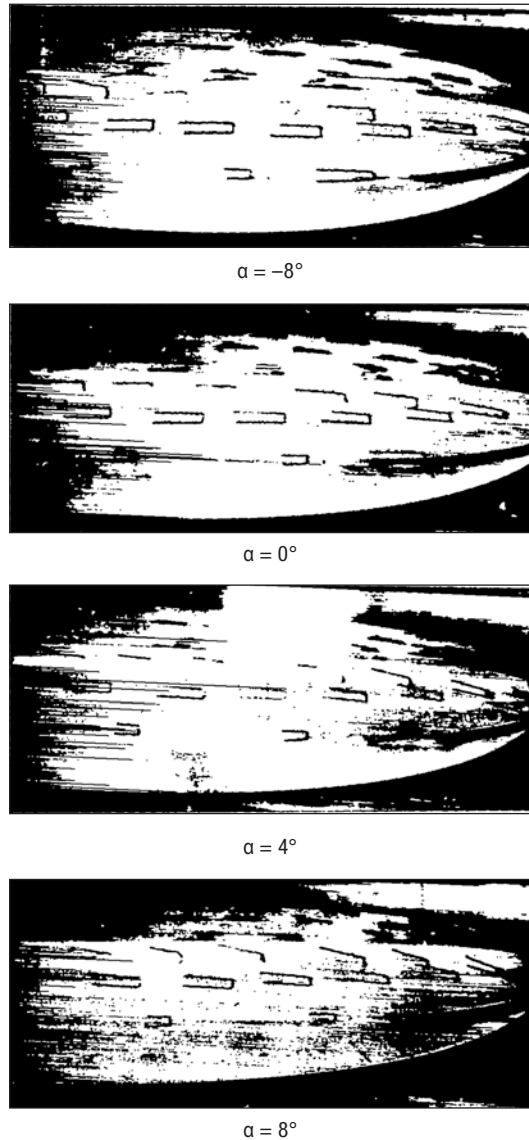

FIGURE 15. Tuft studies of forebody bottom of hull 203 ($L/b = 9$).

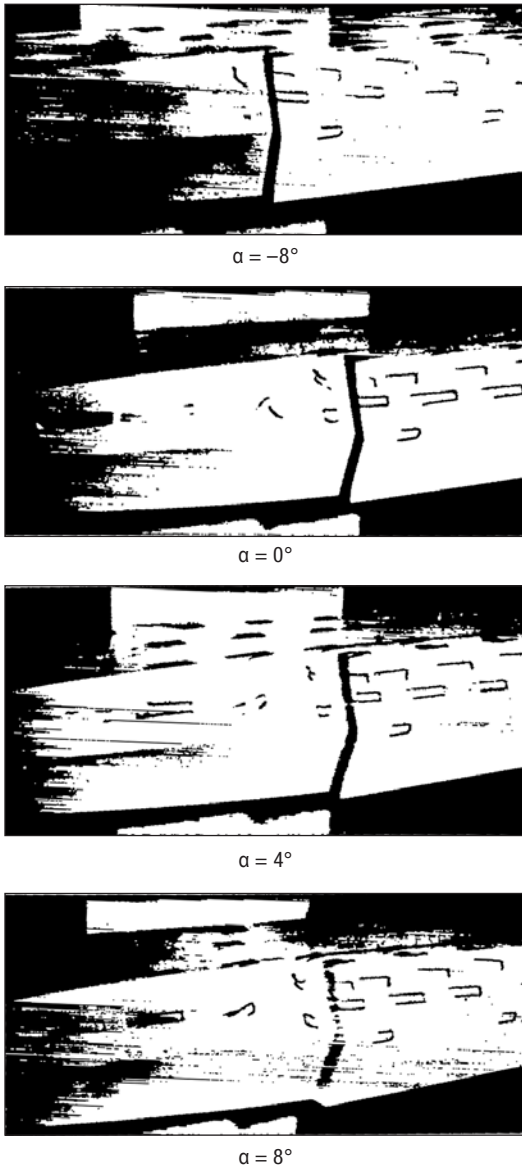

FIGURE 16. Tuft studies of step part of hull 203 ($L/b = 9$).

with the results of investigations made of other hulls and fuselages, the parameters K_f , $\frac{\partial C_{n_f}'}{\partial \Psi'}$, and $\frac{\partial C_n}{\partial \beta}$, as given in references 3, 4, and 5, respectively, are included in the table. The parameter K_f is a fuselage moment factor, in the form of $\frac{\partial C_m}{\partial \alpha}$, based on hull beam and length where α is in radians. The yawing-moment coefficient C_{n_f}' in $\frac{\partial C_{n_f}'}{\partial \Psi'}$ is based on volume and is given about a reference axis 0.3 of the hull length from the nose. The parameter $\frac{\partial C_n}{\partial \beta}$ is based on hull side area and length for which the yawing moment is also given about a reference axis 0.3 of the hull length from the nose and β is given in radians.

Instability as given by the parameters $\frac{\partial C_{n_f}'}{\partial \Psi'}$, and $\frac{\partial C_n}{\partial \beta}$ generally agreed closely with the hull values given in references 4 and 5. The increase of $\frac{\partial C_{n_f}'}{\partial \Psi'}$ with L/b can be attributed to the reduced numerical values of volume used in determining the coefficient at the higher length-beam ratios as well as the generally destabilizing effect of increasing L/b .

Tuft studies of the forebody bottom and step part of model 203 ($L/b = 9$) are presented in figures 15 and 16, respectively.

CONCLUSIONS

The results of wind-tunnel tests of a family of hulls—in the presence of a wing—having length-beam ratios of 6, 9, 12, and 15, a constant product of the beam and the square of the length, a constant height, and the same depth of step at the keel indicated the following conclusions:

1. With transition fixed a reduction in minimum drag coefficient of 0.0022 (29 percent) occurred when length-beam ratio was extended from 6 to 15.
2. Minimum drag for all hulls tested generally occurred in the range of angle of attack from 2° to 3°.
3. Increasing length-beam ratio from 6 to 15 caused an increase in hull longitudinal stability by an amount corresponding to a rearward aerodynamic-center shift of about 2½ percent mean aerodynamic chord on a flying boat.
4. Increasing length-beam ratio from 6 to 15 increased the hull directional instability by increasing the variation of yawing-moment coefficient with angle of yaw from a value of 0.0009 to a value of 0.0014 at an angle of attack of 2°.
5. Incorporating a hull step fairing, which extended longitudinally about 9 times the depth of the step at the keel, resulted in a reduction up to 16 percent in minimum drag coefficient.

Langley Memorial Aeronautical Laboratory
National Advisory Committee for Aeronautics
Langley Field, Va., December 12, 1946

TABLE I. Offsets for Langley Tank Model 213 ($L/b = 6$) [All dimensions are in inches]

Station	Distance to F.P.	Keel above base line	Chine above base line	Half beam at chine	Radius and half maximum beam	Height of hull at center line	Line of centers above base line	Angle of chine flare (deg)	Forebody bottom, heights above base line									
									Buttocks									
									0.66	1.31	1.97	2.62	3.28	3.93	4.59	5.24	5.90	
F.P.	0	10.30	10.92	0	0.	10.92												
½	0.86	5.49	9.17	3.01	3.01	14.29	11.28	10	6.79	8.11	8.96	9.20						
1	3.71	3.76	7.63	4.01	4.01	15.72	11.71	10	4.76	5.78	6.80	7.43	7.71	7.64				
2	7.42	1.83	5.45	5.06	5.06	17.36	12.30	10	2.58	3.31	4.06	4.69	5.17	5.46	5.51			
3	11.14	.80	4.00	5.66	5.66	18.41	12.85	10	1.34	1.90	2.45	3.02	3.49	3.81	4.01	4.05		
4	14.85	.27	3.01	6.04	6.04	19.12	13.08	10	.69	1.12	1.55	1.99	2.39	2.72	2.97	3.09	3.04	
5	18.56	.04	2.36	6.28	6.28	19.60	13.32	10	.37	.71	1.04	1.35	1.69	1.98	2.22	2.37	2.41	
6	22.27	0	1.98	6.41	6.41	19.88	13.47	5	.25	.52	.77	1.02	1.28	1.54	1.74	1.91	1.99	
7	25.98	0	1.83	6.45	6.45	19.99	13.54	0	.24	.47	.72	.96	1.21	1.43	1.61	1.74	1.83	
8	29.70	0	1.83	6.455	6.455	20.00	13.55	0	.24	.47	.72	.96	1.21	1.43	1.61	1.74	1.83	
9	33.41	0	1.83	6.455	6.455	20.00	13.55	0	.24	.47	.72	.96	1.21	1.43	1.61	1.74	1.83	
10	37.12	0	1.83	6.455	6.455	20.00	13.55	0	.24	.47	.72	.96	1.21	1.43	1.61	1.74	1.83	
11	40.83	0	1.83	6.455	6.455	20.00	13.55	0	.24	.47	.72	.96	1.21	1.43	1.61	1.74	1.83	
12F	44.58	0	1.83	6.455	6.455	20.00	13.55	0	.24	.47	.72	.96	1.21	1.43	1.61	1.74	1.83	
12A	44.58	1.16	3.51	6.455	6.455	20.00	13.55											
13	48.26	1.51	3.83	6.36	6.43	20.00	13.57											
14	51.97	1.86	4.08	6.09	6.39	20.00	13.61											
15	55.68	2.21	4.28	5.70	6.30	20.00	13.70											
16	59.39	2.56	4.47	5.24	6.17	20.00	13.83											
17	63.10	2.91	4.57	4.57	6.01	20.00	13.99											
18	66.82	3.26	4.63	3.76	5.81	20.00	14.19											
19	70.53	3.61	4.59	2.70	5.57	20.00	14.43											
20	74.24	3.96	4.47	1.39	5.28	20.00	14.72											
S.P.	77.45	4.27	4.27	0														
21	77.95	4.69			4.95	20.00	15.05											
22	81.66	7.47			4.58	20.00	15.42											
23	85.37	9.70			4.16	20.00	15.84											
24	89.08	11.50			3.70	20.00	16.30											
25	92.79	12.90			3.22	20.00	16.78											
26	96.50	14.18			2.70	20.00	17.30											
27	100.22	15.47			2.15	20.00	17.85											
28	103.93	16.74			1.55	20.00	18.45											
29	107.64	18.02			.93	20.00	19.07											
A.P.	110.19	18.90			.51	20.00	19.49											

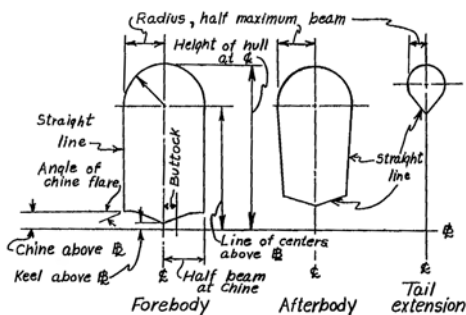

TABLE II. Offsets for Langley Tank Model 203 ($L/b = 9$) [All dimensions are in inches]

Station	Distance to F.P.	Keel above base line	Chine above base line	Half beam at chine	Radius and half maximum beam	Height of hull at center line	Line of centers above base line	Angle of chine flare (deg)	Forebody bottom, heights above base line								
									Buttocks								
									½	1	1½	2	2½	3	3½	4	4½
F.P.	0	10.30	10.30	0	0	11.00	11.00										
½	2.13	5.49	8.30	2.30	2.30	14.29	11.98	10	6.48	7.49	8.14	8.32					
1	4.25	3.76	6.71	3.06	3.06	15.72	12.66	10	4.52	5.30	6.09	6.56	6.77	6.72			
2	8.50	1.83	4.59	3.86	3.86	17.36	13.50	10	2.40	2.96	3.53	4.01	4.38	4.60	4.64		
3	12.75	.80	3.24	4.32	4.32	18.41	14.08	10	1.21	1.64	2.06	2.49	2.85	3.10	3.25	3.28	
4	17.00	.27	2.36	4.61	4.61	19.12	14.52	10	.59	.92	1.25	1.58	1.89	2.14	2.33	2.42	2.38
5	21.25	.04	1.81	4.79	4.79	19.60	14.81	10	.29	.55	.80	1.04	1.30	1.52	1.70	1.82	1.85
6	25.50	0	1.51	4.89	4.89	19.88	14.99	5	.19	.40	.59	.78	.98	1.18	1.33	1.46	1.52
7	29.75	0	1.40	4.92	4.92	19.99	15.07	0	.18	.36	.55	.73	.92	1.09	1.23	1.33	1.40
8	34.00	0	1.40	4.925	4.925	20.00	15.08	0	.18	.36	.55	.73	.92	1.09	1.23	1.33	1.40
9	38.25	0	1.40	4.925	4.925	20.00	15.08	0	.18	.36	.55	.73	.92	1.09	1.23	1.33	1.40
10	42.50	0	1.40	4.925	4.925	20.00	15.08	0	.18	.36	.55	.73	.92	1.09	1.23	1.33	1.40
11	46.75	0	1.40	4.925	4.925	20.00	15.08	0	.18	.36	.55	.73	.92	1.09	1.23	1.33	1.40
12F	51.04	0	1.40	4.925	4.925	20.00	15.08	0	.18	.36	.55	.73	.92	1.09	1.23	1.33	1.40
12A	51.04	1.16	2.95	4.925	4.925	20.00	15.08										
13	55.25	1.56	3.32	4.85	4.91	20.00	15.09										
14	59.50	1.96	3.65	4.65	4.86	20.00	15.14										
15	63.75	2.36	3.94	4.35	4.77	20.00	15.23										
16	68.00	2.76	4.22	4.00	4.65	20.00	15.33										
17	72.25	3.16	4.43	3.49	4.48	20.00	15.52										
18	76.50	3.56	4.61	2.87	4.28	20.00	15.73										
19	80.75	3.97	4.72	2.06	4.03	20.00	15.97										
20	85.00	4.37	4.75	1.06	3.73	20.00	16.27										
S.P.	88.68	4.72	4.72	0													
21	89.25	5.28			3.40	20.00	16.60										
22	93.50	8.71			3.02	20.00	16.98										
23	97.75	11.43			2.61	20.00	17.39										
24	102.00	13.61			2.16	20.00	17.84										
25	106.25	15.31			1.69	20.00	18.31										
26	110.50	16.78			1.17	20.00	18.83										
27	114.75	18.25			.63	20.00	19.37										
A.P.	116.65	18.90			.39	20.00	19.61										

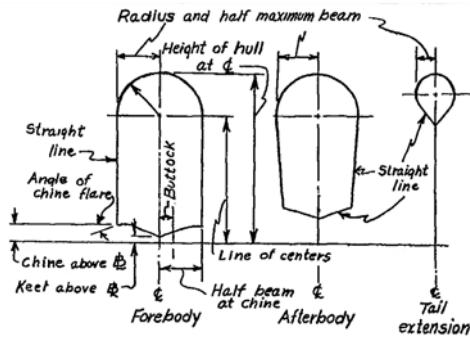

TABLE III. Offsets for Langley Tank Model 214 ($L/b = 12$) [All dimensions are in inches]

Station	Distance to F.P.	Keel above base line	Chine above base line	Half beam at chine	Radius and half maximum beam	Height of hull at center line	Line of centers above base line	Angle of chine flare (deg)	Forebody bottom, heights above base line									
									Buttocks									
									0.41	0.83	1.24	1.65	2.06	2.48	2.89	3.30	3.72	
F.P.	0	10.15	10.15	0	0	11.14												
½	2.34	5.49	7.81	1.90	1.90	14.29	12.39	10	6.31	7.14	7.68	7.83						
1	4.68	3.76	6.20	2.53	2.53	15.72	13.19	10	4.39	5.03	5.67	6.07	6.24	6.20				
2	9.35	1.83	4.11	3.19	3.19	17.36	14.17	10	2.30	2.76	3.23	3.63	3.94	4.12	4.15			
3	14.03	.80	2.81	3.57	3.57	18.41	14.84	10	1.14	1.49	1.84	2.20	2.49	2.70	2.82	2.85		
4	18.71	.27	2.00	3.81	3.81	19.12	15.31	10	.53	.81	1.08	1.35	1.61	1.81	1.97	2.05	2.01	
5	23.38	.04	1.50	3.96	3.96	19.60	15.64	10	.25	.46	.67	.86	1.08	1.26	1.41	1.51	1.53	
6	28.06	0	1.25	4.04	4.04	19.88	15.84	5	.16	.33	.49	.64	.81	.97	1.10	1.21	1.26	
7	32.74	0	1.16	4.06	4.06	19.99	15.93	0	.15	.30	.45	.60	.76	.90	1.02	1.10	1.16	
8	37.41	0	1.16	4.065	4.065	20.00	15.93	0	.15	.30	.45	.60	.76	.90	1.02	1.10	1.16	
9	42.09	0	1.16	4.065	4.065	20.00	15.93	0	.15	.30	.45	.60	.76	.90	1.02	1.10	1.16	
10	46.77	0	1.16	4.065	4.065	20.00	15.93	0	.15	.30	.45	.60	.76	.90	1.02	1.10	1.16	
11	51.44	0	1.16	4.065	4.065	20.00	15.93	0	.15	.30	.45	.60	.76	.90	1.02	1.10	1.16	
12F	56.17	0	1.16	4.065	4.065	20.00	15.93	0	.15	.30	.45	.60	.76	.90	1.02	1.10	1.16	
12A	56.17	1.16	2.64	4.065	4.065	20.00	15.93											
13	60.80	1.60	3.06	4.00	4.05	20.00	15.95											
14	65.47	2.04	3.44	3.84	4.01	20.00	15.99											
15	70.15	2.48	3.79	3.59	3.93	20.00	16.07											
16	74.83	2.92	4.12	3.30	3.80	20.00	16.20											
17	79.50	3.37	4.42	2.88	3.62	20.00	16.30											
18	84.18	3.81	4.67	2.37	3.41	20.00	16.59											
19	88.86	4.25	4.87	1.70	3.17	20.00	16.83											
20	93.53	4.69	5.01	.88	2.87	20.00	17.13											
S.P.	97.59	5.08	5.08	0														
21	98.21	5.74			2.53	20.00	17.47											
22	102.89	9.90			2.16	20.00	17.84											
23	107.56	13.05			1.75	20.00	18.25											
24	112.24	15.45			1.31	20.00	18.69											
25	116.92	17.23			.84	20.00	19.16											
26	121.59	18.83			.34	20.00	19.66											
A.P.	121.78	18.90			.32	20.00	19.68											

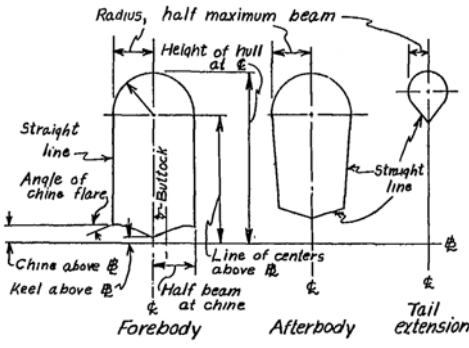

TABLE IV. Offsets for Langley Tank Model 224 ($L/b = 15$) [All dimensions are in inches]

Station	Distance to F.P.	Keel above base line	Chine above base line	Half beam at chine	Radius and half maximum beam	Height of hull at center line	Line of centers above base line	Angle of chine flare (deg)	Forebody bottom, heights above base line									
									Buttocks									
									0.36	0.71	1.07	1.42	1.78	2.13	2.49	2.85	3.20	
F.P.	0	10.30	10.30	0	0	11.00	11.00											
½	2.52	5.49	7.49	1.64	1.64	14.29	12.65	10	6.19	6.91	7.38	7.50						
1	5.04	3.76	5.86	2.18	2.18	15.72	13.54	10	4.30	4.86	5.42	5.75	5.90	5.87				
2	10.08	1.83	3.79	2.75	2.75	17.36	14.61	10	2.24	2.63	3.04	3.38	3.64	3.80	3.83			
3	15.12	.80	2.54	3.07	3.07	18.41	15.34	10	1.09	1.40	1.70	2.00	2.26	2.44	2.54	2.57		
4	20.15	.27	1.76	3.28	3.28	19.12	15.84	10	.50	.73	.97	1.20	1.42	1.60	1.74	1.80	1.77	
5	25.19	.04	1.30	3.41	3.41	19.60	16.19	10	.22	.40	.58	.75	.94	1.09	1.22	1.31	1.33	
6	30.23	0	1.07	3.48	3.48	19.88	16.40	5	.14	.28	.42	.56	.70	.84	.95	1.04	1.08	
7	35.27	0	1.00	3.50	3.50	19.99	16.49	0	.13	.26	.39	.52	.65	.78	.88	.95	1.00	
8	40.31	0	1.00	3.505	3.505	20.00	16.49	0	.13	.26	.39	.52	.65	.78	.88	.95	1.00	
9	45.34	0	1.00	3.505	3.505	20.00	16.49	0	.13	.26	.39	.52	.65	.78	.88	.95	1.00	
10	50.38	0	1.00	3.505	3.505	20.00	16.49	0	.13	.26	.39	.52	.65	.78	.88	.95	1.00	
11	55.42	0	1.00	3.505	3.505	20.00	16.49	0	.13	.26	.39	.52	.65	.78	.88	.95	1.00	
12F	60.51	0	1.00	3.505	3.505	20.00	16.49	0	.13	.26	.39	.52	.65	.78	.88	.95	1.00	
12A	60.51	1.16	2.43	3.505	3.505	20.00	16.49											
13	65.50	1.63	2.89	3.45	3.48	20.00	16.52											
14	70.54	2.11	3.31	3.31	3.44	20.00	16.56											
15	75.58	2.58	3.71	3.10	3.35	20.00	16.65											
16	80.61	3.06	4.10	2.85	3.23	20.00	16.77											
17	85.65	3.54	4.44	2.48	3.07	20.00	16.93											
18	90.69	4.01	4.75	2.04	2.84	20.00	17.16											
19	95.73	4.49	5.02	1.46	2.58	20.00	17.42											
20	100.77	4.97	5.24	.75	2.29	20.00	17.71											
S.P.	105.13	5.38	5.38	0	2.00	20.00	18.00											
21	105.80	6.19			1.96	20.00	18.04											
22	110.84	11.17			1.59	20.00	18.41											
23	115.88	14.63			1.19	20.00	18.81											
24	120.92	17.09			.75	20.00	19.25											
25	125.96	18.84			.29	20.00	19.71											
A.P.	126.12	18.90			.28	20.00	19.72											

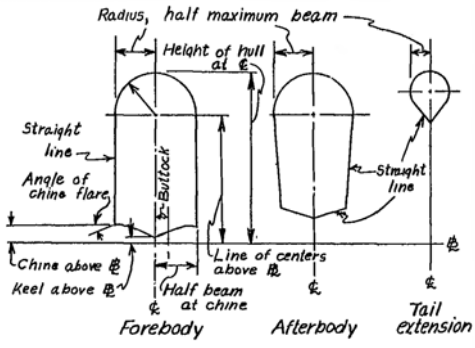

TABLE V. Minimum Drag Coefficients and Stability Parameters for Langley Tank Models 213, 203, 214, and 224

Model	$\frac{L}{b}$	$C_{D_{\min}}$	C_{m_α}	K_f	C_{Y_ψ}		C_{n_ψ}		$\frac{\partial C_n}{\partial \beta}$		$\frac{\partial C_{n_f}'}{\partial \Psi''}$	
					$\alpha = 2^\circ$	$\alpha = 6^\circ$	$\alpha = 2^\circ$	$\alpha = 6^\circ$	$\alpha = 2^\circ$	$\alpha = 6^\circ$	$\alpha = 2^\circ$	$\alpha = 6^\circ$
213	6	0.0075	0.0062	0.83	0.0048	0.0048	0.0009	0.0008	-0.099	-0.081	0.021	0.017
203	9	.0066	.0050	1.10	.0051	.0050	.0012	.0010	-.100	-.088	.027	.023
214	12	.0059	.0043	1.35	.0051	.0051	.0013	.0012	-.100	-.115	.034	.040
224	15	.0053	.0038	1.56	.0051	.0051	.0014	.0013	-.101	-.126	.041	.052

Document 5-26

George W. Gray, "Air and Water,"
chapter 4 in *Frontiers of Flight: The Story of NACA Research*
(New York: Alfred A. Knopf, 1948), pp. 63–81.

There is no better summary of the NACA's research on flying boats and hydrodynamics generally than this chapter from George W. Gray's 1948 book in salute to the NACA, *Frontiers of Flight: The Story of NACA Research*. In fact, it is such a good introduction to the entire subject of hydrodynamics and seaplanes that it might have been placed better as the first document in this chapter related to the subject. Very little that is critical to the NACA appears in Gray's study, which is natural given that the NACA employed him on contract to record the agency's contributions during World War II. Technically, it is highly insightful and very accurate; but for analysis and interpretation of the NACA, readers must turn to other accounts. Historian Alex Roland, who has offered one of those accounts, has called *Frontiers of Flight* "as fine a summary of the NACA's claims for itself as is likely ever to be prepared."

Document 5-26, George W. Gray, "Air and Water,"
chapter 4 in Frontiers of Flight: The Story of NACA Research
(New York: Alfred A. Knopf, 1948), pp. 63–81.

The airplane, like every other vehicle of transportation, has its essential environment, and aeronautical research is concerned not only with the machine but with the medium in which the machine is to operate. In the case of the landplane, the environment is the air. Of course the plane must be able to get off the ground and return to it at will, and the development of landing gear was no mean feat. But after the problem of distributing the weight of the plane among its landing wheels had been worked out, and standards had been established both for a proper supporting structure and for retracting the gear into the body or wings, the ground ceased to be an element of primary concern. The creators of landplanes were able to concentrate on the problem of shaping the machine and adapting all its parts to the major task of harnessing the lift-producing and thrust-producing forces of the air.

For a seaplane, there is no such singleness of medium. It must operate both on the water and in the air, and the equipment for transferring its weight from one to the other must be a fixed element of its structure. At least, no one has yet devised a retractable landing gear for seaplanes, and the shapes which have been most successful for engaging and navigating the water are not the most efficient for flight.

Furthermore, the air propellers must be kept clear of the water, and to provide this clearance it has been necessary to make the body that floats the seaplane larger than is needed for carrying passengers or cargo. As a result of these conflicting requirements, seaplane design has been a compromise. Seaplanes have not been as speedy as comparable landplanes of equal power and weight, because they had to carry extra bulk through the air in the form of large hulls or protruding floats that tended to have high drag. Two military planes extensively used during the war were the Coronado and the Liberator. Both had four engines of the same power, the same type of propellers, and the same size wing. But the Coronado, a seaplane, was thirty miles per hour slower than the Liberator landplane, because the poorly streamlined seaplane body was about twice as big as that of the other.

As some compensation for their lower air speeds, seaplanes have a certain advantage in their independence of prepared runways. They can come down and take off wherever there is a sizable stream, and most cities are on or within easy reach of a river, lake, or sea. Moreover, three-quarters of the globe's surface is water, so the emergency of a forced landing is hardly ever as dangerous for a waterplane as it is for a landplane. The amphibian, equipped with both landing wheels and floats, is equally at home on land and water.

Before the war, the Clipper flying boats pioneered the transport services to Hawaii, the Philippines, China, South America, and Europe. During the war the Navy used flying boats for both combat and transport. Seaplanes were active in rescue work and as patrols in antisubmarine and other ocean operations. It was a Catalina flying boat that sighted the German battleship *Bismarck* in the Atlantic and shadowed it until British bombers and warships arrived. It was another flying boat, the huge Mars of the Naval Air Transport Service, that took off from Maryland waters in November of 1943 with a gross weight of 148,500 pounds, the heaviest load that ever had been lifted by any airplane, and flew 4,250 miles non-stop to Natal, Brazil, in twenty-eight hours and twenty-five minutes (about 150 miles per hour) to carry six and a half tons of Christmas mail for the armed services.

BEGINNINGS OF HYDRODYNAMIC RESEARCH

The original research program at Langley made no provision for airplane hydrodynamics, and during its first decade the efforts of the staff were concentrated almost entirely on problems of the landplane. Many of the studies in wind tunnels and engine laboratories were applicable to seaplanes, and they[,] in common with landplanes[,] benefited from improvements in wings, propellers, engine cowlings, and other developments of the twenties. But it was recognized that the airplane on the water has problems that are not shared by the airplane in the air or on the landing strip, and in 1929 the Committee in Washington decided to enlarge the organization and equipment at Langley to provide for research in hydrodynamics. Starr Truscott, a naval architect recently from the Navy Bureau of Aeronautics,

was selected to head the new division, and as his initial job Mr. Truscott was asked to design a towing tank.

A towing tank may be likened to a wind tunnel. As the wind tunnel demonstrates the laws of airflow, the towing tank demonstrates the laws of waterflow and provides a means of experimenting with various shapes and determining their behavior when moving through the water. The device had long been used by naval architects in the design and development of ships, and there were two tanks in the United States: one at the Navy Yard in Washington, the other at the University of Michigan in Ann Arbor. Both of these ship-model tanks had been used from time to time to test models of seaplane hulls and floats, but the largest of the two was only 500 feet long and was limited to towing speeds of 15 m.p.h.

The NACA proposed to build a tank long enough and with a carriage fast enough to simulate the actual take-off conditions of a seaplane—and that meant a length of at least 2,000 feet and a towing speed of at least 60 m.p.h. These specifications were met in the tank which Truscott designed and built, floating it on the muddy shore of the Back River. The curvature of the Earth had to be taken into account in its construction, and there were unique features in the mounting of the carriage on the rails, along with other details. The tank was completed in 1931, and in the years since then[,] most of the flying boats and other seaplanes built in the United States have been studied here. In 1937 the tank was enlarged to extend the basin to a length of 2,900 feet—its width is 24 feet and its depth of water 12 feet—and at the same time the carriage was improved to increase the towing speed to 80 m.p.h. Part of the tank equipment is an apparatus for sending waves of various magnitudes over the surface, to simulate rough-water conditions for studies of take-off and landing at sea in heavy weather.

At the time the tank came into use, the principal problem confronting the designers and operators of the seaplanes was water resistance. This opposition of the water to the plowing of the hull or floats through its surface rises to a high peak, or “hump,” soon after the seaplane begins to move, whereas the air drag is by comparison slight and increases only gradually with increase of speed. The force of thrust generated by the whirling propeller is usually greatest when the airplane is standing still, and as the plane begins to move forward the thrust gradually falls off, and with every increase of speed there is a decrease of thrust. The three forces—thrust, resistance, and drag—are related to one another as indicated by the three curves of the diagram.

THE THREE FORCES THAT AFFECT TAKE-OFF FROM THE WATER

The two fundamental hurdles of seaplane design are presented in this diagram [*not reproduced*]. First, the designer must make sure that the hump of resistance will never touch the curve of thrust, for if the two should coalesce the plane would be unable to get off the water. Second, the designer must keep the gap between the

drag and the thrust as wide as possible, for the magnitude of the difference between these two forces determines the performance efficiency of the plane. If one could think only of the resistance problem and design a hull with no other requirement in mind, the task would be simple.

But a body shaped solely for water flotation and navigation would stir up such air turbulence in flight that a high percentage of the thrust would be expended in overcoming its drag. Such a seaplane, if it flew at all, would have relatively small cargo capacity, would be necessarily of slow speed, and, because of the high fuel consumption, would have a short flight range. On the other hand[,] if the body were designed with no other thought than to reduce the drag, it would be incapable of taking off from the water. The streamlined shape that is best for the air has a tendency to submerge when it is propelled on the water. A large part of the effort of the hydrodynamic staff at Langley has been expended upon the twin problems: trying to effect a seaplane body that will combine low water resistance with low air drag.

When these studies began, the most frequent question in planning a new design was whether or not the seaplane would take off. Two factors were the take-off speed and the maximum gross weight that the plane would lift at that speed. It had been customary to infer theoretical improvements from previously successful results, but application of such inferences had yielded some disappointing surprises: new designs that would not take off at the speeds planned or that would not lift the desired loads at any attainable take-off speed. The tank rendered all this guesswork unnecessary. By making a small-scale model of the proposed hull, and towing it through the tank at the planned speed and with the desired load, it was possible to settle the question in advance of costly construction.

One of the first jobs was to determine how the water resistance varied with increasing speed. It was found that the magnitude of the resistance at each speed was affected by the trim, or fore-and-aft angle, that the craft assumed; and the trim depended in part on the control power of the horizontal tail. So the initial investigations led to studies of trim and tail forces also. Finally, from the data accumulated it became possible for a designer to make quite accurate predictions of the amount of thrust required to push the craft along on the water and also to determine in advance what measure of longitudinal control was required of the tail. This extensive series of researches placed the whole subject of water resistance on a firmer basis, and established fundamental data that could be applied in the design of a seaplane of any specified gross-load capacity or take-off speed.

Performance at take-off is affected by the power loading of the seaplane and also by its wing loading. By *power loading* is meant the gross weight divided by the engine horsepower, and towing-tank experiments showed that when power loadings were held below about fifteen pounds per horsepower the effect of water resistance became a relatively unimportant criterion in hull design. As the power loading rises above fifteen pounds per horsepower, it engenders higher water resistance, limits the payload that can be carried, prolongs the take-off run, and accentuates most

of the other seaplane problems. By *wing loading* is meant the gross weight divided by the square feet of wing area. Lowering the wing loading has a favorable effect on resistance; for, with fewer pounds for each square foot of its wings to lift, the seaplane can get off at a lower speed and with less load on its hull at all water speeds.

Traditionally, hulls have been built with the length five or six times the width, but the water resistance can be reduced by increasing this length-beam ratio [*figure not reproduced*]. For example, in the two hulls whose horizontal cross-sections are diagrammed above, the area is the same for both models, but Hull No. 1 has a length 5.2 times its beam, while that of Hull No. 2 is 7.8 times its beam. When these two models, having the same weight, are towed in the tank under the same power, the water resistance of Hull No. 2 is less at all speeds. For a 140,000-pound flying boat the resistance of Hull No. 2 is only 25,000 pounds at the hump to compare with 29,000 pounds for Hull No. 1.

Because of the lower resistance of Hull No. 2, the flying boat which embodies it can accelerate to the take-off speed of 100 miles per hour more rapidly, getting off the water in 50 seconds, to compare with 60 seconds for the more resistant Hull No. 1.

THE PROBLEM OF AIR DRAG

Most of the studies of resistance have been carried on under the direction of John B. Parkinson, who succeeded as chief of the Hydrodynamics Research Division following the untimely death of Starr Truscott in 1946. Mr. Parkinson and his associates were concerned primarily with waterflow characteristics, but as rapidly as they worked out shapes for low resistance[,] they sent them to wind tunnels for appraisal of their behavior in an airstream. It turned out, as might be suspected, that changes in the length-beam ratio of seaplane bodies affected not only water resistance but air drag. A related series of hulls was investigated in one of the seven-by-ten-foot tunnels at Langley at speeds [of] up to 300 m.p.h. Increasing the length beam ratio from 6 to 12 reduced the hull drag by some 20 per cent. Translated into practical results, such a drag reduction in a flying boat would mean that it could fly a given distance on less fuel, and thus be able to carry more payload, or it could carry the same load farther.

For low-drag, the shape of a teardrop has been the traditional ideal of airplane body designers; and in an across-the-body cross-section this streamlined shape is circular [*figure not reproduced*]. But a body with a circular cross-section is ill adapted to water navigation, and for taking off from and landing on the water such a shape is a practical impossibility. For the bottom, planing surfaces are needed; that is, flat or slightly curved longitudinal surfaces, and the hulls in common use for seaplanes in the early 1930's showed, when cross-sectioned in mid-body, somewhat the shape pictured on the preceding page, with the bottom forming a broad V [*figure not reproduced*].

It was granted that planing surfaces were needed for the under parts of the hull, where it touched the water, but were they needed for the parts above the waterline? The group at Langley began a series of experiments to work out a compromise which would provide a hull with the lowest drag consistent with good hydrodynamic performance. They started with an arbitrary streamline body, its cross-section a circle, the shape that was right for traveling through the air. They then considered what modifications of this circular shell were necessary to fit it for water performance. The changes, for the most part, could be made exterior to the circular shell, and resulted in a structure whose mid-body cross-section gave this form: [*figure not reproduced*].

With this as the basic form, the researchers proceeded to give it the fore-and-aft lineaments of a hull, contracting forward into a bow and extending rearward into a stern. A whole series was built, each model representing some one change in the basic design, and each in turn was studied in the towing tank and then in the eight-foot high-speed wind tunnel. Four different bows were designed and incorporated in a model, each bow of different height. Similarly there were four different sterns, several variations in the angle of the afterbody keel, in the depth of the step where forebody joins afterbody, and so with many other modifications. In this way, the effect of varying each element was evaluated both in the water and in the air, and design charts were drawn for a hull of low drag and low resistance. The resulting hull had an air drag only 25 per cent above that of the streamline body from which it was derived, to compare with a drag penalty of 50 per cent and more for the usual hulls then in common use.

But don't suppose that the low-drag hull is a standard set of specifications, good for any seaplane irrespective of size, weight, and speed. "In every case," says Parkinson, "the hull must be tailored to fit the design by use of the broad principles outlined and by the results of wind-tunnel and tank tests of the most promising preliminary form." The low-drag hull is a type, designated as the NACA Model 84 Series. The final lines of the Hughes-Kaiser eight-engine cargo transport Hercules were based on the 84 Series, and in the wind tunnel had the lowest drag for its size of any known hull.

PORPOISING, SKIPPING, AND SPRAY PROBLEMS

The demand for larger seaplanes capable of lifting heavier loads made it necessary to increase the take-off and landing speeds, and following these changes a certain instability became more common. As the heavier[,] faster hulls taxied over the water for a take-off, they began to pitch. Instead of changing trim rather slowly, instances occurred in which the craft went into a seesawing motion like that of a plunging porpoise nosing up and down as it advanced. This porpoising assumed such violence in some cases as to cause wrecks.

A further effect of dynamic instability known as *skipping* occurred in landing, though sometimes also in taking-off a seaplane would bound along the surface like a thrown stone, alternately bumping the water and rising into the air in a series of leaps. Skipping is only a more extreme and uncontrollable form of porpoising.

By 1937, take-off and landing violences were occurring with sufficient frequency to be serious, and caused the hydrodynamic researchers at Langley to shift their attention more and more to studies of porpoising and skipping. In the long series of investigations of resistance and drag, models of hulls alone had been used; but it was clear that the thrust of the propeller and the flow of the air over the wings had their part in the impairment of stability, so the new program required complete seaplane models equipped with wings and powered propellers. These dynamic models, as they were called, had to be made very accurately as to scale, not only in size but also in distribution of weight. The co-operation of manufacturers was enlisted to develop miniature electric motors of sufficient power to drive the propellers, and these motors had to be installed inside the model without disturbing the position of its center of gravity. A whole new technique of hydrodynamic research was evolved, and by 1939 these studies were claiming most of the time of the towing tank.

As the war came, and the Navy demanded higher performance from aircraft, seaplane after seaplane was referred to the Langley Laboratory for study and improvement. Usually there was some defect of stability to be corrected. The spray problem also became increasingly imperative; for with heavier, faster planes, the hull's tendency to throw water upward against propellers, wings, and control surfaces was accentuated. So spray research was added to porpoising and skipping research, and metal strips were developed for deflecting the spray and throwing it downward and outward.

A time came when the tank was operating twenty-four hours a day, with new projects for investigation accumulating faster than it could dispose of the old ones. In this dilemma, the Committee in Washington obtained from Congress funds with which to add a second towing tank to the equipment. Tank No. 2 was built next to Tank No. 1 on the east, but is not so long (being 1,800 feet), and with its overhead carriage is more open than the older apparatus, designed particularly for the study of take-off and landing problems. Another research tool added to Langley at about the same time is the impact basin, for investigating the stresses suddenly imposed on seaplane hulls and floats in landing. These two new facilities were completed in 1942, and both were immediately put to work on wartime problems. Earlier studies in Tank No. 1 had shown that porpoising and skipping were related to the malfunctioning of a certain structural part of the hull known as *the step*, and now Tank No. 2 as well was turned to scrutiny of the step.

THE ROLE OF THE STEP

In a ship, the bottom of the hull describes a continuous surface from bow to stem, but in a seaplane the smooth continuity ends abruptly at a point amidship and the surface steps up to a higher level. The part of the hull forward of this step is known as the forebody, that to the rear the afterbody.

The separation of the bottom into two parts by the step is necessary in order to give the hull two surfaces to ride on when it gets to such a speed that it is skimming on top instead of plowing through the water. If only one surface were provided, the hull would assume unfavorable trims during take-off, and at these trims the resistance would be great enough to prevent take-off. A proper step enables air to come between the hull and the water. If, however, the step is inadequate, a mixture of air and water comes into this region and suction is developed. Suction can prevent take-off and cause any number of difficulties, so the provision of a proper step is of the utmost concern.

Since the step plays such a vital role in the process of taking-off, it was natural for investigators of porpoising and skipping to look into it first. Towing tank experiments demonstrated that the position and depth of the step were critically important to its proper functioning.

The studies showed that porpoising occurred when the step was too close to or too far behind the center of gravity, and that the center of gravity itself must be kept within a narrow fore-and-aft range amidships. They showed further that skipping occurred when the seaplane's step was too shallow, the effect of landing being to trap small quantities of air which caused the hull to skitter over the surface. Increasing the depth of the step was a sure cure for skipping, and the experiments indicated that the depth should be at least six to ten per cent of the beam, depending on the weight of the plane and angle of its afterbody.

Often the design of a seaplane was so far advanced that the dimension of the step could not be changed without seriously delaying production, and for these cases the Langley Laboratory worked out a modification that has proved to be a satisfactory substitute. The scheme is to cut two holes in the bottom of the afterbody, just back of the step, and connect these with air ducts leading to the upper surface of body or wing. Then, as the water sweeps beneath the bottom of the hull, it sucks air through the ducts and thereby provides sufficient ventilation to serve a smooth landing.

APPLICATIONS OF THE RESEARCH

Ordinarily the NACA follows the policy of publishing its findings and leaving their application to industry, the Army and Navy, and the engineering profession. But during the war, when all airplane production was for the government, and on an emergency basis, fundamental research became secondary in hydrodynamics as

in all other fields of experimentation. The main emphasis was placed on applications, on quick "fixes," to make a seaplane more stable, or able to carry a heavier load, or to get off the water more quickly. Sometimes a new design was brought to the laboratory in its early stages, and, through tests of the prototype in the tanks, refinements were worked out which contributed to the final production design. More often the seaplane reached the laboratory at a later stage of its development, and the problem was one of improving a design whose general lines were already laid down. Among the seaplanes investigated were the 314 Clipper flying boat, the amphibian Goose, Catalina, Coronado, Hercules, Mariner, Mars, and Sea Ranger.

A good example of this work is the PB2Y Coronado. In its original design this flying boat, when fueled for a long-range mission, had a gross weight of 46,000 pounds of which 3,000 pounds were payload. The Navy wished to increase the payload. Models of the airplane were studied in Tank No. 1, and these experiments indicated modifications that would improve take-off and landing characteristics. The line of the step was changed, but it was impossible to change its depth without reconstructing the whole hull, so ducts for ventilating the bottom area aft of the step were put in. The lines of the bow were changed to deflect spray. The Coronado ended up with a gross weight of 68,000 pounds, of which 12,000 pounds were payload on a 2,500-mile flight across the oceans. Despite the heavier load and faster landing speed, its stability was so assured that the plane during its war service as a naval transport to Pacific islands was repeatedly used to make landings on dark nights when the seeing is poor and the craft must descend on a steady glide path until water is touched, a more hazardous procedure than daylight landing.

The PBM Mariner was brought to Langley in its early design stage, and experimental runs in the tank indicated that the hull was too narrow. The beam was eight feet; it was difficult to take off without porpoising; spray was excessive and flung high into propellers and flaps; and the plane could not get off the water with more than 40,000 pounds. As a result of the tank studies, the Mariner was broadened to a ten-foot beam, the line of the step was brought forward several inches, and strips for controlling the spray were built into the forebody. These and other changes were incorporated in the design which reached production as the PBM-3, and the plane was so stable and seaworthy that it was regularly operated at gross weights up to 60,000 pounds.

An important aid in these researches was a device developed at the laboratory and known as the *events recorder*. It is an instrument by which the results obtained from small-scale models in the tank can be checked with the actual performance of the full-scale seaplane in the air or on the water. The events recorder is completely automatic. It is installed in the hull of the seaplane and left to write its record of what happens while the seaplane is operating. The instrument will measure and record simultaneously the speed of the plane (both on the water and in the air), its trim, the position of its elevators, the position of its rudder, the engine's revolutions per minute, and the propeller's torque and revolutions per minute (from which

water resistance is calculated). If a seaplane has a tendency to porpoise or skip, the instrument will record it, even though the pilot may be so accustomed to his craft's idiosyncrasies that he is unaware of the narrowness of its margin of stability. In the urgency of wartime research, when there was a premium on quick results, the events recorder proved its value in several ways: first, as a detective, to appraise the performance of a seaplane; second, as a means of corroborating in the plane itself the characteristics indicated by tank experiments with models; and third, as a means of checking the performance of the revised design in full-scale, to make sure that the improvements were actually realized.

DITCHING

A major project of the wartime program was the study of *ditching*, by which is meant the forced landing of a landplane at sea. There were thousands of bombers and lighter combat planes, as well as transports, which for one reason or another, because of battle injury, exhaustion of fuel, engine failure, or some other deficiency, were compelled to attempt a belly landing with a body that was designed to land on wheels. One of the sagas of the war was the ditching of the Flying Fortress in which Captain Eddie Rickenbacker was making a tour of Army outposts in the Pacific. The widely publicized story of the quick disappearance of their plane beneath the sea, leaving Rickenbacker and his fellow castaways to drift and starve and thirst for days, dramatized the frailty of the landplane compelled to function in the environment of the seaplane. It was rare that a landplane was able to keep afloat more than four or five minutes—many indeed went down less than two minutes after the crash—and often all hands were lost, trapped inside the crunched, broken shell.

In 1943 both the Army and the Navy asked the NACA to make a study of ditching. The project engaged the attention of several divisions of the Langley Laboratory. The structures group, under the direction of Eugene E. Lundquist, made static tests of the bodies of three bombers, a B-17, a B-24, and a B-26, each of which was subjected to increasing weights and pressures until it broke. The loads research group, working under direction of Richard V. Rhode and using models, measured the stress of landings in the impact basin and tested various devices proposed as ditching aids. The hydrodynamics group, also using models, studied the ditching behavior of more than a dozen different landplanes whose appraisal was requested by the armed services. Some of these studies were made in the open, on Back River, but most of them were carried on in Tank No. 2. The brunt of the research was borne by this hydrodynamic group whose program was directed by John R. Dawson.

In addition to the studies which it carried on in its own laboratories, the NACA provided the instruments and supervised their installation for two B-24 airplanes which were experimentally ditched by the Army Air Forces, one in the James River, [in] Virginia, in 1944, the other in Chactowatchee [*sic*] Bay, Florida, in 1945.

Measurements of the impact loads on the bomb-bay doors and other parts of the fuselage were made, along with other force determinations, and confirmed the values previously obtained in laboratory tests.

In a ditching, the purpose is to save the passengers and the crew, and in all this research there was no thought of developing landplanes that would be able to keep afloat indefinitely. Such an outcome would require a structure so heavily reinforced that it would be impracticable for flight. Records of past ditchings showed that the personnel's chances of escape were in inverse proportion to the structural damage suffered by the plane. Airplanes whose bodies were badly crushed sank rapidly, with a high average percentage of lives lost, whereas those which suffered little structural failure usually kept afloat long enough for the passengers and crew to launch rubber boats and get away. It was accepted, therefore, as a main thesis of the research that anything which could be done to ease the shock of the landing and reduce the magnitude of structural damage would contribute to the survival probabilities.

The program at Langley was aimed at two objectives: first, to learn everything ascertainable about ditching which might be applied to current types of landplanes to increase the chances of human escape and survival; and, second, to gather information which would be useful in the design of future airplanes.

In pursuit of the first objective, studies were made of a number of planes to determine their ditching habits. The models included Liberator, Flying Fortress, Superfortress, Havoc, Invader, Avenger, Lightning, Helldiver, and several others. One plane lands better with flaps up, another with flaps down, but the studies showed that in most models the ditching was less destructive when the flaps were extended about half way. The airplane's attitude or angle of attack in landing was also investigated, and it was found desirable in most cases to maintain the highest feasible attitude, with nose well up, since that contributes to a slow landing—but again exceptions were found, since some airplanes tend to dive at high-attitude landings. The suggestion was made that extending the landing wheels might reduce the severity of the impact on the water, but the tank studies said “No” to this. The idea of leaving the bomb-bay doors partly open to break the force of the landing was also disproved. Landing with one wing low so as to hit the water first with it, and thus cause the plane to slew around in a circular motion, was also tried in the tank experiments. For airplanes with wings high above the belly level, it was proved definitely dangerous; for low wing planes it is possibly desirable, but the maneuver requires great skill of the pilot and the results are not conclusive enough to warrant a recommendation. The idea of using a large parachute as a brake to slow the speed of the landing was tested by the Army at Wright Field and by the NACA in the full-scale tunnel at the Ames Laboratory, as well as in Tank No. 2, where models of the Liberator bomber were used. The plan did not turn out well. Ropes broke, the fabric tore, and the wreck was entangled with [the] parachute; but there were indications that with development this might be made useful.

By means of the wave-making device it was possible to produce rough water in the tank, and the characteristic behavior of the models under different conditions was evaluated here and on Back River. The experiments demonstrated that in landing on a choppy sea in a strong wind, it is best to face the wind. In swells of any size, it is more favorable to land along the swell, either in the trough or on the crest, irrespective of the direction of the wind—unless the wind is twenty-five miles per hour or more. Then the recommendation is to land straight into the wind, regardless of the sea.

The impact in ditching is terrific. Measurements show that the longitudinal deceleration as the fuselage hits the water is frequently as much as eight times the force of gravity, whereas a normal landing of the same airplane on its wheels on a landing strip imposes a deceleration only about one-half the force of gravity. The shock to the human frame can be moderated somewhat by assuming a proper body posture, and there are certain parts of the airplane that are safer than others. The worst place is the nose, “the suicide spot,” airmen call it; the next worse is the extreme rear of the plane. The safest position seems to be in the middle of the body, about opposite the trailing edge of the wing, and as high above the bottom as you can get. All these recommendations are worthless, of course, if there are no escape hatches. One very bad-acting airplane was made relatively much safer by merely adding an escape hatch.

In pursuit of the second objective of the research, the attention of airplane designers has been called to various conclusions which have a bearing on improving the ditching characteristics of future airplanes. If the wing, for example, is placed slightly above the bottom of the airplane’s body, it functions better in a ditching than lower or higher wings. If the wing is too low, it hits the water early and causes too rapid braking; if too high, the buoyancy which can be supplied by the wing is not realized until the body is well under, and then it is too late to avail much. For engine location, the studies indicate that in a multi-engine airplane it is better to have the nacelles well above the body of the fuselage, a conclusion which ties in with the recommended mid-wing position. Although the tricycle landing gear is far more efficient and safer for landing on runways and carrier decks, as earlier NACA research has demonstrated, it is nevertheless true that the old conventional landing gear, with one wheel under each wing and a single rear wheel under the tail, is safer in a ditching. The tricycle gear, with its one front wheel, places a weak spot under the cockpit where the water often breaks through and plays havoc with the pilot.

The studies of fuselage design investigated structural strength, determined the critical parts of the structure, evaluated the influence of longitudinal shape and protuberances, and considered the arrangement of interior quarters. The critical region is the middle third of the fuselage’s length. It is the part most apt to break, because of the presence there of the bomb bay with its fragile doors. A break in this region often causes the ditching airplane to nose down and dive. Tests in the structures research laboratory at Langley showed that the bomb-bay doors of the B-24

have only one-fifth as much strength as the rest of the bottom structure. The Army Air Forces Materiel Command at Wright Field designed a series of ribs to reinforce the doors against impact from outside, and tests at the structures research laboratory showed that when the ribs are in place the doors are equal in strength to the rest of the fuselage bottom. Since 1944, Liberators engaged in operations over the water have carried these ditching ribs as a safety precaution, to be installed in the case of emergency. Four are required for each airplane, they add only forty pounds to the load, and [they] can be inserted within a few minutes.

Various ditching aids have been proposed, to be installed under nose or nacelle as shields or bumpers to ease the shock and soften its impact on the main structure. Hydroflaps and hydrofoils proposed for this purpose were studied in experiments with dynamic models of military airplanes landed in calm and rough water. This work was done by the impact basin staff, though the experiments were performed on Back River. Very promising results were obtained from both devices. They gave decreased deceleration, provided protection for the forward fuselage bottom, and reduced the diving tendency of the ditched airplane.

THE CONTINUED SEARCH FOR BETTER HULLS

Despite the interruption of the basic research program by the numerous emergency problems growing out of active warfare, some lines of fundamental investigation were continued during the war, though on a limited scale. Foremost among these has been the search for a more efficient hull. John R. Dawson and his group at Tank No. 2, much of whose time was occupied by the ditching studies, had previously concentrated on problems of landing and takeoff stability. They experimented with radical departures from accepted hull design, trying to find the specifications for a seaplane body that would combine freedom from porpoising and skipping, low water resistance, and superior performance in the air. Out of these experiments has come a novel design known as the hull with a planing tail.

The conventional hull, viewed from one side, follows the longitudinal lines of the body illustrated below. Its bottom slopes from the bow back to the step which marks the end of the forebody, and then the bottom sweeps back to another step marking the end of the afterbody, from which rises the sharper upsweep of the tail.

In the new planing-tail type of hull, the forebody has a more pointed trailing edge ending at the step, and from the step the body extends at once into a long narrow tail with a V-shaped planing surface as its bottom.

Because of the merging of afterbody into tail, the second step is eliminated, and moreover this new type of hull provides an exceptionally deep main step to safeguard stability in taking-off and landing. The long afterbody tail also contributes to this result, providing the leverage of a small force operating at a greater-than-usual distance. The model tests of this design have been highly encouraging. The new hull has very desirable trim characteristics, it is free of porpoising and skipping

under all practical operating conditions, and its water resistance is exceptionally low. For example, the conventional hull's resistance is such that it can take off with a gross load 4.6 times the resistance, whereas the planing-tail type hull can get away with a gross load 6.5 times its water resistance. Tests in the wind tunnel indicate that the air drag of the new hull is less than that of the conventional hull. With further attention to airflow requirements, it is hoped that the drag may be reduced still further.

The problem of air drag is very much to the fore in seaplane research today. Indeed, present studies are largely focused on the question of seaplane performance in the air. The methods of reducing air drag demonstrated by the work on the 84-series hulls, the planing-tail hulls, and the high length-beam ratio hulls can be combined to produce a hull of much lower air drag than has heretofore been thought practicable. In large-size cargo carriers (above 150,000 pounds), seaplanes can now be built with a drag little different from that of a comparable landplane. But the development that is likely to have the most profound influence on the design of the seaplane is the advent of jet propulsion. With jet propulsion, the problem of keeping propellers clear of the water disappears, and the high-speed hulls of the future can be made much smaller than the "lumbering crates" of the past. This may mean that the world's speed record, which was held for years by the seaplanes of the Schneider Cup races, will again return to the seaplane. The possibilities invite exploration.

Document 5-27 (a-m)

Excerpts from *Annual Report of the National Advisory Committee for Aeronautics* (Washington, DC), 1946–57.

- (a) “Hydrodynamics,” *Annual Report* (1946), pp. 8–9.
- (b) “Seaplane Design,” *Annual Report* (1946), p. 14.
- (c) “Subcommittee on Seaplanes,” *Annual Report* (1947), pp. 23–24.
- (d) “Subcommittee on Seaplanes,” *Annual Report* (1948), pp. 21–22.
- (e) “Subcommittee on Seaplanes,” *Annual Report* (1949), pp. 25–26.
- (f) “Subcommittee on Seaplanes,” *Annual Report* (1950), p. 27.
- (g) “Seaplanes,” *Annual Report* (1951), p. 16.
- (h) “Seaplanes,” *Annual Report* (1952), p. 28.
- (i) “Seaplanes,” *Annual Report* (1953), p. 17.
- (j) “Seaplanes,” *Annual Report* (1954), pp. 25–26.
- (k) “Seaplanes,” *Annual Report* (1955), pp. 23–24.
- (l) “Seaplanes,” *Annual Report* (1956), pp. 37–38.
- (m) “Seaplanes,” *Annual Report* (1957), pp. 24–25.

This set of documents actually completes a string begun in Document 5-22. It is composed of items from NACA annual reports from 1946 to 1957 dealing with the NACA’s work on seaplanes. Readers may be surprised by how much work was still being done in hydrodynamics in the post-World War II era. Building from the test programs that resulted, soon after the war, in the novel high-length-beam-ratio hulls with a planing tail, NACA researchers continued to seek radical new departures from conventional hull design. They also sought ways to take seaplanes into the transonic and supersonic speed regimes and into the era of the turbojet. For example, as one will see in the annual report entries from the mid-1950s, NACA researchers evaluated the performance of floats for the Navy’s Martin YP6M-1

Seamaster jet-propelled flying boat. They also worked to develop retractable “hydro-skis” for the Navy’s experimental little XF2Y-1 Sea Dart fighter built by Convair (still to this day the only supersonic seaplane ever to fly). In addition, they searched for a way to provide water-based aircraft with the combat air performance of comparable land-based planes. These investigations contributed information essential to the design of several experimental military vehicles, including a “pantobase” airplane, a proposed amphibious type that could operate from concrete runways, grass, mud, snow, sandy beaches, or even seaplane ramps and floating rafts.

With the end of the NACA in 1958 and the birth of NASA and the “Space Age,” the focus on seaplanes ended. In December 1959, the management of NASA Langley Research Center dissolved its historic, 30-year-old hydrodynamics division and reassigned its roughly four dozen personnel to other divisions. Many of its staff members went to the Dynamic Loads Division, which dated back to the old Aircraft Loads Division of World War II and had specialized in the study of such problems as aeroelasticity, flutter, buffeting, ground wind loads, and aircraft noise. Other members of Langley’s Hydrodynamics Division transferred to Langley’s Full-Scale Research Division. This was the largest single division at the laboratory, and it was essentially composed of aeronautical researchers who staffed the larger wind tunnels. Among those who moved to “Full-Scale” was John B. Parkinson, the head of Hydrodynamics, who had worked in that division ever since coming to Langley in 1931. Only two years before the dissolution of his division, Parkinson won two major awards for his analysis and experimental verification of the principle that high length-beam ratios improved the hydrodynamic and aerodynamic characteristics of seaplane hulls; these were the first Water-Based Aviation Award, given by the Institute of Aeronautical Science, and NACA Exceptional Service Medal.

At the time the Hydrodynamics Division became defunct in December 1959, NASA Langley researchers in Tank No. 1 were studying the characteristics of some revolutionary VTOL machines over water. They were even investigating the requirements of a supersonic seaplane and a prototype “ground-effect” machine, a platform-like vehicle that could hover and move just above the ground by creating a cushion of supporting air between it and the ground surface. But the potential value of these programs was not enough to save the division from extinction. Two ambitiously experimental Martin YP6M-1 Seamaster jet seaplanes had recently been lost due to design failures; the Navy was about to terminate its entire flying-boat program; and Martin, one of the most dedicated builders of flying boats, was on the verge of moving into the guided-missile business.

Langley’s Hydrodynamics Division, historic as it was, had outlived its usefulness. Already in April 1958, management had deactivated Tank No. 2, and beginning 1 January 1960, venerable Tank No. 1 was placed on standby status. Shortly thereafter, it became an abandoned facility, later to be turned over for very occasional use by the Navy. In explaining its decision to abolish the Hydrodynamics Division, NASA pointed to “the declining need for hydrodynamics research as it applies to seaplanes and other water-borne aircraft.”

Document 5-27 (a), Excerpts from Annual Report of the National Advisory Committee for Aeronautics (Washington, DC), 1946-57, "Hydrodynamics," Annual Report (1946), pp. 8-9.

Basic hydrodynamic research has been focused sharply on applications to seaplane design and operation. The over-all accomplishment in this field in the last 6 years has been the broadening of scope of the research to include hydrodynamic stability and general seaworthiness as well as the primary subject of hydrodynamic forces. The timing of this change was such that the results obtained could be applied directly to the solution of urgent problems during World War II.

Systematic researches in the Langley tanks on the principal design parameters of seaplane hulls were highlighted by the establishment of fundamental relationships between the loadings and proportions in terms of the chief operational qualities of most concern. The results led directly for the first time to means of isolating the fundamental parameter of length-beam ratio, which previously had been obscured by simultaneous variations in hull size.

Other factors explored by the investigation of related families of hull models included the effects of deadrise, step depth and plan form, afterbody angle and length, chine flare and chine rounding, step fairings, planing flaps, and propeller location. The important relationship between afterbody ventilation and hydrodynamic stability was discovered and extensively investigated.

The results of the fundamental researches named were applied to the accelerated development in the tanks of such famous wartime seaplanes as the Catalina, Coronado, Mariner, and Mars.

In the case of a 400,000-pound cargo flying boat, laid down for the movement of the heaviest military equipment over vast distances, the builders worked closely with the tank staff in the preliminary design with the result that no large changes in the hull were required at any stage in the development to obtain superior hydrodynamic and aerodynamic qualities.

In addition to the urgent military developments, a novel hull form was originated which was shown to have the lowest water resistance yet obtained in a tank. This form, termed the planing-tail hull, has also met all stability and aerodynamic drag standards.

The literature on the hydrodynamic characteristics of the planing surface, which is the fundamental lifting element for the surface of the water, was enlarged by the evaluation of the stability derivatives associated with seaplane "porpoising," and by the systematic investigation in the tanks of the stability of simple surfaces, singly and in tandem. This research led to methods of satisfactorily predicting the lower trim limit of stability of a seaplane hull, and to a means of isolating the effects of various hydrodynamic or aerodynamic derivatives on the stability limits.

The available knowledge on the hydrodynamic characteristics of submerged hydrofoils was enhanced by experimental investigations of practical combinations

at water speeds [of] up to 60 miles per hour. It was possible in the closely controlled tests in the tank to measure the effects on the hydrodynamic lift and drag of dihedral, partial submersion, tip shape, leading-edge shape, biplane interference, and strut interference. A special low camber section was developed which delayed the onset of cavitation to higher speeds in a manner analogous to delay of the critical compressibility speed for airfoils.

*Document 5-27 (b), Excerpts from Annual Report of the
National Advisory Committee for Aeronautics (Washington, DC),
1946–57, “Seaplane Design,” Annual Report (1946), p. 14.*

In the design of seaplanes, the research objective has been to establish the fundamental parameters associated with various hydrodynamic qualities with a view toward establishing design criteria for the components of the airplane which can be varied to achieve the desired overall performance. This objective has been reached in several important respects with the result that, as in the case of flying and handling qualities in the air, the research staff, design engineers, and pilots were able to proceed along parallel lines to obtain significant improvements in water-based aircraft.

The established dependence of take-off stability on the trim has provided a useful criterion for all the components affecting the longitudinal moments; that is, the moments must be balanced to obtain stable trim throughout the take-off speed range. When this balance has been obtained, the travel of the center of gravity for take-off is limited in the same way as for aerodynamic stability and control.

The tank research has shown that the most powerful hull parameter influencing the location of the hydrodynamic stable range is the fore and aft location on the step. Designers for sometime [*sic*] have therefore been able to locate the step with respect to the wing by this means, and costly mistakes in design have been avoided by determining the step location for stable take-offs on the basis of tests of models having all the moment-producing components properly simulated.

Tank research has established the dependence of landing stability on the afterbody ventilation, particularly that afforded by the depth and shape of the step, and the form of the afterbody adjacent to it. The application of this relation has proved to be useful in hull design and has resulted in marked improvement in the stability of the newer flying boats. In one wartime case the application of ventilation ducts based on the research findings made the use of approximately 300 four-engine flying boats practicable in the transportation of vital military personnel and supplies, even for night landings where the craft must descend on a steady glide path until the water is contacted.

With the military overloading of several naval flying boats, the resulting heavy spray seriously limited the seaworthiness and increased maintenance time. Methods were developed in the tanks for spray control which assisted in keeping the spray out of the propellers and off the aerodynamic surfaces. For one flying boat

originally designed for 46,000 pounds gross weight, spray strips were developed in the tank which enabled take-offs at an overload of 76,000 pounds to be made without spray damage.

In a broader sense, research on spray has indicated the most favorable shape for spray-control devices, and an efficient form of "butterknife" chine suitable for retraction has been evolved. It has also been shown that the general seaworthiness is largely a function of the relationship of the loads and proportions decided upon in the preliminary design stage, thus affording useful criteria for the beam loading and length of forebody in the newer designs.

*Document 5-27 (c), Excerpts from Annual Report
of the National Advisory Committee for Aeronautics
(Washington, DC), 1946-57, "Subcommittee on
Seaplanes," Annual Report (1947), pp. 23-24.*

AERODYNAMIC CHARACTERISTICS

Seaplane research has been directed toward reducing the aerodynamic drag of seaplanes without imposing penalties on the hydrodynamic characteristics.

Recent research on seaplane hulls has brought to light a number of ways that they may be improved both aerodynamically and hydrodynamically. These studies have indicated that increasing the length-beam ratio in such a manner that the hydrodynamic performance remained unchanged resulted in smaller frontal area. Wind-tunnel tests (Technical Note 1305) verified the predicted decrease in drag and showed that no appreciable change in stability resulted from the increased length-beam ratio. A study of the hull structure indicated that a favorable reduction in structural weight would be expected with an increase in length-beam ratio. These trends show that increased performance in the form of range, speed, and payload can be expected from seaplanes designed with higher length-beam ratio hulls.

ROUGH WATER CHARACTERISTICS

In the past the theory of the impact of seaplanes landing in rough water has been confined to the first impact despite the fact that larger loads are often imposed at later impacts because of the difficulty of predicting mathematically the dynamic behavior and contacting conditions during subsequent bouncing. Powered dynamic models have proved a useful tool in determining the behavior and impact accel[erations] during this latter phase of the landing. Tests showed that for each seaplane there was a critical wave length which produced the maximum impact loads and further that the length was independent of wave height. A long afterbody was found to materially reduce the maximum impact loads encountered during a landing.

In order to test the validity of an impact theory developed by the NACA in recent years (Technical Note 1325), single impact tests were made on an approaching wave with a prismatic float. The theory was verified by agreement between the impact loads obtained from this form of float and those computed from the theory. The combination of the theory and the dynamic history obtained from the dynamic models will lead to a more complete understanding of the complex relations between the many factors involved in the rough water operation of seaplanes.

SPECIFIC MODEL TESTS

Dynamic models of several flying boats being built for the Navy were tested to provide design information and flight handling characteristics before the flight tests. Factors investigated during these and other general tank tests include the effect of varying the step depth, plan form, afterbody keel angle, deadrise, reversed-type longitudinal steps, wing-tip floats, and spray strips. These factors increase the understanding of hydrodynamic phenomena and provide information making possible better seaplane designs.

Document 5-27 (d), Excerpts from Annual Report of the National Advisory Committee for Aeronautics (Washington, DC), 1946-57, "Subcommittee on Seaplanes," Annual Report (1948), pp. 21-22.

LENGTH-BEAM RATIO

Seaplane research has been focused sharply on the possible methods of developing operational seaplanes which will have minimum air drag consistent with acceptable hydrodynamic characteristics. Increasing the length-beam ratio of the hull of a flying boat by maintaining constant the product of length squared and beam has been a promising direction of development and extensive investigations have been conducted on hulls of high length-beam ratio.

Wind-tunnel tests of model hulls mounted on a wing had shown that the air drag was reduced when the length-beam ratio was increased from 6 to 15. In order to determine the extent of wing interference, tests were made of the hulls without the wings. The results (Technical Note 1686) confirmed the previous conclusion that increasing the length-beam ratio reduced the air drag.

To investigate the effect on structural weight of use of a high-length-beam-ratio hull, a mathematical analysis was carried out; it was concluded that a weight saving would result with no reduction in strength.

Because of the advantages of reduced air drag and reduced structural weight, the series of length-beam-ratio hulls were investigated in the towing tank to determine their hydrodynamic characteristics. The spray in the vicinity of the propellers

and flaps was slightly better on high-length-ratio hulls, but the spray around the horizontal tail was slightly worse. It was concluded that the over-all spray was of about the same severity. Hydrodynamic stability and resistance measured on complete dynamic models (Technical Note 1570) were practically unchanged by increasing the length-beam ratio.

UNCONVENTIONAL SEAPLANES

An airplane is designed primarily to fly and devices used for taking off and landing are secondary to the primary design purpose. In some airplane designs, the landing gears are so greatly subordinated to the flight missions that any workable arrangement is permissible. With the philosophy of this design practice in mind, research has been directed toward providing a means of seaplane take-off and landing which will not penalize the flight characteristics.

STEP DEPTH

The step on a seaplane must be deep enough to prevent skipping on landing and yet not so deep as to cause unnecessary air drag. An empirical formula has been devised (Technical Note 1571) from a series of model tests for computing the depth of step necessary from the length of the afterbody and the afterbody keel angle. A comparison of this formula with the results of other model investigations and flight tests shows it to predict accurately the depth of step required.

SMALL TWIN-FLOAT SEAPLANES

Because of the large number of low-powered twin-float seaplanes encountering take-off difficulties, an analysis of the take-off resistance was made (Technical Note 1524). The resistance at the high Froude numbers encountered near the take-off speed was found to be critical for take-off. Based on previous experience, methods of reducing this resistance were suggested.

*Document 5-27 (e), Excerpts from Annual Report
of the National Advisory Committee for Aeronautics
(Washington, DC), 1946-57, "Subcommittee on
Seaplanes," Annual Report (1949), pp. 25-26.*

PLANING-TAIL HULLS

Hydrodynamic research on the planing-tail type of hull has been continued in Langley tank No. 2 with forms representing the extreme in aerodynamic refinement for improvement of flight performance. These refinements indicate the extent

of the hydrodynamic penalties to be paid for the compromises made to achieve low drag, but at the same time demonstrate the practicability of such forms for application to advanced seaplane designs. With the point of view adopted in the research toward over-all improvements in hull form, special techniques were necessarily developed in the tank for adequate evaluation of the hydrodynamic qualities of interest. Parallel investigations of refined planing-tail hulls were also conducted in the Langley 300-mph 7- by 10-foot tunnel to indicate the aerodynamic gains that might be achieved with this type of hull.

LENGTH-BEAM RATIO

An investigation of the effects of hull length-beam ratio on hydrodynamic characteristics in waves has been made in Langley tank No. 1, and the results are reported in Technical Note 1782. It is concluded that when the product of length squared times beam is held constant, as would very nearly be the case for interchangeable hulls on a given seaplane, the motions in trim and rise and the maximum probable vertical accelerations in waves are substantially reduced as the length-beam ratio is increased. The maximum probable angular accelerations on the other hand are increased until extreme length-beam ratios are reached because of the increase in hull length associated with decrease in beam for a specific design.

The research to date is believed to establish broadly the upper limit from the standpoint of hydrodynamic characteristics beyond which no further over-all improvements may be expected from increase in hull fineness ratio alone.

Similar tank investigations of detailed modifications of the form of a hull having a high length-beam ratio are reported in Technical Notes 1828 and 1853. Forebody warp (progressive increase in dead rise from step to bow) and increase in afterbody length are shown to have marked favorable influences on behavior in rough water. Forebody warp greatly improved spray and overload capacity while increased afterbody length had a smaller adverse effect on these qualities. Other hydrodynamic characteristics of interest were relatively unaffected by the modifications.

The effects of combining the modifications are reported in Technical Note 1980. In general, the effects of the separate changes were additive to a certain degree[,] resulting in a particularly promising hull form, with a high length-beam ratio, for open-sea operations. Inferior bow-spray characteristics associated with the lengthened afterbody alone were more than compensated for by the improvements in this quality gained with the warped forebody.

The aerodynamic investigation of hull length-beam ratio in the Langley 300-mph 7- by 10-foot tunnel [has] been extended to very high ratios. The additional effects of the extreme ratios (of limited usefulness from a practical design point of view) on the aerodynamical characteristics were found to be small.

HIGH-SPEED HYDRODYNAMICS

The long-range program of hydrodynamic research on methods of water-basing high-speed aircraft has been continued. The possibilities of various high-speed configurations and auxiliary devices for use in military operation have been evaluated and the fundamental characteristics of promising hydrodynamic lifting elements have been studied in Langley tank No. 2.

Document 5-27 (f), Excerpts from Annual Report of the National Advisory Committee for Aeronautics (Washington, DC), 1946-57, "Subcommittee on Seaplanes," Annual Report (1950), p. 27.

HYDRODYNAMICS

Hydrodynamic studies in the Langley tanks have continued to provide research data to aid in the development of high-speed water-based airplanes which will have a minimum of aerodynamic penalty for hydrodynamic performance. Tests were made on unorthodox shapes as well as some of the more orthodox hulls incorporating high length-beam ratio and long afterbodies. Studies were made to evaluate the effects of a number of auxiliary lifting devices for use in water operation and fundamental data concerning their behavior were obtained.

LANDING LOADS

Hulls of high length-beam ratio not only reduce air drag in flight but also fortunately reduce landing impact loads as well. Tests were made in the Langley impact basin of such a hull incorporating 30° dead rise. The impact results were reported in Technical Note 2015 and pressure distributions were reported in Technical Note 2111. It was found that the instantaneous pressures for a given draft, trim, and location on the bottom are directly proportional to the square of the velocity normal to the keel.

A smooth-water full-scale landing investigation was conducted for the purpose of comparing measured and calculated wing bending moments during hydrodynamic impact. The results of this investigation were reported in Technical Note 2063.

*Document 5-27 (g), Excerpts from Annual Report
of the National Advisory Committee for Aeronautics
(Washington, DC), 1946–57, “Seaplanes,” Annual Report (1951), p. 16.*

Hydrodynamic studies have continued in the Langley tanks to provide basic and design data for the development of water-based airplanes.

One study reported in Technical Note 2297 investigated the use of high angles of dead rise on high-length-beam-ratio flying-boat hulls as a means for reducing water loads encountered during rough-water operation. An increase in angle of dead rise from 20° to 40° increased the take-off stability and substantially improved the spray characteristics of a high-length-beam ratio hull. An expected decrease in take-off performance was evidenced by increases in take-off time and distance of 25 and 30 percent, respectively. The over-all rough-water landing behavior was improved; the maximum vertical and angular accelerations were reduced approximately 55 and 30 percent, respectively. The reduction in vertical acceleration was in good agreement with that predicted by impact theory.

*Document 5-27 (h), Excerpts from Annual Report
of the National Advisory Committee for Aeronautics
(Washington, DC), 1946–57, “Seaplanes,” Annual Report (1952), p. 28.*

The NACA has conducted several investigations at the Langley Laboratory to provide basic and design data for water based airplane configurations as well as for seaplane components. Also, the NACA has sponsored an investigation of the hydrodynamic characteristics of a series of hull models suitable for small flying boats and amphibians at the Stevens Institute of Technology. In this investigation, reported in Technical Note 2503, the hydrodynamic resistance and main spray characteristics were determined for a group of hulls consisting of a basic hull having simple lines, and of variations in this design in which the beam, sternpost angle, and afterbody length were altered. Three of the most promising hulls were tested for landing and porpoising characteristics. The results showed that it is possible to design a hull with simple lines suitable for small flying boats or amphibians. The results also indicated that refining the hull lines would improve the hydrodynamic characteristics only slightly at the expense of more complicated construction features.

*Document 5-27 (i), Excerpts from Annual Report
of the National Advisory Committee for Aeronautics
(Washington, DC), 1946-57, "Seaplanes," Annual Report (1953), p. 17.*

The increased takeoff and landing speeds of water-based aircraft and the use of hydroskis as lifting devices has emphasized a need for information on the principal planing characteristics of prismatic surfaces at high attitudes with respect to the water surface, speeds, and wetted lengths. This information is needed for performance calculations, determination of hydrodynamic balance, and prediction of impact loads.

The hydrodynamic forces and centers of pressure on prismatic surfaces have been determined for ratios of the wetted length to beam [of] up to 7, attitudes with respect to the water as high as 30°, and speed coefficients [of] up to 25. Data for a flat plate are presented in NACA Technical Note 2981, and data for surfaces having 20° and 40° of dead rise are presented in Technical Note 2876. Since flare at the intersection of the bottom and sides of a planing surface (chine flare) is generally desirable for spray control and for recovery of lift lost by the use of dead rise, data also were obtained for 20° and 40° deadrise surfaces with horizontal chine flare. Data for these surfaces are presented in Technical Notes 2804 and 2842, respectively.

The results of these studies show that, during high-speed steady-state planing, the planing characteristics for a given trim depend primarily on the lift coefficient (lift divided by wetted area and dynamic pressure) rather than on speed and load. Increasing the angle of dead rise from 0° to 20° and from 0° to 40° resulted in average losses in lift coefficient of approximately 27 percent and 50 percent, respectively. With horizontal chine flare, these losses in lift were reduced to 15 percent and 30 percent, respectively. In general, the ratio of the center-of-pressure location forward of the trailing edge to mean wetted length decreased with increase in dead rise. Friction drag at high attitudes was negligible, and thus the drag may be assumed to be equal to the product of the load and the tangent of the attitude angle.

*Document 5-27 (j), Excerpts from Annual Report
of the National Advisory Committee for Aeronautics
(Washington, DC), 1946-57, "Seaplanes," Annual Report (1954), pp. 25-26.*

HYDRODYNAMIC ELEMENTS

The general program of research on hydrodynamic lifting elements has been extended to include the effects of vertical chine strips on the hydrodynamic forces and centers of pressure of planing surfaces having dead rise. Vertical chine strips are of particular interest because of their favorable effect on the spray characteristics and on the lift. Wetted length, resistance, and center-of-pressure location were determined at speed coefficients [of] up to 25, load coefficients [of] up to 80, and trims [of] up to 30° for prismatic surfaces having basic angles of dead rise of 20° and 40° with vertical chine strips. These results are presented in Technical Note 3052. Comparisons of the more important planing characteristics are made with those for related surfaces, with and without horizontal chine flare, and for a flat plate. These comparisons show that vertical chine strips are a more effective means for increasing the lift of a given surface than is horizontal chine flare. This increase in lift, however, is accompanied by a substantial increase in drag, so that the lifting efficiency of a surface with vertical chine strips is approximately the same as that of a surface with chine flare.

The application of hydroskis to water-based airplanes has brought about a need for information on the characteristics of hydroskis when operating beneath the water surface. A theoretical and experimental investigation of the characteristics of simple flat plates having aspect ratios of 1.00 and 0.25 has, therefore, been made and the results are given in Technical Note 3079. The experimental investigation disclosed that two types of leading-edge separation can occur when lifting surfaces approach the water surface from below. One type, called white water and found only for the aspect-ratio-1.00 surface, caused a slight decrease in the lift and moment coefficients and a slight increase in the drag coefficient. The other type, called a planing bubble and found for both surfaces, caused a sharp drop in the lift, drag, and moment characteristics of the order of that to be expected in the transition from the submerged to the planing condition. The theoretical investigation was made to develop a method for the calculation of lift under conditions where the flow is not separated from the plate and where the water surface is far enough above the plate to have negligible influence on lift. The method of calculation was developed by modification of Falkner's vortex-lattice theory. The calculated lift was found to be in good agreement with the experimental results obtained in the tank and also with aerodynamic data obtained from a wind tunnel.

The present trend toward the use of underwater lifting surfaces on water-based aircraft and on surface vessels has emphasized the need for drag data on supporting struts which pierce the water surface. An investigation, therefore, has been made to

determine the hydrodynamic drag of three surface-piercing struts at 0° angle of yaw at depths [of] up to 6 chords for speeds [of] up to 80 fps at various angles of rake. These results are presented in Technical Note 3092. Two of the struts had NACA 66₁—012 airfoil sections and the third strut had an NACA 66₄—021 airfoil section. Section drag coefficients, determined from plots of drag against depth, were in good agreement with available wind-tunnel results. Raking the struts changed the section drag coefficient as expected because of the change in effective thickness ratio with angle of rake. The drag coefficient corresponding to the drag at the surface intersection was approximately constant at Froude numbers above 8.0 and at subcavitation speeds. The inception of cavitation was noted at a speed higher than that predicted from two-dimensional-flow theory. This difference was due to the influence of the free-water surface on the pressure distribution.

HYDRODYNAMIC CONFIGURATIONS

Results of wind-tunnel and tank investigations already are available for a related series of hull forms having a wide range of length-beam ratio. To supplement these results, the static properties and resistance characteristics of this family of hulls have been determined and are presented in Technical Note 3119. The static properties are presented as charts from which draft, trim, and upsetting moment for wide ranges of load, center-of-gravity location, and roll for any length-beam ratio in the series may be obtained. The resistance and trimming moments also are presented in the form of charts for models having length-beam ratios of 6 and 15.

*Document 5-27 (k), Excerpts from Annual Report
of the National Advisory Committee for Aeronautics
(Washington, DC), 1946-57, "Seaplanes," Annual Report (1955), pp. 23-24.*

HYDRODYNAMIC ELEMENTS

Recent developments in water-based aircraft have resulted in configurations utilizing planing surfaces operating in ranges of trim, length-beam ratio, and Froude number beyond those for which most of the available planing theories were correlated with experimental data. The existing theories for a rectangular flat plate in pure planing have therefore been correlated with existing data, including recent unpublished data. These results, published in Technical Note 3233, indicate the need for a rational theory that will agree with data in the recently extended ranges. A theory based on the consideration of linear lifting-line theory, the suction component of lift, and crossflow effects is presented. The agreement between the proposed theory and experimental data was found to be satisfactory for engineering calculations of pure-planing rectangular flat-plate lift and center of pressure.

As a continuing part of the NACA research program to provide data needed for the application of hydroskis to water-based aircraft, the force characteristics of an aspect-ratio-0.125 flat plate operating submerged beneath the water surface at several depths have been determined. These data are reported in Technical Note 3249 where they are compared with similar data from flat plates having aspect ratios of 1.00 and 0.25 and also with various aerodynamic theories. The comparisons indicate that decreasing either the aspect ratio or the depth of submersion decreased the lift coefficient, drag coefficient, and lift-drag ratio. The center of pressure moved rearward with decreasing aspect ratio. Cavitation at the leading edge caused a gradual decrease in lift coefficient and a gradual increase in drag coefficient. The planing-bubble type of high-angle separation caused sharp decreases in lift, drag, and moment coefficients. The ventilation boundaries defining the start of the high-angle separation moved to higher speeds and higher angles as the aspect ratio was decreased. A theory obtained by modifying Falkner's vortex-lattice theory, which had shown good agreement at all angles for aspect ratios of 1.00 and 0.25, also agreed with the data for the aspect-ratio-0.125 plate except at angles above 16° where the predicted lift proved too high.

The data for the three submerged rectangular flat plates having aspect ratios of 1.00, 0.25, and 0.125 were obtained with the plates mounted on a single strut. The mutual interference effects of the flat plates and the strut and the strut tares have been evaluated experimentally and the results are given in Technical Note 3420. The interference effects of the strut on the lifting surface proved negligible at all depths of submergence for drag and at all but the very shallow depths for lift and pitching moment. At the very shallow depths the interference effects caused slight increases in both lift and pitching moment. Strut-tare effects on lift and pitching

moment were negligible at all depths, although strut-tare effects on drag were not. Comparisons of the strut drag with wind-tunnel drag data for the same airfoil section indicate that wind-tunnel data at the proper Reynolds number can be used to estimate section drag of a strut operating in the water at subcavitation speeds. The water-surface-intersection drag coefficients for the strut were approximately constant for Froude numbers above the critical wave speed. Below this critical value, a sharp increase in the coefficient occurred and the value obtained agreed fairly well with the predictions of wave-drag theory.

RESEARCH EQUIPMENT AND TECHNIQUES

Waves are of importance to seaplanes because even relatively mild sea conditions can induce critical loads and uncontrollable motions. The characteristics of seaplanes in rough water are investigated in the Langley tanks by means of self-propelled dynamically similar models having freedom in the vertical plane. The methods used in these investigations are described in Technical Note 3419. The maximum trim, rise, vertical acceleration, and angular acceleration during a number of landings are used as criteria for comparisons. For landings in waves of a given height, the criteria are primarily dependent on wave length. Significant reductions in the motions and accelerations have been obtained by practical increases in hull length-beam ratio, afterbody length, angle of dead rise, and suitable combinations of these features. Vertical loads calculated from experimental contact parameters were found to be in reasonable agreement with the vertical accelerometer data. The mean resistance to motion through waves was found to be higher than the resistance in smooth water.

Document 5-27 (I), Excerpts from Annual Report of the National Advisory Committee for Aeronautics (Washington, DC), 1946-57, "Seaplanes," Annual Report (1956), pp. 37-38.

HYDRODYNAMIC ELEMENTS

Experimental and theoretical research on planing surfaces has been extended to include pressure-distribution surveys for a series of related prismatic planing surfaces having angles of dead rise from 0° to 40° , with and without chine flare. These pressure distributions are presented in Technical Note 3477 for a wide range of wetted length and trim.

The results substantiate the use of the normal-load coefficient as the key parameter in predicting flat-plate center-line pressures. The results further show that flat-plate pressure distributions can be adequately predicted from existing theories. The reduction in pressure accompanying an increase in angle of dead rise is about as expected on the basis of previous force measurements. The addition of horizontal chine flare increases the pressure near the chines and extends the region of positive pressures further forward of the stagnation point in the vicinity of the chines. Existing theories are in poor agreement with the experimental pressure distributions obtained for surfaces having dead rise. The lift and centers of pressure, predicted on the basis of the pressure distributions, are in good agreement with recent experimental and theoretical NACA research on planing surfaces.

Interest has been developing in the operation of water-based aircraft off ramps or beaches where the water depth approaches zero. In view of this, an experimental investigation was made to determine the effect of shallow water on the hydrodynamic characteristics of a flat-bottom planing surface. These data are reported in Technical Note 3642 and show that the lift, drag, and trimming moment about the trailing edge of the model increased as the clearance between the model and the tank bottom decreased. The most apparent increases occurred at clearances below one beam. With combinations of high-wetted length and high trim, however, the values began to increase at somewhat greater clearances. The lift-drag ratio increased with decreasing clearance for wetted length-beam ratios greater than 0.8 and trims less than 16° . The roach in the wake of the model increased in height and moved aft of the model as the clearance decreased.

In the past, seaplane-spray investigations were primarily concerned with the definition and reduction of spray impinging on the seaplane. Recent developments have somewhat altered the spray considerations since modern seaplane designs have closely coupled aerodynamic and hydrodynamic components which are constructed strong enough that considerable forces may be developed on the surfaces by impinging spray. A study of the scale relations for converting model spray-force data to full size is reported in Technical Note 3615. The results show that spray lift forces can be scaled by the conventional Foude relations but that a Reynolds

number effect on spray drag is indicated. An empirical method is suggested for correcting the spray frictional-drag coefficients on a Reynolds number basis.

Results of a preliminary investigation of self-excited vibrations of a single planing surface are reported in Technical Note 3698. Research on vibrations of planing surfaces is of considerable significance in the application of hydro-skis to water-based aircraft, since such vibrations have been known to cause structural damage to the aircraft. This research has indicated that self-excited vibrations occur with high aspect ratio (on the order of 10) of the wetted portion of the planing surface and appear to be essentially an oscillation in trim or rise, or a combination of these motions. The oscillations can be decreased in severity or eliminated by using planing surfaces which limit the wetted aspect ratio. Dead rise, transverse curvature, and a pointed trailing edge are all effective.

In order to provide for flush retraction of hydro-skis on high-speed water-based aircraft, it is sometimes desirable to form these components from portions of the airplane which can be extended for landing and take-off. Since the bottom of these skis will then conform to the shape of the fuselage which is generally rounded or to that of the wing which is more or less flat, the skis also will generally have rounded or flat cross sections. Because of this, an investigation was initiated to determine the characteristics of planing surfaces of several plan forms and transversely curved bottoms. One surface was of rectangular plan form with a flat bottom; the second had a rectangular plan form with transversely curved bottom; and a third surface had a flat bottom but was triangular in plan form. The trims investigated ranged from 4° to 20°. The data were reduced in the form of load, resistance, trimming moment, and draft plotted against wetted area.

RESEARCH EQUIPMENT AND TECHNIQUES

The rapid increase in the landing speeds of current airplanes has caused a corresponding increase in the water speeds at which seaplanes operate. As a result, the gap between the speeds available in the existing hydrodynamic testing facilities and full-scale speeds has widened to an extent sufficient to make it advisable to ascertain whether these differences in speed are causing any significant differences in force coefficients. In an attempt to close this gap, an investigation has been made of the feasibility of obtaining hydrodynamic data at full-scale speeds by utilizing a rectangular 3- by 3¼-inch free-water jet actuated by compressed air. A comparison of planing data obtained in the water jet with similar data obtained in conventional towing tanks indicates that it is feasible to use a free-water jet as a hydrodynamic test facility for obtaining planing data at very high speeds. The main problem appears to be in establishing an adequate method of correcting the jet data for the limited boundaries. Consideration has been given to a simple empirical method of correcting planing data for the jet boundaries. This method gave reasonable results for the limited data available.

*Document 5-27 (m), Excerpts from Annual Report
of the National Advisory Committee for Aeronautics
(Washington, DC), 1946–57, “Seaplanes,” Annual Report (1957), pp. 24–25.*

Recent NACA research in exploring and applying advanced aerodynamic and hydrodynamic concepts has opened the way for achieving markedly higher-speeds [*sic*] with new seaplane designs not having the performance compromises presently associated with water-based aircraft. Following the trend of high performance land-based aircraft, however, these advanced seaplane types would have higher takeoff and landing speeds than present day seaplanes. For instance some of the configurations may have takeoff speeds as high as 200 knots. Consequently, a major part of the NACA's hydrodynamic research during the past year has been directed at studying hydrodynamic surfaces and seaplane configurations at higher speeds than before in order to investigate not only hydrodynamic performance but also other important factors such as spray and water flow characteristics, airplane stability and control on the water, and water loads on the seaplanes operating in various wave conditions. These latter characteristics are often difficult or impossible to predict based on present experience, as the new advanced configurations are in many respects considerably different from present day seaplanes. It is encouraging that in the NACA hydrodynamic tests some types of hull forms and hydroski and hydrofoil gears have shown real promise for coping with the severe water loads at the high landing and takeoff speeds, although a large amount of additional research is needed to assess and solve the loads problems.

HIGH-SPEED HYDRODYNAMIC FACILITIES

A new hydrodynamic tank facility (see accompanying photo [*not reproduced*]) has been placed in operation at Langley this year and has a speed capability of 170 feet per second and a planned future capability of 200 feet per second. In the first investigation in the facility it was determined that the lift coefficient of a flat bottom planing surface at various operating conditions was essentially constant throughout the speed range from 80 to 170 feet per second. The experimental results agreed well with those obtained in the larger Langley tanks having lower speed capabilities as well as those obtained in a small high-speed water jet. A better understanding has also been achieved of the proper jet boundary corrections to apply to data obtained in the latter facility.

PLANING SURFACE THEORY

Better theories have been needed to correlate the vast amount of experimental data on lift of submerged and planing hydrodynamic surfaces and to provide better tools for guiding future research and seaplane design. Advances have been made in

this regard during the past year and work has progressed on several fundamental programs dealing with basic hydrodynamic lifting elements such as hull bottoms, hydroskis and hydrofoils. In one example a general nonlinear theory was established for calculating the forces and moments on planing surfaces of various shapes and planforms. Previous theory considered only the linear component of the suction lift and was limited mainly to rectangular surfaces. Special experiments have been conducted in the Langley tank No. 2 to verify the new theory.

HYDROSKI AND HYDROFOIL LANDING GEARS

The ability of hydroskis and hydrofoils to alleviate the motions and loads of seaplanes operating on rough water has spurred additional research on such devices for landing gears. There are still many unknowns concerning optimum shapes and planforms for hydroskis and attention has been given during the past year to effects of bottom and upper-surface curvature on the ski characteristics during operation at various submerged and planing conditions. Also in multiski arrangements the interference effects of multiple wakes have been explored. Some shapes with particular structural and retraction advantages have been incorporated in the program. Skis often produce violent spray at emergence and one experiment has been aimed at investigating the effect of ski nose shape on spray. Submerged lifting surfaces at certain operating conditions near the water surface incur air ventilation on their upper surfaces with large losses in lift and lift/drag efficiency. Experimental investigations have provided a better understanding of the nature of these flow changes, the effect of model size on the phenomenon, and the operating conditions at which the ventilated flow can be expected to occur.

SUPERCAVITATING HYDROFOILS

Normal hydrofoils intended for efficient operation at low speeds develop cavitated flow at moderate water speeds with attendant serious losses in lift and lift/drag efficiency. By designing hydrofoils purposely to operate in cavitated flow, however, good lift and drag properties can be achieved at the higher water speeds. These so-called "supercavitating" hydrofoils offer considerable promise for high-speed seaplanes not only in providing efficient landing gears from a lift and drag standpoint but also in alleviating the severe seaplane motions and overall loads at high speeds in rough water. In the past year refinements have been made in the theory for designing the shapes of such hydrofoils. Several supercavitating hydrofoil configurations have been tested in the Langley Tank No. 2 and the tests will be extended to speeds [of] up to 200 feet per second in the new high-speed hydrodynamic facility.

Document 5-28 (a–b)

**Selections from John W. R. Taylor and Maurice F. Allward,
Wings for Tomorrow (London: Ian Allan Ltd., 1951).**

(a) Rt. Hon. The Lord Brabazon of Tara, “Foreword,” pp. 3–4.

(b) “Wings for Tomorrow,” pp. 97–104.

Flying boat development was not just an American phenomenon; it was international from the start. It is erroneous even to suggest that the United States led the way in this field. The biggest users of commercial seaplanes and flying boats were France and Italy, which both had a number of Mediterranean and Adriatic routes to service. Germany utilized a number of marine aircraft in the Baltic and on coastal resort services to places like Naples, Venice, Tripoli, and Haifa. It also built one extremely large flying boat, the DO-X, to cross the Atlantic; at over 123,000 pounds gross weight, it was in fact the largest aircraft ever constructed up to that time. Designed by Dr. Claude Dornier and constructed at Altenrein, Switzerland, on Lake Constance and near Friedrichshafen, Germany, the 12-engine DO-X could accommodate 66 passengers comfortably over a range of 700 to 900 miles, but it could not lift any kind of payload over transatlantic distances, the minimum such distance being roughly 2,000 miles. Two other countries that built and operated flying boats were the Soviet Union and Japan. Greater Japan Airlines used the impressive Kawanishi H6K flying boats in the 1930s to fly among the home islands and to connect them with vital port cities on the Asian mainland. Japan built 167 Kawanishis during World War II, aircraft that saw heavy duty in transport and antisubmarine work.

The country with the most compelling reason to specialize in the construction and operation of flying boats, however, was Great Britain. The British had a greater need for them because their far-flung empire included remote and forbidding terrain, far from the home island, where it was difficult to build airfields but where rivers, lakes, and harbors were abundant. In the 1930s, as landplanes became larger and heavier, but still with few airfields capable of handling them, the British flying boat enjoyed particular success. With a fleet of C-class flying boats built by Short Brothers, Imperial Airways handled the Empire Air Mail Programme and moved passengers in comfort and style from London to South Africa, Egypt, and India and on to Singapore, Hong Kong, and Australia.

Great Britain did not give up on the flying boat after World War II. Late in the war, J. T. C. Moore-Brabazon, Lord Brabazon of Tara, who in 1908 had been the first Briton to fly, chaired a special committee that was to advise the British government on postwar aircraft development policy. The Brabazon Committee recommended

pushing ahead not only with large landplanes that could fly across the Atlantic nonstop but also transatlantic flying boats with large passenger and cargo capacity. The two aircraft endorsed for this mission were the Bristol Aeroplane Company's Type 167, later named the Brabazon in honor of Lord Brabazon, and the Saunders-Roe SR.45 Princess Flying Boat. The British government's idea was for these two aircraft together to capture a sizeable part of the expected postwar international air travel business, thereby reestablishing a strong position for the British aircraft industry in the European and world markets for commercial aviation.

Although the Brabazon story is itself illuminating (the airplane never got beyond some major technical problems and flew only as a prototype), the focus here is on the Saunders-Roe SR.45 Princess. At 330,000 pounds, this gigantic flying boat, which first flew in August 1952, outweighed by 20 tons the Bristol Brabazon, which itself was Britain's biggest landplane. (The Princess was nearly as large as Howard Hughes's famous albatross of a flying boat, the H-4 Hercules of 1947, better known as the "Spruce Goose"—which weighed 360,000 pounds [20 tons] at takeoff.) Construction of three of these large flying boats was started, but only one was completed and flown. One of most innovative design features of the Princess was a type of double hull, with one on top of another, known as the "double bubble." The British Overseas Airways Corporation (BOAC) planned to use the Princess flying boats for luxury service on transatlantic routes between England and New York. But severe technical problems with the gearboxes and contrarotating propellers for its 10 3,780-horsepower Bristol Proteus engines so escalated development that production costs doomed the Princess. A cost-conscious British government backed away from the project, as did BOAC. By the time the aircraft flew in the summer of 1952, it had no future. Nor did two other Saunders-Roe projects. One of these, the Duchess, was a passenger flying boat to be powered by four jet engines. The other was a 1,000-passenger, five-deck flying boat powered by 24 jet engines; it would fly nonstop between England and Australia.

Below are two sections taken from the 1951 British publication *Wings for Tomorrow*. The first is the foreword to the book, written by Lord Brabazon, who argues that the era of the flying boat is far from over and that it was the destiny of Great Britain, a maritime nation, to bring the flying boat back into predominance. The second reproduces chapter 11, itself called "Wings for Tomorrow." In it, authors John W. R. Taylor and Maurice F. Allward condemn BOAC and the British Ministry of Civil Aviation for failing to further support flying-boat development and withdrawing flying-boat service from British commercial aviation. Taylor, Allward, and Lord Brabazon would have been even more distressed about this state of affairs if they had known that, in just a few months, support for the Saunders-Roe Princess would also be discontinued. Rather than the rebirth of British flying boats, the fate of the Princess signified its near total demise.

It would take a few more years before the very last British flying boat was taken out of service (Aquila Airways did this in September 1958 when it stopped flying

the C-class Solent to the Madeira Islands), but the end of the story was actually written six years earlier, with the failure of the Princess.

In truth, it was World War II that killed the flying boat, no matter how useful those boats had been in the war itself. Not only did the war witness the decline of the British empire and the destruction of Japanese power and the German Reich, but the vast requirements of fighting a war around the world also stimulated the construction, mostly by the United States, of a worldwide network of airfields with long, hard-surface runways as well as connecting and supporting airways, navigation aids, and communications facilities. In addition, wartime demands accelerated the development and production of a number of large, long-range, four-engine American aircraft with better engines and new airborne communications, navigation, and radar systems. As a result, the need for the flying boat disappeared.

Document 5-28 (a), Selections from John W. R. Taylor and Maurice F. Allward, Wings for Tomorrow (London: Ian Allan Ltd., 1951), Rt. Hon. The Lord Brabazon of Tara, "Foreword," pp. 3-4.

Speaking on behalf of the great Brabazon Committee, I have always felt a little guilty that we did not see our way to recommend the building of new "Boats". I have also been surprised, considering the popularity of flying boats, that the Committee was not vigorously attacked for its sins of omission.

The facts are, however, that we did all we could, but our terms of reference were to express "Users' Requirements" as to future types, and at the time we could not get those in charge of the operation of fleets of aircraft to demand them. I thought then it was a mistake; I am sure of it now.

Praise be given, therefore, to the Ministry of Supply, in having the imagination and faith in this type to have ordered the Princess.

In this very readable book, the birth of the flying boat, its development and how we reached the acme of superiority over all others in the Short production, of a four-engined all-metal boat, is told in a vivid and very attractive way.

And then the tragedy, how operators, for the moment, have forsaken them.

It will not be thus for long. We await with anxiety the first flights and commercial use of the great Princess.

Chapter 9 covers the reason "Why" Flying Boats. It is worth getting the book to read that chapter alone, and I indeed am a believer, more and more, in the very big machine.

Maritime nation as we are, I and others resent when travelling in aeroplanes, being packed like sardines or skippers, for hours at a time, surprised that there is no one strap-hanging!

Apart from the very real increase of safety in "boats" over water, there is the question of comfort. People will pay for it as they do when travelling to America in the *Queens*, rather than in other ships, and thus "boats" will come back for economic reasons, the only thing that can move the hard-headed operators.

The extra comfort of the very big flying boat is very much more than the difference between the comfort of a 10,000 ton boat and a *Queen*.

Even the old "boats," such as the Solent type that girdled the world, held the affection of all passengers in spite of superior performances by land machines.

So in the future, as machines get bigger and bigger, as indeed they must, so for many reasons so well explained in this book, will the "boat" come into its own again, and remain predominant.

The sooner the better, but until that time comes, from this attractive volume learn of the past and dream of the future.

*Document 5-28 (b), Selections from John W. R. Taylor
and Maurice F. Allward, Wings for Tomorrow
(London: Ian Allan Ltd., 1951), "Wings for Tomorrow," pp. 97-104.*

The withdrawal of B.O.A.C.'s Solent service to South Africa marks the closing of a chapter in the story of British flying boat operation. And now, what of tomorrow? Is the experience of the past to be used in the development of even better flying boats, or is it to form the basis of an obituary?

Whilst believing and hoping for the former, it is useless to deny that the immediate future for the British flying boat industry is black. Only two types—the Short Sealand and Saunders-Roe Princess—are in production. Not a single prototype, either civil or military, is being built, and only one new civil 'boat—the Saunders-Roe Duchess—is projected. Flying boat development is, in fact, almost at a standstill despite the great part these craft have played in building up our civil air routes and in helping to beat down the submarine menace in two World Wars.

Much of the blame for this sorry state of affairs must be laid at the door of B.O.A.C. and the Ministry of Civil Aviation, for a decision such as that of B.O.A.C.'s to withdraw all its flying boats can only have the most serious repercussions.

Nor does the Minister of Civil Aviation improve matters with such statements as the one in which he expressed his "complete confidence in the commercial judgment of B.O.A.C.," adding that he was not aware of any national consideration which would lead him to request the Corporation to reconsider its decision.

Continuity of operating experience—what the Americans appropriately call "know-how"—is at least as important as merely knowing how to build good aircraft, and the retention of Solents on the South African route solely to maintain our "know-how" of flying boat operation might well have proved to be in the national interest.

We have already had one experience of the serious consequences of foregoing this continuity. During the war Great Britain concentrated on the production of fighters and bombers, and relied on America for virtually all the transport aircraft that she needed. As a result, when the war ended we had no efficient, modern transport in production. Realising that we could never hope to catch up on American "know-how" in the operation of large piston-engined air liners, we decided to concentrate on developing jet-engined air liners instead, in the hope that we might establish a lead in this class of aircraft. It was a brave decision and one that has paid handsome dividends in the shape of such magnificent machines as the Comet and Viscount, but it meant that during the vital post-war period of re-building its civil air network, B.O.A.C. has had to rely largely on American equipment, bought with millions of precious dollars.

If we forget this lesson, B.O.A.C.'s present indifference to the flying boat may well mean that we shall lose our traditional lead in this type of aircraft, which must become of ever-increasing importance in the future of air travel. Worse, it may mean that at a time when they are most needed, we shall not have the military

flying boats which alone could seek out and destroy an underwater enemy, for we have seen through this book that civil and military development have always gone hand in hand.

B.O.A.C.'s action will have repercussions far beyond these shores too, for it is not sufficient that a few overseas airlines still have enough faith in the qualities of British flying boats to use them on their most important services. The vast majority of the others are bound to be influenced by B.O.A.C.'s decision to abandon them as uneconomical, rather than by the satisfactory results achieved by the faithful few. The importance of this should not be under-estimated, bearing in mind that the first British aircraft bought by America since the war was an amphibian flying boat—a Short Sealand.

The pity of it all is that, by making suitable economies, there is little doubt that the Solents could have been operated economically, despite the handicap of being the only 'boats operating to South Africa. If B.O.A.C. itself does not feel inclined to take the risk, there is little justification for the official "dog in the manger" attitude towards privately-owned Aquila Airways, who are quite prepared to do so, with the Solents which B.O.A.C. have discarded!

Anyway, would it be a risk? Aquila's Managing Director, Barry T. Aikman, thinks not, and it is significant that in 1948, of B.O.A.C. and its many allied airlines, one and only one was run at a profit—Tasman Empire Airways, *the only one using flying boats exclusively*, although in fairness it must be admitted that their trans-Tasman route is ideal for flying boats as it has no intermediate ports of call.

B.O.A.C.'s action, in conjunction with the Ministry of Civil Aviation's negative attitude, might well be responsible for "killing" a type of aircraft which is undoubtedly extremely popular, and for which there will be an increasing need in the future. That such a situation should arise under a Socialist Government is even more surprising, because it is one that a super-planned economy was surely intended to avoid.

Looking ahead slightly, the picture brightens as the Princesses come into service. But before this is hailed as the rebirth of British flying boats, it is well to remember that only three are being built. Such a small fleet is obviously insufficient to enable them to make either the reputation or the profit they are so capable of making.

A pertinent question is whether it would not be worth while to spend the extra £5 million required to complete a proposed fleet of seven, and so give the Princesses a much better chance of succeeding and paying the country handsome dividends. Such a step could establish British supremacy on world air routes as never before, *at a total additional constructional cost of 2s per head of our population*. What British man or woman would not be prepared to risk their "two bob" for such a prize?

Unofficial suggestions for possible routes for the Princess have not been particularly inspiring. To use them, for example, to supplement the Atlantic landplane services during the summer rush is as imaginative as using the *Queen Elizabeth* and *Queen Mary* to augment the cross-channel services, or reserving Pullman railway coaches for Derby Day.

As the only air liner in the world, with the possible exception of the Brabazon, capable of operating a 3,500 mile stage under all conditions, and as one of our greatest engineering feats, the Princess is worthy of something better.

In this respect, the tragic death of Air Commodore Brackley was a particularly sad blow for the Princesses. They were very close indeed to his heart and it is a great pity that his inspiring and energetic guidance will not be available to help make them the success we all hope they will be.

Let us take a look at a few of the major British air routes radiating from London to centres of the Commonwealth and South America:

U.K.—Montreal—Vancouver—Honolulu—Fiji—Sydney or New Zealand.

U.K.—Bermuda—Jamaica—Clipperton—Christmas Island—Fiji—Australia or New Zealand.

U.K.—Lagos—Johannesburg—Cocos—Sydney.

U.K.—Alexandria—Karachi—Singapore—Darwin—Sydney (with branch from Singapore to Far East).

U.K.—Bathurst—Rio de Janeiro—Buenos Aires.

Each of these routes involves a stage of over 3,000 miles and *every one is suitable for operation by the Princess*. The only limitation is imposed by ice at Montreal during the winter, and for this period the service would have to be diverted south. Such a network would be of immense benefit to the widely-dispersed Commonwealth, and, used in this way, the Princesses would be the *Queens* of the air, repeating, or even enhancing the magnificent success of the old Empire 'boats.

To follow the Princess, if all goes well, we may expect the Saunders-Roe Duchess which, with a designed gross weight of 130,000 lb. and a span of 135 ft. 6 in., will be something quite new in flying boat design. Incorporating the most advanced aerodynamic and hydrodynamic features, it holds promise of doing for British marine aircraft what the Comet has done for our land-based air liners.

Design drawings show six de Havilland Ghost pure-jet engines installed in a manner similar to that adopted for the Comet, in gracefully swept wings. The hull will have a high length-to-beam ratio, with a full-length planing bottom, far in advance of that used by any flying boat now flying. Lateral stabilising floats are designed to retract to the wing tips. The interior layout can be arranged to suit the individual requirements of operators. One has been schemed for the accommodation of seventy-four passengers in two large cabins, each with its own toilet compartment, connected by a gangway passing the freight hold. Stowage space of

some 600 cubic feet would be provided, sufficient for 66 pounds of luggage for each passenger and about 3,500 pounds of freight.

The Duchess is under consideration by Tasman Empire Airways, Limited, for use on journeys such as the 1,300 mile route between Auckland, New Zealand, and Sydney, Australia. Tasman already have achieved the distinction not only of making a profit, but of doing so with one of the lowest fare rates in the world. Their interest in the Duchess shows that they intend to continue on these lines, because it promises to be the most economical medium-range aircraft yet designed. For stage lengths between 1,300 and 1,500 miles fares are estimated at just over a penny per passenger mile, and for stages of 2,000 miles two-pence. The maximum payload over 1,300 miles should be 21,000 lb. and the cruising speed over 500 m.p.h.

Owing to the abundance throughout the world of scattered islands well served with sheltered coves, rivers, and inland lakes, a future should also be assured for at least a few amphibians in the class of the Short Sealand or Supermarine Seagull. Although the wheels reduce the payload and complicate maintenance, they do enable the craft to operate also from any suitable stretch of level ground and, perhaps even more important, often allow them to be driven ashore for loading and unloading of passengers and freight, thus eliminating the need for a service launch. Amphibians are thus ideal for use in the less developed parts of the world, where aircraft are required to operate with a minimum of facilities and equipment.

On the military side, the unsettled world situation more or less assures a future for marine aircraft, for, as we have already seen in an earlier chapter, if our defences are going to be effective, we simply cannot afford to be without them. We must not assume, because America is developing two fine modern anti-submarine patrol boats, one of them powered by eight propjets, that these would be available to the R.A.F. in an emergency.

Military necessity then, should ensure the appearance soon of a long-range anti-submarine patrol boat to replace the now-ageing Sunderland. One is certainly long overdue.

It is almost certain that advanced types of supersonic flying boat fighters will follow. But first we must have this all-important Sunderland replacement.

We have already explained that without military flying boats there will probably not be the money to build civil flying boats. The staggering financial outlay required to develop a large modern aircraft is such that, in the unsettled state of our national finances, a close interlocking between civil and military types will be essential in future. Refinements made on military craft often have civil applications, and by careful planning this principle could be expanded. It has certainly paid dividends in the past.

Looking ahead farther than the Duchess, say into the nineteen sixties, the outlook for the flying boat brightens immeasurably. Although there are powerful arguments against very big aircraft—two of the most important being the major personal catastrophe and large capital loss that would result from an accident—if aviation is ever to be available to the men and women in the street, then aircraft bigger than those in current operation will be essential, for the reasons put forward in Chapter 9.

If these bigger machines are to be landplanes, then many, if not all, of the world's airfields will need to be strengthened and lengthened, or new ones constructed. Some Governments would probably be willing to undertake such work, assuming they could meet the enormous expense involved, if they could be assured that it would solve the problem finally, or at least for a very long time. But the indications are that the demand will continue to grow faster than it can be satisfied.

Another factor of growing importance as the population of the world increases is the vast amount of land required by a modern air terminal. Hundreds of houses are being demolished to make way for London Airport which, when finally completed, will cover about 4,600 acres of farming land—land that could produce enough grain for three-quarters of a million loaves of bread, sufficient to supply over 70,000 people for a year! Few conscientious governments are likely to sacrifice such tracts of land when a cheaper alternative is available, by transforming existing stretches of water into marine bases.

In those few cases where it is imperative that the airport is within a stone's throw of the town or city concerned, a little planning might enable nearby water reservoirs to be adapted for flying boats relatively cheaply.

An example of such foresight was given by the Government of Southern Rhodesia when it allocated £1,000,000 for the construction of an irrigation dam near Salisbury, the capital, which would at the same time form an ideal flying boat base. Withdrawal of the B.O.A.C. Solents now means that Rhodesia has to provide a further large sum of money to lay down runways and erect airport buildings, for, in the words of her Minister of Commerce, "someone else's Constellations to use."

Here in Britain a little foresight and imagination might have enabled a somewhat similar project to materialise near London, for Parliament has already approved the construction of a vast new water reservoir at Wraysbury, as part of the programme to improve the capital's water supply. It will be sited less than a mile from the two big existing reservoirs at Staines; and there seems little reason why these three reservoirs should not have been joined and then enlarged to accommodate the storage capacity of other new ones scheduled to be built at Walton-on-Thames and Datchet. The result would have been an inland lake measuring about three miles by three miles, which, in addition to safe-guarding London's water, could have doubled as her marine base.

In less fortunate areas, where a completely new artificial lagoon might have to be built, the cost, including terminal buildings, slipways, hangars, and workshops,

has been estimated at about £5,000,000. The cost of a comparable airport for landplanes would be nearer £25,000,000. But such constructional work should rarely be necessary as most world capitals are in close proximity to water.

Despite the attractions of a marine base nearer London, there seems little reason why Southampton Water should not continue as her marine airport. Ever since Roman galleys came sweeping up to Southampton 2,000 years ago it has served as England's port of entry. Sail succeeded the primitive craft of early history; steam succeeded sail. Liner passengers have not grumbled unduly at its one hour train "distance" from London and there is little reason why the majority of air travellers should find it inconvenient. From the financial viewpoint, continued use of Southampton has every advantage.

So far, we have concerned ourselves largely with the future of passenger-carrying civil aircraft. But we should not forget that most other forms of transport, by rail, road, and sea, derive the greater part of their revenue from the carriage of freight. Many financial experts believe that air travel will never begin to pay its way until it does the same.

Centuries of progress in surface travel have built up a network of roads, railways and shipping lanes which converge at docks. If the carriage of freight by air ever assumes an importance equal to that enjoyed by the other forms of transport, then aircraft too will have to make use of existing dock facilities in most cases. Huge specialised aerial freighters weighing hundreds of tons will be required, and even the most fanatical proponent of landplanes will have to admit that if such aircraft are to be built, they can only be flying boats.

It is extremely unlikely that any manufacturers are seriously considering the possibilities of land machines much larger than the 130-ton Bristol Brabazon or the mighty B.36 bomber. But serious thought is already being given to the possibilities of flying boats weighing as much as 500 tons and able to carry 500 to 1,000 passengers. Such projects stagger the imagination and yet are based on sound, logical lines.

Although there is no reason why flying boats of orthodox layout should not be built far bigger than the Princess, the use of twin hulls appears to have many advantages for aircraft of extreme size. In the air, division of the mighty wing into three portions would help alleviate what the technicians call the "gust case." On the water it would be inherently stable and wing tip stabilising floats would not be required. The four walls of the hulls would enable a greater number of people to have window seats and the center section of the wing would afford a wonderful opportunity for a promenade deck.

Furthermore, should the need arise, and all connected with aviation fervently hope that it never will, an aerial leviathan of this type would have an important military application, in the establishment of bridgeheads on an enemy held coastline, for the twin bows could be driven right up to the shore to disgorge men and materials.

But none of these dreams of the future will materialise unless certain provisions are made *now*. Although we have shown that flying boats can operate with primitive, makeshift equipment and with a ground organisation that would be totally inadequate for landplanes, they should not have to do so in future. By comparison with modern land airliners, they need very little, but this "little" is essential to any sort of reasonable operation.

To do the job properly, the most attractive proposition would be a combined floating traffic pontoon and graving dock with hangar covering. A design study for such a unit has been prepared by Saunders-Roe and is completely self-contained to cover all the operational requirements for traffic purposes, routine and major maintenance and for dry docking when required. The cost will be small in relation to the operational and maintenance time and money which will be saved by the facilities provided. Two such units could be arranged either side of a pier-head with a central unit containing stores, toilets, telephones, customs and personnel accommodation.

These bases will not materialise by themselves, and are beyond the means of private enterprise. The State should, therefore, undertake some initial planning and constructional work now. The initiative and the money required must be found to start work on bases capable of handling the Princesses and the far bigger 'boats that will follow.

Our present world superiority in air liner design must be maintained and extended, but this is only possible if we give the flying boat its proper place in our long-term planning. With courage and foresight today, we can ensure that, in twenty years['] time, British leadership in aviation will be as traditional as our command of the seas. We must not let so great a prize slip through our fingers.

Document 5-29 (a–e)

- (a) Anders J. Christenson, FAA Pilot Examiner,
“Observations of a Seaplane Pilot Examiner,”
<http://www.oocities.org/gronkm/fly1/seaplane.html>.
- (b) “Kenmore Air—A Unique Airline; ‘An Experience You’ll Never Forget,’” <https://web.archive.org/web/20001026085716/http://www.kenmoreair.com/seaplanes.html>.
- (c) “Seawinds,” <http://www.seawind.net>, copy in NASA HRC.
- (d) “SeaAirNY,” <https://web.archive.org/web/20001001025732/http://seairny.com/>, copy in NASA HRC.
- (e) “Seawolf: Multi-Mission Amphibian,”
<http://www.seawolfamphib.com>, copy in NASA HRC.

If one thinks that seaplanes are a thing of the past, all one need to do to correct that mistaken view is sit down at a computer, access the Internet, and see how many “hits” appear from searches of words related to seaplanes. Some of these sites involve historical material, but most concern charter flights and tours being offered in various places where lakes and other bodies of water abound, such as the Great Northwest, Alaska, Canada, the Florida Keys and Caribbean, and Scandinavia. Bush pilots fly amphibious aircraft of various types to take in fishermen, hunters, and tourists to exact spots in remote areas where conventional aircraft cannot land. But several of the hits involve Web sites set up by firms that are manufacturing seaplanes of various kinds, and not just of old designs.

This is not a new, post-1945 development, of course. Flying boats, float planes, and other types of amphibious aircraft were used for sport, pleasure, and personal transportation from the very start of aviation. As early as 1913, private individuals bought versions of the Curtiss F boat for their own use, and as we saw back in Document 5-18, the Loening “air yacht” of the early 1920s found a number of buyers for personal and commuter airline use. Through the 1920s and 1930s, a number of small seaplanes were developed in the United States and abroad for general aviation uses. The most noteworthy American utility amphibians of the era were the Douglas Dolphin twin-engine of 1930; the Grumman model G-21 Goose twin-engine of 1937; and the Fleetwings model F-5 Sea Bird four-place single-engine, also of 1937. Of these three, the Grumman Goose was the most aerodynamically efficient, able to achieve a speed of slightly over 200 mph, with good lift (20.5 L/D

ratio) and relatively low drag (0.0325 zero-lift drag coefficient). Not only was the Goose used by private owners, airlines, and charter operators, but the U.S. Navy also made extensive use of it. It is still used today by a few short-haul airlines.

The following documents taken from the Internet in October 2000 (with Web site addresses updated in December 2011) reflect the range of seaplane activities taking place at this end of the century. They show how passion for flying in, from, and above water is still strong. What the enthusiasm of these documents does not indicate is the reality that if large flying boats are ever again to see a heyday, engineers will somehow have to solve the one major problem that plagued these hybrid aircraft during their golden age prior to 1945: somehow, the machine must integrate acceptable hydrodynamic characteristics while still being as efficient overall, and as cost-effective, as a comparable landplane.

*Document 5-29 (a), Anders J. Christenson, FAA Pilot Examiner,
"Observations of a Seaplane Pilot Examiner."*

What's so tough about flying boats? That is one of the questions I might ask an applicant during the oral phase of their seaplane check ride. Over the years that I have been an examiner for seaplane ratings, I've asked myself that question from time to time. There are some cold facts that say that piloting a seaplane safely can be an exacting thing. What is it then that causes the risk to be so high in an otherwise most enjoyable flight experience of power pilots?



I think a great deal of the problem lies right there. It is so much fun. It comes the closest to what we thought flying was going to be before we learned that it is filled with regulations, traffic patterns, radio navigation, etc., and a much greater reliance than we thought on other people in the aviation picture. It comes the closest to flying as it was in the barn-

storming era. It is just this feeling that causes otherwise excellent pilots to do things in a floatplane that they would never think of doing in a landplane. Let me cite a very common example. A land plane pilot, when approaching for a landing at an airport, will very likely circle the airport above pattern altitude, then enter a downwind leg at a safe altitude, keep a safe altitude and have a reasonable distance on final approach. Put this same pilot in a seaplane and he very commonly will disregard downwind altitudes and final approach leg distances. I would like to see him



use his imagination. I would like to see him decide where he wishes to touch down on the water and then imagine a 75-foot wide runway beginning 300 feet before that point and extending for 2,000 feet beyond it. I want him to imagine an airport right there on the lake—then treat it like one—have the normal down-

wind, base and final legs. If we take all of our safety procedures that have been so well trained into us and use them in our seaplane flying, we will have a much better safety record.

I mentioned imagination. That is difficult to have with minimum experience. However, that is one of the items training should develop. Along that line I might ask the applicant how short a lake they would choose to land on, assuming there was no emergency. After considerable thought they will very likely say “about a half mile”. Then I ask him how much lake they would like to have in front of them for take off. The answer, quite commonly, I’m pleased to quote, is “one mile”. My only concern then, since the problem was no emergency one, is why they would land on a lake whose length was not sufficient for take-off. How long should a lake be for landing? The Minnesota Department of Aeronautics requires one mile of effective lake with a one to ten approach slope for the licensing of a seaplane base. Assuming normally a fifty-foot bank with fifty-foot trees surrounding the lake, this means that we need a little over a mile. How can we tell, before landing, if we have the distance? A good method is to fly the long length of the lake as much downwind as possible at an airspeed of 90 MPH. If the time is 45 seconds or more, you should have adequate room for take off.

So far in my discussion you have very likely seen my hint at the first big rule in float flying. It’s the same as in land plane flying—DON’T HURRY! It starts with preflighting the aircraft and floats. You must remember that once you’ve committed yourself to start the engine, you must have everything completed. That includes not only a thorough preflight of your equipment using a checklist, but also just where the aircraft is going to go once the engine is started. Remember that movement is immediate. Don’t hurry. Think over things such as wind, other planes, boats, people, etc.



Prospective seaplane pilots are always amazed that water spray can seriously damage a propeller. I have seen a perfectly good propeller ruined beyond repair in just 15 minutes of improper handling. But even more important and serious is the number of seaplanes that have capsized due to the same improper techniques. Both conditions can be avoided if the second rule is put into practice. NEVER EXCEED 1,000 RPM unless you wish to STEP TAXI, STEP TURN or TAKE OFF. In other words, the only time you should go above 1,000 RPM is when you want to go to full power.

There is some misunderstanding about the effective use of ailerons while idle taxiing. I see people terribly concerned with up ailerons and down ailerons. I always remember to think about only of [*sic*] down ailerons. That cuts my remembering



problem by one-half. The down aileron is deflected much farther from the horizontal plane than is the up aileron. It may not look that way but just try it. Turn your control wheel until the underside of the aileron is parallel to the surface of the lake and just see how far up it is from neutral. You very likely remember your flight instructors stressing the importance of aileron and elevator positions during windy days while taxiing on the airport. The elevator, however, should normally be held in the up position.

Here is just one more word about that second big rule—the 1,000 RPM limit. It is the combination of excess speed and power while attempting to taxi in a quartering tailwind situation that sets up the classic capsizing problem. If you limit yourself to the 1,000 RPM rule, the plane will weathercock before you can get into a capsizing situation. Unless there is a gale blowing, the airplane will not capsize while pointing into the wind. So, if you are taxiing along with a quartering tailwind and find that you are no longer able to hold your bearing, that is, you are starting to weathercock—close your power—let it head into the wind and then make other plans. Your plans will not have to be “How do I get out of this cockpit while I’m upside down?”

Sometimes during the flight test I ask the applicant to shut down the engine and sail to a predetermined spot such as a buoy, dock, or beach. Not uncommonly I see a great deal of insecurity at this point. The flaps come down and the rudder is pushed and the ailerons are whipped up and down. Let’s think a moment about what we are trying to do. We are merely trying, to the best of the aircraft’s capabilities, to change our sailing direction from straight downwind to either side. Let’s just prove that the down aileron position is an effective sail area. With the engine shut down and water rudders and flaps up, neutralize the air rudder—put both feet on the floor, then turn the control wheel or stick to the right. You will notice that the left aileron is down and that the left wing will move back. That is the way it should

be when you sail to the right. Then try it to the left—the right aileron comes down and the right wing goes back. That is the way it should be when you want to sail to the left. Then with the wheel to the left—push your right rudder and see the nose move farther to the right. Now you have the combination for sailing. The way I remember to sail, when the going gets grim, is **TURN THE WHEEL OR MOVE THE STICK IN THE DIRECTION YOU WISH TO SAIL AND PUSH THE OTHER RUDDER**, and then have faith. It is much easier for me to remember it that way from one float season to another than to remember such things as “Point the tail where you want to go” or “When you want to sail to the left, push the right rudder and use the opposite aileron.”

Some manuals mention the use of flaps in aiding your sailing. Think about it. Flaps provide more surface for the wind to act on resulting in more added speed. Since *both* flaps must be lowered, the flap on the upwind side is providing more drag—just what we don’t want. In addition to that, remember the rudder and ailerons are much more responsive when the airplane’s speed is the slowest in relation to the wind’s speed. It naturally follows then that by lowering the flaps we are taking away exactly what we want—controllability. I also find it extremely difficult to see where I’m sailing when some of those big flaps are lowered. However if I wish only to sail directly backward in the swiftest manner possible, I will lower the flaps and open the doors. If I wish to sail using my power I certainly will use the flaps and even open the doors to control my movement over the water. Whenever you have a problem coming up that will require sailing, think it over very carefully, considering the wind, as it will affect your aircraft. If the problem is a grim one, mentally prepare yourself either to start the engine or get a little wet in making the aircraft go where you want it. A good float plane pilot puts his aircraft’s safety ahead of his own comfort.

The third big rule to remember is **ALWAYS HAVE MINIMUM RPM AND WATER SPEED WHEN TURNING, INTENTIONALLY OR UNINTENTIONALLY, INTO THE WIND**. This rule is no less important than the other two. It is often broken with dire consequences. There are so many circumstances that the pilot can get into where he does not recognize that the rule is being broken. Quite commonly, when I have asked the applicant to show me a *left cross wind landing*, I will ask him, while we are on final approach, “If I were to ask you to stay on the step after this landing and make a turn—which way would you turn—left or right?” When centrifugal force and wind force point in the same direction, a powerful capsizing force goes to work. Yet this kind of accident happens. It happens also when taxiing downwind with a quartering tailwind—the pilot attempts to hold a bearing by increasing his power—over 1,000 RPM—the wind is too much—the plane begins to weathercock (this is an unintentional turn but a turn never the less) into the wind. The powerful capsizing force is at work and power must be reduced. Remember, anytime a turn, intentional or unintentional, is

happening—when the airplane is turning into the wind, no matter how slight the turn, *no power* and *minimum* water speed are the order of the day.

I have been in many bull sessions when the discussion turns to the previous rule. The comment always arises, “If the wind is light, isn’t it safe to make such a turn?” My only response is, “What do you think is a light wind?” I’ve had answers ranging all the way from one knot to eight knots. It is one of the variables that, if ignored, forces the new seaplane pilot to make a decision based on experience—experience that he really doesn’t have. I’ve seen an eight-knot wind on one of our local lakes churn the water surface to prominent white caps and two-foot troughs. I have seen fifteen-knot winds barely make a three-inch wave. Much of that depends on the shape, size and depth of the lake and the wind direction. There are so many variables that my rule number three stands as it is. I can’t quote the source but someone once said, “There’s nothing that teaches a person a better lesson than having a good scare.” True—true, but often those scares take their toll.

I think step taxi and step turns are mainly a training maneuver. I say that because you should be able to fly floats for years without ever having to do any step work. Think of the risks involved. First, we should always think of our landing and take-off areas as being unimproved airports. Increasingly there seems to be more debris on and in the lakes and rivers. If you hit a half-filled beer can at step speeds you can damage your floats, hit a plank or something heavier and the chance of damage really increases. Secondly, the lakes are also becoming more crowded with fisherman, pleasure boats and water skiers. We must always watch out for these people. They tend to feel that what we consider a perfectly safe operation can be nothing but carelessness. There are several good reasons then, to use speeds above idle taxi for take-off and landings only.

However, if we are to do step taxi and step turns let us remember the fourth big rule. **IF YOU ARE GOING TO INCREASE YOUR RPM ABOVE 1,000, ALWAYS BE HEADED INTO THE WIND.** Let’s assume that you are going to make a crosswind take-off. After you have full power and the nose of the aircraft is at its highest pitch, begin your turn to the crosswind bearing. *Don’t establish a step taxi condition before you make the turn to a crosswind bearing.* If you are going to make a step turn to the downwind, start your turn when the nose of the aircraft is at its highest pitch. *Be sure that you do not turn to more than the exact downwind position.*

I always ask the applicant for a simulated high density altitude, maximum gross weight take off. Normally, much of the training has been done at less than the maximum allowable gross weight conditions. We simulate this by not allowing full power for the take off sequence. I feel it’s a valuable demonstration since all float plane pilots must, at times, abort a take off. They should, at some time in their training, have that experience. It’s the attitude that every attempt at take-off must result in becoming safely airborne that causes seaplane pilots to, at times, end up in the trees.

In my take off attempt the most important thing is to gain take-off speed. That sounds pretty basic, doesn't it, but I have seen good pilots humbled and a little confused when they have failed to reach that flying speed. In each of these cases the pilot failed to attain that necessary item—constant acceleration—that feeling of the body being thrust backward, at times ever so slightly, until flight occurs. Let's review the other feelings the body can feel. They are: 1) Bouncing—this is a water condition, waves etc. felt as an up and down movement on your seat. That can be stopped, more or less, by forward pressure on the wheel or stick. 2) Porpoise—the fronts of the floats are being held too low—felt as your head and shoulders move forward and back. Applying backpressure to the controls can stop that. 3) Bow Drag—the bows, fronts of the floats, are being held too low—felt by the whole body as brakes are being applied or, as in less severe cases, as all forces stopping. This is stopped by a slight backpressure on the wheel. As the aircraft's speed increases, the pilot must change its attitude to accommodate the changing forces. The attitude for fastest acceleration is always just slightly nosed up from bow drag. This means that in order to get the fastest acceleration, you must, at times during the take-off, get just a bit of bow drag so that you know where the least attitude drag is. A take-off, then, is one of constantly small corrections until the aircraft is airborne.

The one thing that we so not want on a glassy water landing is a flare-out to a landing. We cannot flare-out because on a glassy water surface we cannot see where the surface is. With that one goal in mind, we must have a procedure that makes the landing possible. Earlier in these observations, I mentioned that the lake should be at least one mile long. It is important that our procedure fits for that length of lake. I find quite normally, applicants taking over two miles of lake to get on the water. We must remember that in order *not* to have a flare-out, we must have very little attitude change while on final approach. Let's assume fifty-foot banks with fifty-foot trees surrounding the lake. In order to have little attitude change on final we will have to be quite close to the tops of the trees as we come over the shoreline—let's say twenty-five feet. This should give us one hundred twenty five feet to descend to the water's surface. Remembering that we don't want to land on the beach on the far side, we have only about 35 to 40 seconds, once we've passed the shoreline, to get the job done.

How can it be done? First, we must know of any errors in our airspeed indicator at stall speeds using a landing configuration of desired flaps. Secondly, we must be aware of any errors in our vertical speed indicator. These are two very important instruments for the glassy water landing. Let's start the whole sequence from just after the turn onto final approach to touchdown. At the start of the final approach, you should be about 600 feet above lake level—this gives you about 475 feet to descend until the shoreline. At an average descent rate of 350 feet per minute—at an average airspeed of 1.3 times the stall speed for the approach configuration—you will need a minimum of a 1-½ mile final before reaching the shoreline. Remember; control airspeed using the elevator and the rate of descent using the throttle. When

you arrive over the tops of the trees, at the shoreline, you should have gradually slowed to 1.2 times the stall speed. From that point to the water's surface, you must descend about 125 feet with a slow descent rate of 25 to 50 feet per minute for the last 25 feet of descent to the surface[;] you will have to increase your rate of descent for a short time after passing the shoreline. When you are at the shoreline, decrease your power to about 500 feet per minute of descent. At the same time increase your attitude to an air speed of 1.1 times the stall speed for a few seconds. Then hold your attitude and increase your power for a rate of descent of 25 to 50 feet per minute. Maintain that condition until touchdown. After touchdown, close the throttle.

In summary let me stress that the rules I have suggested are very basic. They are not so complicated that they cannot be remembered from one season to another. They are the rules most often broken that end in accidents. They are the procedures most often done inadequately during flight tests. They can be used as instrument panel placards on seaplanes.

Here they are again:

1. DON'T HURRY.
2. NEVER EXCEED 1,000 RPM UNLESS YOU WISH TO STEP TAXI, STEP TURN, OR TAKE OFF.
3. ALWAYS HAVE A MINIMUM RPM AND WATER SPEED WHEN TURNING INTENTIONALLY OR UNINTENTIONALLY INTO THE WIND.
4. IF YOU ARE GOING TO INCREASE YOUR RPM ABOVE 1,000 ALWAYS BE HEADED DIRECTLY INTO THE WIND.

Practicing the four rules just mentioned and the glassy water landing technique should guarantee happy times while flying floats.

*Document 5-29 (b), "Kenmore Air—A Unique Airline;
'An Experience You'll Never Forget'."*

Flying off the water will spoil you. Once you've experienced the exhilaration of journeying between sea and sky on the same flight, other types of aircraft will seem rather ordinary.

Our airline is different. For starters, we own planes. Our fleet is the envy of the world. Tickets aren't necessary, just your name. Don't look for departure times. There aren't any. We'll direct you to tables where you'll meet your pilot and fellow passengers. Feed the ducks 'til it's time to go.

Seaplanes are probably smaller than the airplanes you're used to. Pilots pass out sandwiches instead of peanuts. Flights are short and everyone is friendly. Pilots fly our planes, not computers. Our entertainment is outside your window watching whales or a Trident sub pass by. If you have a question you just wait until the plane is at cruising level, then tap your pilot on the shoulder or pass a note to him.

Flying low over postcard landscapes reveals views you can only imagine at 30,000 feet. Whether in sunshine or misty drizzle, Northwest coastal areas are dazzling. A typical route leads north from Seattle along the inland waterways of Puget Sound. Below, a school yard, a farm, a country road. Bustling marine traffic links island villages and metropolitan ports. Enjoy a peek into the lives of folks at work and play.

Evergreen forests lead from water's edge to snow-capped peaks. On the west are the rugged Olympic Mountains, while the Cascade Range shields Puget Sound from morning's first light. Too soon, it seems, you'll arrive at your destination, inspired by a flight of many splendors...getting your Northwest getaway [off to a great] start!

OUR FLEET

Four models of floatplanes are used for our scheduled and charter flights.

The seven-passenger piston deHavilland [*sic*] Beaver is the most successful floatplane ever built. It has been the most popular member of our fleet since the early 60's. The Beaver sports a great wing for maximum lift, a sturdy structure and a powerful 450 horsepower Pratt Whitney R-985 radial engine. The Beaver first came off the line in 1967. Our re-manufacturing turns them out better than new.

Turbine powered Beavers make a good plane even better—more carrying capacity, higher climb rate and faster cruise speed. The single engine deHavilland [*sic*] Turbine Otter is the largest, most powerful aircraft in our fleet. A popular workhorse of the northern bush, we began converting piston-powered [O]tters to turbine engines. The effect was like giving Popeye a can of spinach. We now have 6 Turbine Otters in service.

Cessna 180s go on flights that don't require the Beaver's tremendous load capacity. This three passenger model is favored by north-country operators.

SAFETY

Our flight team has an outstanding track record. Careful scrutiny by the FAA and our own conservative standards through 50-plus years have resulted in reliable operations. Prospective passengers concerned about the safety of small planes should realize we fly over water almost our entire routes. In an emergency, landing strips are everywhere.

Document 5-29 (c), "Seawinds."

The Seawind is one of the fastest, most stylish, four/five seat, single engine amphibious airplanes in the world. Because the hull of the Seawind is made of composite material, rather than aluminum, it will not corrode in seawater.

The Seawind is currently produced as a kit airplane. The kit builder, SNA Inc., has sold 150+ kits and 36 planes are currently flying. SNA currently produces 35–50 kits per year, with a 4-month backlog of orders. ACE has improved SNA's design by installing a more powerful engine and will sell modification kits (patent in process) for a 350-hp engine to other builders, which will only be available from ACE.

ACE Aviation also provides a builder's assistance program for composite kit-built aircraft, including the Seawind. SNA INC. makes the major airframe sub-assemblies for the Seawind, the engines are made by Lycoming, Inc. and propellers from Hartzel. These sub-assemblies are shipped to San Rafael, California where they are assembled and finished. The plane is then inspected and test flown under the supervision of the FAA. The sub-assemblies, including the engine, cost about \$200,000 and the labor assistance produces about \$300,000 of revenue, depending on options.

Airplanes started out in World War I being made of wood and cotton cloth. Aluminum quickly replaced wood and fabric because of its better strength-to-weight ratio. Today, almost all general aviation aircraft are made of aluminum. Almost all military high-performance aircraft, however, are made of composite fiber, which has an even better strength-to-weight ratio. Airliners have increasingly begun using composite technology. The Airbus is made almost totally of composites. Boeing currently is upgrading its aircraft manufacturing with a new composite manufacturing process for its hulls.

Small civilian airplanes are still primarily made of aluminum. The Seawind, however, is made of composites. This new technology makes amphibious aircraft virtually maintenance free. The composite material has no propensity to corrode. If composite material hits a submerged object in the water it generally bounces off and is more flexible than aluminum. If the Seawind is damaged, repairs are only made to the part that was directly impacted, unlike aluminum structures, which transfer the force and distort other parts. The Company believes that these new materials are highly attractive and appear to be the way of the future.

The Composite Shop is located in two hangars at the south end of the field. Each hangar is 30 × 40 ft. Unlike the Sheetmetal Shop, when you walk into the Composite Shop you see there is a minimal amount of floor mounted machine tools. Everything is portable to make room for the different parts of the assembly process. One of the hangars holds the nearly complete Seawind or other composite airplane. The other is used to fabricate the component parts.

There are 4 mechanics working in the shop on the Seawind. They combine technical skills with artistry. They fabricate the fixtures used to hold the part in

place while the resin hardens. They make the molds used to form the part. They mix the resins and lay up the cloth. Then they squeegee the part and lay up more cloth. After completion the part hardens and then cures. After curing the part, they do the finish work. The part is then bonded to the aircraft structure and hand finished to perfection.

As ACE is a federally certified facility, it is routinely inspected. ACE employees pay the strictest attention to safety and environmental concerns. All chemicals are handled in accordance with applicable rules.

Mechanics from other shops, such as Avionics, come to the Composite Shop to provide special functions. An example of this is installing radios. This ability to use the skilled mechanics from other shops for specialized functions is somewhat unique for builder assistance programs.

The Seawind is licensed in the United States as an Experimental-Type Certified Aircraft-Homebuilt. SNA Inc. has applied for a change in status to Experimental-Type Certified Aircraft Kit Manufacture. This change in status will mean that ACE Aviation will be able to sell completed Seawinds to the general public. As soon as this happens, ACE Aviation will move from supplying Builder's Assistance to manufacturing and marketing finished Seawind aircraft. According to industry publications, about 20–25% of the airplanes in the United States today are Experimental-Type Aircraft.

Document 5-29 (d), "SeaAirNY."

The little Cessna 208 Caravan 10 seater seaplane, the limousine of seaplanes according to the pilot, just might become a replacement for all those noisy helicopters touring Manhattan. The seaplane takes off out of the East River (some of the nastiest water I've ever seen, so don't fall getting into the plane) into the wind, which in this case meant we were aimed directly at the U.N. building. With the engine rattling and the plane lurching, I thought we might explode. But, after a short liftoff, we were in the air, turning to fly south 'round the tip of the island. When I saw Manhattan at a 90-degree angle to my head, I forgot all about my fear of flying.

The plane traces the southern edges of Manhattan, from Roosevelt Island to the George Washington Bridge and back, from an altitude approximately the height of the World Trade Center towers. From the air, you'll see Governor's Island, Queens, Brooklyn, Staten Island, the Statue of Liberty, Ellis Island, the New Jersey Coast, downtown Manhattan, the Bronx, Fort Tryon, Yankee Stadium, and all of the NYC bridges. We also sailed over low-flying helicopters. It's the most perfect view of New York you can imagine.

On a windy day, wind tunnels down the long avenues of Manhattan and then funnels up to create turbulence for low-flying aircraft. My day out was a particularly windy day—about the roughest wind they'll fly tourists in. If it's a windy day, you're going to have [to] love the sensation of rollercoaster rides to appreciate this seaplane tour, but in general, it's a fabulous way to tour the city. Never before have I seen so much of New York in a half-hour.

In case you're nervous, the ride is perfectly safe (and it's much safer than a helicopter). The plane will rattle during takeoff, since it takes a much greater force to lift a plane out of the water than it does to lift one off the ground. But if you can get past that, it's the best tour of New York around.

Document 5-29 (e), "Seawolf: Multi-Mission Amphibian."

SEAWOLF can be equipped with stabilized Forward Looking Infrared (FLIR) with video camera and Digital Multi-Spectral Imaging System for the most sophisticated of Aerial and Maritime Surveillance roles. Oil and water samples can be collected by SEAWOLF while on maritime surveillance. SEAWOLF is designed to operate well and efficiently in remote and rugged areas under extremes of altitude, temperature and landing sites—both on land and water with a minimum of maintenance.

Light-weight television surveillance equipment with ground based data links as well as FLIR are available from several manufacturers. Avionics, surveillance and detection equipment will be tailored to the specific mission requirements and compatibility with existing user equipment. SEAWOLF can be equipped with night vision goggle compatible cockpit. It is also deployable from C-130 and C-141 aircraft.

SEAWOLF is equipped with hardpoints to allow the mounting of a broad range of external stores. The inboard position can support up to 100 kg. loads. The outboard position between the inboard position and the sponson can carry loads [of] up to 50 kg. in weight.

The jettisonable fuel tank has a capacity of nearly 118 liters. SEAWOLF can also be equipped with dual search and rescue packs which are droppable and automatically deployable. These rescue packs can be equipped specifically for tropical forest, desert, marine or purely medical rescue missions. Forward Looking as well as Remote Sensing Equipment can also be fitted as external stores to fill your Maritime and Aerial Surveillance requirements.

SEAWOLF, due to its refined design and rugged construction, has a lower maintenance cost which results in lower operating costs.

The unique capability of SEAWOLF to operate from water or land makes it an efficient vehicle from which to mount a variety of special operations. In addition to rescue equipment, when equipped with the ALKAN standard NATO mount, SEAWOLF can carry a wide variety of external stores, such as countermeasure devices and pyrotechnic devices providing lighting means for night photography, marking, ground lighting, etc. A large selection of optimal features such as radar, radar altimeter, etc., can help SEAWOLF meet your special mission.

It is the most practical, common sense answer to mission requirements anywhere in the world today.

Engine	Lycoming TIO-540
Engine TBO	1800 Hours
Wing Span	38 Ft. 4 in. (11.68 M)
Height	9 Ft. 4 in. (3.05 M)
Length	28 Ft. 4 in. (8.64 M)
Seats	4+
Max Ramp Weight	3650 Lbs. (1656 Kg.)
Max Take Off Weight	3650 Lbs. (1656 Kg.)
Max Landing Weight/Smooth Surface	3450 Lbs. (1565 Kg.)
Standard Empty Weight	2280 Lbs. (1034 Kg.)
Max Useful Load	1370 Lbs. (622 Kg.)
Fuel Capacity, Standard	88 U.S. Gal (333 Liters)
Fuel Capacity, External	150 U.S. Gal (568 Liters)
Range, Standard Fuel @ 120 KT/222 KM	780 Nm/1442 Km. w/30 Min. Reserve
Range, External Fuel @ 120 KT/222 KM	1450 Nm/2680 Km. w/30 Min. Reserve
Endurance, Std. Fuel @ 90 KT/166 KM	8 Hrs. w/30 Min. Reserve
Endurance, Ext. Fuel @ 90 KT/166 KM	14 Hrs. w/30 Min. Reserve
Cruise Speed, 80% (60 LTR/15.9 Gal/HR)	155 Kts. (287 KPH)
Cruise Speed, 55% (46.5 LTR/12.3 Gal/HR)	120 Kts. (222 KPH)

Document 5-30

**Excerpt from Theodore Von Kármán with Lee Edson,
*The Wind and Beyond: Theodore Von Kármán, Pioneer
in Aviation and Pathfinder in Space* (Boston & Toronto:
Little, Brown and Company, 1967), pp. 85–87.**

This is the first in a series of documents that will complete this chapter related to the history of rotary-wing aerodynamics, notably concerning the evolution of the helicopter. What it offers is an excerpt from the posthumously published autobiography of Theodore von Kármán, in which the renowned aerodynamicist recalled his involvement five decades earlier in the pioneering helicopter experiments of Austrian Colonel (later Captain) Stefan Petróczy back in 1917. In essence, what Stefan Petróczy had in mind in 1917 was not a free-flying machine but a “captive helicopter” (in German, a *Fesselschraubenflieger*) that could replace balloons for artillery observations. The concept was not totally new, though Petróczy and von Kármán were unaware of the progenitor. In 1849, Princeton University professor J. Henry Smith had designed a captive helicopter that he, too, intended for military observation. The most interesting aspect of Smith’s design was that he hoped to power it with electricity more than 30 years before the first electric motors were introduced. What Smith sought to do, unsuccessfully, was use a steam engine located on the ground to produce the electric current for an on-board motor that would power a 23-foot-diameter rotor.

Petróczy’s “captive” weighed about 4,500 pounds. It had two counter-rotating propellers below an observer’s cabin. It also had inflated bags for landing gear and a quick-opening parachute for the pilot. (Smith’s concept of 1849 also included a parachute.) But the latter was never needed because Petróczy’s helicopter never made anything but brief tethered flights to very low heights.

At the end of the excerpt, von Kármán commented on his ongoing interest in helicopters, long after his formative experience back in the Austro-Hungarian Empire. Of particular note is his prediction that “the helicopter will become more important in the jet age not only for military purposes but as vertical flight is needed to bring people rapidly from jet airports to their hometowns.” The last part of the prediction has not yet come true for most people, but it certainly has for business executives, political leaders, and some of the other more privileged members of society.

*Document 5-30, Excerpt from Theodore Von Kármán with Lee Edson,
The Wind and Beyond: Theodore Von Kármán, Pioneer
in Aviation and Pathfinder in Space (Boston & Toronto:
Little, Brown and Company, 1967), pp. 85–87.*

We also got started in 1917 on some pioneer helicopter experiments. The military was trying to find a device to replace the balloons, which had been used for artillery observations since the time of the American Civil War. Balloons, being huge sausage-shaped stationary bags filled with hydrogen, were easily shot down in flames, especially with the new incendiary bullets which had just been developed. Colonel Stefan Petróczy, my chief, thought that a helicopter would be much safer and more effective than a balloon because it would present a smaller target to the enemy. The higher authorities agreed. So Zurovec and von Asboth, two fine designers, and I developed what we called a *Fesselschraubenflieger*, “captive helicopter”—I believe it was the first of its kind. It was anchored to the ground by means of three cables which provide stability, and it had two counter-rotating propellers below the observer’s “cabin,” an open metal can. All the preliminary work was done at Fischamend. Our most successful model (we had quite a few) weighed about 4500 pounds and was powered by three 120-h.p. motors.

As with balloons, the helicopter observer ranged the area with binoculars and reported troop movements to a ground station by radio. We made over thirty such observation flights in our helicopter. I took one of the first flights myself, climbing as high as one hundred feet and managing to stay aloft an hour. I remember peering around from the cabin but didn’t see much. I also came away with the strong impression that life as an observer in a helicopter cabin could be very uncomfortable.

The general staff agreed with us that helicopters looked like a vast improvement over balloons, and the Liptak factory in Budapest eventually agreed to make the machines under contract. We were plagued, however, with the problem of stability. When the cables were slack, the helicopter tended to sway considerably. One day while we were demonstrating the machine to visiting military dignitaries the helicopter got caught by a shifting wind, lost stability and crashed to the ground, with the propellers still beating furiously. Before they could be stopped a propeller broke, and as the war was nearing an end we never had a chance to rebuild it. The Italians later captured Fischamend and hauled away my entire laboratory, including the helicopter. In 1935, when I was in Italy, I was shown my old machine. It had become an Italian museum piece.

My interest in helicopters has remained with me all through the years. I still think that a helicopter with two counter-rotating propellers has a good future, because it produces much less vibration than does the ordinary helicopter. But at the present time the emphasis is on rotating wings. However, the problem of control still persists. At Aerojet-General Corporation I experimented with rotors and

with elliptic thick wings like those of the Junkers plane. S.W. Yuan, a fine engineer who is now a professor at the University of Texas, collaborated with me on a jet rotor control, which we patented a few years ago. The consequences of this are not yet foreseeable, but I believe the helicopter will become more important in the jet age not only for military purposes but as vertical flight is needed to bring people rapidly from jet airports to their home towns.

An interesting aside to my helicopter work at Fischamend occurred in the United States. Brigadier General Frank Gregory, an old friend of mine, now vice president of Midwestern Instruments Company in Tulsa, and until recently commander of the U.S. Air Force Office for Scientific Research, is a specialist in the rotating wings of helicopters. In fact he was one of the U.S. Air Force's first helicopter pilots. Some years ago he wrote an article on the history of helicopters. In this article he described my early experiments, saying that the captive helicopter was developed by a young Austrian lieutenant named Kármán, but unfortunately nobody knew what had become of him.

When I read this, I telephoned General Gregory.

"Dear Frank," I said, "did you not recognize this Austrian lieutenant?"

"What?" he exclaimed. "You mean it is you?" He knew the von Kármán at Cal Tech but had never associated him with Lieutenant Kármán of Austria. In 1944 he wrote a book called *Anything a Horse Can Do: The Story of the Helicopter*, in which I am pleased to say he identified me correctly.

Document 5-31

**Edward P. Warner, Chief Physicist,
Aerodynamical Laboratory, NACA, Langley Field, VA,
“The Problem of the Helicopter,” NACA Technical Note 4
(Washington, DC, May 1920), with an “Appendix”
by William F. Durand, Stanford University, 3 April 1920.**

One of the first surveys in English of the basic problems facing helicopter design was this May 1920 technical report published by the NACA. Its author, Edward P. Warner, holder of a Ph.D. in engineering from MIT, later became one of the most renowned leaders of American aviation—a professor of aeronautics at MIT, editor of *Aviation* magazine, and technical consultant on the design of the Douglas DC-3. From 1919 to June 1920 (a month after the publication of this NACA technical report), Warner served as the original chief physicist at NACA Langley.

As Warner understood, the problem of the helicopter came down to four major issues: 1) producing enough lift to get the machine off the ground effectively, 2) managing a safe descent if power was lost, 3) ensuring a high degree of stability and control, and 4) achieving a practical forward speed. Naturally, the last three only became important if the first—producing enough lift—was solved. Thus, Warner spent the first and longest portion of his paper examining the question of how much thrust “can be secured from a direct-lifting propeller” and determined that the propeller should be designed “in order that this thrust may be a maximum.”

Although the paper does not have a formal bibliography, it does make references to some of the relevant work being done in Europe as well as to helicopter-related propeller research being done at the National Physical Laboratory and at what was then called Leland Stanford Junior University. The work at Stanford involved an unprecedented series of experiments conducted by William F. Durand and Everett P. Lesley. Appended to Warner’s report there was also an appendix prepared by Professor Durand on 3 April 1920 covering an additional program of lifting-propeller research at Stanford carried out by Lesley and one of his graduate students, Howard O. Snyder.

Besides being one of the first reports on helicopters written in English, Warner’s Technical Note 4 was also the very first report on helicopters published by the NACA.

Document 5-31, Edward P. Warner, Chief Physicist, Aerodynamical Laboratory, NACA, Langley Field, VA, "The Problem of the Helicopter," NACA Technical Note 4 (Washington, DC, May 1920), with an "Appendix" by William F. Durand, Stanford University, 3 April 1920.

The idea of using a propeller rotating about a vertical shaft to give lift and to sustain a weight by balancing it directly with the thrust is almost as old as the screw propeller itself, and the elements of the theory of the action of a lifting propeller have been understood for at least fifteen years. Unfortunately, however, the printed discussions of this theory are almost all in French, German, or Italian, and those which are available in English are mostly contained in advanced treatises which are not likely to fall into the hands of the casual student. A vast number of helicopters have been invented, many have been built, and a very, very few have been successful up to the point of raising themselves from the ground. The possible advantages of the helicopter are obvious, a machine which can rise and descend vertically, and which requires no large space over which to run before taking off and after descending, manifestly being more useful, other things being equal, than the present type of airplane. It is regrettable that the inventors of direct-lift aircraft have, in many instances, seen only these possible gains and have failed to consider fully the problem which they have to meet or to familiarize themselves with the fundamental theory on which the action of every helicopter must be based. It is felt, therefore, that a broad survey of the problem will be of use in making clear the nature of some of the obstacles which have prevented any helicopter from reaching the stage of practical usefulness as yet and may lead to a saving of some of the time and money which are constantly being squandered on attempts to demonstrate anew facts which are already perfectly well understood without in the least striking at the root of the problem.

The cruxes of the helicopter question are the securing of the necessary lift to rise from the ground, the assurance of a safe descent after complete failure of the engines, the securing of stability and controllability, and the maintenance of a reasonably high forward speed in the horizontal plane; and each of these points will be discussed in turn. Manifestly, until the first problems are solved satisfactorily the others do not rise at all, and the discussion will therefore be started with the question fundamental to all others, the question of the thrust which can be secured from a direct-lifting propeller and of the specifications to which the design of the propeller must conform in order that this thrust may be a maximum.

THE THEORY OF THE DIRECT-LIFTING SCREW PROPELLER.

The characteristics of propellers can be expressed in several different ways, but all of these except one involve the speed of advance, which is zero in the case of the

helicopter. The only formulae which can be used in investigating the performance of the direct-lift machine are then,

$$T = T_C \frac{\rho}{g} N^2 D^4 \quad (1)$$

$$Q = Q_C \frac{\rho}{g} N^2 D^5 \quad (2)$$

$$P = P_C \frac{\rho}{g} N^3 D^5 \quad (3)$$

where T is the thrust, Q the torque, and P the power, and T_C , P_C , and Q_C are experimentally determined coefficients, functions of V/ND alone and therefore independent of peripheral speed when applied to a helicopter.

Dividing (1) by (3) to find the thrust per horsepower, which is always the factor of primary interest,

$$\frac{T}{P} = \frac{T_C}{P_C} \times \frac{1}{ND} \quad (4)$$

The thrust per horsepower is therefore inversely proportional to the peripheral speed. It follows that an increase in the power applied to a given propeller causes the thrust to increase in a smaller ratio than the power, as the increase of power increases the peripheral speed and this causes a decrease in the thrust per unit power. (3) may be written,

$$P = P_C \frac{\rho}{g} (ND)^3 D^2 \quad (5)$$

If P and P_C are assumed to remain constant, ND , which is proportional to the peripheral speed, varies inversely as $D^{2/3}$. It is therefore possible, by making the diameter of the propeller large enough, to reduce ND below any designated value, and so to increase the thrust per horsepower without limit.

Since the thrust per horsepower is inversely proportional to ND , the product of thrust per horsepower and ND is a fundamental characteristic of any given type of propeller for helicopter use. This product is non-dimensional, or, rather, it would be if power were expressed in ft. lbs. or kg. m. per sec., and to equal to the ratio of T_C to P_C . The mean value of the product for the propellers tested at the request of the National Advisory Committee for Aeronautics at Leland Stanford Junior University, the units being lbs. per H.P. and ft. per sec., was 819 for propellers having a pitch-diameter ratio of 1.1, 984 when that ratio was reduced to 0.9, 1124 for 0.7, and 1318 for 0.5. These propellers were all two-bladed. In some experiments conducted at the National Physical Laboratory in 1917 a maximum of 1750 was obtained with a two-bladed propeller especially designed for helicopter work, the blades having a constant angle; and it is probable that this value cannot be very much exceeded.

Solving (4) for ND and substituting the value obtained in (5), the expression for power consumed becomes,

$$P = P_c \frac{\rho}{g} \cdot \left(\frac{T_c}{P_c}\right)^3 \cdot \left(\frac{P}{T}\right)^3 \cdot D^2$$

The product of the first three factors is a constant for any family of geometrically similar propellers, assuming them always to work under the same atmospheric conditions, and the product of P_c and

$$\left(\frac{T_c}{P_c}\right)^3$$

can therefore be used as another fundamental characteristic of the type of propeller. Denoting this product by K , and solving for diameter,

$$D = \sqrt{\frac{P \times \left(\frac{T}{P}\right)^3}{K \times \frac{\rho}{g}}} = \frac{T^{3/2}}{P \times \sqrt{K \times \frac{\rho}{g}}}$$

Solving similarly for N ,

$$N = \frac{\sqrt{\left(\frac{T_c}{P_c}\right)^5 \times P_c \times \frac{\rho}{g}}}{\left(\frac{T}{P}\right)^5 \times P} = \sqrt{\frac{K' \times \frac{\rho}{g}}{\left(\frac{T}{P}\right)^5 \times P}}$$

where K' is equal to $P_c \times \left(\frac{T_c}{P_c}\right)^5$. Since it is always desirable to make D as small as possible and N as large as possible, other things being equal, in order that the helicopter may occupy a minimum of space and in order that the gear reduction ratio from the engine shall not be any larger than necessary, the best propeller for helicopter use will be that one which has the largest values of K and K' . The mean values of these coefficients for the propellers of several pitch-diameter ratios which have been tested at Stanford are tabulated below, together with the values for several propellers of different numbers of blades which were designed especially for helicopter use and tested at the National Physical Laboratory.

Propellers	K	$K'/10^8$
Stanford P/D = 1.1, average	113,600	761
Stanford P/D = 0.9, average	173,000	1673
Stanford P/D = 0.7, average	191,100	2418
Stanford P/D = 0.5, average	217,400	3773
N.P.L. Type A, 2-bladed	130,000	2734
N.P.L. Type A, 3-bladed	158,000	2511
N.P.L. Type A, 4-bladed	146,000	1610
N.P.L. Type B, 4-bladed	144,500	1401
N.P.L. Type C, 4-bladed	167,000	2822

It is clear that the propellers having a constant geometrical pitch of one-half the diameter are, rather strangely, distinctly superior to those designed especially for helicopter use. Since the question of helicopter design has received only the slightest attention, no wind tunnel experiments except those tabulated above having been run in recent years, there is no doubt that propellers better suited for use with direct-lift machines than any that are now available can be devised. As a basis for computation K may be taken as 250,000 and K' as 44×10^{10} . A table can then be constructed showing the diameter and r.p.m. necessary to secure various lifts per horsepower with different engine powers. Such a table is given on the next page [below]. In applying the table, the power taken should of course be the power used on a single propeller. For example, if a 400 H.P. engine drives two propellers the necessary diameter of a single propeller will be found in the column headed 200.

Propeller Diameters in Feet. (R.p.m. in parentheses.)

		Horse Power										
		20	40	60	100	150	200	300	400	600	800	1000
Lbs. Thrust per H.P.	5	(7740) 2.06	(5490) 2.90	(4470) 3.56	(3460) 4.60	(2830) 5.63	(2450) 6.50	(2000) 7.95	(1730) 9.19	(1420) 11.2	(1220) 13.0	(1100) 14.5
	10	(1350) 5.80	(966) 8.21	(786) 10.1	(612) 13.0	(500) 15.9	(432) 18.4	(353) 22.5	(306) 26.0	(250) 31.8	(216) 36.8	(193) 41.1
	15	(495) 10.7	(351) 15.1	(286) 18.5	(221) 23.9	(181) 29.2	(157) 33.8	(128) 41.3	(111) 47.6	(90.6) 58.5	(78.6) 67.5	(70.2) 75.5
	20	(242.) 16.4	(171.) 23.2	(140.) 28.4	(108.) 36.7	(88.8) 44.9	(76.8) 51.9	(62.4) 63.6	(54.2) 73.4	(44.2) 90.0	(38.2) 104.	(34.3) 116.
	30	(87.6) 30.2	(61.8) 42.7	(50.7) 52.3	(39.2) 67.5	(32.1) 82.6	(29.3) 90.5	(22.6) 117.	(19.6) 135.	(16.1) 165.	(13.9) 191.	(12.4) 214.
	40	(42.9) 46.4	(30.2) 65.6	(24.7) 80.4	(19.1) 104.	(15.6) 127.	(13.5) 147.	(11.0) 180.	(9.5) 208.	(7.8) 254.	(6.8) 294.	(6.1) 328.
	50	(24.5) 60.5	(17.3) 91.1	(14.2) 112.	(11.0) 145.	(8.9) 178.	(7.8) 205.	(6.3) 252.	(5.5) 290.	(4.5) 356.	(3.9) 411.	(3.5) 459.

It is not correct to speak of the lifting power of a helicopter as its efficiency, as is often done, since a helicopter screw which is merely sustaining a load in the air is not doing any useful work. Only when ascending is useful work done, and only under that condition is it proper to speak of propulsive efficiency. The helicopter experiments at the National Physical Laboratory were extended to cover ascending and descending flight, and it was found that the thrust per H.P. is almost independent of vertical velocity over a wide range. This is particularly true of descent. For example, a helicopter designed to barely sustain 30 lbs. per H.P. ($ND = 44$) could ascend with a vertical velocity of 800 ft. per min., if the load were reduced to 22 lbs. per rated H.P. and if the power were kept constant. The r.p.m., however, would be

greater during ascent than during level flight, and it would be necessary, in order to keep the engine from racing with full throttle, to use either a variable-pitch propeller or a variable-speed transmission. If no such mechanism were used, and if the r.p.m. were held constant, the load would have to be reduced to 16 lbs. per H.P., instead of only 22, to permit the attainment of the climbing speed specified above. If the throttle were left wide open and the motor permitted to race until its torque was fully balanced by the resisting torque of the propeller[,], no reduction in load would be required, except that there would have to be a very slight initial excess of power to produce a vertical acceleration and start the upward motion. Once started, it would continue of its own accord. It would not be possible to ascend at much more than 800 ft. per min. with a propeller of fixed pitch. By varying the pitch and reducing the load to about one-half what it would be possible to sustain (say 15 lbs. per H.P. in the problem just discussed) it probably would be possible to climb 1,800 ft. per min. or better, although there are not enough experimental data to make it possible to speak with certainty on this point.

It is usually assumed that propellers designed primarily to work under static conditions should have the blade sections all set at the same angle to a plane perpendicular to the propeller axis. This would be correct if there were no indraught, and it is also correct indraught existing, if the indraught velocity at every point is directly proportional to the distance from the propeller axis. It can be shown by a combination of the momentum and blade-element theories of propeller action that this condition is realized when the blade has the same sectional form and angle of attack at all points and when the blade width is directly proportional to the distance from the hub (i.e., when the blade has the form of the sector of a circle). Such a propeller is of course impossible to build, as it would have no strength near the hub. It is probable, therefore, that in actual practice the indraught velocity near the hub is always considerably larger, in proportion to the radius, than that farther out along the blade, and the angle of setting of the elements near the hub should therefore be a little larger than that of those in the neighborhood of the tip. In other words, the propeller blades should have a little warp of the same sort as that which is given to the blades of propellers intended for driving airplanes. The warp of the blades of lifting screws should, however, be much smaller than that of propulsive screws. The British experiments already mentioned dealt with helicopters the blades of which had no warp, and the angles of the blades were varied during the tests with a view to finding the most efficient disposition. It was found that the ratio of T_C to P_C was the largest for a blade angle of $5\frac{1}{2}^\circ$ for the 2-bladed propeller and $7\frac{1}{2}^\circ$ for the 4-bladed one. The difference is accounted for by the largest indraught velocity of the multi-bladed screw. The product K was the largest for an angle of 9° for the 2-bladed propeller and 11° for the 4-bladed. The best angle to adopt would ordinarily be about half-way between that of maximum thrust per horsepower and that of maximum K .

THE SAFETY OF HELICOPTERS IN FORCED DESCENTS.

The gravest charge brought against the helicopter is its lack of means of making a safe descent when the engine has stopped. This charge is frequently answered by the inventors and promoters of the direct-lift machines with the statement that the blade area of the propellers acts as a parachute to prevent the velocity of descent from rising to a dangerous value, but a moment's consideration will show the fallacy of this. A parachute of the usual type carries a load of not more than 0.25 lbs. per sq.ft. of projected area, yet it lands at a velocity much too high to be safe for a helicopter. In order to prevent damage by excessively rapid deceleration the vertical velocity at landing should be kept below 8 ft. per second, any larger velocity requiring the provision of shock-absorbers of considerable size and complexity. However, the limiting safe velocity may be taken, to be generous, as 16 ft. per second. The resistance of a flat plate normal to the wind at a speed of 16 ft. per second is 0.38 lb. per sq.ft., and this would accordingly be the limiting safe loading of the propeller blades, considered as a parachute. Since the area of the propeller blades is never likely to be more than 40% of the propeller disc area, the loading calculated on the basis of the whole propeller disc would have to be kept down to 0.15 lbs. per sq.ft. To carry a load of 2000 lbs., and have the helicopter descend safely on the parachute principle after an engine stoppage, it would therefore be necessary to have a total propeller disc area of 13,300 sq.ft., which corresponds to two propellers each 92 ft. in diameter. This is manifestly too large to be considered if it is by any means possible to do better.

To have the propeller blades give a true parachute effect, it would be necessary that the propellers be locked after the engine stopped to keep them from spinning around, acting as windmills. A possible alternative method is to leave the propellers free, permitting them to spin. The direction of rotation when acting as a windmill would be opposite to the direction in which the propellers are driven by engine power, and the leading edges of the sections would therefore be what are normally the trailing edges. The propeller would operate very inefficiently under this condition, and the lift resisting the descent would therefore be small. Besides, even if there were a marked advantage to be gained from this reverse rotation as compared with the case in which the propeller is held stationary, that advantage would be of no avail when an engine stoppage occurred near the ground, as it would take some time for the force tending to reverse the direction of rotation to overcome the inertia of the rotating parts, and the propeller would have to pass through all the intermediate stages of decelerating forward rotation, remaining at rest, and accelerating reverse rotation before the full effect of the spinning of the blades would be realized. If the machine were initially so low as to strike the ground during this transition stage it would be no better off, so far as limiting speed of fall is concerned, than if the propeller had been locked.

The remaining possibility is to provide means of changing the angles of setting of the blades, and to set them, as soon as the engine stops, at such a position that they permit the propeller to spin around, impelled by the upward pressure of the air against the blades, while maintaining the same direction of rotation as that in which it is driven by the engine. It is obvious that this mode of operation is superior to the one just mentioned, and a detailed analysis of the resistance which the propeller offers to descent when working as a windmill will therefore be made. A great deal depends on the frictional resistance, which has the effect of partial braking, and two assumptions as to this will be made in turn. In the first case, it will be assumed that a clutch is provided to permit the pilot to disconnect the propeller from the engine entirely, and that, the shaft being mounted on ball or roller bearings, the frictional torque can be entirely neglected. Under this condition, the rate of rotation of the propeller will be such that the mean line of action of the reaction on the blades is parallel to the shaft of the propeller.

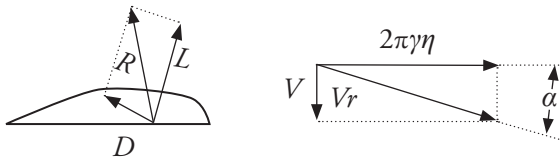

FIGURE 1.

Considering any single element, the resultant and component velocities and forces are shown in Fig. 1. V_r is the vector representing, in magnitude and direction, the resultant velocity. Since there is to be no torque in either direction the equation of equilibrium may be written

$$L \sin \alpha = D \cos$$

and it follows from this that,

$$\frac{D}{L} = \tan \alpha \text{ and } \frac{V}{2\pi\gamma\eta} = \frac{D}{L}$$

Since it is desired to secure the largest possible lift from each element of the propeller, the blades should be set at that angle which will give the largest mean value to the product of the lift coefficient and the square of the resultant velocity. Since V is fixed by the conditions of safe landing, this product may be written,

$$L_C \times V_r^2 = L_C \times (2\pi\gamma\eta)^2 \times \sec^2 \alpha = L_C \times V^2 \times \left(\frac{L}{D}\right)^2 \times \left[1 + \left(\frac{D}{L}\right)^2\right]$$

The term in brackets is always so nearly equal to one that it may be disregarded, and the critical function is therefore the product of the lift coefficient by the square of the L/D ratio. The function has its maximum value when the angle of attack is

approximately 6° for most representative wing sections. Since the mean arc $\tan D/L$ for the whole blade of a propeller at this angle of attack would be in the neighborhood of 4.5° the chord of the blade should be set at about $+1.5^\circ$ to the plane perpendicular to the axis. If L/D has a mean value of 12.5, which corresponds to the assumption just made with regard to the arc $\tan D/L$, the mean peripheral speed for a vertical velocity of 8 ft. per sec., which has already been shown to be the maximum safe landing speed, would be 100 ft. per sec. Assuming this to correspond to a section lying two-thirds of the way out along the blade, the peripheral speed at the blade tips would be 150 ft. per sec. and ND would be 48. When the propeller is being driven by the engine the angle of attack of the sections would normally be from 4° to 5° , and the lift coefficient would therefore be about 12% smaller than when the machine is descending without power and with the pitch reduced so that the propeller acts as a windmill. The peripheral speed for the same upward force would therefore be about 6% greater in the case with power than in that without, and the normal ND would be 51 in the first case for a propeller capable of carrying the weight of the machine during descent without allowing the velocity to rise above 8 ft. per sec. This corresponds to a lift of 26 lbs. per H.P., and it is therefore unsafe to design a helicopter so that it will not be able to sustain normally its full weight at the rate of at least 26 lbs. per H.P., as one which had less lifting capacity than that would have a higher normal value of ND than 51, and would fall with excessive rapidity when the power was cut off (it is assumed in giving these figures than the most efficacious type of propeller available is employed.) [*sic*] The real criterion is that ND shall not exceed 51 under normal conditions, and the load per H.P. for which the helicopter should be designed to insure safe descent would vary somewhat as between different types of propellers) [*sic*].

The second case that has to be considered is that in which there is no means of breaking the connection between the engine and propeller, and in which the propeller is therefore burdened with the task of cranking the engine against its friction during the descent. It will be assumed that the total friction in the engine and transmission is 20% of the brake horsepower, and also (as an initial assumption the propriety of which can be checked at a later stage of the work) that a 150 H.P. engine is used to drive a propeller 240 ft. in diameter at 5.4 r.p.m. The horsepower required to turn the engine over against friction would then be 30, and the torque applied at the propeller, rotating 5.4 r.p.m., would be 29,170 lbs. ft. Taking the mean effective radius of the propeller, as before, as being two-thirds of the maximum radius, the force which it would be necessary to apply to produce this torque would be 365 lbs. Since ND for the propeller just specified is 21.6[,] the thrust would be 61 lbs. per H.P. and the total thrust 9150 lbs. The ratio of torque force to thrust would then be .04. Writing the equations for the elements of these forces and for their ratio,

$$dT = (L_C \cos \alpha + D_C \sin \alpha) \times V_r^2 \times dA = V_r^2 \times dA \times L_C \times \cos \alpha \times (1 + \tan \alpha \tan \gamma),$$

where $\gamma = \arctan \frac{D}{L}$

$$dQ = (L_C \sin \alpha - D_C \cos \alpha) \times V_r^2 \times dA = V_r^2 \times dA \times L_C \times \cos \alpha \times (\tan \alpha - \tan \gamma).$$

$$\frac{dQ}{dT} = \frac{\tan \alpha - \tan \gamma}{1 + \tan \alpha \tan \gamma} = \tan (\alpha - \gamma)$$

Then $\tan (\alpha - \gamma) = .04 \quad \alpha - \gamma = 2.3^\circ$

and, since the mean value of γ would be very nearly 4.5° ,

$$\alpha = 6.8^\circ$$

and $\tan \alpha = \frac{V}{2\pi\gamma\eta} = .119$

Allowing V , as in the first case, to have a maximum value of 8 ft. per second, the limiting mean peripheral speed would be 67.2 ft. per second, corresponding to values of 101 ft. per second for the tip speed and 32 ft. per second for ND . The minimum load capacity for which a helicopter should be designed if it is to have variable pitch propellers but no means of disconnecting the propellers from the engine is therefore 42 lbs. per H.P. For a 150 H.P. engine on each screw this would require a propeller 138 ft. in diameter turning 14 r.p.m. The initial assumption as to propeller size was therefore rather wide of the truth, but this has no effect on the ultimate result. The torque for a given power is inversely proportional to the r.p.m. of the propeller, the torque force for a given torque is inversely proportional to the propeller diameter, and the torque force per horsepower therefore varies inversely as ND . Since the thrust also varies inversely as ND , the ratio between the two components of the reaction is quite independent of the initial assumption as to the propeller size and speed, and the problem could be treated in a perfectly general way without making any such assumption, but it simplifies the work a little to insert some consistent set of figures.

In order to keep the propeller rotating in the original direction and at the maximum effectiveness when it has to turn the engine and transmission over, the mean chord of the blades would have to be set at -1° to the plane perpendicular to the axis, instead of at $+1.5^\circ$ as in the case where there is no frictional torque to contend with.

HORIZONTAL TRAVEL.

The most important question remaining to be discussed has to do with the possibility of progressing at a satisfactory rate in a horizontal plane. To be sure, it has sometimes been proposed to use captive helicopters to do the work for which observation balloons are now used, but their use for that purpose would never

be very extensive under any conditions, and the helicopter can never be considered a practical possibility unless it is capable of making headway against ordinary strong winds.

There are two methods frequently suggested for securing a propelling force in a helicopter. The most commonly proposed, and the one which is likely to be most successful, entails the inclination of the axis so that the thrust may have a horizontal component. The second, which will not be discussed in detail in this report, depends on the use of subsidiary propellers with horizontal axes for propulsion, the transmission being of such a type as to permit of the distribution of the engine power between the sustentative and propulsive screws in any desired proportion. This scheme entails considerable structural difficulties, the requisite being practically two transmissions of infinitely variable gear ratio driven from a single engine and remaining continuously in engagement while the ratio is being changed.

The forces acting on a helicopter with inclined axis are shown in Fig. 2. The method of throwing the machine into the inclined position need not be considered at present, nor need the moments which tend to increase the inclination or to restore the helicopter to a vertical position, as these will be taken up separately in a later section of the report in connection with the general problems of stability and control. The equations of equilibrium for steady horizontal travel are

$$T \cos \theta + \gamma \sin \theta = W$$

$$T \sin \theta - \gamma \cos \theta = R$$

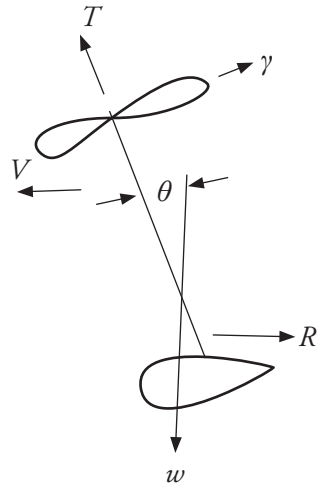

FIGURE 2.

The angle of inclination which the machine assumes depends on the characteristic of the propeller and on the structural resistance. It can best be approximated by examining the conditions under which a propeller would work when exposed to a wind at right angles to its axis (i.e., at 90° yaw). Some tests under this condition were made by Riabouchinsky at Koutchino in 1906, and the results are summarized by M. See in "Les Lois Experimentales des Helices Aeriennes," but the results are so surprising in some respects that it is difficult to give them entire credence, especially as the experiments were performed in the very early days of aerodynamical research, when methods of measurement were rather crude. If a propeller is presented to a wind of velocity at 90° yaw, the velocity with which each blade meets the air varies between $2\pi\gamma\eta + V$ and $2\pi\gamma\eta - V$. The angle of attack also

varies somewhat during the revolution, as the indraught must be nearly constant. The angle of attack is obviously largest when the speed is largest. Neglecting for the moment the variation in angle of attack, and designating the maximum and minimum speed of the blades by v_1 and v_2 , respectively, it is seen that the ratio of T to Y at the instant when the line of the blades is perpendicular to the direction of the wind, and so when the effect of the yaw is a maximum, is

$$\frac{T}{Y} = \left(\frac{V_1^2 + V_2^2}{V_1^2 - V_2^2} \right) \times \frac{L \cos \alpha - \sin \alpha}{D \cos \alpha + \sin \alpha} = \frac{V_1^2 + V_2^2}{V_1^2 - V_2^2} \times \cot (\alpha + \gamma).$$

This is approximately equal to

$$6 \times \frac{V_1^2 + V_2^2}{V_1^2 - V_2^2}.$$

For high speeds of advance v_2^2 is negligible by comparison with v_1^2 , and the ratio of T to Y therefore is probably in the neighborhood of 6. If it be assumed that this ratio is sustained unchanged when the axis is slightly inclined it appears that an inclination of about 10° would be necessary in order that the resultant of T and Y might be vertical when the helicopter was advancing rapidly. This, however, is not sufficient, as R is yet to be overcome. The total resistance of fuselage, propeller shafts, and structure (not including the propellers) at 60 m.p.h. should not exceed one-twentieth of the weight of the helicopter, and the additional tilt necessary to overcome the resistance at this speed would therefore be 3° , making a total of 13° . The angle of yaw is then 77° .

Unfortunately there are no data available for such angles of yaw as this. Riabouchinsky's experiments cover (not entirely satisfactorily in the light of modern practice) the case of 90° yaw, and the only other experiments which have been published are some made by the N.P.L. on propulsive screws at angles of yaw [of] up to 25° . The working conditions of propellers at small angles of yaw and those at 90° are entirely different, and it is difficult to interpolate between two sets of experiments so diverse as those just mentioned. At 90° yaw, as has just been pointed out, the angle of attack is almost independent of the rate of advance, and the thrust increases steadily as the speed of advance increases. When there is little or no yaw, on the other hand, the rate of advance has an important and direct effect on the angles of attack of the blade elements and the thrust falls off rapidly with increasing speed. In order that a helicopter may be suitable for use in all ordinary weather conditions it must be capable of maintaining a forward speed nearly or quite equal to the tip speed of the propellers. This is quite hopeless if the thrust is to fall off rapidly as the speed increases, and not even the provision of a variable pitch propeller would make it possible to secure sustentation and propulsion at high speeds under such conditions. It is possible, however, that when the inclination of the axis from the vertical is only ten or fifteen degrees the rate of change of the angle of attack with changing speed will be small enough so that high speeds can be attained.

This is a point which can most easily be settled by wind tunnel tests on propellers at angles of yaw ranging from 60° to 90° , and such tests should be undertaken as soon as possible.

The dissymmetry between the blades when the helicopter is advancing, resulting in one or more blades carrying more than their share of the load at any given instant, makes trouble structurally, both because of the increased maximum stresses in the propeller blades and because of the large bending moment produced in the propeller shaft and frame of the helicopter. This bending moment can best be taken by placing one propeller above another and keeping them as close together as possible. The bending moments induced by the two propellers will then be opposite and will neutralize each other except in the section of shaft between the propellers. The placing of one propeller in the slipstream of the other may make a little trouble, at times, in the equalization of torque, but it should be possible to overcome any difficulty of that sort by proper adjustment of the blade angles.

If two-bladed propellers were used there would be likely to be some trouble with vibration of the structure when advancing horizontally if the propellers were not perfectly synchronized, as the total moment and force due to each propeller would vary during the revolution. Y , for example, as already noted, would be at a maximum when the line of the blade axes was perpendicular to the line of motion of the helicopter, and would be almost zero when those two lines were parallel. By using propellers with four or more blades all these difficulties can be avoided.

STABILITY AND CONTROL OF THE HELICOPTER.

The stability of the helicopter is dependent on the fin action of the propeller and of any surfaces which may be exposed in the slipstream. As long as the machine is neither ascending [n]or descending, the primary effect of any inclination of the axis from the vertical is to produce a horizontal component of the thrust. This causes side-slipping, which, in turn, causes the propeller and any fin surface to be subjected to a lateral force. If the center of fin surface is above the center of gravity the lateral force gives a righting moment. Control can be secured by adjustable surfaces placed above the C.G. if the damping out of oscillations as soon as they are started is the only consideration. The dynamical stability of helicopters, or the rapidity with which oscillations are damped out when once started, has been thoroughly investigated by Professor H. Bateman in a report soon to be published by the National Advisory Committee for Aeronautics.

When the helicopter is moving the conditions are materially altered. When moving horizontally the forces are as shown in Fig. 2, the axis being inclined, and there is a moment, due to Y , tending to return the helicopter to a vertical attitude. A fin surface above the C.G. then has little or no controlling effect, as the force on it is always in the same direction as Y and R . A small moment tending to hold the helicopter in its inclined position can be secured by setting the control surface

above the C.G. nearly horizontal, but this would be very ineffective if the horizontal translational velocity were much more than the slip-stream velocity. By placing a fin surface low down, on the other hand, any desired measure of control can be secured, but only with the accompaniment of some structural disadvantages. Such a surface would be set horizontally when it was desired to hover motionless, and would be inclined at an angle to the horizontal in order to go ahead. Once forward motion was started, the surface could be set vertical and this position would correspond to the maximum moment about the C.G., to the maximum inclination of the propeller axis for equilibrium, and so to the maximum forward speed. As already mentioned, there are constructional difficulties in the way of placing a control surface far below the center of gravity, most of the weight being concentrated in a car which should be as close to the ground as possible to save landing gear weight and resistance. It may be possible to arrange the control surface in two parts, one above and one below the C.G., and to provide means of folding up, just before touching the ground, the framework which carries the latter, since the high control surface is sufficient during vertical descent.

During ascent and descent the stability is much the same as when stationary, except that any inclination now changes the angle at which the propeller meets the air, and a lateral force is therefore set up at once, before the helicopter has moved laterally out of its vertical path; [*sic*] In the case of ascent this force tends to increase the deviation from the vertical, in the case of descent to decrease it (always assuming the propeller to be above the center of gravity). To secure stability during a climb a large fin surface placed far below the C.G. of the machine would be necessary. Such a fin surface would operate rather inefficiently, as the inclination of the axis produces a change in direction of the slip-stream which would partially counterbalance the effect of the presentation of the fin surface at an angle to the relative wind due to the upward motion of the helicopter. It would be advantageous, from the standpoint of stability when rapidly ascending, to have the fin and control surfaces outside the slip-stream, and this might be possible to arrange in those helicopters which have two propellers in parallel and rotating in opposite directions. Part of the fin surface could then be placed between the two slip-streams. It would not be safe to put it all there, as there would then be no control when poised motionless. In short, there is no single disposition of fin surface which satisfies all requirements, but it is absolutely essential, if a helicopter is to travel horizontally, that there be enough fin surface low down, to bring the center of lateral resistance well below the center of gravity and that the inclination of this surface be variable under the control of the pilot.

APPENDIX
TO
THEORY OF THE HELICOPTER.

Some additional experiments on the thrust and power consumption of propellers working under static conditions have recently been carried out by Messrs. Lesley and Snyder at the Stanford University wind tunnel. A systematic investigation of the effect of varying pitch-diameter ratio, the tests covering a family of otherwise similar propellers with pitch-diameter ratios ranging from 0.1 to 1.3, showed that the largest thrust per horse power for a given peripheral speed was obtained with a pitch of .32 times the diameter. The maximum value of K corresponded to a ratio of .6, and the maximum of K' to one of .5. In a similar set of tests on propellers with unwarped blades set at various angles the highest thrust per H.P. was obtained with an angle of 6° , the best value of K with 15° , and the largest K' with 12° . In none of these tests were the values for any of the coefficients larger than those already reported. A propeller designed by R. Jacuzzi, especially for helicopter use, had K equal to 122,000 and K' 3880×10^8 . The latter figure is close to a record, but the former is rather poor as compared with the best of the constant pitch propellers.

During the winter of 1919–20 standing thrust and power tests for air propellers were conducted at the Stanford University Aerodynamic Laboratory by Mr. Howard O. Snyder, a graduate student in Mechanical Engineering.

In these tests one form of two blade propeller only was tried. This was the narrow curved and tapering form with uniform geometrical pitch and non-cambered driving face designated as $P_1 F_2 A_1 S_1$ in Reports No. 14 and 30, National Advisory Committee for Aeronautics.

In addition to re-testing the propellers that had been already tried three additional pitch-diameter ratios, .1, .3 and 1.3[,] were investigated, making in all 7 propellers varying in pitch ratio from .1 to 1.3 by increments of .2. The results of these tests, reduced to coefficients of the form used by Mr. Warner, are shown in the accompanying Fig. 1.

In the curves as shown T_c and P_c are non-dimensional. T_c/P_c is multiplied by 550 in order to make it comparable to the coefficient used by Mr. Warner, in which thrust is expressed in pounds and power in horse power instead of foot pounds per second.

The coefficients K and K^1 were derived in the same manner as Mr. Warner's.

As may be seen a somewhat higher value of T_c was realized for the .3 pitch ratio propeller than for the one of .5 pitch ratio. However, the coefficients K and K^1 are both considerably less for the propeller of smaller pitch so that to realize the same lift with the equal power a larger propeller running at a slower speed would be required, making on the whole the .5 pitch ratio superior.

Besides the foregoing, tests were made on a flat or non-warped blade propeller of the same contour, area, and section as $F_2 A_1 S_1$. The blades were fitted into a

spherical hub provided with means for adjusting them to various angles. The results of these tests are shown in the accompanying figure 2. These recent experiments indicate that, regarding $550 T_c/P_c$ as a measure of efficiency, practically the same may be realized from the non-warped blade as from one of uniform geometrical pitch. However, as Mr. Warner has pointed out, it is not enough to attain a high value for $550 T_c/P_c$. It is also necessary, in order to keep the diameter reasonably small and the rate of revolutions high, to secure large values of the coefficients K and K^1 .

Tests at Stanford University on a two blade propeller 6 ft. in diameter and about 1 ft. nominal pitch, designed for helicopter use by R. Jacuzzi of Berkeley, California, in 1918, determined the following coefficients:

$$\begin{aligned} T_c &= .0382 \\ P_c &= .0118 \\ \frac{550 T_c}{P_c} &= 1785 \\ K &= 122000 \\ \frac{K^1}{10^8} &= 3880 \end{aligned}$$

Although for this propeller $\frac{550 T_c}{P_c}$ is larger than for any other tested in the Stanford Laboratory, K and K^1 are relatively small.

To realize with this propeller a lift of 30 lbs. per horse power at sea level air density with 100 horse power input, a diameter of nearly 97 feet, and about 37 revolutions per minute would be required, whereas with the .5 pitch ratio blade the same lift and power input could be secured with a propeller 72.5 feet in diameter running at 37.5 r.p.m.

The form of the T_c curve for uniform pitch propellers between pitch ratios of .7 and 1.3 is somewhat surprising. Repeated tests have determined its substantial accuracy however, the dotted line showing the results of investigations on a similar series of propellers of different blade contour and section but of approximately the same area.

W. F. Durand.

Stanford University, April 3, 1920.

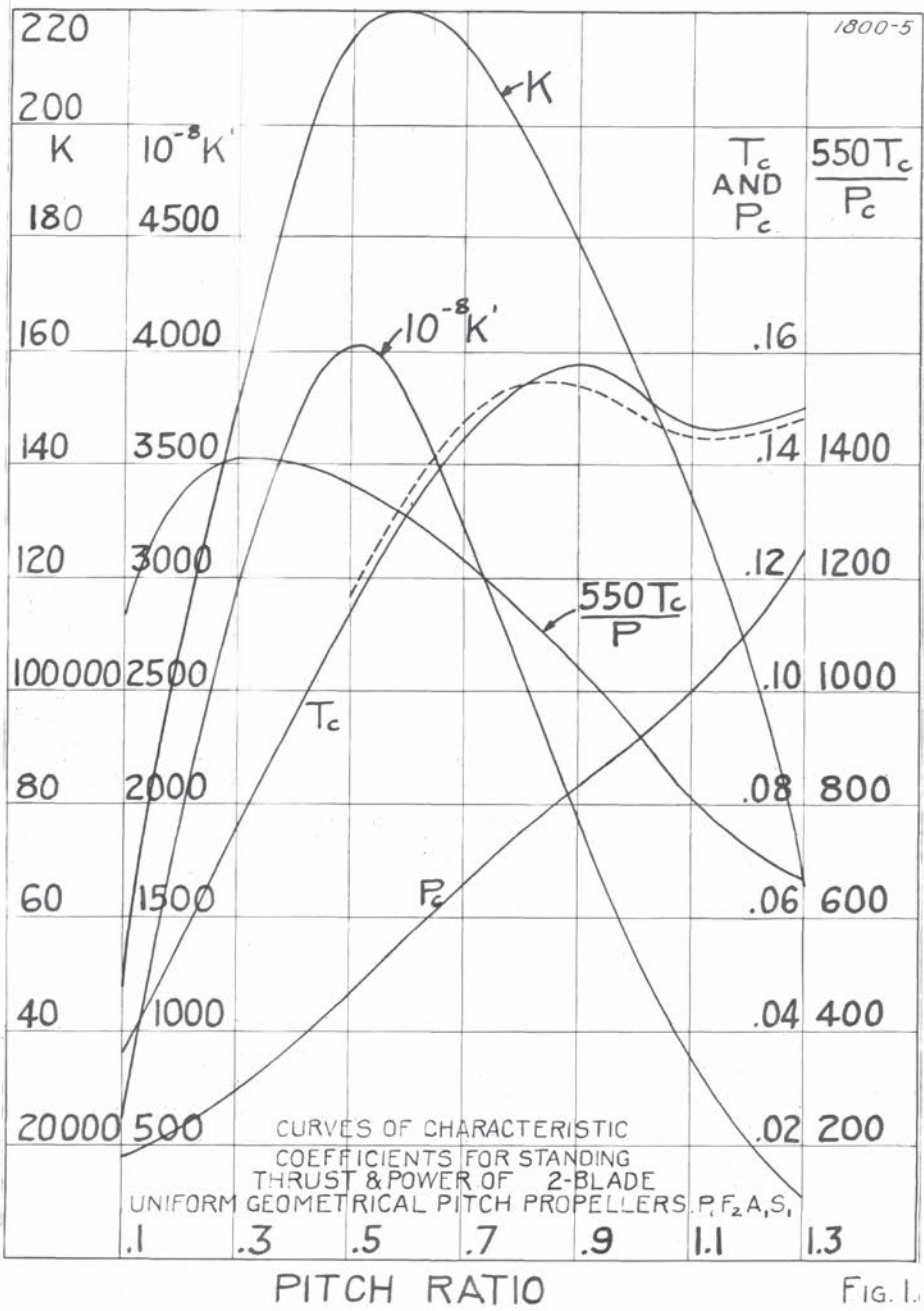
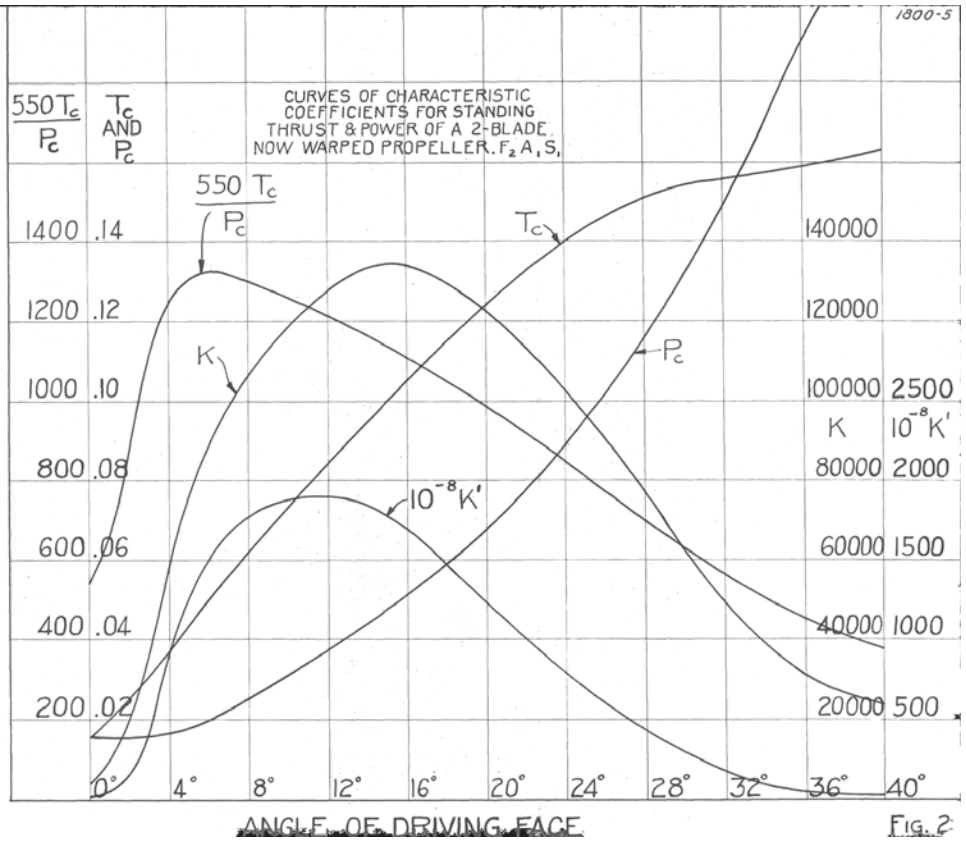

FIG. 1.



Document 5-32

**“The Oehmichen Peugeot Helicopter,”
NACA Technical Memorandum 13 (Washington, DC, 1921),
translated by the Paris Office of the NACA, March 1921.**

This is a translation of two articles that appeared in the French magazine *L'Auto* on 26 and 27 January 1921. It was the work of the Paris Office of the NACA, which opened in June 1919 to collect, exchange, translate, and abstract reports, as well as feeding miscellaneous technical and scientific information relating to aeronautics back to the United States government. Heading this office throughout the 1920s and 1930s was John Jay Ide. The document does not indicate who translated it, but it could have been Russian-born Wladimir Margoulis, a former student of aerodynamicist Nikolai Joukowski. The French-speaking Margoulis worked as an aerodynamical expert and translator for the Paris Office in the early 1920s.

What the report concerned was a demonstration of a helicopter designed by Étienne Oehmichen and built by the French automaker Peugeot. According to *L'Auto*, which covered the event, Oehmichen's machine had previously made over 70 captive flights, but the flight on 15 January 1921 marked the first time that “a free helicopter with an aviator on board” had performed successfully. Although the Fédération Aéronautique Internationale did not begin recognizing helicopter records until 1924, most aeronautical historians recognize the validity of this French claim to a “first.”

*Document 5-32, “The Oehmichen Peugeot Helicopter,”
NACA Technical Memorandum 13 (Washington, DC, 1921),
translated by the Paris Office of the NACA, March 1921.*

We stated in our issues of January 24th that a flight has been made for the first time in a free helicopter with an aviator on board, and that the flight had taken place in a pretty part of France near a district won back by the War. The helicopter was said to have been constructed by a large automobile factory, and it was a generally understood fact that this meant the firm of PEUGEOT, whose factories are installed at Valentigney, Doubs.

The machine is shown in the illustration appearing in the front page of “L'Auto,” January 26, 1921. It is not fitted with any device to permit horizontal flight or landing. It is equipped with an engine of ancient type (Dutheil-Chalmers) of more than 10 years' date. It was constructed by Engineer OEHMICHEN at the expense of the PEUGEOT firm and under the authority of its Chief, M. Robert PEUGEOT.

Messrs. PEUGEOT and OEHMICHEN did not aim at realizing “de plano” a machine that would meet all the complicated desiderata of the question. Properly speaking, it is a sort of aerial laboratory, destined to study all the sides of the question, one after the other.

We have reverted to this very important question in order to explain how M. OEHMICHEN has thought out and executed his machine, and we are now able to reproduce the following unique document, which is drawn up in the form of the Minutes of the first flight on a free helicopter, made by M. Etienne OEHMICHEN, Engineer, at Valentigney, Doubs, January 15, 1921.

THE FIRST FLIGHT

On this day, January 15, 1921, the above-mentioned engineer (Ecole Centrale, Paris), Etienne OEHMICHEN, has made a flight at the place named “Les Graviers,” in the Commune of Valentigney, Doubs, on a helicopter of his own design, comprising the following parts:

1. One frame made of reinforced wood, equipped with two recuperator propellers, Oehmichen system, 6.40 m. in diameter.
2. One two-cylinder engine, 130 bare, 120 m. stroke, Dutheil-Charmeris type (Bayard-Clement 1909), maximum power 25 HP.
3. One flexible belt transmission.

One compensating equilibrium ballonnet of 144 m.² inflated with hydrogen.

It made six ascents, entirely free, to heights varying between .50 m. and 1 m.

The average duration of the flights was one minute.

The wind, at a velocity of about 1.50 m., caused a few side-slips which did not, however, endanger the equilibrium, which was maintained constantly satisfactory in executing regular oscillations. There was no damage whatever. Extremely gentle landings were effected except in one case, which was due to a wrong movement on the part of the pilot.

Weight of machine: 260 kg.; weight of pilot: 76 kg.

Total: 326 kg.

Lifting force of balloon to be deducted: 71 kg.

Remaining load lifted by the propellers: $326 - 71 = 255$ kg.

The following gentlemen were present at the first five flights and added their signatures after the reading of the Minutes:

Messrs. BOURGEOIS, C. IENN, M. TACQUARD, FIQUET,
L. BOUTEILLER, BAILLY AND G. OEHMICHEN.

The above-named gentlemen were present at the last flight, and also the following:

Dr. DUVERNOY, doctor of medicine at Valentigney, Doubs, and Alfred CHAOURT, mechanic.

Legal witness of the above[-]named signatures:

JULES PEUGEOT, Mayor of Valentigney.

The helicopter with which Engineer Oehmichen succeeded in making a free flight on January 15th, [*sic*] is the result of patient investigations. The shape of the propeller blades is the outcome of M. Etienne Oehmichen's personal studies in animal flight. Special investigating apparatus was originated by this scholarly technician, such as the electric stroboscope, which enabled him to formulate new laws on the recuperation of energy in fluids. These laws were the subject of a communication made to the French Academy of Science, in March, 1920, of an article in the "Bulletin des Inventions," April and May, 1920, and finally of a more detailed work, entitled: "Our Masters the Birds."

The propeller shapes were not determined at random, but by the direct application of these theories. According to the author, they have been proved to be superior to any of those tested in the balance on models of reduced size and under the same conditions.

In continuation of his researches, M. Oehmichen will make experiments with stabilizing devices and will get rid of the balloon with which he has made tests so far, as we have already stated, by gradually diminishing the volume and lifting power until they are entirely canceled. He also proposes to make a series of investigations concerning translation, and these researches will be facilitated by the fact of his being already able to sustain his machine in the air.

The helicopter has, moreover, made more than SEVENTY successful captive flights, without balloon or pilot, since its construction. M. Oehmichen experienced great difficulty in the adjustment of the transmission, and this explains why the free flight tests, with a pilot on board, were made in January, 1921, instead of in November of last year, when the machine was already completed.

We may add that the S.T.Ae.—French Technical Section of Aviation—has closely followed the words of M. Oehmichen and will participate in the official tests that will shortly take place in the grounds of the Oehmichen-Peugeot Laboratory at Valentigney [*sic*],—the scene of the first flight.

In noting with great satisfaction the remarkable tests and results achieved by M. Oehmichen, Eng., we feel it to be due to the firm of Peugeot and its Chief, M. Robert Peugeot, to offer them our congratulations on their avoidance of the beaten track in devoting large sums to researches on the helicopter.

Document 5-33

Excerpt from Fred E. Weick and James R. Hansen,
*From the Ground Up: The Autobiography of an
Aeronautical Engineer* (Washington, DC, and London:
Smithsonian Institution Press, 1988), pp. 44–45.

In early 1924, Fred E. Weick, a future star researcher with the NACA then working for the U.S. Navy's Bureau of Aeronautics, traveled out from his Washington, DC, office to the airport at nearby College Park, Maryland, to watch a demonstration flight of a helicopter designed by Henry Berliner, the son of inventor Emil Berliner (1851–1929), who himself had experimented with the idea of vertical flight. In the brief excerpt from his autobiography, Weick described what he saw that day.

By the time of this particular test flight, the Berliner machine had undergone substantial modifications. Following his father's lead, Henry first designed a coaxial rotor helicopter, the rotors consisting of two fixed-pitch propellers driven by a rotary engine. Test flown in 1919–20, the design barely managed to hover and did so only with the help of an assistant on the ground who steadied it. Berliner changed the configuration to a lateral rotor but retained the fixed-pitch propellers for lift. Pitch control while hovering was supplied by a small variable-pitch propeller, which was mounted atop the aft fuselage. Lateral control was provided by vanes placed in the rotor slipstream. By closing the vanes on one side like a shutter, the pilot could accomplish a roll. Initially, Berliner opted for a pure helicopter (built around a Nieuport biplane fuselage), but by the time Weick saw it fly in early 1924, he had changed to a "helicoptane" configuration or "compound helicopter." First, he tried it as a triplane and then as a biplane; it was in this latter form that Weick saw its operation. The main reason for adding wings, stubby as they were, was to make possible a safe power-off landing, something his true helicopter could not manage. Moving from triplane to biplane form was meant largely to improve the machine's airflow, which it did. Berliner also added wingtips that could be flapped, designed for high lift coefficients that enhanced yaw control in hovering. These changes eventually resulted in a machine that performed better overall, but not in the form of a helicopter. What he had actually produced was a short takeoff and landing, or STOL, aircraft. In the summer of 1925, this simpler helicoptane finally managed to fly out of ground effects, to a height of about 30 feet. It maneuvered laterally for a distance of 400 yards and achieved a forward speed of some 40 mph. For the next two years, this machine entered a number of helicopter competitions in the United States and Europe. In the late 1920s, Berliner moved to one last configuration, one involving a single wing.

One way to interpret so many substantive modifications and the movement away from a true helicopter to a helicopter is as evidence of the great uncertainty and ambivalence surrounding the entire subject of rotary-wing aircraft in the 1920s. In his history of early helicopters, E. K. Liberatore looks at the Berliner experience in exactly this way:

Combining the work of father and son there was no greater persistence than their effort to produce a successful helicopter. The persistence is evident in the number of configurations and variations tried, all leading to a compromise to get something that worked. But the principle is unforgiving, if it cannot hover it is not a helicopter. Ideas that started out simple as the lateral rotor helicopter, ended up with wings and appendages.... The complexity plus poor performance as either helicopter or airplane would lead any rational individual to question the tractability of such a thing as a helicopter. (*Helicopters Before Helicopters*, p. 115)

If Berliner himself reached this conclusion, it should not be at all surprising that engineers not involved in rotary-wing research, who were simply observing the frustrations of helicopter designers, would also conclude, as Fred Weick must have, that vertical flight was simply too elusive and that some version of the proven fixed-wing aircraft was the way to go to provide the general STOL capabilities of the helicopter concept, minus hovering.

*Document 5-33, Excerpt from Fred E. Weick and James R. Hansen,
From the Ground Up: The Autobiography of an Aeronautical Engineer
(Washington, DC, and London: Smithsonian Institution Press, 1988), pp. 44–45.*

One occasion that I especially remember from my early days in Washington was a demonstration flight of the Berliner helicopter. This happened at College Park Airport in Maryland, the oldest continuously operating flying field in the country and probably in the world; Orville Wright had given flying lessons there to some army personnel in 1908. Up to this time, as I remember it, no helicopter had been flown in free flight, although some had lifted themselves while tethered. On this day Gen. Mason Patrick, head of the Army Air Service, and Admiral Moffett, chief of the Bureau of Aeronautics, were both present, along with a number of their staff. My boss, Lieutenant Shoemaker, was good enough to take me.

The helicopter was equipped like an airplane, with very small biplane wings so that it could glide to a landing in case of motor failure. As stated earlier, two large balsawood propellers were employed, one above each wing tip; they turned in opposite directions so that the torque from the two propellers would be counteracted. A rotary engine drove the props through a differential gear arrangement. Lateral control, a small controllable-pitch propeller, also driven by the rotary engine, was fitted at the rear near the tail surfaces.

The flight was made by Army Air Service pilot Lt. Harold R. Harris, a friend of Henry's and already a legendary army pilot. But before he could lift off, we had to wait for father Emil Berliner to arrive in his chauffeur-driven Pierce-Arrow. As soon as this occurred, Harris started the engine and flew the helicopter straight up to a height of possibly 12 or 15 feet and hovered there for quite some time. The pilot made slight excursions back and forth a few feet in several directions, but never went very far. He landed satisfactorily and then made a few similar flights. The brake for lateral control operated but was a bit sluggish; Henry later improved it by eliminating the differential action and adding flap-like ailerons to the main lifting propeller blades themselves. Limited though it was, this performance by Berliner's machine was better, I believe, than that by any other helicopter up to that time.

After the flight an interesting incident occurred. As Lieutenant Harris came toward our group, various members started congratulating him and shaking his hand. Harris was beaming and reached out his hand to the next man, who happened to be General Patrick. The little, prim general stood there stiffly at attention, waiting to be saluted. Everyone else was somewhat embarrassed.

Document 5-34

Excerpts from Alexander Klemin, “An Introduction to the Helicopter,” NACA Technical Memorandum 340 (Washington DC, 1925).

Following its publication of Warner’s “The Problem of the Helicopter” as Technical Note 4 in May 1920, the NACA published a number of reports on European helicopter developments, but little besides. In part, this was because the NACA laboratory itself was doing little direct helicopter research, except for some testing involving a propeller-type rotor in forward flight. In 1925, however, came another major paper. Its author, Dr. Alexander Klemin (1880–1950) was the director of the Daniel Guggenheim School of Aeronautics at New York University and one of the earliest and strongest proponents of the vertical-lifting machine. As the clearly presented technical contents of his paper indicated he might, Klemin also quickly became one of the leading educators on the subject.

Klemin began his presentation with an outline of the helicopter problem that was even clearer than Edward P. Warner’s of five years before: “To achieve utility, the helicopter must climb vertically with a moderate degree of useful load; attain a reasonable ceiling; achieve vertical descent with engines in action; achieve safe descent—if not vertically, then at least on a steep path with dead engine; have a reasonable speed in horizontal flight; be fairly stable and completely controllable; and have reasonable assurance of correct functioning of its mechanism.” Then, in a complete, step-by-step analysis carried out over the length of 57 pages (most of them included here), Klemin explained how all these elements can be achieved. Throughout, it is clear that Klemin had tremendous confidence that not only was the helicopter a practical technology, but its achievement was “within measurable distance,” and well “worthy of serious consideration.”

Klemin originally presented the ideas in this NACA report of 1925 at the annual meeting of the American Society of Mechanical Engineers, held in New York City in December 1924. A few weeks before that, in mid-November 1924, the meat of his talk had also appeared in the journal *Mechanical Engineering*.

Document 5-34, Excerpts from Alexander Klemin, "An Introduction to the Helicopter," NACA Technical Memorandum 340 (Washington DC, 1925).

The helicopter or direct-lift type of aircraft has many enthusiastic supporters, and the achievement of vertical ascent, vertical descent, and hovering are beyond doubt of real interest. In spite of numerous flights already made with this type of aircraft, it is difficult to say at the moment whether we have, in the present-day helicopter, the first stages of a valuable type of flying machine, or merely a forced idea. There is, however, a possibility of ultimate success, and investigation should undoubtedly be continued till a definite solution is reached.

It is the object of this report to review briefly the aerodynamic and construction data already available and to set forth the difficulties which must be met.

To achieve utility, the helicopter must climb vertically with a moderate degree of useful load; attain a reasonable ceiling; achieve vertical descent with engines in action; achieve safe descent—if not vertically, then at least on a steep path with dead engine; have a reasonable speed in horizontal flight; be fairly stable and completely controllable; and have reasonable assurance of correct functioning of its mechanism. In these requirements we have the outline of the whole subject.

NOTATION

D = diameter of an airscrew, ft.

A = disk area or area swept out by blades of an airscrew, sq. ft.

n = r.p.s.

V = velocity, ft. per sec.

ρ = 0.00237 = absolute density of standard air per cu. ft.

T = thrust of an airscrew, lb.

T_c = thrust coefficient, such that $T = T_c n^2 D^4$

Q = torque of an airscrew, ft.-lb.

Q_c = torque coefficient, such that $Q = Q_c n^2 D^5$

P = work in ft.-lb. imparted to an airscrew per sec.

P_c = power coefficient, such that $P = P_c n^3 D^5$

K_f = ratio between actual lift secured from an airscrew, and theoretical lift on the Froude momentum theory = $0.1273 T_c^{3/2} / Q_c$

R = aerodynamic resistance in lb.

K = coefficient of resistance, referred to the disk area of an airscrew, such that $R = KAV^2$, when the disk is perpendicular to the line of motion.

K_L = coefficient of lift, referred to the disk area of an airscrew, such that the force perpendicular to the line of motion $L = K_L AV^2$

K_D = coefficient of drag, referred to the disk area of an airscrew, such that the force along the line of motion $D = K_D AV^2$.

i = angle of incidence to the flight path of the plane of rotation of an airscrew.

θ = angle of glide in oblique descent.

I. LIFTING AIRSCREWS

Obtaining a large thrust/power ratio with a lifting airscrew is not the solution of the helicopter, and is in fact one of the requirements most readily achieved. Without going into the detail design of the lifting airscrew, we shall investigate the theoretical limit of this ratio, and see how closely it has been approached in actual design.

Thrust/Power Ratio in a Perfect Fluid. Froude's momentum theory may be readily applied for a perfect fluid, that is, one in which the blades offer no aerodynamic resistance. The fundamental conception is that the air above the hovering airscrew starts from rest, approaches it with a velocity V_1 in a stream equal in area to that of the circular disk swept out by the blades, and below the airscrew passes on with a greater velocity V_2 in a contracted stream as shown in Fig. 1. The mass of air dealt with by the airscrew per unit of time is $\rho\left(\frac{\pi D^2}{4}\right)V_1$, and since the final velocity is V_2 , the thrust

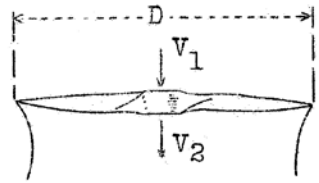

FIG. 1. Diagram to illustrate the Froude momentum theory, as applied to a lifting airscrew.

$$T = \rho\left(\frac{\pi D^2}{4}\right)V_1V_2$$

The work done by the airscrew on the air is TV_1 and is equal to the kinetic energy of the air in the contracted stream (since there are no aerodynamic losses). Therefore, the power expended

$$P = TV_1 = \rho\left(\frac{\pi D^2}{4}\right)V_1^2V_2 = \rho\left(\frac{\pi D^2}{4}\right)V_1\left(\frac{V_2^2}{2}\right)$$

It follows that $V_1 = \frac{V_2}{2}$, and also that $\frac{T}{P} = \frac{1}{V_1} = \frac{2}{V_2}$. From this we see that the thrust/power ratio increases as the velocity of the air driven through the propeller decreases. Also, the greater the diameter and disk area, the less the air velocity and the greater the value of thrust/power.

$$\text{If } A = \frac{\pi D^2}{4}, \frac{1}{V} = \sqrt{\rho\left(\frac{\pi D^2}{4}\right)\left(\frac{2}{T}\right)} = \sqrt{2\rho} \frac{1}{\sqrt{T}}$$

and

$$\frac{T}{P} = \sqrt{2\rho} \frac{1}{\sqrt{T}}$$

a mathematical expression indicating that the thrust/power ratio varies inversely as the square root of the thrust loading/disk area.

Correction Factor for an Imperfect Fluid. The theoretical value of T/P can never be attained. To determine the value of any lifting airscrew, we must find the value of a correcting factor K_f such that

$$\frac{T}{P} = K_f \sqrt{2\rho} \frac{1}{\sqrt{\frac{T}{A}}}$$

K_f depending on the aerodynamic characteristics of the propeller.

Characteristics of Geometrically Similar Propellers. For geometrically similar propellers, K_f is a constant, and determines fully the "efficiency" of the airscrew. It is sometimes more convenient to use the following relationships, however:

$$\begin{aligned} T &= T_c n^2 D^4 \\ Q &= Q_c n^2 D^5 \\ P &= P_c n^3 D^5 \end{aligned}$$

where T and T_c are thrust and thrust coefficient, respectively; Q and Q_c , torque and torque coefficient; P and P_c , power and power coefficient; and n , r.p.s.

It follows that

$$\frac{T}{P} \propto \frac{1}{nD}$$

This relationship indicates that the tip speed (πND) should be as low as possible to give a high value of $\frac{T}{P}$. For a constant thrust $D = \sqrt[4]{\frac{T}{T_c \rho n^2}}$, so that if n is decreased, D decreases proportionately less, and the product nD decreases. Hence it is advantageous to decrease n and increase D as far as practicable, a conclusion agreeing with the Froude momentum theory.

Comparison of Different Types of Propellers. For a helicopter airscrew it is desirable that for a given thrust and power, the diameter be as small as possible; that to keep down gear-reduction ratios, n be as high as possible; and that to keep down centrifugal effects, n be small. These are somewhat conflicting requirements. Also other considerations enter such as characteristics of the airscrew in climb, descent, and forward flight. But in the preliminary selection of an airscrew (T/P) for any given disk loading, the value of K_f is the readiest basis of comparison.

Since experimental results are generally given in terms of T_c and Q_c , it is convenient to relate K_f with them. It can be shown that

$$K_f = \frac{T_c^{3/2}}{Q_c \pi^{3/2} \sqrt{2}} = \frac{0.1273 T_c^{3/2}}{Q_c}$$

and this relationship shows that the value of T_c/Q_c is not a sufficient criterion.

Some Experimental Results. An enormous amount of experimental work has been done on airscrews working at a fixed point, with every kind of blade form, pitch, etc. Characteristics of a few representative propellers are given in Table I to indicate what the values of K_f , T_c and Q_c are at the present time.

TABLE I. Characteristics of Some Lifting Propellers.

Authority	Description of Propeller	T_c	Q_c	K_f
A. Fage & H.E. Collins, N.P.L.	Four-bladed, flat under-surface, chords of blade sections parallel to each other, plan form widening toward the tip, angle of blade 9.75 deg. Pitch diameter ratio 0.49.	0.08640	0.00600	0.536
A. Fage & H.E. Collins, NPL.	Two-bladed propeller, similar to above, angle of blade 12.55 deg.	0.07200	0.00526	0.517
W.F. Durand & E.P. Lesley, NACA.	Propeller No. 5, two-bladed pitch ratio 0.9, mean blade width 0.2 r	0.15100	0.01105	0.680
W.F. Durand & E.P. Lesley, NACA.	Propeller No. 44, two-bladed pitch ratio 0.7, mean blade width 0.27.	0.16700	0.01180	0.740

It is remarkable how near to the theoretical lift, [*sic*] the Durand & Lesley Propeller No. 44 approaches, although it was not designed for helicopter use. In the curve of Fig. 2, for Durand 44 and constant 100 HP, lift in pounds is plotted against diameter. Disregarding the weight of the airscrew itself it is clear that any desired lift can be readily achieved with a given horsepower, if the size of the airscrews is not limited, and if adequate gear reduction is introduced between the high-speed engine and the airscrews, which must be slow to be efficient.

Tandem Airscrews. No very reliable data are available for tandem airscrews. In some of Klingenberg's experiments a screw of 8 m diameter gave 200 kg (440 lb.) lift with 34 HP; a screw of 6 m diameter gave 200 kg

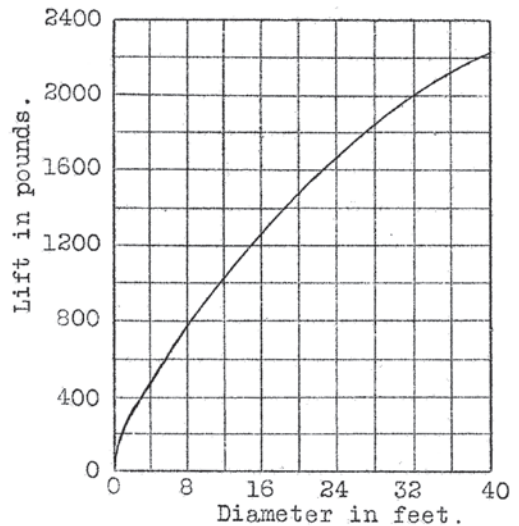

FIG. 2. Lift in pounds plotted against diameter for Durand propeller No. 44 with constant 100 HP.

lift with 42 HP.; the combination of the two in tandem, with the smaller airscrew placed in the contracted airstream of the larger airscrew, gave a lift of 430 kg with only 69 HP.

II. CLIMB

The helicopter airscrew must do more than provide lift; it must be capable of giving reasonable climb and ceiling. The regime of the helicopter airscrew in vertical climb coincides with that of an airplane propeller working at a very low value of forward velocity. It does not follow that the airscrew which gives the highest lift for a given horsepower and diameter, will always be the best for climb—its properties for various values of V/nD must be studied. There is no doubt also that a variable-pitch airscrew would be needed in achieving the best results. Another question to be studied is whether vertical or oblique climb is likely to be most effective.

A Calculation for Vertical Climb. One of the propellers studied by A. Fage and H. E. Collins is sufficiently typical for an illustrative calculation. This is a four-bladed propeller with a constant blade angle of 9.9 deg. Its characteristics are as given in Table II.

TABLE II. Characteristics of Typical Four-Bladed Propeller.

	$\frac{V}{nD}$	T_c	Q_c	$\frac{\text{Thrust in lb.} \times Dn}{\text{Horsepower}}$
Descent	-0.204	0.1010	0.00720	1,230
	-0.182	0.1040	0.00726	1,250
	-0.159	0.1050	0.00757	1,215
	-0.130	0.1070	0.00736	1,270
	-0.087	0.1075	0.00765	1,230
	-0.061	0.1080	0.00759	1,240
Hovering	0	0.1015	0.00743	1,190
Climb	+0.082	0.0930	0.00684	1,190
	+0.135	0.0348	0.00650	1,140
	+0.269	0.0563	0.00525	940
	+0.289	0.0538	0.00493	955
	+0.301	0.0485	0.00479	885

If employed on a 2000-pound helicopter, 100 HP. would be sufficient to sustain this machine with $n = 1.23$ r.p.s., $D = 48.4$ ft., and $Q = 7150$ ft.-lb. (neglecting all gear losses).

Suppose it is required to secure an initial climb of 10 ft. per sec., or 600 ft. per min. The resistance of the rest of the helicopter to vertical motion may be neglected at this low speed, and the thrust remains constant at 2000 lb. No exact mathematical solution is possible, but a ready method of calculation is obtained by assuming values of n greater than 1.23—since with constant thrust and positive values of V/nD , T_c diminishes and n must increase. When $n = 1.4$, $V/nD = 0.147$. By interpolation from Table II, $(T/P) Dn = 1100$ and $T/P = 16.3$, so that 123 HP. is required, and a torque of 7700 ft.-lb. If no variable-speed reduction is included in the transmission system, this means that the engine would have to deliver the 100 HP. required for sustentation, throttled down to some extent. If the maximum horsepower employed were about 150 HP., there would not be the slightest difficulty in meeting this condition. Provided always that in a helicopter the maximum horsepower is not designed to give mere sustentation, there is apparently no difficulty in securing adequate vertical climb. In vertical climb the helicopter has the inherent advantage over the airplane that it has no great aerodynamic resistance to overcome—the power goes directly into work against gravity.

Ceiling. Since the lift or thrust in hovering flight at ceiling is the same as at ground level, and $T = \rho T_c n^2 D^4$, $\rho n^2 = \text{a constant} = C$, and $n = \frac{C}{\sqrt{\rho}}$. And since $P = \rho P_c n^3 D^5 = \rho P_c \frac{C^3}{\rho^{3/2}} D^5 = \frac{P_c C^3 D^5}{\sqrt{\rho}}$, the power required to maintain hovering flight varies inversely as the square root of the density. For an airplane, minimum power at same altitude likewise varies inversely as the square root of the density. As a first approximation it may be assumed, therefore, that if the ratio (available horsepower/minimum power required at ground) of the airplane is equal to the ratio (available horsepower/minimum power required at ground) of the helicopter, the ceilings of the two types of aircraft will be approximately the same, though in all probability the helicopter will reach its ceiling far more quickly.

Oblique Climb. It has been found in a number of laboratories that when an airscrew is working in a side wind, the coefficient of thrust increases, while the coefficient of torque diminishes as compared with the torque and thrust coefficients *au point fixe*.

For example, in Durand and Lesley's experiments on propellers in yaw, the figures given in Table III obtain for propeller No. 5.

It is seen that the power required diminishes considerably in the side wind at high values of V/nD . For 85 deg. yaw there is in addition the advantage of a forward component of the thrust. The same effects persist with larger angles of yaw. From experiments such as these, a number of writers have concluded that a helicopter could lift itself from the ground with less power in a side wind and also climb better on an oblique path, with the plane of rotation at a negative angle to the flight path.

TABLE III. Air Propellers in Yaw.

$\frac{V}{nD}$	Angle of yaw	T_c	Q_c	Ratio of power for same thrust as at $V/nD = 0$, yaw = 90 deg.
0	90 deg.	0.151	0.01105	1.0
0.373	90 deg.	0.151	0.01050	0.942
1.91	90 deg.	0.261	0.01495	0.762
0.372	85 deg.	0.1611	0.01122	0.925
1.58	85 deg.	0.2145	0.01500	0.785

But Durand and Lesley specifically state that they were not in a position to measure the forces perpendicular to the axis of rotation which must inevitably arise in a side wind. Riabouchinsky has fortunately made some tests in side winds, with angle of incidence of the plane of rotation held at zero, however, in which the lateral component was measured.

Some illustrative results are taken from these tests and given in Table IV for a small airscrew of 25 cm (10 in.) diameter.

TABLE IV. Data of Test of a 10-inch Airscrew.

$\frac{V}{nD}$	V (m/sec.)	n , r.p.s.	T (kg)	P , work (kg-m)	R , Lateral resistance (kg)	RV , work required to overcome lateral resistance	Total work $P + RV$, (kg-m)
0	0	20.0	0.0240	0.0740	0	0	0.07400
0.726	3	16.5	0.0240	0.0640	0.00250	0.00750	0.07150
0	0	11.6	0.0081	0.0162	0	0	0.01620
3.020	6	7.9	0.0081	0.0139	0.00410	0.02466	0.03856

While Riabouchinsky's experiments were conducted on inefficient propellers, nevertheless the approximate conclusion may be drawn that less total power is required in a side wind only at small values of V/nD . With large values of V/nD the lateral resistance becomes large enough to offset the apparently advantageous effect of the side wind.

Granted even that a helicopter could get off the ground with a little less power, if it started off with some lateral velocity, the author sees no particular advantage in this. A helicopter which has so little reserve power as to necessitate such a maneuver to get off, would be useless.

It is possible also that by making a get-away at a high lateral speed, the diameter of the airscrews might be somewhat reduced because of the higher thrust

coefficients. But in that case we would be departing from the fundamental advantages of the helicopter, and devising an inefficient equivalent of the airplane.

For much the same reasons the author sees no possibility of securing better climb by flying on an oblique path of moderate steepness. Particularly, since with the helicopter climbing on an oblique path the parasite resistance of the craft would be much greater than in vertical ascent. It is just possible that better climb might be secured by rising on a very steep path than by vertical ascent, but this seems contrary to the “instinct of mechanics.”

III. VERTICAL DESCENT WITH DEAD ENGINE

Limit for Speed in Vertical Descent. The limit of speed will be fixed by (1) physiological considerations, (2) by the factor of safety of the helicopter structure, and (3) by the character of the shock-absorbing mechanism. Damblanc estimates the possible limit as 5 m (16.4 ft.) per sec. This seems large until it is considered that this corresponds to a vertical fall under gravity of only a little over 4 ft. Pilots in airplanes seem to be able to stand violent accelerations with ease, and with careful design of the shock-absorbing system it should be permissible to design for a vertical velocity of some 16 ft. per sec.

Theoretical Limits of Resistance Coefficients in Vertical Descent. If the Newtonian hypothesis were admissible, and particles of air striking a disk perpendicular to the wind were deflected at right angles to their original path, then the resistance of the disk would be ρAV^2 . Hence in the equation $R = K\rho AV^2$, K would be equal to 1. This is evidently the maximum value which could ever be secured for K . But the air meeting a disk separates and flows past it, and the resistance coefficient has only a value of 0.6. The resistance coefficient of a parachute is approximately 0.7 based on its projected area, and the parachute approximates a hollow hemisphere, and evidently captures the air very effectively.

It seems difficult to conceive of any airscrew or windmill exceeding or even approaching this value of 0.7. It is useful to examine the resistance of a windmill—which for our purposes may be termed an airbrake—on the basis of Froude’s momentum theory. In Fig. 3 the column of air is conceived as approaching the airscrew with a velocity V in a stream somewhat narrower than the disk diameter, reaching the screw with a velocity V_1 , receiving an instantaneous increase in pressure, and finally resuming the initial pressure at a smaller velocity V_2 . From considerations of momentum[:]

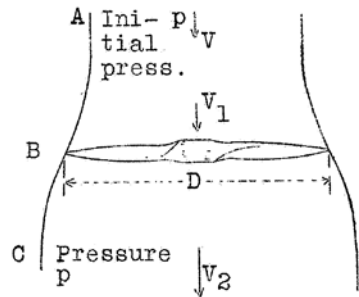

FIG. 3. Diagram to illustrate the Froude momentum theory as applied to an airbrake.

$$T = \rho \frac{\pi D^2}{4} V_1 (V - V_2)$$

Assuming Bernoulli's equation to hold from A to B, and from B to C, the pressures on the two sides of the airscrew disk will be $p + \rho \frac{V^2}{2} - \rho \frac{V_1^2}{2}$ and $p + \rho \frac{V_2^2}{2} - \rho \frac{V_1^2}{2}$. Hence $T = \rho \frac{\pi D^2}{4} (V^2 - V_2^2)$. Equating the two expressions for T , it is found that $V_1 = \frac{V + V_2}{2}$, (also that $V_1 - V_2 = \frac{V - V_2}{2}$, so that decrease in velocity of the air column before it reaches the airscrew is equal to subsequent decrease). Eliminating V_1 in the first expression for T , it is found that $T = \rho \frac{\pi D^2}{4} \left(\frac{V^2 - V_2^2}{2} \right)$. If $V_2 = 0$, $T = \rho \frac{\pi D^2}{4} \frac{V^2}{2}$ or $K = 0.5$. K seems very small, particularly as frictional losses are here neglected, and in actual experiments this value of K has been exceeded. Probably this is due to the fact that while the column of air before the disk is considered as narrower than the disk diameter, in reality an air stream of greater diameter may be affected. Also in the Froude momentum theory the whole mass of air affected is considered as passing through the disk while in reality some of it may flow round the edges as in the case of a flat plate. Also, the theory does not take in the possibility of rotational motion being imparted to the air. Applications of the vortex theory will bring theoretical and experimental values closer together. The Froude momentum theory does indicate, however, that even skilled design of airbrakes will not give very much higher values of K than 0.5.

Even if a coefficient of 0.6, equal to that of a flat plate, is secured, helicopter diameters remain extremely large for reasonable terminal velocity in vertical descent. Thus for a 2000-pound helicopter, if $K = 0.6$, $V = 16$, and $\rho = 0.00237$, then $D = 83.5$ ft. diameter; or if two airscrews are employed, each one must have a diameter of 59.4 ft.

Tandem airscrews are likely to be a very poor combination for vertical descent. Eiffel has shown that two flat plates perpendicular to the airstream and in tandem may have a combined resistance of less than that of one plate (the rear disk, under the action of the suction of the forward disk[,]) may actually experience a negative resistance), and the same result is likely to occur for a tandem airscrew brake.

In a tandem airbrake, if the lower screw of the combination retards the column of air efficiently, there is little energy left to act upon the upper airscrew. If V_2 is the velocity of the air when it reaches the upper screw, its thrust on the Froude momentum theory will be given by the expression $T = \rho \frac{\pi D^2}{4} \left(\frac{V_2^2 - V_3^2}{2} \right)$, where V_3 is the final velocity after passing through the second airscrew. Hence the total thrust of the combination will be $\rho \frac{\pi D^2}{4} \left(\frac{V^2 - V_2^2}{2} \right) + \rho \frac{\pi D^2}{4} \left(\frac{V_2^2 - V_3^2}{2} \right)$ and can never exceed $\rho \frac{\pi D^2}{4} \frac{V^2}{2}$ or give a resistance coefficient greater than 0.5.

Resistance Coefficients of Normal Airscrews in Vertical Descent. Supporters of the helicopter have maintained that normal lifting airscrews would give sufficient parachutal effect in vertical descent without power.

This is not substantiated by experimental values. There are three conditions to be considered: (a) when the airscrew is held, (b) when it is rotating as a windmill in a positive or normal direction, and (c) when it is rotating as a windmill in a negative direction. On vertical descent, an airscrew is not likely to act as a windmill rotating in a positive direction, unless it has a very low pitch, but condition (c) is likely to be realized at certain values of V/nD . Condition (c) is illustrated in Fig. 4.

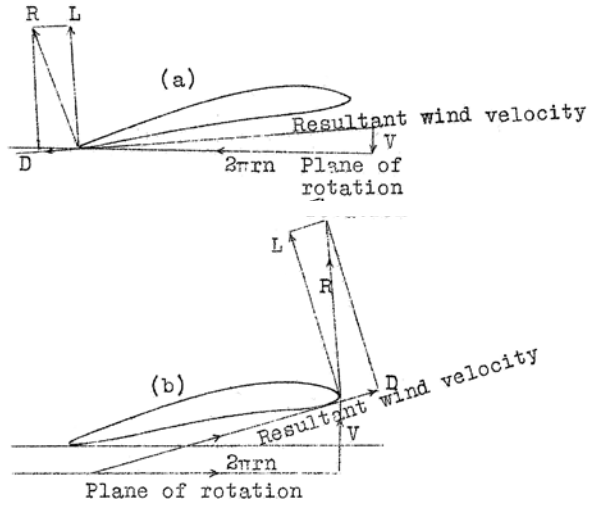

FIG. 4. Action of blade element of a normal airscrew on vertical descent. (a) Air forces on an element of a normal airscrew in vertical ascent; positive direction of rotation; power supplied. (b) Air forces on an element of a normal airscrew in vertical descent; R exercises a torque producing a negative rotation; rear edge meets the resultant wind.

On theoretical grounds, no very large resistance coefficient can be expected from either condition (a) or condition (b). Under condition (a) we simply have the resistance to forward motion of stationary blades, whose combined area is only a fraction of the disk area of the airscrew. Under condition (b) we may expect better values, but unfortunately the air now meets the rear edge instead of the forward edge of the airfoil blade element.

Some experimental results for various conditions of working are given in Tables V, VI, and VII.

These results indicate quite clearly that the parachutal effect of the fixed helicopter airscrew in vertical descent would be negligible in practice. The values for fixed airscrews with the upper surface into the wind are given merely for comparison.

From Tables VI and VII it is clear that a normal airscrew, acting as a windmill, will not exercise its maximum braking effect when the torque is zero. Provided a torque is introduced, a low-pitch airscrew will develop quite an appreciable braking effect, approximately half that of the best drag coefficient obtained with specially designed windmill brakes. It might be possible to do better on descent with lower pitches and specially selected blade elements, but this would decrease lift efficiency; as it is, even with the highest value of the drag coefficient in Table VII, a diameter

TABLE V. Drag Coefficients of Normal Fixed Airscrews.

Designation of airscrew	Authority	Surface into the wind	Drag coefficient <i>K</i> referred to disk area of airscrew
4-bladed normal airscrew, pitch/diameter ratio 0.7	C.N.H. Lock & H. Bateman N.P.L.	Upper	0.074
4-bladed airscrew "A", blade angle 2° (Windmill)	Lock & Bateman	Under	0.099
2-bladed airscrew "B", blade angle ½° (Windmill)	Lock & Bateman	Under	0.063
2-bladed airscrew, relative pitch 0.4	W. Margoulis	Upper	0.0442
		Under	0.0525
2-bladed airscrew, relative pitch 0.8	W. Margoulis	Upper	0.0465
		Under	0.0610

TABLE VI. Normal Airscrews in Vertical Descent Turning Freely as Windmills with no Torque.

Designation of airscrew	Authority	Direction of rotation (Positive is normal)	$\frac{V}{nD}$	Drag coefficient referred to entire disk area
2-bladed airscrew No. 1, relative pitch 0.4	W. Margoulis	negative	0.3	0.1130
2-bladed airscrew No. 2, relative pitch 0.8	W. Margoulis	negative	0.55	0.123
2-bladed airscrew No. 2, relative pitch 1.2	W. Margoulis	negative	0.93	0.0167

TABLE VII. Three Margoulis Airscrews, Relative Pitch 0.4, 0.8, and 1.2, in Vertical Descent as Windmills, with Some Torque Effect.

No. 1		No. 2		No. 3	
$\frac{V}{nD}$	Drag coefficient	$\frac{V}{nD}$	Drag coefficient	$\frac{V}{nD}$	Drag coefficient referred to disk area
0.3	0.1130	0.55	0.123	0.93	0.0167
0.4	0.2560	0.60	0.131	1.00	0.02460
0.5	0.288	0.70	0.124	1.10	0.0417
0.6	0.305	0.80	0.131	1.20	0.0550
0.7	0.278	0.90	0.135	1.5	0.0565
0.8	0.252	1.0	0.124		
1.0	0.200	1.1	0.116		
1.5	0.091	1.3	0.094		
		1.5	0.077		

of 117.5 ft. would be required to give a speed of descent of 16 ft. per sec. for a 2000-pound airplane. The use of a normal airscrew without pitch variation does not seem a practical method of securing vertical descent.

Drag Coefficients of Specially Designed Windmills. Fig. 5 indicates that with a negative blade setting an airscrew in vertical descent will rotate in a positive direction as a windmill, with the resultant wind striking the blade at an efficient angle. Accordingly the plan has often been suggested that the settings of the blades of the airscrew should be varied in vertical descent, and a number of experiments have been tried with windmills specially designed to give a large drag coefficient, but the only published results seem to be those of Lock and Bateman.

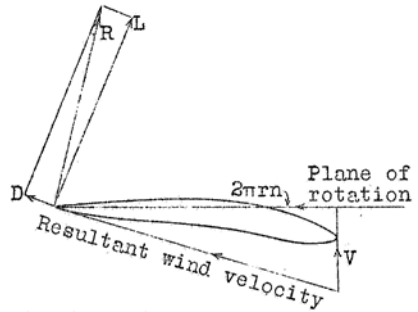

FIG. 5. Action of blade element of a windmill brake on vertical descent.

The experiments were made on two normal airscrews "A" of two and four blades, of pitch diameter 0.3, in which the blades could be rotated, and a special windmill "B." In the airscrews "A" the blade angle at $0.6 r$ from the center was taken as defining the blade angle, the normal blade angle at this point being 9° . In airscrew "B," which was specially designed as a brake-windmill, a pair of rectangular brass airfoils measuring $2\frac{1}{2}$ inches by 15 inches were attached by a pair of short brass spindles to the aluminum boss, thus making a two-bladed airscrew of diameter 3 ft., in which the chord, section and blade angle were constant along the blade, while the blade angle could be adjusted by rotating the blades. This gave a more suitable type of brake-windmill than "A" when rotated, and one of less peculiar shape. The results are summarized in Table VIII.

From these results it is evident that a two-bladed airscrew will answer quite as well as a four-bladed airscrew as far as drag coefficient in vertical descent is concerned. There is evidently no difficulty in securing a drag coefficient nearly that of a circular disk, namely, 0.6. Further, a drag coefficient of nearly this value can actually be secured with a small positive setting for the blade angles or very low pitch—in agreement with the Margoullis tests.

An important difference between these windmill tests and those of Margoullis on normal airscrews in vertical descent lies in the variation of drag with torque. For normal airscrews rotating in a negative direction on vertical descent, it appears to be necessary to introduce a braking torque on the airscrew shaft to secure high values of drag coefficient. For these windmills the drag coefficient seems to be almost independent of the braking torque—an important practical point, since it might thus be unnecessary to disconnect the dead engine when changing the angle of incidence.

TABLE VIII. Experiments on Airscrews.

Blade angle setting* deg.	Rotation	$\frac{V}{nD}$	Drag coefficient referred to disk area	Remarks
<i>4 Bladed Airscrew "A" at Zero Torque</i>				
-6	positive	0.504	0.422	—
-3	positive	0.516	0.500	—
0	positive	0.557	0.550	—
+2	negative	0.556	0.560	—
—	positive	0.618	0.562	—
—	negative	0.487	0.553	—
—	stopped	0	0.099	—
<i>2-Bladed Airscrew "B" at Zero Torque</i>				
-6	positive	0.294	0.387	—
-3	positive	0.283	0.572	—
-1	positive	0.323	0.592	—
-½	positive	0.332	0.597	—
—	stopped	0	0.063	—
<i>2-Bladed Airscrew "A," with Braking</i>				
-6	positive	0.406	0.338	Zero torque
—	positive	0.450	0.343	Braking
—	positive	0.487	0.342	Braking
0	positive	0.409	0.537	Zero torque
—	positive	0.432	0.526	Braking
—	positive	0.508	0.421	Braking
—	negative	0.407	0.540	Zero torque

* At 0.6 r for airscrews "A."

The fact that K only varies slightly with the number of blades is in agreement with unpublished results of experiments in which a multiple-blade windmill was tried out.

Manipulation of the Airscrew to Decrease Rate of Vertical Descent. It has been suggested by a number of writers that by a process analogous to the flattening out of an airplane after a glide, the angle of the airscrew blade might also be manipulated on landing. On the descent, the blades would be rotated to a small negative angle with the plane of rotation so as to secure the maximum drag coefficient. Shortly before landing the pilot would place the blades at a positive angle to the

plane of rotation, when the inertia of the airscrew would maintain rotation, and it would behave again as a lifting screw. This seems to be a very practical and promising suggestion, and if lifting airscrews are indeed provided with a variable-pitch mechanism, there is no reason why this maneuver should not be resorted to; if practical, the diameter of the airscrew could be cut down.

When an airplane engine stalls at get-away near the ground, the pilot may have but little time to bring his machine to a gliding attitude. If the helicopter engine stalls near the ground, the difficulty will be equally great. Reliable and very rapid control of the variable-pitch mechanism will be required. Clutches may also be necessary, so that the engine may be instantaneously disconnected when the airscrew is converted into a windmill, and zero torque is required to secure the greatest drag coefficient.

IV. OBLIQUE DESCENT WITH DEAD ENGINE

Since even with a specially designed brake-windmill only a drag coefficient of 0.6 is attainable, and large diameters are necessary in vertical descent, it is natural to examine the possibility of oblique descent, with the plane of rotation of the airscrew inclined to the flight path like the wing of an airplane on a glide, and the airscrew either fixed or rotating like a windmill in a side wind.

Oblique Descent with Fixed Airscrews. Margoulis experimented with the previously mentioned airscrew of pitch-diameter ratio 0.8. The airscrews were placed with the plane of rotation at 0, 15, 30, 60 and 90 degrees incidence to the flight path. The coefficients of lift and drag referred to the total disk area of the propeller were as given in Table IX. Since the forces on the airscrew vary with the exact position in which the airscrew is held, the values in Table IX are mean values of three different positions.

TABLE IX. Margoulis' Airscrew Experiments.

Incidence in deg.	0	15	30	60	90
K_L referred to disk area	0.00075	0.0206	0.0237	0.00134	0.0
K_D referred to disk area	0.02580	0.0330	0.0432	0.05860	0.0610
L/D	0.029	0.625	0.55	0.226	0.0

With such values the glide paths would always be exceedingly steep; and as a matter of fact, the lowest vertical component of velocity would be slightly greater than on direct vertical descent at 90 deg. incidence with airscrew fixed.

These unfavorable results might well have been expected; a fixed airscrew on a glide with its broken-up and unsymmetrically disposed surfaces could not possibly be as efficient as an ordinary wing surface of equal area. Also to seek improvement by reversing one of the blades on the glide would be futile.

Oblique Descent with Airscrew Rotating as a Windmill. With the same airscrew of pitch-diameter ratio 0.8, Margoulis experimented with the airscrew rotating as a windmill in oblique descent. In vertical descent $V = \sqrt{(W/\rho A)} \sqrt{(1/K_D)}$; in oblique descent the vertical component of velocity is given by the formula $\sqrt{(W/\rho A)} \sqrt{(\cos \theta \sin^2 \theta / K_I)} \sqrt{(1/K_D)}$ and $\sqrt{(\cos \theta \sin^2 \theta / K_I)}$ are accordingly calculated in Table X.

Equilibrium, of course, is possible only where the torque is negative, so that a glide is not possible at either 0 or 15 deg. It is quite clear from Table X that the glide path in oblique descent would always be very steep with the airscrew in question, and that the least vertical velocity would be secured in vertical descent. It would seem from this that a descent on a gliding path with a normal airscrew would not be promising. It is therefore necessary to investigate oblique descent with variable-pitch airscrew.

Oblique Descent with a Windmill Type of Airscrew. No experiments are available for a windmill on oblique descent except those for La Cierva's Autogiro.

A model of this, a four-bladed airscrew, Göttingen 429, in section for blade elements, with each blade at 2 deg. to the plane of rotation, diameter of airscrew 1.1 m (43.3 in.), width of blades 8 cm (3.15 in.), was tested with the plane of rotation at

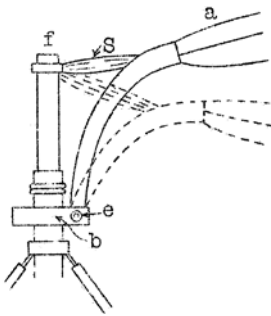

FIG. 6. Principle of La Cierva's autogiro. (The wings are fixed to a piece b, by means of hinges e, so that they are free to move as shown in the diagram. The piece b turns freely about the axis f. S are elastic shock absorbers limiting the downward motion of the wings.)

various angles of incidence to the forward wind, and the screw mounted freely in its bearings. The peculiarity of La Cierva's device is that each blade is flexibly connected to the axis of rotation, as shown in Fig. 6. Therefore, although but one airscrew is used, and the blade going into the wind meets a greater air velocity and experiences more lift, no banking effects are apparently produced in straight flight, the resultant force of each blade always passing through one point. The blade turning into the relative wind rises, however, until the centrifugal force, the weight of the blade, and the lift are all in equilibrium. The blades remain at the same angle of incidence to the plane of rotation during the peculiar feathering motion of the airscrew, but no doubt the rising of a blade tends to decrease its effective angle of incidence, and reduces the variation in lift. It is unfortunately impossible, in the scope of this report, to analyze the peculiar action of the blade and the varying aerodynamic conditions at each point on the path of rotation.

Even the action of an ordinary windmill, moving in a horizontal wind with its axis inclined to the path, is difficult to analyze, as indicated by the diagram of Fig. 7. Unlike a windmill rotating with its axis parallel to the line of motion, the windmill with its axis oblique to the motion may have its blades at one point of the circle

TABLE X.

Angle of incidence $\frac{V}{nD}$	K_D	K_L	Angle of glide, θ deg.	$\sqrt{\frac{1}{K_D}}$	Torque (when positive power must be supplied by the engine)	
90 deg.	1	0.1310	0	90.0	$\sqrt{7.63}$	negative
	2	0.0645	0	90.0	$\sqrt{15.5}$	negative
	3	0.0600	0	90.0	$\sqrt{16.6}$	negative
	4	0.0660	0	90.0	$\sqrt{15.15}$	negative
$\sqrt{\frac{\cos\theta \sin 2\theta}{K_D}}$						
60 deg.	1	0.11	0.0274	76.2	$\sqrt{8.2}$	negative
	2	0.0595	0.0246	67.6	$\sqrt{13.1}$	negative
	3	0.0530	0.0218	67.5	$\sqrt{14.9}$	negative
	4	0.0610	0.0192	72.6	$\sqrt{14.3}$	negative
$\sqrt{\frac{\cos\theta \sin^2\theta}{K_L}}$						
30 deg.	1	0.0760	-0.0486	—		positive
	2	0.0452	0.0	—	$22.1 \left(= \sqrt{\frac{1}{K_P}} \right)$	positive
	3	0.0425	0.0152	70.4	19.55	negative
	4	0.0447	0.0216	64.1	16.7	negative
$\sqrt{\frac{\cos\theta \sin^2\theta}{K_L}}$						
15 deg.	1	0.0430	-0.110	—		positive
	2	0.0318	-0.0252	—		positive
	3	0.0304	-0.00238	—		positive
	4	0.0336	+0.00925	74.6	26.6	positive
	5	0.0330	+0.0169	62.9	21.6	positive
$\sqrt{\frac{1}{K_D}}$						
0 deg.	1	0.0274	-0.133	—		positive
	2	0.0218	-0.0374	—		positive
	3	0.0218	-0.0152	—		positive
	4	0.0256	-0.00595	—		positive
	5	0.0254	0.0	—	39.6	positive

tending to rotate in a positive direction, and at another point tending to rotate in a negative direction. If the torques on the windmill balance as a whole, so that the resultant torque is zero, the L/D of the whole windmill considered as a lifting surface will depend on the inclinations to the perpendicular to the flight path of the forces R in the diagrams of Fig. 7. It is conceivable that if the axis of rotation of the windmill is only at a slight inclination to the flight path, and the inclinations of R to the perpendicular to the flight path are alternately positive and negative, that a very high L/D for the whole disk surface might result—conceivably a higher L/D than that of a single blade element. The peculiar feathering action of the Autogiro may assist in securing this high L/D .

Therefore it would be dangerous to dismiss as entirely impossible the surprising results obtained by La Cierva in the wind tunnel and given in Table XI.

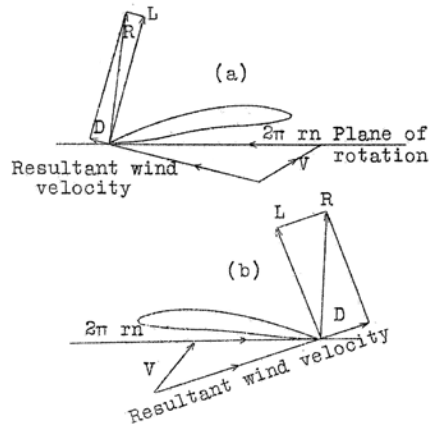

FIG. 7. Diagrams to illustrate the action of blade elements of a windmill in side wind. (a) Blade element moving away from the wind. Resultant force R tends to maintain rotation. (b) Blade element moving into the wind. Resultant force R may oppose rotation, be neutral, or even help rotation.

TABLE XI. Wind Tunnel Tests of La Cierva's Autogiro.

Angle of incidence of plane of rotation to flight path deg.	$\frac{L}{D}$	K_L Referred to entire disk area	K_D Referred to entire disk area	Glide angle θ deg.	$\sqrt{\frac{\cos\theta \sin^2\theta}{K_L}}$
0	19.23	0.0386	0.00202	3	$\sqrt{0.069}$
1	27.78	0.0400	0.00144	2.05	$\sqrt{0.0296}$
2	20.00	0.0432	0.00216	2.8	$\sqrt{0.055}$
4	10.00	0.0535	0.00535	5.7	$\sqrt{0.181}$
6	6.06	0.0700	0.01150	9.4	$\sqrt{0.372}$
10	3.92	0.1130	0.02900	14.3	$\sqrt{0.524}$
16	2.77	0.2030	0.07400	20.1	$\sqrt{0.546}$
22	2.11	0.5500	0.26200	25.5	$\sqrt{0.308}$
26	1.85	0.7150	0.38700	28.4	$\sqrt{0.282}$
30	1.63	0.8050	0.49500	31.5	$\sqrt{0.244}$
34	1.53	1.1300	0.73600	33.2	$\sqrt{0.222}$

These figures indicate extraordinary possibilities for oblique descent with a skillfully designed windmill. Thus if the weight of the airplane is 2000 pounds, the angle of incidence 2 deg., the glide angle 2.8 deg., and the vertical component of velocity 16 ft. per sec., then from the formula

$$V(\text{vertical}) = \sqrt{(W/\rho A)} \sqrt{(\cos \theta \sin^2 \theta / K_D)},$$

we find that a windmill diameter of only 15.2 ft. would be required. If the steepest possible path were used, and the angle of incidence on the glide were 34 deg., a diameter of only 30.6 ft. would be required, and we would then have an airplane which could land in a horizontal attitude on the worst and smallest terrain, and come to rest almost immediately.

Of course, very great difficulties may be encountered in converting a normal lifting airscrew into a windmill by mechanical methods. The best planform and blade-angle setting for the lifting airscrew might be far from the best for the windmill. The production of a compromise design will need very thorough aerodynamic research.

V. FORWARD SPEED AND EFFICIENCY IN HORIZONTAL FLIGHT

It has been shown by several investigators that for a given torque and R.P.M., the thrust along the airscrew axis increases with forward speed. From this it has been argued that a helicopter would be extremely efficient in forward speed. This is based on faulty analysis. The best method of approaching the problem is again to treat the airscrew as a lifting surface, and to consider work done in overcoming forward resistance, as well as the work done in imparting thrust to the airscrew.

Durand and Lesley's Experiments at Zero Incidence for Plane of Rotation. A large number of propellers were tested by these investigators, with the axis of rotation at 90, 85, 80, 70, and 60 deg. to the relative wind, with the axis inclined, in all but the first case, in such a manner as to produce forward thrust coefficients along the axis, and torque coefficients were obtained; no allowance was made for lateral resistance.

It is convenient to introduce here an expression L/D_a for the lift/drag ratio of an airscrew working in a side wind. Where lateral resistance is neglected,

$$\frac{L}{D_a} = \frac{T}{(2\pi Qn)/V}$$

and since $T = T_c n^2 D^4$ and $Q = Q_c n^2 D^5$,

$$\frac{L}{D_a} = \left(\frac{T_c}{Q_c}\right) \left(\frac{V}{2\pi n D}\right) = \left(\frac{T_c}{2\pi Q_c}\right) \left(\frac{V}{n D}\right)$$

As a general rule it was found that the ratio T_c/Q_c increased considerably in going from small values of V/nD to the largest employed in the tests; for some propellers this ratio was more than doubled. Neglecting lateral resistance, the value of L/D_a would increase greatly with increasing values of V/nD . But it is impossible to imagine that T_c/Q_c would increase indefinitely with V/nD , and there are practical limitations to the value of V/nD in an actual helicopter. For our purpose, which is merely to approximate to values of forward efficiency *on a basis of insufficient experimental data*, it is sufficient to consider L/D_a for a few propellers at the highest V/nD tested (see Table XII). Propellers of low pitch/diameter ratio seem to come off better, but the L/D_a values are poor even when the lateral resistance is neglected.

TABLE XII. Tests by Durand and Lesley on Propellers at 90 deg. Yaw or 0 deg. Incidence for Plane of Rotation.

Propeller	Pitch diameter ratio	Highest $\frac{V}{nD}$ tested	T_c	Q_c	$\frac{L}{D}$	$\frac{L/D_a}{V/nD}$
5	0.7	1.190	0.2610	0.01945	4.07	2.13
9	0.5	1.301	0.1842	0.00779	4.90	3.76
139	0.3	0.423	0.0936	0.00346	1.83	4.30
146	0.3	1.333	0.1540	0.00455	7.15	5.38

Relf's Experiments at Zero Incidence. These experiments were likewise at 90 deg. yaw, or 0 deg. incidence for the plane of rotation, with a two-bladed 2-ft.-diameter propeller of 2 ft. pitch. Lateral resistance was not taken into account. Two representative results are given in Table XIII.

TABLE XIII. Relf's Experiments at 0 deg. Incidence.

Wind speed ft. per sec. V	R.P.M.	$\frac{V}{nD}$	Thrust T lb.	Horsepower	$\frac{L}{D_a} = \frac{T \times V}{\text{HP.} \times 550}$
20	750	0.8	1.0	0.032	1.13
40	760	1.6	1.22	0.036	2.45

Riabouchinsky's Experiments at Zero Incidence. Riabouchinsky experimented with a small airscrew of only 25 cm (10 in.) diameter, and a pitch/diameter ratio of 0.75, at 0 deg. incidence for the plane of rotation, and wind speeds of 3, 4, 5 and 6 m per sec. (9.85–19.7 ft. per sec.). In his experiments lateral resistance was taken into account. The results are given in the original units in Table XIV.

TABLE XIV. Riabouchinsky's Experiments at 0 deg. Incidence.

Wind speed, N m/sec. V	r.p.s. nD	$\frac{V}{nD}$	Thrust, kg T	Work put into airscrew shaft, kg-m/sec.	Lateral resistance, kg R	L/D_a neglecting lateral resistance TV/P	L/D_a taking lateral resistance into account $TV/(P - RV)$
3	8.6	1.39	0.0076	0.0112	0.00140	2.03	1.49
6	17.5	1.37	0.0307	0.0846	0.00663	2.18	1.48
6	7.9	3.20	0.0139	0.0139	0.00411	3.44	1.26

These results do not seem very promising for the efficiency of a helicopter when operating with plane rotation at zero angle of incidence, but they were not obtained from modern propellers. Riabouchinsky's experiments are interesting in showing the considerable value of the lateral resistance, particularly at high values of V/nD . They put us on guard against expecting high efficiencies in forward flight with the axis of rotation inclined so as to produce a component of thrust in the direction of flight.

Horizontal Flight with Plane of Rotation Inclined at a Negative Angle to the Flight Path. From the experiments just described, it would appear that only low efficiency can be secured in horizontal flight with the plane of rotation parallel to the flight path. If the propeller is working in yaw other than 90 deg., and the forward component of the thrust and the lateral resistance are both neglected, the expression for L/D_a becomes (where γ = angle of yaw) $(T_c \sin \gamma / Q_c 2\pi)(V/nD)$. We shall examine the value of this expression for the propeller 146 in Durand and Lesley's experiments (see Table XV).

TABLE XV.

γ Angle of yaw, deg.	$\cos \gamma$	Highest V/nD tested	T_c	Q_c	$\frac{L}{D_a} = \frac{T_c \sin \gamma}{Q_c 2\pi} \frac{V}{nD}$
90	1.0	1.333	0.1540	0.00455	7.15
85	0.9962	1.201	0.1240	0.00539	4.40
80	0.9848	1.267	0.0977	0.00496	3.90
70	0.9397	1.262	0.0339	0.00402	1.59
60	0.8660	0.959	0.00665	0.00372	2.34

If the forward component of the thrust is taken into account, the expression for L/D_a becomes

$$\frac{(T_c \sin \gamma)(V)}{Q_c 2\pi nD - T_c \cos \gamma V} = \frac{T_c \sin \gamma}{Q_c 2\pi/(VnD) - T_c \cos \gamma}$$

values of which are given in Table XVI.

TABLE XVI.

Angle of yaw deg.	Highest VnD tested	$\frac{T_c \sin \gamma}{Q_c 2\pi/(VnD) - T_c \cos \gamma} = \frac{L}{D_a}$
90	1.333	7.15
85	1.201	7.42
80	1.267	12.50
70	1.262	3.88

The expression L/D_a can be brought into definite comparison with L/D_w , which will be used to denote the L/D of an airplane wing.

Thus for an airplane we can write, if η is the efficiency of the propeller and R_p the parasite resistance,

$$P\eta = \frac{WV}{L/D_w} + R_p V \text{ and } \frac{L}{D_w} = \frac{WV}{P\eta - R_p V}$$

For the helicopter we can write

$$P = \frac{W}{(L/D_a)} V + R_p V \text{ and } \frac{L}{D_a} = \frac{WV}{P - R_p V}$$

For the same power P and weight W , in order to have the same velocities for air-

plane and helicopter, $\left(\frac{P\eta - R_p V}{W}\right) L/D_w$ must equal $\left(\frac{P - RV}{W}\right) L/D_a$, or $L/D_a = L/D_w \left[1 - \frac{(P - P\eta)}{P - R_p V}\right]$. In other words, L/D_a can be less than L/D_w to secure the same effect.

We can now get an idea of the probable effectiveness of the airscrew in forward flight.

There are two extreme cases: (1) where the lateral resistance of the airscrew balances its forward component; and (2) where the forward component is undiminished by lateral resistance. With a propeller such as the Durand 146, we can by inclining the airscrew secure an L/D_a certainly not less than 4.40, never much greater than 12.50. Certainly an L/D_a of between 8 and 9 can be expected.

It may also be safely concluded that higher efficiency would be secured in forward flight by using an inclined airscrew than by the use of an auxiliary propeller.

At least the experimental values of L/D_a , neglecting lateral resistance, are much higher in the former case. Compare 12.5 at 80 deg. yaw in Table XVI with 7.15 at 90 deg. yaw in Table XII. Also for the helicopter with the inclined airscrew producing forward thrust there is a decided advantage in the fact that

$$L/D_a = L/D_w \left[1 - \frac{(P - P\eta)}{P - R_p V} \right]$$

With an auxiliary propeller there would be efficiency losses of the usual type in the auxiliary propeller itself; and this advantage would disappear. Granted that an inclined airscrew is used, that the parasite resistance can be kept down, and that the diameter of the airscrew can be kept within reasonable dimensions, by windmill action on oblique descent, so as to have high values of V/nD , there is no reason to doubt that fair speeds could be secured with a helicopter satisfactory in other respects.

For example, if it were possible to build a helicopter weighing 2500 lb., with 200 HP., and an equivalent parasite resistance of 15 sq. ft. (more than that of the DH4 airplane), and to have $L/D_a = 8$, solution of the equation

$$L/D_a = \frac{WV}{P - R_p V}, \text{ or } 8 = \frac{2500 V}{(200 \times 550) - 0.0450 V^3}$$

would give approximately a speed of 115 ft. per sec. or 78.5 M.P.H.

Estimates of Efficiency by Margoulis and Case. Margoulis' views on airscrews, with no motive power supplied to the shaft from an external source, are based on careful experiments. His estimates for L/D for power-driven airscrews are based on a series of unsatisfactory approximations and interpolations from the results of various laboratories. He finds maximum L/D to be only 1.7, with $\gamma = 60$ deg., but this need not be seriously regarded. Case has designed a number of propellers on the simple blade-element theory and calculated their efficiency, for an angle of 10 deg. between the flight path and the plane of rotation. With a four-bladed screw of pitch/diameter ratio 0.3, $V/nD = 20$, $D = 40$ ft., $n = 1.46$ r.p.s., he found an effective L/D_a of 6.7. By making the effective angle of incidence 5 deg. along the blade, when meeting the forward wind an L/D_a of approximately 9 is deducible from Mr. Case's calculations.

It is doubtful whether for the complicated and varying conditions under which the helicopter airscrews must work when inclined to the side wind, calculations based on the simple blade-element theory will give accurate results. But still these careful calculations are pleasingly in agreement with hypotheses based on experimental values.

The elementary blade-element conditions for various points in the revolution of the airscrew are very complicated. The design of an airscrew, to give the best results, would evidently be a difficult proposition. It is doubtful if the inclined

helicopter airscrew can be made as efficient as the combination of propulsive screw and lifting wing of the airplane, but it must be considered that in the inclined-screw helicopter there is only one transformation of energy; in the airplane there are two such transformations.

VI. STABILITY AND CONTROL

Stability in Vertical Movement and Vertical Winds. This first problem in the stability of the helicopter involving stability in vertical movement and vertical winds, has been well treated by Fage. In Fig. 8 are shown typical propeller characteristic curves plotted against V/nD . From this it follows that if a down gust hits a hovering helicopter, it will be in the region of positive V/nD , and while the engine will speed up a little as Q_c diminishes, T_c will diminish more rapidly, the thrust will decrease, and the machine will descend. If the down gust ceases, the helicopter will work in a region of negative V/nD and the thrust will increase accordingly, equilibrium being rapidly restored. If an up gust strikes the helicopter, its airscrew will be working in a region of negative V/nD , and the thrust will increase accordingly. If the up gust is very violent, however, so that the negative V/nD is numerically large, the thrust coefficient will decrease and the machine may drop. (This is not unlike the behavior of an airplane in vertical gusts.) Also, if for some reason the helicopter should descend rapidly, it may reach the condition of large negative V/nD and drop with increasing velocity. Evidently the pilot will have to watch his throttle very carefully in vertical maneuvers. But with an engine responding readily to the throttle or a variable-pitch propeller, nothing serious need be feared.

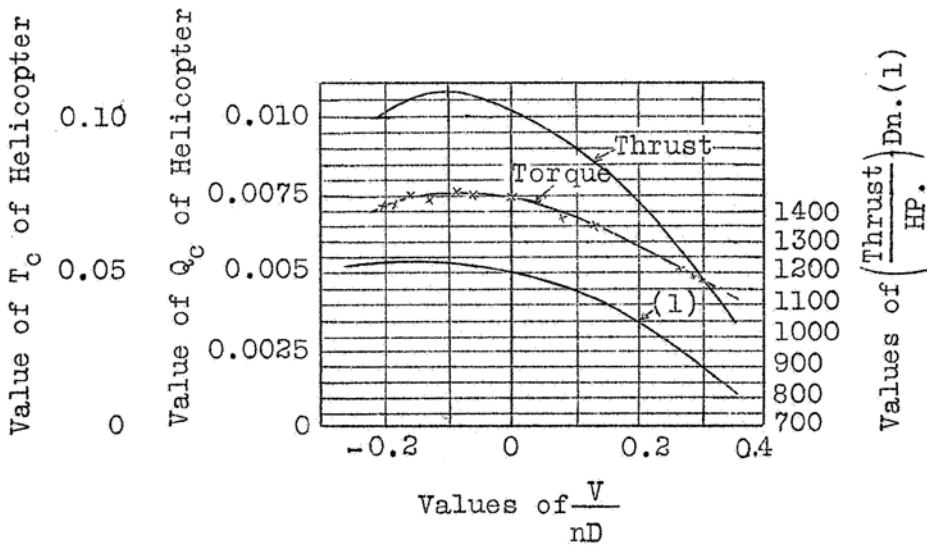

FIG. 8. Characteristics of a Helicopter airscrew at varying values of V/nD .



FIG. 16. Karman Helicopter without turre[t].

Dihedrals in the Helicopter. Karman (Figs. 16 and 17) has shown that a helicopter with two screws rotating in opposite directions and placed above the center of gravity is likely to be unstable, whether the screws are coaxial or side by side. But an airplane wing of itself is not stable, and it does not seem fair to demand that a helicopter should be stable without some special arrangement of the airscrews. It seems possible to secure stability either longitudinally or laterally by the use of dihedral angles between the planes of rotation of two airscrews. If the helicopter is slightly tilted for some reason or another, the resultant of the two thrusts will no longer be vertical: there will be a side component in the direction of the tilt and a lateral movement in that direction. But Durand and Lesley have shown that when airscrews are placed with their planes of rotation oblique to the wind, the coefficient of thrust becomes smaller than the coefficient of thrust when the plane of rotation was parallel to the wind. The inclined screw has its plane of rotation inclined to the lateral motion, and therefore has less thrust. A righting moment is introduced thereby. Dr. De Bothezat, in building his helicopter, had four lifting screws disposed with a longitudinal and lateral dihedral, and evidently had this property in mind. From unofficial reports it is clear that his machine was stable.

It might be possible to secure both lateral and longitudinal dihedrals by the use of only three lifting screws suitably arranged.

If two coaxial screws are used, it might be possible to secure the necessary dihedrals by the use of a third or auxiliary airscrew. Whether a dihedral effect in a single

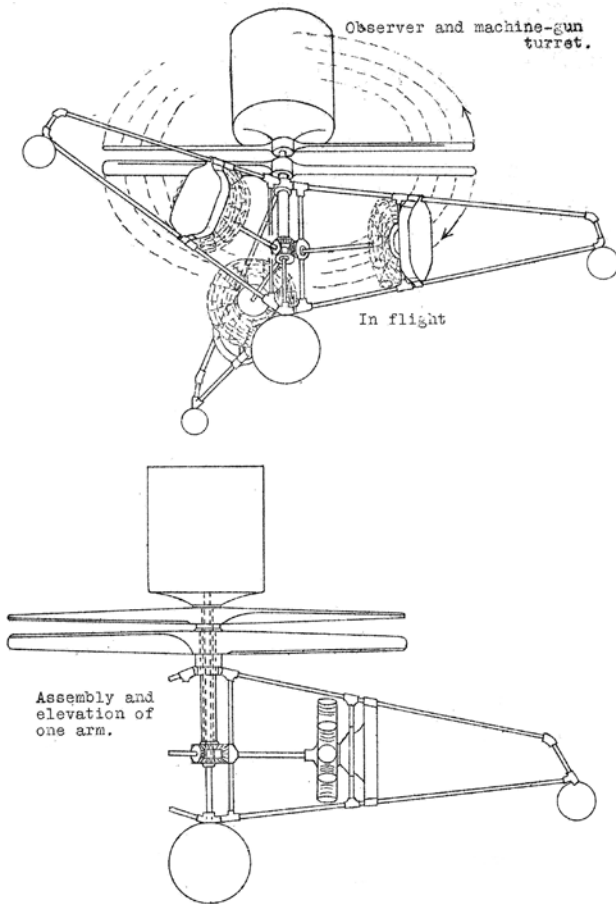

FIG. 17. Diagrammatic drawing of the Karman captive helicopter with three rotary engines.

airscrew can be secured by placing the blades at an upward angle to the axis of rotation, [*sic*] is an open question.

Damping in the Helicopter. Dihedrals in the helicopter, just as in the airplane, give static righting moments, but damping will also be present, even if no dihedral is embodied in the design. If a helicopter is rolling in such fashion that one airscrew rises, it can be seen from the curves of Fig. 8 that its thrust diminishes; simultaneously the thrust of the other airscrew will increase. There should be, therefore, damping in either roll or pitch for both three-screw and two-screw helicopters. It is a question, however, whether a two-screw coaxial helicopter would provide damping.

Fins to Give Equivalent of the Dihedral. Since it is advisable to keep the number of lifting screws down to a minimum, the possibility of using fins immediately suggests itself. In rapid forward flight the use of fins should be effective; if two coaxial screws are employed, one vertical fin placed high above the center of gravity, with its plane parallel to the line of flight, would be an effective substitute for the lateral dihedral. A stabilizer placed at a negative dihedral to the plane of rotation of the lifting screws might be an equally good substitute for the longitudinal dihedral. These auxiliary surfaces in rapid forward flight would not have to be of unduly large proportions.

But in hovering flight and vertical ascent or descent such auxiliary surfaces would be almost useless. For instance, if we imagine the coaxial screw helicopter in vertical ascent, with a horizontally disposed stabilizer, to pitch slightly, the

horizontal stabilizer would be scarcely affected by the slight pitch. Similar considerations would apply in regard to vertical fins used as a substitute for lateral dihedral. In vertical ascent or descent the problem is somewhat easier than for hovering, but even if placed in the slipstream the auxiliary surfaces would have to be enormous to be effective. In all probability, if dihedrals between the lifting screws are not present, reliance will be placed on skilled actuation of the controls.

Directional Stability. So-called "directional stability," more properly "weathercock stability[.]" has to be considered for the helicopter just as for the airplane. In the airplane weathercock stability is readily secured by a preponderance of fin area aft of the center of gravity. Propellers, whether propulsive or airplane propellers or lifting airscrews, may be considered as fins. In rapid forward flight the fin action of the propellers, whether two or four lifting screws were used, would be concentrated approximately at the center of gravity, and comparatively little power would be required of a vertically disposed fin to obtain "weathercock stability." In hovering and vertical ascent or descent it would act far less powerfully, and reliance would probably have to be placed on auxiliary steering propellers, and manual control.

Stability a Subject for Research. The above treatment of stability is obviously superficial. It seems to the author that prior to the building of full-sized helicopters a great deal of theoretical analysis and wind-tunnel experimentation should be undertaken as regards stability. It seems ridiculous to expose helicopter pilots to great hazards in their first painful efforts, when with some patient wind-tunnel work a machine fairly stable under all conditions might readily be evolved.

Control. The question of helicopter control is one decided by practical rather than theoretical considerations. There seems no reason, however, why complete control under all circumstances should not be more readily secured than stability. For rapid forward flight the requirements are not unlike those of an airplane, and systems of control readily suggest themselves. For the ailerons can be substituted variation in pitch of the lifting airscrews on either side of the longitudinal axis, or else movable fins or plates placed in the slipstream of the propellers. In forward flight a vertical tail rudder would be just as effective as on the airplane. So would an elevator.

In hovering or vertical flight an auxiliary elevator airscrew with variable or even reversible pitch would seem to be necessary, as also a steering airscrew—or steering airscrews.

The question of control would seem to offer wide scope for inventiveness and mechanical skill. Perfectly realizable, helicopter control is always likely to be more complicated and less certain than that of an airplane. A duplicate system of controls—one for forward flight, one for hovering—might conceivably be necessary. Descriptions of machines which follow illustrate a number of practical forms of control.

VII. SOME MODERN HELICOPTERS

Berliner Helicopter. An early form of the Berliner helicopter was described in *Mechanical Engineering* for September, 1922. It was of the simplest possible form, with a 200 HP. engine driving two moderate-sized lifting airscrews on either side of the fuselage. Lateral control was secured by the use of three movable fins under each of the propellers; and longitudinal control by a small variable-pitch propeller at the rear of the fuselage. A horizontal stabilizer and elevators and rudder identical with those of an airplane were provided. Successful short flights were achieved.

Quite obviously, Berliner was not satisfied with the safety of his craft in case of engine failure; and in his next design sought to provide the ability to glide by embodying wing surfaces in the structure. It now became a helicopter-airplane. Outline drawings and photographs of this machine are shown in Fig. 9.

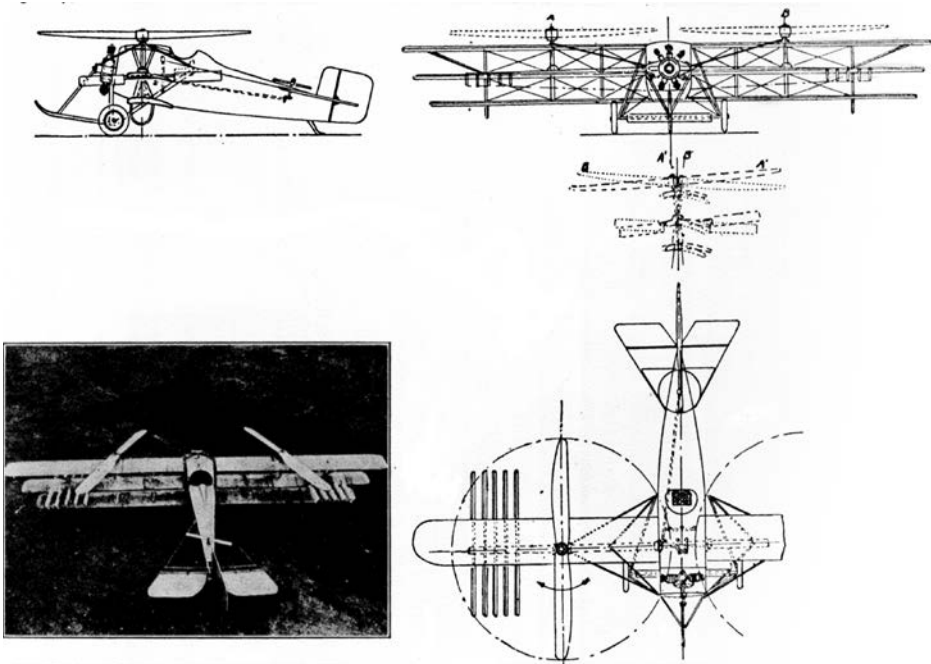

FIG. 9. Plan, elevation and view of a recent form of the Berliner Helicopter.

The Berliner helicopter is now provided with a conventionally trussed triplane wing surface and two lifting propellers, which latter also provide forward thrust on inclination of the entire craft. The transmission system is carefully enclosed within the wing surfaces and the interplane struts.

The system of control is complete. A slight warping of the wings can be produced by a special control, whereby the axis of the lifting propellers can be inclined

at different angles to the line of flight on either side of the machine; so that a turning couple can be obtained. With the lifting propellers in motion, the pilot regulates a variable-pitch propeller placed at the tail end of the machine, so as to raise the tail from the ground. Under the action of the lifting propeller the helicopter leaves the ground. The rear propeller permits the further inclination of the axis of the lifting propeller until a forward component of the thrust is obtained, with resulting forward speed. Lateral equilibrium is maintained by a system of movable fins placed below the disk area of the propellers. It can be seen that the system of control is fully operative whether in forward flight or hovering flight or vertical movement.

If the lifting propellers become inoperative, either owing to damage or engine failure, the machine becomes a glider. On the glide, wind-tunnel experiments seem to indicate a best L/D of only 4. On the glide, warping of the wings takes care of lateral control; an ordinary rudder and elevator act in the usual manner.

The gross weight of the machine with pilot and fuel for a twenty-minute flight is about 1950 lb. The engine is a Bentley Rotary Model 2, air-cooled, providing 220 HP. at 1200 R.P.M. The lifting propellers turn at about 560 R.P.M. and have a diameter of 15 ft. The span of the wings is 38 ft. and the chord is approximately 1 ft. 11 in. The overall length is 20 ft. 6 in. and overall height about 6 ft. 8 in.

According to reports of the Italian Air Attaché in Washington, the machine makes only a fair getaway. The maneuverability seems satisfactory, and the aircraft responds well to the controls. In a moderate but irregular wind the oscillations appeared important. The Berliner helicopter is still in an experimental form, but it has definitely achieved vertical flight, and complete freedom of evolution. Its ability to glide is an important factor as regards safety. The maximum duration of flight achieved so far appears to be 1 min. 35 sec., and the highest altitude reached, 15 ft.

Pescara Helicopter. This is shown in Fig. 10. It has made some excellent flights. The apparatus carries two six-bladed biplane airscrews of 21 ft. diameter. The engine is a 120 HP. Le Rhone. Maneuvering is effected by modifying the incidence of the blades at any one point in their revolution. No very reliable technical information is available. The control seems very incomplete, and Pescara himself has complained of this.

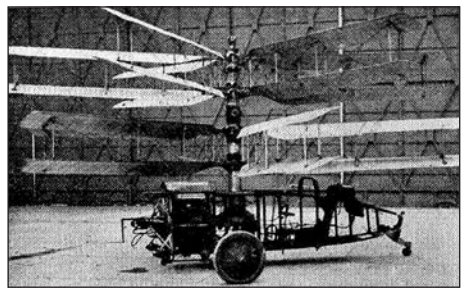

FIG. 10. Pescara Helicopter.

It is very interesting to read in a recent report of the French Section Technique d'Aeronautique, that this competent body places most reliance on the helicopter airplane. Pescara now seems to be working on a machine of this type, termed a "helicoptane." A somewhat sketchy description of this design is available.

This machine has upper and lower wings revolving in opposite directions. They are connected through gearing and clutches to a 300 HP. engine situated immediately back of the wings of the fuselage. This engine is also connected through a clutch through a pusher propeller mounted at the rear end of the fuselage. The pilot sits immediately forward of the wings. The radiator is located in the front end of the fuselage. The machine will weigh 850 kg empty, and 1250 kg fully loaded. Surface loading will be approximately 80 kg per sq. m. The main vertical drive shaft to the helicopters proper terminates in the landing-gear fork support, and the vertical drive-shaft housing alone forms the main support for the planes proper. Small counterbalancing ailerons are fitted at the extremities of the helicopters. Elevator, stabilizer, and rudder are mounted in conventional fashion. The tail skid is really an extra strut to the landing gear proper to keep the propeller away from ground interference. In order to glide to earth in case the engine stops, Pescara claims that by varying the pitch of these helicopters and allowing them to be free to move, they will revolve in opposite directions while gliding without power and thus increase the gliding distance appreciably.

De Bothezat Helicopter. This interesting machine is illustrated in Fig. 11. It was first flown on October 19, 1922. On April 17, 1923, with Colonel Thurman H. Bane as pilot, a four-man flight was made, with three men hanging on to the machine. Between these two dates the helicopter has made over 50 flights—no descent with engine cut being attempted, however.

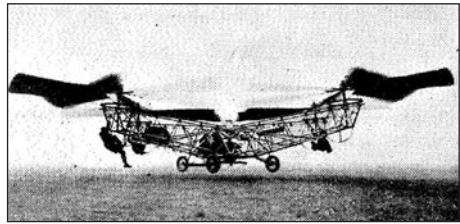

FIG. 11. De Bothezat Helicopter.

The De Bothezat helicopter, as illustrated in Fig. 11, is provided with four lifting screws, each of 26½ ft. diameter, four-bladed, with wide blades (5 ft. toward the tip), giving a total blade area of 900 sq.ft. Although each blade screw was designed for a lift of 1000 lb., dynamometer tests were conducted up to a thrust of 1500 lb.

The weight empty is 3400 lb., and a useful weight of 1000 lb. has been carried. The weight empty exceeded original estimates considerably, as all new types of aircraft are bound to do. When the helicopter is in operation, two-thirds of its weight is rotating and about one-third only is stationary. The overall length is 65 ft.; width, 65 ft.; height, 10 ft.

It has been equipped with the B.R. 2 stationary air-cooled engine developing 200 HP., a 9-cylinder 200 HP. Le Rhone rotary engine failing to give satisfaction.

A central frame member supports the engine and four outwardly extending structural arms, built up of duralumin and steel tubing. One of these arms contains the pilot's seat and each supports one of the lifting screws at its outer end.

The engine drives a main shaft and four jackshafts, to each of which is connected a turret driven through ring and center gearing. The engine also drives two 4-bladed propellers, of the reversible-pitch type, one being rotated at each side of the pilot and facing forward so as to give a forward thrust.

Unofficial reports indicate that the De Bothezat helicopter was moderately satisfactory in control and stability. In the four-man flight mentioned above, a man was hanging on at the extreme end of the rear arm with his weight totally unbalanced.

We have discussed in the previous section the utility of the dihedral principle. This principle was undoubtedly used successfully here; with the planes of rotation of the laterally and longitudinally disposed airscrew at a dihedral angle to one another.

The control secured was apparently complete by making all the lifting propellers variable and reversible in pitch, and by using the two small variable-pitch directional propellers, with axes horizontal, placed on either side of the fuselage.

In order to reverse the pitch of the blades of the main lifting screws a hollow shaft is fixed to the frame, and the end extends upward to a floating bearing which acts as a hub for a hollow shaft. A reversing and adjusting sleeve and levers are adapted to be operated vertically by movement of the shaft mounted within the adjusting sleeve in order to adjust the blade angle. The shaft is vertically operated by means of spiral threads and a spiral-threaded member, the threads being operated by a sprocket to set the pitch of all the propellers' members simultaneously in the same direction, and the threaded member which is operated by a lever for lateral stability by relative variation of the blades of the opposite lifting screws.

Forward motion was apparently secured by tipping the helicopter forward. With the variable pitch of the four airscrews, lateral as well as longitudinal control was secured. The possibility of tipping the helicopter in any sense permits its displacement being effected in any direction.

While no attempts were made to land the helicopter with its engine cut, the design provided for reversing the blades on descent and securing windmill resistance, and also for a reversal to normal position just before reaching the ground.

Damblanc Helicopter. The Damblanc helicopter, while never flown, is an interesting design. The machine is shown in outline in Fig. 12, from which it is seen that the construction was comparatively simple.

Two lifting airscrews were used, driven by cables from two Le Rhone 110 HP. engines. The drive was so arranged that either or both of the two engines could operate both lifting airscrews. An automatic clutch and an elastic shock absorber were embodied in the transmission.

Control was secured by a mechanism for warping the blades (which were built very much like airplane wings), a horizontal stabilizer, and a vertical rudder. Forward speed was to be secured by inclining the airscrews. Apparently for descent the blades were to be put in negative pitch.

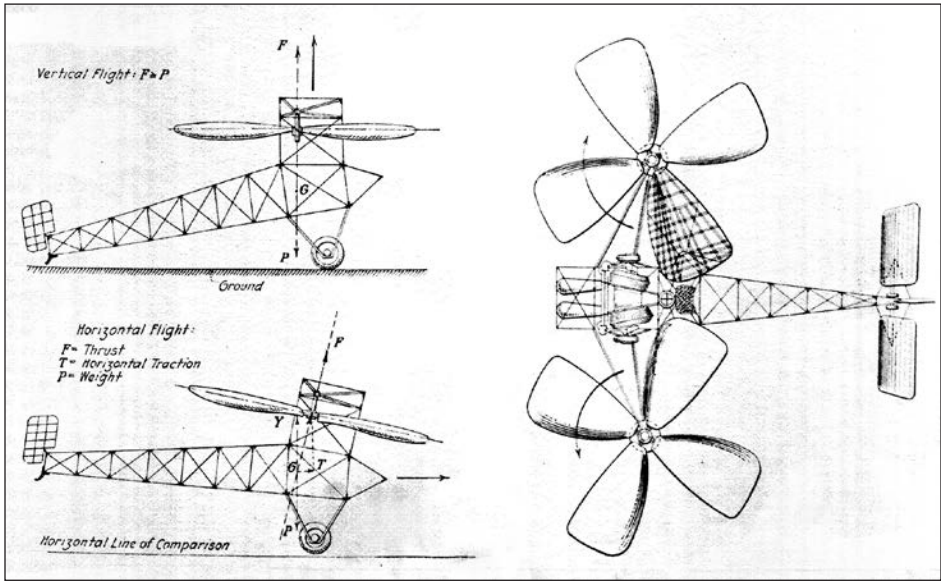

FIG. 12. Damblanc Helicopter.

The main characteristics were as follows:

Span	49 ft.
Overall length	30.2 ft.
Total area of rotating wings	430.0 sq. ft.
Width of fuselage	3.93 ft.
Area of horizontal stabilizing planes (2)	86.00 sq. ft.
Area of rudder	10.75 sq. ft.
R.P.M. of blades	160
Total gross weight	2640 lb.
Power of engines	110 at 1300 R.P.M.
Useful weight	Pilot and gasoline for half an hour's flight.

In his paper before the Royal Aeronautical Society, Damblanc gives some very interesting figures, based on experience and calculation for the weight of his type of airscrew—built in very similar fashion to that of an airplane wing. With a factor of safety of 7, he found that the optimum diameter of a lifting propeller was about 22.6 feet, and that the weight of the propeller per square foot of surface was 1.43 lb.

Damblanc estimated the horizontal speed at 62 M.P.H., and the initial climb at 10 ft. per sec. His machine was wrecked on ground trials, and no further experiments were conducted.

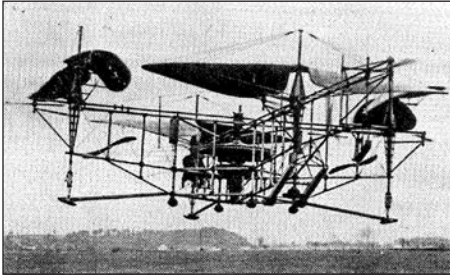

FIG. 13. Oehmichen Helicopter.

Oehmichen Helicopter. This is a very curious machine. While it has completed[,] for the first time in helicopter history, a circular kilometer, has made 450 flights, some at a height of 35 ft., and is perfectly maneuverable and stable, it does not seem possible that so much complexity will persist in the construction of the helicopter. The machine is illustrated in Figs. 13 and 14.

The helicopter's main structure is in the form of a large cross with unequal arms. The longer axis is the longitudinal one and defines the direction of forward flight. At the four terminals of the arms of the cross are placed the lifting propellers. The longitudinal pair of lifting propellers are 25 ft. in diameter and the lateral pair 21 ft. in diameter, all turning at 145 R.P.M. and driven by a system of tubular shafting from a Le Rhone 9-cylinder engine of 120 HP. The engine is placed at the center of the cross, and on the engine shaft is placed a gyroscope (apparently nothing but a flywheel), which has a maximum peripheral velocity of 425 ft. per sec. This rotating mass is said to insure stability in calm air, and to damp out oscillations in rough air.

Two propulsive propellers, of fixed pitch, are belt-driven and placed as shown in Fig. 14. These are of 4.6 ft. diameter and placed about half-way out on the frames which support the lifting propellers. To counteract the torque of the engine and the gyroscope, a propeller with its axis horizontal and athwartship is placed far forward. In addition, five auxiliary propellers, "evolueurs" as Oehmichen terms them, are used. These are variable-pitch propellers of 4.75 ft. diameter, driven from the shafts of the main lifting propellers. It is quite evident that the control about every axis is fully provided for. The landing gear consists of a peculiar system of six footballs at the end of shock-absorbing and pivoted struts. A double skid has been recently introduced into the forward part of the machine. The gross weight of the machine is about 2200 lb., with a load of 6.6 lb. per sq. ft. of blade area.

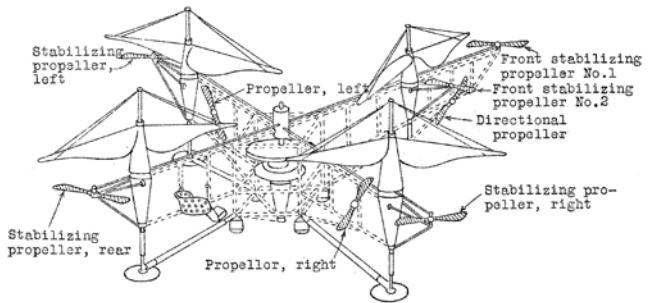

FIG. 14. Diagram of the Oehmichen Helicopter.

La Cierva's Autogiro. La Cierva's Autogiro is a most curious machine, neither a helicopter nor an airplane, but with a windmill operating in a lateral wind providing sustentation. The principles of operation of the windmill have already been described. The machine is illustrated in Fig. 15. The Autogiro weighs about 880 lb. empty, and 1100 lb. loaded. With an 80 HP. engine the maximum speed is 55 M.P.H.; the minimum speed is 33 M.P.H. The rotational speed of the lifting vane is about 140 R.P.M. The diameter of the vane is 26.2 ft. The vertical component of velocity on a steep glide is said to be surprisingly low. The Autogiro certainly deserves careful consideration.

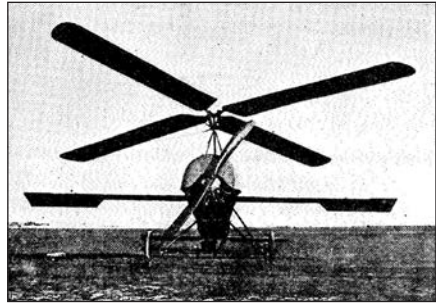

FIG. 15. La Cierva's Autogiro.

CONCLUSION

While predictions in matters regarding the helicopter are rash, it is safe to say that three lines of development are definitely open: (1) The combined helicopter-airplane; (2) the multiple-engined helicopter; and (3) the helicopter with gliding ability by virtue of windmill action of the reversed-pitch airscrews.

The combined helicopter-airplane, of which the Berliner is such an excellent example, is a thoroughly practical proposition. Since descent with engine dead is taken care of by airplane wings, comparatively small airscrews need be provided. This means general compactness of design, high values of V/nD , and ultimately good efficiency in forward flight. Also, since descent is taken care of by gliding planes, the main lifting screws do not need variable pitch, and the mechanism is reduced to a simple speed-reduction and power-transmission problem. Mechanical simplicity is thus assured. This type of craft is not so likely to be very efficient in vertical climb, since it will have a very large wing surface resisting upward motion. The climb of a helicopter-airplane will be more analogous to that of an ordinary airplane. On the glide, it is not to be hoped for that this type will be as efficient as an ordinary airplane. In hovering, more power is likely to be required than in the helicopter proper. The combined helicopter-airplane, while the most readily realized, may be said to depart from the ideal conception of a helicopter, which can rise vertically with ease and descend with engine cut out, either vertically or on a very steep path. It may be a very valuable compromise between the airplane and the helicopter proper.

The multiple-engined helicopter has never been seriously attacked. Damblanc's "Alerion," with its two engines, each capable of driving the two sustaining airscrews, is the nearest approach to such a type. A machine is conceivable with, say, six small

independent power units. On descent, reliance could then be placed entirely on the power plant. The airscrews could therefore be of the small dimensions needed for compactness and efficiency in forward flight. Variable pitch for the main lifting screws could be eliminated. The multiple power plant has difficulties and complications of its own, but the type is well worth considering. It should give us the closest approach to the ideal helicopter, and possibility of good speed as well as climb. The aerodynamic problems would be somewhat minimized.

The third type is the one which has received most attention hitherto, and such designs as those of De Bothezat and Damblanc show that it is practically realizable. It should be possible with this type to secure control, stability, excellent vertical climb, hovering flight, moderate forward speed, and, provided suitable windmill action can be secured, a steep, safe descent with engine out of commission. It will be more complex than the first two types, with variable-pitch propellers as an absolute necessity. It will approximate to the ideal helicopter more closely than the combined helicopter-airplane, less closely than the multiple-engined type. Besides its inevitable complexity, it is never likely to achieve great forward speed, and its load-carrying capacities are likely to prove disappointing. In spite of these difficulties, it may be developed because it does not involve the disadvantages of multiple engines and because it does approximate to the ideal helicopter. Some plausible calculations by the author indicate that with a 200 HP. engine a helicopter of this type could be built to weigh about 3000 lb. carrying a man and a couple of hours' fuel load, be equipped with two main lifting airscrews of 30 ft. diameter each, climb vertically at 500–600 ft. per min., have a forward speed of 60 M.P.H., and glide down safely with engine dead on a path of 30 deg. to the horizontal at an angle of incidence of 30 deg. so that craft would maintain a horizontal position on the glide, and come to rest very quickly after touching the ground.

There is no doubt that any of the three types discussed above can be realized in practical form, and that the general characteristics of the helicopter are already well understood. Given more fundamental work in the wind tunnel and financial support, aeronautical engineers will readily produce a workman-like craft.

It is also suggested that aerodynamic research be conducted before the construction of full-sized machines is undertaken. Langley and the Wrights undertook such investigation before building their flying machines. Surely the wind tunnel should now be called upon for investigating stability, windmill action in gliding descent, conversion of a lifting airscrew into a windmill, and efficiency of the lifting airscrew in forward flight.

The helicopter is not likely to equal the airplane in speed or in carrying capacity. Owing to the large airscrew diameters required, it is not likely to be so compact or maneuverable. With engine dead, however, it should be able to land in worse and more restricted terrain, and that is an important point from the safety aspect. But the airplane has only one mechanical contrivance of any complexity: the engine. The helicopter with multiple-engine power plant will have reduction gearing (10 to

1, or thereabouts) to contend with, and a complicated system of control. The single-engined helicopter will have to include a variable-pitch mechanism in addition. The airplane engineer builds a structure which glides through the air, but with its parts stationary relative to one another. In the helicopter weight limitations and the flexibility of a light, huge device will make all the mechanical problems of transmission, etc., particularly difficult, and such difficulties militate against safety.

The future of the helicopter, unless it undergoes radical development, therefore lies not in competition with the airplane, but in its ability to perform certain functions which the airplane cannot undertake.

Before the complete development of a new mechanism of transportation, it is impossible to predict all the uses to which it may be put. It is doubtful whether the Wrights foresaw the application of the airplane to fighting the boll weevil, or making air surveys for laying down power-transmission lines. By analogy, the helicopter, once it has been developed, may be utilized in ways quite unsuspected by us at present. There is no lack of plausible suggestions for its utilization. In military use for observation purposes, to replace kite balloons or over areas where extremely accurate information is required; for securing communication between army units which cannot maintain airplane contact owing to topography; for accurate bombing of either land or sea objectives; for use in connection with naval vessels not supported by aircraft carriers. Enthusiastic supporters of the helicopter go so far as to see it landing on roofs, bringing rapid communication to the very heart of cities and helping to relieve traffic congestion—although airplanes with landing platforms may more readily achieve this.

At any rate, the helicopter is within measurable distance of achievement, and is worthy of serious consideration.

Document 5-35

M. Moreno-Caracciollo, "The 'Autogiro'," NACA Technical Memorandum 218 (July 1923).

Soon after its appearance in the Spanish journal *Ingeniera y Construccion* in March 1923, the NACA's Paris office forwarded a translation of this article written by M. Moreno-Caracciollo, the secretary of the Royal Aero Club of Spain. What it reported was the first successful flight of Juan de la Cierva's autogiro, at the aerodrome of Cuatro Vientos in Madrid, on the afternoon of 31 January 1923. Several photographs of the Cierva machine accompanied the translation, and four of them were published in the NACA Technical Memorandum. Readers should look for the following grandiose (and very long) sentence near the end of the article: "The 'Autogiro' is not a helicopter nor an aeronautic freak pretending to solve a difficult problem of mechanics, but is a perfected airplane, although not designed with the sporting purpose of increasing speed nor with the commercial object of enlarging the radius of action, but with the humanitarian purpose of reducing to a minimum the number of accidents and the number of human lives sacrificed in the fight for the conquest of the air."

Document 5-35, M. Moreno-Caracciollo, "The 'Autogiro'," NACA Technical Memorandum 218 (July 1923).

For the first time in the world, a flying machine, heavier than the air and distinct from the airplane, has completed a circuit of four kilometers (nearly 2.5 miles) at a height of more than 25 meters (82 feet) above the ground. This event, which marks the beginning of a new era in the history of aviation, took place in Madrid at the airdrome of Cuatro Vientos, in the afternoon of January 31, 1923.

The machine piloted by Lieut. Alejandro Gomez Spencer, which, that afternoon, we saw flying above us, was neither an airplane nor a helicopter. It was the "Autogiro," a flying machine invented and constructed in Spain by a civil engineer, Juan de la Cierva. Between the original conception and this brilliant accomplishment there lay many months of continuous work, a thousand difficulties overcome, experiments begun in many directions only to be abandoned, and yet with a will sustained by an immovable faith in ultimate success.

We are going to give the readers of "Ingeniera y Construccion" the story of the "Autogiro." It is a useful lesson for those who are willing to abandon the well-trodden roads of routine and have sufficient courage to enter the difficult paths of research. We will first indicate in a few words, the problems which the "Autogiro" is expected to solve.

A very high percentage of aviation accidents is due to “loss of speed.” The lift produced by the pressure of the wind depends on two factors: wing area and speed, as combined in the formula

$$P = K\gamma S V^2,$$

in which V is the airspeed or velocity, S the wing area, and $K\gamma$ a coefficient dependent on the wing section and the angle of attack. Since the velocity is squared, a small diminution of its value may result in a large loss of lift, followed by a catastrophe.

This preponderance of velocity over the other factors by which lift is obtained gives rise moreover to another serious disadvantage. An airplane must fly very swiftly, [*sic*] in order to remain in the air and, when it does come into contact with the ground, the same velocity which prevented its fall carries it violently over the irregularities of the field and any obstacles which happen to be in the way. Airplanes are often upset and aviators killed due to the high landing speed.

A flying machine unaffected by losses of speed in the air and which can alight as slowly as a bird, is the goal long pursued by airplane constructors and only recently attained in the “Autogiro.”

In this machine the wings have been eliminated and the lift is produced by revolving wings on a vertical shaft projecting from the fuselage of an ordinary airplane. However, it does not belong to the family of helicopters since the sustaining propellers of the latter are operated directly by the engine, whereas in the “Autogiro” the wind produced by the motion of the aircraft actuates the blades. Hence, although at first glance it seems to resemble a helicopter, it is really more like an airplane and, had it not been christened the “Autogiro,” it would surely have been called an “airplane with rotating wings.”

It is easily understood that the blades of the lifting wings will revolve, when the “Autogiro” moves horizontally, pulled by the tractor propeller coupled to its engine. It is also easy to understand that the revolving blades of the “Autogiro” strike the air more violently than the fixed wings of an ordinary airplane, since the rotation speed of the blades must be added to the normal speed, and since one of the blades advances while the opposite one moves back, these component speeds are added on

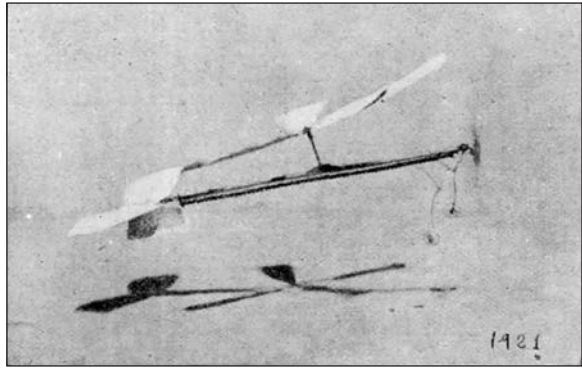

FIG. 1. Model of Autogiro, with rubber elastic as propelling force, exhibited before the Technical Committee of the Aero Club in 1921.

one side of the aircraft and subtracted on the other. Hence the resulting speed will be greater on one side than on the other and the aircraft being unequally sustained, will tip toward the side of the blade which cuts the air with less speed.

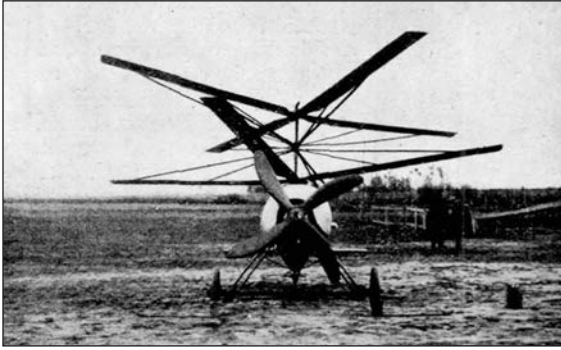

FIG. 2. Autogiro No. 1.

upper revolving wing acted on the lower, the latter rotating much more slowly than the former. The lifts of the two wings were unequal and their effects were not compensated.



FIG. 3. Autogiro No. 2.

angles of attack, although the geometrical angles formed by their surfaces and the axis of rotation are equal. A careful calculation gave the exact critical angle at which the variation of speed would just be compensated by the angle of attack, but it was necessary to confirm the theory by experiments.

Before the duralumin for the enormous blades of the aircraft arrived in France, a lifting wing with three flexible blades was constructed in a few days. This was attached to the fuselage of an airplane and tests were begun in June, 1921, at the airdrome of Getafe.

The remedy adopted by all helicopter builders (two propellers revolving in opposite directions) was the first one tried by La Cierva and, in October, 1920, "Autogiro" No 1 (Fig. 2) was tested at the airdrome of Getafe, piloted by Don Felipe Gomez Acebo, Captain of Artillery. A single run across the field was enough to demonstrate the necessity of abandoning this method. The

Then the construction of "Autogiro" No. 2 (Fig. 3), [*sic*] was begun with only one sustaining wing with five blades. A theoretical study, based on the shape which at that time was thought to be the best for the distribution of pressure, was expected to give a solution of the problem.

Two symmetrical blades, one advancing in the direction of flight and the other going back, cut the air at unequal speeds, but also at different

The lateral control of "Autogiro" No. 3 (Fig. 4), which was tested at Santa Quiteria field while No. 2 was awaiting the arrival of the duralumin tubes, was obtained by warping the blades, which was easily accomplished by the pilot. The skeptical curiosity with which the tests of No. 1 had been witnessed, [*sic*] had given place to an over-confidence in success.

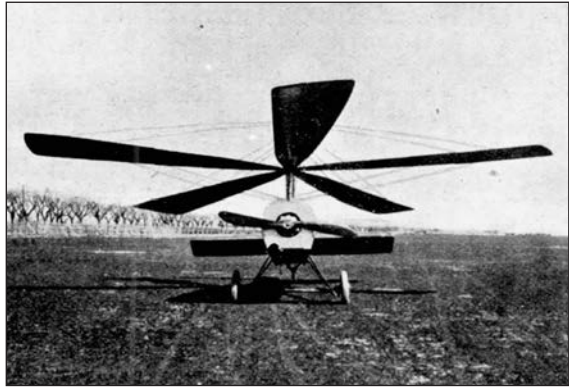

FIG. 4. Autogiro No. 3.

Before No. 3 left the workshop for the airport, another unnumbered "Autogiro" had made many flights before the eyes of the pedestrians of "la Chopera." In this corner of the park of Madrid and before the Technical Committee of the Aero Club and even a representative of the Academy of Sciences, there had been flown an "Autogiro" with a propelling force of India-rubber, a fuselage of cane, and wings of paper (Fig. 1). It took off after running only a few feet on the ground and remained in the air several seconds, covering distances of more than 100 meters (328 feet).

However, Lieut. Lecca, who piloted "Autogiro" No. 3, always made, [*sic*] at the end of his runs the same discouraging report, that the aircraft always tipped to the right (the blades, seen from above, revolving in a clockwise direction). The pilot said that he could feel the lift and that the aircraft often took the air, but completely out of balance, so that it always fell to the ground, breaking its blades on more than one occasion, when it landed on only one of the wheels of its landing gear.

This was attributed to the fact that the force exerted by the pilot was not the only force which warped the wings. The wind also altered their shape from that in which there was compensation.

At that time (April, 1922), "Autogiro" No. 2 was finished and Lieut. of Cavalry Alejandro Gomez Spencer, who had replaced Lieut. Lecca, prepared to test it. The five blades of the sustaining wing had strong duralumin struts and were rigidly braced. There was no fear that the wind would change their angle of attack. This did not prove, however, to be the means for obtaining the much-desired compensation. The distribution of pressure had been calculated according to the rectangular law adopted at that time and not according to the elliptical law which experience has since confirmed.

Lateral control was obtained in this machine by warping the tail. This obliged the fuselage to bear considerable torsion which caused some fastenings to give way, resulting in deformation. The damage done by this accident was not repaired, since



FIG. 5. Autogiro No. 4.



FIG. 6. Autogiro No. 4. [sic] on the day of its official tests, January, [sic] 22, 1923.

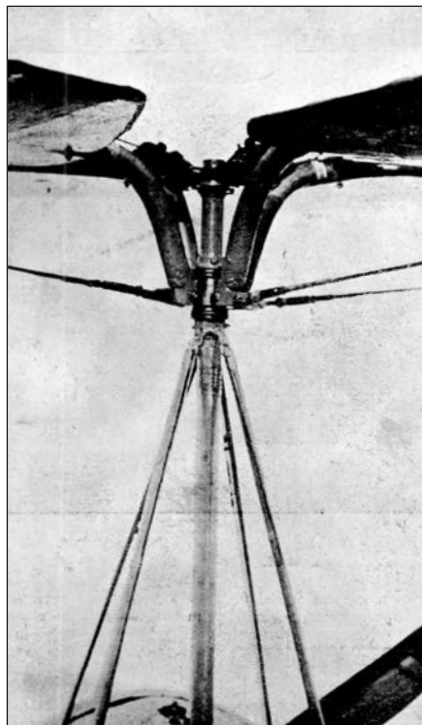

FIG. 7. Joints of Autogiro No. 4.

“Autogiro” No. 4 (Figs. 5 and 6), which took off a few months later, was already being built.

The sustaining wing of this fourth aircraft had four blades, in place of five in the second, and three in the third, but instead of their being rigidly fastened to a common shaft, they were articulated to it and could move freely up or down while revolving around it (Fig. 7). The articulation point of the blades is situated below their center of gravity and the resultant of the lift and centrifugal force acting on each blade, [sic] must pass through this point. The blade of greater lift will go up more than the opposite one and the resultant of all the reactions will pass through a fixed point in which the metacentric curve has been concentrated. Therefore, there is no transmission of moments to the axis of rotation, nor are there any gyroscopic effects, since there is no continuity in the rotational plane necessary for producing them.

Would practice confirm the theory? On January 10, last, Lieut. Gomez Spencer gave an affirmative answer. The “Autogiro” did not balance properly and fell like the former ones, not to the right, however, but to the left, that is to say, in the direction contrary to the one due to the decentralization of pressure. The reason for this lack of balance was immediately found. It was the torque of the tractor propeller

which tipped the aircraft to the left. The axis of the sustaining wing was then set a few centimeters off the central line and on January 17, the "Autogiro" left the ground and made several straight flights in the airdrome of Getafe.

During one of these test flights, on January 20, when alighting like an ordinary airplane (the only way tried until then), an accident took place which would have wrecked an ordinary airplane. The engine was accidentally started, when the pilot was nosing up the "Autogiro" in order to rest the tail skid on the ground, and the aircraft went up quickly. The pilot cut off the engine and pulled the control levers and the "Autogiro" descended vertically and alighted slowly, the pilot noticing clearly the lift produced by the rapid revolution of the blades.

The chief of the Getafe airdrome, Capt. Estefani, who, from the first had enthusiastically assisted the inventor, gives the following report of this incident:

Don Jose Gonzalez Estefani y Caballero, Ordnance Captain and Chief of the Getafe airdrome, certifies that, during a test which Lieut. Alejandro Gomez Spencer made on a flying machine designed by Juan de la Cierva y Godorniu, called "Autogiro" by its inventor, because of damage to the hand lever of the engine, the aircraft ascended suddenly to about 8 meters (26 feet), at which height it found itself without any apparent horizontal speed, in a position similar to that of an airplane with complete loss of flying speed. The "Autogiro" landed safely, however, without damage, due to the lift continuously produced by the rapid rotation of the supporting wing.

In witness whereof I sign this report in Getafe, March 10, 1923.

(Signed) Jose G. Estefani.

Two days later the official tests took place with a strong wind which the "Autogiro" valiantly combated. Soon after these tests, the aircraft was sent to the airport of Cuatro Vientos where, on January 31, it made the performance mentioned at the beginning of this article and which is attested by the following official report:

Don Emilio Herrera y Linares, Major of the Engineer Corps and Chief of the Military Aerodynamical Laboratory, hereby certifies that, in the airdrome of Cuatro Vientos, on the afternoon of January 31, last, an aircraft named "Autogiro," designed and constructed by Juan de la Cierva y Codorniu [*sic*] and piloted by Lieut. Alejandro Gomez Spencer, made three flights, the last one covering a distance of 4 kilometers (2.5 miles), in a closed circuit in 3 minutes and 30 seconds, reaching an altitude of more

than 25 meters (82 feet) above the ground (Fig. 8). Cuatro Vientos Airdrome, February 1, 1923.

(Signed) Emilio Herrera,
Chief of the Laboratory,
Sporting Commissioner of the F.A.I.



FIG. 8. Autogiro No. 4. [*sic*] flying at Cuatro Vientos Jan. 31, 1923.

The "Autogiro" has ceased to be a scientific curiosity and has become something which can be developed commercially. The tests of last January have proved that it can fly, that it is more stable than an airplane and that it can alight vertically and without speed. We have now to determine its exact efficiency, which should be at least 90% that of an airplane.

In the workshops of the Industrial School, where the most delicate parts of "Autogiros" Nos. 2, 3 and 4 were constructed, "Autogiro" No. 5 is at present being built, under the supervision of La Cierva. This aircraft will have improvements which will increase its efficiency and carrying capacity. It will be able to carry a passenger and to make long flights, which it would not have been prudent to attempt with the previous aircraft, built solely for experimental purposes. "Autogiro" No. 4 was the last of the experimental series, and No. 5 will be the first of the commercial series. Those who have followed its progress will not go to the airport simply to see it fly and descend vertically without an appreciable forward speed, but to see it compete with its elder brother, the airplane.

The "Autogiro" is not a helicopter nor an aeronautic freak pretending to solve a difficult problem of mechanics, but is a perfected airplane, although not designed with the sporting purpose of increasing speed nor with the commercial object of enlarging the radius of action, but with the humanitarian purpose of reducing to a minimum the number of accidents and the number of human lives sacrificed in the fight for the conquest of the air.

Nearly all aviation accidents are due to loss of speed, which diminishes the lifting force and leaves the airplane subject to the force of gravity. The "Autogiro" is not affected by loss of speed. An engine failure, a sudden "nose up" or a very sharp turn may interrupt its horizontal flight and make it descend toward the ground,

but the rotating blades will sustain it in the air and enable it to alight at a very low speed.

Calculations, the details of which need not be given here, lead to the encouraging conclusion that, in the least favorable case, when an accident to the pilot leaves the aircraft without control, the collision with the ground would be similar to that of a fall of a little over two feet, instead of the break-neck horizontal speeds at which airplanes now land. The "Autogiro" will land, in the least favorable case, at a speed of less than 7.5 miles per hour.

The stalling of the engine while in flight over ground which is rough or covered with vegetation, though fatal to an airplane, will only be a mishap of minor importance to an "Autogiro." On the other hand, it will probably be unable to do any looping or other stunts, like fighting airplanes. It will be a commercial aircraft, with which it will not be possible to bring down enemy airplanes, nor give dangerous exhibitions of useless daring.

These constitute two excellent qualities in addition to that of safety in case of loss of speed and its ability to alight slowly and vertically.

Translated by

National Advisory Committee for Aeronautics.

Document 5-36 (a–b)

(a) Juan de la Cierva, “The Development of the Autogyro,”
Journal of the Royal Aeronautical Society (January 1926): 8–29.

(b) Juan de la Cierva, “The Development of the Autogyro,”
Journal of the Royal Aeronautical Society
(November 1930): 902–921.

In the early 1920s, the Spanish engineer Juan de la Cierva (1895–1936) introduced the world to the “autogyro,” a word that Cierva himself coined and that was originally a proprietary term for just the Cierva machine. The autogyro (British spelling, “autogyro”) was not a helicopter, but a different type of rotorcraft that was capable of short takeoff and landing (STOL) but not hovering. It differed from the helicopter in that its rotor was not powered but turned automatically (i.e., autorotation) from the very motion of the craft through the air. The Cierva autogyro began making successful flights in 1923. Soon other inventors came to design their own autogyros. Some of them showed good enough performance that manufacturers in different countries started building variations of the machine. By the mid-1920s, when Cierva gave the following speech to the British Royal Aeronautical Society, some observers felt that the autogyro represented a dominant flight technology of the future. Proponents felt that the hybrid rotorcraft offered the best means to achieve short-field landings and takeoffs plus deliver the safe and effective “low and slow” performance that could lead to what many enthusiasts wanted from general aviation aircraft—that was, door-to-door aerial commuting.

The majority of those who witnessed Señor de la Cierva’s presentation on his invention of the autogyro at the third meeting, first half, second session of the British Royal Aeronautical Society in late 1925 (the first of two documents in the string below) seem to have come away quite impressed. As readers will see at the end of the document below, the master of ceremonies who opened the question-and-answer session following Cierva’s talk began by saying, “I think we are all agreed that we have seen to-night one of the most wonderful inventions since the original invention of the aeroplane itself.” This opinion would spread far and wide from the mid-1920s well into the 1930s, a period when this class of rotorcraft “far outshone the helicopters of the period” (Liberatore, *Helicopters Before Helicopters*, p. 71). In late 1925, for example, the British Air Ministry dropped its support of Louis Brennan’s experimental work on a helicopter. This was one year after the Air Ministry had offered a prize of £50,000 (about \$250,000 today) if anybody could produce a helicopter capable of doing a short list of rather simple things. The list included attaining an altitude of 650 meters (2,130 feet), climbing straight up and

down; hovering for 30 minutes in a 35-kilometer (22-mile)-per hour wind; performing a circular flight of 32.2 kilometers (20 miles) at 95.5 kilometers per hour (kph) (or 60 mph); landing safely with power off in a small area; and carrying a pilot, 1 hour's worth of fuel, and a load of 68 kilograms (150 pounds). The contest attracted 18 entries (8 of them from the United States), but not a single entrant materialized, and no competition was ever held. Brennan's machine was the sole British entry, but it never came close to performing well enough to compete. Some skeptics wondered at the time whether the British canceled the event because their country's own entry was not ready. But the truth of the matter was that the failure of any entries to materialize symbolized how far helicopter development still had to go to be competitive. When autogiros started to fly successfully at just this same time, it was no wonder that many people questioned whether the helicopter would ever become efficacious. Liberatore has concluded in his history that the British decision to drop helicopter development in the mid-1920s was definitely "reinforced by the promise of the Cierva autogiro" (p. 67). One way to interpret the relationship between helicopters and autogiros during this period is to say that the growing commitment to the autogiro retarded the development of the true helicopter, at least temporarily.

By the time Cierva gave his second presentation to the Royal Aeronautical Society in November 1930 (the second document below), readers may detect a slight cooling off of enthusiasm for the autogiro. More aware of the actual performance of this type of machine, several of those who spoke during the discussion following Cierva's talk reiterated their faith in the future of the autogiro and its unique capabilities but expressed greater concern for its many problems and limitations. By the time he gave a third talk before the Royal Aeronautical Society in December 1935 (not included here), some of the discussants clearly indicated a preference for greater efforts on behalf of a true helicopter over continued development of the autogiro.

By the end of the 1930s, the autogiro fad had mostly passed, in part because Cierva died in an airliner crash at the Croydon aerodrome, near London, in 1936. But the fundamental problem of the machine was that it could not hover—and hovering was the ultimate goal that rotary-wing enthusiasts sought. Still, thanks to autogiros, some significant improvements were made in the technology of the rotor head and rotor blade. Many of these improvements transferred over to the helicopter field and expedited helicopter design when the first practical helicopters appeared in the late 1930s. Again, one can only wonder what would have happened if the course of this technological development had been different and practical helicopters had been available in World War II. All one has to imagine is how the Allied armada on D-Day might have assaulted (and bypassed) the beaches at Normandy if waves of helicopters had been a part of the action.

*Document 5-36 (a), Juan de la Cierva, "The Development of the Autogyro,"
Journal of the Royal Aeronautical Society (January 1926): 8-29.*

Mr. Chairman, Ladies and Gentlemen,

I began to work in aviation in 1911 and experimented with gliders, brought very much into vogue again recently in connection with sailing flight.

In experimental flights on these gliders my brother and I had some rather dangerous falls due to loss of flying speed, the most prolific cause of accidents to aeroplanes in their present form. The problem of removing this source of danger from aviation has seemed to pursue me throughout my aeronautical work, and has directed my investigations up to the present moment.

In 1912 I constructed my first power-driven aeroplane, a biplane, followed by a monoplane in 1913. In 1918 I had constructed a large biplane with three engines which, after most satisfactory trial flights, was wrecked precisely by losing flying speed. The accident diverted all my energies to the solution of the problem of eliminating this danger; for the possibility of losing flying speed and the uncertainties of landing are, in fact, the only faults with which we can reproach the aeroplane, which otherwise is practically perfect in point of speed and maneuverability.

The two problems are, in reality, one and the same, and apart from more or less secondary considerations the problem is solved if we can find a flying machine with stability entirely independent of its speed and which, consequently, can fly or descend with a wide range of incidence, practically from $.0^\circ$ to 90° , as compared with the narrow range of incidence, 0° to 15° , permissible in aeroplane flight.

In 1919 I had the idea of using as lifting surface a windmill with vertical axis driven solely by the relative wind, a component of which, parallel to the axis, was to be obtained by beating of the wings as in an ornithopter, and this was held sufficient to maintain rotation in horizontal flight. An engine would drive an ordinary tractor airscrew and would furnish power for the beating movement. If the engine stopped the windmill would act as a parachute, permitting a vertical descent. This design remained on paper, for it very soon became clear that a lifting windmill of this kind would turn without any flapping action provided the axis was slightly inclined backwards from the vertical.

The chief difficulty was now the asymmetry of lift on the wings, for the wings rotating against and with the relative wind would have their average velocities through the air respectively increased or decreased, with a corresponding asymmetry of lift and a displacement of their resultant lift from the vertical, leading to a sideways movement and ending probably in a sideslip.

The first solution that suggested itself was the use of two lifting windmills of opposite symmetry and rotation, mounted on the same axis, and this was embodied in the design of my first "Autogyro," to use the generic name given by reason of the fundamental characteristic common to all my designs, of turning automatically.

Figs. 1-3 show Autogyro No. 1 with two windmills of four blades each, on the same axis turning in opposite directions, the axis being mounted on the fuselage of an old Deperdussin, with a 60 h.p. Rhone engine, driving a four-bladed tractor airscrew. The controls consisted of an elevator, a rudder and a single aileron mounted vertically on the top of the axis of the two windmills.

Revolution counters fitted to each windmill, [*sic*] separately gave observed values for comparison with calculations. The agreement was satisfactory in the case of the upper windmill, but the lower windmill ran at only two-thirds of the expected speed with consequent lack of compensation of the lateral forces.

A differential gear could have been employed to impose equal angular velocities mechanically, but the increase in the already considerable complication, the mechanical losses and other secondary considerations all led irresistibly to the conclusion that one lifting airscrew only should be employed. An alternative solution for lateral stability was therefore sought along the following lines.

Applying the blade element theory of airscrews it was clear that greater relative speed might be compensated by a smaller relative incidence in elements diametrically opposite.

If it were possible to choose the aerodynamical characteristics of each element and to control its incidence so that the resultant lift couples of the opposed blades (not necessarily of each element but the resultants summed over all elements) should be in equilibrium the problem would be solved.

The detailed computations were laborious, for the compensation must be effective at all incidences. After several formal investigations and innumerable trial solutions I achieved the design of the second type of Autogyro (Fig. 4). It consists of a single windmill, with the cantilever blades capable of being set at varying incidence by the pilot, who could thus displace the resultant lift to right or left at will. This is, in fact, a very effective lateral control.



FIG. 1.

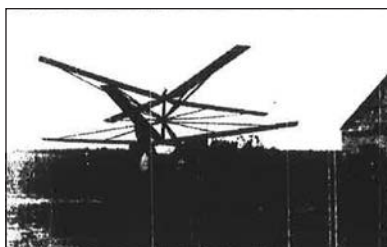

FIG. 2.

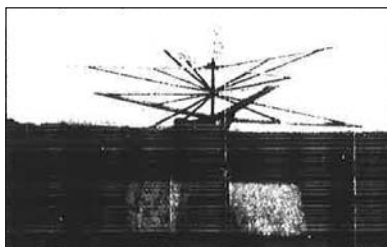

FIG. 3.

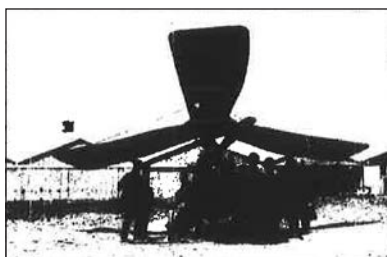

FIG. 4.

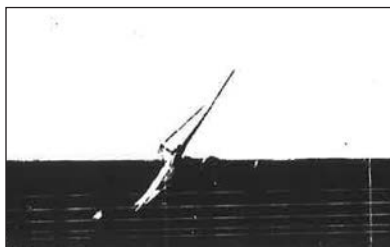

FIG. 5.



FIG. 6.

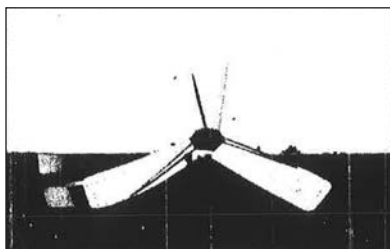

FIG. 7.

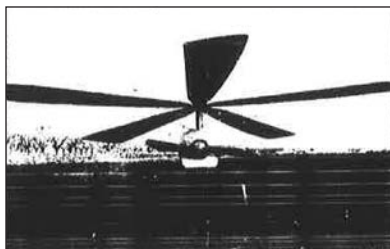

FIG. 8.

The engine was at first a 50 h.p. Gnome, later an 80 h.p. Le Rhone.

The first results were encouraging, for the machine in taxiing at the aerodrome of Getafe, near Madrid, in the beginning of 1921, developed the calculated angular velocity of the windmill and an adequate lift. But, unfortunately, as soon as the pilot brought the machine into the appropriate attitude for flight, it inclined towards the wing which was rotating contrary to the direction of flight; in this case the right wing. The rotation of the windmill was clockwise looking from above. (In the latest type it is anti-clockwise.)

It followed that the distribution of pressure did not agree with my assumptions and calculations.

An attempt was made to control the variation of incidence of the blades by means of a lever operated by the pilot, but the same trouble always reappeared, leading to serious damage, the machine being reconstructed nine times in the course of the experimental work.

After a large number of trial modifications of the wing profile, it appeared that the discrepancies would be accounted for by torsion of the unbraced cantilever blades, which had not sufficient torsional rigidity to withstand twist and consequent change of effective incidence caused by shift of the centre of pressure.

These torsional forces evidently alternate with each complete revolution.

Following on this, the third type of Autogyro was designed, based on the same general principles, but with heavy bracing of the blades to the axis, by streamline high tensile steel wires, as in aeroplane practice.

Autogyro type 3 was ready for test in the beginning of 1922. It had a lifting windmill of five rigid blades, lateral control being obtained by the differential effect of a large elevator divided into two independent parts right and left. The fuselage was designed to take the resulting torsional couple.

The engine was a 100 h.p. Le Rhone.

This machine showed a closer approach to lateral balance than the former, but always had a tendency to fall over sideways, which the split elevator was insufficient to control. It was damaged and rebuilt four times in the course of these experiments.

The idea of using articulated blades had come to me in the beginning of 1922.

It is a fundamental point in the design of the Autogyro exhibited at Farnborough, affording as it does a complete solution of the problem of stability, and incidentally, of numerous other problems of design.

Thus, during completion of the tests of type 3, the first Autogyro of type 4 was already being constructed to my new designs.

This machine had a single windmill with four rotating blades, but instead of being rigidly attached, they were hinged near the root (in the latest designs the hinge pins are at 2° with the axis of the windmill). The blades were thus able to move freely about their hinges, beating the air, so to speak, freely, without any sensible change in their geometrical incidence, the chord remaining always practically parallel to its original position for small amplitudes of beating movement.

Rubber shock absorbers, or "Sandows," keep the wings in position when at rest and prevent them from flapping downwards till supported by contact with the earth or with other parts of the machine.

In rotation, centrifugal forces act on the blades and are large enough to keep them nearly perpendicular to the axis. By the construction the resultant force acts at a point in the axis above the hinge pins.

The aerodynamical and mechanical problem is highly complex, but there is one great simplification which can be stated at once. Since the blades are articulated the total reaction on each blade, that is the resultant of all the air forces and inertia forces, acting on it must pass through the hinge pin.



FIG. 9.



FIG. 10.

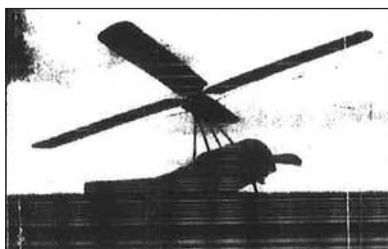

FIG. 11.

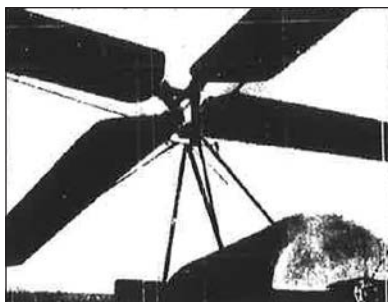

FIG. 12.

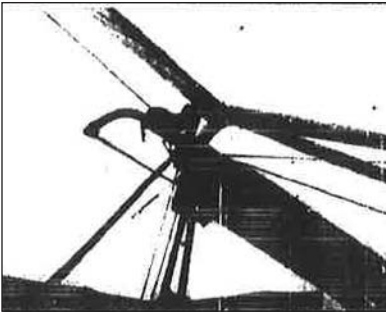

FIG. 12A.

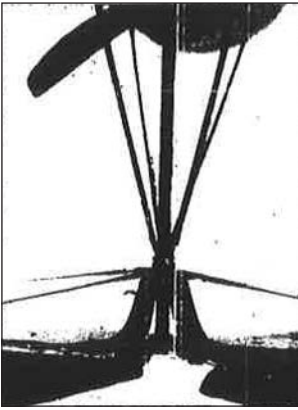

FIG. 13.

Finally the articulated blades form a flexible system in sudden gusts. The inertia forces are ten times the lift forces, the resultant being $\sqrt{(10^2 + 1^2)} = 10$ very nearly. In a gust producing ten times the air forces the resultant would be $\sqrt{(10^2 + 10^2)} =$



FIG. 14.

Perpendiculars drawn between hinge pins and axis meet in a common point on the axis. Since these perpendicular distances are small the resultant of the four-blade reactions may be taken as active at this "common point." This resultant is in general inclined slightly to the axis, and by giving an equal and opposite inclination to the axis, the result becomes vertical.

If the centre of gravity is below the "common point" the aeroplane is in equilibrium, in spite of the asymmetry of the forces on the blades.

The "common point" may be called the metacentre of the air forces and inertia forces on the blade system. It is nearly independent of incidence, speed, etc.

The centre of gravity is relatively very low, hence there are always high restoring forces bringing the machine back to its position of equilibrium. At the same time there are high damping forces preventing resonance, i.e., oscillations of increasing amplitude about the position of equilibrium, as might be feared from the low centre of gravity.

The damping does not, however, interfere with ordinary maneuvers.

Gyroscopic forces, which would be of the severest nature in a rigid system, cannot be transmitted through the flexible attachment of blades to axis.

14.1 approx., an increase of only 41 per cent. [*sic*] over normal stresses.

In the first machine of this type, lateral control, though unnecessary in theory and it would seem in practice, was provided for by tilting the axis of the windmill to the right or left; but it became immediately evident in the very first tests that the pilot's strength was insufficient to work the control.

After many months of exploration, "crashes," and rebuilding (this particular machine was reconstructed or modified fifteen

times in all) I had recourse to a more logical system of control, fixing the windmill axis rigidly and building into the machine two small non-lifting ailerons at the end of streamlined spars.

From that time onward the machine, which had demonstrated in the course of the year 1922 the value of the articulated system, making hops without inclining to the side, was ready to be used in real flight, and on 17th January, 1923, it flew right across the aerodrome at Getafe at a height of several metres.

It was transported thence to the aerodrome of Quatro Vientos [*sic*] (Four Winds), near Madrid, and on 31st January, 1923, carried out a flight of four minutes at a height of more than 25 m., in closed circuit, officially observed and controlled.

It is, so far as I know, the first real flight ever carried out by a machine, heavier-than-air, differing from the conventional aeroplane.

The pilot was Lieut. Gomez Spencer, of the Flying Corps of the Spanish Army.

After this success type No. 5 was designed and constructed on the same principles, but with important improvements in detail.

This machine had only three blades and the details of construction were carefully worked out. The engine was a 100 h.p. Le Rhone.

Several preliminary flights were successfully carried out, but before it had been brought to its proper trim it was completely broken up by an accident while taxiing.

At this point the Spanish Army aeronautical authorities took the responsibility of continuing the experiments

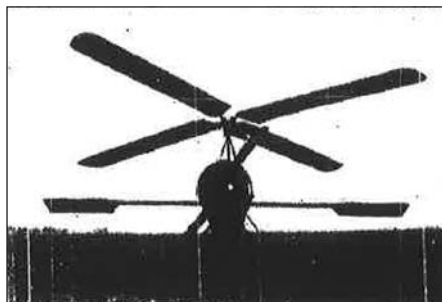

FIG. 15.



FIG. 16.



FIG. 17.



FIG. 18.

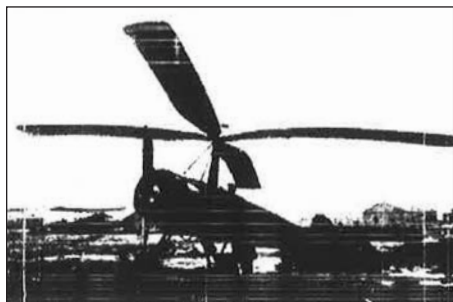

FIG. 19.



FIG. 20.



FIG. 21.

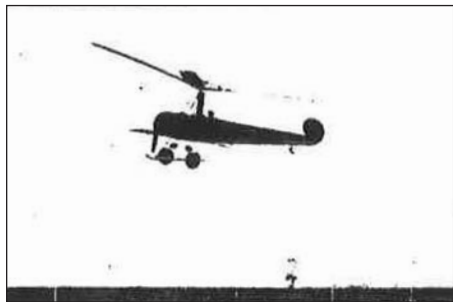

FIG. 22.

and sanctioned the construction of any Autogyro of type 6 in the military workshops at Quatro [*sic*] Vientos.

The third machine of this type to be constructed was that shown at Farnborough recently.

It is made up of a standard "Avro" fuselage with a 100 h.p. Le Rhone engine, with two lateral ailerons (non-lifting), a carriage somewhat larger than the standard "Avro," and a four-bladed windmill. The blades have a section in the axial plane, designed so that the resultant force at each point is along the blade. Thus, the single longeron, in [a] steel tube, is in pure tension, very nearly, the bending moments being almost nil.

The symmetrical section (Gottingen No. 429) is almost free from movements of the centre of pressure and from consequent torsional forces.

They are mutually braced by wires kept in tension by the centrifugal force on small leaden weights.

This machine commenced its flights in May, 1924, but other engagements prevented definite trials till December, 1924. On the 9th December, 1924, Captain Loriga, of the Spanish Military Aviation, made his first flight, rising to 200 m. and landing almost vertically.

He is unfortunately prevented by serious illness from demonstrating his control of the machine in this country.

On 12th December, 1924, Captain Loriga made a flight of 12 km. between the aerodromes of Quatro Vientos [*sic*] and Getafe, the first air voyage in an Autogyro.

Figs. 21 and 22 show the departure and arrival.

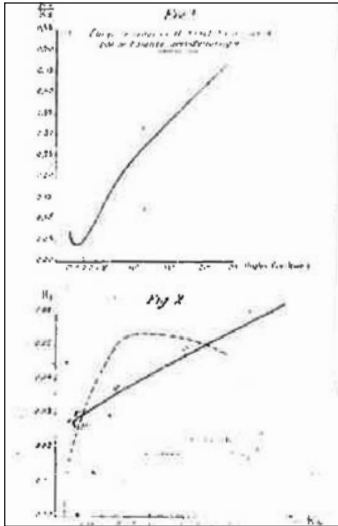

Type 6 has been completely remodelled twice, which gives a total number of 32 distinct machines built and tested in order to arrive at the results demonstrated earlier in this week before many of those present to-night.

DISCUSSION

Mr. Lock said: I think we are all agreed that we have seen to-night one of the most wonderful inventions since the original invention of the aeroplane itself. Before thanking the Lecturer very much for his most interesting lecture, I should like to ask him one or two questions dealing with the actual working of the machine. First of all, whether he can tell

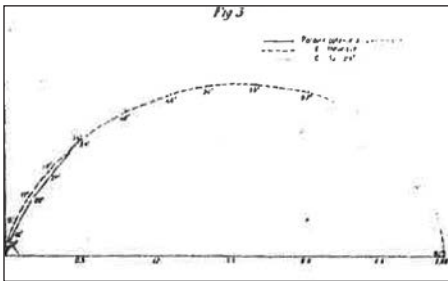

us if there are any conditions which may occur in flight which might stop the windmill from rotating? It seems likely that such conditions might occur when flying at very high speeds. This does not seem likely to occur on landing, but in flying at very high speeds the rotating wings might have a difficulty in maintaining rotation. I should like to know the smallest angle to the wind at which the windmill would maintain rotation.

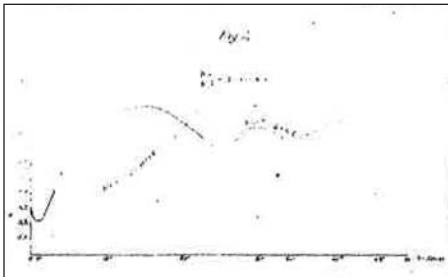

Secondly, whether there might possibly be a danger of the rotating wings stopping if the machine dived very rapidly at a high speed and then checked itself by raising the elevators as in an ordinary aeroplane when diving and flattening out.

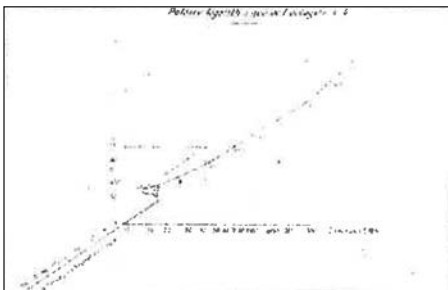

Thirdly, what would be the actual velocity of descent in a very steep glide?

Fourthly, would it be possible for the machine to descend absolutely vertically at a safe speed apart from considerations of stability? It appears that the machine does come down at an extremely steep angle, but we do not know what was the velocity of the natural wind.

I have been very much impressed by the lecture and films and was fortunate enough to see the machine fly at Farnborough. It was one of the most wonderful sights I have ever seen.

The following additional questions were communicated to the Lecturer in writing: In connection with the first question, whether the wind tunnel tests showed a tendency for the screw to cease to rotate at very small angles of disc incidence, since it was probably possible to obtain smaller angles of incidence in the wind tunnel than could be obtained by the machine in actual flight. In connection with the fourth question, I should like to ask whether you anticipate that the resistance of the Autogyro, in falling vertically, would be very much greater than that of a parachute of area equal to the disc area of the Autogyro, since a simple calculation indicates that a parachute having the same area and loading as the Autogyro would fall at a velocity of between 30 and 40 feet per second.

The CHAIRMAN gave the provisional reply, that if a starter were applied to bring the windmill speed up to 120 r.p.m. the unsticking speed would be about 15 m.p.h.

A device for the speeding up at standstill was the next step in development.

The surface was less than half that of a standard Avro, the weight 600 lbs. more. The speed attained by Captain Courtney was 68 m.p.h. without ailerons, and with reduced weight higher speed would be attained.

Major F. M. GREEN said that he owed a double debt of gratitude to the Author of the paper, firstly for giving us an account of his invention, and secondly for calling it an "Autogyro" and not a "Helicopter." It was not very long ago since the speaker had himself read a paper before this Society in which the possibilities of the helicopter were discussed, and then he gave it as his considered opinion that the chances of this type of aircraft being successful for transport purposes were remote. If Senor [*sic*] de la Cierva had chosen to call his invention a helicopter it would have been unfortunate for the speaker, and he therefore agreed whole-heartedly with the Author of the paper that this successful machine is not a helicopter but an Autogyro.

As it seems very likely that the name of Senor [*sic*] de la Cierva's invention will become a household word, the speaker hoped that we should find a shorter word than Autogyro; perhaps the inventor will help us to find one.

The particular point about which the speaker would like information concerns the rate of revolution of the windmill. It seemed to him that if this did not vary much in speed the structural design would not be difficult. The stresses on the revolving blades depended almost entirely upon the rate of turning, and if under no circumstances would this increase by more than a small percentage above the normal rate of revolutions, then the variation of stress during flight would be much smaller than in an aeroplane of the ordinary type. When the pilot made any sudden maneuver it was inevitable that the accelerations which resulted should increase the apparent weight of the apparatus. On an ordinary aeroplane of the single-seater

fighter class we know that accelerations of five times gravity are not unusual. So long as the rate of turning of the windmill did not increase, the extra loads will take care of themselves, as the inclination of the blades would change so that the resulting force along the axis of the windmill was increased to supply the force required.

In conclusion, Major Green wished to congratulate Senor [*sic*] de la Cierva most sincerely on having brought before their notice what was undoubtedly an invention of the first importance, and he wished also to express his thanks to Colonel Wimperis for having arranged matters so that the demonstration and lecture became possible.

Mr. Handley Page said: I should like to join the previous speakers in thanking the Author very much for his interesting paper, and congratulate him on the successful results which he has achieved after many years of research work.

On Monday last I had the pleasure of seeing the machine from the air, being a passenger in one of our three-engined aeroplanes which was flying over Farnborough. From the air the machine looked for all the world as though it were a toy spinning top which a boy had wound up and sent into the air.

From a technical point of view, it would add greatly to the value of the paper if the Author could give some technical data in regard to the lift and resistance of his machine. After all, the Autogyro is an aeroplane and follows the same laws governing an ordinary aeroplane. The inventor has only changed a fixed plane for a rotating one, and by so doing has obtained a much wider range of lift and, presumably, also of drag. It would therefore be of great interest to all the technical members of the Society if he could add to his paper some details of lifts and resistances over a wide range of angles of inclination of the machine and speeds of rotation of his planes.

One has heard a good deal in the last few days in the popular Press about machines of this type being able to land on roofs, but I would remind Senor [*sic*] de la Cierva that for such a landing one must presumably have a flat roof. Most of the roofs in England are not flat, being designed to drain off the rain. If, however, the machine did find a flat roof on which to land, how would it fly off? There seems at the present time no means by which the machine could make a vertical ascent such as is associated with the helicopter. I should be very glad if Senor [*sic*] de la Cierva could give further technical information as to the shortest distance in which the machine could ascend and whether there is any possibility of incorporating the full helicopter effect for an ascent. I should be very interested to know what the loading is on the planes of the Autogyro. It would seem that the speed on landing is greatly reduced, but has this reduction in speed been obtained at the expense of top speed? From the figures given it would appear that the machine is slower than an ordinary Avro. If the top speed were increased to that of a normal machine, would Senor [*sic*] de la Cierva propose to do this by cutting down the area of the propeller blades and so increasing the loading, and when the loading was so increased, would not the slow speed be correspondingly increased? There are many ways in an ordinary

aeroplane by which a greatly decreased slow speed can be obtained, but it is nearly always at the expense of top speed.

Senor [*sic*] de la Cierva mentioned that the tip speed of his blades was constant, no matter what the size was, and presumably under all conditions of the varying attitudes of the machine in flight this would hold good. Is this due to some basic fundamental theory, and if so, could Senor [*sic*] de la Cierva give reasons for it?

There is another side upon which one would like further information, and that is from the constructional point of view. The blades of the propeller are supported on a single tubular axis. Are they not, as in an ordinary blade of an aeroplane propeller, subject to torsional forces, or are these small in comparison with the centrifugal forces? Would not difficulties arise if the aircraft were made in a large size?

I would like to know whether Senor [*sic*] de la Cierva could give any comparative figures as to what the weight of his machine is compared with that of an ordinary aeroplane.

Finally, Senor [*sic*] de la Cierva is to be congratulated on having both the perseverance and financial resources at his disposal to carry his experiments through to the successful result which we have seen demonstrated in this country under Captain Courtney's piloting.

Professor Bairstow said: I have listened with very great interest to the account which has been given of the Lecturer's early attempts to produce the Autogyro. Although the pictures have been extremely interesting it appears to me that they have not given quite so good an account of the machine as they might. It made a great impression on me to see it come down some hundreds of feet at an angle of 60° to the ground and then run forward only a few yards. That, of course, is the feature of the Autogyro on which most stress has been laid, and that seems to be its chief merit. Although the complete aircraft can go forward at 20 m.p.h. in still air the tips of the screw themselves are moving at 150 to 200 m.p.h.—depending a little on the conditions of flight. Consequently one can see in that fact a reason for very high lift coefficients and the very high wing loading of 25 lbs./sq. ft. without departing from a knowledge of the existing aerofoils to-day or the necessity for assuming new and unexplored types of air flow. That encourages me to go a little further; although Major Green says he is pleased that the apparatus has not been called a helicopter, and in fact has some important differences from the latter, yet one of his remarks in a lecture to the Society some years ago bears very much on the efficiency of the Autogyro at high speeds. If an aerofoil is to be used at all with the normal types of airflow, it must have a limiting value to the ratio lift/drag which is not at the choice of the inventor and which is available for the aeroplane. The work done in moving the aerofoil under best conditions is proportional to the distance they move and the aeroplane in going straight from point to point does least work. The coiled path of the aerofoils of the Autogyro screw is much larger, and as a necessary consequence the device must be less efficient at high speeds than the aeroplane. It should, perhaps, be pointed out here that high speed aeroplanes

do not fly at their best angle of incidence and that the restriction may not apply to the Autogyro. On the other hand, the Autogyro has still to achieve speeds in excess of 70 m.p.h.

In the construction of this machine one can but admire the extreme mechanical simplicity of all its parts. The hinging of the blade screws at the central hub, the bending of the blades so that there is tension only along the spar are admirable devices for avoiding stresses not only in the screw but in the aircraft generally.

It seems to be one of the rare occasions when nature has presented gifts to the inventor. A screw is produced which auto-rotates and is free from high stresses. It proves to be very stable and the flapping essential in the stress problem does not adversely affect the aerodynamic behaviour. There are, however, some gifts withheld as usual; the possibility of hovering in still air or of rising vertically from the ground does not come with the device as exhibited.

I would like to congratulate the inventor on his device and on the extraordinary success which his tests have had in this country.

Mr. Manning said: Mr. Handley Page has already mentioned that we should like to know more about what is generally known as the lift-drag ratio of the wing itself. I understand from what General Brancker has said that the rotary speed of the wings is constant under all conditions. I presume that consequently the wing lift would vary as the square of the speed of the machine, and that as the weight of the present machine is understood to be 2,000 lbs., an 8,000 lb. machine with a speed range of from 20 to 130 m.p.h. could be made with the same diameter of revolving wing. It would be interesting to have some information as to the resistance of the wings of such a machine. In any case, the machine has one important feature—its low speed is 10 m.p.h. and its top speed 68, so that it has a speed range of $6\frac{1}{2}$ to 1, and that has never before been attained.

I congratulate the inventor on his most important contribution to the science of aeronautics.

Mr. Harris Booth said: Two months ago I should have had a lot of questions to ask, but since then I have had the great pleasure of seeing his machine fly in Spain and carry out all the tests that were asked of it, and now I have seen his films I cannot think of anything to ask him. I can only congratulate him again.

Captain Sayers [said]: There are many questions I should like to ask the Author. Many have already been asked, others require further consideration than has been possible this evening. In common with other speakers, I would congratulate Senor [*sic*] de la Cierva upon having produced an extraordinarily interesting and entirely novel aircraft—an achievement second only to that of the Wright Brothers.

One gentleman at Farnborough, having seen the machine make four flights, said, "I have seen it, but I don't believe it." There is some excuse for his incredulity. It is very difficult to estimate the possible future of this type. By giving the wings a speed of rotation which is independent of the forward speed of the machine as a whole it is possible to reduce the landing speed indefinitely—in fact to zero. As

forward speed can obviously be produced, a speed range of zero to something—an infinite range in fact—is possible. The present machine claims 10 m.p.h. to 68 m.p.h.—a very big range indeed on a high horse-power loading. Obviously there is room for very much experimental work in order to see how far this speed range can be extended up the speed scale.

In any event, this Society is to be congratulated upon having secured from the Author one of the most important and epoch-making contributions in its recent history.

Mr. J. L. Hodgson said that he also wished to be among those who congratulated Senor [*sic*] de la Cierva on his epoch-marking achievement. As in the case of the Wright Brothers, the main advance he had made was that he had achieved stability of his lifting surfaces under flying conditions. The solution he had come to was an amazing and an unexpected one. But, brilliant though it was, it seemed inevitable that any device which depended upon flexible propeller blades and lead weights slung on wires would in the end prove but a temporary expedient. The flexible wing of the Wright aeroplane had very quickly become a thing of the past.

Some years before Senor [*sic*] de la Cierva commenced work upon the first of his 32 machines, namely, in 1915, the speaker had, in an attempt to solve the helicopter problem, carried out elaborate tests on propellers working at positive and negative speeds of advance and also inclined at various angles to the direction of motion.

These tests were the first quantitative tests ever made at negative speeds of advance, or upon propellers inclined to the direction of motion. The tests at positive and negative speeds of advance were published in a paper entitled, "Tests on Model Propellers," which was read before the Institution of Automobile Engineers in 1917, and which it would probably be worth while now to reprint in the Society's proceedings.

The curious instability which occurred at moderately low negative speeds of advance, which showed that three different propeller speeds and three different torques would give the same thrust at the same speed of fall should be noted (see Figs. 4 and 5 of the 1917 paper) [*not reproduced*].

The photograph shows the apparatus, illustrated in Figs. 2 and 2a [*not reproduced*] of the 1917 paper, being used to test a propeller working at a small inclination to the direction of motion in a rectangular flume passing

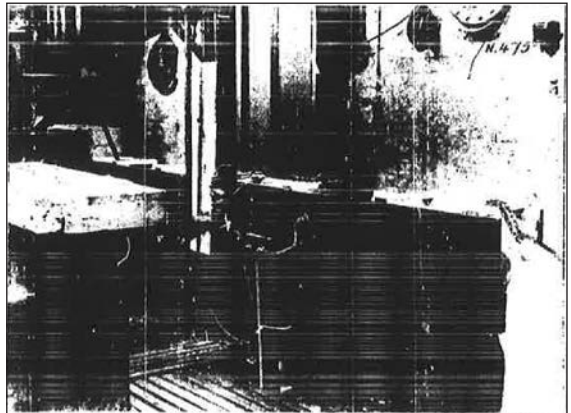

about 100,000 gallons of water per hour. These tests on inclined propellers, which were very elaborate, have never been fully published. Certain data from them were however used in criticising Major Green's attack on the helicopter in 1923. In the course of that discussion the writer, while agreeing that the work on helicopters as then being pursued by the Air Ministry was futile, said:

If one imagined a helicopter which had horizontal motion before it got off the ground (see Fig. 20 of the paper before the I.A.E.) [*not reproduced*], such a machine could get off the ground by running along and gradually climbing, and would require very little more horse-power than the equivalent aeroplane. Similarly, if the engine broke down and it was still possible to maintain the stability of the machine, it could glide down as the aeroplane does.

This was only repeating what had previously been said in the 1917 paper, viz.:

The same series of tests upon inclined propellers also showed that it would be possible to construct helicopters of very much smaller size than the unwieldy, hovering machine first considered; provided that these smaller helicopters ran along the ground so as to obtain initial velocity before rising,

and showed that so far back as 1915 the speaker, as a result of many months of research, had clearly seen that the helicopter problem would be most easily and surely tackled by means of machines which had horizontal motion and not (with our present ratio of horse-power to weight) by machines which attempted to hover.

A machine which roughly embodies these ideas was sketched in various attitudes of flight in Fig. 20 of the 1917 paper. The only essential feature in which that machine differed from the one now developed by Senor [*sic*] de la Cierva was that two symmetrically placed propellers rotating in opposite directions were used for balancing the torques and lifts in place of the single propeller used by Senor [*sic*] de la Cierva. This single propeller was the most notable part of Senor [*sic*] de la Cierva's great achievement. The system sketched by the speaker in 1917 had however the advantage that rigid propellers could be used, provided that these were so made or supported that they would not be damaged by bumpy landings. Their use would probably become inevitable in the case of big machines, and there was no need to limit the number of propellers to two (see Fig. 18 of the 1917 paper) [*not reproduced*].

The speaker's 1915 tests were also of interest because they were the first accurate quantitative tests taken on propellers in a closed tunnel—as against the whirling arm of Langley (see Fig. 2 of the 1917 paper); and also because the tests were taken in water (dimensional equations being used to allow for the “scale” effects),

which enabled low speeds and high thrusts to be obtained with small and easily made propellers.

The speaker had been developing the technique of such water tests made in connection with air problems since 1909.

In conclusion, the speaker very much regretted the lack of imagination on the part of the Air Ministry of this country as compared with that of Spain. Had the necessary support been forthcoming in 1915, or later, it is almost inevitable that the great step now made by Senor [*sic*] de la Cierva would have been made by English engineers.

Major Low said: I must congratulate Senor [*sic*] de la Cierva on a very remarkable scientific success, and it begins to look more and more probable that he also will score a practical success in the near future. But that does still lie in the future. I think practically the whole range of the performance can be analysed by the usual blade element theory which in combination with the Prandtl corrections will suffice to tell us all about this machine. But there is a new combination of known physical properties and this leads to new complications in the routine calculations which will take a considerable time for our airscrew experts to work out. But I believe this can be done along well-known aerodynamical lines.

Senor [*sic*] de la Cierva has established a reputation for making good all his claims, he has claimed no more than he has performed, and that is a very valuable reputation to establish.

In conclusion he would refer to one of the important questions raised. Professor Bairstow had pointed out that as the blades must travel farther than the aeroplane the energy expended by the drag must be greater. But it must be remembered that the blades are long and narrow and have no bracing, so that their drag is a small proportion of the drag of a complete aeroplane. The body travels at the normal speed and the increased work is in respect only of a small fraction of the total, so that the effect is not so unfavourable as at first sight it might appear.

He thanked the Author for his paper and for the introduction of a new and intensely interesting problem of aircraft design to the aeronautical world.

Mr. Wimperis said: I think the Society is very much to be congratulated upon having got Senor [*sic*] de la Cierva to give us this lecture and our Transactions will gain greatly by its incorporation. No doubt the Lecturer will find it possible to include an appendix of technical matters such as the relationship of the rotational speed to the area of the wings and the load carried. Of course in an invention of this kind, an invention in which the wings are so hinged at the hub as to be capable of being folded up like an umbrella blown inside out, it is natural to speculate as to safety. Perhaps the most effective way to envisage the safety of the device is to ask what a pilot would have to do if he wanted to kill himself, supposing he was flying in an Autogyro. In an ordinary aeroplane there are several obvious ways by which he could attain his end, but in an Autogyro it might prove more difficult. I should like to know whether should he bank very suddenly, or loop the loop, would he then be likely to succeed in his object?

When I first saw this machine in the air I realised what courage must have gone to the first flying of machines of this character. I certainly felt with our Chairman that Captain Courtney, who flew it in this country, showed uncommon courage. We had to have someone to take the place of the Spanish pilot who fell ill, and Captain Courtney did it with complete success. When I saw this machine in flight with no wings, and looking rather like a rotating St. George's cross, and felt that I did not know what was holding it up, it reminded me of the saving of that other famous Spaniard, Sancho Panza, that "behind the cross stands the devil."

Sir Sefton Brancker said: With regard to the discussion, the Author has asked me to say that he would be most grateful if all those gentlemen who made queries during the discussion, and any others who wish for further information, would communicate with him by letter. He will in due course answer them in full.

I agree that the films do not really do the machine justice. They show it taxiing at great length, which gives the impression that it is making a long weary struggle to get off the ground; this is not at all so in actual fact.

This invention has caused a certain amount of despondency and alarm amongst some of our designers and constructors. It certainly is rather disturbing to have this completely new idea thrust upon us. We have most of us been sceptical about the helicopter, and here suddenly we have a machine which does practically everything that the helicopter sets out to do with the exception of vertical climb.

Mr. Wimperis raised the question of the impossibility of committing suicide on such a machine. I went into that question very carefully with the Author, and he assures me that a pilot, even of my ability, which you all know is not of the greatest, could not hurt himself, no matter what he did in the air.

It has one serious drawback to my mind. It seems that it is going to do away with the skilled pilot; we shall have nothing to do but to navigate in the future!

In addition to the other questions which are going to be sent to Senor [*sic*] de la Cierva, I propose to furnish him with the specification and performance of one of our standard air transport machines and ask him what that machine could do if its planes were replaced by an Autogyro. His reply should be extremely interesting.

There is one point which has not been emphasised during the discussion, but upon which the newspapers have laid considerable stress. Too much importance is attached to the fact that this machine in case of a forced landing can land very slowly and in a small space. I think that in air transport we have reached a point of reliability where no one would dream of completely changing the design of the fleet in order to attain this end. We must stop having forced landings and not design new machines for this sole purpose. What is of much greater importance is that this new type of aircraft should be able to rise from a very small space. It has not done it yet because no mechanism exists for spinning the windmill up to flying speed before taking off, but when this is done it should climb rapidly after attaining a forward speed of only ten miles an hour. This will revolutionise the problem of providing air ports near great cities.

We must remember that this is only the first experimental step. There are many problems and difficulties which will present themselves. For instance, the cooling of the engine. I think that you will all agree with me that we owe to the Author our most sincere gratitude for placing his invention before us and writing this paper. We would like to congratulate him again on his really magnificent achievement, an achievement which many of us believe will have a revolutionary effect on aviation in the future.

Colonel J. D. Fullerton, Royal Engineers (retired) (*contributed*):

1. The great point about this machine is, that it enables a landing to be made nearly vertically, so that only a small space is required for the maneuver.
2. The machine itself somewhat resembles the ordinary aeroplane, but it has one very important point of difference, viz., the supporting planes are replaced by an approximately vertical airscrew, which when put in motion by the horizontal advance of the machine, revolves and lifts the whole apparatus in the air. The airscrew itself is of an unusual pattern, as by a system of hinged joints, the drifts of the advancing and retiring blades are equalised, and any tendency of the machine to rotate round the propeller axis is prevented.
3. The general action of the machine appears to be as follows: When the tractor screw is put in motion, the machine advances in the usual way, but at the same time the air pressure developed rotates the lifting screw and raises the machine in the air; the faster the horizontal speed the greater being the lift produced.
4. When it is desired to descend, the tractor screw is shut off (at any suitable height) thus reducing the horizontal velocity to a very small amount, and the whole machine descends, very much upon the principle of a helicopter descent, the rate of fall depending upon the design of the machine.

No information is at present available about the weights, surfaces, etc., of the apparatus, but it is clear that since the horizontal velocity can be made very small, and the vertical velocity can be reduced to suit any particular conditions, landing should be very nearly vertical.

5. The machine is most ingenious, but some further information is required. For instance, how does the speed compare with that of an ordinary aeroplane of the same weight and power; also how is a steep dive carried out without straining the vertical propeller axis?

REPLY TO DISCUSSION

Senor [*sic*] Cierva has supplied the information necessary for the following replies:

In answer to the general queries as to area, rotational speed and loading of windmill blades, by nearly every speaker—

Blade area = $(5.5)(.75)(4) = 16.5 \text{ m.}^2$

Total mass 900 kg.

Blades $(40)(4) = 1600 \text{ kg.}$

Loading = $900/16.5 = 54.5 \text{ kg./m.}^2$

Available power 90 h.p.

The maximum flying speed at 90 h.p. was about 30 m./s. or 108 km./hr. The slowest flying speed was about 15 m./s.

The landing speed with descent at 30° was about 4 m./s. horizontal, 2 m./s. vertical; the disc being nearly horizontal and therefore about 30° to flight path.

In vertical descent the speed was about 3–4 m./s., the disc being nearly perpendicular to the vertical flight path.

The angular velocity remains about constant at about 130 r.p.m.

This is due to the condition that there is no torque transmitted by the shaft which runs freely on its bearings.

The total weight is also constant and the root mean square speed is nearly constant, hence the r.p.m. remain nearly constant.

With regard to Mr. Lock's question as to stopping at small disc incidence, this implies very high power and very high forward speed. There should be no serious difficulty with any probable horse-power and speed range.

With regard to climb, rate of climb depends on excess of horse-power divided by weight, and no mechanism can alter the climb from this figure, but it may be obtained at low forward speed; hence the angle of the climb path may be much steeper for the same effective excess of horse-power per unit weight than for an aeroplane. The flying speed range also depends on the excess of power available, as greater power is required for horizontal flight both at very small and very great disc incidence; but the Autogyro has *no* stalling speed, and as the top speed increases the slow speed *decreases* with increasing margin of power. There will possibly be practical limits with extreme excess of power at both ends of the range.

The vertical nose dive is the same in principle as flying at high power with no disc incidence. Both cases seem beyond the range of what the Autogyro will be called on to do with any reasonable power margin.

In reply to Mr. Handley-Page, the torsion of the blade was a serious problem until a section was adopted (Gottingen 429) with fixed c.p. in the usual range of whirling incidence.

Mr. Hodgson's suggestion that rigid blades have advantages and would be required for large machines is entirely contrary to experience. The larger the blades the more necessary it is that the stress should be as nearly as possible pure tension.

Mr. Hodgson's test indicating several possible speeds is extremely interesting from the point of view of pure aerodynamical science, but it does not concern the performance of the Autogyro which maintains its own speed at small blade

incidence under all conditions from 0° to 90° of disc incidence once it acquires sufficient angular speed.

Professor Bairstow's argument that the greater length of the blade path means greater drag loss for the same length of voyage must be modified by two circumstances; first, the blades are at a better incidence for L/D ; secondly, only a very small and clearly designed part of the whole is moving at these high speeds.

It would be rash to prophesy just what performance will be reached when competing designers have used every favourable circumstance and mitigated every adverse circumstance, but it may be confidently expected that detailed improvements will greatly increase every present advantage of the Autogyro tested at Farnborough.

*Document 5-36 (b), Juan de la Cierva, "The Development of the Autogyro,"
Journal of the Royal Aeronautical Society (November 1930): 902–921.*

The Fourth Meeting of the 65th Session of the Royal Aeronautical Society was held in the Lecture Hall of the Royal Society of Arts, 18, John Street, Adelphi, W.C.2, on Thursday, February 13th, 1930, when a paper on the Autogyro, by Senor [*sic*] J. de la Cierva was read and discussed. The President (Colonel the Master of Sempill) was in the chair.

The Chairman: They had all come there that evening with a good deal of enthusiasm and were anxious to give Senor [*sic*] de la Cierva a very hearty welcome. Many of them were there at the end of 1925, shortly after Senor [*sic*] de la Cierva came to England, when he gave them the first detailed pronouncement on his invention, the autogyro. That lecture followed only a few days after the tests that had been made before the Aeronautical Research Committee and Air Ministry officials at Farnborough. That was in October, 1925. Senor [*sic*] de la Cierva was very distinguished in his own country, and was very well-known in all other countries. Last year the School of Aeronautical Engineering was founded in Madrid and one of the first acts performed by that school when it came into being was the conference of an Honorary Degree upon Senor [*sic*] de la Cierva.

Senor [*sic*] de la Cierva's first idea of the autogyro arose from his witnessing the stalling of a large three-engined machine. He decided to produce a type of aircraft which would be free from that danger. It was rather like the way Dr. Lachmann conceived his idea of the slotted wing during the war, after he had recovered consciousness in hospital following a serious crash which nearly cost him his life.

Whatever their ideas might be as to the ultimate future of the autogyro—many different ones, no doubt, would be expressed in the discussion—they were all at one on this point, that Senor [*sic*] de la Cierva, during his few years in England, had earned their admiration for his ability, his courage and his pertinacity. He was a very gifted person because he was not only the inventor of that type of aircraft, but in the main the designer, and in all cases, since the very first tests (after which

he had learned to fly) he had been the pilot. Of the fourteen types which had been produced recently in this and other countries, the inventor and designer, Senor [*sic*] de la Cierva, had himself made all the first tests; so he at least had absolute confidence in his own invention.

THE AUTOGIRO BY J. DE LA CIERVA

(INGENIERO DE CAMINOS, CANALES Y PUERTOS E INGENIERO
DE CONSTRUCCIONES AERONAUTICAS)

I have, for the second time, the honour of addressing you. Four years ago I told you how I had had the good fortune to discover a new method of flying with characteristics altogether different from the conventional aeroplane.

To-day, taking advantage of your kind invitation, I come to tell you of how the crude experimental autogiros of 1925 have been developed into practical flying machines. I will also deal with a number of theoretical points in justification of the assertions I have often made about the qualities of the autogiro and in answer to the criticisms of which my system has been made the object from time to time.

I have, at the risk of giving the impression of not understanding my own discovery, preferred to remain practically silent for years, giving only expression to my faith in the future. I was waiting to have enough experimental evidence to check my theories, which I have not had until quite recently, because of the secondary difficulties which make any development of this kind so slow and painful. A double simultaneous investigation, aerodynamical and mechanical, has been necessary to bring the autogiro to the present stage, which, of course, only represents an intermediate degree of improvement.

The autogiros lately produced have no better performance than the equivalent conventional aeroplanes. In fact, they have a little less speed and a little less climb than the best equivalent aeroplanes. Nevertheless, they are better flying machines. If they still fall a little short of the best aeroplanes in that rather vague quality which is called "performances" they have a performance of their own, which is *utility* and *safety*.

The comparison in performance between existing autogiros of several types and best equivalent aeroplanes can be summed up as follows: Top speed, five to ten per cent. less. Rate of climb, twenty per cent. less. Steepness of climb, fifty per cent. more. Minimum horizontal speed, fifty per cent. less. The take-off since the introduction of the deflector tail is better. The landing qualities are so well known that it is hardly necessary for me to mention them. In any case, I want to state that the present day autogiro can, with proper handling, be landed in perfectly still air with no run at all after touching the ground. In steep descent of about forty-five degrees the vertical speed of the latest machines is not more than 12 to 13 feet per

second. I will deal later in this paper with the theory of the purely vertical descent, one of the more discussed performances of the autogiro.

The latest autogiros have an appearance rather different from those of 1925.

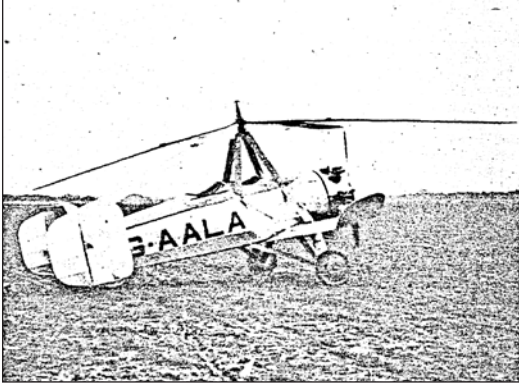

FIG. 1.

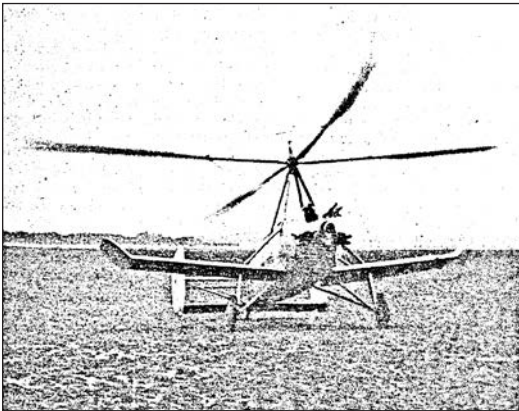

FIG. 2.

They are no longer transformed aeroplanes; and fuselage, undercarriage and tail have been gradually transformed to suit better the necessities of the new system (Figs. 1 and 2). The undercarriage is wider, the fuselage shorter and the tail is of a peculiar design. Also the ailerons, which in 1925 were fixed on a transverse beam or stick, are now supported by small fixed wings, such as the bottom plane of a sesquiplane.

The rotary wings are of a different shape and construction. Their main characteristics are the smoothness of the skin, the local strength of the same to prevent deformation under very high unitary loads and the considerable flexibility of the whole blade in a plane perpendicular to that of rotation.

The blades are hinged to a central hub as in the old machines, so as to allow free flapping in flight. A secondary hinge perpendicular to the first is

also provided, allowing a certain freedom between two consecutive blades. Those two articulations give, by the way, the maximum degree of freedom that rotary wings can have without becoming unstable with relation to the axis of rotation in horizontal motion.

In these machines the tail acts as self-starter to the rotary blades prior to take-off. The slipstream of the propeller is deflected upwards and the rotary blades are forced in turn to a flapping movement which is transformed by aerodynamical reaction into circular motion. Sixty to seventy per cent. of the flying revolutions are obtained in no wind by this means and take-off is possible as soon as the horizontal speed corresponding to the position of the machine on the ground is attained.

The aerodynamics of the autogiro is one of the most complex problems that can be imagined. A considerable number of parameters, both mechanical and aerodynamical, make it really awkward to handle from a purely theoretical point of view. On the other hand, the scale effect being astonishingly great, wind channel experiments are of little use to check any approximate theory. Together with this the extraordinary sensitiveness of the autogiro to changes in certain parameters, such as pitch and profile drag[,] explains that both eminent mathematicians and experimenters have conservatively fixed the best lift-on-drag ratio of the autogiro somewhere near seven (in some wind channel experiments it was only three point five), its maximum lift coefficient around point five and its maximum thrust coefficient at about point seven, referred to the disc area.

I must say that some of the machines I produced in the course of the experimental development were not much better than what could be expected from those conclusions. I took more than one false step. My engineering theories, all based on energy equations since 1924 and very similar in general lines to that developed later by Mr. C. N. H. Lock, and published by the Air Ministry in the R. & M. 1127, in 1927 were not a useful guide to me until, in 1928, I succeeded in finding an analytical method of integrating the frictional losses of energy, when the aerofoil used is the Gottingen 429, which gives the average profile drag in any conditions and for any value of the parameters defining a rotor. The theory completed in this manner has allowed me to produce autogiros with the correct proportions and I can safely say that the present results check with amazing accuracy the simple assumptions which form the basis of my theory.

Simultaneously with this, I must mention the introduction of the small fixed wings in combination with the pure autogiro. Apart from being very useful constructive elements, as supports of the undercarriage and ailerons, they can improve the aerodynamical efficiency considerably and, by a judicious setting of their relative angle of attack, they can contribute towards regularising the speed of rotation of the rotor. From the efficiency point of view their action is double, because they not only give less drag per unit of the lift but, by relieving the rotor of part of the load, they bring it nearer the optimum incidence, which is very small.

The experimental results in several countries with machines of different types permit of my stating definitely that I have obtained in practice a lift-on-drag ratio of about twelve for rotors combined with small fixed wings, the ratio for the rotor alone being about ten. As for the lift and thrust coefficients, though their accurate estimation is somewhat difficult, the figures *one* for the first and *two* for the second, referred to disc area, seem to be reliable. All this for rotors of about point one solidity.

In comparing the autogiro with the aeroplane, the fact that the former has an inferior lift-on-drag ratio is often put forward as proof of its inefficiency. In reality what happens is that the aeroplane and the autogiro are respectively most efficient under different conditions. The aeroplane or, at least, an aeroplane of normal

proportions, has a maximum efficiency in its middle range of speed, while the autogiro is at its best at both ends.

It is perfectly possible for an autogiro to be faster than an equivalent aeroplane, though its optimum lift-on-drag ratio would be inferior. Fig. 3 shows the relative shapes of the required horse-power curves in function of the speed for two normal equivalent machines, one aeroplane and the other autogiro. It will be only a question of the available horse-power whether the autogiro will be faster or not.

It can be shown that if the diameter of the autogiro equals the span of the aeroplane, and both machines have the same parasite drag, the induced and parasite power would be the same in either case, and the required horse-power equations would differ only in the term corresponding to profile drag. In the aeroplane these terms will be practically proportional to the cube of the speed, while in the autogiro it would only be directly proportional to the speed within wide limits. This proves that the greater the speed the less the difference between both and eventually the autogiro must become faster.

The same Fig. 3 explains qualitatively why the aeroplane, in general, will have better rate of climb, since it corresponds to the range of speed for which its efficiency is a maximum, and why, on the contrary, the steepness of the climb of the autogiro can be much better than that of the aeroplane, provided only the propeller's efficiency does not drop to too low a figure at very slow speeds, which seems to show that geared propellers are proportionally of greater interest to the autogiro than to the aeroplane.

The shape of the required horse-power curves of Fig. 3 shows also the much greater changes in the top speed of the autogiro with the available horse-power than those corresponding to the equivalent aeroplane. I have had recently the opportunity of checking this conclusion in the most amazing manner, obtaining from the same machine within the same twenty-four hours a top speed increased by nearly thirty miles per hour by simply changing the propeller.

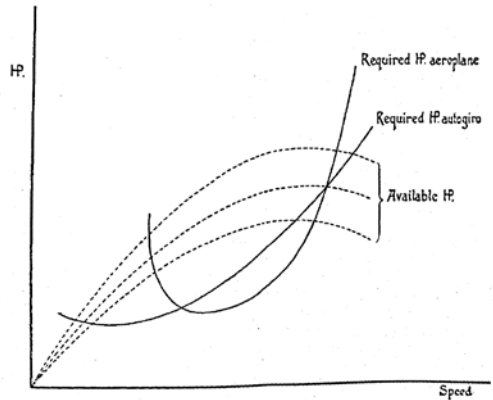

FIG. 3.

This sensitiveness to changes in parameters seems to be a fundamental characteristic of the autogiro. The third term in the equation of required horse-power, of which I have made mention before, is, for the aeroplane, proportional to the surface of its wings, the density, a coefficient which only changes slowly with the speed and the cube of the speed, while for the autogiro it is independent of the surface and the density and is directly proportional to a coefficient which changes slowly with

the speed to the total weight of the machine and the speed. The other two terms being equal, it follows that the required horse-power will increase or decrease with the weight more quickly in a given autogiro than in the equivalent aeroplane of the same span, and the same applies to the density and, consequently, with the altitude, assuming the same speed in both.

This fundamental difference with the aeroplane would be against the efficiency of the autogiro but for two reasons, one aerodynamical and the other constructional. The first is that the above mentioned third term of the power equation is, in the autogiro, independent of the surface (or rather, almost independent) and the second is that an increase in diameter of an autogiro represents much less increase in weight than the same increase in the span of an aeroplane. It sounds paradoxical, but if the blades of an autogiro are substituted for others of exactly the same construction and the same chord, but of greater length, the stresses, both on the hinges and on the blades themselves[,] will be about the same if the blades are sufficiently flexible in the plane of flapping, so that the secondary bending moments are considerably relieved by the deformation of the blade in elevation. Incidentally, that flexibility also considerably relieves any sudden overload making the autogiro the stronger the flimsier it looks.

All this makes comparison between aeroplane and autogiro unfair assuming the same span for both, since span, that precious parameter, costs much less in the second, and this consideration corrects for the autogiro in practice the greater sensitiveness to the weight and altitude. Autogiros with correct proportions can carry the same normal load as equivalent aeroplanes and have about the same ceiling.

A definite advantage of the autogiro with regard to the aeroplane is its extraordinary aerodynamical flexibility and adaptability. In an aeroplane the load per square foot of wing area defines its landing qualities, and if the power is increased, in order to obtain the full benefit, an increase in wing loading must follow with a corresponding increase in the landing speed. Roughly speaking, the landing speed of an aeroplane is proportional to its top speed. In an autogiro the landing qualities depend almost exclusively on the load per square foot of disc area, while in order to obtain the best possible efficiency at top speed it is only necessary to keep the ratio *tip* speed to *top* speed equal to about one point five, which ratio depends only on actual blade area, assuming the pitch constant. This means that, within wide limits, autogiros can be designed to have very different top speeds, but exactly the same qualities in landing and descent. Of course, a limit must come when the blades, even reduced to three in number (two blades only have been tested in flight and found impossibly rough) will become too narrow and thin, but beyond that limit a decrease in pitch angle can still be used to increase the rotational speed with only a slight decrease in efficiency at slower speeds, not very important in machines with a considerable excess of power. It will probably be possible to go beyond the new limit by using for the rotary blades aerofoil sections with a less abrupt stalling than the Gottingen 429, stalling that when produced on a considerable portion of the

retreating blade at low *tip speed to advancing speed ratios*, means a sudden drop in the efficiency. I think it is very probable that tip speed to top speed ratios of about *one* will be used in very fast autogiros in the future.

So far as we have at present ascertained and without even resorting to diminishing the pitch angle from the optimum, I am satisfied of the possibility of designing autogiros having a top speed of the order of two hundred miles per hour, and landing exactly the same as the light autogiros of the latest type.

When considering extremely fast autogiros two objections have been raised. One is that the parasite drag corresponding to the same hub, cables, etc., supporting the rotor cannot be diminished in the same proportion as the equivalent constructional elements of the aeroplane, and the other is that since the tip speed of the rotor plus the advancing speed represents the true maximum air speed of the fastest element of an autogiro, the speed of sound will be approached by that element long before any wing element of an aeroplane, with corresponding detriment to efficiency. To the first objection I will only answer that if the wonderful ingenuity displayed by the racing aeroplane constructors were applied to a racing autogiro, the parasite drag could probably be reduced to the same order as that of the external bracing of the aeroplane, especially when considering the small size of rotor to be used in such an hypothetical machine which, of course, would have a landing speed higher than the present autogiros, though certainly much slower than the racing aeroplanes. To the second I must say that the tip speed of the propellers of the fastest aeroplanes must approach very much the speed of sound without terribly detrimental action. In the equivalent autogiros, and in virtue of what I have said before about the ratio *tip speed to top speed*, speeds of the order of about one half of that of sound, or some 370 miles per hour, could be attained before the speed of sound would be approached by the wing tips and even then it will only be for the tip of the blades during a few degrees of their azimuthal position. On the other hand, at those enormous speeds a drop in the efficiency of the wings, either fixed or rotary, is of relatively minor importance as their drag is very small when compared with the parasite.

In any case this only presents to me at present an academical interest and I would like it to be understood that when I have affirmed that the autogiro could attain greater speeds than the aeroplane, I only had in mind the equivalent practical aeroplane with equal weight-power ratio, without thinking of machines outside the practical range.

Very interesting considerations arise in connection with the limit in the size of autogiros.

Apart from secondary difficulties, which will probably be overcome more or less easily, the size of an autogiro seems to be limited by the diminution of the ratio centrifugal force to lift when the dimensions increase homothetically and the weight of each blade is kept proportional to the total weight of the machine. This means an increase of the coning angle and, while that increase is not very

detrimental to the efficiency within certain limits, it is evident that for this and other considerations, the coning angle must be kept below a certain value. On the other hand, it is always possible to re-establish the ratio by increasing the relative weight of each blade, but this must also have a practical limit. I have arbitrarily fixed the maximum coning angle as nine degrees thirty minutes, a condition in which certain autogiros have already flown without any apparent loss of efficiency or difficulty whatever, and the maximum desirable ratio of total weight to weight of the rotor is *ten*. Considering those conditions and the others already mentioned about the *tip* speed to *top* speed ratio and suitable loading per square foot of disc area in order to keep the existing landing qualities, it is possible to write a system of inequations which show the very curious fact that the total maximum weight of autogiros complying with all of them increases very quickly with the top speed assumed for the same. A correctly calculated autogiro, with a top speed of only eighty miles per hour, should not exceed one thousand pounds all up weight, while for one hundred miles per hour the weight could be more than two thousand five hundred, and a machine weighing ten thousand pounds should be faster than one hundred and forty miles per hour.

This is only, of course, a tentative estimation, but gives, I believe, a fairly conservative idea of the possibilities. As the big machines should be proportionally faster than the small for equal power loading, because of the smaller relative parasite, which is also more favourable to the autogiro than to the aeroplane, since it is equivalent to an increase in the available power, and since the utility of big transport machines, for instance, is only real if they are fast, I can see no fundamental objections to three, four or five-ton autogiros. For bigger sizes I think it is premature to forecast anything and, in any case, I believe more for the present in small and medium size autogiros than in very big ones, which would only come in the course of time.

One of the more interesting possibilities of the autogiro is the slow vertical descent, being the first flying machine ever realised substantially capable of such a feat. The parachutal efficiency of the autogiro is one of the most interesting and apparently mysterious aerodynamical phenomena and also one of the most discussed. Certain theorists cannot see any physical possibility of the thrust on any kind of parachute being greater than that corresponding to the dynamic pressure, which is equivalent to assuming that the parachute stops completely all the air coming directly against its surface (in the relative motion) and this leads to the conclusion that the ordinary parachute is about the optimum. A number of experiments with models, both in wind channels and in free drop, seem approximately to confirm this idea. On the contrary, other experiments such as those carried out by Costanzi and Munk gave results about twice as good in some cases.

Full-scale measures on actual autogiros in real vertical descent are difficult since, by construction, the centre of gravity of the machine is placed in front of the axis of the rotor, so that a purely vertical descent can only be obtained during a

short period, which depends of course on the position of the centre of gravity and the longitudinal moment of inertia of the machine. But in every case the more or less approximate measures which have been taken, not only by myself and my co-operators, but by independent entities, have shown results which were much better than those mentioned. On one occasion an autogiro, falling freely from eighty feet and touching the ground with an angle of incidence of eighty-seven degrees in no wind at all, had a speed of impact, cinematographically recorded, of sixteen feet per second only. The load per square foot of disc area was about two pounds.

Figures from thirteen to fifteen feet per second have been obtained now and again in free descent from high altitudes for descents at large angles approaching ninety degrees on many occasions.

The discrepancy between the full-scale results and the models can be explained by the fact that the energy lost in friction through stalling of the inner part of the blades is a maximum in vertical descent. The speed of rotation (if the autogiro is considered alone, without fixed wings at all) is a minimum in vertical descent and this presupposes a maximum average angle of incidence, which means a larger part of the blades beyond stalling angle. This point is strengthened if it is considered that the models giving the worst results to my knowledge are those in which the aerofoil section used for the blades was a symmetrical one, with an extreme sensibility to changes in scale.

A careful consideration of the autogiro in vertical descent in the light of the vortex theory gives a satisfactory physical explanation of how it can actuate on a much greater mass of air per second than that corresponding to its surface and the speed of descent.

The wake of such a machine will be formed of helicoidal vortices such as those schematically represented in Fig. 4 with a circulation as shown by the arrows. At a considerable distance above the descending machine, the axis of those vortices will form a cylinder with a certain constant radius, because of the symmetry of the reactions of the helicoidal vortices on themselves, but it is obvious that near the autogiro that symmetry is destroyed and the radius of the helicoids tends to increase, widening gradually until reaching an asymptotic value, R_{∞} , greater than the radius of the autogiro considered.

This phenomenon of course is not new and it corresponds to the contraction of the wake of a propeller for the opposite reason, but its effects on the autogiro are much more important, since, assuming equal vortex strength, the widening of the same in the autogiro will be much greater than the contraction in the propeller, because the speed of vertical displacement of the helicoidal vortices with relation to the machine is obviously much smaller, while the *widening contracting* speed will be of the same order.

An accurate calculation of the wake deformation involves differential equations of considerable difficulty, which I have not yet been able to solve in their entirety. But by certain simplifications, which ought not to alter the order of magnitude

of the results, I have reached some provisional conclusions, which are extremely interesting. The widening of the wake is, in a measure, proportional to the parachutal efficiency itself, which means a great sensibility to anything that might alter that efficiency. This is confirmed by the experimental discrepancies I have mentioned. The law of widening from my approximate theory, which law is more or less that shown in Fig. 4, of logarithmic structure coincides almost exactly, when applied to a model tested at Farnborough (results published in the R. & M. 1116) with the position of a number of coils of smoke photographically recorded.

In that case the helicoids had increased thirty per cent. in diameter one radius behind the model and should reach *ad infinitum* a diameter about fifty per cent. greater than the initial.

As to the maximum possible widening in the optimum case it is doubtful whether the simplified assumptions I have made are applicable to this condition, but it looks probable that it would be theoretically possible to reach a radius *ad infinitum* several times greater than that of the autogiro.

The optimum parachutal efficiency of a theoretical autogiro should be, by the indications I have, about *six* times greater than that of the ordinary parachute and the existing full-size machines appear to have fifty per cent. of the optimum, being three times more efficient than the parachute.

Recent experiments made with an autogiro having a better power ratio than any of the previous machines, and fitted with a geared propeller giving a reasonable efficiency at slow speeds, have confirmed fully my ideas as to the possibilities of the autogiro on the slow side of the speed and I think I can say that from a practical point of view a helicopter can be realised at once by simply decreasing the power loading of the present-day autogiros. In this paper I have insisted very much on the sensitiveness of the autogiro to changes in parameters. By increasing the power or decreasing the load amazing results are obtained. If a practical helicopter of any of the proposed types is ever going to be realised, it is obvious that it will only be at the expense of weight, cost and complications without end.

In any case none has yet been realised. But if the obtaining of such a machine were worth the sacrifice of cost and simplicity (and I believe for many applications

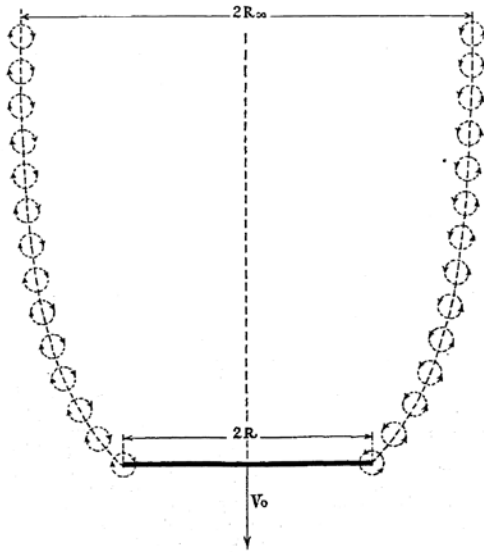

FIG. 4.

it would be justified) an over-powered autogiro, in which only load would be sacrificed, could practically do everything the helicopter is supposed to do. Take off in ten to twenty yards, forty to fifty degrees steepness of climb, eighteen miles an hour minimum horizontal speed or ten miles an hour when losing altitude at seven or eight feet per second, in addition to the vertical descent and dead stop landing qualities, would constitute performances which, while not strictly those of the theoretical helicopter, could yet be obtained immediately and would, in practice, open for such a machine all the possibilities of a helicopter. To my mind, the autogiro could be classified in two categories: The autogiro-aeroplanes, with performances comparable with those of the ordinary aeroplanes in speed and climb and relatively low powered, and the autogiro-helicopters. There is, of course, no definite point of division between both.

Before ending this paper, I must say once more that the autogiro is still susceptible to considerable development and improvement. At the same time it is already a thoroughly practical machine, and in the very near future it will be, I hope, a still better one.

The secondary development stage has now arrived where the co-operation of aircraft constructors generally can be justifiably asked and the scope of the work broadened by the participation in it of the aircraft industry whose constructional knowledge and genius have not hitherto been available.

I want to take advantage of this meeting to thank publicly all who have helped the development of the autogiro in this country, where I have carried out most of my work for the past four years. To my friends and collaborators, to the Air Ministry, to the Royal Aeronautical Society and even to my critics, I feel I am very much in debt.

DISCUSSION

The Chairman: He thought they would agree that the lecturer had put forward a frank and moderately clear account of the present position, and a series of reasonable claims for future research leading to the production of what he termed the smaller size autogiro. Since these developments were commenced four-and-a-half years ago, under the control of the Director of Scientific Research—who would open the discussion—the slotted wing had become more or less a standard fitment on ordinary aircraft. Therefore, the advantage that the autogiro offered at the time that it was first taken up in England had to some extent been modified, in that it did not, to the slotted wing machine, offer the same degree of extra safety that it offered to a machine not fitted with the slots. He absolutely agreed with Senor [*sic*] de la Cierva when he said that his machine, with a suitable power weight ratio, could do in a practical manner all that it was claimed the helicopter could do.

They all admitted that safety was one of the most important considerations; but how much safer was the autogiro than the slotted wing aeroplane? They wanted

to know not only at what cost, from the performance point of view, would he give that added safety; but also to consider the general convenience of operation of that type of machine. He (the Chairman) had been fortunate enough to be flying one of these later models on several occasions, and he had been amazed at the performance of the machine in the air. Being accustomed to flying an ordinary machine, he had not flown Senor [*sic*] de la Cierva's yet a sufficient number of hours to convince himself definitely when in the air that he had entire confidence in its performance, which, when he was on the ground, he knew that he possessed. When one arrived over the aerodrome, say at 1,000 feet, and one found merely by casually shutting off the engine that the machine would ultimately arrive on the ground without doing anything else at all, it did take one a little time, if one were accustomed to flying the ordinary machine, to get used to sitting perfectly still and admiring the surrounding scenery. But that was undoubtedly what happened. The ground simply came up in a gentle fashion, as the machine approached it at somewhere round 15 ft. per second, which the under-carriage was capable of coping with.

He thought they might have some remarks from Flight Lieutenant Cotton, who was responsible for the use and development of aircraft for seal spotting and the like, where taking-off and landing in a dead beat fashion were extremely important.

The Director of Civil Aviation—who could not be present as he was on his way to Athens in connection with certain arrangements for Imperial Airways to fly through Greece and other countries—had sent a written communication in which he said he was still a convinced user of the autogiro, and felt that they were on the brink of making a real practical use of that type of machine. He said that even in its present state of development, it was an interesting and comfortable machine to fly. Throughout his aviation career, he had been celebrated for making extremely bad landings; and one could imagine the joy of being able to pancake from about 30 feet with impunity, and then being told by the pilot in charge that that was the right way to handle that machine. He felt that their efforts should be specially devoted towards improving the take-off. Some time ago Senor [*sic*] de la Cierva had promised him that he would produce a four-seater machine which would take-off comfortably from the Horse Guards Parade. The rate of climb was less than that of the aeroplane; but the climb was at a much steeper angle and the forward speed much slower, a fact which some people were apt to forget. Thus, in its present state of development, one could say its ability to get out of an enclosed area was distinctly better than that of the average aeroplane. He strongly recommended the fitting of a geared propeller to an autogiro as soon as possible.

He (the Chairman) would like to ask Senor [*sic*] de la Cierva what was his idea, in the future development of the machine, as to means for speeding up the rotor preparatory to taking-off. They all knew what the old arrangements were. But under the present arrangements he has shown that it was possible to spin the rotor up to 120 revolutions per minute and it seemed to work very well indeed. There were two other schemes. One was driving the rotor round by coupling it to

the engine by a suitable clutch, and also by a method of jet propulsion[;] perhaps he would tell them about these in the discussion.

The Director of Scientific Research had kindly agreed to open the discussion, and he (the Chairman) would remind those who were not there four-and-a-half years ago that the fact that they had the autogiro in its present state, and that these developments were being carried out by Senor [*sic*] de la Cierva in England, were due to the initiative and energy put into the problem in the very early days and since by the present Director of Scientific Research.

Mr. Wimperis (Director of Scientific Research): He had listened with the greatest pleasure to the lecturer, and he thanked him on their behalf for coming and for giving so interesting and full, though not as full as he would have liked, account of what he had been doing in the last five years. They had all of them become so used to the autogiro, that it was a little difficult to carry their minds back to where they were nearly five years ago. He remembered so well the first demonstration of the machine in flight at Farnborough. He remembered the look of amazed incredulity on the face of the late Chief of the Air Staff when the machine really flew, because he had scarcely believed that it would fly. It was a great tribute to Senor [*sic*] de la Cierva's energy and ingenuity as an engineer that he had produced the rotary wing machine that had been proved to be capable of carrying out a cross-country journey worth talking about. During the years which had passed, the Air Ministry had built several of these machines, of slightly different types, with a view to ascertaining whether the predicted performance of the machine, based upon model tests made in the wind tunnels at Teddington and the calculations made by the staff there and at Farnborough, would in fact actually be borne out. He did not know that they were yet quite in a position to assess the efficiency attainable by these aircraft, because there were lots of little items in the design which had never been used before and which tended to go wrong; so that the investigation could not be carried out at the speed which one would like. But speaking generally, he would say their results had confirmed the figures given by Senor [*sic*] de la Cierva at the beginning of his paper, where he spoke of the loss of top speed and rate of climb as compared with the conventional aeroplane. How far were those two losses of top speed and rate of climb, and one might add miles per gallon, serious? For certain purposes they were very serious indeed; but one could not expect advantages without paying for them in some way. The enormous advantage of landing with almost no horizontal run at all, a run rarely exceeding the wheel base of the machine, was so great an advantage for quite a number of purposes, particularly private flying, that it should, he submitted, outweigh the disadvantages of the fuel costing a little more, and the top speed being not quite so high. For landing under conditions of fog, there was nothing to rival it in any heavier-than-air machine. It was not impracticable, with radio beacons, to find an aerodrome under any conditions of fog; but to land on the aerodrome when one had found it was quite another story; unless the story was that told by their lecturer that night, which was, as the Chairman had said, that

one "pulled the stick back and sat down." The Chairman had spoken about the long run when taking-off which was necessary, so he would not say very much about that, except to say that they had done their best at the Air Ministry to assist Senor [*sic*] de la Cierva in the development of various self-starting devices. The "scorpion tail," the turned-up tail, which was the most promising of them, was a sound idea. It would succeed, he hoped, in reducing the length of the run to something that they were accustomed to with normal types of aircraft. Without some such device the considerable amount of taxiing round the aerodrome necessary to get up speed was a great trial to the under-carriage, unless the aerodrome was an unusually perfect one; and there were some which were not by any means perfect.

From time to time he had had the following kind of representation made to him at the Air Ministry. In what Senor [*sic*] de la Cierva was claiming to introduce, was he claiming anything more than could be done with an ordinary type of machine, if one only had enough slots in it? When he read of the Guggenheim competition, and saw that a Handley Page machine, supplied with slots, was being entered, and that two of Senor [*sic*] de la Cierva's machines were being entered too, he thought that would produce an extraordinarily interesting opportunity of seeing whether that statement which had so often been made to him really had anything in it. He was sorry that the comparison never took place as the two autogiros were withdrawn from the competition. He had not seen any public statement as to why they were withdrawn; and perhaps the lecturer would tell them about that to-night.

The work of investigating the properties of this machine was continuing, and they had faith in its future. They believed there were certain purposes which it could serve in a way that no other machine that they knew of could serve. His personal view was that the biggest opportunity would lie in providing a light machine for private fliers in places where aerodromes were not abundant, or where the country was broken up by rivers and transport was, generally speaking, difficult. In such conditions he would have said that that type of machine would have invaluable advantages.

Mr. McKinnon Wood: The paper struck him as being principally a statement of his faith in his machine. He hoped the lecturer would forgive him stating that he had a little difficulty in taking quite such an optimistic view about the future of its performance; but then he confessed that Senor [*sic*] de la Cierva knew very much more about autogiros than he did, as, in fact, he felt a little out of date. He had only personal knowledge of the performances of one autogiro designed about 1925. That was a machine with which they had been experimenting, which had a speed range of something like 40 to 70 miles an hour and a "service ceiling" very near sea level. Progress had been considerable since that date. That was a two-seater aeroplane of 200 horse-power, and a much better performance was put up to-day by a two-seater aeroplane with only half that horse-power. He regretted that he had not a more intimate knowledge of the autogiro of to-day; but he hoped that the writer of the paper

would give them some actual figures of performance of autogiros in the matter of power, weight, speed and climb.

Mr. Wimperis had referred to the Guggenheim competition. He, too, had hoped that something interesting in relation to the autogiro would have come out of that competition; because, if one took the diagram in the paper, Fig. 3, it appeared that the autogiro should be a good machine for the big speed range which was one of the things the competition was directed to obtaining. A good slow speed, a steep angle of descent, and a steep angle of ascent, were among the chief features of the competition. There was nothing in the rules of the competition requiring a high rate of climb, which it was generally agreed was the weakest point of the autogiro.

It was not, perhaps, a matter of great practical importance—people in general were quite content to descend at 45 degrees—but he would like to say something about the question of vertical descent. He would not undertake to prove that a parachutal coefficient of two was an impossibility, though it seemed to him highly improbable. As to the explanation given in the paper, he did not think that the spreading out of the vortices could explain a parachutal coefficient of two on the ordinary familiar theories of airscrews and windmills, because, according to the theory of Froude, if the ratio of R infinity to R in the diagram were $1\frac{1}{2}$, which was suggested in the paper as having been measured at Farnborough, the coefficient then would be of the order of four-ninths; but it would only reach a limiting value of half if that ratio were infinite, i.e., if the airflow up through the autogiro were finally brought to rest, the highest value one could get would be $\frac{1}{2}$. That did not mean that nothing greater could be obtained, but that the theory was not applicable to such extreme cases. Actually the highest model coefficient measured was as quoted in the paper, 0.7[,] and the different observations varied from 0.6 to 0.7. The resistance of a disc, from Eiffel's experiments, was 0.55; from Miss Bradfield's experiments the resistance of a hemispherical cup was 0.75. The autogiro coefficient was between the two. He found it hard to believe that it could be much greater even if the air flowed to some extent through the plane of the autogiro from above to underneath; and it appeared that most of the flow must be upwards through the disc. A fair amount of flow was necessary in order to keep the autogiro rotating.

Major Mayo (Technical Adviser to Imperial Airways): It certainly was a great disappointment that the autogiro did not turn up for the Daniel Guggenheim Safe Aircraft Competition.

He believed that one of the difficulties that had been experienced in regard to the competition, was in connection with the flattest angle of glide. That was rather a severe condition for the autogiro and he knew that throughout the competition Senor [*sic*] de la Cierva had criticised that particular condition, because he claimed that the great advantages of the autogiro in its steep descent far outweighed the advantages of a flat glide from the safety point of view. He quite agreed that the steep glide was more important, but thought that any aircraft ought to be able to glide for a reasonable distance in case of engine failure. He would be extremely interested

if the lecturer could give them some information as to whether he had been able to achieve a flat glide which was comparable with that of an ordinary aircraft.

Mr. Walker (Chief Designer, De Havilland Aircraft Co.): There was one point in connection with Fig. 3 which had been shown on the screen in which it was shown that the autogiro had a higher top speed than the aeroplane, if one had sufficient horse-power. There was a difficulty in saying what was the "equivalent autogiro," and everyone would probably have some rather different ideas on that point. If one assumed that an autogiro having the same span as an aeroplane was an equivalent machine, it was then very difficult to see how it could be faster at the higher end of the speed scale. The ordinary resistances on which the speed depended were all of them the same in both machines, except the wings of the aeroplane and the rotor of the autogiro. In the case of the wings, it was clear that the horse-power required depended on the cube of the speed. As any differences in induced drag could be neglected under speed conditions, one would imagine that the profile drag must be greater for the rotor, because it would depend on the mean square of the speed of the blades, which would be greater than the squared mean speed and therefore greater than that of the aeroplane wing. That was one of the points which struck him after looking at that figure. He would also like to ask Senor [sic] de la Cierva if he thought there was any chance of flutter on the rotor at high speeds. It did not seem impossible, although they were hinged at the root; but possibly he had some experience of what might happen at high speed in that respect.

Major Green: The paper was on general lines and the author, therefore, was fully justified in dealing with it in the most general way possible. At the same time too, to people who were not so intimately acquainted with the problem as he was, it was rather hard to follow these general arguments and assumptions. It would add immensely to the value of the paper if the author would add some concrete instances, giving what the actual speeds were, and weights and so forth. A diagram like Fig. 3 meant very little when there was no scale to it. The other thing which had struck him as remarkable was the great increase of speed with a change from one airscrew to another. That was almost incredible; and it would be very valuable if one could have some more particulars of tests, and some explanation of why there were these extraordinary figures of speed.

Dr. Hele-Shaw: About 20 years ago Senor [sic] de la Cierva began his practical experiments in aviation. Four and a half years ago he read his paper for their Society in that hall, amidst a chorus of well-deserved congratulation, but as far as he remembered, no one congratulated Senor [sic] de la Cierva on the most remarkable thing of all, namely, his immunity from a fatal or even serious accident. In that paper, he wrote: "In 1918 I had constructed a large biplane with three engines, which, after a most satisfactory trial flight, was wrecked precisely by losing flying speed. The accident diverted all my energies to the solution of the problem of eliminating this danger; for the possibility of losing flying speed and the uncertainty of landing are in fact the only faults with which we can reproach the aeroplane,

otherwise it is practically perfect in point of speed and maneuverability." That night the author of that paper stood before them sound in wind and limb, after conducting experiments himself with 30 or 40 different machines. This meant that he had achieved the object with which he had set out. Like the author, he was an inventor; and if having an object in view one attained the object, which in this case was "safe landing," then he could claim success. To-night the Director of Research told them what he for one was delighted to hear, that for landing in fog, landing without any advancing movement of the aeroplane, they now had a safe machine. Forty years ago he was a Professor of Engineering at Liverpool, and the Mayor, who was a personal friend, sent for him and asked him not to lecture on aviation, because people were beginning to say a man was totally unfit to be a Professor of Engineering if he was talking about such absurd things as flying.

He for one did not feel inclined to obscure the main point of the author's work, namely, safe landing, by throwing doubt on further successes which seemed to be expected from his invention. The object which he had set out to attain was safe descent, and about 18 months ago, at the Hampshire Pageant, he saw one of the Senor's [*sic*] machines. True, it broke a spring on one side, but it descended vertically in the middle of the ground without danger to the passengers.

That night the author came before them to give them various other comparisons with aeroplanes as follows: Rate of climb less, top speed less, steepness of climb 50 per cent. more, and minimum horizontal speed 50 per cent. less. When he, the speaker, came down to the ground, he wanted to come down with that smaller horizontal speed.

He admired one device of the author, namely, the blades being hinged to a central hub as in the old machines, so as to allow free flapping in flight, and a secondary hinge perpendicular to the first which was provided to allow a certain freedom between two consecutive blades; "those two articulations giving the maximum degree of freedom that rotary wings can have without becoming unstable with relation to the axis of rotation in horizontal motion." Another point which interested him very much and to which the Director of Research had also referred, was that in the new machines the tail acts as self-starter to the rotary blades prior to taking-off. The slipstream of the propeller is deflected upwards and the rotary blades are forced in turn to a flapping movement, which is transformed by aerodynamical reaction into a circular motion. Sixty to 70 per cent. of the flying revolutions are obtained in no wind by this means, so that take-off is possible as soon as the horizontal speed corresponding to the position of the machine on the ground is attained.

He, therefore, thought they were justified in congratulating the inventor not only upon his immunity from accident, but on having added further beautiful devices to the invention. He remembered four and a half years ago the astonishment of the world at the fact that that horizontal wing would start into action. He believed the inventor did not know sometimes which way it would start. He

thought the final words with which the author concluded his paper justified everything he had done, namely: "The secondary development stage has now arrived, where the co-operation of aircraft constructors generally can be justifiably asked." In other words, the co-operation of the practical men was invited. As an inventor he could say that if any invention reached that secondary stage the invention was sound in principle. If it were not sound it would never reach that secondary stage—it would be dead before it got there.

Mr. Pye (Assistant Director of Scientific Research): He must confess, in relation to engineering structures, to a prejudice in favour of stiffness. No doubt these marvellous rope bridges across ravines in Africa and Borneo had ample factors of safety, but personally he would prefer a steel arch to go across on. Speaking purely as a man in the street, he felt there might be others like himself who, when they saw for the first time an autogiro flapping round, felt this prejudice in favour of stiffness rise up in them. One could not help being apprehensive of large pieces of structure moving at great speeds in rather close proximity to oneself. These remarks were really addressed not so much to Senor [*sic*] de la Cierva as to other people in the room who had flown these machines. It would be interesting if some of them would say whether they felt in themselves any sort of prejudice against flying in a machine of which the essential part was a large piece of moving structure. He felt that himself; and he believed that before this machine could win a place as having a real future in aviation, the inventor would have to get over that prejudice in others besides himself.

Mr. Manning: He thought loss of top speed was important. The only excuse for the aeroplane was that its speed was greater than that of any other form of transport. That was an advantage that must be pressed. With a good many existing light aeroplanes, if the conditions were slightly unfavourable, say a 20 miles an hour head wind, it was probably difficult for the machines with passengers and luggage to fly from London to Paris without landing to obtain further supplies of petrol. The expenditure of petrol in the case of the autogiro would be worse, and it would probably be nearly impossible to do that journey without landing for a fresh supply. With regard to the gliding angle, it was clear that the danger in crossing the channel would be rather larger in the case of the autogiro than in the case of the Moth at the same height. There were two other points also which had not been investigated. It had always occurred to him that the advantages which the autogiro had over the aeroplane were important in two particular directions. One was in the case of the seaplane. It seemed to him that a machine which could be pulled off the water quite rapidly with a low forward speed would be very useful for seaplane work, especially as it was possible that the arms of the rotor might be made to fold when the machine was sitting on the water. In the case of the seaplane top speed was less important; and the speed of climb was also less important. In fact, the points on which the autogiro was admittedly inferior to the aeroplane were of very much less importance in the case of seaplanes, whereas the advantages of the autogiro come

out very strongly in that connection. It had always occurred to him that in the case of night flying, which would undoubtedly have to be gone into to a much greater extent in the future, it would be much safer to fly by night with an autogiro than with an aeroplane. If one was going to crash, the autogiro crashed vertically at a comparatively low speed, whereas the aeroplane usually crashed end on; and it was that type of crash which was dangerous to life.

Captain Rawson: He had flown about 1,500 hours in an ordinary type of machine and about 200 hours in an autogiro. After about the first ten minutes he had altogether lost any consciousness of anything buzzing round his head; and if any other pilot who had flown an autogiro were asked, he thought he would confirm that statement. The feeling that one had a number of loose wings wandering round and round wore off after about ten minutes in the air. As regards the feeling of safety, he felt safer flying across country in an autogiro than he did in an ordinary machine. He had to go up two or three times a year for his normal training. In the first half-hour, in a normal machine, he was afraid of letting it drop out of his hand, whereas in the autogiro, at an altitude of 200 feet, he did not mind anything which happened, because he could bring it down anywhere and not damage himself and probably not even the machine. As he had done most of the performance tests, perhaps he might give one or two outstanding figures. It was said that the first giro had a speed range of 40 to 70 miles an hour. The maximum speed range they had attained up to now, taking a conservative estimate, was from 25 to 112 miles an hour. That had actually been measured. A machine in England had done from 25 to 106 miles an hour, measured officially. In the King's Cup Race of 1928, flying from Hendon to Norwich, a distance of 99 miles—there was no head wind worth talking about, but there was a cross wind—99 miles was flown in an hour and five minutes, three minutes of which was taken in taxiing round the aerodrome to take-off. A similar machine was built and efficiently timed by the Italian Government over a measured distance, and the official figures were 106 mile an hour. Both those machines could fly 25 miles an hour; and also in flying at Newcastle-on-Tyne, in a demonstration, he had actually had a minus on the indicator. As regards long distance flying, the farthest flight by an autogiro has been 140 miles non-stop. That was a machine which only had petrol for an hour and 45 minutes on board.

Captain Yeatman: He hoped that Senor [*sic*] de la Cierva would publish in the Journal his mathematical theory of the autogiro, which they were very anxious to hear; and also some performance figures, backed up with as much legally compelling evidence as he could obtain.

Major Low: He thanked the lecturer for his paper and reminded him of the small collaboration he was able to give four and a half years ago. He had then tried to work out a physical theory which was divided into part 1 vertical descent and part 2 horizontal flight or flight at an angle. At the end of part 1 he found that his autogiro fell twice as fast vertically as Senor [*sic*] de la Cierva's observed results and

gave up his attempt to formulate a physical theory, which he had not found time to renew since.

Flight Lieutenant Bonham-Carter: Nobody there had actually brought out the fact that they owed the invention of the autogiro entirely to a sheep. It happened in the following way. Senor [*sic*] de la Cierva was flying in the very early days of aviation from one end of a field to another. After a time, he thought he would go to the next field; so he took-off in his aeroplane and flew over the hedge. When he came into the next field, there was a sheep, so he pulled back his stick to avoid the sheep and the machine went up and stalled, and fell back on its tail and crashed. Senor [*sic*] de la Cierva had a sleepless night or two and thought of the autogiro. That was more or less what happened. After that he produced his machine. The next problem, after having found a machine that would fly, was to overcome the starting difficulty. He went through various phases of thought. One of his suggestions was to place at the end of each wing a rocket. He (the speaker) was very sorry that Senor [*sic*] de la Cierva did not go on with that suggestion. If the machine had appeared with rockets at the end of each wing, it would soon have become a popular attraction. At one time the usual method of starting the autogiro was to have a wire and get a number of people to pull this wire away from the machine. Senor [*sic*] de la Cierva discarded the wire when he found that taxiing would start the giro. To-day he had got this deflector tail; perhaps the lecturer would tell them whether the deflector tail was really a solution of the problem and whether the machine would stand up to the bump which it must get each time the rotors went over the deflector tail. There must be a very big vibration owing to the fact that for a short period in each revolution of a blade there came about this violent upwards jerk. He would like to know whether there were any mechanical difficulties arising from that violent bumping. One or two people had emphasised that the great advantage of the autogiro was that it could land easily anywhere; but he did not think anybody had brought out the point that the autogiro was absolutely spin-proof. The slotted machine would spin, and would probably damage the pilot if he inadvertently stalled near the ground. But the autogiro would not spin. In difficulties, one could pull the stick back and sink. The rate of descent might be higher, but one would come down straight. That was a great advantage when landing in a very small space. Somebody asked whether pilots had any objection to flying in a machine on which there were large rotating masses. He did not think there was anything in that. One could take the machine off and feel perfectly happy straight away. There was a certain prejudice about hanging on to a single bearing; but when one got into the air, one soon got over that. One could do things with it that one could not do with any other machine. One could treat it like the normal machine in many respects, but one could also take liberties which would be likely to cause trouble if taken with the normal aeroplane.

Sir Sefton Brancker: He had the honour of presiding at his first lecture some four years ago and giving his proposals his full support. He was still a convinced

believer in the autogiro principle and felt that they were on the brink of being able to make real practical use of it.

Even in its present state of development it is a most interesting and comfortable machine to fly. When on the ground the system by which the windmill supports the machine in the air tends to create misgivings in the mind of the would-be pilot; but the moment it gets into the air the system seems to be perfectly logical and dependable, and after a few minutes' handling the pilot experiences a feeling of complete confidence—at least that was his experience.

He felt that at present their efforts should be specially devoted towards improving the take-off. Some time ago, Mr. de la Cierva promised he would produce a four-seater machine which would take-off in any wind from the Horse Guards Parade. The rate of climb, of course, is less than that of the aeroplane; but the climb is much steeper and the forward speed much slower, a fact which many people are apt to forget. Thus, even in its present state of development they can say that its ability to get out of an enclosed area is distinctly better than that of the average aeroplane.

He would strongly recommend the fitting of a geared propeller to an autogiro as soon as possible.

He would like to ask Mr. de la Cierva one question. When flying in bad weather a heavy downward current is sometimes experienced in which an aeroplane will drop like a stone 400 or 500 feet; gravity ceases to work; the engines stop owing to the cessation of gravity feed; and the passengers and hand baggage fly up to the roof and remain suspended until the end of the bump. What would an autogiro do under such conditions?

REPLY TO DISCUSSION

Senor [*sic*] J. De La Cierva: Sir Sefton Brancker, the Director of Civil Aviation, had sent a very kind letter, in which he asked what would be the behaviour of the autogiro on the occasion of these hair-raising bumps which sometimes happened. He was sorry that his pilot had not answered that question, because he has had some experience of that. He was flying through Germany last year in an autogiro accompanied by the Secretary of the Autogiro Company, who was undergoing his first flying experience. They were nearly thrown out of their seats by a terrific bump, the machine falling 500 feet. The wings became horizontal for a moment; but after a few seconds everything became normal and nothing happened. As a matter of fact, it might be interesting to state that the autogiro behaves in bumps better than the aeroplane, due to the flexibility of its lifting means.

The Chairman asked me what other self-starting methods than the system of the deflected tail were being contemplated. There were many possibilities of a self-starter with an autogiro. The obvious conventional solution would be a direct mechanical drive from the engine, and that solution was being tested at the

present moment. There was no doubt that the problem could easily be solved by that method, if weight complications were neglected. It was merely a question of engineering progress and whether that method was practicable or not. There was another method which was derived from that more or less wild experiment which Mr. Bonham-Carter had been telling them of, of rockets on the tips of the rotor. The rockets did not seem to be a very great success in themselves, but there was the possibility of starting a rotor by means of jet reaction not applied to the ordinary flight conditions, but only for starting. Some experiments already made had been quite successful. Judging from his personal experience, for general use the deflector was sufficient, even in its present form; and it certainly was possible to improve it greatly.

Mr. Wimperis, who was responsible for his being there, as he was responsible for his coming the first time to England, had said that he was disappointed that the autogiro did not appear in the Guggenheim Competition, and other speakers had made the same remark, and had asked him explicitly to state why the autogiro did not appear. Major Mayo's words had given the real answer—that they were not ready. Most of them were acquainted with the difficulties of aviation, and knew that aeroplanes were only fast in the air. They were not fast enough, and the 1st October came without their being ready. As to the question of flat glide, he might say that in fact an autogiro had a worse angle of glide than the ordinary aeroplane; but they thought they would have passed that test and other tests, had they been in time for the Guggenheim Competition. Several speakers had asked for definite figures of performance. Captain Rawson had mentioned some, and he would just add a few more. Autogiros of 200 horse-power engine with all round weight of about 2,500 lbs. have reached 112 miles an hour maximum horizontal speed and minimum horizontal speed of 25. The rate of climb was about 1,000 feet per minute and a steepness of climb of about 20 degrees. He said in his paper that the autogiro was not to-day as fast as the best equivalent aeroplanes; but he by no means meant to say that the autogiro would always be inferior. That was what he had tried to prove with Fig. 3. At present the autogiros were slightly inferior. If one considered that only a few years ago they were very much inferior, in view of the rate of progress made, one could see that the autogiro was catching up the aeroplane in performance. He might be wrong, but he hoped that in the near future it would be scratch with the aeroplane. Mr. Walker said he could not understand why the autogiro was said to be as fast as the aeroplane, or even faster, seeing that the unitary profile drag of the rotary wings was much greater than that of the ordinary fixed wings. That was true as to the unitary drag; but the surface of the rotary wings was much smaller than that of the fixed wings; and on the autogiro the total amount could be less even if the unitary drag was much more. For instance, an autogiro has a wing area something like a fourth of the wing area of a more or less equivalent aeroplane; so that if the unitary drag was four times more, it had the same amount of total drag.

He could say that flutter, in the sense in which it was understood in an aeroplane, had not been produced. There had been many cases of resonance between blades; and in fact he had spent most of the time since he came to England for the first time trying to cure vibration, which was absolutely cured to-day; but that vibration had nothing to do with flutter, or torsional resonance arising from a blade in its own rotation. The fact that both speed and incidence change continuously for every blade make practically impossible the maintenance of any critical resonant condition unless of what might be termed a coincidence of second degree, which is almost out of the question.

Mr. McKinnon Wood said he did not share the lecturer's faith in the future performances of the autogiro. That was a question of faith and could not be discussed; but in passing he had asked him to explain the very high parachutal efficiency of the autogiro. That was a problem not to be dealt with by pure philosophy; and it would be better if the Aeronautical Society gave him the hospitality of its paper to put it in writing, as it would be too hard to discuss then, on account of difficulty of language and lack of time. It was not reasonable to expect that phenomenon of high efficiency to be explained by the Froude theory. There was no ordinary airscrew theory which really explained it. But there is enough experimental evidence to show that the autogiro's parachutal efficiency was much higher than that of the ordinary parachute. In some tests not made by himself, but by Constanzi, in Italy, as far back as 1909, he found a coefficient with a rotating windmill of 18 thin blades equal to 1.2 in English absolute system, which was nearly equal to twice that mentioned. Also, in some experiments made by Prof. Munk, in America, there was obtained a coefficient something higher than that which Mr. McKinnon Wood had mentioned. It was, unfortunately, very difficult to get actual figures on that point, because the autogiro had its centre of gravity in front of the axis in order to prevent a true vertical descent, so that the machine would not be any longer in control, but would be thereafter a parachute. But on many occasions, descents practically vertical have been obtained for several hundred feet and all measures, whether taken by themselves or by independent and even official persons, seem to prove that a parachutal coefficient in true scale of about two has already been attained in agreement with his theoretical results.

Document 5-37

**Juan de la Cierva and Don Rose, “The Autogiro in America,”
in *Wings of Tomorrow: The Story of the Autogiro*
(New York: Brewer, Warren & Putnam, 1931), pp. 126–133.**

In this chapter from his 1931 autobiography, Juan de la Cierva told how his autogiro came to the United States. It happened in 1929 through the efforts of U.S. rotary-wing pioneer Harold F. Pitcairn, who had met with Cierva several times in London four years earlier. Impressed with the Spanish engineer’s invention, Pitcairn switched from helicopter development to the autogiro, obtaining the American rights to Cierva’s invention in 1929 and creating the Autogiro Company of America (ACA) to develop and promote it. Quickly, Pitcairn licensed it to Kellett Aircraft as well as to his own construction firm, Pitcairn Aircraft, both located in the Philadelphia area.

Pitcairn himself exemplified the switch from helicopters to autogiros and back to helicopters again discussed in our text. In the early 1920s, he had worked along with fellow rotary-wing enthusiast Agnew Larsen on a novel helicopter incorporating a system of adjustable vanes placed in the slipstream (outboard of the 70-percent radius) in the hope of counteracting torque and avoiding some of the problems associated with ground effects. Although he visited Cierva while in England in 1925, his main reason for going there was to enter (through Larsen) a British helicopter competition. But he came away from that visit more interested in the autogiro, though he continued to conduct helicopter experiments into 1928, dropping his antitorque vanes in favor of a jet-driven rotor. A major aspect of this test program by 1928, however, centered on the transition of a helicopter in flight from powered lift to descent via autorotation, a concept for which Cierva was the main influence. It was this work that led Pitcairn to drop his helicopter work and focus on the autogiro. Again, the reason for the switch to the autogiro in the late 1920s seems to have been the technical frustrations blocking the design of a true helicopter and the desire for what at the time appeared to be a more practical machine. As early as 1920, Pitcairn had told a friend that he wanted “a single-rotored helicopter” but that he did not care if it had a propeller out front or not.

As the 1930s proceeded, developments in the technology of rotary-wing flight brought Pitcairn back to the matter of helicopters. His Autogiro Company of America patented several hundred inventions, many of them—as lengthy lawsuits demonstrated—directly applicable to helicopters. After building autogiros under license from Pitcairn, the Kellett brothers went on to build helicopters. They later sold out to Hughes Aircraft, which, thanks to a team of Kellett engineers who went to California with the business (such as Richard H. Prewitt, Paul Hovgard, Dave

Driskill, and Lou Leavitt), became a prominent helicopter manufacturer. So active had the Philadelphia area become in the rotary-wing industry that Arthur Young located his work around the Quaker City in 1928; Frank Piasecki, father of the tandem rotor helicopter, also established his company there in the 1940s.

The entire subject of the exact relationship between helicopter and autogiro development deserves fuller analytical treatment than it has been given. The best coverage to date is Eugene K. Liberatore, *Helicopters Before Helicopters* (1998). Calling the autogiro “a forerunner” of the helicopter as many historians have done is hardly sufficient. On the other hand, the role of the autogiro in the progress of the helicopter should not be underestimated. Two of the individuals most responsible for the invention of the helicopter in the 1930s, Heinrich Focke and Igor Sikorsky, both recognized the technical contributions of Cierva to what became the first practical helicopters.

Document 5-37, Juan de la Cierva and Don Rose, “The Autogiro in America,” in Wings of Tomorrow: The Story of the Autogiro (New York: Brewer, Warren & Putnam, 1931), pp. 126–133.

The formation of an English company for the development of the Autogiro and the financing of its commercial production resulted in the transfer of experimental work to England. Rights to the Autogiro patents became the property of this organization, known as the Cierva Autogiro Company, Limited. Development was carried on in co-operation with established aircraft manufacturers, who built machines to designs which I prepared with the assistance of a corps of qualified engineers. It was at this time that I learned to fly and became a licensed pilot.

In 1918 a visitor from the United States attended several demonstration flights of the Autogiro. This was Harold F. Pitcairn, at that time president of Pitcairn Aviation, Inc., and a well-known personality in American aeronautics. He had done some experimental work with helicopters and was unusually well qualified to recognize the possibilities of the Autogiro. His increasing interest quickly resulted in the selling by the Cierva Autogiro Company of all American rights, to Harold F. Pitcairn and his organization.

This was the beginning of a close association which has proved highly profitable to the Autogiro and very pleasant to its inventor. It resulted in rapid development of the commercial possibilities of the machine, for the Pitcairn organization was experienced in both the manufacture and the operation of aircraft. Under the title of Pitcairn Aircraft, Inc., it had produced a successful series of planes for mail service, sport flying and primary training. Pitcairn Aviation Inc., operated a pioneer air mail route between New York, Atlanta and Miami, and achieved an outstanding success in building up the air mail service and patronage in this section of the United States. Associated with this air mail route was a system of four flying schools, in addition to that maintained at the main field near Willow Grove, Pa.

In the summer of 1929 the Pitcairn organization disposed of all its operating activities. It continued the manufacture of the Pitcairn Mailwing and a sport model of the same plane, and began an intensive engineering effort in perfection of the Autogiro. My own work was continued in England, but co-operation was closely maintained across the Atlantic and to a considerable extent the two companies shared the results of their labors. I myself made two visits of some length to the United States. The first was related to the original appearance of the Autogiro in America. The second came during the fall of 1930, when development was well under way in the United States, as was dramatically demonstrated by the fact that I was greeted by four Autogiros flying in formation—the largest number I had seen in flight at one time—as I entered New York harbor on the *S. S. Bremen*.

Much of my time on this first visit was spent in reducing to complete and organized condition the technical theory of the Autogiro and of flight by means of autorotation. This involved some months of work, following the many years in which its material had been accumulated. Study and theoretical calculations, checked constantly in free flight experiment, had supplied sufficient data so that a theory could be developed covering many probabilities of performance and possibilities of design beyond the actual achievement in construction to that time. This “first edition” of the theory of the Autogiro forms a large-sized volume, complete with tabulated values and graphs of various items entering into design.

The first Autogiro to fly in the United States arrived there late in 1928. It was flown from the field at Willow Grove, Pa. Mr. Pitcairn had learned with little trouble to fly an Autogiro in England, and one of its first appearances in the American air was when he flew the visiting ship in December, 1928, over his home in Bryn Athyn, Pa. Later he piloted it from near Philadelphia to Langley Field, a distance of several hundred miles, the first cross-country flight by [an] Autogiro in America.

Within two years from its first flight in America, the Autogiro went through many modifications in design, though some of these are only apparent to the technical observer. Rapid progress was stimulated by the intention to enter on commercial production as soon as the remaining weakness or uncertainties were eliminated from the machine. No effort was spared to this end, but on the other hand the Autogiro Company of America would not permit any premature introduction of the craft of into the commercial market. The work was carried on quietly, in spite of a great deal of public and technical curiosity. Only when we were satisfied on both sides of the Atlantic that the Autogiro was no longer experimental but a useful, efficient and reliable flying machine were the results of these long years of research offered to the public.

An important American development was the mechanical starter to set the rotor in motion before taking off. The machine cannot fly until the rotor is turning at least 80 revolutions per minute, so it has always been necessary to provide means for getting up rotational speed before attempting flight. In the experimental days this was usually done by starting the rotor with a push by hand and increasing its speed



Early autogiro in flight. **ABOVE:** First English built Autogiro for the British Air Ministry, June, 1926. **BELOW:** Autogiro C8, in flight over Newcastle, on a tour of England.

by taxiing around the field. At one time a mechanical device was developed for the same purpose. A drum was fixed to the rotor, carrying a cable which was fastened at one end to an anchorage on the field. As the machine picked up ground speed and moved away, this cable pulled the rotor around as a string turns a top. But this was an expedient and not a solution to the problem.

Considerable success was secured with a starter which utilized the slipstream of the propeller to turn the rotor. A biplane tail was built which could be set by the pilot so that the current of air from the propeller was deflected upwards to strike against the rotor blades and turn them. With

this device a sufficient speed could be developed in the rotor without running the machine around the ground before taking off. Until this was done the Autogiro was handicapped by the need for plenty of space for the take-off, though it could land in a very small area.

But the mechanical starter proved much more satisfactory, when American engineers developed one of sufficiently light weight so that it did not unduly burden the Autogiro or reduce its useful load too much. The starter now in use on the 300 horse power Autogiros weighs about 65 pounds; the one so far developed for lighter craft weighs about 45 pounds. It operates under the pilot's control, using power from the engine, and it brings the rotor to flying speed in about thirty seconds.

The addition of an efficient starter enables the Autogiro to get out of small fields as well as into them. It could do so before, so far as its length of take-off run and steepness of climb were concerned, but could not do so while it needed considerable space to taxi around in order to put the rotor in motion.

The development of the Autogiro in America received gratifying recognition in March, 1931, when the Department of Commerce awarded it an approved Type Certificate, the highest rating as a flying machine for public use and commercial

traffic. It is interesting to note that the Department was obliged to set up new regulations covering the Autogiro, because the terms on which certificates are granted to airplanes do not apply to some of the most characteristic features of Autogiro performance. An airplane is required, for instance, to pass tests demonstrating its ability to recover from a spin. The Autogiro will not stall in the airplane sense of the word, and cannot spin.



Modern craft in a modern city. Two autogiros in flight over New York. Note Empire State tower in background.

A signal honor was conferred on the American organization engaged in Autogiro development by the announcement in April, 1931, of the unanimous decision of the committee in charge that the Collier Trophy should be awarded to Harold F. Pitcairn and his associates. The Collier Trophy is the outstanding American distinction for achievement in aeronautical research for the year of its award. It has been granted to a few individuals, to some governmental departments and to national organizations interested in aeronautics. It was awarded on this occasion for “the greatest achievement in aviation, the value of which has been demonstrated by actual use during the preceding year.”

Document 5-38 (a–b)

(a) Frank Tichenor, excerpt from editorial,
 “Why the NACA?,” *Aero Digest* (December 1930): 49–50.

(b) Henry J. E. Reid, Engineer-in-Charge,
 NACA Langley, to George W. Lewis, Director of Research,
 NACA, Washington, DC, 2 January 1931, in Accession
 55 A 312, Records of the NACA, National Archives.

Historian Alex Roland used *Aero Digest*'s editor's December 1930 assertion that the NACA neglected autogiro research as his primary evidence of an “NACA pattern of ignoring helicopter research before World War II.” But as a more exhaustive review of the NACA's involvement in the rotary-wing field clearly shows, the NACA neither neglected the autogiro nor ignored the helicopter. Those scholars who have scrutinized the technical literature in the United States related to autogiros and helicopters in the 1920s and 1930s, such as Eugene K. Liberatore and J. Gordon Leishman, give the NACA high marks for what it contributed to a fundamental understanding of the operation of these unique machines.

Frank Tichenor (the aforementioned editor) was not just critical of the NACA for what he thought it was not doing with the autogiro. In his December 1930 editorial, he condemned the government research organization pretty much across the board for failing to live up to its federal mandate of conducting fundamental *scientific* research. In another anti-NACA editorial published in February 1931, Tichenor wrote: “In these columns in December, I reviewed the conditions prevailing in the National Advisory Committee for Aeronautics which prevent it from functioning in a manner useful to the best interests of the industry it purports to serve.... The importance of a wise and honest expenditure of public funds appropriated specifically for scientific research and not for a cheap substitute for it, is generally recognized” (“Air—Hot and Otherwise,” *Aero Digest* [Feb. 1931]: 24). In this header, it is not possible to go into a complete analysis of Tichenor's editorial campaign against the NACA. Suffice it to say that Tichenor did not understand the NACA's research process very well and suffered from too categorical a distinction between what he preferred to call “science” and the “engineering science” that was at the heart of NACA research. (For an elaboration of this thesis, see James R. Hansen, “Engineering Science and the Development of the NACA Low-Drag Engine Cowling,” in *From Engineering Science to Big Science: The NACA and NASA Collier Trophy Research Project Winners*, ed. Pamela E. Mack [Washington, DC: NASA SP-4219, 1998], especially pp. 16–20.) One might also add that the claim made by Tichenor in his December 1930 editorial that the autogiro was perhaps the “most important invention of recent years” hardly qualifies the man as a clairvoyant.

In the second excerpt below, NACA Langley's engineer-in-charge, Henry J. E. Reid, responded in an internal memorandum of 2 January 1931 to Tichenor's December 1930 claims about NACA neglect of the autogiro. Even Alex Roland noted that Reid's response was quite restrained, given the provocation: "To the hyperbole of the Tichenor piece, Reid responds characteristically with documentation, moderation, and specificity" (*Model Research* II: 660).

It is striking to read Tichenor's condemnatory article in conjunction with the published histories of the helicopter and its early development by Liberatore and Leishman, both of which credit the NACA not only with substantial involvement, but also with leadership in the rotary-wing field.

Document 5-38 (a), Frank Tichenor, excerpt from editorial, "Why the NACA?," Aero Digest (December 1930): 49-50.

The Autogiro is the most painful subject in connection with the N.A.C.A. research. The N.A.C.A. had the priority in this new and perhaps most important invention of recent years. Autogiro models were investigated in 1922. It is hard to believe, but nevertheless true, that these tests were never published in a Technical Report. Five years later, after the practical value of the Autogiro had been demonstrated abroad, the results were published in mimeographed form, giving evidence of an opportunity to contribute to scientific progress which was woefully neglected.

In the investigation of auto-rotation of wings, it was demonstrated that, in a wind tunnel, wings can be made to rotate like windmills. This has hardly any bearing on or connection with the spinning of airplanes. It can hardly be called a research, but rather only making pretense of research. No airplane designer gives any attention to such tests, and science rejects them entirely.

Document 5-38 (b), Henry J. E. Reid, Engineer-in-Charge, NACA Langley, to George W. Lewis, Director of Research, NACA, Washington, DC, 2 January 1931.

In regard to the autogiro, as mentioned in the article, there is no evidence in the files to indicate that tests on an autogiro model, as such, were ever made. The correspondence back as far as January, 1919, shows that propellers were being studied with a view to their application to the helicopter, and in 1921 tests were carried out on a propeller mounted in a wind tunnel, measuring the drag at various angles of yaw and with various amounts of braking. Later on, work was done on feathering propeller blades, and correspondence in 1923 and 1924 indicates that there was a paper prepared by Bacon and Munk on "Model Test on the Economy and Effectiveness of Helicopter Propellers." The Laboratory correspondence does not indicate that this type of work showed very much promise, and as I was not personally connected with any of that work I am not in a position to recall any of the details of the tests.

Document 5-39 (a–h)

Excerpts from *Annual Report of the National Advisory Committee for Aeronautics* (Washington, DC), 1933–1940.

- (a) “Rotating-Wing Aircraft,” *Annual Report* (1933), pp. 14–15.
- (b) “Rotating-Wing Aircraft,” *Annual Report* (1934), pp. 16–17.
- (c) “Rotating-Wing Aircraft,” *Annual Report* (1935), p. 16.
- (d) “Rotating-Wing Aircraft,” *Annual Report* (1936), pp. 16–17.
- (e) “Rotating-Wing Aircraft,” *Annual Report* (1937), pp. 18–19.
- (f) “Rotating-Wing Aircraft,” *Annual Report* (1938), p. 17.
- (g) “Rotating-Wing Aircraft,” *Annual Report* (1939), pp. 16–17.
- (h) “Rotating-Wing Aircraft,” *Annual Report* (1940), p. 8.

Although isolated references to rotary-wing developments can be found in the NACA’s annual reports prior to 1933, it was not until that year that a regular entry on “Rotary-Wing Aircraft” began to appear in the publication. In that first year of reporting on it, the NACA explained that it was paying attention to “three promising types” of rotating-wing aircraft: first, the “familiar” autogiro; second, the “gyroplane,” a special form of autogiro with a different kind of rotor arrangement and operation, one seeking a greater symmetry of lift; and third, the “cyclogiro,” essentially a helicopter, though the NACA did not call it that in this first report. Most of this work on rotorcraft was being done in the form of wind tunnel tests. The Committee reported in the *Annual Report of the National Advisory Committee for Aeronautics* for 1933 that its researchers were conducting the tests “principally for the purpose of improving the rotor characteristics of the autogiro and gyroplane and confirming the soundness of the principles involved in the cyclogiro” (p. 15). Most interestingly, it wrote that “the aerodynamic principles of vertical flight” were “sound” and “that hovering flight, vertical climb, and a reasonable forward speed may be expected with a reasonable expenditure of power” (p. 15). In the *Annual Report* for 1934, the NACA reiterated its belief in this form of flight technology: “Considerable effort has been devoted during the past year to a continuance of the theoretical and experimental work on rotating wings, for the principal reason that they are believed to constitute one of the best existing solutions to the problem of safe, stable, and controllable flight” (pp. 16–17). Interestingly, though several

NACA researchers by the late 1930s appear to have become more interested in true helicopters, the NACA's entries on rotary-wing aircraft in its annual reports continued to focus on autogiros. Perhaps NACA leadership still considered helicopters too early in their experimental development.

Document 5-39 (a), Excerpts from Annual Report of the National Advisory Committee for Aeronautics (Washington, DC), 1933-40, "Rotating-Wing Aircraft," Annual Report (1933), pp. 14-15.

Because of the possibility of obtaining sustentation with little or no forward speed and the consequent possibility of safe flight at low speeds, continued attention has been given during the past year to three promising types of rotating-wing aircraft.

The first is the familiar autogiro in which the rotor axis is vertical, the rotation of the rotor occurs automatically as a result of air forces acting on the rotor blade, and lift on opposing blades is equalized by a flapping motion of the blades. Investigations have been made of the various elements controlling the performance of this type of machine, and one such investigation, which consisted of determining the rotor blade motions and the division of load between the rotor and the fixed wing, has been completed and described in Technical Report No. 475. The results of this investigation served two purposes: (1) The measured loads on the fixed wing have aided in the formulation of design rules for the fixed wings of this type of aircraft, and (2) the load on the rotor correlated with the measured blade motion has provided data needed for a theoretical study of rotor characteristics, the results of which are now being prepared for publication. A brief investigation of the vibrations occurring in a 3-blade autogiro has also been completed, and flight tests are in progress for the purpose of determining the effect of the incidence of the fixed wings on the rotor characteristics and on performance in general.

The second type of rotating wing being investigated, the gyroplane, is similar in general principle to the autogiro, but is fundamentally different in regard to its rotor operation, in that opposite blades of the rotor are rigidly connected and lift on these blades is equalized by oscillation about an axis parallel to the blade span. A theoretical analysis of this type of machine has been completed and is now in preparation for publication.

The third type being investigated, the cyclogiro, derives its lift and thrust from a power-driven rotor consisting of several blades rotating about an axis parallel to the lateral axis of the aircraft. A theoretical analysis of the cyclogiro has been completed and a simplified aerodynamic theory of the machine has been prepared and published (Technical Note No. 467). The analysis indicates that the aerodynamic principles are sound, that hovering flight, vertical climb, and a reasonable forward speed may be expected with a reasonable expenditure of power, and that autorotation in a gliding descent is available in the event of engine failure.

The studies on all three types of rotating-wing aircraft are being continued mainly in the form of wind-tunnel investigations principally for the purpose of improving the rotor characteristics of the autogiro and gyroplane and confirming the soundness of the principles involved in the cyclogiro.

Document 5-39 (b), Excerpts from Annual Report of the National Advisory Committee for Aeronautics (Washington, DC), 1933-40, "Rotating-Wing Aircraft," Annual Report (1934), pp. 16-17.

Considerable effort has been devoted during the past year to a continuance of the theoretical and experimental work on rotating wings, for the principal reason that they are believed to constitute one of the best existing solutions to the problem of safe, stable, and controllable low-speed flight.

The original strip theory of the autogiro was refined and expanded to determine the influence of twisted blades. The altered theory was then used to predict the characteristics of the rotor of the Committee's autogiro and the results compared with data obtained from flight tests (Technical Report No. 475). Reasonable agreement was obtained up to a tip-speed ratio of 0.4, but appreciable discrepancies were found at higher values; also, no comparison of drag could be made, since it was impossible to determine the rotor drag in flight. The altered strip analysis and comparison of theory with experiment are contained in Technical Report No. 487.

In order to obtain data that would be of assistance in formulating methods of predicting the drag of an autogiro rotor, the rotor was tested alone in the full-scale wind tunnel. Lift, drag, angle of attack, and aerodynamic moments were measured at three rotor pitch settings and several rotor speeds, and surveys of the air flow immediately above the rotor were made at two different tip-speed ratios. The information obtained is being prepared for publication as a technical report, and is at the same time being utilized to add further refinements to the strip analysis. It is of interest that the results show the drag of the exposed fittings on the rotor to be about 5 percent of the total rotor drag.

A systematic investigation of the influence of the fundamental parameters of the autogiro rotor has been started in the propeller-research tunnel with tests on a series of model rotors of 10-foot diameter differing only in airfoil section and plan form. Measurements of air forces and moments and the rotor-blade motion are being made at several pitch angles over the entire angle-of-attack range of each rotor. The work is at present only partly completed, but it has been established that the airfoil section of the blade has a critical influence on the maximum pitch setting at which autorotation is obtained. It is expected that the results of these tests will be applicable to the gyroplane as well as the autogiro.

Flight tests on the autogiro disclosed that at high air speeds the rotor speed decreased dangerously and limited the safe high speed of the machine. A study of the load distribution between rotor and fixed wing indicated that this phenomenon

might be caused by a transfer of load from rotor to wing at high speeds. Flight tests were consequently made with the fixed wing set successively to lower incidences, and measurements of the rotor speed and wing pressure distribution were made. The results confirmed the original hypothesis and showed that by a suitable choice of wing incidence the rotor speed could be made to increase at high speed instead of decrease. The results of these tests are being prepared for publication.

An analysis has been made of the gyroplane type of rotating-wing system and published as Technical Note No. 492, and in order to obtain experimental information concerning the aerodynamic characteristics of this type a 10-foot model gyroplane rotor with mechanical feathering was constructed and tested in the propeller-research tunnel. Force and moment measurements were taken from 0° to 90° angle of attack at seven pitch angles. This information is now being prepared for publication.

A model cyclogiro rotor, 8 feet in diameter and 8 feet in span, was built and tested in the propeller-research tunnel. Power input, lift, and drag were measured over the entire operating range of the rotor from conditions approximating hovering flight to those simulating high speed. The power required by the rotor was, in general, found to be disappointingly large, being about twice the predicted value for the blades after the tare power for the shaft and supports had been deducted. The results were such that it is now thought that the cyclogiro has very limited possibilities. The information obtained in the wind tunnel is being prepared for publication.

Document 5-39 (c), Excerpts from Annual Report of the National Advisory Committee for Aeronautics (Washington, DC), 1933-40, "Rotating-Wing Aircraft," Annual Report (1935), p. 16.

Considerable work on rotating wings and on rotating-wing aircraft has been accomplished during the past year. This research is being carried forward because of the marked advantages possessed by the rotating-wing in comparison with the fixed wing in respect to safe, controllable flight at low speeds.

The published results of an investigation of a full-scale autogiro rotor in the full-scale wind tunnel (Technical Report No. 515) demonstrate the influence of blade pitch setting and rotor speed upon rotor characteristics. These data are now being used to check the validity of revisions to the strip analysis of the autogiro rotor.

The influence of change in the incidence of the fixed wing of an autogiro upon the load division and rotor speed has been determined in flight and the information published as Technical Report No. 523. The data have been presented so as to assist in the calculation of the wing incidence required for any load division; in addition, it has been shown that the interference effect of the wing upon the rotor is so small as to be negligible.

An investigation in flight on a direct-control type of autogiro employing a cantilever three-blade rotor has been made for the purpose of studying the rotor

vibrations and flapping and twist of the rotor blades. The results of this investigation will be incorporated in a report.

A report is now being prepared giving the results of a study of a series of autogiro models of 10-foot diameter in the propeller-research tunnel. The influences of changes in the rotor-blade airfoil section and in the blade plan form were studied; the results showed that it was disadvantageous to increase the airfoil section thickness from 12 percent to 18 percent and that the reduction of blade chord near the rotor hub reduced the lift-drag ratio of the rotor. Anomalies in the results indicated that the blades twisted during test, and indicated the necessity of investigating the influence of blade twist in order to isolate the influence of individual factors.

An experimental investigation of autogiro take-off, in which the kinetic energy of the rotor is employed to obtain an initially vertical flight path, has been started. The effects of blade pitch setting, initial rotor speed, and disk loading upon the height of free rise are being studied.

The results of an investigation in the propeller-research tunnel on a 10-foot-diameter gyroplane rotor have been published in Technical Report No. 536. Data that show the influence of blade pitch setting, solidity, and feathering angle upon the rotor characteristics have been obtained; the effect of feathering angle upon the control moments available was also studied.

Document 5-39 (d), Excerpts from Annual Report of the National Advisory Committee for Aeronautics (Washington, DC), 1933-40, "Rotating-Wing Aircraft," Annual Report (1936), pp. 16-17.

The detailed development and steady progress of rotating-wing aircraft during the past year are attested by the construction of several new models of autogiros far superior to any previous ones. The steadily widening field of application of this type of aircraft more than justifies the vigorous prosecution of research directed toward increase in efficiency and the elimination of secondary difficulties arising in a design.

A report has been published (Technical Report No. 552) containing the results of wind-tunnel tests on a family of models of autogiro rotors of 10-foot diameter in the 20-foot wind tunnel. The investigation of systematic variations of blade airfoil section and blade plan form established the fact that the use of an airfoil 12 percent thick results in a higher lift-drag ratio than is obtained when an airfoil 18 percent thick is employed; and it was found that the reduction of blade chord near the rotor hub resulted in a reduction of rotor lift-drag ratio. The evaluation of the data obtained indicated the desirability of extending the tests to include other airfoil sections and established the necessity of making a study of blade twist in order to separate a composite influence on the test results into its constituent parts. The design of models to be used in this extension of the test program is well advanced.

During the past year two direct-control autogiros were purchased by the Army Air Corps for service test and experiment. The Committee conducted investigations in flight for the Air Corps of the control forces and general performance characteristics of these machines.

An experimental study of autogiro "jump take-off" on a rotor model of 10-foot diameter was recently completed. The maneuver involves the utilization of stored excess kinetic energy in the rotor blades for a take-off in which the flight path is initially vertical. The tests included a study of the three basic variables: blade pitch angle, initial rotor speed, and rotor disk loading. The experimental work was supplemented by an analysis of the problem through which it was found that the simple case of a jump take-off without forward speed could be accurately predicted from a solution of the differential equation of motion. The approximations required for the solution were justified by a comparison of analytical and experimental results. The results are to be published in a technical note.

Considerable study has been directed during the past year toward the extension of and improvement in the aerodynamic analysis of the autogiro rotor. One phase of this, which has been completed, is the analysis of the rotor-blade oscillation in the plane of the rotor disk. Study of this phenomenon disclosed that the flapping motion of the blade caused an oscillation in the plane of the rotor disk which was independent of the components of the air forces in the rotor disk and was the dominating factor determining the motion being studied. It was found that a satisfactory first approximation could be made if the air forces were neglected altogether. Experimental data were found to agree satisfactorily with predicted values. The results of this work also will be published as a technical note.

Additional analytical work on the autogiro rotor completed and awaiting preparation in report form includes: a study of the rotor-torque equation, including correction factors graphically derived; a study of the effect of periodic blade twist on the rotor thrust and blade motion; a study of the instantaneous forces on a rotor blade, and their effect on rotor vibrations and rotor pitching and rolling moments; and a study of certain factors affecting the profile drag of an autogiro rotor.

Document 5-39 (e), Excerpts from Annual Report of the National Advisory Committee for Aeronautics (Washington, DC), 1933-40, "Rotating-Wing Aircraft," Annual Report (1937), pp. 18-19.

The development of the direct-control type of autogiro has been delayed to some extent by the introduction of certain secondary difficulties connected with the provision of a satisfactory variation of control forces with air speed and with the elimination of vibration. A study of the effect on certain rotor characteristics of a periodic variation in blade-pitch angle has been made, and the results have been published in Technical Report No. 591. The predicted value of the flapping motion of the rotor blade was radically altered when the periodic pitch variation was inserted in the rotor analysis, and an appreciable influence of the periodic pitch on the rotor thrust coefficient was indicated. An analysis has been made of the factors involved and a method developed of predicting the periodic variation of the pitch angle. The results have been published in Technical Report No. 600.

An investigation has recently been conducted both in flight and in the full-scale wind tunnel on a direct-control autogiro to determine the lift, drag, control forces, flapping motion of the rotor blade, and periodic variation in pitch angle. The tests in the full-scale wind tunnel were made on the complete autogiro, on the rotor alone, and on the machine without the rotor to determine the interference effects between various parts. The data obtained from these tests are being analyzed for use in the study of any desired variation of the location of the center of pressure on the rotor.

An investigation has been started in the propeller-research tunnel on a series of model autogiro rotors having airfoil sections of different thickness and different mean camber lines, and will include two rotors that differ only in plan form of the rotor blades. This work is an extension of an investigation previously made in which the effect of airfoil section and plan form on the lift-drag ratio of an autogiro rotor was studied.

The analysis of the results obtained during the autogiro jump take-off tests has been completed and published in Technical Note No. 582. The report covers theoretical study of the jump take-off without forward speed and includes an experimental verification.

An analytical study of the rotor-blade oscillations in the plane of the rotor disk has been made, and the results have been published in Technical Note No. 581.

A study of the autogiro rotor-torque equation has been made, and a report is in preparation which will include a solution of the problem in chart form.

Document 5-39 (f), Excerpts from Annual Report of the National Advisory Committee for Aeronautics (Washington, DC), 1933-40, "Rotating-Wing Aircraft," Annual Report (1938), p. 17.

In the hope of developing an improved method of direct control for rotating-wing aircraft, research during the past year has been restricted to a theoretical study of rotor control systems. The effect of periodically feathering the blades of an articulated rotor has been analyzed in detail and the aerodynamic identity of the Hafner and Cierva control systems has been mathematically demonstrated. As yet the study has not been extended to cover feathering control of rigid rotors but it is hoped that this can be done in the near future.

A study of the torque equilibrium in the autogiro rotor has been completed and the results published in Technical Report No. 623. This study simplifies and improves the previous method of calculating the inflow velocity required to maintain autorotation in a given rotor. Correct estimation of the inflow is particularly important because all rotor characteristics depend directly on inflow velocity.

Document 5-39 (g), Excerpts from Annual Report of the National Advisory Committee for Aeronautics (Washington, DC), 1933-40, "Rotating-Wing Aircraft," Annual Report (1939), pp. 16-17.

The possibility of improving the lift-drag ratio of rotors of rotating-wing aircraft in forward flight in retarding or preventing the stalling of the inboard elements of the retreating blades is being investigated. The preliminary step in this investigation was to supplement theoretical calculations of the operating blade elements in various parts of the disk with photographic observations of the behavior of silk tufts mounted on the blades of a YG-1B autogiro. The tuft observations indicated that the portion of the rotor disk in which the elements are stalled is somewhat larger than would be expected from theoretical considerations. A technical note presenting the results of the initial observations is being prepared and additional observations on blades of various airfoil section and plan form are in progress.

An attempt is being made to isolate the factors in the design of rotor hubs and blades that are responsible for the severe vibration present in the control systems of present-day direct-control autogiros. To this end, the varying loads in the control system of a YG-1B autogiro have been recorded in flight at various air speeds. Analysis of the records indicates that mass unbalance or improper matching of the blades is not responsible for the control vibration in this machine and that some modification of hub and blades may be desirable. Similar tests on the same machine equipped with blades of improved design are now in progress.

Data on the blade motion and the control characteristics of nonarticulated feathering rotors have been obtained from flight tests of the Wilford XOZ-1 sea gyroplane and are being evaluated.

Document 5-39 (b), Excerpts from Annual Report of the National Advisory Committee for Aeronautics (Washington, DC), 1933–40, “Rotating-Wing Aircraft,” Annual Report (1940), p. 8.

The investigations of the stalling of inboard elements of the retreating rotor blade on the YG-1B autogiro have been reported in Technical Note No. 741. Similar investigations of the same machine equipped with rotor blades of improved design have been completed during the past year. The results indicate that the size and importance of that portion of an autogiro rotor where blade elements operate beyond their stalling angles are appreciably influenced by the static stalling angle of the airfoil section chosen for the rotor blade. They also show that the elimination of control-stick vibrations in direct-control rotating-wing aircraft requires the [missing text] of rotor blades that do not twist periodically during rotation. Much work has been done on the extension of existing rotor theory.

Document 5-40

**Heinrich Focke, “The Focke Helicopter,”
NACA Technical Memorandum 858 (April 1938),
translation of “Der Focke-Hubschrauber,” *Luftwissen* 5
(February 1938): 33–39, by S. Reiss, NACA.**

The FW-61, designed by Heinrich K. J. Focke (1890–1979) in the mid-1930s, is considered by most aviation historians to be the first practical helicopter. Following its first free flight on 26 June 1936, it broke nearly all the world records for helicopters. It stayed in the air for 1 hour and 20 minutes; crossed a distance in a closed circuit of 80.5 kilometers (50 miles); reached a speed of 122.3 kilometers per hour (76 mph); and climbed to a height of 2,440 meters (8,000 feet). Whenever and wherever the machine flew (two of them were built), it caused a sensation, both technically and politically.

E. K. Liberatore has compared Focke’s machine to the historic 1903 Wright Flyer, in that both were “minimal” machines that were just good enough to prove that flight was “feasible but not much more” (*Helicopters Before Helicopters*, p. 159). Like the Wrights, Focke succeeded where so many others had failed because he followed a systematic engineering approach to make the helicopter practical. In particular, the German designer was the first to solve the problem of autorotation, which other helicopter pioneers had neglected even though the “ability to land a helicopter safely with engine failure was the absolute requirement for a practical helicopter” (*Helicopters Before Helicopters*, p. 200). Focke’s first demonstration of this ability came on 10 May 1937 from an altitude of 400 meters (1,310 feet).

Focke’s February 1938 article in *Luftwissen*, which the NACA translated and published two months later as Technical Memorandum 858, is interesting in two major respects. First, it described the process that Focke followed from 1934 on, leading to his design of the first practical helicopter. Second, in it, Focke defended himself against those critics, especially in Great Britain, who questioned whether he had in fact designed a helicopter. As readers will see in the article that follows, Focke specifically took on the challenge to his invention made by helicopter pioneer Oscar Asboth. In 1937, Asboth argued in print that Focke’s machine, if it were truly a helicopter, could not have reached anything like what was being reported as his record altitude of 8,000 feet; contemporary rotor blades simply could not yet provide enough lift. What Asboth suggested was that the FW-61 was really an autogiro; to confirm his allegation, Asboth pointed to the fact that the machine had a second rotor attached out front in the form of an autogiro propeller. These charges against Focke circulated internationally throughout 1937, for example, in the French article “Le Focke Wulf est il vraiment un helicoptere?” (*Les Ailes* 17 [15 July

1937]: 7–8) and in a Dutch publication “Helicoptere oder Autogiro? (*Vliegwereld* 3 [19 August 1937]: 502).

It is not surprising that Focke responded to such charges via his 1938 article in *Luftwissen*, for his machine was no impostor. The “autogiro propeller” that explained to some how the FW-61 performed as well as it did was in fact simply a fan to cool his helicopter’s engine. Near the end of his paper, Focke took exception to “the rather unconcealed charge of deception against me,” particularly as it related to his altitude record. (This was the NACA’s translation; the same words could also be translated as “thinly disguised accusation of fraud.”) Not mentioning the likelihood that Asboth was jealous about the unprecedented successes of his German competitor, Focke simply suggested that Asboth had made some serious miscalculations based on misinformation about his machine. He did chide his critic, however, by pointing out that the FW-61 was to this point the only helicopter able to transition successfully into autorotation, a jab at Asboth’s own machines. But even Focke admitted in the conclusion to his paper that the superior performance of his helicopter came as a surprise, even to himself: “Nobody, myself included, had considered such performance from a first design with small excess power to be possible. It is just this fact, however, which so strikingly brings out the great possibilities which are offered by helicopter flights for the future.”

Liberatore rightfully has supported Focke over his critics, then and now, in terms of his contribution to the invention of the practical helicopter. In *Helicopters Before Helicopters*, he writes, “Some modern, benighted writers on helicopter history take the work of Focke as inconsequential.” Though it is true that no one person “invented” the helicopter, “Focke reduced it to practice by virtue of the right combination of components demonstrating hover capability, vertical flight, and autorotation.” As explained earlier, the ability to autorotate was “the critical, decisive element,” but with today’s helicopters “this feature is rarely in public consciousness” because most people would believe that a power failure with a helicopter results in a catastrophe. Thus, few understand how important the ability to autorotate was to the process of invention. And, “since most helicopters flying today have tail rotors, Focke’s lateral rotor machine suggests a dead-end project and therefore inconsequential,” when it was anything but. Looking back to the Wright brothers again, Liberatore concludes: “It is interesting this view did not hold for the Wright Flyer I which was a fixed-wing dead end and very unlike modern airplanes. The Flyer I featured biplane wings, horizontal planes forward, vertical planes aft, skid landing gear, and a prone pilot. By parallel argument, if Focke’s machine was not the first practical helicopter, neither was the Wright Flyer I the first practical airplane” (*Helicopters Before Helicopters*, p. 226).

One can wonder how much the trouble in recognizing the authenticity of Focke’s achievement was related to the fact that he was German and that on the tail of his aircraft was the Nazi swastika. Perhaps also, when examining a flight technology developed in 1936 rather than in 1903, the standard for evaluation became

more stringent. In other words, fairly or unfairly, more was expected of Focke than of the Wrights, given how much progress in the science and technology of flight generally had been made by the 1930s.

Document 5-40, Heinrich Focke, "The Focke Helicopter," NACA Technical Memorandum 858 (April 1938), translation of "Der Focke-Hubschrauber," Luftwissen 5 (February 1938): 33-39, by S. Reiss, NACA.

The successful record flights of the Focke helicopter of the past year have surprised the world and have brought nearer the first practical solution of a problem that has long occupied the attention of the aeronautical engineering world. It may be expected that with further perfecting of the new type of aircraft new fields of application of aviation hitherto closed will be opened up. Professor Focke has, at our request, made available the following contribution in which he explains in detail the main ideas by which he was guided in his work and describes the methods which finally led to his successful achievement. (Editors)

There is no doubt that the attainment of zero velocity in the air as well as vertical take-off and landing has been a goal striven for in aeronautics that up to the present has not met with any marked success. Performance characteristics such as the above are quite impossible of attainment by the conventional airplane since the latter's ability to sustain itself and its controllability depend on the relative wind in forward flight.

When, thirty years ago, the conventional airplane, as a result of the fundamental simplicity of its design, gained ascendancy over the other types of heavier-than-air craft[,] it seemed that its line of development would be the only one followed. Great progress with this type of airplane has, as a matter of fact, been made, although the progress has been only gradual and no fundamental changes have been made from the original design.

However, with the first visible successes of 1907 to 1909 a circumstance arose which, when viewed from a broader point of view, may be considered as unfortunate as it has served to create hindrances that should have been unnecessary. The unfortunate circumstance referred to is the fact that the conventional type airplane, which was the type that had met with some degree of success, was henceforth practically the only one that came to be produced and all other parallel attempts that had up to that time been made on other types tended to be forgotten. For two or three decades the fact was overlooked that a single practical solution did not necessarily constitute a proof of the impracticability of other possible solutions.

The tenacity with which the methods that made possible the first successful flights were adhered to is something that can be readily understood and, similarly, the overlooking of the fundamental deficiencies of this first solution.

We are well aware of the limitations to which our present-day airplane is subject. Of these we take account, and direct our efforts accordingly. We keep

on making improvements within the limits of its possibilities. This is, of course, proper. We need not, for this reason however, forget one thing as regards the future, namely, that new and wider fields of application which today we find closed to us can be conquered only by going back to the roots of our technical knowledge and seeking new paths.

The problem of designing an aircraft that is to be independent of its forward velocity having once been stated, a requirement immediately enters that can in no way be set aside, namely, that of imparting to the lift members a motion relative to the air. Furthermore, it will be necessary in practice to satisfy this requirement with the greatest possible structural simplicity. Although flapping and bucket-wheel types of aircraft hold out certain technical "lures," calm consideration shows that one of our simplest and also theoretically best known mechanical elements, namely, the air propeller, is still the most suitable.

The idea of a power-driven propeller with vertical axis as a flying device is very old. Leonardo da Vinci had already sketched a first helicopter. Two impulses of quite different origin have in recent times been responsible for the strong interest taken in the helicopter. The first arose from sheer necessity, the take-off and landing in a restricted space as, for example, on ships without airplane catapults, application as liaison airplanes, mountain and colonial airplanes, geographical researches, special tasks of surveying, radio, etc.; all these required a machine with not only moderate, but with even very small take-off and landing distance, possibility of hovering in the air, and arbitrary climb and gliding angles up to the vertical. Likewise, any extended private air communication of the future with the conventional-type airplane will always come up against the difficulty, unavoidable no matter what we try to do about it, of the requirement of a large space for landing and take-off. With a well-developed helicopter, however, roof and garden landings are no longer a Utopia.

The second impulse referred to above came entirely from the technical side. De la Cierva, with his autogiro, has shown practically that a large rotating propeller is a reliable lifting device, as had also been emphasized by him so many times. To be sure, his machine is not a helicopter and cannot therefore rise and land vertically or hover in the air since the rotor is not driven by the engine but "autorotates" freely under the action of the relative wind which is still required. The forward motion is obtained in the usual manner by engine and propulsive propeller.

Unquestionably the autogiro represents a noteworthy intermediate solution between the conventional airplane and the helicopter. By its very existence it has on the theoretical side provided us with insights into which without it we should have had a long time to wait. The government authorities in England who were to test Cierva's autogiro have provided such experts in aerodynamics as Glauert and Lock with the stimulus for rendering a clear explanation of the peculiar process of autorotation, i.e., of the fact that the large propeller at small angles of attack turns freely under the action of the relative wind.

An extension of the Glauert-Lock computation method to the forward flight of a helicopter is theoretically possible down to very small velocities and has served as the theoretical basis for the construction of my helicopter.

As regards the progress that had been made at the beginning of my work on helicopters in 1932, the following performances of the Pescara (France), d'Ascanio (Italy), and Oehmichen (France) were officially or at least semi-officially confirmed:

Range	about 1 km
Duration	about 10 min.
Altitude	about 18 m

No continuous flights with a helicopter, even only on the experimental level, have been recorded, however.

With this state of affairs, and with the general state of flight technique and flight science, the problem cannot be solved by merely adding to the many previous designs still another which perhaps would fly several meters higher and farther without ever becoming adapted to practical flight. The only solution was to create an aircraft, although at first only an experimental aircraft, that was truly worthy of the name. The attainment of this object, however, must be striven for with all the technical means at our command. Inventive ideas are good and necessary but a calm consideration of all points of view of importance to the problem and the working out of all technical foundations is the better method.

The requirements which practice will impose on the completed aircraft and which are the determining factors for the points of view mentioned above follow in the order of their importance:

1. **Possibility of a forced landing in case of engine failure.**—This basic requirement, by far the most important, has not been practically satisfied by any helicopter although the theoretical possibility of allowing the propeller to go into autorotation has long ago been pointed out even before Cierva. For this purpose it is necessary that the blade setting of the propeller be reduced as compared with the operation of the same propeller as [the] helicopter, since by this means alone is autorotation assured. This means further mechanical complexity which, however, cannot be dispensed with since an aircraft without the ability, after failure of the engine or force transmission gear, of landing smoothly is unthinkable as a practical machine. The next important requirement is that of:
2. **Controllability and stability.**—The aircraft must, at least with normal skill of pilot, be controllable in all flight conditions, hence also when it is hovering in the air. It is still better to have static stability about all axes and, as far as possible, also dynamic stability. This is where the sore spot lay in all the previous helicopter tests. In most cases it was reported that only through simultaneous, exact, lightning-fast control motions was it possible to keep

these helicopters for some minutes in the proper attitude. In the case of other designs which, for other reasons[,] were later dropped, it was claimed that they had shown themselves to be stable without any explanation for such stability being offered. The prophecies of Kármán probably had much to do with the pessimistic statement that practical, continuously flying helicopters, were impossible.

3. **General safety in operation.**—In this respect, too, lay a great weakness of the helicopter. There could hardly be any talk of safe operation where the duration of flight was still reckoned in minutes. To be sure, the fixed structural parts are subject to hardly any conditions other than those for the main body structure in the case of the conventional airplane. The driving parts, however, must be made at least as reliable as the engine, whose reliability of operations will be smaller and presumably will remain smaller than that of fixed airplane structure. It is understood of course that we are considering here the reliability of operation in general which determines the continuous practical usefulness of the aircraft. The ability to make a forced landing discussed under 1, is an essential preliminary condition that must be satisfied, together with the reliability of operation of the structure. Directly connected with the practical usefulness is the requirement of:
 4. **Simplicity of the piloting maneuvers.**—The technical side of a new problem is always only a part, perhaps the smaller part of the whole problem. The other part concerns the one who is to drive the new machine. It is therefore one of the most urgent requirements to render this task of piloting as easy as possible for him. It is all the more necessary to provide him with methods of control and control members with which he is acquainted or which in any case require only a few more manual controls. Furthermore, we cannot dispense with the requirements of:
 5. **Acceptable performance.**—It is obvious that we cannot expect, particularly at the beginning, that the maximum performance of the conventional-type airplane will be attained. On the other hand, a price must be paid for the exceptional performance of rotating-wing aircraft in the region of low velocities. Still the value of a helicopter will be seriously restricted if, for example, it were only able to hover in one place in the air. We shall therefore have to require that its performance be at least comparable with that of the airplane. Finally, a not unimportant requirement is that of:
 6. **Reasonable servicing.**—It is naturally necessary for the personnel working with a new type of aircraft to get accustomed to it. Nevertheless, we must emphasize that the body should require about the same type of servicing as that of the conventional airplane and the engine about the same as that of an ordinary aviation engine. There will then arise no greater difficulties after a certain initial period.

The above enumeration of only the main requirements shows that for the problem of the ideal rotating-wing aircraft there exists no surprise solution by any invention, patent, or Columbus egg, but that only one way is open, that of making a thorough study with equal care of the many diversified questions and taking them all into consideration in the design. Many of the questions such as the extensive stability investigations are of an entirely theoretical character. Others, for example, the problems of simple manipulation and control, are primarily of a practical nature. Between these are to be found the difficult problems in connection with the construction of the aircraft parts.

The production of lift of a propeller.—The generation of a propeller thrust which is here equivalent to lift offers nothing particularly new. The computation

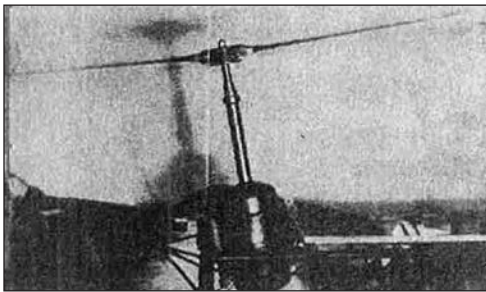

FIGURE 1. Model of three-blade propeller driven by a 3 hp. electric motor for tests in wind tunnel.

has been performed so often and so thoroughly that little remains to be added. The three-blade propeller of tapered plan form was also subjected to extensive wind tunnel investigations both as a helicopter and as an autogiro propeller. Figure 1 shows a model of this three-blade propeller driven by a three-horsepower electric motor. The outfit rests on the wind-tunnel scales, which measure all air forces and moments.

The measurements require great care since there are many sources of disturbance, the details of which cannot be individually discussed here. One essential circumstance will be mentioned, however, since it also has a direct bearing on practical helicopter flight, and that is ground effect. On approaching a sufficiently large horizontal plane there is a considerable increase in the thrust and to a smaller extent also in the torque of a propeller, as soon as the distance becomes comparable with the propeller diameter. In practice this effect is very marked. With a given throttle setting the helicopter lifts off the ground, but with no more power supplied to the engine, does not rise above a few meters. A helicopter without sufficiently great excess power will never rise above this "floating level." On the other hand, this phenomenon gives rise to a

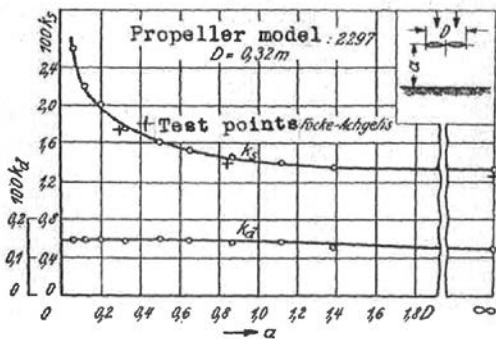

FIGURE 2. Results of Flachsbar on the ground effect on a propeller.

welcome cushioning effect in landing. Up to the present only a few tests on ground effect have been available, the best ones still being those of Flachsbart (1928) which were well confirmed by our own measurements. The upper curve of figure 2 gives the increase in thrust, the lower one that in the torque with decreasing distance from the ground expressed in propeller diameters. The three points marked with crosses are those corresponding to our own measurements.

Control and stability.—No control is thinkable without a previous existence of complete balance of the moments. This is where the well-known difficulty, which to a large extent has stamped the whole character of the helicopter problem, lies. The large, slowly rotating propeller exerts an unbalanced moment of the order of hundreds to thousands of kg-meters on the aircraft. The manner in which this moment is balanced determines

the entire structural character of the helicopter. Many designs have been proposed as shown in figure 3. Two oppositely rotating propellers placed one above the other (a) Breguet, d'Ascanio, Pescara, Asboth, (b) two propellers one behind the other (Cornu) or even four, one at each of the corners of a square (de Bothezat, Oehmichen), (c) two oppositely rotating propellers side by side (Berliner, Focke), (d) apparently

paradoxical, two propellers rotating in the same direction, but with axes so inclined that the lateral components of the total moment are eliminated (Florine, Belgian Government), (e) a single large screw on whose blades are located small propellers (Isacco, Curtiss-Bleeker), (f) the blades carry out flapping motions so that no unbalanced moment arises, further, (g) a single helicopter propeller and on long outriggers of the fuselage one or more propellers whose thrust opposes the helicopter moment, [*sic*] (Baumhauer, Holland), (h) a propeller mounted behind the helicopter screw and in whose slipstream are placed deflecting vanes (Hirtenberger Patronenfabrik, Austria), (i) such vanes have even been tried in the helicopter slipstream itself (Hafner and Nagler, Austria). Finally, there has been proposed a method of drive by reaction nozzle (k) (Dornier patents, Papin and Rouilly, France, with counterbalanced single-blade propeller and air under pressure).

Of all these proposed designs we may immediately eliminate those which require a considerable additional power expenditure or involve a loss in performance. These are (a) for which the efficiency of the small propellers enters into the propulsive output of the helicopter so that about 30 percent is lost, (g) and (h), where to produce the reaction force continuous power must be expended which,

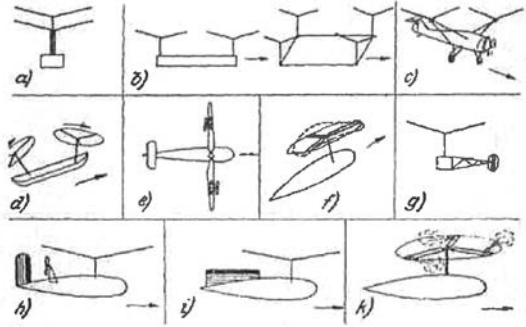

FIGURE 3. Proposals for balancing the helicopter propeller moments.

with a feasible design, may be estimated as from 20 to 30 percent. Also, in order to realize any practical design we must exclude those designs the bases of which are not yet sufficiently clear. These are (f) and (i), reaction and flapping drives. Both may possibly be called on later to play a part. Type (d) offers no advantages as compared to (b) and (c), the inventor having wished to maintain the gyroscopic effects which are lost with the oppositely rotating propellers. If we further exclude the use of more than two propellers for the present on account of the increasing mechanical difficulties there remain three possibilities, namely, two oppositely rotating propellers, one above the other, one behind the other, or side by side. Up to the present the first of these has generally been built. The most successful helicopter up to the past year, especially that of Breguet-Dorand in France, had this arrangement. Considering the matter more closely, however, and the fact that so many constructions were doomed to failure, this solution, too, cannot be considered as final. In the first place, the designers keep on reporting of the almost insuperable difficulties due to the vibrations which are excited by the arrangement of blades rotating one above the other. Furthermore, the efficiency of the propellers with this arrangement is generally smaller than that of separately running propellers. The slipstream acts on the entire surface of the aircraft, on the fuselage, control members, etc., thus resulting in a lowering of the effective thrust. An approximate calculation shows that the advantage of saving in weight as compared with the side-by-side arrangement is thereby to a large extent offset. In the case of forced landing with propeller acting as windmill a smaller disk area is made available.

Also in the case where the propellers are arranged one behind the other there is, at least in forward flight, a very considerable influence exerted on the rear propeller by the forward one. The fact must be considered that behind a helicopter propeller downwash directions are encountered to which we are not accustomed in the conventional airplane and these have a strong effect on the pitching moments.

The only arrangement which permits no unfavorable interactions of the two propellers is the side-by-side arrangement on the fuselage. Induced vibrations of the blades will in this case not occur. In the case of forced landing the full disk areas of both propellers are available, their mutual induction having the effect of increasing the aspect ratio. The efficiency is always as high as for the case of the single propeller. There is practically no interference and only the essential parts lie in the slipstream. The space requirement is also not very different since what is saved in span in the case of the vertical arrangement must in part be made up in length and above all in height.

We now come finally to the consideration of the stability and controllability. Many autogiros are controlled and stabilized by tail surfaces of the type used on conventional airplanes. In the case of the helicopter, when it is hovering in the air, this is no longer possible. The idea naturally suggests itself of using fixed vanes and movable surfaces in the slipstream of the helicopter or that of a normal propeller[,] and both of these methods have, in fact, been tried by us as well as others but with

little success. More suitable to the fundamental character of the helicopter is the control and stability by utilizing the propeller blades themselves, a method that has been applied on my machine.

Special careful attention has been given to the stabilizing and control processes at the instant of conversion from helicopter to autogiro (or windmill) flight. Exact instructions could therefore be given to the pilot, particularly on the possible manual operations and trimming of the stabilizer surfaces. In actual flight control was effected as was predicted by the computations and a 3-point landing was obtained the very first time from an altitude of 400 meters. About two seconds after conversion from helicopter to windmill the machine was executing normal gliding flight. It may be said that this performance, which Pilot Rohlf's first accomplished on May 10, 1937, and has since then often repeated, marked the beginning of practical helicopter flight. The ghost of engine failure had lost its terror.

I should not omit to mention the fact that the computational and experimental work involved before these results were attained was very great. Stability computations, in particular, become formidable in extent. Since new territory is everywhere encountered, conscientiousness requires that abbreviated methods and the neglect of certain factors be avoided. If such methods must be used, for example, because the limits of the mathematical possibilities have been attained, then they must be justified by a large number of special, even tedious, tests. The success attained, however, has justified the efforts expended. The first free flight of my machine lasted 28 seconds, the fourth 16 minutes. Even if a large part of the credit may be ascribed to the skill of Pilot Rohlf's, the results achieved would have been unthinkable without a thorough sifting of the technical material.

Considering now the performance, I should like to differentiate between what is already directly attainable today, or shown to be possible, and what we are to expect in a more distant future from the rotating-wing aircraft.

A) AUTOGIROS

Schrenk has made an interesting comparison between the characteristics of airplanes and autogiros (fig. 4). The actual difference occurring is partly due, however, to the impaired relations with respect to the harmful drag which by better streamlining of the propeller hub, etc., may be reduced in the future. It may therefore be estimated that an autogiro will remain inferior to the conventional airplane as regards speed by about 10 percent, but on the other hand, has about half the minimum velocity.

With regard to the climb performance the comparison appears still more disadvantageous. Since we are now in the upper portions of the polar curves[,] the drags become very high. The smallest required power for level flight is considerably higher than in the case of the conventional airplane and occurs also at smaller velocities, a circumstance which is undesirable on account of the propeller efficiency. It is

this fact which confirms the view we had expressed at the beginning, namely, that the autogiro is destined to play only the part of a transition aircraft from the conventional airplane to the helicopter. The autogiro fails to solve half the problem since, while it makes possible landing in a small space, it does not permit a velocity zero while the take-off and all other performances connected with the climb characteristics are less favorable. As regards weight, there is no essential disadvantage. On the contrary, particularly in large designs, the reduction in weight caused

by the use of lifting surfaces free from forces due to pressure and extended by the centrifugal forces should more than offset the heavy propeller hub and starting gear. This is a very valuable property of all rotating-wing aircraft and hence also of

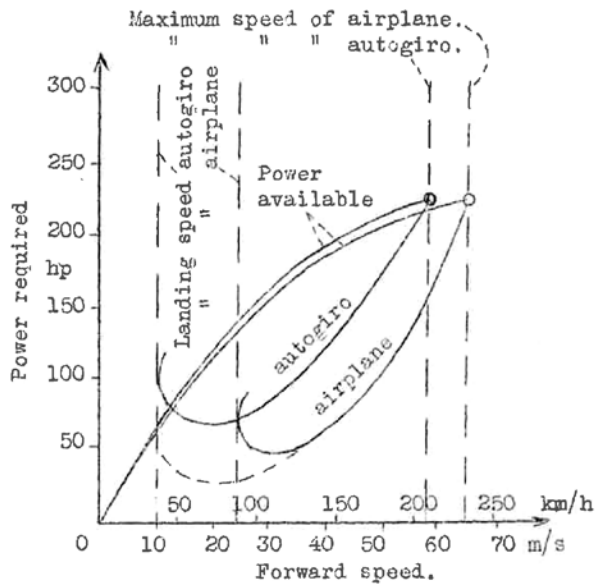

FIGURE 4. Comparison of required and available power of conventional airplane and autogiro.

B) HELICOPTERS

which we shall now consider. In regard to the question of weight we must still make the greatest sacrifice, probably the only one in the future. The gears must transmit to the propellers with sufficient reliability the full maximum power of the engines, a circumstance which in the case of small aircraft puts the helicopter at a disadvantage as compared with the conventional airplane. Breguet has computed a helicopter of 16 tons gross weight and claims to have found a saving in weight as compared with the corresponding airplane. Although this appears too optimistic, it may be stated roughly that with increasing size of aircraft the proportion of the weight taken up by the drive gear will be reduced sharply as compared with the weights very small due to absence of pressure forces of the lifting parts.

As regards the maximum velocity the question arises at the very beginning whether it is advantageous to have a given rotating-wing aircraft operate as an autogiro or as a helicopter, that is, without propulsive propeller. For it is conceivable that our initial requirements would be met if the helicopter in high-speed flight would operate as an autogiro or in some intermediate state. This important question we

have investigated by a detailed computation supported by tests and have obtained the interesting result that the same aircraft operating as a pure helicopter is considerably faster even after 10 percent had to be deducted for engine cooling. Practical experience with my helicopter has well confirmed this result.

	Rate of climb m/s	Weight kg
F.W. 44 Stieglitz airplane	3.5	870
Cierva C 30 autogiro	1.5	815
F.W. 61 Helicopter as autogiro (windmill)	1.3	950
F.W. 61 Helicopter as helicopter	3.6	950

FIGURE 5. Comparison of airplane, autogiro and helicopter.

I should like to point out at this place that my high opinion of the helicopter is not necessarily based entirely on the proof of its equal or higher climb and speed performance as compared with the airplane. The helicopter is justified by its peculiar properties which determine its special purposes. It is all the more advantageous that it is at least not very inferior to the airplane.

So far, we have considered the extensive knowledge that was necessary for the development of a helicopter. Again it must be emphasized to what a large extent science has formed the basis for building up the new knowledge. The second and still more difficult part of our task consisted in putting this knowledge to practical application in design, construction, and testing.

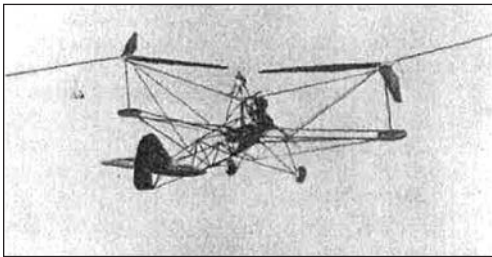

FIGURE 6. A Focke free flying model helicopter driven by a 0.7 hp. gasoline engine. The model attained an altitude of 18 m.

The high-climb performance of the helicopter is also very marked. Figure 5 gives a comparison of the measured rates of climb at the ground and the weights of the Fw 44 "Stieglitz," the Cierva C30, and the helicopter flown both as helicopter and as autogiro with the same Sh 14a engine. It should be observed that the weights were not equal; the helicopter is heaviest, but nevertheless has the greatest climb performance. The autogiros fall quite behind.

The first step was the construction of a free flying model (fig. 6). It was driven by a 0.7-hp. two-stroke-cycle engine and with 50 gallons of gasoline had a gross weight of 4.9 kg. It will be understood that it was more often apart than together but it nevertheless furnished us with many valuable experiences. In November 1934 it attained an altitude of 18 m, which happened to be the world record at the time for large, manned helicopters.

We further subjected the engine, together with its coupling and the blade control, to a test somewhat as is done in the case of a new engine. The Brandenburg

engine works, which under the personal direction of Mr. Wolff took upon itself the difficult task of the construction of this gear and the modification of the Sh 14a engine and achieved such marked success, at first constructed only one side of the driving gear. It was mounted with a single helicopter blade and the supporting structure on a mock-up fuselage. The helicopter was electrically driven, using a Leonhard system so that the propeller power could be measured. The thrust was measured by the suspension of ballast, the fuselage being made rotatable about its longitudinal axis, and the ground effect being taken into account. A 50-hour continuous run was made and the controls tested.

Figure 7 shows the bevel gear drive with the friction coupling and the safety devices which, in the case of injury to the engine or gear or lowering of the rotational speed below a certain minimum, automatically convert the helicopter propeller to a windmill. Figure 8 shows one of the propeller hubs with the control parts for the blade motion.

The construction of the body and of the propeller was made to follow the lines of a normal airplane. For cooling the engine in hovering flight, a blower propeller was developed and by cylinder-temperature measurements was tested in cooperation with the Brandenburg motor works. (See fig. 9.)

The completed model was at first "flown" many times while anchored to the ground (fig. 10). These "captive flights" are an excellent means of testing since all flight conditions are completely simulated while the helicopter is no more than 0.5 to 1 m above the ground. No stage of testing was attempted without previous investigation

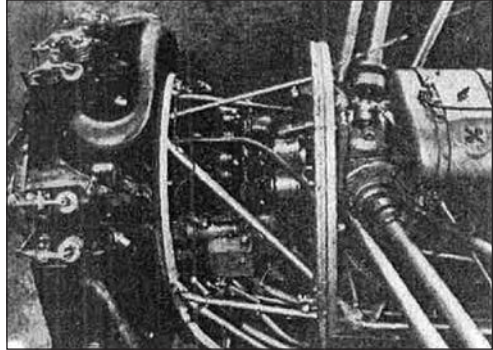

FIGURE 7. Bevel gear drive with friction coupling.

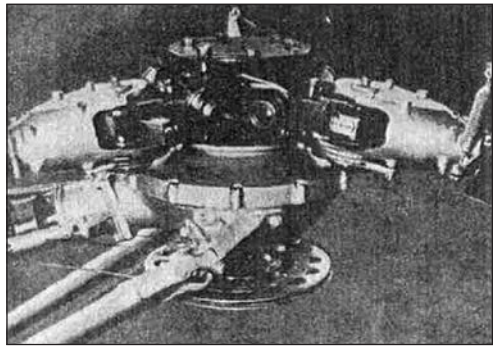

FIGURE 8. A propeller hub with the control parts for the blade motion.



FIGURE 9. View of the helicopter with the propeller used for cooling.



FIGURE 10. Model aircraft being tested while still "captive" on ground.

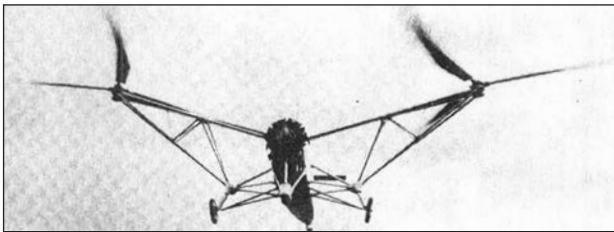

FIGURE 11. The first free flight carried out by Rohlfs June 26, 1936.

of the preliminary conditions by computation or special test. On June 25 and 26, 1937, this model was able to bring to Germany all the helicopter world records by outstripping the existing performances 15-fold (fig. 11). The altitude attained of 2,439 meters (9,000 ft.), which by no means was the absolute ceiling[,] has given rise to the rather unconcealed charge of deception against me on the part of Mr. Asboth in a foreign technical journal. Asboth doubts, in particular, that the air-

craft operated as a pure helicopter in attaining this altitude and thinks it probable that the aircraft at that altitude was flown as an autogiro like that of de la Cierva. He believes he is able to show by computation that this altitude could not have been attained as a helicopter, giving figures and weights that are far from actuality. I should like to state at once—and numerous witnesses will at any time confirm it—that all of the record flights from beginning to end were pure helicopter flights and, for the purpose of putting to nought any such doubts as those of Asboth, that each landing was effected vertically as a pure helicopter. The pilot was expressly requested to do that by the sport witnesses of the F.A.I., whose unimpeachability Asboth will probably not question. It is true, as has been said, that aside from the record flights, the aircraft has made many repeated landings with engine stopped. Before the flight of this particular machine, *no* helicopter has been able to effect a smooth landing with power off, including Asboth's own helicopter.

The attainment of an altitude of 2,439 meters in helicopter flight is based on knowledge which, judging by Asboth's computations, was not available to him. I agree with Asboth that no technical wonders have been accomplished, but the results have been obtained after an unbroken five-year period of continuous work on the helicopter problem. I cannot help it that in his article, Asboth shows repeatedly that he is unacquainted with my work. Furthermore, the construction of the helicopters, the results of years of computations, wind-tunnel and full-scale tests originate with me alone, however much Asboth seems to doubt it and claims that good helicopters aside from his own are quite unknown. He appears to forget that

by patience, hard work, and knowledge any technical result may be achieved that is not contrary to the natural laws.

In June the German Government took over the first helicopter and in October the second. The latter helicopter was flown in October 1937 by Hanna Reitsch from Bremen to Berlin wherein she further improved the world record between Stendal and Tempelhof to 108.947 km/h (67.67 m.p.h.). No one, myself included, had considered such performance from a first design with small excess power to be possible. It is just this fact, however, which so strikingly brings out the great possibilities which are offered by helicopter flights for the future.

Translation by S. Reiss,
National Advisory Committee for Aeronautics.

Document 5-41

Igor S. Sikorsky, “The Helicopter Becomes a Reality,”
The Story of the Winged-S: Late Developments and Recent Photographs of the Helicopter; An Autobiography (New York: Dodd, Mead & Company, Inc., first published in 1938, with subsequent editions in 1941, 1948, 1958, and 1967).

The 1996 *World Almanac and Book of Facts* (Mahwah, New Jersey: Funk and Wagnalls, p. 174) credits Igor Sikorsky with inventing the helicopter in 1939, in the United States. As the previous header should make clear, this is one “fact” that the *World Almanac* has wrong; if any single person deserves credit for “inventing” the helicopter, that honor should belong to German designer Heinrich Focke for his FW-61 of 1936. To repeat, one of the reasons to credit Focke over Sikorsky is that his machine was the first to demonstrate effective autorotation—something that a Sikorsky helicopter did not do until 1941–42.

But Sikorsky most definitely deserves considerable recognition for what he achieved with his helicopter design. An immigrant to America from Russia after the Bolshevik Revolution of 1917 who first earned his reputation as a builder of flying boats, Sikorsky in the late 1930s laid out what would become the standard configuration for the modern helicopter—a vehicle with a single main three-bladed rotor, one with collective pitch, plus a tail rotor. This is what the *World Almanac* should record about Sikorsky, and that his tail rotor was the first practical one ever to be built. Although he did not necessarily invent the concept of the tail rotor, either. As far back as 1909 through 1912, fellow Russian Boris N. Yur’ev had sketched out different tail rotor designs in helicopter drawings. And more than 30 years before that, in 1874, Wilhelm von Achenbach expressed the concept. (There is no evidence, though, that Sikorsky was aware of either.) But it was Sikorsky who first made the configuration real, first in a design created in 1930 and then for his prototype tail-rotor helicopter, the VS-100, of 1939. It was Sikorsky’s arrangement (later borrowed by Piasecki, Bell, Hiller, and others) that became a standard component of helicopter design from the VS-100 to this day.

In this chapter from his autobiography *The Story of the Winged-S*, first published in 1938, Sikorsky recounts his design of the innovative VS-100 and the procurement of the XR-4 by the U.S. Army Air Services. As the chapter reproduced below comes from the 1967 edition of his book, the story of Sikorsky’s helicopters extends well beyond these two machines to include discussion of his S-55, S-56, and S-58 machines of the 1950s, as well as S-61 and S-65 helicopters of the 1960s.

Document 5-41, Igor S. Sikorsky, "The Helicopter Becomes a Reality," The Story of the Winged-S: Late Developments and Recent Photographs of the Helicopter; An Autobiography (New York: Dodd, Mead & Company, Inc., first published in 1938, with subsequent editions in 1941, 1948, 1958, and 1967).

The early pages of this book include the description of the first two helicopters which I built and tested in 1909 and 1910. Experience gained from this work, and my intuitive feeling, brought me then to the realization that the general standing of aeronautical technique as well as my own knowledge and financial means were not yet sufficient to solve the problem of the practical helicopter. Consequently, in May, 1910, this work was discontinued and for the next twenty-nine years I was designing, building and flying different types of airplanes of my own. While I had a good share of success and all kinds of interesting experiences, particularly with large planes and Flying Clippers, I never abandoned the idea of a helicopter.

As aviation progressed, a vast amount of knowledge was accumulated. Better engines, lighter materials and more experienced mechanics became available. In 1929 I came to the firm conclusion that a successful practical helicopter would soon become possible. In 1930 I completed a project and in 1931 applied for a patent for a helicopter that was similar and included nearly all major features of the VS-300 aircraft. However, time and attention during the next few years were so occupied by the very important and interesting work of designing and producing the first transoceanic clippers that it was impossible to concentrate enough efforts on a radically novel and very difficult project. Finally, it became possible to resume seriously the study of a helicopter.

Late in 1938, in line with my recommendation, the management of United Aircraft decided to embark upon the development of a direct lift aircraft. It was most interesting, I would say thrilling, to resume a certain engineering development where it was discontinued nearly thirty years earlier, not only in another country but even in a different hemisphere.

The type of aircraft, which I had been developing on paper since 1929, was a simple helicopter with one main lifting screw and one small auxiliary rotor situated at the end of a fuselage and used mainly to counteract the torque of the main lifting screw. The machine included a system of controls for changing the pitch of each of the propellers and also for varying the incidence of the blades of the main rotor along certain sections of the disc of rotation. These latter movements, sometimes called the cyclic control, enabled the pilot, by moving the stick, to feather the blades so that their pitch was increased at any given point in their cycle of rotation, while at the opposite point in the cycle the pitch was simultaneously decreased. This arrangement was expected to form the means for longitudinal and lateral control, while the change of the pitch of the auxiliary rear propeller would provide directional control.

It was again a case of advanced pioneering work along lines where extremely little reliable information was available. But the ability, experience and well-trained intuition of a fine engineering group made it possible to attack the novel and difficult problem successfully.

The new helicopter, called the VS-300, was designed in the spring, built during the summer and was ready for tests in the fall of 1939. The light, strange-looking machine had a four-cylinder, 75-horsepower, air-cooled engine; a three-bladed main rotor, 28 feet in diameter; a welded, tubular steel frame; a power transmission consisting of V-belts and bevel gears; a two-wheel landing gear and a completely open pilot's seat located in front in a way resembling the very early airplanes.

As may well be expected, the completion of the new machine marked not the end but the beginning of the most important phase of engineering work, which is the period of discovering and overcoming troubles. At first we could not accelerate the blades to normal speed because some very objectionable shaking would take place. The trouble was corrected and it became possible to increase the velocity until the machine made small hops, but then it was discovered that the control action needed a great deal of improvement[.]

A considerable amount of work was done which resulted in the refinement of the machine. A new technique of flying was developed. In November, 1939, we were able to make hops of one or two minutes' duration, hovering over one spot or moving slowly forward. With greater power the aircraft would undoubtedly stay in the air for longer periods, but the action of the controls was still too weak and needed improvement.

A new scheme was quickly devised and installed which did away with the feathering control on the main rotor. Instead, two additional propellers were mounted at the rear, one on each side of the fuselage. The pitch of these rotors was determined by the movement of the main control stick. The push-and-pull movement would change both propellers equally and in the same direction, giving longitudinal control, while the transverse movement of the stick would change the pitch in the opposite direction, giving lateral control.

To study the action and permit ourselves some training, we mounted the helicopter without the main rotor on a support that permitted tilting the machine in all directions. The control appeared satisfactory and, after about one week of training, the main lifting screw was mounted again and flights were resumed. In flight it was much better but we were more careful now because we had learned that with inadequate control and experience the aircraft could easily turn over near the ground—as it did once, before the new control system was installed. Therefore, we attached ropes to the landing-gear struts and for a few weeks continued training and test flights with men holding the helicopter with the ropes. This proved to be an excellent way of carrying on the engineering development work and training the pilot with very little risk of damaging either the machine or the pilot himself. Finally, with enough confidence in the aircraft and the flier, we dropped

the ropes and started to make free flights. By the middle of the summer of 1940, the helicopter was able to remain in the air for fifteen minutes under reasonably satisfactory control.

I did most of the flying at that time and became very familiar with the helicopter's operation. During my years in aviation, I had never been in a machine that was as pleasant to fly as this light helicopter was, with a completely open cockpit. It was like a dream to feel the machine lift you gently up in the air, float smoothly over one spot for indefinite periods, move up or down under good control, and move not only forward or backward but in any direction. Time and again the satisfactory control characteristics permitted the craft, in full flight, to approach a man standing on the ground or on a pile of rocks and allow him to receive or deliver a package, after which the helicopter would either rise straight up or move directly backward. As for landings, it was possible to come down not only within a few feet but even within a few inches of a spot previously designated on the ground. It was a most interesting and pleasant sensation to perform all these maneuvers with ease and accuracy many times, despite reasonably strong winds. There was great satisfaction in knowing that, within a short period of time, good engineering along a novel line produced encouraging and promising results.

During the next several months we continued gradually to accumulate further engineering data and flight experience. A large number of minor engineering problems and a few major ones were gradually solved, the primary objective of our work being the accumulation of data for the design and construction of successful and practical direct-lift machines in general. Even though demonstration flying of the experimental machine was given a secondary position in our efforts, I succeeded in establishing an American helicopter record of endurance by remaining in the air a little over one hour on April 15, 1941. Two days later the machine, mounted on rubber floats, was operated from both land and water; this is believed to be the first practical flight of an amphibian helicopter in the world. On May 6, 1941, a world's record for endurance was established by a flight of one hour, 32 minutes and 26.1 seconds.

I believe that the success of the VS-300 was the result of a correct engineering approach to the whole problem. At the outset of this program, the only thing we knew was that we had very little reliable information about helicopters—and no flight experience whatsoever. In the face of these difficulties, we decided not to attempt an attractive, finished-looking aircraft but to create a purely experimental, fact-finding device that would give us information on design, flight and control characteristics as well as the chance to train ourselves with minimum risk to pilot and aircraft. In view of this, I decided to use the belt drive in the transmission which permitted rapid changing of the reduction gear ratio by replacing the pulleys. I also decided on the use of an old-fashioned, welded, tubular-steel structure for the machine. This allowed rapid alterations during the process of fact-finding and training. Thus, when unsatisfactory behavior or control characteristics were

detected during a flight, it was sometimes possible to make proper decisions that same evening, cut off certain parts and reweld them in a different position during the night and have an aircraft of substantially different configuration ready for flight the next morning. As a result, we quickly accumulated important information pertaining to design and flying techniques which, in turn, permitted us to overcome the numerous difficulties that confronted us, to discover a multitude of important facts and, within less than two years of flight experimentation, to develop a practical helicopter.

The high points of this work were as follows:

Around February or March of 1939, the management of United Aircraft Corporation authorized the preparation of drawings of the experimental aircraft. During the summer, the VS-300 was designed and built. On September 14 of the same year, I made my first hop in the machine. The following spring it became possible to remain in the air for fifteen minutes under reasonably satisfactory control and on May 6, 1941, a little more than two years after permission was granted to begin preparation of the drawings, the VS-300 brought to the United States a world endurance record for helicopters. During this time, four major and a number of minor alterations in the design were made and several thousand flights took place.

In 1943, I delivered the experimental VS-300 to the Edison Institute Museum at Greenfield Village, Dearborn, Michigan, where it is on permanent exhibit.

The successful flights of the VS-300 created much interest and resulted in our receiving an order from the United States Army Air Forces for an experimental two-seater helicopter.

This helicopter, the XR-4, was completed, tested and successfully delivered by air from Bridgeport, Connecticut, to Dayton, Ohio, in May, 1942. This was the first cross-country flight ever made in the United States by a helicopter. I had the good fortune to fly as co-pilot a substantial part of the way. It was a most pleasant and comforting feeling to fly the helicopter, knowing that literally any small cleared spot could be a landing field and that routes could be checked by stopping in the air near a highway sign or by asking information of a passing motorist while hovering—which, by the way, we actually did.

The craft created a great deal of interest, particularly at the airports. On one occasion the landing spot in front of a hangar was purposely overshoot and the helicopter flown about thirty feet above and some 100 feet beyond its designated landing place. It was then leisurely backed, stopped in the air, and, finally, very gently and slowly, lowered to a perfect landing on the exact spot. One of the airport mechanics who witnessed the performance remarked: "I don't know whether I'm crazy or drunk."

The delivery flight of the XR-4 to Dayton and the subsequent tests and training of a few Air Force pilots was the next major step in the process of the "helicopter becoming a reality." On July 24, 1942, our organization was honored and encouraged by a telegram received from Brigadier General Arthur W. Vanaman,

commanding general of the Materiel Center, Wright Field, Dayton. It read as follows:

Today the XR-4 passed the 100-hour mark and completed the primary training of five Air Force officers, two of whom soloed this morning. Few experimental aircraft have accomplished such a record in the short space of two months. I extend my sincere congratulations to you and the members of your organization who took part in making this possible. The XR-4 is, indeed, proving its mettle.

It would be right to state that, with the successful flight of the XR-4 in the summer of 1942, the helicopter became a reality in the United States. Its practical value and possibilities for the future were proven beyond any doubt. From then on, it became a question of improving the details, designing larger and more efficient types of craft and organizing production, because the fundamentals were already established. Soon afterward, the helicopter entered actual service.

The first mission of mercy flown by the helicopter took place early in January, 1944, when Commander Frank A. Erickson, U.S. Coast Guard, used one of the first Sikorsky R-4s to transport urgently needed blood plasma from Battery Park, New York City, to Sandy Hook, New Jersey, where the victims of a ship explosion were receiving emergency treatment. The flight was completed in a snowstorm and in a fraction of the time any other means would have required. This flight to Sandy Hook was the first of many mercy missions.

As time went on, the number of helicopter rescues became so great and their nature, in many instances, so dramatic and interesting that I have devoted a special chapter ("A Device for Saving Lives," Chapter XXIV) to the description of at least a few of them.

As a growing number of our military personnel and civilians began to recognize the outstanding qualities of the helicopter, the rate of its progress and the spread of its use increased. This was reflected in many expressions, catchwords and even nicknames involving the helicopter. H. Franklin Gregory (now a retired Air Force general), who greatly contributed to the acceptance and development of the helicopter in the United States, called his excellent book on helicopters *Anything a Horse Can Do*. To General Gregory goes the honor of several firsts. He made the first shore-to-ship flights by helicopter, making several takeoffs and landings in the XR-4 helicopter on a small platform built on a tanker. Later, General Gregory made the first nonstop helicopter flight from Washington, D.C., to Dayton, exceeding by far the then-existing world records for distance and duration.

Another name that must be mentioned in connection with the early flights of our helicopters is that of Charles L. (Les) Morris who was our test pilot at that time. He tested the XR-4 helicopter and was its pilot on the delivery flight to Dayton.

Les was the first helicopter pilot to reach an altitude of 5000 feet at a time when helicopter altitudes rarely exceeded a couple of hundred feet.

The number of achievements that could be considered milestones in the helicopter's development is so great that it will be possible to mention only a few. Probably the most important was the first extensive use of helicopters under actual battle conditions during the Korean conflict. The role they played is described elsewhere in this book. I will only say that the helicopter fully confirmed the hopes that were held for it, and must be credited with saving the lives of thousands of our military personnel and with conducting many valuable and important services.

In 1952, two S-55 helicopters made Air Force and world history by flying the Atlantic Ocean, the first time it had been done by helicopter.

Captain Vincent H. McGovern, Lieutenant Harold Moore, Captain George Hamrick and Captain Harry Jeffers piloted the two aircraft, named Hop-a-long and Whirl-o-way, from Westover Field in Massachusetts across the northern ice cap to Prestwick, Scotland, and on again to Wiesbaden, Germany, where there was an Air Rescue Service base. The trip took fifty-two hours' flying time. Two days after arrival in Wiesbaden, the two S-55s helped rescue the crew of a bomber that had crashed in the Rhine River.

The U.S. Navy and U.S. Marine Corps worked together and separately in the development of the helicopter. HMX-1, a Marine Corps experimental squadron at Quantico, Virginia, had been training pilots and men for two and a half years before the United Nations intervened in Korea. The squadron was first established to study and practice the idea of vertical assault. The men worked out combat techniques for a new kind of aircraft and a new kind of war. Ellyson Field, near Pensacola, Florida, became the Navy's first training field for helicopter pilots in January, 1951. In the next fifteen years several thousand Navy and Marine fliers were taught the fundamentals of helicopter flight there.

Navy scientists worked with Sikorsky Aircraft in the 1940s and 1950s to develop such helicopter advances as the automatic pilot, first tested in the S-51 helicopter, and the self-contained navigational system, designed and built for installation in the S-58. In 1950, the first three-axis automatic flight-control system governing pitch, roll and yaw was used in an S-51. It proved effective, and a similar system was built for the S-55.

The Naval Air Development Center's Aeronautical Instruments Laboratory helped develop self-contained navigational systems, beginning with doppler experiments in 1952. Lessons gained in this program were used in the S-61. Other projects included the helicopter rotor attitude system, automatic engine speed control system, helicopter flight directors and programmed path flight controllers coupled to a tape line navigational system.

During the 1950s we were hard at work designing and producing larger helicopters. In 1953, the S-56, a twin-engine transport built for the Marine Corps, was flown for the first time. It was more than four times as heavy as the S-55 and

represented a great advance in the art of designing and building helicopters of considerable size. The S-56 could carry thirty-six troops. Vehicles could be driven right into the cabin through clamshell doors in the nose. Three months after the first S-56 flight, the S-58 was flown for the first time. The S-58, originally designed and produced for the U.S. Navy, proved to be one of the most successful helicopters ever created. More than 2000 were eventually produced, over 1800 at the Sikorsky plant and the balance by licensed companies. They were—and are—used all over the world.

With the availability of turbine power plants in the 1950s, further progress was possible. We produced the S-61 (SH-3A) for the U.S. Navy. For a number of years this aircraft remained the leading helicopter of its size and class. A great number of outstanding flights were made by pilots of the U.S. Navy.

On February 5, 1962, Lieutenant Robert W. Crafton of the U.S. Navy, with Captain Louis K. Keck of the U.S. Marine Corps as co-pilot, established a world helicopter record for speed when he flew an S-61 at an average rate of 210.65 miles per hour. This figure substantially exceeded the previous world record of 198.8 miles per hour. It was the first time that a helicopter traveled faster than 200 miles per hour over an established course.

In June, 1963, an Air Force S-61 (CH-3B), called the Otis Falcon, made the second transatlantic helicopter flight in history, covering 4600 miles in 35½ hours. The crew included Captain John E. Arthurs, Captain William A. Scott and Captain William B. Lehman. That same year the Air Force started to fly and use the S-61R, an S-61-type helicopter with rear cargo door. The S-61R, called the CH-3E and HH-3E, saw service in Vietnam as early as 1964. The HH-3E, built especially for the Aerospace Rescue and Recovery Service, had extra rescue equipment.

On March 6, 1965, a U.S. Navy-Sikorsky SH-3A (S-61) helicopter made the first nonstop, transcontinental, helicopter flight, setting a distance record of 2105 miles. The craft, piloted by Commander James R. Williford, with copilot Lieutenant David A. Beil, both of the Naval Air Test Center, Patuxent River, Maryland, took off from an aircraft carrier at San Diego, California, and landed on a carrier at Jacksonville, Florida. This remarkable flight began over the Pacific Ocean and ended over the Atlantic Ocean, the helicopter never touching the continental United States.

As time went on, helicopters of higher performance and greater lifting capacity were developed and produced. The latest helicopter built by our organization, for the U.S. Marine Corps, is the S-65 (CH-53A). This aircraft made its first flight in 1965. It exceeded speeds of 200 miles an hour early in its testing program. It carried a 13,000-pound truck externally at 115 miles per hour for over one hour. It carried thirty-eight combat-equipped troops over 230 miles at speeds up to 196 miles per hour. It flew 232 miles per hour at its normal gross weight of 35,000 pounds. It flew at a gross weight of 42,000 pounds with a 20,000-pound useful load. It carried an 11,200-pound CH-46A helicopter externally at a speed of 115 miles per hour.

The helicopter is still a young aircraft. Its development continues and, at present, there appears to be no limit to further improvement and increased lifting capacity.

Besides other qualities, a good helicopter must possess two characteristics that greatly contribute to its usefulness and universality.

One is to have such flight and control characteristics as to permit the use of a hoist with a cable and sling or rescue basket or, in larger aircraft, any type of van that can carry passengers or cargo. Such arrangements make it possible to deposit or pick up passengers or materials to and from any spot where even a helicopter cannot land. Besides countless services made possible by this arrangement, thousands of lives were saved in emergencies because it was possible to pick up victims from trees and rooftops, small boats and other places and, when necessary, hoist them into the cabin of the helicopter.

The second feature is the ability of a good helicopter to make, whenever necessary, a so-called partial landing. This is a maneuver where the pilot gently places the wheels, or sometimes only one wheel, of the helicopter on the ground, or on the slope of a hill, a rooftop or any other place where even the helicopter is not able to land, and, thus, makes it possible for the passengers to either enter or leave the aircraft.

This feature allows for other landing opportunities. There are a number of places, such as flat rooftops, which are large enough and appear to be good landing spots but which are not strong enough to bear the full weight of a helicopter. In this case the pilot can make a partial landing by gently placing a small portion of the weight on the wheels and supporting the bulk of the weight through the rotor blades. This maneuver has been practiced in many cases. One particular example, which will be described in more detail later, was the rescue operation at the Brussels Air Terminal fire.

Very valuable characteristics can be expected from an amphibian helicopter. Aircraft of this type have already been produced, and further progress along this line can be expected in the future. The amphibian helicopter may be considered the most universal vehicle ever devised by man. The truth of this somewhat extravagant statement is evident. Steamships and boats are limited to adequate waterways; trains can travel only over rails, automobiles only over roads, and even tanks and tractors are limited by swamps, deep snow, steep hills, rivers, seas, forests, and so on. Airplanes obviously can fly freely through the air in any direction, but they are helpless and useless without adequate airports for takeoffs and landings. Only the helicopter is independent, requiring but a little free space on the ground or a platform where it can swing its rotors. The amphibian helicopter, in addition to its ability to land on the ground, also can land on water, deep snow or swamp. It can even land with complete safety on thin ice because, if the ice should break, the machine will remain afloat and the pilot can start it up again, hop off and seek another landing spot.

Concluding this review, I can only reaffirm my belief that the classic helicopter is here to stay; further development of direct-lift aircraft will continue. I am

convinced that the helicopter will remain an immensely valuable means of travel with a limitless variety of applications. Furthermore, in a vast number of situations it will remain by far the best and often the only friend in emergencies.

Document 5-42

**Excerpt from Arthur Young, *The Bell Notes:
A Journey from Metaphysics to Physics*
(Mill Valley, CA: Roberts Briggs Associates, 1979), pp. 9–22.**

Although his name is not nearly as well known, American engineer Arthur Young ranks with Heinrich Focke, Igor Sikorsky, and Anton Flettner as one of the individuals most responsible for the design of what became the modern helicopter. Moreover, Liberatore ranks Young as Sikorsky's equal. This stature is based on his original contributions to the problem of helicopter *stability*, especially while hovering. Most other helicopter pioneers had concentrated on rotor *lifting power*, not rotor stability. Not Young—he worked to devise the first truly effective rotor-stabilization system, one based on a gimbal mounting that allowed the rotor to teeter. Another essential feature of his system involved his concept of rotor control “feedback” that permitted control of the rotor “following-rate” that was independent of the behavior of the rest of the helicopter. Young achieved this first by putting a gyroscopic mass above his teetering rotor; in its final form, he did so via a gyroscopic flybar. In Liberatore's view, “the Young design” as it materialized by 1941 represented “a complete departure” not just from all the many rigid-rotor concepts that preceded it, but also from blade-articulation concepts that had been tried on various autogiros.

The different components of Young's rotor-stabilization system evolved over the course of several years, starting with scale-model work he began in a Philadelphia area shop in 1928. By the early 1930s, one of his remote-control models already incorporated a teetering rotor with a gyroscope mounted above it. But it took several more years, until 1941, before he built a full-scale tail-rotor prototype. By this time, he was working for Bell Aircraft Company, and Bell classified his prototype “Model 47.” It was the first in a series of very successful helicopters that Young designed for what became Bell Helicopter (later a division of Textron), for which he served as head of engineering.

What follows is the introduction from his autobiographical *The Bell Notes: A Journey from Metaphysics to Physics* (1979). This is an exceptional book in that it offers a philosophy of life based on a better synergy between the material world and human consciousness. For our narrower documentary purposes, we are most interested in what he remembered about the technological process going into his early design of the tail-rotor helicopter.

*Document 5-42, Excerpt from Arthur Young, The Bell Notes:
A Journey from Metaphysics to Physics
(Mill Valley, CA: Roberts Briggs Associates, 1979), pp. 9–22.*

On the evening of September 3, 1941, I went to the Bell Aircraft Company in Buffalo. In a suitcase I carried a remote control model helicopter, the fruit of almost twelve years of research on the problem of vertical flight.

My interest in the helicopter started in 1928. I had gone to Washington to the Patent Office to evaluate various ideas I'd had for inventions. If I could find some practical problem to work on for the next ten to fifteen years, I could return to my study of philosophy and the theory of process later with a better grasp of how things work. (This other search is described in my book *The Reflexive Universe*.) The idea that did impress me was not suggested by the Patent Office. It was in a small book by Anton Flettner, the inventor of the boat propelled by rotating cylinders which had crossed the Atlantic in 1927.

Flettner showed a picture of a huge windmill with small propellers, themselves windmills, at the tips. The wind turns the big windmill which in turn makes the small propellers rotate at high speed, requiring smaller gears to pick up the power.

When I went to bed that night I saw Flettner's idea applied to a helicopter. A large rotor propelled by small propellers at the blade tips would not only not require heavy gearing but it would solve the "torque problem," *i.e.*, how to counteract the twist resulting from turning the large rotor.

As I was to learn in the years following, on my periodic trips to libraries in Washington, Detroit, and other cities, there had been many attempts to build helicopters since the early 1900s. Leonardo had of course made sketches, but he had not shown any way of correcting the torque. Furthermore, not until the coming of the automobile with its internal combustion engine was it possible to obtain engines sufficiently powerful and light enough even to approach the requirements of vertical flight.

Indeed, the smaller power requirements of the airplane were largely responsible for the fact that the airplane succeeded first. Certainly there were many more attempts to make helicopters than airplanes in those early days.

Among others, D'Ascanio and Isacco in Italy, Pescara in Spain, Karman and Petroczy in Austria, Berliner and Cooper Hewitt in the U.S., and Oe[h]michen and Breguet in France, made helicopters. Both Oe[h]michen and Breguet succeeded on actual flights over a kilometer closed circuit, but at speeds of the order of 6 miles per hour. Not until 1937, some nine years after I started, did Focke, a German airplane designer, succeed in building a helicopter which obtained an average speed of sixty-eight miles per hour. And it was soon after this (as far as I know) that Sikorsky, who had first attempted a helicopter in 1909, and then become the successful designer of large airplanes, returned to the helicopter and achieved in

1938 the first truly successful experimental flights in the U.S. By May of 1942 a larger Sikorsky machine, the famous XR4, flew to Dayton, Ohio, for delivery to the Air Force.

But in 1928, despite advances in engine design, there were still no successful helicopters. In fact, there was no agreement as to design. Some used coaxial rotors (two rotors turning in opposite directions on the same shaft). Some used side by side rotors; some had four lifting rotors. Oehmichen made over 1,000 flights in a machine with four lifting rotors and nine auxiliary propellers. There was even one design in the form of a maple seed. And, as I later learned, Isacco had a large single rotor turned by propellers and engines on the ends of the blades.

In any case, in 1928 the helicopter was an interesting challenge and I was intrigued by the possibility suggested by Flettner's design for a large windmill, of a single rotor with propellers at the tips.

I went back to Radnor, Pennsylvania, with the determination to try this idea. At a toy store I found rubber bands, carved wooden propellers, light balsa wood strips, Japanese silk, and dope (lacquer) and soon had made a model helicopter, about six feet in diameter.

It flew nicely but with short duration, indicating that a helicopter would require more power than an airplane.

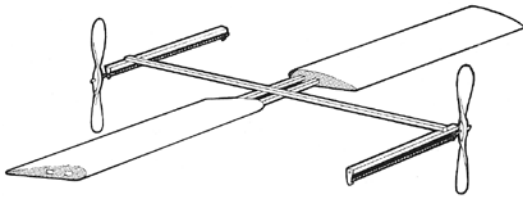

First model.

For the next nine years I struggled with this design. During the first phase of the work I developed the use of models powered by electric motors (the model technique became important later). During this period the most significant development was a whirling arm with which I

could make accurate tests of propeller efficiency. I also built equipment to measure the lift and horsepower of the electric model and discovered the formulas to predict lift and horsepower for full scale.

I next undertook a larger machine. Since I had neither facilities nor finances for a full-scale model, I decided on an intermediate 20-horsepower machine, which I purposely made small in order to achieve high power density. Because this would increase the stresses to values even greater than with full scale, and do so within a small compass, it would be an ideal test vehicle. I anticipated that I would use remote control to fly it.

The stresses were even larger than I anticipated. On its first test the propeller blades broke off. The stress induced by rotating the small propellers at 4,000 rpm and at the same time having to reverse the direction of their rotation as the big rotor turned 400 times per minute was too much.

I built stronger blades. The second time the whole shaft broke off and the machine destroyed itself.

A third time I rebuilt everything using forged magnesium alloy blades and nickel vanadium steel shafts designed for maximum strength. It held up. Next came the overspeed test with lift wing blades at flat pitch (no lift). This time it blew up with a vengeance.

These explorations, in which I never even got to the question of flight, were very time-consuming but provided valuable experience, both in calculating stress and redesigning and building parts. It was now 1938 and I had bought an old farm in Paoli. I rebuilt the barn into a shop and test area for model flights. I was beginning to think I should turn to a simpler configuration when I attended the first of the Rotating Wing Aircraft meetings, organized by Burke Wilford. There I saw Sikorsky's film and was impressed with his argument for correcting the torque by means of a tail rotor.

I also heard a paper by Platt, in which he argued that a rotor with blades hinged to the mast would be stable in flight because the body could swing without tilting the rotor. This was the argument given in *Le Vol Vertical*, a French text on helicopters, but it was not until I heard it from Platt that I questioned it. Would the hinged rotor not follow the inclined mast? And was it stable in flight?

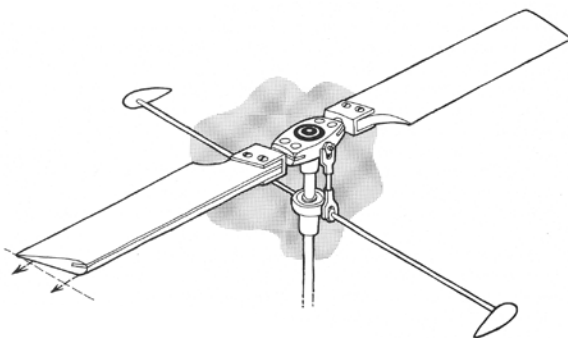

Stable rotor configuration.

I went back to my shop and built a small electric model to test a hinged rotor. Tipping the mast with the rotor turning, I could see the rotor immediately “follow” the mast so that, despite the articulation, the rotor remained perpendicular to the mast. In flight it was definitely unstable, tipping as it took off and dashing in the direction of the tip, only to

swing back and reverse direction. After several swings of increasing amplitude, it would upset.

The problem of obtaining a rotor system that would provide stable flight now took my attention. Since the hinged rotor, first proposed by Breguet in 1907, was used by many pioneers, including the Frenchman Oe[h]michen whose work I especially admired, was it not possible that its unstable flight was responsible for their lack of success? (Oe[h]michen had ended by attaching a balloon to his helicopter, not for lift but for stability.) Was it not likely that some of the wrecks which terminated helicopter flights in the past were due to this factor?

I could now put my mechanical skills to work. My long apprenticeship had taught me the virtue of simplicity, and returning to small models I could give my attention to principles and especially to stability. I could concentrate on flight. If the model were wrecked, I could rebuild it in a day or so and carry on. In this way I was able to speed up the process of trial and error, to make mistakes and learn from them, with a minimum of time invested. So after a half dozen different rotor configurations, I hit upon the device of using a stabilizer bar linked directly to the rotor. In this way the rotor plane was controlled independently of the mast, which was attached to the rotor hub by a universal joint.

This configuration had superb stability. It could hover indefinitely without moving. It was no problem now to add remote control. With the remote control I could fly it around a prescribed course in the interior of the old barn, or even fly it out the barn door and back.

It was the description of this model given by a friend to engineers at Bell Aircraft Company that resulted in my being invited to come there and give a demonstration.

Which brings me to September 1941. At the gate of the Bell Aircraft Company the guard checked with the engineer who had invited me and I was permitted to enter. I was escorted to the factory where I unpacked the model and flew it in the rather cramped space between the Airacobra pursuit planes which filled most of the space in the factory.

By this time a number of engineers were gathered. We adjourned to the projection room where I showed my film "Principles of Stability" which, starting with an unstable model, demonstrated the flight of different types of rotors I'd used, ending with the remote control model I'd just flown in the plant.

Bell's patent attorney then informed me that Bell would like to make an arrangement. I was introduced to Larry Bell himself, whom I liked from the first. In November of that year we signed a contract, I to assign my helicopter patents to Bell and Bell to build two helicopters. (I insisted on two in case the first was wrecked.) I asked if my assistant, Bart Kelley, could come too and was told yes, if he could work for \$36 a week, a small sum even in those days.

Bart Kelley, whom I'd known since boyhood, had worked with me on models back in the summer of 1931. He had then disappeared, to return again one summer night in 1941, just at a time when I could use his help. He remained during the rest of the summer, assisting me and teaching himself how helicopters were made. When I told him Bell's offer, he accepted. (Bart worked with me and remained after I left, becoming Vice President in charge of engineering. He is now officially retired but still plays an active part in the company.)

Now that I'd joined Bell I assumed that the organization would take over my responsibilities and build the two helicopters, but, as I gradually came to be aware, nothing happened and nothing would happen. The company, already seething with wartime activity, working three shifts and expanding all the time, hardly seemed to know of my existence, much less how to build helicopters. But I did not realize

the extent of my predicament until after about two months of waiting around. An engineer who had been assigned to me showed me the budget he was working on—\$250,000. I thought fair enough, but to my consternation I found it was not to build two helicopters, as the contract had specified, but to *draw* the helicopters.

This was the normal procedure for airplanes, which required elaborate drawings to make the precisely curved metal panels of which body and wings consisted. It would hardly do for the complex mechanism of the helicopter, involving all kinds of hitherto untried mechanisms. I wanted to build the helicopters first with working drawings only and get them to fly. Then, when we knew the requirements, we could make the drawings for the production prototype.

This woke me up to the fact that I'd have to act myself. I went to Russ Creighton, head of production at the factory, and explained my predicament. He spoke my language and understood. He agreed to sign a budget which provided for *building* two helicopters for \$250,000. Then he added a provision: "provided only that the engineering [drafting] department had nothing to do with it."

But even with the budget question set to right, the problem remained. How to get something built? In my former life at Paoli, I could plan a model, go over to the barn, build it and fly it, but I never even thought about full scale. How to begin? I went over to my temporary shop in the factory, mocked up an engine and, twenty feet away, a tail rotor. How would I ever fill the space between with actual machinery that would lift 2,000 pounds into the air? The problem seemed insurmountable. There was nothing to do but make everything six times model size. Drawings would be straightforward but making the parts would require machinery and machinists. Assembly and flight would require space. We would have to have a plant of our own. Further, the project, small as it now was, was already split into office, model shop, and drafting room, each in a different location. It would be far better to get the project all in one place for better coordination. Then with a machine shop and space to build and fly helicopters, we would be in business.

I issued a memorandum stating the need for a plant of our own. When this brought no result I engaged a real estate company in Buffalo to look for a suitable place.

Things were now beginning to take shape. With the help of my shop in the factory, I was able to build a final model involving a control system that would be suited to pilot operation. (The remote control model system did not lend itself to pilot operation.) The all-important gears were being made. But still something was holding us back; funds were not released. At last I learned why. L. Bell wanted to see a model demonstration of safe descent in case of engine failure.

This was difficult in the space available. So I arranged a vertical wire and had the model climb up it some thirty feet to the ceiling, then cut the power and let it descend in auto-rotation. When it was ready, I went to the restaurant where Larry had lunch and told him it would be ready when he returned. I obtained two raw eggs from the chef. Back at the shop I placed one egg on the model and put it

through the test. Unfortunately, the model climbed too fast and the egg bounced off when it hit the ceiling. Then Larry came. I was more careful this time. The model climbed to the ceiling; I cut the power; it descended without breaking the egg. Larry was delighted.

After that funds were released and the property we had found most suitable was leased. This was a garage on the outskirts of Buffalo, with open space behind it, a former Chrysler Agency. The maintenance department got to work, surrounded it with a board fence painted Navy gray, floodlights, and an armed guard. I commented that this strategy only called attention to it, so the floodlights were removed and the guard reduced to a single night watchman.

On June 23, 1942, we moved to the new location. Gardenville, as it came to be called, was ideal for our purpose. Behind the building proper was a good-size yard where we would do the preliminary testing—beyond that an open meadow, suitable for short flights. The building itself was divided into four parts: 1. an office space with desks for myself and my “brain trust” (B. Kelley, Tom Harriman, and Charlie Seibel; the secretary, Mary McCann; and later, the pilot, Floyd Carlson); 2. the machine shop and assembly area, which occupied more than half the total space; 3. the wood shop for making blades; 4. the drafting room where drawings were made, later referred to as the paper shop. What had been a display room for Chryslers was set aside as a model shop.

The helicopter project was now augmented by flight mechanics, body men, a welder, and two patternmakers (for the wood shop) plus Tom Darner, the youth whom I’d taught to make blades before I came to Bell. We were also fortunate in the addition of three of the best toolmakers from the Bell factory, who had somehow got wind of the operation and applied for transfer. The paper shop now included five men.

We could now get to work in earnest and Model 30, our first helicopter, was underway. Draftsmen made drawings; machinists made masts, rotor hub, and control system; patternmakers made wooden blades (actually a composite of steel-impregnated fir and balsa). The body men and the welder made the fuselage and landing gear. The riveted magnesium tail boom was made in the main plant to drawings.

About six months after we came to Gardenville we had a helicopter ready to be wheeled out, with long legs of 3-inch dural tubing, a 32-foot rotor, and a 160 horsepower Franklin air-cooled engine. (All dimensions were six times those of the model.)

But Model 30, its Bell number, or Genevieve, as it was christened when we first took it out December 1942, was a bit cumbersome. To get it out the door, the legs had to be removed, then it was wheeled out on a dolly, and pushed up a ramp so that the legs could be replaced. By this time everyone was frozen stiff, as was the engine, which had the additional handicap of having to push the huge rotor, for at this stage we had no clutch. A storage battery for starting was wheeled out on an

express wagon, but the starter was unequal to the task. My solution was simple: use two batteries (24 volts). This did the trick, and I actually believe caused less strain on the motor because it turned over fast and didn't draw as much current.

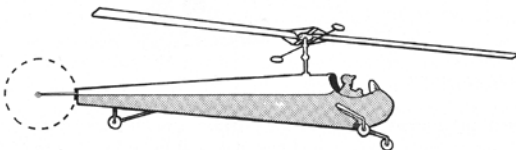

Model 30 Ship 1.

We now began to encounter the problems of helicopters, problems that are not apparent until flights are attempted, and which had caused the demise of many pioneers before us. (I later learned that by 1943 there had been 343 helicopter companies that had failed.)

To appreciate these problems, which cost us several crack-ups with the necessity of rebuilding and making design changes, it would be necessary to go into a lot of technical detail which would only tax the patience of the lay reader. Suffice it to say, thanks to the flexibility of the Gardenville group, which could work in a coordinated way with a minimum of red tape, we were able to take these problems in our stride, so that by July 1943 we had Ship 1 flying well up to speeds in excess of 70 miles per hour. Then, due to an unsuitable landing gear, this ship was damaged on a power-off landing.

Meanwhile Ship 2, a streamlined two-passenger version, became our test vehicle. The first ship was rebuilt with a raised tail rotor and landing gear modified to permit the machine to remain in the tipped-back position for the touchdown in power-off landings.

Then came the problem of engine wear, which plagued our early efforts. The cause of this was traced to gear wear, which was in turn corrected.

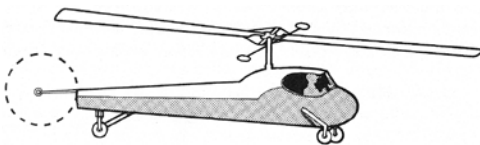

Model 30 Ship 2.

Since I was not a pilot, and had never even flown an airplane, much less a helicopter, my first hops were brief and erratic, six inches or a foot at most. I did not fly it long. We were assigned a regular pilot, Floyd Carlson, who is still with the company.

Next, we started giving rides to visitors and the helicopter was tried out on rescue missions. Larry Bell had his ride. The time had come for the helicopter to make its debut. It was given a two-page spread in the Sunday paper, with the consequence that the traffic on the road behind our shop, which before had paid no attention to our test flights, was now blocked with spectators.

Then came a flight indoors in the Buffalo Armory. The pilot, despite the glare of searchlights, maneuvered the ship slowly around under perfect control, ending by bringing the front wheel into my extended hand.

Later, on July 4, 1944, Ship 1 was flying again and gave a demonstration to a crowd of 5,000 in the Buffalo Stadium.

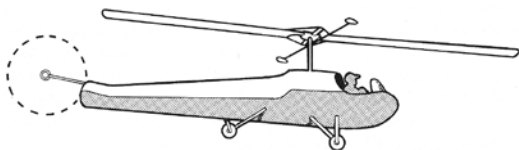

Model 30 Ship 1A.

At about this time Larry Bell, foreseeing the time when pursuit airplanes could no longer be sold, sent a contingent of engineers from the main engineering department to Gardenville to learn about helicopters. The plan was to design

a large ship, Model 42, which, according to a market survey, would better meet demand. (It was anticipated that helicopters would be used to carry passengers to airports.)

Here began the problem that was later to become important, and which is the main theme of the "Bell Notes," a difference of philosophy. At Gardenville, we built things, tested them, modified them until they worked, and *then* made the drawings. [In contrast, t]he main engineering group made drawings, sent them to the plant, and only the project engineer ever saw the product fly. This was successful with airplanes because the airplane did not involve unknowns; these had been ironed out in the forty years of development since the Wright Brothers. In retrospect, I can only suppose that Larry, who did indeed appreciate the problems and the Gardenville way of dealing with them, still felt that, with the basics having been established, the main engineering department could do the job better. Besides, he had to think of what was in the best interests of the company, which, with its thousands of employees, would be out of work when the war ended.

Meanwhile, we, the Gardenville group, were still not satisfied with Ships 1 and 2. In early 1945 we started on Ship 3, which was to incorporate the best we had found in our experience so far. A four-wheeled landing gear was designed which provided a better behaved takeoff. A different body shape, with instrument panel in the middle and almost no floor, gave unobstructed vertical vision. And later a bubble canopy, blown from heated Plexiglas like a soap bubble, gave undistorted vision.

This ship, launched on April 20, 1945, was an immediate success. With room for two passengers, no body or windshield, only a small instrument column between passenger and pilot, one had an unobstructed view up and down. It was like sitting in a chair and flying about through space. Vice President Truman had witnessed flights a few weeks before we started giving rides. I recall his smile as we stood together waiting for it to take off. Now we were giving rides to whoever came by—Governor Dewey, Mayor LaGuardia. (I recall the somewhat ludicrous sight of the latter, already short, stooping as he ran out under the rotor.) Hundreds at the plant also had rides, and it improved morale, not only for our own group but for others who might have been depressed by the demise of the pursuit airplane.

Then came the great blow. Since we were now successful, we were to be transported back to the main plant. This had now been moved to Niagara Falls, the

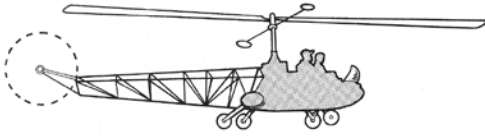

Model 30 Ship 3.

Wheatfield Plant, built and owned by the government and on the edge of a commodious airport.

We were moved, machinery and all, June 24th, exactly three years after we had moved to Gardenville.

We were installed in a hangar: office, paper shop, machine shop, wood shop, and model shop, partitioned off as before with plywood walls.

The most critical time had come; the drawings for Model 47, the production prototype, had to be made. The drafting department sent us more men, but they were not their best and made so many mistakes I recall saying to Bart it would be better to buy the drawings from Sears Roebuck and fill in the dimensions ourselves. And I really exerted myself to get everything just right. Mast, hub, blade grips, bar control system, transmission with ground gears, all were done over to incorporate our experience and the opportunity to use forgings and take advantage of mass production.

What made it more difficult was that at this time Bart was sent to Germany to learn what they had to offer in helicopters.

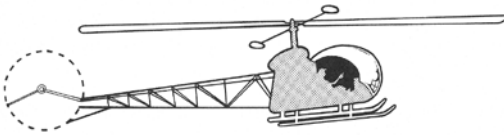

Model 47.

But luck was with us and on December 8, 1945, less than six months after we came to Wheatfield, the first Model 47 was rolled out, complete with bubble canopy. It was the first Bell ship, I was told, to be completed on schedule. We had even better lift than

anticipated, which made for a very good performance, even with two passengers. I have a photo of Model 47 hovering with seven people hanging on to it.

This ship was one of ten made from production parts but assembled by our own crew as a transition to the full production ship, which was to come off the assembly line. This ultimately turned out to be a fiasco; it took twice as long to assemble it with an assembly line.

This brings me to the time when I began what I call the "Bell Notes."

It had been my custom since I started on the helicopter to keep a journal in which I sketched my ideas and noted results and dates. This was important not only for patents, but also, by encouraging a sort of inner debate, for providing a stimulus to new ideas. When the helicopter was ready for production, changes and inventions had to cease and the momentum of my inner discourse took a different direction. My writing became introspective and philosophical.

These notes were not so much about the helicopter as they were an emotional outlet for my frustrations during the transition, as the main plant took over the job

of building helicopters. They were also notes on the “psychopter,” which I began to realize was my true interest.

For two reasons the notes should not be taken as a criticism of Bell. In the first place, they present only my side of the story. In the second place, Bell Aircraft did undergo a transformation. Eventually the seed of Gardenville did create a new entity—Bell Helicopter Company, now located in Texas.

It is important to mention that just prior to the launching of Model 47, shaken by the atom bomb (1945), anticipating that my task would be ended in about a year, and knowing that my contract required a year’s notice before terminating, I’d written a letter to Larry to this effect. I recall writing the letter several times, ultimately making it short and perhaps too abrupt. This was disastrous; Larry interpreted it as my quitting under fire, whereas I thought my job was successfully accomplished so that I could step out.

As things worked out I stayed at Bell for two more years, getting the bugs out of production and, later, getting Model 42 past its problems. But the main difficulty was with people. It was hard for the company hierarchy to learn new tricks and three Vice Presidents were successively fired before Bart Kelley was eventually put in charge of engineering.

Throughout, the Gardenville group remained dedicated and continued to keep in touch, even when we had to work underground because individuals in management tried to break up the group. It was the loyalty and dedication of the Gardenville group and their successors, not the helicopter itself, that I think of as the main accomplishment, for it is not making a helicopter that counts, it is the process by which it is made, and this resides in people.

Document 5-43 (a-m)

Excerpts from *Annual Report of the National Advisory Committee for Aeronautics* (Washington, DC), 1946–58.

- (a) “Helicopters,” *Annual Report* (1946), pp. 13–14.
- (b) “Subcommittee of Helicopters,” *Annual Report* (1947), pp. 22–23.
- (c) “Subcommittee on Helicopters,” *Annual Report* (1948), p. 21.
- (d) “Subcommittee on Helicopters,” *Annual Report* (1949), pp. 24–25.
- (e) “Subcommittee on Helicopters,” *Annual Report* (1950), pp. 27–29.
- (f) “Rotary Wing Aircraft,” *Annual Report* (1951), pp. 16–17.
- (g) “Rotary Wing Aircraft,” *Annual Report* (1952), pp. 26–28.
- (h) “Helicopters,” *Annual Report* (1953), pp. 17–18.
- (i) “Helicopters,” *Annual Report* (1954), pp. 26–27.
- (j) “Helicopters,” *Annual Report* (1955), pp. 21–23.
- (k) “Helicopters,” *Annual Report* (1956), pp. 36–37.
- (l) “Rotary Wing Aircraft,” *Annual Report* (1957), pp. 25–26.
- (m) “Rotary Wing Aircraft,” *Annual Report* (1958), pp. 44–45.

The NACA’s Subcommittee on Helicopters actually dated back to a “Subcommittee on Helicopter (or Direct-Lift) Aircraft,” formed in 1917; its original chairman was the esteemed Dr. William F. Durand himself, of Stanford University, who chaired the overall NACA at the time. Then, for the following 23 years, no such committee existed, until 1940, when the NACA Aerodynamics Committee created a “Subcommittee on Rotating-Wing Aircraft.” Its only chair was John Easton, who served until the committee was disbanded at the end of 1942. Actually, Easton’s committee evolved in 1943 into the “Subcommittee on Helicopters,” a change in

name that signified the helicopter's arrival as the most important form of rotary-wing aircraft. This committee lived on until the end of the NACA in 1958. Four different men chaired the body: Grover C. Loening (1943–48); Richard H. Prewitt (1949–51), Bartram Kelley (1952–55), and Lee L. Douglas (1956–58).

Grover Loening (chair, 1943–48) seems an unusual choice for chair, as he had had little to do with rotary-wing up to this time; in fact, Loening was one of the many Doubting Thomases when it came to the potential of helicopters. In 1943 (the first year he chaired this subcommittee), he published an article in *Air Transportation* with the title “Don't Believe All You See and Hear About Helicopters.” Richard Prewitt (chair, 1949–51), on the other hand, had excellent credentials for the post. In the 1930s, he had designed the first practical adhesively bonded metal rotor blade. He went on to design the Kellett YO-60 autogiro for the U.S. Army in the early 1940s. The YO-60 never made it past the service test phase, but Prewitt became Kellett's chief engineer as it became more involved in helicopters. He also introduced the concept of “figure of merit,” a mathematical formula with engineering units for determining the hover efficiency of a rotor and checking the realism of a design approach or of a test measurement. After the war, Prewitt founded a successful company of his own that built innovative rotary-wing systems, the Prewitt Aircraft Company of Wallingford, Pennsylvania.

Lee Douglas (chair, 1956–58) also had very good credentials, having worked with the Piasecki Aircraft Corporation during its development of the tandem rotor helicopter right after the war. Douglas went on to work for Boeing after it acquired the Piasecki company in 1955. In the 1950s, he published a number of papers on the development problems of large helicopters.

Of the four, however, Bartram Kelley (chair, 1952–55) became the most distinguished. Working with Arthur Young under the auspices of Bell Aircraft during the war, Kelley helped Young develop a practical teetering rotor system, a trademark feature of Bell helicopters from that time on. In fact, Kelley would come to stand at the forefront of virtually every new design that came out of Bell Helicopters for the next 35 years. Not only was he instrumental in the development of the Army version of the Model 47, known as the H-13 Sioux, Kelley also supervised the design, testing, and development of the UH-1 Iroquois, AH-1G Cobra, and OH-58 Kiowa. One of his greatest strengths was that he himself piloted helicopters and thus understood intuitively what pilots wanted in terms of flyability. As director of engineering and senior vice president of engineering for Bell in the 1960s, Kelley became the moving force behind the Model 209 Huey Cobra attack helicopter. The Army and the Marines deployed this aircraft, designated AH-1, as their main gunship helicopter in the Vietnam War. Even today, the Cobra is used (in successive dash numbers) by the two services, as well as by several allied foreign countries, and it remains the defining configuration for attack helicopters worldwide. Kelley also presided over the design of Bell's first “tilt-rotor” aircraft, the first of which flew experimentally in the late 1950s. In his last year serving as chair of the NACA's

Subcommittee on Helicopters, Kelley won the American Helicopter Society's Alexander Klemin Award for outstanding "engineering, design, and invention in the field of rotary-wing aircraft." He did not retire from Bell until 1975.

The following annual summaries of the work of the Subcommittee on Helicopters that these four men chaired from 1946 to 1958 give a good indication of the range and depth of NACA research investigations into helicopters and other matters related to the development of rotary-wing aircraft.

Document 5-43 (a), Excerpts from Annual Report of the National Advisory Committee for Aeronautics (Washington, DC), 1946-58, "Helicopters," Annual Report (1946), pp. 13-14.

The war years have seen the development of the helicopter from a purely experimental aircraft to a machine having performance and handling characteristics which make it valuable for specialized military and commercial purposes. While considerable effort was spent in evaluating and improving existing designs for the armed forces, the Committee also was able to aid in the fundamental development of the helicopter by experimentally and analytically investigating the problems which vitally affected the craft in its early stages of development, and to lay a foundation for future helicopter research.

One of the most significant contributions made by the NACA to the science of rotary-wing aircraft is a refined yet easily applied general rotor theory. The method of analysis developed in this connection was used in preparing a much needed series of design charts summarizing the effect of changes in the major variables on the characteristics of a helicopter design. Flight and wind tunnel experimentation, as well as analytical studies, disclosed the nature of some modifications of rotor blade size and configuration, driving gear ratio, and engine supercharging, which made possible substantial increases in the general performance of machines of the type investigated.

Studies were also made of the effect of blade twist, plan form, rotor tip solidity, and type of airfoil section, by analyses which indicated the manner in which additional gains in efficiency could be affected by proper design. The full-scale experimental data obtained also were used in checking and extending existing rotor theory. In view of the specialized flow conditions encountered in the rotor, a series of airfoil sections designed particularly for use on helicopters was developed.

Considerable attention was also devoted to the vibration problems which are peculiar to the helicopter. One of the most dangerous of these problems which was investigated and solved was the phenomenon known as "ground resonance," which, prior to NACA studies, was responsible for the destruction of several rotary-wing aircraft. The problem of rotor blade flutter has also been investigated and a theory established in this connection.

Document 5-43 (b), Excerpts from Annual Report of the National Advisory Committee for Aeronautics (Washington, DC), 1946-58, "Subcommittee of Helicopters," Annual Report (1947), pp. 22-23.

The experimental and analytical investigations of the fundamental factors that affect the performance, flying qualities, and reliability of helicopters have been continued during the past year. The object of this work was to provide and interpret the fundamental information required for proper guidance of helicopter development so that the unique potentialities of rotary-wing aircraft might be fully realized in rescue, commercial, and military applications.

FLIGHT INVESTIGATIONS

The effect of rotor-blade stalling on the power absorbed by a rotor was determined in flight and the results of the investigation published in Technical Note 1250. The flight measurements checked the calculations made by the weighting curve method in that it was found that stalling materially reduces rotor efficiency before the operating limitations due to vibration and loss of control were reached. It was also found that calculation of the operating conditions corresponding to an angle of attack of the retreating blade tip of approximately 12° is a useful approach in determining the conditions for optimum performance of current rotors, as well as in limiting the applicability of theoretical treatments that omit allowances for stalling losses.

Safety and design considerations make the autorotative condition important to the helicopter designer inasmuch as the helicopter rotor becomes, in effect, an autogiro rotor in the event of power failure. Flight tests were therefore conducted on a helicopter in the autorotative condition and the results published in Technical Note 1267. It was found that good agreement between theoretical and experimental autorotative performance was obtained and that the same theory could satisfactorily predict the performance of a rotor in both the power-off and power-on flight conditions. The theory could thus be used in extending the available rotor data from one condition to another. It was shown that significant improvements in gliding performance appear possible with improved blade contour and surface condition.

Basic data on helicopter rotor-blade motion were obtained by photographic observations of the behavior of a rotor blade in flight. The measurements were analyzed by means of existing theory and the results published in Technical Note 1266. Values of measured flapping, feathering, and in-plane motion were compared with theoretical calculations, and agreement was found good enough to render the theory useful in such problems as the estimation of control displacement for trim, the determination of the static stability of the rotor, and in designing the stop settings and bearing positions of the rotor hub. A basis for design of a simple service torquemeter, consisting of a mechanical device for measuring the mean blade-drag

angle, was suggested by the test results, in that the mean drag angle was found to be a simple function of the rotor torque and revolutions per minute over a wide range of conditions. Data on blade twisting and distortions imposed by aerodynamic and inertia forces in flight, which are essential to studies of blade stresses and rotor vibration, were also obtained.

WIND-TUNNEL INVESTIGATIONS

As part of a general helicopter research program intended to provide designers with fundamental rotor information, the forward-flight performance characteristics of a typical single-rotor helicopter have been investigated in the Langley full-scale tunnel. The data, which are given in Technical Note 1289, are presented in a series of charts which facilitate the rapid estimation of the forward-flight performance of helicopter rotors having physical characteristics similar to the rotor tested. The results indicate that large savings in the power required for flight would result from the use of smooth rotor blades and that additional smaller savings in power would result from operation at lower rotational speeds.

Blade motions of the PV-2 helicopter rotor have been studied in the Langley full-scale tunnel. The flapping and feathering motions of the rotor blades were subjected to harmonic analysis and the Fourier coefficients have been summarized in a convenient set of charts from which the motions for such a rotor may be readily obtained for a range of flight conditions. The theory in common use was found to predict accurately the coning angle and the longitudinal component of the equivalent flapping; fair agreement for the lateral component of the equivalent flapping, however, requires that the theory take into account the fact that the inflow across the rotor disk increases from front to rear.

ANALYTICAL STUDIES

An extension of previous work on the theory of self-excited mechanical oscillations of hinged rotor blades has been published. Previously published papers cover the cases of three or more rotor blades on elastic supports (such as landing gear) having equal or unequal support stiffness in different directions and the case of one or two blade rotors on supports having equal stiffness in all horizontal directions. The missing case of one or two blades on unequal supports has now been treated in Technical Note 1184. This report completes the combinations of support elasticity and number of blades which the ground-vibration studies have been planned to cover. The results show the existence of ranges of rotational speed at which instability occurs (changed somewhat in position and extent) similar to those possessed by the two-blade rotor on equal supports. In addition, the existence of an infinite number of instability ranges which occurred at low rotor speeds and which did not occur in the cases previously treated is shown.

A theory has been developed in preliminary form and reported in Wartime Report L-692 which seems capable of predicting the aerodynamic instability phenomena of a two-blade "see-saw-type" helicopter rotor. In particular, the theory indicates the possibility of unstable vibrations even with the chordwise center of mass at or ahead of the 25-percent-chord position. The stability condition for oscillatory motion is expressed in terms of a small number of composite parameters that are evaluated from the moments of inertia, angle settings, and aerodynamic parameters of a blade. Computed stability results for different coning angle settings, center-of-mass positions, and control-system stiffnesses for one value of blade density and aspect ratio are presented in a chart. It is found that, in addition to parameters analogous to those occurring in wing-flutter theory, the present theory requires the use of a parameter that represents an unstabilizing effect due to the difference between the moments of inertia in flapping and in rotation.

In order to facilitate solutions of the general problem of helicopter selection, the aerodynamic performance of rotors is presented in Technical Note 1192 in the form of charts showing relations between primary design and performance variables. By the use of conventional helicopter theory, certain variables are plotted and other variables are considered fixed. Charts constructed in such a manner show typical results, trends, and limits of helicopter performance. Performance conditions considered include hovering, horizontal flight, climb, and ceiling. Special problems discussed include vertical climb and the use of rotor-speed-reduction gears for hovering.

A tentative list of standard symbols for helicopters was prepared in answer to the interest in standardization shown by the armed services and the rotary-wing industry. The symbols listed were limited to those most generally used in helicopter aerodynamics studies, inasmuch as the specialized symbols necessary in vibration, stress, and stability work remain to be developed and standardized.

CURRENT DEVELOPMENTS

The NACA helicopter test tower was placed in operation. The work done to date is of a preliminary nature dealing with the calibration of the tower. The tower is 40 feet high and powered with a 1,500 horsepower engine. It is instrumented to obtain the average aerodynamic rotor forces as well as transient forces. The test tower is designed for the purpose of obtaining the aerodynamic rotor characteristics for the hovering and near-hovering cases and has been located in a relatively isolated area in order to minimize interference effects from other objects. The construction of the driving head is such that various types of rotors may be used.

Document 5-43 (c), Excerpts from Annual Report of the National Advisory Committee for Aeronautics (Washington, DC), 1946-58, "Subcommittee on Helicopters," Annual Report (1948), p. 21.

The increasing use of helicopters, both by the military services and by commercial operators, has accentuated the necessity for developing means of improving the flying and handling qualities of this type of aircraft. During the past year, the Committee has intensified its research on the basic problems involved in obtaining satisfactory stability and control characteristics for helicopters.

FLIGHT INVESTIGATIONS

Flight-performance measurements were made on a twisted, plywood-covered helicopter rotor in various flight conditions, in order to obtain reliable data with which to check the rotor theory that had already been published by the NACA. An analysis of the test results, published in Technical Note 1595, showed that rotor theory can be used to predict adequately the performance of helicopters in various steady-flight conditions. By comparing the test results with performance measurements on a fabric-covered rotor, the analysis of Technical Note 1595 also showed the importance of smooth, rigid-blade surfaces for obtaining maximum performance.

The effects of rotor-blade twist on helicopter performance in the high-speed and vertical-autorotative-descent conditions were investigated in flight and the results reported in Technical Note 1666. It was found that the use of negative blade twist appears to be an effective means for increasing the maximum speed of the helicopter as limited by blade-stall and for reducing the performance losses due to stall at a given thrust coefficient and tip-speed ratio. The investigations also showed that negative blade twist had little effect on the power-off performance of the rotor in the vertical-descent and forward-flight conditions.

ANALYTICAL STUDIES

As a first step in establishing a set of flying-and-handling qualities requirements for helicopters similar to those previously established for the airplane, a discussion of some fundamental concepts of helicopter stability and control was prepared. This paper also includes a discussion of several lines of development which appear to warrant consideration.

In view of the current interest in large, slow-moving load-carrying helicopters, methods for the improvement of rotor hovering performance are necessary. One means for accomplishing this improvement, which involves designing the rotor blades with proper amounts of twist and plan-form taper, was investigated theoretically in Technical Note 1542. The results of the analysis indicated that substantial

improvements in hovering payload could be achieved by small amounts of linear twist and taper.

The high tip speeds of helicopter rotors appear to offer a useful application of jet power, particularly for the large load-lifting type of helicopter. To evaluate the merits of the various types of jet power plants available, a theoretical study was made of the hovering performance of a helicopter powered respectively by a ram jet, pulse jet, and Nernst turbine in which the air is compressed by the centrifugal pumping action in the hollow rotor blade and mixed with fuel at the blade-tip burners.

BIBLIOGRAPHIES AND SUMMARY REPORTS

Direct contact with designers and research workers in the rotating-wing field has indicated the need for bringing to their attention all of the available technical literature. Accordingly, as an aid in obtaining such material and in order to acquaint the rotating-wing industry and the various Government agencies charged with the design, evaluation, and procurement of helicopters with the work done by the NACA in the field of rotating-wing aircraft, a bibliography of NACA papers issued in that field was released.

Also, in order to facilitate the application of miscellaneous airfoil data to the problems of the helicopter designer, a discussion of a number of the problems most frequently arising was published. A reference list of published reports on airfoil section characteristics (or their application) which experience had shown to be useful in connection with these helicopter problems was included in the paper.

Document 5-43 (d), Excerpts from Annual Report of the National Advisory Committee for Aeronautics (Washington, DC), 1946-58, "Subcommittee on Helicopters," Annual Report (1949), pp. 24-25.

In order to provide and interpret fundamental information on the factors which affect the flying qualities, performance, and reliability of helicopters, the NACA has enlarged and intensified its research in this field. In addition to theoretical studies, experimental investigations have been carried out on full-scale and small-scale models in flight, in wind tunnels, and on the Langley helicopter test tower.

ROTOR-BLADE SECTIONS

Five NACA airfoil sections intended for use on helicopter rotor blades were designed and tested in the Langley two-dimensional low-turbulence pressure tunnel. These airfoils have thicknesses varying from 10 to 15 percent of the chord and design lift coefficient from three-tenths to seven-tenths. Theoretical pressure distributions, together with measured values of the two dimensional aerodynamic characteristics over a range of Reynolds number[s], were obtained for each airfoil. In addition, the effects of surface condition on the airfoil characteristics were determined. The results of the investigation, which are presented in Technical Note 1922, were analyzed to demonstrate the effects of variations in thickness and camber on the pertinent aerodynamic characteristics. Theoretical calculations for different flight conditions are included to indicate the relative performance of sample rotors employing the different airfoils. These calculations show that the new airfoils are inferior in performance, for most flight conditions, to the NACA 8-H-12 airfoil section developed in a previous investigation.

ROTOR PERFORMANCE

An investigation was made on the Langley helicopter test tower to determine the effects of wind velocity on rotor performance. This information was needed to enable correlation of data obtained under various wind conditions and on different rotors. The results of the investigation, reported in Technical Note 1698, were in essential agreement with simple momentum theory which indicates that rotor performance increases with increases in airspeed above zero. As an example, it was found that for a typical helicopter the power required to produce a given amount of thrust was 17 per cent less in a 15-mile-per-hour wind than under zero wind conditions. It was also found that the effects of wind velocity on performance were virtually independent of blade load distribution.

An analysis of the steady autorotative vertical descent of a helicopter was made by Princeton University under NACA sponsorship. The effects of both constant and variable induced velocity over the rotor disk were determined and the results

reported in Technical Note 1906. It was found that, although the assumption of constant induced velocity causes considerable error in the load distribution along the blade, the rotor speed and rate of descent for small angles of blade pitch are negligibly affected. For high angles of pitch where blade stalling is important the errors in theoretically computed blade load distributions may be expected to be sufficient to cause disagreement with experiment[s]. A consideration of the forces of autorotation indicated that for small values of blade pitch these forces will be adequate for autorotation, and blade stalling can be neglected. At the higher values of blade pitch, however, the possibility of blade stalling resulting from an upward gust is increased.

An analytical study has been made by Princeton University of the motions of the helicopter in the transition range from hovering flight with power on to steady vertical autorotative descent following a power failure. The effects of hinging the blades, of blade moment of inertia, and of rate of pitch reduction after a power failure were considered. The results of the study, which were reported in Technical Note 1907, indicate that the effect of blade flapping is negligible as far as the establishment of steady autorotation is concerned. It was also found that in order to avoid excessive blade stalling during the transition, blade moment of inertia should be large and blade pitch should be reduced as rapidly as possible after power failure.

STABILITY AND CONTROL

As part of an investigation to establish satisfactory helicopter flying-qualities requirements and to determine means of satisfying these requirements, the flying-qualities problems of current helicopters as observed during flight were collected and are discussed in Technical Note 1799. This paper contains information on the flying qualities of helicopters obtained from performance testing, experience with various helicopter types, and knowledge of foreign work in this field. It was found that the principal problems of current helicopters are: Instability with angle of attack in forward flight; control sensitivity in forward flight, particularly with the smaller helicopters; and control forces following control movements during maneuvers. Some discussion is given of suggested remedies for these problems.

To aid in establishing criterions [*sic*] for acceptable helicopter stability characteristics, flight tests were conducted on a small single-rotor helicopter possessing stick-fixed longitudinal characteristics which were considered satisfactory by the test pilot. Time histories of longitudinal maneuvers were obtained for correlation with the test pilot's personal observations.

VIBRATION

The dynamic response of a helicopter rotor to oscillatory pitch and throttle movements was investigated in the Langley helicopter test tower to determine the

natural frequencies of the drag-angle motion and the damping required to prevent excessive drag-angle oscillation response. Both symmetrical oscillations, in which [some] of the blades lag and advance together, and unsymmetrical oscillations, in which the blades are out of phase with each other, were studied. The results, which are reported in Technical Note 1888, showed that, whereas the frequency of the symmetrical drag-hinge oscillations was influenced by the engine and gearbox inertias and rotor-shaft torsional stiffness, the frequency of the unsymmetrical oscillations was affected primarily by the rotor-pylon bending stiffness. These results were shown to be in agreement with predicted values and indicated that care should be exercised to insure the absence in the helicopter of regular disturbing forces, such as a hunting pitch and throttle governor or hunting automatic pilot, with frequencies near those of the resonant condition.

A contract investigation was carried out by the Polytechnic Institute of Brooklyn in which a theoretical study was made of the dynamic properties of helicopter rotor-blade systems. The study dealt with the application of the theory of small oscillations about a steady state of motion to a representative blade system hinged to a driving hub. The study covered the derivation of the angles of attack of the inflow, of the blade-position variables—pitch, flapping, and lagging—and of the aerodynamic inertia forces acting on hinged blades in both hovering and translational flight. Also included were the development and solution of the equilibrium conditions of the blade system and the development of the frequency, stability, and damping properties of hinged blades in both hovering and translational flight. Four combinations of relative constraint conditions between angles of pitch, flapping, and lagging were investigated. The results are reported in Technical Note 1430.

Document 5-43 (e), Excerpts from Annual Report of the National Advisory Committee for Aeronautics (Washington, DC), 1946-58, "Subcommittee on Helicopters," Annual Report (1950), pp. 27-29.

The increasing practical application of helicopters has emphasized the need for research information which will permit the development of machines having improved performance and satisfactory flying and handling qualities. The research effort of the NACA has been directed at supplying this information. Theoretical, flight, wind-tunnel, and helicopter test-tower studies are being made at Langley of such problems as the development of helicopter rotor airfoils, autorotation of jet-powered rotors, helicopter stability and control, and vibration.

ROTOR-BLADE SECTIONS

In order to simplify the construction of small metal helicopter rotor blades, consideration is being given to the use of a blunt, thick trailing edge. The aerodynamic penalties resulting from the use of this thickened trailing edge have been studied using a two-dimensional model of a modified NACA 0012 airfoil. The results are presented in Technical Note 2074. Tests were made at Reynolds numbers of 3,000,000 and 6,000,000 to determine the lift, drag, and pitching-moment characteristics of three airfoil sections formed by removing successively large portions of the rear of the airfoil section. The results indicated that the minimum drag coefficient increased for both smooth and rough surface conditions; with increasing trailing-edge thickness, however, the maximum lift coefficient remained nearly constant for the smooth condition and increased slightly for the rough condition. The position of the aerodynamic center was found to move rearward with increasing trailing-edge thickness.

One of the more promising of the airfoil sections designed specifically for helicopter rotors, the NACA 8-H-12, has been investigated in the Langley two-dimensional low-turbulence pressure tunnel at Reynolds numbers from 1,800,000 to 11,000,000. The data, presented in Technical Note 1998, indicated no unusual scale effect on lift, drag, or pitching moments in either the smooth or rough leading-edge conditions.

ROTOR PERFORMANCE

The autorotative rates of descent of conventionally powered helicopters with normal disk loadings have proved to be satisfactory to the pilot from the standpoint of safety and controllability. The autorotative performance of helicopters powered by rotor-blade-tip jet units, however, presents a problem because of the high rates of descent resulting from the relatively high drag of the jet units when they are inoperative. In order to obtain more quantitative information concerning the effects of

the power-off drag of the tip jet, the autorotative performance of a hypothetical tip-jet powered helicopter was calculated for several values of jet-unit power-off drag coefficient. The analysis and the results are published in Technical Note 2154. It was concluded that the power-off drag of ram-jet units of current design could cause a marked increase in the minimum rate of descent of helicopters, but that the effects of the power-off drag of pulse-jet units giving power or thrust equal to the ram-jet units would be less severe because of their greater ratios of net power-on thrust to power-off drag.

STABILITY AND CONTROL

Because of the increased demand for improvements in the flight characteristics of helicopters, particularly the handling qualities, a major effort has been exerted toward the establishment and fulfillment of satisfactory flying-qualities requirements. The problem was investigated by obtaining flight-test measurements and corresponding pilots' opinions of the forward-flight longitudinal flying-qualities characteristics of several single-rotor helicopters. The comparison obtained formed the basis for defining satisfactory longitudinal flight characteristics. The conclusions reached as a result of these tests were expressed in the form of tentative flying-qualities requirements. The results of the investigation are presented in Technical Note 1983.

The flight investigations also showed the importance of a stability parameter known as rotor damping, the moment produced by the rotor per unit [of] angular pitching or rolling velocity, on the handling qualities of the helicopter. The subject was investigated theoretically and the results indicated that present-day helicopters with conventional control systems tend to have low damping at high speed and in climbs and can even experience negative damping in certain maneuvers, and that high-speed, high-powered helicopters and certain types of convertible aircraft would have prohibitive amounts of negative damping. The analysis, together with an experimental check of trends shown with varying flight conditions, was published in Technical Note 2136, which also contained suggestions for the avoidance of negative damping through special design features. The investigation also disclosed the fact that the assumption that the rotor force vector is at all times perpendicular to the tip-path plane during rolling or pitching may give highly misleading results when applied to the calculation of rotor characteristics.

Most of the published literature on helicopter stability is written for the specialist in stability theory. For the nonspecialist, an explanation of the fundamental ideas underlying helicopter stability in terms of the basic physical parameters rather than of specialized mathematics has been prepared and is presented in Technical Note 1982. Three primary helicopter-rotor stability parameters that influence the flying qualities of helicopters are discussed in fundamental terms. Static stability of the helicopter and the stick-fixed oscillation in hovering and forward flight are also discussed in the same fashion because of their influence on flying qualities.

The results of flight tests made by the Navy of a tandem-rotor helicopter representative of a present helicopter design indicated that it was directionally unstable at small angles of yaw. To study and find means for increasing the directional stability of this helicopter, force tests have been made in the Langley free-flight tunnel on a model of a fuselage-pylon combination which was representative [*sic*] of the tandem-rotor configuration. The investigation included force tests of the model with the original tail and with various modifications to the tail.

An aerodynamic servo-controlled rotor system in which auxiliary airfoils mounted outboard on the blades are used to twist the blades in order to achieve pitch control has been investigated on the Langley helicopter tower. The results, published in Technical Note 2086, indicated that satisfactory performance and control characteristics could be obtained by using the aerodynamic type of servo-control, although approximately 6.5 percent more hovering power was required as compared with a conventional rotor of the same diameter and solidity.

VIBRATION

A theoretical analysis of the frequency and damping characteristics of the free modes of vibration of balanced, fixed-ended, and hinged elastic rotor blades in hovering and in vertical flight has been made by the Polytechnic Institute of Brooklyn under NACA sponsorship. This study, presented in Technical Note 1999, is further discussed under the section on the Subcommittee on Vibration and Flutter.

The frequency and damping characteristics of the coupled flapping and lagging oscillations of helicopter blades in hovering have also been derived for the general case in which the lagging (vertical) hinge axis is offset from the flapping hinge axis, while both hinge axes are inclined. The analysis and the numerical examples indicate that significant increases in the damping of the lagging motions, which ordinarily border on instability, can be obtained by suitable inclinations of the hinge axes, especially of the lagging axis. Offsetting the flapping and lagging hinge axes tends especially to increase the natural lagging frequency.

RESEARCH EQUIPMENT AND TECHNIQUE

A suitable hot-wire anemometer was devised and installed in a helicopter where it has been in use for 1 year. This instrument indicates the forward component of airspeed, whether positive or negative, and is particularly suitable for the very low airspeeds which are encountered near hovering.

Document 5-43 (f), Excerpts from Annual Report of the National Advisory Committee for Aeronautics (Washington, DC), 1946-58, "Rotary Wing Aircraft," Annual Report (1951), pp. 16-17.

Based on the results of flight investigations of several single-rotor helicopters, preliminary qualitative requirements for satisfactory flying and handling qualities of helicopters have been established. Progress in designing helicopters to meet these requirements, however, has been handicapped by the need for a method permitting sufficiently accurate prediction of the flying qualities of a helicopter at the design stage. To help fill this need, existing rotor theory, accurate for the calculation of rotor performance and blade motion, has been extended (Technical Note 2309) to permit the prediction of those rotor characteristics that influence the flying qualities. Variation of the longitudinal derivatives of rotor resultant force, rotor pitching moment, and rotor torque with operating parameters such as rotor angle of attack, collective pitch, forward speed, and rotational speed may be determined. The usual simplifying assumption that the rotor resultant force vector is perpendicular to the rotor tip path plane is shown by the results of this theory to lead in many cases to grossly incorrect longitudinal stability derivatives. The theory also indicates that the increase in rotor load factor with an incremental increase in angle of attack is approximately linear with increasing forward speed. This is in contrast to the airplane where the increase is as the square of the forward velocity.

Increases in the forward speed of helicopters are expected to require increases in rotor tip speeds in order to avoid excessive tip stalling on the retreating blade. At tip speeds within the transonic range the rotor will suffer some performance loss due to compressibility. In order to gain an insight into the magnitude of this compressibility-induced performance loss and to furnish a check on theoretical methods of estimating the loss, two conventional full-scale rotors, one having linear twist and the other untwisted, have been tested to tip speeds [of] up to 770 feet per second on the Langley helicopter test tower. The results of this study, reported in Technical Note 2277, show that both rotors suffered increasing compressibility losses as the tip speed increased to the maximum speed studied. Linear twist delayed the onset of compressibility losses. For the blades investigated good agreement was obtained between the measured and predicted drag-divergence Mach number.

As part of a general investigation of the aerodynamic characteristics of various multi-rotor configurations, an investigation to determine the static-thrust performance of two full-scale coaxial helicopter rotors has been conducted in the Langley full-scale tunnel. One coaxial rotor was equipped with blades tapered in both planform and thickness and the other with blades tapered in thickness only. The results, presented in Technical Note 2318, show the hovering performance of each rotor in the coaxial configuration and with the upper rotor removed. The effect of application of yaw control on the hovering performance of the coaxial configurations is also presented. A comparison of measured and predicted hovering performance is included.

As a part of the investigation of multi-rotor configurations a study was made of the air-flow patterns through small scale single, coaxial, and tandem rotor models. The balsa-dust technique of air-flow visualization was employed. The photographic results, presented in Technical Note 2220, provide a qualitative interpretation of the transient and steady-state flow through the rotors.

A theoretical study of the rigid-body oscillations in hovering of helicopter rotor blades has been made by the Polytechnic Institute of Brooklyn under NACA sponsorship. The study, presented in Technical Note 2226, includes a determination of the rigid-body frequency and damping characteristics of the coupled flapping and lagging oscillations of helicopter blades on which the lagging hinge axis is offset from the flapping hinge axis and both hinges are inclined. The effect of offset of the flapping hinge axis from the axis of rotation of the rotor is also considered.

The analysis and numerical examples indicate that significant increases in the damping of the lagging motions, which ordinarily border on instability, can be obtained by suitable inclinations of the hinge axis, particularly the lagging axis. Offsetting the flapping and lagging hinge axis also increases the natural lagging frequency.

Document 5-43 (g), Excerpts from Annual Report of the National Advisory Committee for Aeronautics (Washington, DC), 1946-58, "Rotary Wing Aircraft," Annual Report (1952), pp. 26-28.

Some effects of varying the damping in pitch and roll on the flying qualities of a small single-rotor helicopter are reported in Technical Note 2459. Flight-test measurements and pilots' opinions of the longitudinal flying qualities and later control characteristics of a small single-rotor helicopter are presented. In these tests the damping of the helicopter in pitch and roll were varied by means of a rate-sensitive automatic-control device from the amount present in the helicopter with the device inoperative to nearly three times that amount. Longitudinal stability and control characteristics which were unsatisfactory with the device inoperative were improved by increasing the damping of the helicopter, and were judged to be satisfactory when the damping was approximately doubled by the device. The low rate of roll associated with the largest amount of damping tested was adequate for normal flying.

Since the ability to operate under instrument flight conditions will materially extend the usefulness of the helicopter, the Langley Laboratory has undertaken a flight investigation to determine what flying qualities and what flight instruments are necessary for satisfactory all-weather operation. Some initial results of this program are reported in Technical Note 2721, wherein it was concluded that, although existing longitudinal-flying-qualities requirements for helicopters are adequate for instrument flight at speeds near cruising, both the flying qualities and pilot's instruments will require improvement before satisfactory instrument flight is possible from hovering to maximum speed.

One approach to the problem of providing more suitable instruments for helicopter blind flying is to combine on a single indicator information that is usually obtained from several different instruments. A commercially available flight indicator which combines heading, altitude, bank angle, and pitch information was modified for helicopter use and flight-tested under simulated instrument conditions. The results, presented in Technical Note 2761, indicate that use of the combined-signal indicator for helicopter blind flying enabled the pilot to maintain a more accurate flight path and required less concentration than use of conventional instruments alone.

Although standard rotor theory has proven adequate for predicting the performance of present day helicopters, certain of the assumptions used in the development of the standard theory limit the usefulness of the theory in the study of the characteristics of high performance helicopters. The development of theories adequate for high speed helicopters are presented in Technical Note 2656 prepared by the Georgia Institute of Technology under NACA sponsorship, and in Technical Note 2665 by the Langley Laboratory. Neither theory is limited to the flight conditions wherein the rotor-blade-section inflow angles are small and wherein there is little or no reversed flow over the rotor disc as in the case of the standard theory. Although both theories are in agreement with existing experimental data and standard theory on flapping rotors at low tip speed ratios, the theory developed by Langley appears to be more applicable to the study of flapping rotors and the Georgia Tech theory more applicable to the study of rigid rotors because of the system of axes chosen.

Methods are available for estimating the mean value of induced velocity through a helicopter rotor in hovering and steady autorotation. No theory is available, however, for treating the flow during the transition from hovering to autorotation and the development of a rigorous theory would be extremely difficult because of the unsteady flows which predominate in this regime of flight. Technical Note 1907 assumed an exponential variation of induced velocity during the transition; however, there was at the time of publication of this report insufficient experimental data to confirm the assumption. Princeton University, under NACA sponsorship, undertook an investigation of the transition from hovering to steady, vertical autorotation of several rotor models with the object of determining the validity of the previously assumed exponential variation of induced velocity. The results of this investigation presented in Technical Note 2648 indicate that the effective induced velocity during transition often differs greatly from the previously assumed variation.

Recent flight data on the auto-rotational characteristics of a helicopter were in serious disagreement with existing wind tunnel results and Glauert's empirical induced velocity relations. In view of this, the Georgia Institute of Technology, under NACA sponsorship, undertook a wind-tunnel study of the induced velocity, thrust and rate of descent of several helicopter rotor models. The objects of the

program included an evaluation of the validity of Glauert's empirical relations, a determination of the sources of error in previous wind-tunnel studies of the induced velocity through auto-rotating rotors, an indication of the effects of blade taper and twist on vertical descent characteristics, and flow visualization with smoke and tufts. The results of the investigation, presented in Technical Note 2474, indicate considerably lower mean induced velocities in hovering and in small rates of descent, and considerably higher mean induced velocities at high rates of descent than would be predicted by Glauert. The wind tunnel results are in fair agreement with flight experience. The effects of both blade twist and taper are also discussed.

Statistical information concerning the flight loads and associated operating conditions of a helicopter engaged in air-mail operations has been obtained. An analysis of the normal accelerations and operating conditions encountered in 253 hours of flying time is presented in Technical Note 2714. The results indicate that for this type of operation the loads developed in routine takeoff and landing-descent maneuvers are often greater than the maximum loads encountered en route.

Existing theoretical methods of calculating the loading and bending moments on helicopter rotor blades are known to be in error because of certain simplifying assumptions made in the development of the theory. The Massachusetts Institute of Technology, under NACA sponsorship, has developed a wind-tunnel technique for determining blade bending moments and has evaluated the accuracy of existing methods of blade bending moment calculations for a flapping rotor. Also, existing theory for application to fixed-at-root blades has been modified. The results of the investigation are reported in Technical Note 2626 and show that for both the fixed- and hinged-at-root blades the experimental data are in fair agreement with theory; however, the many discrepancies between theory and experiment are pointed out and, where possible, explained.

Document 5-43 (b), Excerpts from Annual Report of the National Advisory Committee for Aeronautics (Washington, DC), 1946-58, "Helicopters," Annual Report (1953), pp. 17-18.

Although much progress has been made, improvement in helicopter flying qualities continues to be an important matter. Better definition of design goals and methods of relating design changes to stability characteristics are essential. In addition to the basic single-rotor case for which work has been previously reported, other important types, such as the tandem configurations, require study.

An investigation of the lateral-directional flying qualities of a tandem-rotor helicopter in forward flight was undertaken to determine desirable goals for helicopter lateral-directional flying qualities and possible methods of achieving these goals. The results of this study are presented in Technical Note 2984. Pilot opinions are included to show what considerations are important insofar as flying qualities are concerned. The conclusions are also expressed in the form of desirable flying-qualities requirements.

As an aid to understanding and analyzing the stability of a tandem-rotor helicopter as well as a single-rotor machine, a study has been made at the Georgia Institute of Technology, under NACA sponsorship, of the normal component of induced velocity in the vicinity of a lifting rotor. The tables and charts in Technical Note 2912, which reports this study, may be used to determine the interference-induced velocities arising from the second rotor of a tandem or side-by-side rotor arrangement and the induced flow angle at a horizontal tail plane.

Conditions encountered by some rotors used in convertiplane designs do not permit certain simplifying assumptions used in analysis of the stability or performance of more conventional rotors. A study was conducted at the Georgia Institute of Technology, under NACA sponsorship, to develop a blade-element analysis for lifting rotors that would avoid the approximations that blade-element inflow angle and blade angle are small, and thus be useful for convertiplane calculations. The results of this study, presented in Technical Note 2656, are in agreement with experimental results previously reported in the range of rotor operating conditions encountered by helicopters.

An experimental investigation of some factors in the problem of reducing the descending velocity of a helicopter in autorotation was conducted by Princeton University, under NACA sponsorship, and is reported in Technical Note 2870. In this study, tests were made using a model rotor to examine the effects of disk loading, rotor inertia, and amount and rate of blade-pitch change on the flare performance of the rotor. The tests were extended to ranges of the variables which would be disastrous in flight.

In order to permit greater reliability without sacrifice of useful load, particularly for less conventional rotary-wing designs, a better understanding of the loads occurring in flight is essential. As one step, an analysis has been made of load factors

obtained in flight tests of two single-rotor helicopters. Some additional information obtained from military-pilot-training and commercial-airmail operations with helicopters is also incorporated in this study, which is reported in Technical Note 2990. Load factors of the order of 2.5 were found to be attainable by several different deliberate maneuvers, and this same value was also approached under actual operating conditions. The largest flight loads, as a group, resulted from pull-ups in which both cyclic and collective control were applied with certain phasing. The assumption that flight load factors are limited to the value that would be computed by assuming all blade sections to be operating at maximum lift coefficient agreed well with flight-test results. This assumption thus provides a convenient method of estimating, for new designs, the maximum obtainable load factors for any given flight condition. It is concluded that higher speed helicopters and unorthodox configurations may be subjected to load factors materially higher than those experienced by current types.

The complex nature of the flow through a helicopter rotor, both in hovering and in forward flight, renders the prediction of aerodynamic loading on the blade very difficult. In order to provide insight into the nature and distribution of aerodynamic loading, pressure distributions were measured on a model helicopter rotor blade under hovering and simulated forward flight conditions. This study, carried out by the Massachusetts Institute of Technology under NACA sponsorship, is reported in Technical Note 2953. The work included tests of rotors with and without flapping-hinge offset. The results, showing loading distribution on the rotor disk, indicated a marked difference between the aerodynamic characteristics of the two rotors operating under identical conditions. The introduction of an appreciable amount of flapping-hinge offset resulted in a large first-harmonic aerodynamic loading in simulated forward flight. Blade-flapping measurements revealed appreciably lower values of first-harmonic flapping coefficients for the offset rotor as compared with the conventional configuration. An analysis of the angle of attack at the tip of the retreating blade, based on experimental flapping measurements, indicated that an appreciable offset flapping hinge in combination with a low blade mass constant offers a means of postponing stall on the retreating blade.

Document 5-43 (i), Excerpts from Annual Report of the National Advisory Committee for Aeronautics (Washington, DC), 1946-58, "Helicopters," Annual Report (1954), pp. 26-27.

LOADS

The correct prediction of the loads and stresses imposed on a helicopter in flight is essential to the reliability, availability, and utility of the helicopter. A fundamental aspect of the loads problem is a knowledge of the bending frequencies and mode shapes of the lifting rotor blades. A chart procedure for rapidly estimating these frequencies, for both rotating and non-rotating blades, has been worked out. Since the procedure was based on Southwell's equation, an evaluation of the method with regard to such parameters as higher modes, blade offset, and variable mass and stiffness distributions has been made. The evaluation shows that, when non-rotating-beam bending modes are used, Southwell's equation yields reasonably accurate bending frequencies for rotating helicopter blades. Several comparisons of frequencies estimated, by using the charts with values given by the manufacturer for several actual blades, show that the simplified procedure yields good practical results.

The designer must also know the extent to which gusty air affects rotor-blade stresses. An investigation of the effects of gusts was conducted at the Langley helicopter test tower and the results reported in Technical Note 3074. For the rotor conditions tested, in gusty winds up to 26 mph, the influence of gusts appeared to be secondary to the vibratory stress levels that resulted from the dissymmetry of the rotor downwash in forward flight.

Tests have also been conducted at the Langley helicopter test tower to determine the increase of rotor loading and induced velocity due to a rapid collective-blade-pitch increase during a jump takeoff or maneuver. The results (Technical Note 3044) showed that the rates of blade-pitch increase ranged from 6° to 200° per second and, in general, at the high pitch rates it was possible to develop over twice the normal thrust coefficient for about 0.2 second. The calculated thrust overshoot is shown to be in good agreement with experimental time histories.

PERFORMANCE

The helicopter has now been developed to the point where future increases in speed and greater range dictate the necessity for reductions in parasite drag. Accordingly, a preliminary inspection of available literature dealing with airplane drag cleanup work, conducted in previous years in the Langley full-scale tunnel, has been made. The results were applied to a typical helicopter in Technical Note 3234. Substantial reductions in parasite drag may be realized by modifying the landing-gear installation as well as the rotor hub, air induction and exit systems,

and exhaust stacks, and by eliminating air-leakage gaps and protuberances. For the typical helicopter examined, a 19-mph speed increase and a 25-percent increase in maximum range are indicated.

In an effort to assess the relative advantages of various helicopter configurations for different applications, a general research program to determine the performance of multirotor configurations has been conducted at the Langley full-scale tunnel. A summary of the hovering and forward-flight tests of one coaxial and one tandem configuration is reported in Technical Note 3236. The results indicated that, although power requirements for the coaxial rotor in static thrust can be predicted with good accuracy from available single-rotor theory, more power is required in level flight than would be predicted for an equivalent single rotor. The tandem arrangement having zero rotor overlap and stagger indicated less power required for static thrust than predicted, but somewhat greater power for level flight than predicted from single-rotor theory.

Current design trends have resulted in increased interest in the use of blade twist for most rotor configurations. Theoretically derived charts for predicting the profile drag-lift ratio of a helicopter rotor having rectangular blades with -8° twist (blade pitch angle at tip 8° lower than at root, with linear variation between) have been prepared. Conditions for the onset of blade stalling are shown in the charts. A sample study is included to illustrate the theoretical effects of blade twist in forward flight, with reference to limiting forward speed, power required, power-off rate of descent, and blade motion. The sample study includes results for additional twist values to indicate the trends beyond the two values for which charts are available.

STABILITY AND CONTROL

One of the most important helicopter flying-qualities criteria utilized in current specifications deals with satisfactory maneuver stability, that is, no divergent tendency in pitch. It was found that the same criterion was generally applicable to both tandem- and single-rotor helicopters. A basis for designers and procurement agencies, to use in studying the maneuver stability of a prospective helicopter, is presented in Technical Note 3022. The report contains a chart from which combinations of pertinent stability derivatives that result in at least marginal stability can be conveniently determined. Methods for theoretically predicting the necessary derivatives are also discussed, as well as techniques for measuring the derivatives by means of flight tests.

Another important aspect of current flying-qualities specifications is the criteria for minimum helicopter directional stability and control. With the conventionally powered single-rotor helicopter, and with many jet-powered helicopters, these requirements must be met by an adequately designed tail rotor. As an aid in designing helicopter tail rotors to meet the directional criteria, theoretically derived charts and equations are presented in Technical Note 3156 by which tail-rotor

design studies of directional trim and control response at low forward speeds can be conveniently made. The use of the charts and equations for tail-rotor design studies is illustrated, and comparisons between theoretical and experimental results are presented.

Helicopter fuselages in general, and tandem fuselages in particular, may exert a marked influence on helicopter directional stability and control. An experimental investigation was therefore made in the Langley stability tunnel to determine the directional stability of two tandem helicopter fuselages (Technical Note 3201). One fuselage represented a helicopter with overlapping rotors (overlap-type fuselage) and the other a helicopter with non-overlapping rotors (non-overlap-type fuselage). The overlap-type fuselage model was found to be directionally unstable for certain combinations of angle of attack and sideslip, but could be made directionally stable by blunting the vertical tail of the model or by using a thin tail in place of the original thick vertical tail. The non-overlap-type fuselage model was directionally unstable for positive angles of attack throughout the angle-of-sideslip range. Spoilers located around the fuselage nose were the only effective means found to make this fuselage stable without resorting to major design changes.

AIRFOIL CHARACTERISTICS

Extension of the range of information on airfoil-section characteristics has been continued to meet the specialized requirements of rotating-wing aircraft. The increasing speed of helicopters, for example, has brought about the need for airfoil data at high subsonic Mach numbers at angles of attack as high as 30°. Data in this range were obtained in an investigation in the Langley low-turbulence pressure tunnel of four airfoil sections varying in thickness from 6 to 12 percent. Information which illustrates the effects of airfoil-section parameters and flow variables on the aerodynamic characteristics of symmetrical, two-dimensional airfoils at high angles of attack, obtained from the literature and recent investigations, is summarized in Technical Note 3241. Included in this summary are the results of an investigation of one section, through an angle-of-attack range from 0° to 360°, which show that the drag coefficient reaches a value of 2 at an angle of attack of 90°.

In an effort to develop a helicopter rotor having minimum profile-power losses, the NACA has derived a special series of helicopter airfoil sections. The most promising of such sections (NACA 8-H-12) is a laminar-flow airfoil which, when tested in the Langley two-dimensional low-turbulence tunnel[,] showed low drag in the operating lift-coefficient range of most helicopter rotors without undue sacrifice in maximum section lift coefficient. The airfoil retained reasonable aerodynamic characteristics when tested in the rough condition. The practical aspects of blade construction, however, created doubt as to the achievement, in actual operation, of the low drag values obtained from the aerodynamically smooth, two-dimensional test specimens. A test rotor incorporating the NACA 8-H-12 section was therefore

constructed and tested on the Langley helicopter test tower. The test results, reported in Technical Note 3237, indicated that controlling construction to tolerances of the order of 0.002 inch of true surface contour resulted in the realization of one-half of the theoretical profile-drag reduction, or a 6- to 7-percent reduction of the total torque coefficient.

ROTOR INFLOW

A knowledge of the inflow distribution through and about a lifting rotor is required in almost all fields of helicopter analysis. In view of the stimulation of interest in rotor-induced flow brought about by the current emphasis on loads, stability and control, and the expanded use of multirotor configurations, it was considered desirable to review the available information on the subject. Such a review is presented in Technical Note 3238. The available material is summarized in a table according to flight condition, type of information, source, and the reference papers in which the data can be found. Representative aspects of some of the reference material are discussed.

Document 5-43 (j), Excerpts from Annual Report of the National Advisory Committee for Aeronautics (Washington, DC), 1946-58, "Helicopters," Annual Report (1955), pp. 21-23.

LOADS AND FLUTTER

The periodic nature of the loads imposed on the helicopter rotor system requires that the designer be supplied with means for calculating the bending frequencies and mode shapes of the lifting rotor blades. Simplified procedures and charts for the rapid estimation of bending frequencies of rotating beams are presented in Technical Note 3459. A Rayleigh energy approach utilizing the bending mode of the non-rotating beam in the determination of the bending frequency of the rotating beam was evaluated and was found to give good practical results for helicopter blades. Charts are presented for the rapid estimation of the first three bending frequencies for rotating and non-rotating cantilever and hinged beams with variable mass and stiffness distributions, as well as with root offsets from the axis of rotation. Some attention is also given to the case of rotating beams with a tip mass. A more exact mode-expansion method used in evaluating the Rayleigh approach is also described. Numerous mode shapes and derivatives obtained in conjunction with the frequency calculations are presented in tabular form.

In the course of flight testing an experimental two-bladed jet-driven helicopter, the main rotor blades were found to be subject to a condition of near resonance between the frequencies of the first elastic bending mode of the blades and the third harmonic component of the aerodynamic loading which results in high bending

strains during the normal flight conditions. An experimental investigation, reported in Technical Note 3367, has been made on a $\frac{1}{10}$ -scale dynamic model of this helicopter to determine the effect of various changes in the design configuration on the blade bending strains. These changes included the addition of different amounts of concentrated weight to the blades at various radial and chordwise locations and variations in the design counterweight locations, as well as changes in blade pitch-control stiffness and blade bending stiffness. Tests were made under both hovering and forward-flight conditions up to a tip-speed ratio of approximately 0.18. The results of the tests show that the maximum bending strains occurred at tip-speed ratios in the vicinity of 0.10 and that the strains could be reduced materially by attaching to the blades, at proper radial stations, concentrated weights that would minimize the condition of resonance. Further reductions in bending strains could be obtained by the proper location of the weight along the chord. A concentrated weight equal to 5 percent of the blade weight appeared to be about two-thirds as effective as a weight equal to 10 percent of the blade weight.

One of the most important aspects of the helicopter loads problem is that of fatigue, including any contributions that might arise from gust loads. Although military and civil rotary-wing design specifications require that load factors due to an arbitrary gust be considered, the response of a lifting rotor to gusts is difficult to predict analytically because of the transient nature of the disturbance. A comparison is made in Technical Note 3354 of the effects of gusts on a single-rotor helicopter and an airplane flown in formation. The results indicate a somewhat greater gust alleviation for the helicopter than for the airplane over the speed range investigated, and a substantial effect of speed on the normal accelerations due to gusts was observed. The need for a rigorous analytical approach, compared with the simplifying assumption of only a rotor angle-of-attack change, is also discussed.

In addition to a knowledge of the overall response of a helicopter to gust loads, information is also needed which provides some insight into operating gust and maneuver loads and corresponding flight conditions, the maximum loads likely to be encountered, and the percentage of time spent in various flight conditions by helicopters in various fields of application. Such information is of interest as an aid in establishing a more rational basis for helicopter design and in more realistically estimating the service life of certain critical helicopter components. Technical Note 3434 presents an analysis of the normal accelerations and operating conditions encountered by two different airmail helicopters and a military pilot-training helicopter. Tables and graphs are used to illustrate the effect of operating conditions on acceleration levels. The results based on 4,325 flights indicate that maneuvers are usually responsible for the large accelerations encountered, whereas gusts contribute primarily to the large number of smaller accelerations.

In order to determine the stress response of a rotor to a gust of known velocity, preliminary investigations have been made in the Langley gust tunnel to determine the effects of a sharp-edge vertical gust on the blade flapwise vibratory bending

moments of small model rotors having either fixed-at-root or teetering blades. Both rotor configurations were tested up to a tip-speed ratio of about 0.35. The results, reported in Technical Note 3470, for simulated forward flight (which include the effects of the change in rotor angle of attack due to the gust) indicate that the effect of the gust on the maximum vibratory bending moment is of less importance for the teetering rotor than for the fixed-at-root rotor. Increasing the rotor speed decreases the magnitude of the vibratory bending moments resulting from a given gust. At a given rotor speed, the magnitude of the vibratory components due to the gust increases with increasing tip-speed ratio. Increasing the rotor speed at a constant forward velocity decreases the maximum vibratory bending moments for all conditions tested. The rate of increase of the vibratory bending moments with tip-speed ratio is approximately twice as great for the fixed-at-root rotor as for the teetering rotor.

In general, helicopter designers are not greatly disturbed by the phenomenon of flutter, primarily because rotor blades are generally massbalanced throughout their length in consideration of other more imminent problems, such as undesirable control forces. These favorable conditions may not exist indefinitely, however; for example, the introduction of irreversible controls may lead the designer to select blades which are not completely massbalanced in order to obtain the desired strength with minimum weight. The use of such design features in conjunction with higher tip speeds may cause flutter to become a problem. Some experimental studies have therefore been conducted to determine the general characteristics of rotor-blade flutter under hovering and simulated forward-flight conditions by means of flutter tests of the rotor system of a one-tenth-scale dynamic model of a two-bladed jet-driven helicopter. Tests were made of several configurations to evaluate the effect of variations in the blade pitch-control stiffness and forward speed on the flutter speed. The results of the investigation, reported in Technical Note 3376, show that the flutter speed of the model blades was increased as the blade pitch-control stiffness was increased and indicated that the structural blade modes of primary significance with respect to flutter were the first torsion mode and the flapping mode. The results also show that the rotor speed at flutter was reduced slightly as the tip-speed ratio was increased from a hovering condition and that the nature of the flutter motion was changed from a sinusoidal oscillation having a distinct frequency to a more random type of oscillation of comparable amplitude but without a well-defined frequency.

PERFORMANCE

Current design trends require methods for estimating the effects of changes in design variables and flight condition on the performance of helicopters operating at high forward speeds and at high rates of climb. Basic equations for calculating such effects are already available. However, because of the length and complexity

of these equations, their application is considerably simplified by presenting them in the form of charts from which helicopter performance can be quickly estimated. Technical Note 3323 presents theoretically derived charts for use in predicting profile-drag thrust ratios of rotors having hinged blades with -8° twist. The charts are considered applicable to rotor operating conditions in which high tip-speed ratios or large rotor angles of attack are encountered; however, they do not include the effects of compressibility. Limit lines showing the conditions of onset of stall are included in the charts, and the effects of blade twist on the stall limits are discussed.

Although the effect of blade twist on the rotor profile-drag power is not very significant at certain flight conditions, differences in profile-drag power between blades of different twist can become appreciable at other flight conditions, particularly at high tip-speed ratios. Charts published in Technical Note 3323 for estimating the performance of high-performance helicopters are applicable to rotors having hinged rectangular blades with a linear twist of -8° . Supplementary charts covering twists of 0° and -16° are presented in Technical Note 3482.

As helicopter forward speeds increase, the flapping behavior of the main rotor blades becomes more critical, both from the standpoint of the stability of the motion and also in regard to the blade-fuselage clearance problem. Although the flapping motion of helicopter blades has shown itself to be very stable for conventional tip-speed ratios (below about 0.5), some doubt exists as to the stability of the motion at tip-speed ratios equal to or greater than 1.0. Technical Note 3366 presents a method for studying the transient behavior of the flapping motion, as well as for calculating the steady-state flapping amplitudes, of free-to-cone and seesaw rotors operating at extreme flight conditions. The method is general and can be applied to blades of any airfoil section, mass distribution, twist, plan-form taper, root cutout, and flapping hinge geometry. Stall and compressibility effects can also be accounted for. Applications of the method to the calculation of the stability of the flapping motion of unloaded rotors and to the transient blade motion resulting from arbitrary control inputs under conditions of extreme stall are included.

In the performance analyses of rotating-wing aircraft under extreme operating conditions, very-high-angle-of-attack airfoil data are needed for the inboard locations of the retreating rotor blades. In order to supply some of this high-angle-of-attack information, the two-dimensional aerodynamic characteristics of the NACA 0012 airfoil section have been obtained in the Langley low-turbulence pressure tunnel at low speeds at angles of attack from 0° to 180° . The results, presented in Technical Note 3361, show that the application of surface roughness or a reduction of Reynolds number had only small effects on the lift coefficients obtained at angles of attack between 25° and 125° . The drag coefficient at an angle of attack of 180° was about twice that for an angle of attack of 0° . The drag coefficient at an angle of attack of 90° was closely comparable with the drag coefficient of a flat plate of infinite aspect ratio inclined normal to the flow.

ROTOR INFLOW

Continued progress in all phases of rotor aerodynamics requires increasing experimental and theoretical knowledge of rotor flow fields. To help fill this need, wind-tunnel flow surveys have been conducted in the vicinity of single and tandem helicopter rotors in the Langley full-scale tunnel. Preliminary results, published in Technical Note 3242, indicate that the average induced velocity across the span of a rotor may be calculated to an acceptable degree of accuracy by existing theory. The surveys also show many points of similarity between the flow behind a rotor at cruising speeds and the flow behind a wing. These measurements were used to calculate the approximate magnitude of the induced power requirements for a tandem-rotor system.

STABILITY AND CONTROL

Information obtained during NACA flying-qualities studies of a tandem helicopter indicated that the tandem-rotor configuration was susceptible to instability with speed in forward flight. An undesirable instability, evidenced by rearward stick motion with increasing forward speed at constant power, was indicated to be caused by variations with speed of the front rotor downwash at the rear rotor. An analytical expression for predicting changes in speed stability caused by changes in rotor geometry has been derived, and constants for use with the analytical expression have been presented in chart form to facilitate design efforts toward reduction of this instability.

In connection with the current interest in small, one-man helicopters, a series of flight tests has been conducted by the Langley Pilotless Aircraft Research Division to determine the flying qualities of a platform powered by a teetering rotor and supporting a pilot. The rotor investigated was 7 feet in diameter and was driven by air jets at the rotor tips fed through hollow blades by air hoses connected to an external air supply. The machine was tested indoors in hovering and in limited translational flight and outdoors in light and strong gusty winds at elevations of from 1 to 7 feet. The stability and controllability of the machine and flyer combination were found to be satisfactory.

Document 5-43 (k), Excerpts from Annual Report of the National Advisory Committee for Aeronautics (Washington, DC), 1946-58, "Helicopters," Annual Report (1956), pp. 36-37.

ROTOR AERODYNAMICS

The need for research work on helicopters arises both from the desire of the user for a better, more reliable, or less expensive helicopter to do an existing job and from the desire to develop designs which will permit successful application to new missions. For both purposes, improved rotor aerodynamic theory and coordinated experimental research are required. In recent years, modern high-speed automatic computing machines have become generally available to research institutions and to industry. This availability, in turn, has made possible the application of these machines to the problem of computing the aerodynamic characteristics of lifting rotors by numerical methods. By means of such methods, factors that are normally omitted from conventional analytical rotor treatments, such as stall and compressibility effects and combinations of such design parameters as hinge offset, blade twist and taper, and root cutout, can be accounted for. Greater accuracy is thus obtained for designs of conventional types, while design studies for radically different helicopters (particularly designs aimed at higher forward speeds) become practical. The necessary equations and procedures for carrying out the numerical computations involved are presented in Technical Note 3747. Rotor characteristics considered included thrust, profile drag, total power, flapping, rolling and pitching moments, direction of the resultant-force vector, and the harmonic contributions of the shear-force input to the hub.

A knowledge of the steady-state flapping behavior of lifting rotors is necessary in the design of helicopter hubs and control systems, in estimating rotor-fuselage clearances, and as a prerequisite to the numerical evaluation of the aerodynamic characteristics of rotors. Equations for calculating rotor-blade flapping have been available from various theories. In order to reduce computation to a minimum, theoretical flapping values can be obtained directly from charts which were constructed and are presented in Technical Note 3616. The charts are applicable over a wide range of helicopter operating conditions and for blade twists of 0° , -8° , and -16° .

The recent emphasis on helicopter-rotor vibration and the consideration of compound helicopters and convertiplanes require a more complete evaluation of the induced velocity field near a lifting rotor and of the rotor downwash in the regions of wings and tail planes. The preliminary report of this experimental investigation has been supplemented in Technical Note 3691 by a complete presentation of results and a comparison with theoretically predicted flow fields.

The normal component of induced velocity of a lifting rotor can be calculated with good accuracy as far rearward as three-quarters of a diameter behind the

front edge of the rotor, provided a realistic non-uniform (essentially triangular) disk loading is assumed. Because of the rapid rolling up of the trailing vortex system, the induced-velocity calculations at the rear quarter of the disk do not accurately predict the measured results. In the far field behind the rotor the induced flow can be more accurately predicted by considering a uniformly loaded rotor in the same manner as a rectangular wing. Charts of the normal component of induced velocity in the longitudinal plane of symmetry in the near and far fields of the rotor determined analytically for different non-uniform, circularly symmetrical disk loadings are presented in Technical Note 3690.

One of the more difficult problems facing the helicopter designer is the calculation of the rotor-blade aerodynamic loading. The problem is difficult because of the complexity of the rotor flow and the uncertainties of the assumed distribution of induced velocity across the rotor disk. An extensive investigation to determine experimentally the helicopter rotor-blade loads for both the hovering and forward-flight conditions has been conducted in the Langley full-scale tunnel. The static-thrust information on a single rotor is presented in Technical Note 3688. A rapid drop-off in load per foot of span is shown near the blade tip. A comparison of the blade-section loadings with theory shows that a tip-loss factor which varies with thrust coefficient gives more accurate results than the commonly employed constant tip-loss factor.

The effects of compressibility arising from high tip-speed operation on the flapping, thrust, and power of a helicopter rotor over a wide range of forward flight conditions were investigated by the use of numerical methods and are reported in Technical Note 3798. With the particular airfoil characteristics used, the results indicated minor increases in rotor flapping and thrust when rotor tip speed was increased from 350 to 750 feet per second. The largest effect noted was an increase in profile-drag power in the advancing side of the disk that was proportional to the amount by which the blade-tip Mach number exceeded the drag-divergence Mach number. These effects of compressibility appeared to be independent of blade twist but are, of course, a function of the airfoil characteristics employed in the analysis.

PROPULSION

The large load-lifter type of helicopters are particularly well suited to benefit from use of rotor-blade tip-mounted jet-propulsion power plants. A pulse-jet unit having high ratios of thrust to frontal area had previously been studied on the Langley helicopter test tower. In order to determine centrifugal-field effects on the propulsive characteristics, the same pulse-jet unit was tested over a range of yaw angles and forward speeds in the Langley 16-foot transonic tunnel. A comparison of the non-whirling and whirling results, presented in Technical Note 3625, indicates that the pulse jet is subject to reduced performance. This reduction results from centrifugal distortion of the fuel-spray pattern for centrifugal accelerations

greater than 200g (a value high enough to indicate that no difficulty of this nature should be encountered with the largest load lifters but indicating an area requiring careful consideration for smaller pulse-jet designs).

A performance analysis of fixed- and free-turbine helicopter engines has resulted in performance charts and comparisons of the off-design specific fuel consumption, altitude performance, power-speed characteristics, and response times. The results presented in Technical Note 3654 indicate that power modulation of the fixed-turbine engine was more rapid than the free-turbine engine at constant shaft speed, although simultaneous changes in speed and power were executed by both engines in about the same time. At constant temperatures, the free-turbine power varies only slightly with shaft speed, whereas the fixed-turbine power decreases significantly with shaft speed.

Solutions of the problem of excessive vibration, structural fatigue, roughness of control, and rotor interference would become more evident if the nature of the rotor disturbances was known. With a reasonable knowledge of inflow variations, it may at least be possible to design away from these adverse characteristics. The available current experimental inflow data are not adequate to permit a thorough evaluation of existing theories. With the exception of the hovering condition, therefore, only a limited amount of material has been published about the correlation between inflow theory and experiment. Since no force and moment data for offset-flapping-hinge rotors were available, a study was undertaken by the Massachusetts Institute of Technology, under the sponsorship of the NACA.

Inflow distributions, azimuth and spanwise, were determined analytically from measured pressure distributions and blade-motion data on a model helicopter rotor blade under hovering and simulated forward-flight conditions. Pressures and corresponding blade flapping were recorded for various rotor conditions at tip-speed ratios of 0.10 to 1.00. Covered in this study are one-bladed-rotor operation effects, deliberate blade stall, data on the effects of cyclic pitch, and tests on a rotor with a 13-percent-offset flapping hinge. Since the offset-flapping-hinge rotor was used primarily as a means of alleviating stall in order to obtain inflow data at high tip-speed ratios, μ , in the vicinity of 1.0, no cyclic pitch was used to balance out the hub moments resulting from the incorporation of offset hinges. It is these moments which are the primary source of stall alleviation. The inflow plots presented in Technical Note 3492 indicate variations very different from the uniform distributions which are sometimes associated with a rotor disk. An extensive investigation of the $\mu = 0.30$, zero-offset rotor condition showed that larger inflow variations than those predicted by theory can exist. In addition, however, upflow over the forward portion of the disk and relatively large induced velocity at the trailing edge are verified. The inflow patterns for the zero-offset and 13-percent-offset rotors under the same conditions of operation, except for the presence of hub moments in the offset-hinge case, are found to be very different in general character.

Document 5-43 (I), Excerpts from Annual Report of the National Advisory Committee for Aeronautics (Washington, DC), 1946-58, "Rotary Wing Aircraft," Annual Report (1957), pp. 25-26.

VIBRATION

One of the major operational problems associated with current helicopters is the high vibration level. In addition to seriously limiting the life of some major and expensive components, the vibration induces severe pilot fatigue after only a short period of flying time. In order to study this problem of vibration considerable effort has been applied to determine the sources of the aerodynamic loads which excite them. Various flight and wind-tunnel tests have been conducted in which rotor-blade vibratory stresses and fuselage vibrations in a number of steady and maneuvering flight conditions have been measured. The results show that the coupling effect between the fuselage and rotors, which is often neglected or else treated by unproven theoretical methods, can produce an important shift in resonant frequency. The method developed during the flight investigation should prove a satisfactory means for "flight-test checking" of helicopter prototypes for coupled frequency effects on vibration. In addition, the measurements are being used to establish more satisfactory theoretical treatments which should help designers to alleviate the vibrations at the sources.

A better understanding of the basic aerodynamics of the rotor airflow is a prerequisite to the development of more efficient helicopters. Since the characteristics of the flow field change with each flight condition, theoretical treatments of helicopter characteristics are very difficult and time consuming. Using previously obtained rotor flow-field measurements as a guide, analytical work has been continued in an effort to provide methods for more accurately predicting the induced flow. These studies have included the effect of tip-speed ratio and the use of non-uniform blade loadings which were not included in previous work. Automatic computers have been used to compute rotor blade motion, rotor blade airloads, rotor thrust and power, longitudinal and side forces, and certain stability derivatives. The computational setup is general and the equations can be used for blades of any airfoil section, mass distribution, twist, planform taper, root cutout, [and] flapping-hinge offset, and can account for the effects of pitching and rolling velocities. Stall and compressibility effects can be predicted, as well as the effects of the reversed flow occurring over part of the retreating blade. The use of high-speed computing equipment has enabled the rapid solution of very detailed equations in which no simplifying small-angle limitations need be made regarding inflow angles, angles of attack, or flapping angles.

Experimental work has supplied information relating to the aerodynamic interference between the rotor and other components, a problem that has become more important in view of the trend toward increased rotor blade loadings and

convertiplane arrangements involving airplane-type lifting surfaces. An investigation of the effects of a rotor slipstream on a panel representing a wing mounted below a hovering rotor has indicated that the vertical drag[,], that is, the loss in thrust due to blockage of the rotor slipstream, can be calculated with good accuracy. Various span panels were located at varying distances below the rotor and both steady and pulsing pressures on the panels were measured.

PERFORMANCE

Current helicopters are limited in top speed by the compressibility drag rise on the advancing blade which causes large increases in the power required for flight at high speeds. In addition to analytical work on the problem of reducing the effects of compressibility, the problem has also been attacked experimentally. Using rotors varying in thickness from 6 to 15 percent of the blade chord, investigations have indicated that significant gains in high-speed performance can be achieved with little loss in efficiency. One important objective of this continuing project is to accumulate a sufficiently wide range of airfoil section data at suitably matched angles of attack and Mach numbers for design information related to high tip speed rotors.

STABILITY AND CONTROL

Full utilization of the helicopter requires a true blind-flying capability, which in turn has been reflected in continued effort toward a fuller understanding of the factors influencing helicopter stability and control characteristics and flying and handling qualities. Research conducted by means of flight tests has been concentrated on the important problem areas of low-speed flight, steep approaches, and vertical landings, in order to determine the effect of changes in various stability parameters on pilot proficiency. Specialized piloting tasks such as hovering over a fixed spot or executing a low-speed instrument approach have been included. Being considered also is the relative importance of improved instrumentation for the pilot in conjunction with improved helicopter stability for instrument flight. Low airspeed flights, including efforts to hover over a ground reference, are being conducted under simulated instrument conditions with an HO3S-1 helicopter equipped with electronic autopilot-type components which permit alteration of the apparent (to the pilot) stability and control characteristics of the helicopter. By means of these components, systematic variations in such parameters as control power[;] damping in roll, yaw, and pitch[;] and stabilization about each axis can be evaluated. In order to insure adequate coverage in the present investigations a current production helicopter with stability augmentation equipment (HSS-1) has been flown and appropriate data published. The first results show that significant improvements in flying qualities can be obtained with automatic stabilization equipment, particularly with yaw stabilization.

PROPULSION

Various design studies by the military services and industry have indicated that propulsion devices mounted on the rotor blade tip would be suitable for very large, short range helicopters. Such systems employing pulse-jet and pressure-jet propulsion devices have been tested on the Langley helicopter tower. Pressure-jets may be either cold cycle[,] in which the working fluid, usually air, is ducted through the blade and no burning of fuel occurs at the rotor blade tips; or hot cycle, in which burning does occur at the tip. The results of a preliminary experimental program on a pressure-jet rotor using both cold and hot cycles have been published, as well as a set of design charts derived to facilitate rapid analysis of compressible flow properties in a whirling duct. In general, the hot cycle system showed about double the ratio of rotor propulsive horsepower to equivalent compressed-air horsepower of the cold cycle but resulted in a significant increase in specific fuel consumption. The analysis of the flow in a whirling duct presents in chart form the internal aerodynamics of a pressure-jet rotor blade. Also in conjunction with this project, an analytical study of the hovering performance of various helicopter propulsion systems has been completed and the results presented in the form of charts for estimating hovering over endurance.

Document 5-43 (m), Excerpts from Annual Report of the National Advisory Committee for Aeronautics (Washington, DC), 1946-58, "Rotary Wing Aircraft," Annual Report (1958), pp. 44-45.

PERFORMANCE

The extension of basic rotor theory in accordance with anticipated state-of-the-art changes has been a continuing process. Current efforts relate primarily to clarification of rotor force and blade-flapping phenomena for the severe flight conditions brought about by the considerable increases in installed power which are evident in new designs. This work utilizes published numerical procedures, in conjunction with electronic computers and full-scale experimental setups.

Limitations of helicopter speed due to retreating blade stall have been largely based on pilot reactions to roughness caused by the blade stall. A technique has been developed whereby the beginning of this blade stall can be detected readily under high forward-speed conditions. This is accomplished by monitoring blade-pitching moments and power input so that blade stall can occur to a measurable but not catastrophic degree. As a consequence, it has been possible to establish the allowable increase in forward speed for a rotor of a tandem helicopter resulting from a change in blade-section from a symmetrical to a cambered section. A 20- to 25-percent increase in forward speed at the same weight or a 15-percent increase in gross weight appears possible.

Investigations are in progress to determine the static aerodynamic characteristics of helicopter rotors operating at tip speeds [of] up to 900 fps. The effects of centrifugal forces on the rotor-blade boundary layer, tip flow field, and varying stall or compressibility areas over the rotor in forward flight are also being studied. Rotors having a wide range of blade-thickness ratios, thickness form, and leading-edge radius have been tested. These investigations have resulted in successful attempts to "synthesize" airfoil data from rotating rotor tests. Such data are expected to provide greater accuracy in the calculation of the forward flight characteristics of rotors operating at high tip speeds.

VIBRATION

As helicopters have become larger and more flexible, the magnitude of the vibrations associated with them has increased. The use of the helicopter for longer military missions and the increasing use of helicopters in civil applications have made the present vibration levels an increasingly serious matter. The designer is frequently unable to predict vibration sources and to provide methods of alleviation.

As a result of the increasing importance of this problem, a flight investigation was made to measure the vibration encountered by a specially equipped tandem helicopter. The first phase of the project involved the development of a method for measuring rotor blade fuselage-coupled frequencies in flight. The technique involved the use of a mechanical shaker mounted in the helicopter. The results indicated that the method developed would provide a satisfactory means for flight testing of prototype helicopters for coupled frequency effects.

The project was extended to include the measurement of relative aerodynamic inputs for several flight conditions, of vibration effects due to blade out-of-track, and flight vibration mode shapes, through use of magnetic tape data recording. Vibration was only slightly increased when the blade out-of-track was less than 1 inch. However, as the out-of-track increased to slightly over 2 inches, the vibration became nearly intolerable. These efforts have not resulted in a state of knowledge which will permit satisfactory prediction and reduction of helicopter vibrations; however, use of the research technique holds promise for the attainment of this goal.

STABILITY AND CONTROL

Stability and control studies utilizing a variable-stability helicopter have succeeded in determining the degree of improvement attainable by increased damping and control power during instrument-flight landing approaches.

Low airspeed flights, including efforts to hover over a ground reference, have been conducted under simulated instrument conditions with a single-rotor helicopter having electronic autopilot-type components which permit alteration of the apparent (to the pilot) stability and control characteristics of the helicopter. By

means of these components, systematic variations in such parameters as control power, damping in roll, yaw and pitch, stick force gradient and stabilization about each axis can be evaluated singly or in combination. The results confirm earlier work showing that improvements in handling qualities result with increases in damping. Also there is a large range of damping values within which desirable control powers are independent of the damping. However, as the damping is increased, the allowable maximum control power tends to increase.

A device that supplies signals to the pilot's instruments to indicate helicopter position and rate of change of position with respect to a ground reference, as well as helicopter altitude over the ground, has been constructed. The purpose of the device is to permit hovering on instruments so that handling qualities in hovering may be investigated. An additional device is also being constructed which will provide position and rate signals to the pilot in the form of stick forces.

Current efforts to assist in modernization of military flying qualities specifications for helicopters serve to emphasize both the value of the damping and control-power work completed and the need for more information; for example, how to apply the results established for helicopters of typical size to size extremes which can range from 250 to 100,000 pounds gross weight. As one step in learning possible effects of size, and also the effects of gross changes in the ratio of rotor inertia to aircraft inertia, brief tests have recently been completed with a tip-jet-driven helicopter of far smaller size but of higher relative rotor inertia than any previously tested. Certain beneficial effects related to high rotor inertia were readily apparent and led to additional comparative tests with more typical designs. Correlation of these results with those obtained with other larger helicopters is continuing.

Document 5-44 (a-b)

(a) John P. Reeder and F. B. Gustafson, “Notes on the Flying Qualities of Helicopters,” presented at the annual meeting of the American Helicopter Society, 22–24 April 1948, copy available in Technical Library, NASA Langley Research Center, Hampton, VA.

(b) John P. Reeder and F. B. Gustafson, “Flying Qualities of Tandem-Rotor Helicopters,” *Aero Digest* (May 1953): 103–109.

Having already set up requirements for the satisfactory flying qualities of airplanes, the NACA moved quickly after the appearance of the first practical helicopters and the end of World War II to extend this work to cover the helicopter. As these two papers by NACA researchers John P. “Jack” Reeder and Frederic B. Gustafson indicate, the NACA began conducting flight research with helicopters in the middle of 1944 in a program involving one of the Navy’s single-rotor Sikorsky R-4s (U.S. Navy designation HNS-1, Bureau of Aeronautics No. 39034). For the next four years, the NACA flew the R-4 through an exhaustive series of tests, trying to understand the machine and find ways not only to improve what NACA Langley test pilot Jack Reeder felt were generally poor handling qualities but also to define what stability, control, and handling qualities were desired. By 1948, when the first of these two reports came out, many groups at NACA Langley were busy on helicopter research. Besides Reeder, Gustafson, and other members of Langley’s Flight Research Division, the work involved personnel in the Full-Scale Tunnel, the Free-Flight Tunnel, and the lab’s vibration and flutter group; many structures people; and the staff of the NACA’s new helicopter test tower.

In the second document in this group, the reader will learn more from Reeder about the NACA’s postwar helicopter research. Here we would like only to add a reference about his coauthor, Frederic Gustafson. In *Helicopters Before Helicopters*, E. K. Liberatore ranks Gustafson with the most important “pioneers who were instrumental in creating rotary wing flight in America”: Sikorsky, Young, Piasecki, Hiller, and Charles Kaman. In his view, “special mention” should be given to Gustafson and to the organization for which he worked “for contributing the theoretical and practical base for today’s helicopters.” Liberatore believed that if the kind of information presented in papers written by Gustafson particularly, and in combination with those of other NACA researchers like Jack Reeder, had “existed a century ago[, it] would have spared many of the pioneers...their fruitless groping for a solution” (p. 153). One can hardly imagine a stronger testimony on behalf of the NACA’s early and active involvement in the development of the helicopter.

*Document 5-44 (a), John P. Reeder and F. B. Gustafson,
“Notes on the Flying Qualities of Helicopters,” presented at the
annual meeting of the American Helicopter Society, 22–24 April 1948.*

Introduction: It has been suggested in the past that flying a helicopter is a new and different art. In its present stage of development the helicopter is different and more difficult to fly than most airplanes. The difficulty seems to arise from three sources: the helicopter has one additional control (collective pitch) to be operated; the power controls (collective pitch and throttle) must be used almost continuously in conjunction with the flight controls during operations near the ground, chiefly because of the rapid variation of power required with airspeed in the speed range normally used in these operations; and, the helicopter has undesirable stability characteristics in forward flight which would not be acceptable in an airplane. Hovering flight also introduces a new and unique problem which is, however, somewhat analogous to formation flying with airplanes.

The NACA has long been vitally interested in stability and control problems and in setting up requirements for the satisfactory stability and control characteristics for airplanes. We are now in the process of extending this work to cover the case of the helicopter. It is recognized that airplane requirements may not be applicable to helicopters in a specific manner but, nevertheless, the underlying reason for setting up the requirements applies to both airplane and helicopter. We feel that sooner or later the helicopter is going to have to meet requirements parallel to those for the airplane in order to reach its potential capabilities.

During the past several years rotor performance tests have been conducted at the Langley Laboratory using a Navy HNS-1 (Army YR4) type helicopter. The rotors flown during this period differed in solidity, airfoil section, twist, and blade-surface rigidity. During the course of these tests attention was drawn to certain stability characteristics of the helicopter which have long been considered unacceptable for airplanes. Also, some interesting control characteristics and flight regimes were revealed, and some very limited measurements of stability and control characteristics were made during this time. Recently, moreover, the status of the performance work was such that it was convenient to install instrumentation to get more detailed information on flight characteristics. The results obtained with this instrumentation are not sufficiently complete for detailed presentation, but the work thus far, along with other material, has aided in formulating the ideas presented in this paper. The views given reflect experience with other helicopter types, knowledge of British tests, and information from translations of German papers. A further valuable source of experience concerning the characteristics of the helicopter in maneuvers has been afforded by pull-up tests for load factor determination, which tests have been made by the CAA with the assistance of the NACA. With this background, it is felt that the present paper may help to indicate the most fruitful lines for immediate study.

Longitudinal Stability in Forward Flight: During the course of the performance tests, considerable flying was done at relatively high speeds, approaching the limits imposed by blade stalling. It was found quite difficult to hold steady conditions because of a strong tendency of the machine to diverge in pitch, creating the impression of balancing on a ball. This characteristic seemed far more pronounced with some of the rotors tested than with others, but was always troublesome. Upward pitching was most troublesome as it frequently precipitated or intensified stalling, which added to the difficulties because it increased the tendency to pitch up and was accompanied by rather violent periodic stick forces and vibration. The forward displacement of the control from trim necessary to check some of these pitching motions suggested that a short delay in applying corrective control would allow a maneuver severe enough that control would be lost. Although there seemed ample control to stop downward pitching, an uncomfortable amount of forward control was again required in order to check the subsequent upward pitching. These characteristics suggested a pronounced type of instability.

The tendency to depart from the trim speed and the necessity of applying appreciable control deflection against a pitching maneuver involving acceleration, initiated either by control or by external disturbances, is apparent throughout the speed range normally used in forward flight. It becomes much less pronounced, however, at the lower speeds.

Shortly after the embryo pilot experiences forward flight, he is impressed with the necessity for having to constantly fly the helicopter. At first thought the reasons for this situation are not clear. It is common knowledge that a flapping rotor tilts to the rear if speed is increased, thus tending to cause the machine to return to the original speed. This condition constitutes stability of the rotor with respect to speed. Wind-tunnel tests of the R-4 fuselage have shown it to be unstable, but this instability is evidently outweighed by the rotor stability just discussed, inasmuch as measurements of stick position have shown that the stick does move forward to trim at increasing steady speeds. Furthermore, observation and measurements have indicated that the static stick-force gradient with respect to speed is small, but has been either unstable, neutral, or stable, depending upon the pitching moments of the particular blades and upon the bungee configuration, without greatly altering the pilot's overall impression of instability. The source of the difficulty, therefore, cannot be either stick-fixed or stick-free instability with speed.

The somewhat obvious conclusion is that the pilot's impressions are a result of the helicopter's instability with angle of attack. There are at least two logical sources for its instability with angle of attack. The first results from the flapping of the rotor. If the helicopter rotor is subjected to an angle-of-attack change in forward flight, then for constant rpm the advancing blades are subjected to a greater upward accelerating force than the retreating blades because the product of angle-of-attack change and velocity squared is greater on the advancing side. The resulting flapping motion will then tilt the disk in the direction of the tip-speed

ratio and becomes more pronounced at higher speeds. The second source is the unstable fuselage.

It may be well to point out here that airplanes can and do exhibit instability with angle of attack at times, but this condition is recognized as unsatisfactory and is generally prevented by keeping the center of gravity sufficiently well forward.

The effects of the instability with respect to angle of attack on the flight characteristics of the helicopter were subsequently investigated in more detail, first in the low-speed flight range and then at successively higher speeds. It was found that in maneuvers in which the stick was abruptly deflected from trim and held, the normal acceleration built up at an increasing rate for a length of time detectable to the pilot. Furthermore, the acceleration and pitching velocity, at least for small stick deflections when the maneuver could be continued for a reasonable time, did not reach a maximum until 3 or 4 seconds had elapsed. The acceleration and pitching velocity in this type of maneuver apparently would continue to increase for even greater periods of time were it not for the stabilizing influence of the associated speed change. The stick forces accompanying these maneuvers are undesirable. After transient effects have disappeared they become somewhat unstable; that is, a push in pull-ups or a pull in push changes the magnitude of the forces depending upon blade characteristics. Of course it is highly desirable that these forces be stable.

Longitudinal Oscillations: Stick-fixed longitudinal oscillations of the HNS-1 were studied to shed more light on the interaction of the stability with speed and stability with angle of attack. Studies have been prepared of two recorded time studies of attempted stick-fixed oscillations. For these cases the helicopter had a set of experimental blades of low solidity, not production blades. Low solidity necessitates higher pitch of the same rpm and thus stalling was encountered [for] fewer forward speeds than for the production blades.

The first slide (Figure 1 [*not reproduced*]) shows an oscillation initiated from steady level flight at 40 miles per hour by a momentary aft motion of the stick. The type of motion shown resembles the airplane phugoid motion in that changes in airspeed and altitude occur, but there is the important difference that definite changes in angle of attack take place. The period of the motion is about 14 seconds, which is long in that the pilot does not have trouble controlling the oscillations. The motion doubles in amplitude in one cycle. During the third cycle it reaches 25° up from the trim attitude and shows successive increments in acceleration, from about +.4g and -.3g. This maneuver was terminated when the attitude and the rate of change of attitude, acceleration, and speed were such as would cause the pilot apprehension.

The next slide (Figure 2 [*not reproduced*]) shows an oscillation attempted from steady level flight at 65 miles per hour. Again the helicopter was disturbed by an intentional [stic]k motion, after which the stick was held fixed. The helicopter nosed up mildly and then nosed down. The helicopter was still nosing down at an

increasing rate, as the acceleration curve indicates, at about $9\frac{1}{2}$ seconds or about 4 seconds [afte]r the 1g axis was crossed and recovery had to be made by control application. Immediate response to aft control was obtained, but notice that as 1g was reached the control was not only back to the trim position but was moving rapidly forward to check the acceleration which was building up at a high rate. The control reached the forward stop about 2 seconds before the acceleration reached its peak of 1.7g. The time history does not tell the whole story, however, for during this maneuver as the stick approached the forward stop the collective pitch was reduced to about 6° to reduce the acceleration and the associated blade stalling. The "rpm" went above the placard limit. Also, as the horizon disappeared from the pilot's view, the machine was rolled for recovery as in a wing over. Needless to say, this maneuver was a little disturbing to the pilot.

Comparison of these two histories indicates the marked influence which speed has on the instability with angle of attack and hence on the difficulty of controlling the aircraft. In order to bring out this trend with speed more clearly[,] additional oscillations and flight in mildly gusty air were made to provide more points in the speed range. To obtain greater generality we used different rotor blades on the same helicopter and also utilized a later model helicopter of basically similar design. In all cases the time required with controls fixed to reach a dangerous flight condition following the first definite nose-down motion was noted. For the cases where we had relatively complete instrumentation we found that at the flight condition considered dangerous, the increment in normal acceleration from the 1g condition that had been reached was usually about $\frac{1}{4}g$, regardless of forward speed. The acceleration increment appears to be a much better criterion for the flight condition at which recovery must be started than is the more commonly discussed attitude angle. The value of $\frac{1}{4}g$ mentioned for this increment probably corresponds to the particular helicopter under test and may be expected to vary with the size and other characteristics of the helicopter. The results of the measurements that have been made are summarized on the following slide (Figure 3 [*not reproduced*])). Here the increment in acceleration per unit time is shown plotted against airspeed. The ordinate values were obtained by taking the reciprocal of the values of time to reach a dangerous flight condition, which, as has been pointed out, corresponded to a reasonably fixed acceleration increment of about $\frac{1}{4}g$. Thus, the higher the value shown, the more frequently the pilot has to apply control to maintain steady flight. To look at it another way, if corrective control is applied at given intervals, then the higher the value shown, the greater the amount of corrective control required.

It is interesting to note that from about 40 miles per hour to 50 or 60 miles per hour the values shown are relatively low. In this region the helicopter can actually be made stable by relatively simple means, and in any event it requires relatively little attention from the pilot. At the higher speeds the attentiveness required of the pilot rises rapidly. Correspondingly, many methods of improving the stability

characteristics which could readily be made to function satisfactorily at low speeds will offer greater difficulty or may even become inadequate at these higher speeds.

It will be noted that a peak is shown at about 30 miles per hour. In this range if the controls are fixed the helicopter will soon nose up, slow down, and slide backwards with resulting yawing motions and control difficulties.

Observations Particularly Concerning Hovering: Thus far only the forward flight characteristics have been discussed. Hovering, of course, precedes and follows all forward flight and is the outstanding reason for the existence of helicopter types. We feel, however, that at present the problems associated with hovering in this particular type are more indefinite than in forward flight, that they tend to disappear with a little flight practice, and that they don't affect its general utility to the extent that limitations on night and instrument flying do.

One of the problems which the trainee must overcome in a helicopter of this type and size is the high control sensitivity in roll or the high rate of roll per unit stick displacement. This sensitivity can lead to over controlling which results in a short-period, pilot-induced lateral oscillation. It is caused, apparently, by the pilot's lag in removing control following response of the machine. The result can be likened to what occurs with an auto-pilot having improper follow-up. It might be well to point out here that with constant ratio of control stick displacement to cyclic feathering the rolling velocity obtained will vary inversely as the diameter, or, the smaller machine will roll the faster. Thus sensitivity becomes less of a problem with larger machines.

The forces the pilot encounters in deflecting the stick can accentuate or minimize his impression of the sensitivity. The pilot should first be able to trim steady forces to zero. He should also have a force gradient opposing displacement of the stick in order that he can properly judge the control being applied. The control force gradient centers the stick when it is released, reducing the lag in the follow-up process and reducing the required pilot effort. With one set of blades on the R-4 the lateral gradient was satisfactory, but with other blades peculiar characteristics appeared. In some cases the initial force change with deflection was proper but the force returned to zero or even reversed as rolling velocity developed. From the pilot's standpoint this is very undesirable. The following slide (Figure 4 [*not reproduced*]) illustrates the character of the lateral forces immediately following stick displacement for two different rotors. Rotor A illustrates the type of transient force variation considered unsatisfactory, while the force variation for rotor B was considered acceptable.

It is interesting to note at this time that the longitudinal forces immediately following abrupt stick displacement differed in character from the lateral forces. These are shown on the next slide (Figure 5 [*not reproduced*]). In this case neither rotor A nor rotor B showed acceptable characteristics, although the pilot reported the characteristics of rotor A noticeably inferior to those of rotor B.

In another case abrupt stick motions were found to cause forces perpendicular to the direction of motion which tended to whirl the stick in the direction of rotor

rotation. The stick would go to full deflection in a spiral motion if released. The forces for restraint of the stick became higher the more rapidly the stick was moved. In a case like this[,] over-control results because the pilot fights the forces.

No less important in promoting over-control is high control friction. Friction prevents accurate positioning of the control because of the extremely non-linear force gradient it provides for small deflections and because the control tends to jump as static friction is broken. Furthermore, it prevents self-centering of the control, consequently poor follow-up and an increase in the required pilot effort. Fortunately, the control difficulties imposed by high sensitivity, undesirable forces, and friction can be greatly lessened with relatively little practice. Friction, however, always increases the demands on pilot effort and is the least susceptible to practice to prevent over-control.

It is interesting that the extrapolation of roll measurements with the R-4 helicopter to full deflection indicates that its maximum rate of roll is as great as that of some modern fighter airplanes at the speeds of their maximum rates of roll. The high rate of roll achieved with the helicopter is apparently due to low damping, and not to high control power, as the moments developed about the center of gravity are always relatively small. Computations of the damping indicate that it is a fraction of that for airplanes. The low damping in itself is not particularly noticeable to the pilot. Computations of overshoot following the centering of the controls from high rates of roll indicated large values, but in trials made at 40 miles per hour none was noticeable to the pilot. In hovering, both pilot observations and instrument measurements have indicated that the tendency to overshoot, while presumably there[,] is secondary to the effects of the stability with speed which enters as a result of the lateral motion acquired. Apparently, the lateral velocity can, depending on the details of the maneuver, either cancel or add to the tendency to overshoot.

There used to be much description of the control response of this and similar helicopter types in terms of lag. Actually the control lag, as defined by the time necessary for the rotor to reach a position corresponding to any specified stick position during steady motion of the controls, has been found to be less than .1 second for the R-4 rotor, a time period too short for perception by the pilot. Correspondingly, after the stick reaches its position following an abrupt lateral deflection only about .1 second elapses before the fuselage attains maximum angular acceleration in roll. Years of airplane experience indicate this to be a satisfactory response; in fact, the airplane requirements allow .2 seconds. It may be noted further that the helicopter approaches a steady rate of roll in about the same time as does an airplane. The impression of lag when hovering over a spot, therefore, seems to arise from the fact that velocity changes or displacement of the helicopter in space do not follow the inclination of the thrust vector immediately, because of the mass of the machine. A similar example occurs in airplane formation flying where the problem is to control the rate of closure. The pilot overcomes his first impressions of lag during training by quickly learning to control the helicopter's accelerations.

Also, in hovering the machine drifts back and forth as a result of the motions of the air. Some drift has to be expected of any flying machine since it is supported by the air. The stability of the machine with respect to speed and the directional stability in connection with yawing motions, both of which are desirable in other respects, increase the tendency to move or yaw with changing wind velocity or direction. It follows that in this respect, reduction of stability can be beneficial.

It has been found that, in hovering, control-fixed lateral and longitudinal oscillations build up rapidly in amplitude per cycle. Since the machine performs an oscillation there is a restoring tendency following a disturbance due to stability with speed. The restoring tendency itself is beneficial, provided the period of the motion is long enough to allow for the pilot's reaction time in perceiving and correcting the motion. The longitudinal period for the R-4 was found to be about 14 seconds, while the lateral period was about 6 seconds, considerably shorter. From accumulated aircraft experience and personal experience with the R-4 and some other helicopter types the period of the lateral motion is considered great enough to completely eliminate it as a control problem.

Isolated Flight Phenomena: Early in our performance work we encountered a phenomenon in connection with vertical flight. In determining power required at zero airspeed with varying rates of descent a region was encountered where control of the machine could not be maintained. The descents were entered from forward flight with fixed power and when zero airspeed was reached the rate of descent was low. If the power was insufficient to maintain less than 500 ft. per minute descent (as indicated by a standard rate of climb indicator) the machine would slowly increase its vertical velocity. At an indicated value of about 500 ft. per minute rate of descent, shaking of the machine became quite pronounced. Rather violent, random yawing motions would then occur with some roll, the rate of descent would apparently increase rapidly, the rpm would vary noticeably, and more often than not the machine would eventually pitch nose down and recover by gaining speed, despite application of considerable rearward control. Many variations in this behavior occurred depending, apparently, on small horizontal velocities and on power conditions. In some cases similar shaking of the machine was encountered at indicated rates of descent of only 300 ft. per minute. The loss of control appeared most severe when the power was as high as possible but would yet permit the required rate of descent. As power was progressively reduced during successive trials the difficulties were reduced to the point where no trouble was encountered for the power settings permitting steady descents of about 1500 ft. per minute and higher. These descents were always performed with a margin of altitude and no difficulty was ever encountered in recovering at any stage desired.

The yawing motions and inadvertent recovery mentioned earlier are quite probably the result of rearward velocity. Nevertheless, it appears that the fundamental cause of the phenomenon is an irregular flow of air through the rotor. In hovering, a definite downward flow of air through the rotor occurs, and in completely

power-off descent an upward flow of air through the rotor takes place; but in this intermediate condition the air tends to move with the rotor. It seems logical that when the air attempts to stay with the rotor, it might actually mix in turbulent and erratic fashion with the air outside the rotor disk. Motion picture studies of tufted blades during some of these cases have shown no stalling, but have shown pronounced but irregular blade bending. The presence of this irregular bending tends to support the irregular flow explanation, but there is yet much to be learned about this regime of operation.

Another phenomenon has been encountered following take-off. The machine was being accelerated rapidly horizontally from hovering and at 20 to 30 miles per hour it pitched up abruptly. In several cases control against the forward stop was required for a short interval of time to check the motion. This same tendency has been noticed in other helicopters. Normally, the horizontal acceleration is low enough that full control is not required. This characteristic may be due to the dynamic stability characteristics in pitch and to the rapid entry into the higher speed range. It should be looked into, however, as a possible critical condition in determining the required control range.

The preceding notes have attempted to point out some of the stability and control characteristics as we have found them for a particular helicopter type. They appear to be applicable to other types, however, in whole or in part.

Discussion of Possible Solutions: Basically, flying qualities studies are made in order that the characteristics most in need of improvement may be clarified, and, in turn means may be found for achieving these improvements. It, therefore, seems in order to discuss a few examples of the lines of development which are suggested by the evaluation of flying qualities which has been given.

We feel that the problem which most urgently needs investigation is the instability with angle of attack. One proposed solution to the problem is to provide stick forces in the proper direction, or stick-free stability. This means that in maneuvers at constant speed pull forces are required to hold constant positive acceleration and push forces to hold negative accelerations. This solution does not alter the fact that the control moves in the wrong direction as the maneuver develops. Stick-free stability is considered to be essential for a completely satisfactory solution, but not in itself sufficient. First, the stick is never actually free because of friction; also, the pilot imposes some restraint on the stick, either consciously or subconsciously, because the stick will tend to move noticeable amounts as it attempts to counteract the stick-fixed instability. Secondly, and most important, the stick-free stability does not alter the fact that maneuvers (either intentional or due to gusts) can be severe enough that insufficient recovery control exists.

If the machine could be provided with stick-fixed stability with respect to angle of attack the danger of loss of control would be virtually eliminated, and friction or pilot restraint of the stick would not affect the machine's tendency to maintain steady flight. Maneuvers could be executed without reversing the stick motion, and

recovery could be made by simply returning the stick to the trim position. Stick-free stability could be provided in this case by mechanical means such as simple springs.

Since the instability with angle of attack arises as a result of forward speed, and is greatest at the highest speeds, it seems logical to attempt to obtain the desired stabilizing forces by using some form of horizontal tail surface mounted on the fuselage. This is particularly valid, of course, for the over-coming [*sic*] of the instability of the fuselage itself. For the rotor instability, it seems basically more logical to arrive at a self-contained means for eliminating its instability, but it further appears that the more practical immediate solution may nevertheless lie in the use of some form of horizontal tail surface. Preliminary calculations indicate that [a] rather small tail area should suffice; for example, calculations for a sample two-place helicopter indicated that about 4 square feet would be needed to stabilize the fuselage, and that an additional area of about 4 square feet should serve to stabilize the rotor.

One obvious disadvantage resulting from the use of the tail surface lies in the undesired vertical loads and pitching moments developed in hovering and vertical flight. For the areas mentioned these forces are actually quite small but may be further reduced if desired by using a bi-plane tail surface, thus presenting less projected area in vertical flow, or by using a free-floating tail surface arranged to be effective only in forward flight. More serious problems arise from the fact that in forward flight, a change from level flight to climb or to autorotation results in a sizeable change in angle of attack of the tail surface. This change occurs because the attitude angle of the helicopter remains roughly constant while the flight path angle changes. This situation suggests that for the faster and more highly-powered helicopters, at least, the tail surface should be made to move in conjunction with the pitch controls or should be made free floating.

These problems, and in addition a number of details concerning the rotor downwash, need further clarification before the helicopter designer can be expected to make full use of the tail surface as a cure for the angle of attack instability.

It should also be possible to improve the hovering characteristics. Control sensitivity could be reduced by changing the control-system gearing, but this is undesirable because it would limit control available for trim unless a nonlinear system were used. It would seem logical, though, to provide the pilot with a stick-force gradient which is suitably proportioned to the control sensitivity. It is interesting to note that in this regard the effects of size tend to be contradictory. In other words the smaller the helicopter the greater its control sensitivity but the smaller the force gradient is likely to be, and vice versa, whereas the greater sensitivity should be accompanied by a larger force gradient.

Also, control sensitivity could be reduced by increasing the damping which would reduce the rate of roll. One way of doing this involves increasing the control lag by changing the rotor characteristics. Control lag, however, should not be increased to more than perhaps 3 or 4 times that of the R-4 type, or more than perhaps 0.2 to 0.3 seconds, as it may lead to over-controlling of a different type

than mentioned previously and one which is more dangerous because of larger amplitude. It would be better to increase damping without changing lag.

Friction in the control system should be kept to a minimum or to a value which will permit good self-centering characteristics.

To reduce the tendency of the machine to react to horizontal gusts in hovering, the stability with speed could be reduced as by the use of a linkage such that flapping causes corrective feathering.

Concluding Remarks: It is hoped that the discussion given may have succeeded in clarifying the currently outstanding flying qualities problems. It is felt that these problems are open to solution, and that continued effort on the part of all concerned will result in rapid progress.

*Document 5-44 (b), John P. Reeder and F. B. Gustafson,
"Flying Qualities of Tandem-Rotor Helicopters,"
Aero Digest (May 1953): 103-109.*

Tandem qualities of tandem-rotor helicopters are being studied by the National Advisory Committee for Aeronautics as part of a broad program of helicopter research at Langley Aeronautical Laboratory, near Hampton, Virginia.

The chief aim of this study, according to NACA officials, is to assist the U.S. Navy, Air Force, Army, Civil Aeronautics Administration, and helicopter manufacturers in the formulation of handling qualities standards appropriate for tandem-rotor machines. A secondary aim is to obtain scientific information which might be used by designers to improve the flying qualities of any tandem helicopter. The military services, it is understood, are very much interested in the project.

The flight tests are being conducted at Langley Laboratory under direction of Melvin N. Gough, chief of the Flight Research Division, and Frederic B. Gustafson, the NACA's top specialist in rotary wing research. Kenneth B. Amer, an aeronautical research scientist in the flight research division, is project engineer in the tandem helicopter investigation.

Several months ago, the Bureau of Aeronautics loaned NACA a Piasecki HRP-1 twin-rotor helicopter (nicknamed "the Flying Banana") for use in this study. Test data obtained in flights with the HRP-1, it is expected, will be applicable to any tandem helicopter. This particular machine has not been singled out for study, but serves merely as an example of a twin-rotor type for test purposes.

The Navy's requirements for helicopter flying qualities—sometimes called handling qualities—were established two years ago, with the assistance of NACA. "The current study of flying qualities," said Gough, "will show whether the military standards for flying qualities can properly be applied to a helicopter with two rotors." The present standards, which specify certain limits for acceptable performance in the helicopter's response to controls, were based primarily on studies of single-rotor machines such as those manufactured by Sikorsky and Bell. We

will check on the applicability and adequacy of these requirements. If we find they cannot be applied to a tandem helicopter, we will recommend some new or modified standard.

Stability and control of the tandem helicopter are being investigated carefully. One characteristic noted in the test machine, Mr. Gough said, is insufficient directional stability—a tendency to yaw too much if disturbed from steady flight. “Probably one incidental result of our work,” he remarked, “will be an appraisal of the specific flying qualities of the test helicopter, with suggestions for improving this type.”

The Flight Research Division is not the only group engaged in rotary wing research at Langley Laboratory. The full-scale wind tunnel devotes one-third of its time to investigation of the fundamentals of flow, performance, and stability of various rotor configurations. Both jet rotors and conventional rotors are tested on the outdoor helicopter tower. The vibration and flutter branch, structures laboratory, and free-flight tunnel also contribute to the many aspects of helicopter flight.

CURRENT TESTS

For the current tests of stability and control and handling qualities, the large tandem helicopter has been equipped with NACA recording instruments that occupy the rear end of the roomy cabin. These automatic instruments have synchronized time scales and measure control position, and normal acceleration. These measurements are recorded as continuous time histories during each maneuver.

Two NACA research pilots, John P. Reeder and James B. Whitten, have taken the HRP-1 up on a series of test flights since it arrived at Langley Field. First, studies were made of the longitudinal characteristics of the aircraft in order to determine the applicability of the Navy’s longitudinal divergence requirement. This requirement, which is based on NACA Technical Note 1983, insures that a helicopter will not have a tendency to diverge rapidly in pitch if it is disturbed from steady flight.

The study consisted of flying the helicopter in various flight conditions (as a convenient means of varying the aircraft’s flying characteristics) and comparing the pilot’s opinions of the longitudinal flying qualities with records obtained by the recording instruments during a special test maneuver called for by the Navy requirement. The test maneuver was a sudden pull-up from steady flight. A mechanical device was used to obtain a fixed amount of control stick displacement during the pull-up.

It was possible to vary the longitudinal stability of the helicopter over an appreciable range by variation of the power and/or center-of-gravity position, there being a reduction in stability with increasing power and aft c.g. position. Correlation of pilots’ opinions with the stability characteristics shown in recorded time histories of the test maneuvers indicated that the longitudinal stability requirements were generally applicable to tandem helicopters.

The tandem arrangement has unique problems requiring detailed study. For instance, the rear rotor operates in the downwash field of the front rotor, thus reducing its lift slope with respect to that of the front rotor. Also, because of increased inflow, the rear rotor operates nearer tip stalling conditions than does the front rotor. These factors tend to reduce the longitudinal stability of the helicopter. On the other hand, stability can be improved with this configuration by positioning the center of gravity of the helicopter forward.

A study is now under way to determine how much static directional stability is sufficient for satisfactory behavior of the tandem, particularly in maneuvers. One factor which makes low directional stability an acute problem for the tandem type is its high moment of inertia in yaw.

As an aid in these stability studies, spring devices have been installed in several of the controls to enable the pilot to center these controls and hold them fixed during test maneuvers. This has been found necessary because of the interaction of controls and inadvertent motions which the pilots find impossible to prevent under flight conditions.

Several methods have been used for varying the directional stability over a broad enough range to determine the minimum satisfactory value. For instance, the stability was found to increase as power was increased and to decrease as power was reduced. Evaluation was therefore made at various power settings. Added power improves directional stability, although it reduces longitudinal stability.

Another method, utilizing a "human autopilot," was tried in an effort to obtain the equivalent of a further increase in directional stability for evaluation purposes. A signal proportional to sideslip angle was fed into an indicator watched by the copilot. Movement of the rudder pedals in a direction to reduce the sideslip angle caused an opposing signal to register on the same dial. When the pilot was ready to perform a typical test roll maneuver, such as abruptly deflecting the lateral control from trim and holding it displaced, he removed his feet from the pedals and the copilot operated his pedals in an effort to keep the needle of the indicator centered. The copilot thus served as an autopilot by keeping the pointer in a fixed position.

The simulated increase in directional stability could be varied quite easily by changing the ratio of the copilot's indicator signal to sideslip angle. This method did not prove entirely satisfactory, however, as the copilot was able to keep the pointer centered for only a short time, because of the rapid variation in sideslip.

A more satisfactory method of increasing the directional stability for research purposes was developed from wind-tunnel tests of a fuselage model. It was found that the directional stability of the fuselage itself could be increased appreciably by adding spoiler strips to the nose of the fuselage. The spoilers consisted of a strip of metal about four inches wide placed around the forward end of the cabin, projecting into the airstream sufficiently to create turbulence instead of smooth flow along the sides of the fuselage.

The reasoning behind this installation is that unstreamlined fuselages are known to be more stable than streamlined fuselages. The static stability has been definitely increased in flight by this method, which has proved satisfactory for the desired test purposes, although it is certainly detrimental from the drag standpoint.

The pilots dubbed this innovation a "horse collar." Surrounding the pilot's greenhouse, it bears a striking similarity when viewed head-on. The horse collar, of course, cuts down the speed of the helicopter in forward flight, and therefore is not a practical modification for military use. It merely serves as an experimental device to vary the machine's flight characteristics for test purposes.

Flight research with the HRP-1 has shown that the tandem configuration aggravates another stability problem. This problem was exposed by studies made in recent years of dynamic lateral-directional stability in airplanes. It has been discovered that product-of-inertia terms in the stability equations, which previously were disregarded, can have important effects on the "Dutch roll" stability of an aircraft under certain conditions. These conditions prevail when the principal axis of the aircraft does not coincide with the flight path and the moment of inertia in yaw is high with respect to that in roll.

In powered forward flight, the helicopter has its principal axis inclined downward with respect to the flight path, a condition in which the product-of-inertia terms are most destabilizing. In addition, the tandem configuration has a high moment of inertia in yaw compared to that in roll, which in the case of an airplane tends to create Dutch roll instability. Further studies of the dynamic lateral behavior of this helicopter, it is believed, may aid in establishing the relative importance of these inertia factors in helicopter stability.

The current study of tandem helicopters, Mr. Gough said, is one important phase of NACA's general study to establish flying qualities requirements applicable to all the practical helicopter configurations. Fundamental investigations of stability and control extend the usefulness of the helicopter by making it safer and easier to fly under broader conditions. Continued flight research, he believes, will eventually enable the helicopter to realize its full potentialities as an all-weathering flying machine.

Document 5-45

**Alfred E. Gessow and Garry C. Myers, Jr.,
“An Introduction to the Helicopter,” chapter 2 in
The Aerodynamics of the Helicopter
(New York: Frederick Ungar Publishing, 1985),
pp. 16–45; first published by Ungar in 1951.**

After going through three editions as well as translations into several different languages, College Park Press of the University of Maryland reissued *The Aerodynamics of the Helicopter*, by Alfred Gessow and Garry C. Myers, in 1999, calling it “the classic text on the subject.” In the following second chapter from this text, Gessow and Myers offer a very understandable introduction to the helicopter. In it, they describe the main types of helicopter configuration, chief methods of helicopter control, main type of rotor blades, principal mechanics of rotor control, essential features of helicopter design, and the flight characteristics of a helicopter. For those readers who need a basic primer about helicopters, they may want to read this selection, originally composed in 1951, and then move back into some of the previous documents for better understanding.

It is significant to any assessment of the NACA’s contribution to helicopter development to note that over 70 NACA papers appeared in the text’s bibliography. Besides works by Gessow and Myers themselves, other NACA authors whose helicopter work was cited in the text included F. J. Bailey, Jr., T. J. Voglewede, W. B. Boothby, Richard C. Dingeldein, Raymond F. Schaefer, Montgomery Knight, Ralph A. Hefner, Stanley Lipson, John B. Wheatley, Carlton Bioletti, William C. Clay, Ray Windler, F. J. Bailey, Paul J. Carpenter, Herbert Talkin, Eugene Mitgotsky, Robert P. Coleman, Arnold M. Feingold, Carl W. Stempin, P. J. Carpenter, R. S. Paulnock, W. Castles, Jr., R. B. Gray, P. de Gullenschmidt, John E. Duberg, A. R. Lueker, Frederic B. Gustafson, and John P. Reeder. Even Robert R. Gilruth, the future head of NASA’s Mercury program, published a set of research reports related to rotary-wing flight. And much of this work in fact predated the Second World War. Wheatley published at least one report on rotary-wing design (primarily about autogiro aerodynamics and control) in every year from 1933 to 1938. The collaborative work of Montgomery Knight and Ralph A. Hefner dated from 1937 and concerned thrust analysis of “lifting airscrews.” (After moving to a teaching post at the Guggenheim School of Aeronautics at the Georgia Institute of Technology (Georgia Tech) in 1930, Knight built a single-blade jet-driven rotor test rig whose data led to his design of an innovative helicopter concept.)

Along with Gustafson, Gessow ranks as one of the greatest helicopter experts ever to have worked for the NACA/NASA. In 1980, Gessow moved from NASA

to the University of Maryland to serve as chair of its Department of Aerospace Engineering. This was six years after he received NASA's Exceptional Service Medal for his career achievements in helicopter research. In 1997, the University of Maryland renamed its Center for Rotorcraft Education and Research after Gessow.

Document 5-45, Alfred E. Gessow and Garry C. Myers, Jr., "An Introduction to the Helicopter," chapter 2 in The Aerodynamics of the Helicopter (New York: Frederick Ungar Publishing, 1985), pp. 16–45; first published by Ungar in 1951.

Later chapters of this book will deal primarily with the behavior of the helicopter rotor in various conditions of flight. The fact that the rotor has a fuselage, source of power, and means of control will be taken for granted, and very little attention will be given to the details of mechanical design. The purpose of the present chapter is to give the reader a picture of the helicopter as a whole—its geometrical configurations, its means of control, its general design features, its performance characteristics, and its flying qualities. This will, it is hoped, provide a background and permit a clearer understanding of the following chapters.

HELICOPTER CONFIGURATIONS

Helicopter configurations may be classified into five main types and several subclasses. Each type has its unique characteristics, advantages, and disadvantages.



FIG. 2-1. Bell H13-B single-rotor helicopter. Courtesy NACA.

These are discussed below.

The Single Rotor. In terms of the number of machines in operation today, the *single-rotor machine* with tail rotor (Fig. 2-1) is by far the most common type. It has the advantage of being relatively simple—one rotor, one set of controls, one main transmission.

While the tail rotor uses about 8 to 10 per cent of the engine power in hovering and 3 to 4 per cent in forward flight, the simplicity of the configuration and the saving in weight as compared with other means of torque counteraction probably compensate for this loss. One disadvantage is the danger of the vertical tail rotor to ground personnel, the whirling blades being behind the pilot and thus not under his precise control. The *gyrodyn*e, a type of helicopter in which the torque counteracting rotor points forward, has the advantage of using the anti-torque rotor instead of the main rotor to pull the machine through the air. This results in more efficient operation of

the main rotor in forward flight since it avoids the tilting forward of the rotor and the accompanying radial dissymmetry in blade angle of attack. On the other hand, the gyrodyne torque rotor must be mounted on a relatively short arm in order to avoid excessive parasite drag, and the engine power required to counteract torque at the shorter moment arm is accordingly higher.

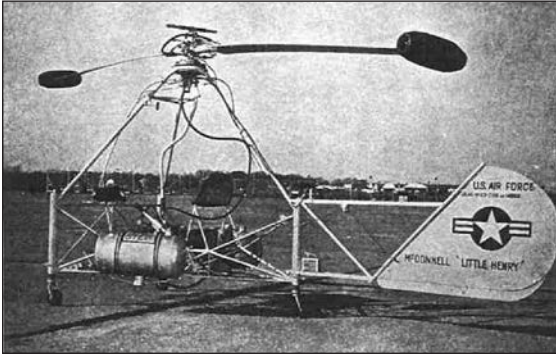

FIG. 2-2. McDonnell "Little Henry" ram jet helicopter. Courtesy McDonnell Aircraft Corporation.

stream in forward flight. Jet thrust may be provided by tip units, as in the ram jet rotor, or by an engine-driven blower from which air is ducted to rearward-pointing nozzles at the blade tips. The jet rotor has the advantage of simplicity and small storage space and the disadvantage of high specific fuel consumption as compared with a conventional machine. Development will depend primarily on jet engine development. Ultimately, the jet helicopter may very well prove to be the most practical configuration.

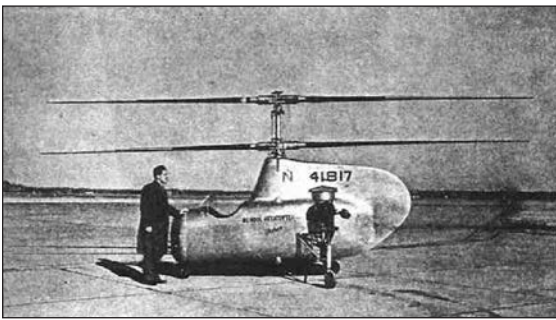

FIG. 2-3. Bendix experimental coaxial helicopter. Courtesy NACA.

over-all dimensions defined only by the rotor diameter and of a saving of power over the single rotor-tail rotor design. On the other hand, the rotor hubs and controls become more complex and rotor weights tend to increase.

The jet rotor (Fig. 2-2) provides the simplest solution to the torque problem. The rotor torque is supplied by units at the blade tips rather than by shaft torque so that the fuselage may be simply supported on a bearing, the only torque transmitted to the fuselage being the bearing friction. Fuselage directional control may then be achieved by a vane or rudder which utilizes the rotor downwash in hovering and the air

Coaxial rotors. In the coaxial machine (Fig. 2-3), fuselage torque is eliminated by utilizing two superimposed rotors, rotating in opposite directions. These rotors may or may not have the same diameter or turn at the same speed. The only requirement is that they both absorb the same torque. The coaxial design has the advantage of having its

Side-by-side rotors. The basic advantage of the side-by-side configuration (Fig. 2-4) is that the laterally displaced rotors effect a reduction in power required to produce lift in forward flight, similar to the aspect ratio effect on an airplane wing. This advantage becomes important in large multi-engine helicopters where standards require that level flight be possible with one engine dead, since the



FIG. 2-4. McDonnell XHJD-1 side-by-side helicopter. Courtesy McDonnell Aircraft Corporation.

reduction in power necessary to maintain level flight in the side-by-side ship permits bigger loads to be carried. The configuration has the disadvantage of having either high fuselage parasite drag or high structural weight, for as the supporting pylons become thin and aerodynamically clean they become heavy. The supporting pylons, however, may act as lifting surfaces and unload the rotors in forward flight, effecting a sizable gain in efficiency at high speed. As compared with the single-rotor machine, the side-by-side configuration has the disadvantage of requiring relatively complex gearing and shafting. Its over-all dimensions are greater than the single-rotor machine, this depending, of course, on the degree of overlap. The *synchropter* (Fig. 1-11), in which rotors are intermeshed to the point of approaching the single rotor, sacrifices some lifting efficiency gains for compactness and transmission simplifications.

Tandem Rotors. The main advantage of the tandem configuration (Fig. 2-5) lies in its clean fuselage possibilities, together with a large available center-of-gravity range. The useful load may be distributed between the two rotors in varying proportions. Disadvantages in transmission and shafting weights are similar to the side-by-side configuration. One main disadvantage lies in the loss in lifting efficiency in forward flight, for just as the side-by-side configuration is more efficient than a single rotor in this flight condition, the

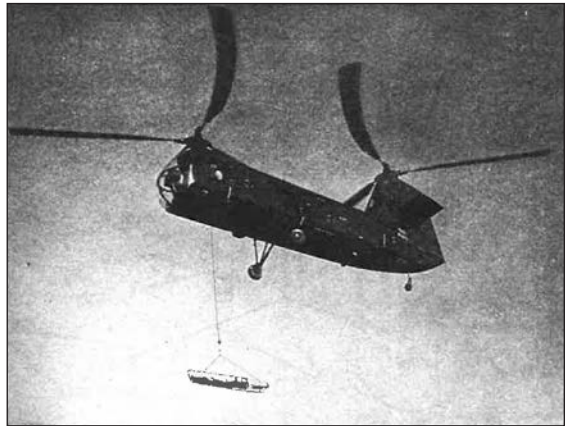

FIG. 2-5. Piasecki HJP-1 tandem helicopter. Courtesy Piasecki Helicopter Corporation.

tandem configuration is less efficient than the single rotor because one rotor is working in the wake of the other. The loss in lifting efficiency in forward flight may be minimized by stagger, i.e., by placing the rear rotor above the front rotor.

Tandem designs also include variations in the relative size of the front and rear rotors. These dimensions are important from the point of view of forward flight stability and handling qualities.

Multi-Rotors. Helicopters with many rotors have been proposed for special uses and generally for large machines. Three or more rotors offer simplifications in control system design inasmuch as control in all directions may be achieved by simply increasing the thrust of one rotor relative to the others. For large machines, use of multi-rotors offers the further advantage of influencing a large mass of air without having blades of unwieldy dimensions.

HELICOPTER CONTROL METHODS

Having established the geometrical shapes of helicopters, it is well to gain an appreciation of the manner by which each type of machine is controlled in flight. The purpose of the following paragraphs is to discuss control methods, first from the over-all point of view of the forces and moments applied to the helicopter, and second, from the point of view of the levers which the pilot moves.

Control Requirements. To control completely the position and attitude of a body in space requires control of the forces and moments about all three axes. This involves six independent controls (Fig. 2-6). Thus, if the body drifts to the side, a force may be exerted to return it to its original position. If it rolls over, a moment may be exerted to right it again. It would be exceedingly difficult, however, for a man to coordinate the controls of any machine having six independent control systems. Fortunately, it is possible to reduce this number by coupling together independent controls. Such couplings involve some sacrifice of complete freedom of control of position and attitude in space, but the sacrifice may actually be desirable.

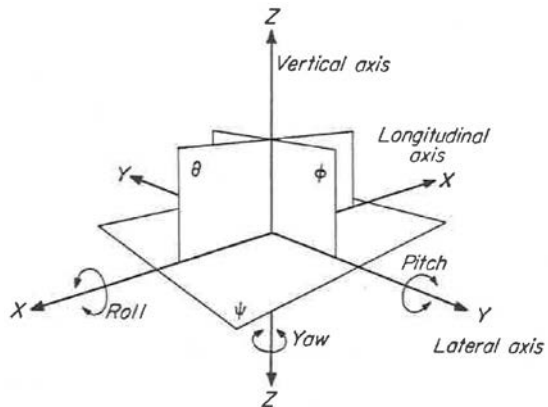

FIG. 2-6. System of control axes.

The pilot of the helicopter, for example, does demand the ability to produce moments about all axes in order to right himself as when disturbed by a gust. He does not, however, demand that he be able to produce moments (a pitching

moment, for example), without producing an accompanying force—in this case in the longitudinal direction. He therefore sacrifices the ability to maintain force equilibrium, as in hovering, and to rotate his fuselage in pitch at will so as to attain a desired attitude. By thus coupling pitching moments with longitudinal forces the necessity for one of the six independent controls is eliminated.

Actually, four independent controls are adequate for the helicopter. These are discussed and illustrated below.

- 1. *Vertical control.* This is necessary to fix the position of the helicopter in the vertical direction. It is achieved by increasing or decreasing the pitch of the rotor so as to increase or decrease the thrust.
- 2. *Directional control.* Directional control fixes the attitude of the helicopter in rotation about the vertical axis, permitting the pilot to point the ship in any horizontal direction. Means for achieving directional control are shown in Fig. 2-7. (Note that moment control is not basically coupled with force control about the vertical axis.)

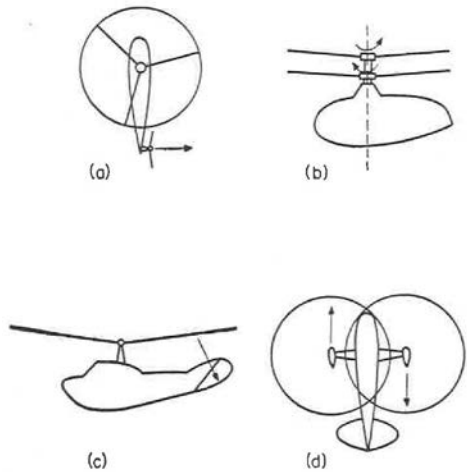

FIG. 2-7. Means for achieving directional control. (A) Anti-torque rotor (B) Differential torque between two rotors (C) Vane in rotor slipstream (D) Differential tilt of rotor thrusts.

- 3. *Lateral control.* Lateral control involves the application of both moments and forces. When the pilot applies lateral control a rolling moment is produced about the aircraft center of gravity which tilts the helicopter. As a consequence of the tilt, a component of the rotor thrust vector acts in the direction of tilt. The application of lateral control has therefore resulted in a tilt and sideward motion of the helicopter. Methods for obtaining lateral control are shown in Fig. 2-8. Note that while the initial effect of lateral control is a pure moment for the side-by-side machine, the single-rotor helicopter experiences a side force together with the initial moment.



FIG. 2-8. Methods for obtaining lateral control. (A) Tilt of rotor thrust (B) Differential thrust change.

- 4. *Longitudinal control.* Longitudinal control is identical in nature to lateral control. Pitching moments are coupled with longitudinal forces. Methods

for longitudinal control for various configurations are shown in Fig. 2-9.

In the case of multi-rotor ships, such as the tandem or side-by-side, a fifth control is possible. This would enable control of longitudinal force without an accompanying pitching moment for the tandem, or control of the side force without accompanying rolling moments for the side-by-side. Rather than introduce this fifth control, force control is usually coupled directly with moment control as described above. A fifth control for longitudinal trim (moment which is independent of horizontal force) may be available in the tandem by differentially adjusting the pitch of the two rotors just as the horizontal tail is trimmed in the single-rotor or side-by-side machine.

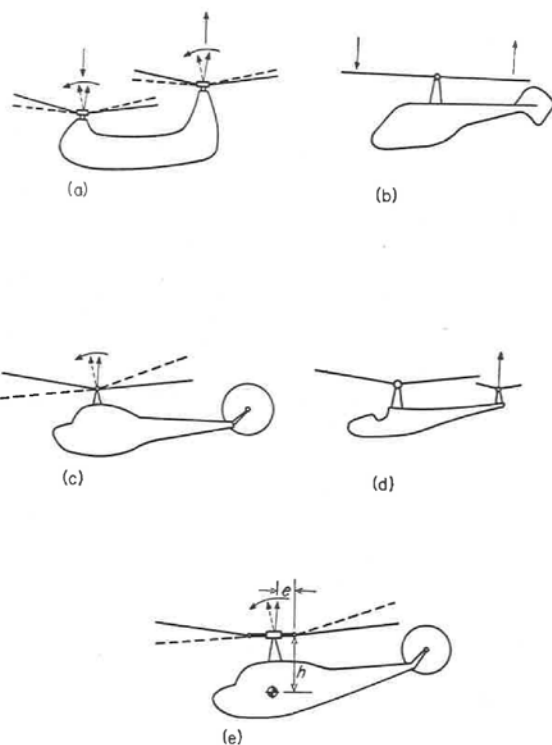

FIG. 2-9. Methods for obtaining longitudinal control. (A) Differential thrust change (B) Thrust variation around azimuth (C) Tilt of rotor thrust (D) Horizontal tail rotor (E) Tilt of rotor thrust coupled with offset-flapping hinges.

Cross effects are, in general, undesirable. For example, in the single-rotor machine an increase in vertical force necessitates an increase in rotor torque so that a correction is required in directional control to maintain the fuselage direction. Such cross effects necessitate considerable coordination on the part of the pilot and result in longer periods of training in order to control the machine.

The Pilot's Controls. In order to produce the forces and moments necessary to control the machine the pilot is supplied with levers which he moves with his hands and feet. The conventional system of levers is described below and illustrated in Fig. 2-10. The *control stick* is located in front of the pilot. It is comparable to the stick of an airplane and is used for longitudinal and lateral control. In the helicopter the pilot pushes the stick in the direction he wishes to go—forward, sideward, or backward.

Pedals, as in an airplane, are used for directional control. To point the ship toward the right the pilot pushes the right pedal; to the left, the left pedal.

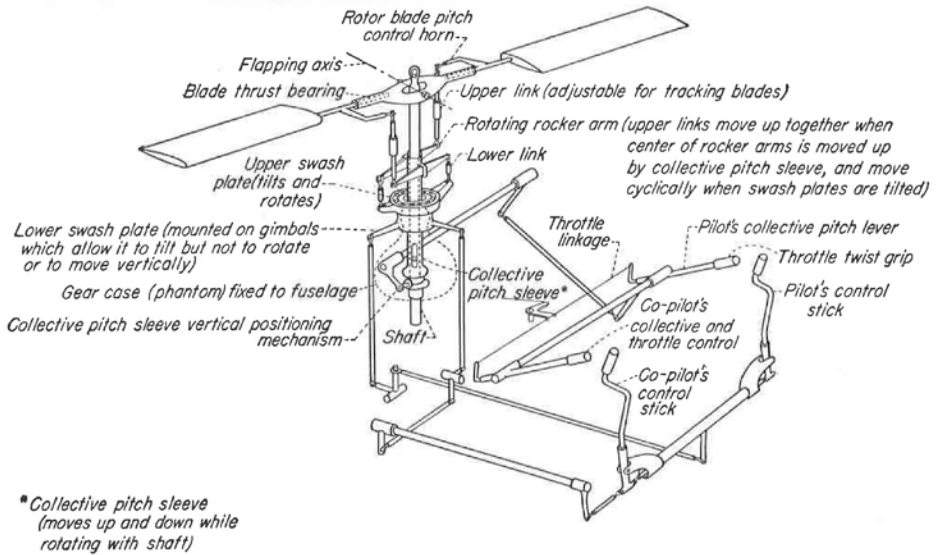

FIG. 2-10. Control system of conventional helicopter.

The *pitch lever* is operated by the pilot's other hand and is used to control the pitch of the rotor for up and down flight and for adjustments as required in forward flight. If the control system is a direct mechanical linkage, the pitch stick is usually located at the pilot's side and is moved in an up and down direction. If the pitch is controlled electrically or hydraulically, the lever may be a small pointer located within convenient reach, although in that instance a full-sized emergency lever would also be provided in case of power-control failure.

The *throttle* is usually located near or on the pitch stick. In the case of the mechanical control system, throttle adjustments are accomplished by twisting a grip located at the top of the pitch stick. In the case of the powered (electrical or hydraulic) control, the throttle may be located parallel to the pitch lever so that the two may be moved together with one hand. In either case, linkages which produce the necessary throttle change with a given pitch change are usually provided, so as to automatically keep the rotor speed approximately constant. In fact, a constant speed governor may be provided which relieves the pilot of either the pitch or throttle control. In the first case, the governor adjusts rotor pitch to absorb the engine power and to maintain a constant rotational speed. In the second case, the governor adjusts the throttle so as to supply the proper power for a given pitch setting, again so as to maintain constant rotor speed.

Devices are sometimes employed which automatically decrease the rotor pitch so as to maintain a certain minimum rotor speed in order to assure autorotation in case of power failure and in case the pilot fails to lower the pitch immediately.

ROTOR TYPES

There are three fundamental types of lifting rotors:

1. Rotors in which the blades are attached to the hub by hinges, free to flap up and down and swing back and forth (lead and lag) in the plane of the disk (Fig. 2-11).
2. Rotors in which the blades are rigidly interconnected to a hub but with the hub free to tilt with respect to the shaft (Fig. 2-12).
3. Rotors in which the blades are connected rigidly to the shaft (Fig. 2-13).

The hinges of the freely flapping rotor may be located at varying distances from the axis of rotation. The position of the flapping hinge is important with regard to stability and control, whereas the position of the lag hinge is important primarily in regard to vibration. Hinged rotors usually have dampers which prevent excessive motion about the lag hinge. Rotor types (1) and (2) differ chiefly in regard to the lag motions that are permitted in case (1) but which are restrained in case (2). In the discussions of rotor control which will follow, the flapping motions of rotor type (2) are equivalent to a rotor of type (1) in which the flapping hinges are located on the axis of rotation.

Rotors may have one, two, three, four, or more blades, the choice depending on such factors as vibration characteristics, rotor weight, mechanical complexity, and storage space required. In general, increasing the number of blades decreases vibration problems and increases rotor weight and, usually, mechanical complexity.

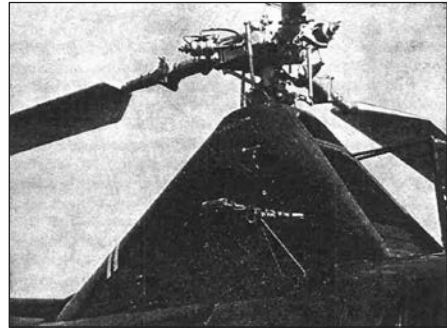

FIG. 2-11. Three-bladed articulated rotor system.
Courtesy NACA.

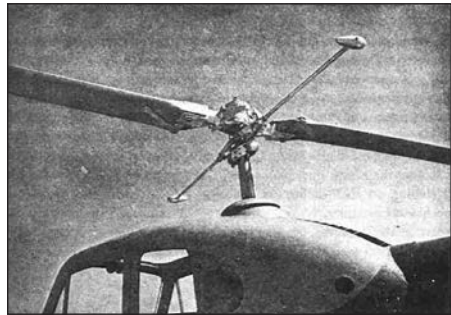

FIG. 2-12. Two-bladed "see-saw" rotor system.
Courtesy Bell Aircraft Corporation.

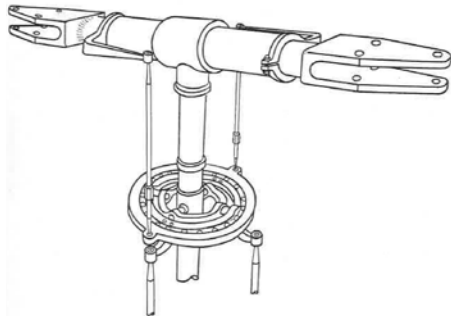

FIG. 2-13. Two-bladed rigid rotor system.

MECHANICS OF ROTOR CONTROL

As pointed out in the preceding section on helicopter control methods, the helicopter is controlled by (1) producing moments about the rotor hub, (2) tilting the resultant rotor lift vector, or (3) a combination of both. Means of accomplishing moment changes and thrust vector tilts are discussed below for the flapping and rigid type rotors.

Control by Tilting the Rotor Hub. If the hub of either a rigid or flapping rotor is tilted with respect to fuselage, as in Fig. 2-8a, a change in the direction of the thrust vector results. In the normal engine-driven helicopter, it is mechanically awkward to tilt the hub, since the hub is a rotating structure to which large torque loads are applied. Control by tilting the hub is limited primarily to jet propelled rotors and autogyro rotors where no torque is transmitted to the hub.

Control by Cyclic-Pitch Change. The conventional way of achieving control in both rigid and flapping rotors is through cyclic-pitch change. This is usually accomplished by a linkage from the blades to a “swash plate,” which is a rotating plane that defines the pitch of the blades (Fig. 2-10). The blades are mounted on “feathering” bearings and are free to follow the swash plate in pitch. With cyclic-pitch control, the effect of a sudden swash-plate tilt is fundamentally different for flapping and rigid rotors. For rigid blades, a swash-plate tilt produces a moment about the rotor hub in the direction of the swash-plate tilt, owing to the difference in lift on the feathered blades (Fig. 2-14). For flapping blades with hinges on the axis of rotation, a swash-plate tilt results in a tilt of the rotor vector. Because the blades are freely hinged, no moments may be transmitted, and the swash-plate tilt has the same effect as a corresponding shaft tilt (Fig. 2-9c). When the flapping hinges are moved outboard, the tilt of the rotor caused by a swash-plate tilt results in a moment about the hub as well as a thrust vector tilt. This moment is caused by the blade mass forces acting on the hub.

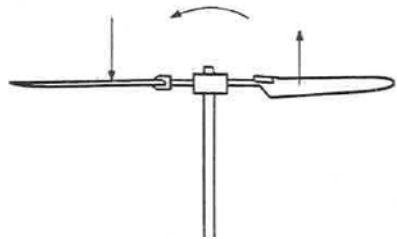

FIG. 2-14. Moment produced by thrust vector offset.

Alternative Means of Accomplishing Cyclic-Pitch Change. In addition to the direct swash-plate linkage discussed above, blade pitch change may be accomplished by connecting the swash plate to a *servo-tab* on each blade, as in Fig. 2-15, or connecting the swash plate to a *servo-rotor* which in turn acts as the swash plate for the main rotor

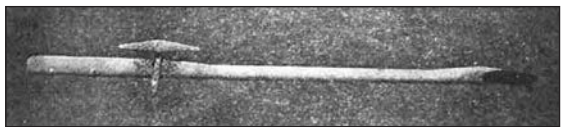

FIG. 2-15. Karman rotor blade with servo-tab. Courtesy NACA.

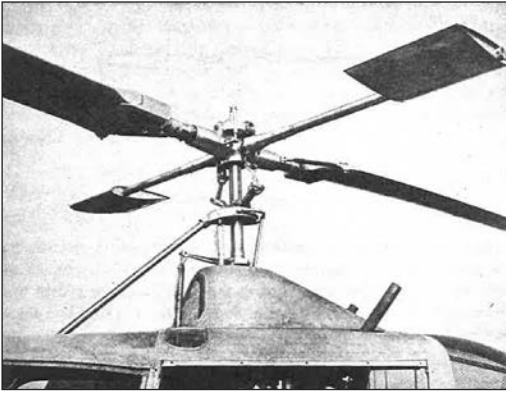

FIG. 2-16. Hiller servo-rotor control system. Courtesy United Helicopters, Inc.

(Fig. 2-16). The advantages of such systems are that they prevent the feedback of forces from the rotor into the control system and that they may be arranged so as to produce favorable effects on the stability of the machine in flight.

CONVENTIONAL HELICOPTER DESIGN FEATURES

Rotor Blades. The blades of conventional helicopter rotors are about fifteen to twenty times as long as they are wide. Airfoils are used which have low pitching moment coefficients, usually the NACA 00 series (0012, 0015, etc.) or the NACA 230 series (23012, 23015, etc.). Airfoil thickness ratios vary between 9 per cent and 20 per cent, thicker sections being used only on the inner portions of the blade.

Blades vary both in plan form and amount of twist. It will be shown later that the best blade from an aerodynamic standpoint incorporates both twist and taper. However, gains resulting from twist and taper are oftentimes relatively small (depending on the type of helicopter and the task it is primarily designed for), and oftentimes factors such as cost of production win out and blades of simple rectangular plan form without twist are used. Typical rotor blade shapes are shown in Fig. 2-17. Several methods of blade construction are outlined below:

1. *Steel spar, fabric covering.* Most early rotor blades employed this type of construction. The blades are reasonably simple to fabricate but have very

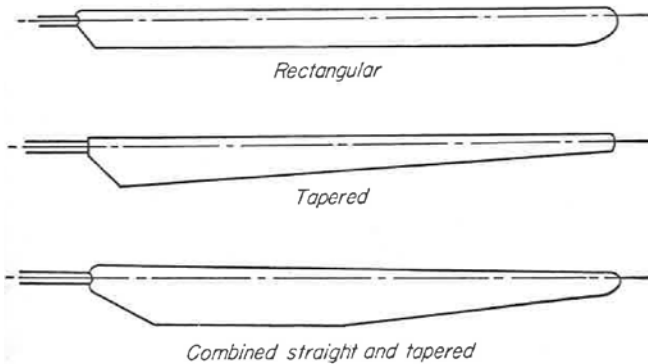

FIG. 2-17. Representative rotor blade plan forms.

definite disadvantages in that it is difficult to avoid surface irregularities and fabric distortions in flight. The primary structural member of the typical fabric-covered blade consists of a steel spar which is usually step-tapered. Spars are drawn as one continuous tube with no discontinuities in the structure of the metal occurring at the steps. The ribs are usually cut from plywood and are fastened to the steel spar by metal collars. The collars are riveted to the rib and are spot-welded or glued (cycle-welded) to the spars. The leading edge is built up of solid wood—spruce or mahogany—often with a metal strip to help to keep the blade center of gravity forward. The forward portion of the blade is covered with plywood back about to the spar line. The entire blade is covered with fabric which is sewed to each rib. Blades are vented by small holes, usually on the under surface, in order to relieve the internal pressure created by the centrifugal pumping action of the blade.

2. *Plywood-covered blades.* Most of the objectionable features of the fabric-covered blade can be overcome by using the same basic structure and covering the entire blade with thin plywood. Some of the objections to plywood-covered blades are that they require careful handwork, do not lend themselves to quantity production, and are not weatherproof.
3. *All-wood blades* are used frequently. They are usually built up from laminations of several woods, heavier woods being used in the forward portion and light woods such as balsa being used in the rearward portion. All-wood blades are relatively simple to fabricate, especially if built with rectangular plan form and constant thickness. Surfaces can be obtained which are aerodynamically clean and true to contour. One disadvantage of the all-wood blade is that it is relatively heavy and, along with fabric and plywood blades, is subject to moisture and deterioration.
4. *Metal blades* are being developed at the present time by most manufacturers. Blades are either built up from pieces of sheet stock or utilize extrusions together with sheet metal. Probably the simplest blade yet fabricated involves an extruded D-spar which forms the leading edge and a V-shaped sheet metal trailing edge joined to the D-spar by flush rivets. Entire blade sections have been extruded successfully. Extrusions lend themselves well to quantity production. It is probably safe to say that all-metal blades will eventually become standard for helicopter rotors.

Rotor Hubs. The hub is a main structural member of the rotor and is usually forged from steel or dural. Designs differ according to the hinge offsets and number of blades employed. Usually the forging houses needle-bearing hinges on which the blades flap.

Rotor Control Linkages. The rotor control mechanism usually consists of a swash plate, connecting links, and blades which rotate in their sockets (free to feather). The swash plate consists of a central nonrotating disk and an outer ring

which rotates with the rotor (Fig. 2-10). These parts are connected by thin-race ball or roller bearings. The inner portion of the swash plate is universally mounted and connected to a linkage which allows it to move up and down and tilt in any direction. Blades are connected to the swash plate by links so that the pitch of the blade is determined by the plane of the swash plate. Care is usually taken to proportion the linkage so that in its normal operating attitude the blade will not change pitch as it flaps or lags. Furthermore, linkages are arranged to minimize these couplings of pitch with flap or lag in all positions of the blade. Changes of pitch with flapping, if moderate, have some desirable effects and are often purposely incorporated. Large changes of pitch with lag angle, however, are undesirable and are usually avoided as much as possible.

The Control System. A typical direct-linkage control system for a single-rotor helicopter may be understood by again referring to Fig. 2-10. It is seen that the control stick is connected so as to tilt the swash plate in the direction in which the stick is moved. The pitch stick raises and lowers the pitch sleeve while retaining any tilt imposed by the control stick. The mechanical advantage between control stick and blade is usually such that 1 inch of stick motion results in 1 to 2 degrees of cyclic-pitch change.

In multi-rotor configurations, control systems are necessarily modified. In the side-by-side machine the swash plate may be free to tilt only in a fore and aft direction. In this case, lateral control is achieved by raising one swash plate and lowering the other, thus tilting the ship and producing sideward motion. Lateral control may also involve a swash-plate tilt which is coupled with the collective pitch change so as to tilt the thrust vector laterally as well as roll the machine. The same remarks apply to tandem machines in regard to longitudinal control.

Fuselage Design. Several factors which influence fuselage design are listed below:

1. A streamlined shape for low parasite-drag and moment coefficients.
2. Good visibility for the pilot.
3. Area for disposable load located as nearly under the rotor as possible to avoid center of gravity shifts.
4. Easy accessibility to engines and transmissions.
5. Accommodation of a tail rotor and/or stabilizing surfaces at a reasonable moment arm.

In order to increase the range of center of gravity travel for a given control tilt and in order to improve the control of the machine, it is desirable to keep the center of gravity as far below the rotor center as possible.

Landing Gear. Landing gears of both the three-wheel and four-wheel types are used. Landing gear design is comparable to normal airplane design except that the stroke available in the shock absorber of the helicopter is usually considerably longer to provide softer action in landings and provide damping for "ground resonance." Alternate gear arrangements, which permit operation from all possible types of terrain, are sometimes supplied by the manufacturer. Thus flotation gear which is

suitable for water, land, and marsh operation is available, as well as skid gear for high forward-speed landings on rough, plowed ground as well as on improved surfaces, and ski gear for soft snow and rough ice. In all cases, it is important that the landing angle, as determined by tail wheel or tail skid position, be sufficient to permit high pitch-up attitudes of the fuselage for flare-outs in autorotation landings.

Transmission Systems. Transmission systems usually involve gear ratios between engine and rotor of the order of 10:1. Planetary gear trains are most efficient from a weight point of view but are expensive and often noisy. Bevel gears, along with a single-stage-planetary-gear train, are frequently used. The drive system is also supplied with a clutch which is engaged either manually by the pilot or centrifugally when a certain engine speed is reached. In addition to the clutch, a free-wheeling unit or overriding clutch is incorporated so that the engine may drive the rotor, but the rotor cannot drive the engine in case of power failure. In a single-rotor machine, the tail rotor is geared directly to the main rotor so that in case of engine failure, the main rotor turns the tail rotor.

FLIGHT CHARACTERISTICS OF THE HELICOPTER

An appreciation of the flight characteristics of the helicopter involves an understanding of its performance characteristics, its vibration characteristics, and its stability and control characteristics. The following paragraphs deal with these topics in a qualitative manner.

Performance Characteristics. Power must be supplied to the rotor of the hovering helicopter for two reasons:

1. Power is required to produce lift. This is referred to as *induced* power.
2. Power is required to drag the blades through the air. This is called *profile-drag* power.

The helicopter rotor produces thrust to support the helicopter in air by imparting momentum to a mass of air. The rotor imparts a downward velocity to a large mass of air and, in so doing, realizes an upward thrust. It is clear that power must be expended to produce this jet of air. The power is, in fact, proportional to the downwash velocity for a given weight of helicopter. The downwash velocity, in turn, depends upon the amount of air to which velocity is imparted in producing the rotor thrust. A large diameter rotor, then, can lift a weight with much less induced loss than a small diameter rotor.

Profile-drag power arises entirely from the fact that air is a viscous fluid and that when a body is pulled through this fluid frictional forces are exerted on the body.

For the normal helicopter in hovering, induced losses account for about 60 per cent to 70 per cent of the total rotor power required; profile-drag losses account for about 30 per cent to 40 per cent. The engine must supply sufficient power for the rotor and, in the case of a single-rotor machine, for the tail rotor in order that

the helicopter may hover. If more power is applied to the rotor than is required to overcome the induced and profile losses, then the helicopter will climb.

In forward flight power must be supplied to drag the fuselage through the air as well as to overcome the induced and profile-drag losses. The power required to drag the fuselage through the air increases as the cube of the forward speed and becomes large at higher speeds. In one of the early production helicopters, for example, one-half of the available engine power was used in overcoming fuselage drag at 80 miles per hour.

While parasite-drag power increases rapidly with airspeed, the power required to produce lift—the induced power—decreases with increasing speed. As the rotor moves forward, it encounters a larger mass of air per second. To produce its thrust it therefore needs to impart less velocity to each mass of air and the energy imparted to the air is thereby reduced.

The profile-drag power increases slightly as forward speed is increased, the increase becoming very rapid at high forward speeds. The trends of induced, profile, and parasite power with airspeed are shown in Fig. 2-18. The sum of these three components at any forward speed gives the total power required for level flight at that speed. The resultant power-required curve is shown in Fig. 2-19. The numbers given are typical for a small, two-place helicopter. It is seen that the power required to hover is relatively high, the power decreasing rapidly in the low speed range (because of decreased induced losses) and increasing again at high speeds due to fuselage drag.

Minimum power is required in level flight at about 40 miles per hour in the example shown. It is characteristic of almost all helicopters that minimum power falls somewhere in the 40- to 60-mile per hour range. Also shown in Fig. 2-19 is a horizontal line which represents the power available at the helicopter rotor. The power available is the rated engine power minus the tail rotor power (if an auxiliary rotor is used), as well as the frictional losses in the transmission, and losses from powering a blower to cool the engine.

It is clear that the performance capabilities of a helicopter are determined by the level of the power-available curve with respect to the power-required curve. If, for example, the power available is just equal to the power required to hover,

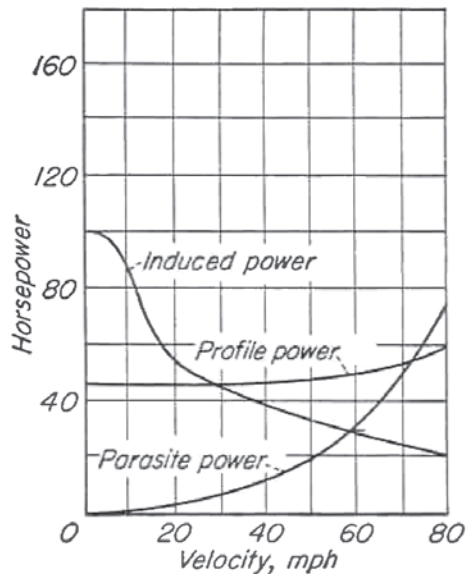

FIG. 2-18. Breakdown of helicopter power losses.

as in curve (a) of Fig. 2-19, the performance of the machine is marginal. It is only barely able to hover and unable to climb vertically. A slight overload would increase the induced power required and the machine would be unable to hover.

Actually, a helicopter is able to hover very near the ground even when it has insufficient power to hover away from the ground. This is because of a phenomenon known as *ground effect*. The ground stops the rotor downwash, or induced velocity, thus decreasing the induced power required.

It will also be noted that because of the reduction of power required with forward speed, an overloaded helicopter may take off in a wind or by making a run on the ground to attain a small forward speed. While the machine can fly forward in this overloaded condition, it cannot hover. The marginal hovering performance of many present-day helicopters has resulted in the loss of several machines in the hands of inexperienced pilots. When flying close to the ground there is a tendency to fly by ground speed rather than according to the airspeed indicator. If winds are involved, a “downwind turn” may result in zero airspeed, so that the machine will settle to the ground. Again, the helicopter may be hovering in a wind above some obstacle, such as a row of trees. When the helicopter drops below the trees, where the wind is decreased, it is unable to hover and settles to the ground.

It is clear from Fig. 2-19 that best climb with the helicopter will occur at about the speed for minimum power in level flight, for here the greatest excess power available for climb exists.

Top speed in level flight is determined by the point where the power-required curve and power-available curves cross. It will be noted that the slope of the power-required curve is very steep at high speed, because fuselage-drag power is increasing at a rapid rate. Thus, it is very difficult to increase the top speed of the machine appreciably by increase in power, inasmuch as very large increases in power are required to make significant gains in top speed. On a percentage basis, reductions in fuselage drag by “cleaning up” the fuselage are far more effective in increasing top speed than increases in power.

At high forward speeds blade stall is encountered over a portion of the rotor disk. Stall causes vibration of the helicopter and controls and a considerable increase

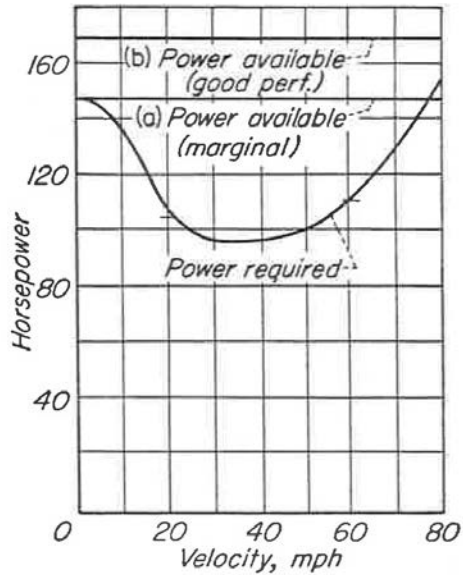

FIG. 2-19. Power-available and power-required curves.

in profile-drag power. Blade stall is due to the difference in velocity encountered by the advancing and retreating blades in forward flight. As a lifting rotor moves forward, the advancing blades encounter progressively higher velocities and the retreating blades progressively lower velocities. In order to maintain its lift, the retreating blade must operate at progressively higher angles of attack as forward speed increases. It follows that at some forward speed the angles of attack on the retreating side will reach the stall.

While the dissymmetry can be reduced by turning the rotor faster, thus permitting a higher forward speed for a given amount of stall, this method soon leads to excessively high velocities over the advancing blade and accompanying power losses and roughness due to compressibility effects. The fundamental limits to the high speed of the helicopter are therefore blade stall and blade Mach number. It will always be difficult to build helicopters which can reach speeds very much greater than about 200 miles per hour.

In case of power failure, the helicopter is able to glide, its rotors continuing to whirl in autorotation as does the rotor of the autogyro. In vertical descent the rotor is about as effective as a parachute of the same diameter in allowing the machine to descend slowly. At its best gliding speed the rotor lets the helicopter down at about one-half the vertical autorotative rate of descent, or about 15 to 20 feet per second. As the helicopter approaches the ground the pilot may pull back on his stick and "flare out," trading his energy of forward motion for additional lifting power. In this manner, he is able to settle slowly to the ground with very little forward speed. He may also take advantage of the energy in the rotor and increase the blade pitch, producing additional thrust while decelerating the rotor.

Control Forces. Stick forces in the helicopter are quite important in regard to the pilot's impressions of the machine. Pilots tend to fly aircraft by the "force feel" of the stick rather than by stick displacements. Without accurate reference points it is extremely difficult to judge the number of inches which a stick has been displaced. Most pilots like a moderate force gradient always resisting a motion of the stick. For steady flight, desirable stick force characteristics require that the pilot push with moderate but increasing force to move the stick forward and pull with increasing force to move the stick aft. When released, the stick should return to a neutral position.

In maneuvers, the forces which feed back into the pilot's stick have considerable influence on his impressions of the stability of the machine. If in a maneuver forces are created which tend to move the pilot's hand in a direction to aggravate the maneuver, the pilot experiences difficulty in properly controlling the machine.

While stick forces are quite important in regard to flying qualities, they are difficult to control in the helicopter. Stick forces in the helicopter do not arise from straightforward sources as in an airplane. In an airplane a motion of the control stick deflects a hinged control surface. Because of the deflection of the hinged surface a moment is created which is transmitted to the pilot's stick. In the simple cyclic-pitch control rotor, on the other hand, a motion of the stick changes the pitch

of the blades as they rotate. In the helicopter, all stick forces must therefore arise from pitching moments on the blades themselves. When airfoil sections are chosen and mounted so as to have no pitching moments at any pitch angle, then there should be no stick forces for the pilot to overcome.

Actually, pitching moments exist on rotor blades because of several secondary effects such as airfoil imperfections, blade-bending distortions, chordwise mass balance, etc. Stick forces are caused from these secondary effects rather than from straightforward moments as in the airplane.

Control forces consist of both oscillating forces and steady forces. Oscillating forces may occur at frequencies of 1/rev. and even multiples of the number of blades. Oscillating forces with a frequency of 1/rev. are entirely chargeable to differences in pitching moments between the rotor blades. For example, if only one blade of a three-bladed rotor experiences a pitching moment, this one blade exerts a steady force on the swash plate as it rotates. This rotating force is transmitted to the control stick. Because the pilot's hand is not a rigid support, the control stick yields under the rotating force and describes a small circle. Helicopters are often characterized by a small 1/rev. stick shake.

Higher frequency oscillations in the control stick can arise at integral multiples of the number of rotor blades. A three-bladed rotor may, therefore, experience a 3/rev., 6/rev., 9/rev., etc., oscillation in the controls. These higher frequency oscillations arise from periodic changes in the pitching moment of each blade. The periodic changes, in turn, arise from periodic air force changes in a rotor in forward flight or from periodic blade deflections. For example, a three-bladed rotor with equal pitching moments on all three blades will produce a 3/rev. motion of the control stick in forward flight because of the change in velocity on the advancing and retreating blades. As the blade comes forward and experiences higher velocities, its pitching moment is increased, and since this happens three times for each rotor revolution, a 3/rev. shake of the control stick results.

Oscillating forces in the control system can be prevented from annoying the pilot by the use of irreversible controls or by making the effective mass of the pilot's stick large enough to absorb the oscillating force. One convenient means of accomplishing the latter is by the use of an inertia damper which may consist of a weight on a high-pitch screw, the weight being forced to rotate when axial force is applied to the screw. The inertia damper is simply a means of producing a large, effective mass without heavy weights.

Steady forces on the control stick come entirely from 1/rev. variations in blade-pitching moments. These again may arise from periodic air forces, periodic blade deflections, or both.

Sometimes tabs are used on blades intentionally to produce pitching moments. In forward flight these pitching moments then vary periodically as the velocity over the blade varies, becoming large on the advancing blade and small on the retreating blade. A steady stick force results.

Usually stick forces are relatively small in small rotors (20 to 30 feet in diameter). As diameters increase, however, stick forces increase rapidly. It is, therefore, very difficult to use directly connected controls in large rotors since extreme care must be taken in blade construction to avoid the small secondary effects which produce the annoying control forces. Servo controls, which relieve the pilot from these feedback forces, seem to be necessary for very large helicopters.

Vibration Characteristics. As in the case of control oscillations, the helicopter itself is subject to vibrating forces from the rotor. If it is assumed that the force input from each rotor blade is identical, then the only frequencies at which oscillations occur are again even multiples of the number of rotor blades. Vibrating forces may be in a vertical, fore and aft, or sideward direction. The reduction of the input forces from the rotor blade is primarily a question of blade design, involving the proper distribution of masses and air forces along the span. The effect of the input forces on the vibration characteristics of the machine depends considerably upon the natural frequencies of the fuselage structure. If the fuselage structure has any mode of vibration, such as vertical bending, fuselage torsion, etc., in resonance with an exciting frequency, vibrations may become quite disagreeable. One of the main problems in minimizing vibrations in the helicopter lies in avoiding natural exciting frequencies. This is difficult since exciting frequencies cover a wide range (3/rev., 6/rev., 9/rev., etc.).

Ground Resonance. The helicopter is a very complex dynamic system, involving masses and springs in several degrees of freedom. Sometimes couplings occur between blade lag motion in the rotating system and sideward or fore and aft motion of the shaft. If insufficient damping is present in the system, a self-excited vibration may result, the ship shaking back and forth with increasing amplitude and the blades moving back and forth in the plane of rotation, out of pattern. This phenomenon is commonly known as *ground resonance* because the most frequent place of occurrence of the vibration is on the ground where the machine is supported on its relatively soft tires, giving a low natural frequency of the machine in sideward motion. Ground resonance, if it begins, often results in complete destruction of the machine within a few seconds. Several helicopters and autogyros have been destroyed by these self-excited vibrations.

Stability Characteristics. Hovering in the conventional helicopter requires considerable practice on the part of the pilot, although most of the problems tend to disappear with experience. The novice pilot must learn to put up with high control sensitivity in roll, or, in other words, the high rate of roll per inch of stick displacement. Helicopters with conventional control systems are subject to high control sensitivity which, according to reference VI-7 (Appendix IIA [*not reproduced*]), can lead to overcontrolling, and in turn, to a short-period, pilot-induced lateral oscillation. High control sensitivity is apparently due to low rotor damping, which for the helicopter is a fraction of that for airplanes. This problem is therefore minimized with large diameter rotors, which have greater damping than small rotors.

The normal helicopter in hovering is somewhat sluggish in response to a sudden control deflection. This sluggishness is not due to a lag in the response of the rotor to an applied control motion, for the rotor follows almost instantaneously a motion of the stick, but rather to the fact that velocity changes or displacement of the helicopter in space do not follow the inclination of the thrust vector immediately because of the mass of the helicopter. During training the student pilot overcomes his first impressions of lag by learning to control the helicopter's accelerations.

If disturbed from hovering equilibrium with control stick fixed, the helicopter will describe a slow, translational oscillation and move back and forth with slowly increasing amplitude. The conventional helicopter is thus dynamically unstable in hovering. The instability is easily controllable, however, and is not considered a serious handicap in the machine inasmuch as the period of the oscillation is long enough to allow for the pilot's reaction time in perceiving and correcting the motion. There are several means of stabilizing the helicopter in hovering, all of which utilize gyroscopic forces.

In forward flight, the normal helicopter may exhibit some undesirable tendencies in the longitudinal control. Helicopters have a tendency to "zoom" at low forward speeds following take-off, pitching upward abruptly, and sometimes requiring full forward stick motion to regain control of the machine. At normal cruising speed the conventional helicopter is usually dynamically unstable in pitch, but only mildly so, with a long enough period to allow the pilot to recognize the disturbance and correct it. This instability is primarily due to low rotor damping and to the fact that the conventional helicopter rotor is statically unstable with angle of attack, the instability becoming greater as the forward speed is increased. Because of this increase of angle-of-attack instability with forward speed, the attentiveness required of the pilot to correct for a disturbance increases rapidly as the helicopter's top speed is reached, in that at those speeds the disturbance builds up so rapidly that corrective control must be applied in a few seconds. The elimination of this pitching instability is considered to be of primary importance in achieving satisfactory flying qualities. Many experimental helicopters, and several production machines, already incorporate devices which either increase the damping in pitch or add positive static stability with angle of attack.

Most helicopters on the market today have definite instabilities in some regimes of flight and by airplane standards have very poor flying qualities. The stability and control characteristics of the helicopter represent a major present-day development problem, but because they are receiving considerable attention from manufacturers and government research agencies, it may be stated with confidence that a rapid improvement of helicopter flying qualities will not be long forthcoming.

Document 5-46 (a–b)

Excerpts from Wayne Johnson, *Helicopter Theory* (Princeton, NJ: Princeton University Press, 1980).

(a) Chapter 1, “Introduction,” pp. 3–11.

(b) Chapter 7, “Design,” pp. 313–321.

Just as with the Gessow-Myers textbook that was originally published in 1951 and long since has been considered a classic, NACA/NASA research continued to provide much of the substance for the treatment of helicopter aerodynamics in Wayne Johnson’s 1980 textbook as well. Of the roughly 2,000 references in the “Cited Literature” at the back of Johnson’s 1,089-page book, approximately 780 of them were NACA/NASA reports. (Of these, the NACA published some 225.) And many more of them were authored by NACA/NASA researchers but published elsewhere, for example, by the American Institute of Aeronautics and Astronautics (AIAA), by the Advisory Group for Aerospace Research and Development (AGARD) (a now-defunct part of the North Atlantic Treaty Organization, or NATO), or in aeronautical magazines and journals. It seems fair to say, then, that roughly half of all the references in Johnson’s 1980 textbook derived from NACA/NASA research. In fact, one entire chapter in his text (not the one reproduced below) concerns NACA research from the early 1950s (mostly involving Alfred Gessow) that led to the development of a means for predicting helicopter rotor stall.

Johnson’s was an extremely advanced treatise used mostly by graduate students in aeronautical engineering and by practicing aeronautical engineers; most of its contents are too abstruse for the average reader. Not even pilots wanting to learn how to fly helicopters found it very useful, but it has been a must-read since 1980 for anyone seriously working with the detailed design and analysis of helicopters. A more basic coverage of helicopter aerodynamics was provided in a series of short books authored in the 1980s and 1990s by Raymond W. Prouty, a veteran helicopter aerodynamicist who had worked since the 1950s for Hughes Helicopters (later McDonnell Douglas Helicopter Co.), Sikorsky Aircraft, Bell Helicopter, Lockheed, and back to Hughes before retiring in 1987. Prouty’s books include *Practical Helicopter Aerodynamics* (1982), *Helicopter Aerodynamics* (1985), and *More Helicopter Aerodynamics* (1988), all published by PJS Publications, Inc., of Peoria, IL. In 1989, Prouty also published *Military Helicopter Design Technology* (Surrey, England: Jane’s Defence Data).

In the first of the two excerpts below from his 1980 text, Wayne Johnson introduces his reader to the helicopter generally: the helicopter rotor, helicopter configuration, and helicopter operation. In the second excerpt, he outlines the principal concerns going into the design of different rotor and helicopter types.

Document 5-46 (a), Excerpts from Wayne Johnson, Helicopter Theory (Princeton, NJ: Princeton University Press, 1980), chapter 1, "Introduction," pp. 3-11.

1-1 THE HELICOPTER

The helicopter is an aircraft that uses rotating wings to provide lift, propulsion, and control. Figures 1-1 to 1-3 [*not reproduced*] illustrate the principal helicopter configurations. The rotor blades rotate about a vertical axis, describing a disk in a horizontal or nearly horizontal plane. Aerodynamic forces are generated by the relative motion of a wing surface with respect to the air. The helicopter with its rotary wings can generate these forces even when the velocity of the vehicle itself is zero, in contrast to fixed-wing aircraft, which require a translational velocity to sustain flight. The helicopter therefore has the capability of vertical flight, including vertical take-off and landing. The efficient accomplishment of vertical flight is the fundamental characteristic of the helicopter rotor.

The rotor must efficiently supply a thrust force to support the helicopter weight. Efficient vertical flight means a low power loading (ratio of rotor power required to rotor thrust), because the installed power and fuel consumption of the aircraft are proportional to the power required. For a rotary wing, low disk loading (the ratio of rotor thrust to rotor disk area) is the key to a low power loading. Conservation of momentum requires that the rotor lift be obtained by accelerating air downward, because corresponding to the lift is an equal and opposite reaction of the rotating wings against the air. Thus the air left in the wake of the rotor possesses kinetic energy which must be supplied by a power source in the aircraft if level flight is to be sustained. This is the induced power loss, a property of both fixed and rotating wings that constitutes the absolute minimum of power required for equilibrium flight. For the rotary wing in hover, the induced power loading is found to be proportional to the square root of the rotor disk loading. Hence the efficiency of rotor thrust generation increases as the disk loading decreases. For a given gross weight the induced power is inversely proportional to the rotor radius, and therefore the helicopter is characterized by the large disk area of large diameter rotors. The disk loading characteristic of helicopters is in the range of 100 to 500 N/m² (2 to 10 lb/ft²). The small diameter rotating wings found in aeronautics, including propellers and turbofan engines, are used mainly for aircraft propulsion. For such applications a high disk loading is appropriate, since the rotor is operating at high axial velocity and at a thrust equal to only a fraction of the gross weight. However, the use of high disk loading rotors for direct lift severely compromises the vertical flight capability in terms of both greater installed power and much reduced hover endurance. The helicopter uses the lowest disk loading of all VTOL (vertical take-off and landing) aircraft designs and hence has the most efficient vertical flight capability. It follows that the helicopter may be defined as

an aircraft utilizing large diameter, low disk loading rotary wings to provide the lift for flight.

Since the helicopter must also be capable of translational flight, a means is required to produce a propulsive force to oppose the aircraft and rotor drag in forward flight. For low speeds at least, this propulsive force is obtained from the rotor, by tilting the thrust vector forward. The rotor is also the source of the forces and moments on the aircraft that control its position, attitude, and velocity. In a fixed wing aircraft, the lift, propulsion, and control forces are provided by largely separate aerodynamic surfaces. In the helicopter, all three are provided by the rotor.

Vertical flight capability is not achieved without a cost, which must be weighed against the value of VTOL capability in the desired applications of the aircraft. The task of the engineer is to design an aircraft that will accomplish the required operations with minimum penalty for vertical flight. The price of vertical flight includes a higher power requirement than for fixed wing aircraft, a factor that influences the first cost and operating cost. A large transmission is required to deliver the power to the rotor at low speed and high torque. The fact that the rotor is a mechanically complex system increases first cost and maintenance costs. The rotor is a source of vibration, hence increased maintenance costs, passenger discomfort, and pilot fatigue. There are high alternating loads on the rotor, reducing the structural component life and in general resulting in increased maintenance cost. The stability and control characteristics are often marginal, especially in hover, unless a reliable automatic control system is used. In particular, good instrument flight characteristics are lacking without stability augmentation. Aircraft noise is an increasingly important factor in air transportation, as it is the primary form of interaction of the system with a large part of society. The helicopter is among the quietest of aircraft (or at least it can be), but utilization of its VTOL capability often involves operation close to urban areas, leading to stricter noise requirements in order to achieve its potential. All these factors can be overcome to design a highly successful aircraft. The engineering analysis required for that task is the subject of this book.

1-1.1 THE HELICOPTER ROTOR

The conventional helicopter rotor consists of two or more identical, equally spaced blades attached to a central hub. The blades are maintained in uniform rotational motion, usually by a shaft torque from the engine. The lift and drag forces on these rotating wings produce the torque, thrust, and other forces and moments of the rotor. The large diameter rotor required for efficient vertical flight and the high aspect ratio blades required for good aerodynamic efficiency of the rotating wing result in blades that are considerably more flexible than high disk loading rotors such as propellers. Consequently, there is a substantial motion of the rotor blades in response to the aerodynamic forces in the rotary wing environment. This motion can produce high stresses in the blades or large moments at the root, which are transmitted through the hub to the helicopter. Attention must therefore

be given in the design of the helicopter rotor blades and hub to keeping these loads low. The centrifugal stiffening of the rotating blade results in the motion being predominantly about the blade root. Hence the design task focuses on the configuration of the rotor hub.

A frequent design solution that was adopted early in the development of the helicopter and only recently altered is to use hinges at the blade root that allow free motion of the blade normal to and in the plane of the disk. A schematic of the root hinge arrangement is given in Fig 1-4. Because the bending moment is zero at the blade hinge, it must be low throughout the root area, and no hub moment is transmitted through the blade root to the helicopter. This configuration makes use of the blade motion to relieve the bending moments that would otherwise arise at the root of the blade. The motion of the blade allowed by these hinges has an important role in the behavior of the rotor and in the analysis of that behavior. Some current rotor designs eliminate the hinges at the root, so that the blade motion involves structural bending. The hub and blade loads are necessarily higher than for a hinged design. The design solution is basically the same, however, because the blade must be provided with enough flexibility to allow substantial motion, or the loads would be intolerable even with advanced materials and design technology. Hence blade motion remains a dominant factor in rotor behavior, although the root load and hub moment capability of a hingeless blade has a significant influence on helicopter design and operating characteristics.

The motion of a hinged blade consists basically of rigid body rotation about each hinge, with restoring moments due to the centrifugal forces acting on the rotating blade. Motion about the hinge lying in the rotor disk plane (and perpendicular to the blade radial direction) produces out-of-plane deflection of the blade and is called flap motion. Motion about the vertical hinge produces deflection of the blade in the plane of the disk and is called lag motion (or lead-lag). For a blade without hinges the fundamental modes of out-of-plane and in-plane bending define the flap and lag motion. Because of the high centrifugal stiffening of the blade these modes are similar to the rigid body rotations of hinged blades, except in the vicinity of the root, where most of the bending takes place. In addition to the flap and lag motion, the ability to change the pitch of the blade is required in order to control the rotor. Pitch motion allows control of the angle of attack of the blade, and hence control of the aerodynamic forces on the rotor. This blade pitch change, called feathering motion, is usually accomplished by movement about a hinge or bearing. The pitch bearing on a hinged blade is usually outboard of the flap and lag hinges; on a hingeless blade the pitch bearing may be either inboard or outboard of the major flap and lag bending at the root. There are also rotor designs that eliminate the pitch bearings as well as the flap and lag hinges; the pitch motion then occurs about a region of torsional flexibility at the blade root.

The mechanical arrangement of the rotor hub to accommodate the flap and lag motion of the blade provides a fundamental classification of rotor types as follows:

Articulated rotor. The blades are attached to the hub with flap and lag hinges.

Teetering rotor. Two blades forming a continuous structure are attached to the rotor shaft with a single flap hinge in a teetering or seesaw arrangement. The rotor has no lag hinges. Similarly, a gimballed rotor has three or more blades attached to the hub without hinges, and the hub is attached to the rotor shaft by a gimbal or universal joint arrangement.

Hingeless rotor. The blades are attached to the hub without flap or lag hinges, although often with a feathering bearing or hinge. The blade is attached to the hub with cantilever root restraint, so that blade motion occurs through bending at the root. This rotor is also called a rigid rotor. However, the limit of a truly rigid blade, which is so stiff that there is no significant motion, is applicable only to high disk loading rotors.

1-1.2 HELICOPTER CONFIGURATION

The arrangement of the rotor or rotors on a helicopter is perhaps its most distinctive external feature and is an important factor in its behavior, notably its stability and control characteristics. Usually the power is delivered to the rotor through the shaft, accompanied by a torque. The aircraft in steady flight can have no net force or moment acting on it, and therefore the torque reaction of the rotor on the helicopter must be balanced in some manner. The method chosen to accomplish this torque balance is the primary determinant of the helicopter configuration. Two methods are in general use[:] a configuration with a single main rotor and a tail rotor, and configurations with twin contrarotating rotors.

The single main rotor and tail rotor configuration uses a small auxiliary rotor to provide the torque balance (and yaw control). This rotor is on the tail boom, typically slightly beyond the edge of the main rotor disk. The tail rotor is normally vertical, with its shaft horizontal and parallel to the helicopter lateral axis. The torque balance is produced by the tail rotor thrust acting on an arm about the main rotor shaft. The main rotor provides lift, propulsive force, and roll, pitch, and vertical control for this configuration.

A twin main rotor configuration uses two contrarotating rotors, of equal size and loading, so that the torques of the rotors are equal and opposing. There is then no net yaw moment on the helicopter due to the main rotors. This configuration automatically balances the main rotor torque without requiring a power-absorbing auxiliary rotor. The rotor-rotor aerodynamic interference losses absorb about the same amount of power, however. The most frequent twin rotor arrangement is the tandem helicopter configuration—fore and aft placement of the main rotors on the fuselage usually with significant overlap of the rotor disks and with the rear rotor raised vertically above the front rotor. A side-by-side twin rotor arrangement has also found some application.

Operation in vertical flight, with no translational velocity, is the particular role for which the helicopter is designed. Operation with no velocity at all relative to

the air, either vertical or translational, is called hover. Lift and control in hovering flight are maintained by rotation of the wings to provide aerodynamic forces on the rotor blades. General vertical flight involves climb or descent with the rotor horizontal, and hence with purely axial flow through the rotor disk. A useful aircraft must be capable of translational flight as well. The helicopter accomplishes forward flight by keeping the rotor nearly horizontal, so that the rotor disk sees a relative velocity in its own plane in addition to the rotational velocity of the blades. The rotor continues to provide lift and control for the aircraft. It also provides the propulsive force to sustain forward flight, by means of a small forward tilt of the rotor thrust.

Safe operation after loss of power is required of any successful aircraft. The fixed wing aircraft can maintain lift and control in power-off flight, descending in a glide at a shallow angle. Rotary wing aircraft also have the capability of sustaining lift and control after a loss of power. Power-off descent of the helicopter is called autorotation. The rotor continues to turn and provide lift and control. The power required by the rotor is taken from the air flow provided by the aircraft descent. The procedure upon recognition of loss of power is to set the controls as required for autorotative descent, and establish equilibrium flight at the minimum descent rate. Then near the ground the helicopter is flared, using the rotor-stored kinetic energy of rotation to eliminate the vertical and translational velocity just before touchdown. The helicopter rotor in vertical power-off descent has been found to be nearly as effective as a parachute of the same diameter as the rotor disk; about half that descent rate is achievable in forward flight.

A rotary wing aircraft called the autogiro uses autorotation as the normal working state of the rotor. In the helicopter, power is supplied directly to the rotor, and the rotor provides propulsive force as well as lift. In the autogiro, no power or shaft torque is supplied to the rotor. The power and propulsive force required to sustain level forward flight are supplied by a propeller or other propulsion device. Hence the autogiro is like a fixed-wing aircraft, since the rotor takes the role of the wing in providing only lift for the vehicle, not propulsion. Sometimes the aircraft control forces and moments are supplied by fixed aerodynamic surfaces as in the airplane, but it is better to obtain the control from the rotor. The rotor performs much like a wing, and has a fairly good lift-to-drag ratio. Although rotor performance is not as good as that of a fixed wing, the rotor is capable of providing lift and control at much lower speeds. Hence the autogiro is capable of flight speeds much slower than fixed-wing aircraft. Without power to the rotor itself, however, it is not capable of actual hover or vertical flight. Because autogiro performance is not that much better than the performance of an airplane with a low wing loading, it has usually been found that the requirement of actual VTOL capability is necessary to justify the use of a rotor on an aircraft.

1-2 HISTORY

The initial development of rotary-wing aircraft faced three major problems that had to be overcome to achieve a successful vehicle. The first problem was to find a light and reliable engine. The reciprocating internal combustion engine was the first to fulfill the requirements, and much later the adoption of the turboshaft engine for the helicopter was a significant advance. The second problem was to develop a light and strong structure for the rotor, hub, and blades while maintaining good aerodynamic efficiency. The final problem was to understand and develop means of controlling the helicopter, including balancing the rotor torque. These problems were essentially the same as those that faced the development of the airplane and were solved eventually by the Wright brothers. The development of the helicopter in many ways paralleled that of the airplane. That helicopter development took longer may be attributed to the cost of vertical flight, which required a higher development of aeronautical technology before the problems could be satisfactorily overcome.

Document 5-46 (b), Excerpts from Wayne Johnson, Helicopter Theory (Princeton, NJ: Princeton University Press, 1980), chapter 7, "Design," pp. 313–321.

7-1 ROTOR TYPES

The helicopter rotor type is largely determined by the construction of the blade root and its attachment to the hub. The blade root configuration has a fundamental influence on the blade flap and lag motion and hence on the helicopter handling qualities, vibration, loads, and aeroelastic stability. The basic distinction between rotor types is the presence or absence of flap and lag hinges, and thus whether the blade motion involves rigid body rotation or bending at the blade root.

An articulated rotor has its blades attached to the hub with both flap and lag hinges. The flap hinge is usually offset slightly from the center of rotation because of mechanical constraints and to improve the helicopter handling qualities. The lag hinge must be offset in order for the shaft to transmit torque to the rotor. The purpose of the flap and lag hinges is to reduce the root blade loads (since the moments must be zero at the hinge). With a lag hinge it is also necessary to have a mechanical lag damper to avoid a mechanical instability called ground resonance, involving the coupled motion of the rotor lag and hub in-plane displacement. The articulated rotor is the classical design solution to the problem of the blade root loads and hub moments. It is conceptually simple, and the analysis of the rigid body motion is straightforward. The articulated rotor is mechanically complex, however, involving three hinges (flap, lag, and feather) and a lag damper for each blade. The flap and lag bearings are required to transmit both the blade thrust and centrifugal force to

the hub, and so must operate in a highly stressed environment. The hub also has the swashplate, and the rotating and non-rotating links of the control system. The resulting hub requires a high level of maintenance and contributes substantially to the helicopter parasite drag. Recently, the use of elastomeric bearings has been introduced. By replacing the mechanical bearings, a major maintenance problem is eliminated.

The teetering rotor (also called a semi-articulated, semi-rigid, or see-saw rotor) has two blades attached rigidly to the hub without flap or lag hinges; the hub is attached to the rotor shaft with a single flap hinge. The two blades thus form a single structure that flaps as a whole relative to the shaft. The hub usually has a built-in precone angle to reduce the steady coning loads, and perhaps an under-sling also to reduce Coriolis forces. The blades have feathering bearings. Without lag hinges, the blade in-plane loads must be reacted [*sic*] by the root structure. Similarly, the rotor coning produces structural loads, except at the design precone angle. To take these loads the rotor requires additional structure and weight relative to an articulated rotor. This factor is offset by the mechanical simplicity of the teetering configuration, which eliminates all the lag hinges and dampers and all but a single flap hinge. The flap hinge also does not have to carry the centrifugal loads of the blade, but only the rotor thrust, since the centrifugal forces cancel in the hub itself. The teetering configuration is perhaps the simplest and lightest for a small helicopter. It is not practical for large helicopters because a large chord is required to obtain the necessary blade area with only two blades. A gimballed rotor has three or more blades attached to the hub without flap or lag hinges (but with feathering hinges); the hub is attached to the shaft by a universal joint or gimbal. Basically, the gimballed rotor is the multi-blade counterpart of the teetering rotor, and like it has the advantage of a simpler hub than articulated rotors. The teetering and gimballed rotors are characterized by a flap hinge exactly at the center of rotation, giving a flap frequency of exactly 1/rev. The improvements in handling qualities due to offset hinges are not available. For example, flight at low or zero load factor is not possible with a teetering or gimballed rotor, since the control power and damping of the rotor are directly proportional to the thrust. However, a hub spring can be used to increase the flap frequency by as much as can be achieved in articulated rotors, although in the teetering rotor a hub spring leads to large 2/rev loads as well. The lag motion of teetering and gimballed rotors is usually stiff in-plane motion with a natural frequency above 1/rev.

The hingeless rotor (also called a rigid rotor) has its blades attached to the rotor hub and shaft with cantilever root constraint. While the rotor has no flap or lag hinges, there often are hinges or bearings for the feathering motion. The fundamental flap and lag motion involves bending at the blade root. The structural stiffness is still small compared to the centrifugal stiffening of the blade, so the mode shape is not too different from the rigid body rotation of articulated blades and the flap frequency is not far above 1/rev (typically $\nu = 1.10$ to 1.20 for hingeless

rotors). Depending on the structural design of the root, the blade may be either soft in-plane (lag frequency below 1/rev) or stiff in-plane (lag frequency above 1/rev). Without hinges, there can be considerable coupling of the flap, lag, and pitch motions of the blade, which leads to significantly different aeroelastic characteristics than with articulated blades. The hingeless rotor is capable of producing a large moment on the hub due to the tip-path-plane tilt; this moment has a significant influence on the helicopter handling qualities, including increased control power and damping, but also increased gust response. The hingeless rotor is a simple design mechanically, with therefore a potentially low maintenance requirement and low hub drag. A stronger hub and blade root are required to take the hub moments, however. There are rotor designs that eliminate the blade pitch bearings as well (these are sometimes called bearing-less rotors). The pitch motion in such designs takes place about torsionally soft structure at the blade root.

Most rotor designs have a hinge or bearing at the blade root to allow the feathering or pitch motion of the blade for collective and cyclic control inputs. While it is the most common design solution, the pitch bearing operates under very adverse conditions. It is required to transmit the centrifugal and thrust loads of the blade while undergoing a periodic motion due to the rotor cyclic pitch control. Thus there have been other approaches to achieving blade pitch control. A hinge can be used instead of a bearing, or an elastomeric bearing can be used instead of a mechanical one, to simplify the mechanical design. Another approach is to allow the pitch motion to take place about torsional flexibility at the root, or tension-torsion straps between the blade and hub. Kaman developed a rotor that uses a servo-flap on the outboard portion of a torsionally flexible blade. Servo-flap deflection causes the blade to twist, which can be used for the collective and cyclic control of the rotor in place of root pitch.

7-2 HELICOPTER TYPES

The helicopter configuration primarily involves the number and orientation of the main rotors, the means for torque balance and yaw control, and the fuselage arrangement. The basic rotor analysis is applicable to all helicopter types, but the configuration of the helicopter does have an influence on its behavior, notably on its stability and control characteristics.

A single main rotor and tail rotor is the most common configuration. The tail rotor is a small auxiliary rotor used for torque balance and yaw control. It is mounted vertically on a tail boom, with the thrust acting to the left for a counter-clockwise-rotating main rotor. The moment arm of the tail rotor thrust about the main rotor shaft is usually slightly greater than the main rotor radius. Pitch and roll control of this configuration is achieved by tilting the main rotor thrust using cyclic pitch; height control is achieved by changing the main rotor thrust magnitude using collective pitch; and yaw control is achieved by changing the tail rotor

thrust magnitude using collective pitch. This configuration is simple, requiring only a single set of main rotor controls and a single main transmission. The tail rotor gives good yaw control, but it absorbs power in balancing the torque, which increases the helicopter power requirement by several percent. The single main rotor configuration typically has only a small center-of-gravity range, although it is increased with a hingeless rotor. The tail rotor is also some hazard to ground personnel unless it is located very high on the tail, and it is possible for the tail rotor to strike the ground during operation of the helicopter. The tail rotor operates in an adverse aerodynamic environment (as do the fixed vertical and horizontal tail surfaces) due to the wake of the main rotor and fuselage, which reduces the aerodynamic efficiency and increases the tail rotor loads and vibration. The single main rotor and tail rotor configuration is the simplest and lightest for small- and medium-size helicopters.

Many anti-torque devices to replace the tail rotor have been considered. A successful alternative must have satisfactory stability, control power, autorotation capability, weight, and power loss. The tail rotor has satisfactory characteristics in all these areas, excellent characteristics in some. Most candidate replacements are seriously deficient in at least one area. The most likely alternative to the tail rotor appears to be the ducted fan. The primary deficiencies of the tail rotor are its hazard to personnel, noise, and vibration. The ducted fan offers some improvements, particularly regarding personnel hazard. Some development problems remain to be solved before the ducted fan can replace the tail rotor, however.

With two (or more) contrarotating main rotors torque balance is inherent in the helicopter configuration, and no specific anti-torque device with its own power loss is required. There are aerodynamic losses from the interference between the main rotors and between the rotors and fuselage; these losses reduce the overall efficiency of twin main rotor configurations to about the same level as for the single main and tail rotor configuration. The mechanical complexity is greater with twin main rotors because of the duplication of control systems and transmissions. For large machines, the resulting increase in weight and maintenance is offset by the fact that rotors of smaller diameter than a single main rotor can be used for a given gross weight and disk loading, thereby reducing the rotor and transmission weights.

The tandem rotor helicopter has two contrarotating main rotors with longitudinal separation. The main rotor disks are usually overlapped, typically by around 30% to 50% (the shaft separation is thus around $1.7R$ to $1.5R$). To minimize the aerodynamic interference created by the operation of the rear rotor in the wake of the front, the rear rotor is elevated on a pylon, typically 0.3 to $0.5R$ above the front rotor. Longitudinal control is achieved by differential change of the main rotor thrust magnitude, from differential collective; roll control is by lateral thrust tilt with cyclic pitch; and height control is by main rotor collective. Yaw control is achieved by differential lateral tilt of the thrust on the two main rotors using differential cyclic pitch. A large fuselage is inherent in the design, being required to

support the two rotors. The tandem helicopter also has a large longitudinal center-of-gravity range because of the use of differential thrust to balance the helicopter in pitch. The operation of the rear rotor in the wake of the front rotor is a significant source of vibration, oscillatory loads, noise, and power loss. The high pitch and roll inertia, unstable fuselage aerodynamic moments, and low yaw control power adversely affect the helicopter handling qualities. There is a structural weight penalty for the rear rotor pylon. Generally the tandem rotor configuration is suitable for medium and large helicopters.

The side-by-side configuration has two contrarotating main rotors with lateral separation. The rotors are mounted on the tips of wings or pylons, with usually no overlap (so the shaft separation is at least $2R$). Control is as for the tandem helicopter configuration, but with the pitch and roll axes reversed. Roll control is achieved by differential collective pitch, and helicopter pitch control by longitudinal cyclic pitch. The structure to support the rotors is only a source of drag and weight, unless the aircraft has a high enough speed to benefit from the lift of a fixed wing.

The coaxial rotor helicopter has two contrarotating main rotors with concentric shafts. Some vertical separation of the rotor disks is required to accommodate lateral flapping. Pitch and roll control is achieved by main rotor cyclic, and height control by collective pitch, as in the single main rotor configuration. Yaw control is achieved by differential torque of the two rotors. The concentric configuration complicates the rotor controls and transmission, but the extensive cross-shafting of other twin rotor configurations is not required. Yaw control by differential torque is somewhat sluggish. This helicopter configuration is compact, having small diameter main rotors and requiring no tail rotor. The synchropter is a helicopter with two contrarotating main rotors with very small lateral separation. It is therefore nearly a coaxial design, but is simpler mechanically because of the separate shafts.

In most helicopter designs the power is delivered to the rotor by a mechanical drive, that is, through the rotor shaft torque. Such designs require a transmission and a means for balancing the main rotor torque. An alternative is to supply the power by a jet reaction drive of the rotor, using cold or hot air ejected out of the blade tips or trailing edges. For example, helicopters have been designed with ram jets on the blade tips, or with jet flaps on the blade trailing edges that use compressed air generated in the fuselage. Since there is no torque reaction between the helicopter and rotor (except for the small bearing friction), no transmission or anti-torque device is required, resulting in a considerable weight saving. With a jet reaction drive, the propulsion system is potentially lighter and simpler, although the aerodynamic and thermal efficiency will be lower. The helicopter must still have a mechanism for yaw control. Fixed aerodynamic surfaces (a rudder) may be used, but at low speeds they are not very effective, depending on the forces generated by the rotor wake velocities.

7-3 PRELIMINARY DESIGN

Preliminary design is the process of defining the basic parameters of the helicopter to meet a given set of performance or mission specifications. Basically, the preliminary design analysis involves sizing the helicopter, rotor, and powerplant, and thus it can be formulated as an iteration on gross weight. Basic parameters such as rotor radius, tip speed, and solidity are selected on the basis of a current estimate of the helicopter gross weight; fundamental limits such as those on disk loading, Mach number, advance ratio, and blade loading are considered. Next, the powerplant is sized by a performance analysis that consists primarily of a calculation of the power required for the specified mission. Typically, the energy balance method is used for the performance analysis. The simplest method that will accurately do the task is desired, assuming it is consistent with the preliminary definition of the aircraft that is available. The basic sizing of the helicopter is then complete, and the general layout can be sketched. The component weights can be estimated now from the size of the rotor and powerplant and from the fuel and payload required for the mission. The component weights are summed to obtain the gross weight of the helicopter, and the procedure is repeated until the gross weight converges. Design optimization is based on an examination of mission cost parameters (such as direct operating cost, or even gross weight, which controls first cost) or various performance indices (such as range, maximum speed, or noise) as a function of the basic rotor and helicopter parameters. Even rotor type and helicopter type can be considered in the optimization process if the performance analysis and weight estimation are detailed enough to be able to distinguish between the types.

The major rotor parameters to be selected in the preliminary design stage are the disk loading, tip speed, and solidity. For a given gross weight, the disk loading determines the rotor radius. The disk loading is a major factor in determining the power required, particularly the induced power in hover. The disk loading also influences the rotor downwash and the autorotation descent rate. The rotor tip speed is selected largely as a compromise between the effects of stall and compressibility. A high tip speed increases the advancing-tip Mach number, leading to high profile power, blade loads, vibration, and noise. A low tip speed increases the angle of attack on the retreating blade until limiting profile power, control loads, and vibration due to stall are encountered. Thus there will be only a limited range of acceptable tip speeds, which becomes smaller as the helicopter velocity increases (see section 7-4). For a given rotor radius, the tip speed also determines the rotational speed. The rotational speed should be high for good autorotation characteristics and for low torque (and hence low transmission weight). The blade area or solidity is determined by the stall limitations on the rotor blade loading. The limits placed by stall on the blade operating lift coefficient, and therefore on C_T/σ , require a minimum value of $(\Omega R)^2 A_{\text{blade}}$ for a given gross weight. The rotor weight and profile power increase with blade chord, however, so the smallest blade

area that maintains an adequate stall margin is used. Parameters such as blade twist and planform, number of blades, and airfoil section are chosen to optimize the aerodynamic performance of the rotor. The choice will be a compromise for the various operating conditions that must be considered. With appropriate representations of their influence on the helicopter weight and performance, these and other parameters can be included in the preliminary design process. However, there are many factors influencing the basic design features of the helicopter that do not appear directly in the preliminary design analysis. For example, the rotor type is determined more by its influence on the helicopter handling qualities, aeroelastic stability, and maintenance than by its influence on performance and weight. Such considerations must be included by the engineer in the optimization process.

A key element in the preliminary design of aircraft is the estimation of the weights of the various components of the vehicle from the basic parameters of the design. For a new aircraft that has not reached the detailed design stage, the component weight estimates can only be obtained by interpolating and extrapolating the trends observed in the weight data for existing vehicles. Preliminary design analyses generally use analytical expressions based on correlation of such weight data. The fundamental difficulty with such an approach is the reliability of the trends, particularly when it is necessary to extrapolate far beyond existing designs. If this limitation is kept in mind, the formulas expressing empirical weight trends may be successfully employed in preliminary design.

Component weight formulas are typically obtained by correlating weight data from existing designs as a straight line with some parameter κ on a log-log scale, which leads to expressions of the form $W = c_1 \kappa^{c_2}$ (where c_1 and c_2 are empirical constants). The parameter κ will be a function of those quantities that have a primary influence on the component weight. As an example, for the helicopter rotor weight, κ would depend on at least the rotor radius, tip speed, and blade area. Determining the form of the parameter κ requires a combination of analysis, empirical correlation, and guesswork. There is no unique correlation expression, or even a best one. Consequently there are numerous component weight formulas in use for preliminary design analyses.

Detail design completes the specification of the construction of all components of the helicopter. All the individual components are designed to perform their required tasks in accordance with the results of the preliminary design analysis. The major task is the structural analysis of all components, which requires a detailed specification of the aerodynamic and inertial loads and a complete calculation of the helicopter performance. This stage in the helicopter design thus brings to bear the best developed and most complex analyses available to the engineer.

7-4 HELICOPTER SPEED LIMITATIONS

As for fixed wing aircraft, the maximum speed of a helicopter in level flight is limited by the power available, but with a rotary wing there are a number of other speed limitations as well, among them stall, compressibility, and aeroelastic stability effects. The primary limitation with many current designs is retreating blade stall, which at high speed produces an increase in the rotor and control system loads and helicopter vibration, severe enough to limit the flight speed. The result of these limitations is that the design cruise speed of the pure helicopter is generally between 150 and 200 knots with current technology. To achieve a higher cruise speed requires either an improvement in rotor and fuselage aerodynamics or a significant change in the helicopter configuration.

The absolute maximum level flight speed is the speed at which the power required equals the maximum power available. At high speed the principal power loss is the parasite power. To increase the power-limited speed requires an increase in the installed power of the helicopter or a reduction in the hub and body drag. Because the parasite power is proportional to V^3 , a substantial change in drag or installed power is required to noticeably influence the helicopter speed. The rotor profile power also shows a sharp increase at some high speed as a result of stall and compressibility effects.

Document 5-47 (a–b)

(a) Robert L. Lichten, “Some Aspects of Convertible Aircraft Design,” *Journal of the Aeronautical Sciences* 16 (October 1949): 611–622.

(b) Robert L. Lichten, “Some Performance and Operating Characteristics of Convertiplanes,” presented at the national meeting of the Society of Automotive Engineers (SAE), Los Angeles, CA, 30 September–5 October 1957, copy in the Technical Library, NASA Langley Research Center.

During World War II, Robert L. Lichten worked for the Piasecki Aircraft Corporation. In 1945, he left Piasecki, taking a team of engineers with him, to form the Transcendental Aircraft Corporation. The goal of this small firm was to begin development of a special type of aircraft that could perform both as a helicopter and as an airplane. What Lichten and his associates had in mind was a “convertiplane”: a fixed-wing rotorcraft that could convert from hovering to forward-flight operation (and back again) either by tilting the complete rotor system and having the wing then support the craft (i.e., a “tilt-rotor”) or by integrating the wing and rotor, tilting them forward together as a unit for forward flight (i.e., a “tilt-wing”). As the convertiplane concept developed from the 1940s on, the preferred configuration came to have two rotors placed laterally on the wing. Aerodynamically, this created a total fixed-wing area that was optimal for cruising flight. Because the convertiplane hovered and landed in the helicopter mode, less wing area was needed than required by a conventional airplane coming in for a landing.

Lichten and his colleagues did not invent the convertiplane concept. (The word “convertiplane” itself seems to have been first used around 1930, but spelled “convertaplane.”) In this chapter’s essay, we mentioned that Baynes Heliplane, a small British firm, designed a tilt-rotor in the 1930s but did not build it. In fact, the convertiplane concept dated back much further. As far back as 1843, Sir George Cayley, an ardent advocate of the fixed-wing, had designed such an aircraft, which he called the “Aerial Carriage”; the idea was for the two lifting rotors of his machine to be able to “de-pitch” their blades, thereby forming circular wings. In virtually every decade from Cayley’s time through World War I, one finds someone experimenting with some version of convertiplane. Then the pace of interest picked up greatly in the 1920s. Early in that decade, Chicago-area flight enthusiast Victor H. Leinweber designed a tilt-rotor prototype that, with the help of Glenn Curtiss, was actually built; a few years later, Henry Berliner experimented with his “helioplane,” previously discussed. American Stanley Y. Beach came up with a tiltable

rotor concept, one he submitted for the 1925–26 British helicopter design competition. Into that same competition, German engineer J. E. Noeggerath entered a plan for a tilt-screw monoplane. Many other convertiplane concepts surfaced at this time, including Spaniard Ramon Oriol's 1924 attempt to use oversized coaxial propellers that were tiltable relative to a machine's fuselage. But it was not until after World War II that enough progress had been made in the technology of the helicopter to make any sort of convertiplane a practical possibility.

By the time he published the two articles to follow, Robert L. Lichten had become Chief Experimental Project Engineer for Bell Helicopter Corporation. The first paper, dating from 1949, provided a thorough, quantitative engineering treatment of convertible aircraft design. The analysis covered conversion from helicopter rotor to propeller operation, rotor aerodynamic characteristics in propeller operation, and the effect of gravity on a lag-hinged rotor in propeller operation. In Lichten's view, to be successful, a convertiplane had to demonstrate a performance at both low and high speeds that was "essentially as good as the performance of comparable helicopters and airplanes in their respective flight regimes." Lichten felt that this was possible.

In the second paper below, read at an October 1957 Society of Automotive Engineers meeting in Los Angeles the same weekend that the Soviet Union launched Sputnik, Lichten evaluated the performance and operating characteristics of convertiplanes as they were beginning to take their place within a broad spectrum of possible VTOL machines.

Document 5-47 (a), Robert L. Lichten, "Some Aspects of Convertible Aircraft Design," Journal of the Aeronautical Sciences 16 (October 1949): 611–622.

SUMMARY

This paper is a contribution toward a quantitative engineering treatment of convertible aircraft design. A brief discussion of design requirements and proposed configurations is given. The analysis covers the following:

1. *Conversion from Helicopter Rotor to Propeller Operation.*—A semigraphical process for computing rotor characteristics during the conversion process when blade-section inflow angles can no longer be considered small is presented. Calculations for a typical case indicate that no unusual or undesirable rotor behavior occurs, blade flapping decreasing progressively from the magnitude existing in helicopter operation. The rotor is shown to operate efficiently throughout, indicating that aircraft performance is not impaired during the conversion interval.
2. *Rotor Aerodynamic Characteristics in Propeller Operation.*—It is shown that satisfactory propulsive efficiency can be obtained with isolated rotors having relatively low solidity and blade twist compared to conventional

propellers. In order to obtain good efficiency at high-forward speeds, it is necessary to operate the rotor at high pitch and power coefficient. In practice, this means that when a helicopter rotor is converted to propeller operation its tip speed must be reduced considerably. Model propeller test data are compared with calculations based on modified vortex theory, and it is shown that the calculation method yields reasonably accurate results for the somewhat unusual operating conditions of the rotor-propeller.

3. *Effect of Gravity on a Lag-Hinged Rotor in Propeller Operation.*—The undamped in-plane motion due to gravity excitation of a lag-hinged rotor blade is analyzed for operation with rotor axis horizontal. In the case of a three-bladed rotor, it is shown that the resulting hub vibratory loads are negligible. In the case of a two-bladed rotor, the amplitude of the vibratory force applied to the rotor hub is considerably greater than total blade weight, and therefore a two-bladed convertible rotor probably must be of the semirigid or rigid type to avoid this condition.

INTRODUCTION

Convertible aircraft, which combine the ability of the helicopter to take off vertically and hover with the ability of the airplane to fly at high speed over long distances, have been proposed in various forms for many years. Design requirements for moderately high-speed flight have been generally known for some time; however, it was not until the more pressing problems associated with the development of practical helicopters were solved and corresponding design knowledge for the low-speed part of the flight spectrum became available that such proposals could be given serious consideration.

In the writer's opinion, the primary requirements for successful convertible aircraft are that low- and high-speed performance be essentially as good as the performance of comparable helicopters and airplanes in their respective flight regimes and that the excellent controllability and maneuverability of present-day helicopters at zero and low air speeds be retained. As an airplane, the convertible aircraft must be able to fulfill an economic function. At low speed, it must be able to execute rapid and precise changes in air speed and air position, must be able to make safe landings after power failure in ground areas as small and restricted as those normally used for power-on operation, and must be relatively undisturbed by gusty air. Failure to meet these requirements would result in a degree of safety and utility too low to justify the cost of development.

DISCUSSION OF TYPES

A brief discussion of the more prominent proposed types of convertible aircraft is given here to indicate the reasons for the direction taken in the analysis. It should be emphasized that all statements made are matters of opinion at this time.

Two basic classes of direct-lift aircraft may be defined: (A) aircraft in which direct lift is obtained by imparting a relatively large downward acceleration to a relatively small mass flow of gases, as by use of rocket or turbojet engines; (B) aircraft in which direct lift is obtained by imparting a relatively small downward acceleration to a relatively large mass flow of atmospheric air, as by use of helicopter or cyclogyro rotor systems.

Class (A) fails to meet the previously stated requirements for convertible aircraft in that power failure during direct-lift operation would be disastrous, and therefore is not considered further. Class (B) will be limited to use of helicopter-type rotor systems for this discussion, and convertible aircraft in this class may be subclassified into two main groups, each having two subgroups, as follows:

1. Aircraft having one or more helicopter-type rotors as the principal source of lift in low-speed flight; for high-speed flight, rotor rotation is stopped.
 - (a) Longitudinal fuselage axis is approximately vertical at take-off and approximately horizontal at high speed; (b) longitudinal fuselage axis is approximately horizontal throughout the entire flight range.
2. Aircraft having one or more helicopter-type rotors with axes approximately vertical as the principal source of lift in low-speed flight; for high-speed flight, rotor axes are tilted to an approximately horizontal attitude in which the rotors act as propellers.
 - (a) Longitudinal fuselage axis is approximately vertical at take-off and approximately horizontal at high speed, and rotor axes are fixed with respect to fuselage; (b) Longitudinal fuselage axis is approximately horizontal throughout the entire flight range, and rotor axes tilt with respect to fuselage.

Type (1a) and (2a) represent entirely possible solutions. Type (1a) has been embodied in proposed aircraft having ram-jet or pulse-jet engines mounted at the tips of relatively rigid blades to drive the rotor for helicopter operation; for high-speed flight the blades are feathered and act as wings, while the jet engines provide direct propulsion. Type (2a) has been embodied in many designs, such as those proposed by Zimmerman, Young, Leonard, and Robins. In both these types, conversion from helicopter to airplane flight and return may be expected to require either a discontinuous maneuver in which control and excess power available are likely to be marginal for an appreciable time interval. The required 90° range of fuselage attitude would probably make such an aircraft unsuitable for carrying more than one or two persons. Autorotational descent in the event of power failure, with sufficient forward speed to minimize sinking speed and to provide a choice of landing sites, would be a difficult and awkward maneuver at best. For type (2a), the coaxial

rotor arrangement, with two superimposed oppositely rotating rotors, is most often used, leading to solidity values that are objectionably high for propeller operation, as will be shown later.

An early example of type (1b) was the Herrick Convertaplane demonstrated with partial success in 1937. Other designs of this type have been proposed by Wilford and Gazda. Such aircraft generally require separate power transmission systems for driving the rotor in helicopter flight and for propelling the aircraft after stopping the rotor. Simplification in this respect might be effected by use of some form of jet drive for both configurations. A one-bladed rotor offers advantages for this type; however, such a rotor presents many new problems even for use on conventional helicopters. Mechanical requirements for stopping and starting large rotors in flight are likely to be severe.

Type (2b) embodies, in general, the most conventional configurations as suggested by Blount, LePage, Stuart, DuMonge, and others. This type appears to be the most suitable for large cargo and personnel transport aircraft but has the disadvantage of a relatively heavy structure and power transmission system. However, it introduces the least new design problems, permits adequate provision for safe operation after power failure, and seems most promising for immediate development. Therefore the analysis presented in the following sections is directed primarily toward this type, although it is applicable in many respects to other types discussed above.

Additional discussion is given in reference 9.

NOTATION

The plane of the rotor disc is a plane perpendicular to the rotor shaft axis passing through the rotor hub.

- a = slope of blade section lift coefficient curve, per rad.
- a_m = coefficient of $\cos m\psi$ term in expression for β
- A_m = coefficient of $\cos m\psi$ term in expression for γ
- b = number of blades per rotor
- b_m = coefficient of $\sin m\psi$ term in expression for β
- B = tip-loss factor
- B_m = coefficient of $\sin m\psi$ term in expression for γ
- c = chord of constant-chord blade, ft.
- c_{d_0} = blade section profile drag coefficient
- c_l = blade section lift coefficient
- C_p = rotor shaft power coefficient = $P/[(1/2)\rho(\omega R)^3\pi R^2]$
- C_T = rotor thrust coefficient = $T/[(1/2)\rho(\omega R)^2\pi R^2]$
- D = rotor diameter, ft.
- e_2R = distance from rotor shaft axis to lag hinge, ft.
- F = Goldstein propeller theory factor (κ in reference 2)
- F_c = centrifugal force on one blade, lbs.

- F_y = force on rotor hub in positive y direction, lbs.
 F_s = force on rotor hub in positive z direction, lbs.
 I_2 = moment of inertia of blade about lag hinge, slug-ft.²
 k = $\tan^{-1}(c_{d0}/c_l)$
- $$K_1 = I_2 - \frac{W_b R^2}{g} e_2 L_2 \frac{e_2 + I_1}{e_2 + I_2}$$
- $$K_2 = W_b L_1 R / 2\omega^2$$
- $L_1 R$ = distance from lag hinge to blade center of gravity, ft.
 $L_2 R$ = distance from lag hinge to point of application of resultant F_s , ft.
 n = rotor rotational speed, revolutions per sec.
 P = rotor shaft power, ft.lbs. per sec.
 $p\omega$ = pitching angular velocity of rotor shaft axis, positive nose up, rad. per sec.
 r = radius to a blade element, ft.
 R = radius to blade tip, ft.
 T = rotor thrust, vector coincident with rotor shaft axis, lbs.
 $u_p \omega R$ = component of resultant velocity at a blade element, parallel to rotor shaft axis, ft. per sec.
 $u_n \omega R$ = component of resultant velocity at a blade element, normal to blade span axis and parallel to rotor disc plane, ft. per sec.
 v = average induced velocity at rotor disc, normal to rotor disc plane, ft. per sec.
 V = true air speed along flight path, ft. per sec.
 w = total induced velocity at a blade element (profile drag neglected), ft. per sec.
 W_0 = resultant of V , and ωr at a blade element, ft. per sec.
 W = resultant of W_0 and w at a blade element, ft. per sec.
 W_b = weight of one blade, lbs.
 x = r/R
 y = fixed horizontal coordinate in plane of rotor disc, propeller operation, ft.
 z = fixed vertical coordinate in plane of rotor disc, propeller operation, ft.
 α = angle between flight path and rotor disc plane, positive when leading edge of disc is raised, rad.
 α_b = blade element angle of attack relative to zero-lift chord line, rad.
 β = flapping angle between blade span axis and rotor disc plane, positive upward, rad.
 γ = lag angle between projections in rotor disc plane of blade span axis and line connecting rotor shaft axis and lag hinge, rad.
 ϵ = $\tan^{-1}(w/W)$, rad.
 η = propulsive efficiency, propeller operation, = TV/P

- η_0 = rotor profile efficiency = $T[v - V \sin(\alpha + \alpha_1)]/P$
 θ = pitch angle between blade section zero-lift chord line and rotor disc plane = $\theta_0 + \theta_{1x}$, rad.
 λ = inflow ratio = $(V \sin \alpha - v)/\omega R$
 μ = advance ratio = $(V \cos \alpha)/\omega R$
 ρ = air density, slugs per cu.ft.
 σ = rotor solidity = $bc/\pi R$
 ϕ_0 = $\tan^{-1}(V/\omega R)$, rad.
 ϕ = $\phi_0 + \epsilon$, rad.
 ψ = blade azimuth angle measured from downwind or top position, rad.
 ω = rotor rotational speed = $d\psi/dt$, rad. per sec.

CONVERSION FROM LIFTING ROTOR TO PROPELLER OPERATION

INTRODUCTION

In converting from lifting rotor to propeller operation in flight, it is highly desirable that the transition be made without requiring unusual piloting technique, penalizing performance appreciably, or causing erratic rotor behavior. The type of maneuver envisioned for the conversion process is as follows: The aircraft attains maximum forward speed as a helicopter. The pilot then actuates the conversion mechanism, causing the rotor axis to swing from an approximately vertical to an approximately horizontal attitude parallel to the flight path. This process occupies a time interval of the order of 15 sec., at the end of which the rotor is operating as a propeller and the aircraft weight load is carried by fixed wings. Conversion from propeller to lifting rotor operation is the reverse of the process described above.

EXPERIMENTAL DATA

Flight tests of a convertible aircraft model are reported in reference 7. Using the classifications given previously, this model was of type (2a). It had a 39-in. diameter, two-bladed rotor, and gimballed to permit flapping and feathering and was driven by an electric drill motor. A 48-in. span by 8-in. chord wing was mounted below the rotor with chord line parallel to rotor shaft axis. The model was mounted at the end of a dural "fish pole" 18 ft. long and was flown in a circular path around the operator. The model was free to pivot about the pole axis, and the operator had longitudinal cyclic feathering control, collective pitch control, and motor torque control. Thus, the operator controlled the model about the pitch axis by means of rotor thrust vector inclination, but the model was restrained from yawing and rolling.

In flight, the transition from hovering to high-speed flight with rotor axis horizontal could be made rapidly or slowly and was smooth and continuous. The model could be flown steadily with the rotor shaft axis in a range of attitudes from vertical

to horizontal. It was also possible to perform loops and vertical figure eights. Rotor behavior was normal throughout all maneuvers.

Approximate measurements of power input gave evidence of a sharp increase in power required in the vicinity of $\alpha = -60^\circ$ over that required in hovering and in forward flight at smaller values of α . This is attributed to operation of the wing in a stalled attitude at the relatively high forward speed corresponding to this axis inclination. As axis inclination is further increased, the wing would be expected to unstall with a consequent drop in power required, followed by a rise as maximum forward speed is attained with $\alpha \cong -90^\circ$. Such a trend is exhibited by the test data. A curve showing the approximate variation of power required with rotor axis inclination at one rotational speed is given in Fig. 1. This curve was cross-plotted from faired curves based on the reference 7 data. No airspeed data were recorded.

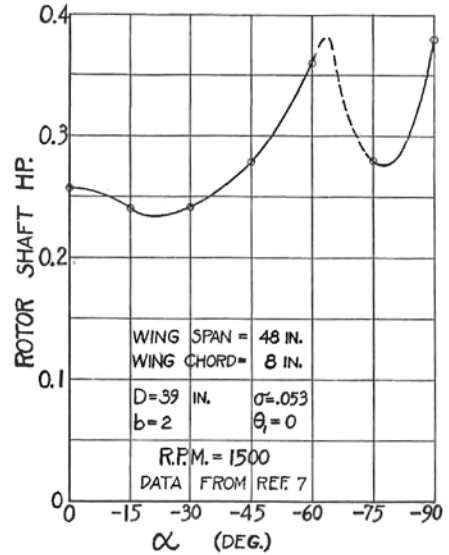

FIG. 1. Power required variation with rotor axis inclination from model flight-test data. Model wing chord line fixed parallel to rotor axis.

ANALYSIS

During the conversion process, the principal conditions of operation which might be expected to lead to unusual rotor behavior because of differences from steady-state lifting rotor or propeller operating conditions are: (a) airflow interference caused by nonrotor parts of the aircraft; (b) the pitching angular motion of the rotor hub as the rotor axis is converted from an approximately vertical to an approximately horizontal attitude; (c) the large inflow angles, together with continuous variation of inflow angle around the blade path, which are experienced by the blade sections.

Interference effects depend on the particular configuration of the subject aircraft. They may be considered as superimposing on the airflow pattern, surrounding an isolated rotor in a given operating condition, a velocity and static pressure variation at each point in the pattern caused by the influence of other parts of the aircraft. Good design will minimize such effects; however, there are instances of difficulties encountered with propeller installations in conventional aircraft due to interference. In the present case, rotor behavior difficulties due to interference are not expected to appear, since such a rotor is already designed to accommodate the large variations with blade azimuth position and forward speed of section angle of attack and relative airflow velocity experienced in helicopter operation. Therefore

interference effects are not herein considered further, although they may have a considerable effect on stability and control in particular cases.

It may be shown, exactly in the case of a flapping- or teetering-type lifting rotor at zero air speed and approximately for such a rotor in forward flight, that a steady pitching angular velocity of the hub will produce lateral flapping

$$b_1 = -\frac{p\omega}{\omega} = -p$$

due to aerodynamic damping of the pitching motion and will produce longitudinal flapping due to blade mass whose magnitude is dependent on the ratio of blade moment of inertia about the flapping hinge to air density and which, for typical rotor blades, is approximately

$$a_1 = -2.5p$$

These values should still be good approximations for flapping due to hub pitching velocity during the conversion process. For an angular motion of 90° in 15 sec., about 0.10 rad. per sec., and a typical rotor speed $\omega = 25$ rad. per sec., the resultant flapping amplitude would be

$$\sqrt{a_1^2 + b_1^2} = 2.7p = 0.011 \text{ rad.} = 0.6^\circ$$

This may be considered negligible so far as any significant effect on rotor behavior is concerned, and this conclusion is supported by the fact that present small helicopters can obtain rates of roll or pitch in excess of 1 rad. per sec. in maneuvers without experiencing abnormal rotor behavior. Therefore it has been considered permissible to neglect the effect of hub pitching velocity in analyzing rotor behavior during conversion, which permits a quasi-static treatment in that steady-state operation at rotor angles of attack intermediate between lifting rotor and propeller conditions may be assumed.

The aerodynamic analysis of rotor operation in this intermediate range is complicated because the inflow angle cannot be considered a small angle as in lifting rotor analysis, while conditions at any blade station do not remain constant with respect to blade azimuth as in propeller analysis. This leads to a strip analysis with graphical integration for rotor characteristics.

In addition to the assumptions that interference effects and hub pitching velocity may be neglected, the analysis is based on the following: (a) Only the component of induced velocity normal to the rotor disc plane need be considered. For this component a mean value over the disc as given by momentum theory may be used. (b) Only the constant and first harmonic components of the blade flapping motion need be considered. (c) Eq. (2) of reference 8,

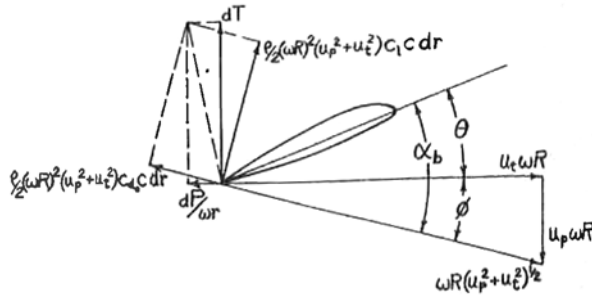

FIG. 2. Schematic diagram of a typical blade section for conversion analysis.

$$\tan \alpha = \frac{\lambda}{\mu} + \frac{C_T}{4B^2\mu}(\lambda^2 + \mu^2)^{1/2} \tag{1}$$

remains valid during conversion. This equation includes an approximation for lifting rotor induced flow, based on simple momentum theory and analogy with finite airfoil theory.

The above assumptions are equivalent to those used in standard blade-element analysis of lifting rotors. Accordingly,

$$u_i = x + \mu \sin \psi \tag{2}$$

$$u_p = \lambda - x(a_1 \sin \psi - b_1 \cos \psi) - \mu \cos \psi (a_0 - a_1 \cos \psi - b_1 \sin \psi) \tag{3}$$

Referring to Fig. 2,

$$\alpha_b = \theta_0 + \theta_1 x + \tan^{-1} (u_p/u_i)$$

$$\frac{1}{\sigma} \frac{dC_T}{dx} = (u_i^2 + u_p^2)(c_l \cos \phi + c_{d_0} \sin \phi) \tag{4}$$

$$\frac{1}{\sigma} \frac{dC_P}{dx} = x(u_i^2 + u_p^2)(c_{d_0} \cos \phi - c_l \sin \phi) \tag{5}$$

In applying these expressions, blade airfoil section characteristics are taken from a plot that covers a large range of α_b extending well into the negative stall region.

No further details of the analysis will be given except for the following outline of the procedure followed:

- a. For a given rotor, choose a forward speed and value of α for analysis. A value of μ is derived.
- b. Select a range of values of λ and θ_0 appropriate to the chosen α .
- c. Assuming zero blade flapping, calculate C_T for each possible combination of λ and θ_0 by evaluating Eq. (4) over a range of values of x at intervals of ψ around the blade path (every 30° is recommended). The resulting values of dC_T/dx at each value of x are averaged with respect to ψ , and C_T

is obtained by graphical integration. The tentative assumption is made that thus-obtained values of C_T are little affected by introduction of actual blade flapping.

- d. Sets of λ , μ , and C_T values from (c) are substituted in Eq. (1), yielding values of α which are plotted versus the assumed λ and θ_0 values and the calculated C_T values. Intersections at the originally assumed α value determine possible operating conditions (satisfying both momentum and blade-element conditions).
- e. For each of the possible conditions, a substitute effective value of λ is determined by substituting the corresponding C_T and θ_0 in Eq. (14) of reference 8. This is then used to compute flapping coefficients a_0 , a_1 , and b_1 from Eqs. (11) to (13) of reference 8.
- f. Using these flapping coefficients, values of C_T and C_p are computed following the procedure outlined in (e) for the range of possible operating conditions. Using the dC_T/dx values obtained during this computation, values of $x(dC_T/dx)$ are computed and integrated over the blade radius for each blade azimuth position. This quantity is proportional to the aerodynamic thrust moment about the flapping or teetering hinge, and a harmonic analysis of its variation with ψ is performed. A corresponding procedure is followed for the zero-flapping cases. The correct values of a_1 and b_1 are determined by interpolation between the two sets of first harmonics obtained from the

$$\int_0^B x \left(\frac{dC_T}{dx} \right) dx$$

variation with ψ . It may be assumed that the sine component varies linearly with a_1 and the cosine component linearly with b_1 ; for a hinged rotor, a_1 and b_1 are such that the first harmonic components are reduced to zero.

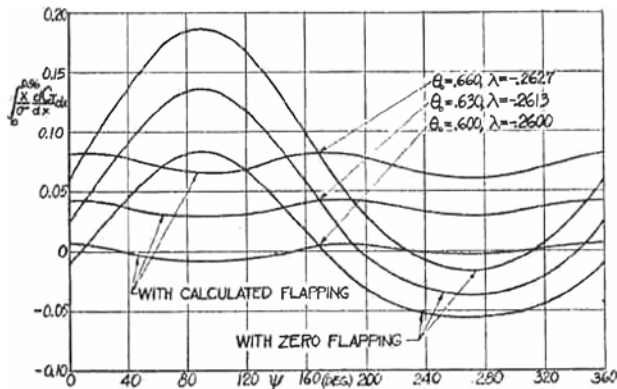

FIG. 3. Calculated variation of thrust moment coefficient with azimuth angle for example rotor. $\alpha = -60^\circ$; $\mu = 0.15$; $\theta_1 = -20^\circ$; $\sigma = 0.04$.

In the actual calculations made, it was found that the flapping coefficients obtained in step (e) produced this result directly within the limits of accuracy of the method so that interpolation was unnecessary. This is indicated by the example shown in Fig. 3. In all cases the final flapping values should be sufficiently close to those calculated in step (e) that the C_T values obtained in step (f) do not require recalculation. This conclusion is supported by the small changes between values for zero and for calculated flapping shown in Table 1 for the example case. It has been assumed that similar reasoning may be applied to C_P .

TABLE 1. $\alpha = -60^\circ, \mu = 0.15, \theta_1 = -20^\circ$

θ_0 (rad.)	0.600	0.630	0.660
λ	-0.2600	-0.2613	-0.2627
C_P/σ (zero flapping)	-0.0125	0.0328	0.0822
C_T/σ (calculated flapping)	-0.0161	0.0334	0.0827

- g. In the $\alpha = -90^\circ$ case (propeller operation), a considerable simplification can be made, since there is no variation with ψ and first harmonic flapping is zero. The general method outlined above may still be followed in order to obtain a comparative set of results for this limiting condition.

Some results for a set of calculations with $\alpha = -60^\circ$ are presented as an example. Table 1 shows a comparison of C_T values as computed for cases with zero and with calculated flapping. Differences are within the limits of accuracy of the computations.

In Fig. 3, the variation of thrust moment coefficient about the flapping hinge is shown for these cases. It may be noted by inspection that the calculated flapping reduces the first harmonic variations essentially to zero. In Fig. 4, final rotor characteristics for this operating condition are shown.

INTERPRETATION OF RESULTS FOR EXAMPLE ROTOR

A summary of results obtained in a complete analysis of the example rotor operated to absorb constant shaft power at a typical helicopter tip speed,

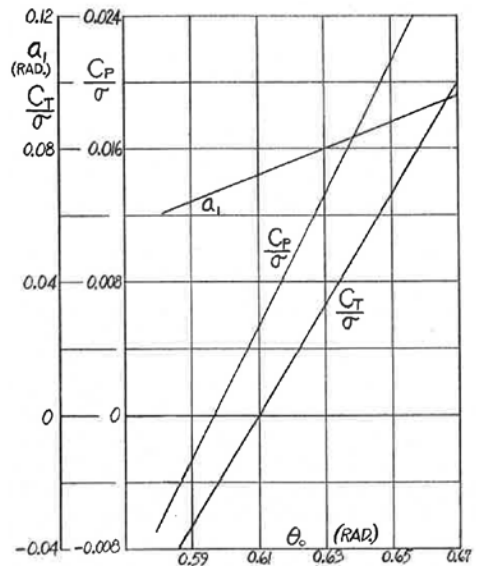

FIG. 4. Variation of longitudinal flapping, thrust, and power coefficients with blade pitch for example rotor. $\alpha = -60^\circ; \mu = 0.15; \sigma = 0.04; \theta_1 = -20^\circ$.

TABLE 2. Rotor disc loading = 3.5 lbs. per sq. ft. (in helicopter operation). Rotor power loading = 9.8 lbs. per shaft hp. $\omega R = 612$ ft. per sec., $\sigma = 0.04$. $\rho = 0.00238$ slug per cu.ft., $\theta_1 = -20^\circ$

α (Deg.)	Flight Condition	V (M.P.H.)	θ_0 (Deg.)	μ	λ	a_1 (Deg.)	T (%)	η_0
0.0	Hovering	0	27.0	0.0	-0.0665	0.0	100.0	0.72
-20.3	Helicopter high speed	133	28.8	0.30	-0.1130	8.05	100.0	0.77
-30.0	Conversion	125	30.0	0.26	-0.1542	6.51	61.4	0.83
-60.0	Conversion	125	36.8	0.15	-0.2617	4.86	27.3	0.74
-90.0	Conversion complete	125	39.8	0.0	-0.3014	0.0	20.1	0.66

including comparative data for helicopter operation, is given in Table 2. It may be seen that longitudinal flapping coefficient a_1 decreases steadily during conversion, while required θ_0 increases, as would be expected with decreasing transverse and increasing normal flow components. Rotor thrust is given in per cent of thrust for helicopter operation. In order to indicate how much of the power input to the rotor is expended usefully during the conversion process, a profile efficiency has been defined as

$$\eta_0 = (T/p) [v - V \sin (\alpha + a_1)] \quad (6)$$

or approximately, since a_1 is a small angle,

$$\eta_0 = -(T/p) (\lambda + \mu a_1) \omega R \quad (6a)$$

This expression represents, to a close approximation, the ratio of the rate of useful work done on the air flowing through the rotor tip path plane to the shaft power input. It reduces to the familiar rotor figure of merit in the case of hovering flight. It will be noted that, throughout nearly the entire conversion range of α , profile efficiency exceeds that for hovering. This indicates that there should be no detrimental effect on performance during the conversion process insofar as rotor characteristics are concerned. In general, the analysis indicates that a conversion process of the type considered will introduce no undesirable rotor behavior or piloting requirements and should therefore be entirely practical.

ROTOR AERODYNAMIC CHARACTERISTICS IN PROPELLER OPERATION

GENERAL CONSIDERATIONS

In order to obtain high-forward speeds as an airplane after conversion from lifting rotor to propeller operation, reasonably high-rotor propulsive efficiency is

required. It can be shown that operating a typical helicopter rotor as a propeller, with no change in rotational speed or rotor geometry (except for increasing blade pitch to maintain constant power absorption), results in poor propulsive efficiency at air speeds above normal helicopter maximum level flight speeds. This poor performance is a consequence of the low disc loadings that are required in helicopter design to obtain satisfactory low-speed and power-off flight performance. The condition may be explained qualitatively as follows:

The thrust produced by a rotor operating with constant power input is, roughly speaking, inversely proportional to the airflow velocity component normal to the rotor tip-path plane. For a typical rotor operating as a propeller at an air speed of, say, 170 m.p.h., this normal velocity component is about ten times greater than in hovering as a helicopter. Rotor thrust is thus of the order of one-tenth of hovering thrust. In hovering, a representative blade section might operate at $c_l = 0.5$ with a section lift/drag value of 40; accordingly, in high-speed flight the same section would operate at about $c_l = 0.05$ with a lift/drag value of about 5. Had such a rotor been required to operate *only* in the high-forward speed propeller condition, it could have been so designed that a mean blade section would operate near best lift/drag with a consequent large improvement in propulsive efficiency at high speed.

From this explanation it is clear that to improve propulsive efficiency at high speed it is at least necessary to increase the mean blade-section lift coefficient in this operating condition. This is equivalent to increasing rotor power coefficient, which might be done in the following ways:

- a. Increase the power input to the rotor. This is impractical because of the already low power loadings required for adequate performance in helicopter operation.
- b. Use contractable blades to decrease rotor diameter and tip speed during propeller operation. This would be an excellent solution if structural difficulties could be overcome. It has the disadvantage that, in the case of twisted blades, telescoping the blades would decrease overall blade twist in an operating regime where increased twist is desirable.
- c. Decrease rotational speed for propeller operation. This appears to be the only practical solution at present. It requires the use of a variable-speed transmission and requires provision for the increased rotor torque realized when rotor speed is decreased.

An associated problem is provision of proper blade twist. In helicopter operation, moderate amounts of blade twist have the advantageous effects of reducing hovering induced power losses, reducing peak blade bending moments, and increasing the forward speed at which stall of the retreating blade tip begins to occur. However, it is generally agreed that the region of diminishing returns is reached when more than about 10° total twist from blade root to tip is used. Although never demonstrated experimentally, it has been presumed that excessive blade twist

would lead to reduced performance in autorotation due to stalling of the blade root sections and, possibly, to an undesirable blade bending moment distribution.

Optimum total twist for conventional propeller blades is of the order of 45°. The amount of twist used in a particular case depends on the design advance ratio for the propeller: the higher the advance ratio, the less twist required. When a propeller operates with non-optimum twist distribution, propulsive efficiency suffers because of increased profile and induced losses.

The conflicting blade twist requirements for lifting rotor and propeller operation may be met in two ways: (a) use blades whose twist may be varied, or (b) use a compromise permanent twist distribution. The first alternative would be preferable if a reliable method for varying blade twist were available. At present, it is thought necessary to adopt the second alternative. Accordingly, for the calculations of this paper untapered blades with 20° linear twist from root to tip have been assumed. It may be mentioned in passing that preliminary analyses for such blades in lifting rotor operation have indicated that, compared to equivalent untwisted blades, blade bending moments at high-forward speed are somewhat less severe, and that the initial point of stall on the retreating blade is moved inboard from the tip to about $x = 0.65$ and occurs at a higher forward speed. There is no evidence of impairment of autorotational performance, but the calculations do not account for losses due to blade stall.

EXPERIMENTAL DATA

Available test data on rotors operating as propellers are extremely limited, and, except for a few cases, propeller test data cannot be used because of wide differences between conventional propellers and the proposed type of rotor in blade twist, plan form, and solidity.

The General Electric Company has kindly made available unpublished results of extensive model tests made under its auspices. A summary of some of these data is

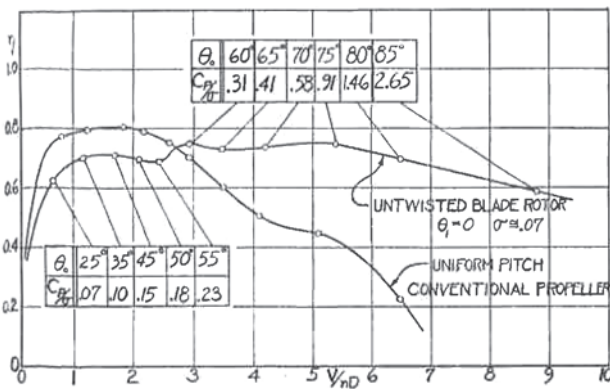

FIG. 5. Envelope propulsive efficiency curves from General Electric Company data. $\alpha = -90^\circ$; $D = 2$ ft.; $b = 2$.

presented in Fig. 5, where an envelope propulsive efficiency curve obtained with a 2-ft. diameter, two-bladed model rotor with untwisted blades operated through a large range of pitch angles is shown. Pitch angles and power coefficients are spotted along this curve to indicate the operating condition. A large spinner with diameter approximately 25 per

cent of rotor diameter was used on this rotor, and spinner tare drag was added to observed thrust in calculating propulsive efficiency; therefore, resulting efficiency values are probably somewhat too high, since the inner portions of such untwisted blades normally would be stalled negatively in propeller operation, except at the highest pitch angles. For comparison, a 2-ft. diameter two-bladed model of a conventional propeller of uniform design pitch was tested concurrently, and the envelope propulsive efficiency curve for this model is also shown in Fig. 5. It should be noted that these tests were carried through much higher values of the advance ratio, V/nD , than is normal for propeller operation. For example, in cruising flight the DC-3 airplane operates at about $V/nD = 1.2$. The conventional propeller model shows decided superiority in the low-advance ratio range, while the untwisted-blade rotor model is superior above $V/nD = 3.0$. It is notable that a propulsive efficiency of 0.70 was obtained with the untwisted-blade rotor at 80° pitch, and, for a considerable pitch range below this, somewhat better efficiency is realized. (The low Reynolds Number of the model tests compared to full scale probably resulted in propulsive efficiency values lower than would be obtained in full-scale tests.)

A rapid increase in power coefficient required for operation at envelope efficiency as pitch is increased is apparent. As a consequence, with constant power input would require that tip speed for $\theta_0 = 80^\circ$ be only 40 per cent of the tip speed required at $\theta_0 = 35^\circ$. These results indicate that even an untwisted-blade rotor might perform satisfactorily as a propeller under proper operating conditions.

In Fig. 6 test results for the untwisted blade rotor at a particular pitch setting are compared with values calculated by the method described below. The fair agreement indicates that the calculation method provides a reasonably close prediction of magnitude and trend. Part of the discrepancy may be explained by the fact that the rotor assumed in the calculations had lower solidity and blade sections operating at a much higher mean Reynolds Number than the model rotor, which would tend to reduce induced and profile losses for the calculations in comparison to the

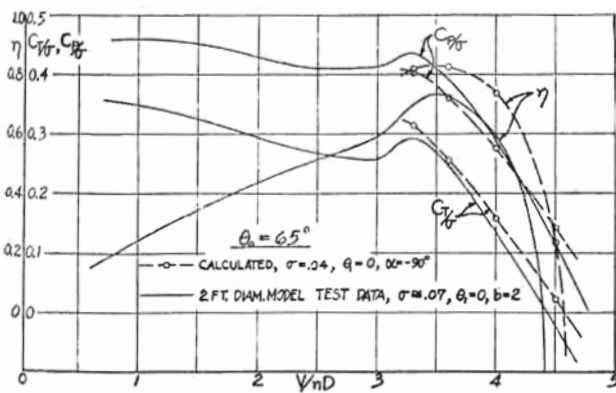

FIG. 6. Comparison of calculated and experimental untwisted-blade propeller characteristics.

test data.

A second source of applicable data is found in reference 1, where excellent data are presented from tests of 34-in. diameter model propellers, including several having unusually low amounts of blade twist and roughly constant chord from shank to tip. The twist distributions for two of the model blades are shown in Fig. 7; for purposes of this

analysis it has been assumed that test results for propellers using these blades would be closely approximated by untapered blades having an equivalent linear twist distribution given by the dashed lines of the figure. From Fig. 1 of reference 1, the estimated effective value for the solidity of these propellers is $\sigma = 0.120$. This is about triple the solidity desired for the type of rotor under discussion. However, it has been assumed that, for a given operating condition, thrust and torque coefficients vary directly with solidity, and propulsive efficiency is independent of solidity. These assumptions are valid only for conditions where axial and rotational induced velocities are negligibly low, which conditions are approximately fulfilled in the present cases.

In Fig. 8 propulsive efficiency curves are shown for a typical low-solidity rotor operating at several different power coefficients. These curves were interpolated from the test data of reference 1 in accordance with the assumptions stated above. In order to show their physical significance, the Fig. 8 curves have been replotted in Fig. 9 in terms of the operation at various tip speeds of a 19-ft. diameter rotor absorbing 100 shaft hp. The curve for 671 ft. per sec. tip speed shows propeller operation at a tip speed that might be used for a typical modern rotor in helicopter operation. Propeller performance is poor in this condition. When tip speed is reduced, a considerable increase occurs both in peak efficiency and in air speed

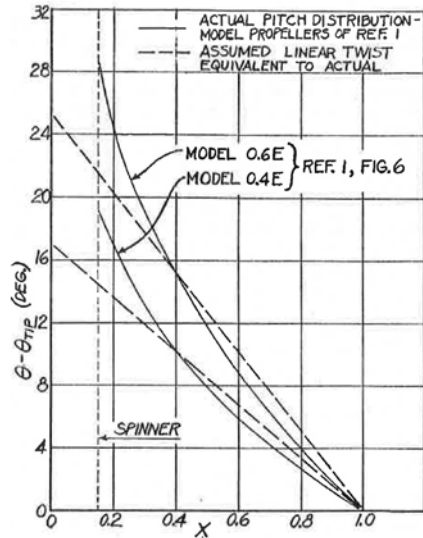

FIG. 7. Comparison of actual and assumed equivalent blade pitch distributions.

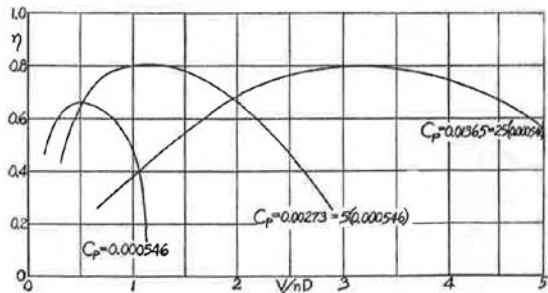

FIG. 8. Propulsive efficiency curves for operation at constant power coefficient, based on model test data. $\sigma = 0.04$; $\theta_1 = -20^\circ$; $\alpha = -90^\circ$.

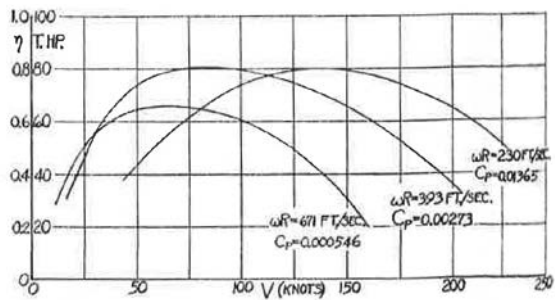

FIG. 9. Effect of tip speed on propulsive efficiency for constant power operation, based on model test data. $\alpha = -90^\circ$, $D = 19$ ft.; $\sigma = 0.04$; $\theta_1 = -20^\circ$; b.hp. = 100; altitude = sea level.

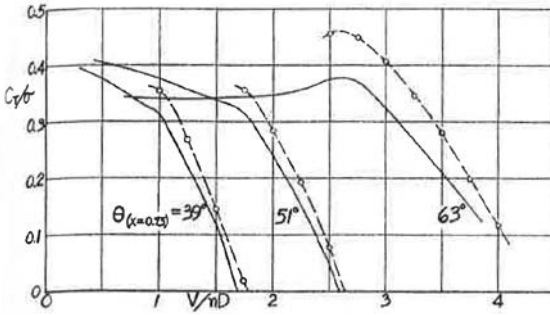

FIG. 10. Comparison of calculated and model test thrust coefficient variation with advance ratio. $\alpha = -90^\circ$. — Test data, 34 in. diameter, $\sigma = 0.12$, interpolated for $\theta_1 = -20^\circ$; —○— Calculated, $\sigma = 0.04$, $\theta_1 = -20^\circ$.

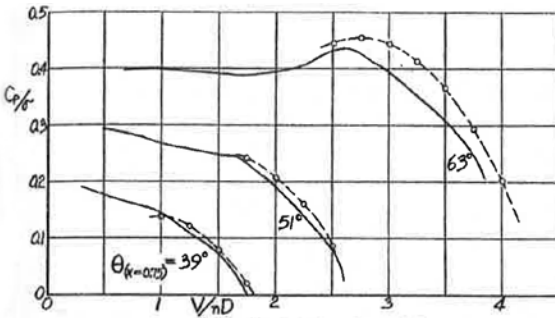

FIG. 11. Comparison of calculated and model test power coefficient variation with advance ratio. $\alpha = -90^\circ$. — Test data, 34 in. diameter, $\sigma = 0.12$, interpolated for $\theta_1 = -20^\circ$; —○— Calculated, $\sigma = 0.04$, $\theta_1 = -20^\circ$.

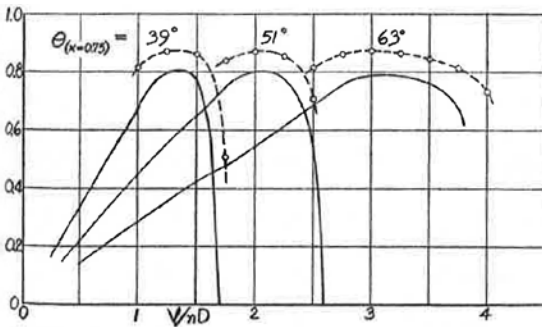

FIG. 12. Comparison of calculated and model test propulsive efficiency variation with advance ratio. $\alpha = -90^\circ$. — Test data, 34 in. diameter, $\sigma = 0.12$, interpolated for $\theta_1 = -20^\circ$; —○— Calculated, $\sigma = 0.04$, $\theta_1 = -20^\circ$.

for peak efficiency. The curve for 230 ft. per sec. tip speed represents acceptable propeller performance for a moderately high-speed airplane.

In Figs. 10, 11, and 12, some of the test curves of reference 1 for constant pitch settings are shown as interpolated for 20° linear blade twist. (The nominal pitch settings of reference 1 have been increased by 3° to account for the mean difference between nominal and zero-lift blade chord lines as indicated by Fig. 3 of reference 1.) These are compared with values calculated by the method described in the next section. Agreement is fair, although differences appear to increase with increasing pitch. The calculations yield peak propulsive efficiencies about 10 per cent too high. As in the case of the General Electric Company data, part of the discrepancies may be explained by the fact that the rotor assumed in the calculations had a much lower solidity and had blade sections operating at a higher mean Reynolds Number than the model propeller. Also, hub drag was not accounted for in the calculations. On the basis of these comparisons, it is probably correct to conclude that the calculation method will give reasonably accurate results for the somewhat unusual operating conditions required for the rotor-propeller.

CALCULATED AERODYNAMIC CHARACTERISTICS

The method of propeller analysis used for the calculations of this paper is an adaptation of the methods of references 2 and 3, which are based on standard vortex theory with Goldstein corrections. In reference 3 a comparison between experiment and calculations by this method is shown, in which excellent agreement was obtained through $V/nD = 6.0$ in spite of blade loadings that varied widely from that on which the Goldstein theory is based. In the present case, blade loadings vary more widely from that of the Goldstein theory than did the loadings of reference 3; however, it is thought that reasonable agreement should still be obtained.

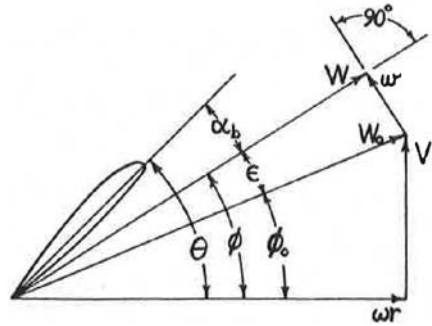

FIG. 13. Schematic diagram of a typical blade section in propeller operation. $\alpha = -90^\circ$.

A diagram of the flow condition at a typical blade element is shown in Fig. 13. That part of the induced velocity which is due to profile drag is neglected. ϵ is a small angle.

The fundamental relation of the vortex propeller theory as modified by Goldstein may be written as

$$w = \frac{BcWc_l}{8\pi rF \sin \phi} \tag{7}$$

or

$$\tan \epsilon = \frac{w}{W} = \frac{\sigma c_l}{8xF \sin \phi} \tag{7a}$$

From the diagram, Fig. 13,

$$W = \left(\frac{\omega r}{\cos \phi} \right) - w \tan \phi = \left(\frac{\omega r}{\cos \phi} \right) - W(\tan \epsilon)(\tan \phi) \tag{8}$$

$$W \sin \phi = \frac{\omega r}{(\cot \phi + \tan \epsilon)} \tag{9}$$

Then,

$$\begin{aligned} \frac{dC_T}{dx} &= \frac{1}{(\rho/2)(\omega R)^2 \pi R^2} R \frac{dT}{dr} \\ &= \frac{R}{(\rho/2)(\omega R)^2 \pi R^2} \times (\rho/2) W^2 bc (c_l \cos \phi - c_{d_0} \sin \phi) \\ &= 8Fx^3 (\tan \epsilon) \frac{\cot \phi - \tan k}{(\cot \phi + \tan \epsilon)^2} \end{aligned} \tag{10}$$

$$\begin{aligned} \frac{dC_p}{dx} &= \frac{1}{(\rho/2)(\omega R)^3 \pi R^2} R \frac{dP}{dr} \\ &= \frac{R}{(\rho/2)(\omega R)^2 \pi R^3} \times (\rho/2) W^2 bcr (c_l \sin \phi + c_{d_0} \cos \phi) \\ &= 8Fx^4 (\tan \epsilon) \frac{1 + (\cot \phi)(\tan k)}{(\cot \phi + \tan \epsilon)^2} \end{aligned} \tag{11}$$

Using the above expressions, calculations were made for a range of blade radial stations and pitch angles, and a range of section angles of attack at each combination of radial station and pitch angle. Aerodynamic characteristics for the NACA

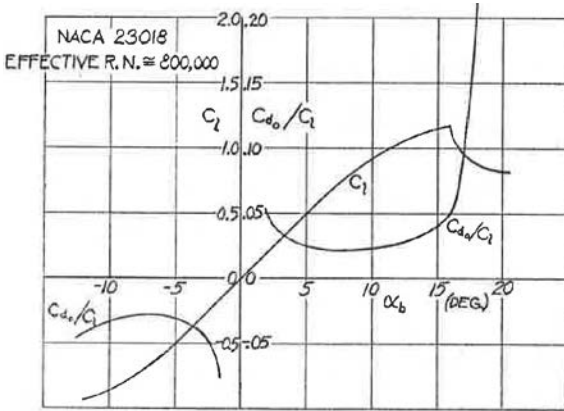

FIG. 14. Blade section characteristics used for propeller performance analysis.

23018 blade section estimated from data of references 4, 5, and 6 are shown in Fig. 14. The accuracy of the method is not sufficient to justify consideration of Reynolds Number variation with section radius. A sample calculation is shown in Table 3. Results for each radial station were plotted as curves of $C_{T/\sigma}$ and C_p/σ versus V/nD for constant θ .

Having a complete set of blade-element characteristics curves for blade stations $x = 0.15, 0.30, 0.45, 0.60, 0.75, 0.85,$ and 0.95 and for the operating range of section pitch angles, thrust and torque coefficient grading curves were constructed for the desired pitch settings and blade twist distributions at intervals of advance ratio to provide comparisons with the model test data. A typical set of these grading curves is shown in Fig. 15. The areas under the grading curves correspond to the thrust or torque coefficients for their respective operating conditions.

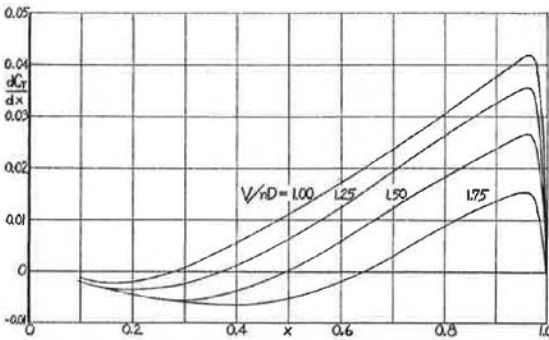

FIG. 15. Typical calculated thrust coefficient grading curves. $\theta_{(x=0.75)} = 39^\circ; \theta_1 = -20^\circ; \sigma = 0.04$.

Comparisons of calculated and test results are shown in Figs. 6, 10, 11, and 12. These have been discussed previously.

TABLE 3. Sample Calculation of Blade Element Characteristics

(1) x	0.60
(2) θ (deg)	45.0
(3) α_b (deg.) (assumed)	8.0
(4) c_l (Fig. 14)	0.77
(5) $\tan k$ (Fig. 14)	0.0230
(6) $\phi = \theta - \alpha_b$ (deg.) = (2) - (3)	37.0
(7) $\sin \phi = \sin$ (6)	0.602
(8) $F(b = 3)$ (from reference 2)	0.770
(9) σ	0.040
(10) $\tan \epsilon = \sigma c_l / 8x F \sin \phi =$ (9) (4)/8(1) (7)	0.01384
(11) ϵ (deg.) = 57.3 (10)	0.79
(12) $\phi_0 = \phi - \epsilon$ (deg.) = (6) - (11)	36.21
(13) $V/nD = \pi x (\tan \phi_0) = \pi$ (1) \tan (12)	1.381
(14) $\cot \phi = \cot$ (6)	1.327
(15) $\cot \phi - \tan k =$ (14) - (5)	1.304
(16) $(\cot \phi + \tan \epsilon)^2 = [(14) + (10)]^2$	1.800
(17) $8Fx^3 \tan \epsilon = 8(8) (1)^3 (10)$	0.01840
(18) $dC_T/dx =$ (17) (15)/(16)	0.01333
(19) $1 + (\cot \phi) (\tan k) = 1 +$ (14) (5)	1.0305
(20) $8Fx^4 \tan \epsilon = 8(8) (1)^4 (10)$	0.01105
(21) $dC_p/dx =$ (20) (19)/(16)	0.00642

EFFECT OF GRAVITY ON A LAG-HINGED ROTOR IN PROPELLER OPERATION

INTRODUCTION

In the case of a rotor with lag hinges operating as a propeller with rotor axis horizontal, the alternating gravity force on each blade may be expected to produce a blade motion response. The following analysis investigates this blade motion and the resulting forces on the hub.

ASSUMPTIONS

The following simplifying assumptions are made:

- a. γ is a small angle, and γ^2 terms are negligible compared to γ terms.

- b. For purposes of this analysis, blade aerodynamic forces may be neglected, since, because of symmetry of the operating condition, such forces are essentially constant.
- c. The rotor hub rotates at constant angular velocity.
- d. The effect of lag motion damping may be neglected in considering the limiting case.

BLADE LAG MOTION

Fig. 16 shows a front view of one blade and rotor hub in propeller operation. The blade lag motion is analyzed with respect to coordinates rotating with the hub. Centripetal acceleration is then replaced by a centrifugal force given by

$$F_c = (W_b/g) \omega^2 R (e_2 + L_1) \tag{12}$$

plus Coriolis terms containing γ which become negligible in Eq. (13) since they are of γ^2 order. The equation for angular motion about the lag hinge is

$$\begin{aligned} I_2 \frac{d^2\gamma}{dt^2} &= -F_c L_2 R \frac{\gamma e_2 R}{e_2 R + L_2 R} - W_b L_1 R \sin(\psi - \gamma) \\ &= -W_b \left[\frac{\omega^2 R^2}{g} e_2 L_2 \frac{e_2 + L_1}{e_2 + L_2} \gamma + L_1 R (\sin \psi - \gamma \cos \psi) \right] \end{aligned} \tag{13}$$

Assume that the blade lag motion is given by

$$\gamma = A_1 \cos \psi + B_1 \sin \psi + A_2 \cos 2\psi + B_2 \sin 2\psi \tag{14}$$

Substituting Eq. (14) in Eq. (13) yields

$$\begin{aligned} 0 &= K_2 A_1 + \cos \psi (K_1 A_1 + K_2 A_2) + \sin \psi [K_1 B_1 + K_2 (B_2 - 2)] + \\ &\cos 2\psi (K_1 A_2 + 3I_2 A_2 + K_2 A_1) + \sin 2\psi (K_1 B_2 + 3I_2 B_2 + K_2 B_1) + \\ &\cos 3\psi (K_2 A_2 + \dots) + \sin 3\psi (K_2 B_2 + \dots) \end{aligned} \tag{15}$$

Equating coefficients of the constant, $\sin \psi$, $\cos \psi$, and $\sin 2\psi$ terms to zero (since there are only four unknowns, only four of the seven possible simultaneous equations are solved, and these are selected under the assumption that the higher harmonics will prove to be relatively unimportant),

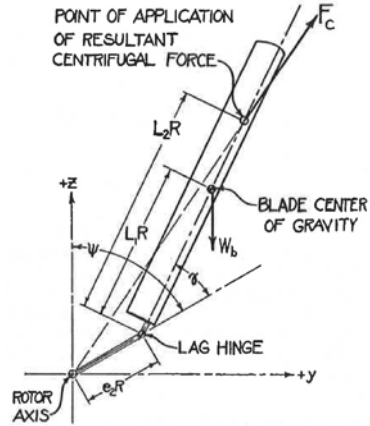

FIG. 16. Schematic diagram of lag-hinged rotor blade in propeller operation.

$$A_1 = 0 \text{ (since } K_2 \text{ is not, in general, zero)} \tag{16}$$

$$A_2 = 0 \text{ (since } K_2 \text{ is not, in general, zero)} \tag{17}$$

$$B_1 = (K_2/K_1)(2 - B_2) \tag{18}$$

$$B_1 = -B_2(K_1 + 3I_2)/K_2 \tag{19}$$

Solving for B_2 ,

$$B_2 = 2/[1 - K_1(K_1 + 3I_2)/K_2^2] \tag{20}$$

MOTION OF BLADE CENTER OF GRAVITY

Referring to Fig. 13, the motion of the blade center of gravity in fixed coordinates is derived as follows:

$$y = e_2R \sin \psi + L_1R \sin (\psi - \gamma) \cong R[e_2 \sin \psi + L_1 (\sin \psi - \gamma \cos \psi)] \tag{21}$$

$$z = e_2R \cos \psi + L_1R \cos (\psi - \gamma) \cong R[e_2 \cos \psi + L_1(\cos \psi + \gamma \sin \psi)] \tag{22}$$

Substituting $\gamma = B_1 \sin \psi + B_2 \sin 2\psi$ and differentiating twice,

$$\frac{d^2y}{dt^2} = \omega^2R [\sin \psi (-e_2 - L_1 + 1/2 L_1B_2) + \sin 2\psi (2 L_1B_1) + \sin 3\psi (1/2 L_1B_2)] \tag{23}$$

$$\frac{d^2z}{dt^2} = \omega^2R [\cos \psi (-e_2 - L_1 + 1/2 L_1B_2) + \cos 2\psi (2 L_1B_1) + \cos 3\psi (1/2 L_1B_2)] \tag{24}$$

HUB LOADS DUE TO GRAVITY

The equations of linear motion of the blade center of gravity are

$$F_{z_1} - W_b = \left(\frac{W_b}{g}\right)\left(\frac{d^2z}{dt^2}\right) \tag{25}$$

$$F_{y_1} = \left(\frac{W_b}{g}\right)\left(\frac{d^2y}{dt^2}\right) \tag{26}$$

where the vertical force exerted by one blade on the hub at the lag hinge is F_{z_1} and the horizontal force is F_{y_1} . Substituting Eqs. (23) and (24).

$$F_{z_1} = W_b \left(1 + \frac{\omega^2R}{g} [\cos \psi (-e_2 - L_1 - 1/2 L_1B_2) + \cos 2\psi (2 L_1B_1) + \cos 3\psi (1/2 L_1B_2)]\right) \tag{25a}$$

$$F_{y_1} = \frac{W_b\omega^2R}{g} \left(\sin \psi (-e_2 - L_1 + 1/2 L_1B_2) + \sin 2\psi (2 L_1B_1) + \sin 3\psi (1/2 L_1B_2)\right) \tag{26a}$$

For a three-bladed rotor, the total instantaneous blade reactions on the hub are

$$F_z = F_{z_1} + F_{z_2} + F_{z_3} \tag{27}$$

$$F_y = F_{y_1} + F_{y_2} + F_{y_3} \tag{28}$$

where the value of ψ for each of the three blades may be expressed in terms of ψ for the first blade as

$$\psi_1 = \psi; \psi_2 = \psi + \left(\frac{2\pi}{3}\right); \psi_3 = \psi + \left(\frac{4\pi}{3}\right)$$

Making these substitutions,

$$F_z = \frac{27}{2} \frac{W_b \omega^2 L_1 R}{g} B_2 \cos 3\psi + 3W_b \quad (29)$$

$$F_y = \frac{27}{2} \frac{W_b \omega^2 L_1 R}{g} B_2 \sin 3\psi \quad (30)$$

By an analogous process for the case of a two-bladed rotor,

$$F_z = \frac{4W_b \omega^2 L_1 R}{g} B_1 \cos 2\psi + 2W_b \quad (31)$$

$$F_y = \frac{4W_b \omega^2 L_1 R}{g} B_1 \sin 2\psi \quad (32)$$

In the case of a three-bladed rotor, the force transmitted to the hub by the blades in propeller operation (aside from a steady vertical force equal to total blade weight) is a third harmonic vibratory force arising from the second harmonic lag motion. In the case of a two-bladed rotor, the transmitted force is a second harmonic vibratory force arising from the first harmonic lag motion.

NUMERICAL EXAMPLES FOR TYPICAL ROTORS

The foregoing analysis has been applied to four typical rotors, selected to represent extremes of size and operating at low rotation speed (found to be more critical in the case of three-bladed rotors) to represent propeller operation. Results are summarized in Table 4. In the case of the three-bladed rotors, the vibratory hub loads are negligibly low compared to total blade weight, while in the case of the two-bladed rotors the vibratory hub loads are dangerously high. These results indicate that a three-bladed rotor with lag hinges should be satisfactory from the standpoint of gravity-induced vibratory hub loads; however, for a two-bladed rotor, a semirigid or rigid-type rotor would be required to avoid objectionable vibratory loads induced by gravity.

TABLE 4.

Rotor diameter (ft.)	16.5	16.5	72.0	72.0
Number of blades	3	2	3	2
Weight of one blade (lbs.)	10	15	200	300
Rotor speed (rad. per sec.)	32	32	8.2	8.2
B_1 (rad. times 10^{-3})	7.75	7.75	57.7	57.7
B_2 (rad. times 10^{-6})	-6.50	-6.50	-223.0	-223.0
Vibratory hub load resultant amplitude (lbs.)	0.15	77.2	23.9	2745

Document 5-47 (b), Robert L. Lichten, "Some Performance and Operating Characteristics of Convertiplanes," presented at the national meeting of the Society of Automotive Engineers, Los Angeles, CA, 30 September-5 October 1957.

SOME PERFORMANCE AND OPERATING CHARACTERISTICS OF CONVERTIPLANES

SUMMARY

The place of the convertiplane in the VTOL aircraft spectrum between the helicopter and the jet direct-lift airplane is discussed. Performance and operating characteristics are compared for four turbine-powered convertiplane designs having a range of disc loadings from 10 to 160 lbs/sq ft, and capable of hovering flight at 5000 ft on a 95°F day. It is shown that a marked increase in installed power requirement and in hovering fuel rate and downwash velocity occurs with increasing disc loading. Speed capability increases with disc loading; however it was also found that for equal installed power, speed capability is largely independent of disc loading. Cruising range was found to be higher at low disc loading.

The use of fixed vs tilting wings in convertiplanes is considered. Test data on the download on a fixed wing in hovering flight is presented, including the effects of plain flaps. The influence of disc loading on the characteristics of tilt-wing types during conversion is discussed.

INTRODUCTION

The term "Vertical-Take-off-and-Landing Aircraft" covers many types and configurations of direct-lift, man-carrying machines. These range from the helicopter at the low-speed end of the VTOL spectrum to the direct-lift jet airplane at the high speed end.

Several years ago the general belief existed that all VTOL types are to a large degree competitive with each other. For example, there was a widespread expectation

on the part of the public that the helicopter would soon be displaced by other VTOL types having more spectacular performance. So far, this expectation has not proved correct, and today the helicopter is flourishing as never before. There is now good evidence that each major VTOL type may be expected to engender its own unique applications and create its own sphere of usefulness, just as the helicopter has done.

Meanwhile the helicopter continues to expand its markets, both commercial and military, as its performance and operating costs continue to improve. It is significant that most of the new helicopter applications of recent years have emphasized the low-speed performance characteristics of the helicopter. Commercially, for example, helicopters are now being used for mineral exploration work in all types of terrain, and for mapping and route surveys in rugged inaccessible areas. Militarily, helicopters are finding new uses as aerial cranes, in naval minesweeping, and as aerial weapon platforms.

At the other end of the VTOL spectrum, experimental jet aircraft have recently made successful initial flights, and operational versions may reasonably be expected within the next five years. For the foreseeable future, the application of the jet VTOL type with its short hovering endurance will probably be exclusively military in nature, with its most likely use being as an interceptor aircraft.

Between the helicopter and the jet lies a considerable portion of the VTOL spectrum, available for occupancy by aircraft types with hovering abilities and speed capabilities between the helicopter and jet extremes. Probably the candidate most likely to be successful in making a place for itself in the intermediate portion of the spectrum is a general type which is termed the convertiplane for purposes of this paper.

THE CONVERTIPLANE

By the term convertiplane is meant a type of aircraft which uses one or more rotating airfoil systems acting on unheated atmospheric air to provide lift for vertical and low-speed flight, and to provide forward thrust for high-speed flight with the lift load transferred to a monoplane wing. The rotating-airfoil system, which may be a rotor-propeller, a conventional propeller, or a ducted propeller, has its axis substantially vertical for low speed flight, and *converts* to high-speed flight configuration by having its axis rotated forward to a generally horizontal attitude.

Fig. 1 [*not reproduced*] shows one type of convertiplane, the Bell XV-3. It has relatively lightly loaded rotor-propellers which are mounted in journals at the wing tip for conversion. The wing is fixed to the fuselage at the incidence for forward flight at all times. This type has often been called the tilt-rotor convertiplane, but a more definitive term might be: fixed-wing convertiplane.

Fig. 2 [*not reproduced*] shows a second type of convertiplane, the Vertol Model 76. In this case, the rotor-propellers are smaller in diameter and of higher solidity, and are mounted at about the mid-span position on each wing. The wing chord line is no longer fixed with respect to the fuselage, but rotates about a spanwise axis with the rotor-propellers during conversion. This type is known as a tilt-wing convertiplane.

Fig. 3 [*not reproduced*] shows an artist's sketch of a third type of convertiplane, the Hiller X-18 Propelloplane, which is also a tilt-wing type, basically similar to the Vertol 76 above. In this case, nearly conventional airplane-type propellers are used which are relatively heavily loaded in vertical flight.

Fig. 4 [*not reproduced*] shows a fourth type of convertiplane, a Bell ducted propeller design. In this case, the vertical lift and forward propulsion units are propellers of small diameter operating inside cylindrical shrouds. These units are mounted in journals at the wing tip for rotation through 90° for conversion. As in the first type described, the wing is fixed to the fuselage.

THE VTOL SPECTRUM

The position in the VTOL aircraft spectrum which the various types of convertiplanes occupy is shown in Fig. 5 [*not reproduced*] for turbine-powered transport-size machines. The boundaries shown between the various types should be considered as typical values only; in actual practice considerable overlap may be expected. Similarly, the maximum speed capabilities shown should not be taken to indicate absolute limits, but rather the values which are estimated to be attainable with operational machines of practical design. Machines especially designed for speed could exceed the limits shown in all categories.

The substantial advantage in static lifting efficiency of the conventional helicopter with lightly loaded rotor compared to other types is evident in Fig. 5. This, of course, is due to a relatively low rate of energy dissipation in the slipstream. The jump in speed capability shown in Fig. 5 between helicopter and convertiplane is due to the elimination of the well-known helicopter speed limitations due to retreating blade stall and advancing blade compressibility losses, neither of which are present in the convertiplane in high-speed flight configuration. The jump in speed capability shown between convertiplane and direct-lift jet airplane is due to the large increase in specific thrust which is obtained when heat is added to the propulsive fluid by burning fuel in it, as in the turbojet engine with or without afterburner. In all cases, increasing speed capability implies a correspondingly higher level of aerodynamic cleanness.

RELATIVE PERFORMANCE OF CONVERTIPLANE TYPES

a. Description of Analysis

In order to provide a comparison of the performance to be expected from the various types of convertiplanes, a simplified analysis was performed for the aircraft shown in Fig. 6 [*not reproduced*], which represents a typical transport convertiplane of 25,000 pounds gross weight. In the figure, rotor-propellers of 40-foot diameter together with their power plants are shown mounted at the wing tips. The analysis was performed for this propulsion unit and for the others of smaller diameter shown to scale in Fig. 7 [*not reproduced*]. For the smaller diameters, the propulsion units

may be assumed to be mounted inboard of the wing tips at appropriate locations, although the performance analysis as performed is independent of such locations.

The design parameters of the four propulsion units shown in Fig. 7 were based on disc loadings of 10, 40, 80, and 160 pounds per square foot, plus the requirement that the propellers be aerodynamically capable of supplying sufficient static thrust to permit hovering at 5000 feet altitude on a 95°F day. Tip speeds and numbers of blades were selected arbitrarily as considered appropriate for each design. The 10 lb/sq ft disc loading is a typical value for a rotor-propeller; the 40 lbs/sq ft loading is typical for a lightly loaded propeller design for the tilt-wing configuration; the 80 lb/sq ft loading is probably representative for tilt-wing designs which aim to use propellers as nearly conventional as possible, and the 160 lbs/sq ft design represents a relatively high loading case with performance which may also be considered representative for a ducted propeller configuration having a slightly smaller diameter.

The propeller performance analysis used for the comparison is not given in the present paper, but is a simplified version of the standard vortex method as outlined in Reference 1. Even though simplified, the method is believed to provide reasonably correct propulsive efficiency values, which should be of adequate accuracy for the purposes of this comparative analysis.

Note from Fig. 7 that there is not a very large variation in total blade area among the various designs. This is simply the result of assuming the same maximum average lift coefficient of .95 at the hovering design point for all cases. What difference in total blade area does exist is solely due to the variation assumed for rotational tip-speeds. In the two larger designs, the first figure listed for tip-speed is the hovering value, while the second figure is used in highspeed cruising flight. Use of a lower value for cruise in these two cases provides higher propulsive efficiency, but requires the use either of a two-speed gear box or of an engine type such as the free turbine which permits a relatively wide range of output shaft speeds at the same power output level.

b. Results of Hovering Analysis

One of the primary results of the analysis is shown in Fig. 8 [*not reproduced*], which shows the installed power requirement at sea level to meet the design hovering condition of 5000 feet and 95°F. Conventional turbine engine power characteristics without liquid injection for temperature compensation are assumed. The resulting powers are about 50% higher than would be required solely for hovering at sea level on a standard day. Experience with turbine-powered helicopters has shown that such a level of excess power is desirable from the general safety and operational performance standpoint, irrespective of the particular hovering design requirement.

Fig. 8 also shows the rate of fuel consumption in hovering at sea level on a standard day. These data indicate that installed power and fuel requirements for the three lower disc loadings are probably within reason, but that the power requirement at the highest disc loading is so high that the achievement of a practical aircraft

having its characteristics is extremely unlikely. The applicability of the three types having lower disc loadings to certain missions would depend on the required length of hovering time, in view of the wide variation in hovering fuel rate shown.

Downwash velocities generated in hovering at sea level are shown in Fig. 9 [not reproduced]. Again, operational requirements might be expected to determine how high a disc loading could be tolerated from the standpoint of kinetic energy in the hovering downwash. It is unlikely that ground personnel could continue to function in downwash velocities much above 75 mph. (Adding an optimum duct or shroud to a propeller effects an appreciable reduction in downwash energy and velocity in the hovering condition; this effect has not been included in the analysis.)

c. Results of Forward Flight Analysis

The variation in maximum speed found for the various designs is plotted in Fig. 10 [not reproduced] for an altitude of 15,000 feet. The resulting trend is almost entirely due to the differences in the installed power required for the several designs. This is borne out by the dashed curve which demonstrates that almost the same maximum speed would be attained by all four designs if each had the same installed power. This occurs because all provide nearly equal propulsive efficiencies in this particular flight condition. The drop in efficiency indicated by the speed decrease for the 160 lb/sq ft disc loading case occurs because its propellers become somewhat underloaded for the reduced power assumed for the dashed curve of Fig. 10.

Fig. 11 [not reproduced] shows the cruise performance calculated for the various designs at 15,000 feet, with 10,000 pounds of fuel assumed available for cruise. It may be seen that the trend is fairly uniform among the types, and that if a very high cruise speed is desired, the higher disc loadings must be used, or at least the high installed power levels corresponding to those assumed for the high disc loading designs must be provided. If speed requirements are more moderate, in the 250–350 knot range, then a low disc loading design offers an appreciable improvement in range. This analysis indicates that large-diameter slow-turning propellers can be at least as efficient in cruise at medium speeds as smaller propellers of greater solidity such as proposed for many VTOL designs.

An appreciable part of the differences that show up in the range comparison, as well as the break in each curve of Fig. 11, is due to the assumed variation of specific fuel consumption with percentage of maximum power output used in cruise. The values used in the analysis were [in the table at right]:

These values represent operation of modern turbine engines in each aircraft, with the normal increase for turbines being used down to 60% of maximum power.

% of Maximum Power Output	Brake Specific Fuel Consumption (lbs/shaft hp-hr)
100	.50
90	.51
80	.53
70	.56
60	.60
50	.60
40	.62
30	.64
(1)	.67

Below this level, the increase in fuel consumption over that at full power was assumed to be considerably smaller than that which would result from the operation of a single turbine engine at these reduced power settings, on the basis that a more economical operating schedule could be used with multi-turbine installations, involving the shut-down of one or more engines for cruise. In such cases, it is believed that the assumption of a small increase in specific fuel consumptions at reduced total power output is a reasonable one for typical cases.

The net result is that for designs having very high installed engine power, maximum range capability is reduced by the necessity of operating, for economical cruise, at greatly reduced total power output where some penalty in specific fuel consumption must be paid at fixed altitude.

FIXED-WING AND TILT-WING CONVERTIPLANE CHARACTERISTICS

a. Wing Download in Hovering Flight

Other factors being equal, there is little question that it would be more desirable to use a wing fixed to the fuselage structure rather than one designed to tilt through 90° for convertiplanes. The reason for use of the tilting wing is to avoid the loss in lift that occurs when large wing areas are exposed to the downwash from the lifting propellers in hovering and low-speed flight. Such downloads also exist for helicopter airframe components which are immersed in the rotor downwash. Here they can be tolerated because of their small magnitudes, of the order of 2 to 3 per cent of total lift for typical helicopter configurations.

NACA tests and analysis of download on flat panels in the slipstream of a rotor are reported in Reference 2. Results of recent tests made by Bell Helicopter Corporation on a model of a fixed-wing convertiplane are in good agreement with NACA data. The Bell tests included determination of the effects of deflecting 22[-] and 44-per cent-chord full-span plain flaps. Results are shown in Fig. 12 [*not reproduced*]. For a wing whose projected area below the rotor-propeller occupied 10% of the disc area, the download in hovering was 7.7% of rotor thrust at a disc loading of 3 lbs/sq ft. There was a slight tendency for this percentage to decrease with increasing disc loading. Flap deflection may be seen to provide appreciable reductions in the download, to 5.5% and 3.4% for the two flaps tested at the optimum deflection of 60° . Beyond 60° deflection, the flow past the flap became erratic due to presumed separation, which may have been associated with the scale of the model.

The use of full span flaps, probably combined with the aileron function, thus appears desirable for future fixed-wing convertiplane designs, especially since such flaps would offer other advantages in addition to the reduction in hovering download. Based on the test results, so long as the fixed surfaces in the slipstream occupy a reasonably small percentage of the disc area, the download penalty associated with a fixed wing does not appear excessive. This condition can be met only with

relatively low hovering disc loadings; an upper limit of about 20 lbs/sq ft is estimated to be acceptable.

In the case of the tilt-wing configuration, slipstream drag on the immersed wing area is small, probably of the order of 1% of total thrust. This effect should be substantially independent of disc loading.

b. Flight Characteristics at Low Airspeeds

One of the interesting characteristics of the fixed-wing convertiplane is the pilot's ability to vary the proportion of lift provided by the wing and by the rotor-propellers in low speed flight. This is illustrated in Fig. 13 [*not reproduced*], which shows the results of flight tests to determine the variation in power required with conversion angle. The aircraft was in a high-drag configuration for these tests. The results indicate appreciable reduction in required power with forward conversion as the wings begin to carry a portion of the lift load. This result is attributed partially to the unloading of the rotor-propellers and partially to reduced parasite drag with improved fuselage attitude.

One of the disadvantages of the fixed-wing convertiplane type is that as disc loading is increased there is a tendency for wing loading to become excessive. Keeping wing area in the downwash to a minimum results in wing loadings of about 8 times the disc loading for typical proportions. This can lead to wing stall when the rotors are completely unloaded at conversion airspeeds and at altitude. Wing flaps are probably desirable to alleviate this tendency for machines of high design loadings.

For tilting-wing convertiplanes, the problem of separated flow over the wing during some transition conditions exists, particularly during deceleration or partial-power descent. This problem is discussed in Reference 3, and is illustrated in Fig. 14 [*not reproduced*] for two disc loadings. The problem arises because maintenance of unstalled flow over the wing at large incidence angles during conversion is dependent on the presence of a sufficiently large slipstream velocity to keep the wing angle of attack low. When power is reduced either for deceleration or descent, flow separation may result. As indicated by Fig. 14, this condition is more likely to occur with moderate than with high disc loadings.

c. Short Take-off Characteristics

Because of their extremely high available static thrust, convertiplanes of all types may be used to advantage as STOL aircraft under overload conditions. Reference 4 discusses various aspects of this type of operation. For running take-offs, the tilting-wing type is converted until the optimum angle of attack is obtained, which may be of the order of 20° or 30°, depending on whether or not wing flaps are available. In the case of the fixed-wing type with low disc loadings, a ground clearance limit usually prevents complete 90° conversion for running take-offs, but an angle of 40° to 50° is feasible for most designs. At a typical value of 45°, 70% of total

thrust is available for forward acceleration, and at the same time the 70% vertical thrust component unloads the landing gear so that very good short take-off performance is still obtained. Wing flaps are desirable for the fixed-wing type to increase the wing lift at low airspeeds, as on conventional airplanes.

CONCLUSIONS

Based on an approximate performance analysis of four equivalent turbine-powered convertiplane designs having a range of disc loadings from 10 to 160 lbs/sq ft and capable of hovering flight at 5000 feet on a 95°F day, the following conclusions are drawn:

1. The installed engine power required and the hovering fuel rate vary approximately as the square root of the design disc loading in hovering.
2. Installed power requirements for disc loadings above about 80 lbs/sq ft are probably too great for economically practicable aircraft.
3. Maximum speed capability increases with disc loading from 307 knots at 10 lbs/sq ft to 479 knots at 160 lbs/sq ft; however if equal installed power is assumed, maximum speed is substantially independent of design disc loading.
4. Cruising range increases with decreasing design disc loading, largely because designs having high installed powers must operate at inefficient engine power settings for economical cruising.
5. For optimum range and speed performance, designs with hovering disc loadings below about 70 lbs/sq ft require use of reduced rotational speed in cruise.
6. Based on consideration of wing download in hovering flight, wings fixed to the fuselage may be used for design disc loadings [of] up to about 20 lbs/sq ft. Above this value, tilting wings are considered desirable.
7. For fixed-wing convertiplanes, wing flaps provide appreciable reductions in hovering wing download as well as advantages in conversion at altitude and in overload running take-offs.
8. Tilt-wing convertiplanes, particularly those with moderate design disc loadings, may be subject to stalling of portions of the wing immersed in the slipstream during conversions in which deceleration or descent is taking place.
9. Convertiplanes of both the fixed and tilt-wing types should exhibit excellent short take-off performance at overload. The fixed-wing type with low design disc loading is subject to a ground clearance limitation, but this should have little effect on running take-off performance.

Document 5-48 (a-e)

Excerpts from *NASA Conference on V/STOL Aircraft; A Compilation of the Papers Presented*,
Langley Research Center, Langley Field, Virginia,
17-18 November 1960 (NASA, 1960).

(a) Richard E. Kuhn, Langley Research Center, "Review of Basic Principles of V/STOL Aerodynamics," pp. 1-17.

(b) Robert H. Kirby, Langley Research Center, "Aerodynamic Characteristics of Propeller-Driven VTOL Aircraft," pp. 19-34.

(c) Richard C. Dingeldein, Langley Research Center, "Considerations of Methods of Improving Helicopter Efficiency," pp. 101-117.

(d) F. B. Gustafson, Robert J. Pegg, and Henry L. Kelley, Langley Research Center, "Aerodynamic Observations from Flight Tests of Two VTOL Aircraft," pp. 149-169.

(e) Charles H. Zimmerman, Langley Research Center, "Summary of V/STOL State of the Art," pp. 335-345.

It is clear from reading these five summaries from a November 1960 V/STOL conference at Langley Research Center that NASA's V/STOL experts understood the inherent limitations of the conventional helicopter and wanted to look into the promise of various convertiplane arrangements. One could, in fact, find all the following facts about helicopter performance already being reported in NACA publications even before the organization itself "converted" into NASA in 1958. Rotors could generate only so much power and aerodynamic lift. Compressibility effects seriously disturbed airflow over a rotating blade, both as it advanced and as it retreated in its cycle. The hub of the rotor as well as other components of the airframe produced considerable drag, resulting in a poor ratio of lift to drag. Together, these problems restricted the cruising speed of a helicopter in level flight to no more than about 170 mph, with short dash speeds of up to perhaps 230 mph. Auxiliary propulsion devices and other arrangements could be tried to increase those speeds, but not without seriously compromising other elements of

a helicopter's performance. By the early days of NASA, an increasing number of V/STOL advocates felt that a better approach might be to bypass the problems of the conventional helicopter and go after some sort of convertiplane based on the tilt-rotor. Such craft would need much less runway area and therefore could ease congestion at airports by enabling aircraft to take off from various spots around a city, including from the city center and even from on top of buildings. Skeptics argued that tilt-rotors posed even more problems in the form of increased weight and greater mechanical complexity. Aerodynamically, their rotors and wings still seemed all too susceptible to major aeroelasticity problems. Overall, the problems of "conversion" or "transition" from vertical to horizontal flight and back again just seemed too daunting.

Document 5-48 (a), Richard E. Kuhn, Langley Research Center, "Review of Basic Principles of V/STOL Aerodynamics," in NASA Conference on V/STOL Aircraft; A Compilation of the Papers Presented, Langley Research Center, Langley Field, Virginia. November 17-18, 1960 (NASA, 1960), pp. 1-17.

SUMMARY

This paper reviews the principal factors that determine the performance of V/STOL aircraft. These can be summarized as follows. In hovering, the power required, the fuel consumption, and the downwash dynamic pressure are all determined by and increase with increasing slipstream area loading. In transition the wing span, the distribution of load on that span, and the power required in hovering determine the shape of the power-required curve and through this the engine-out safety and STOL performance. In cruise some compromises are required but, generally, the same rules for designing good cruise performance into conventional airplanes still apply to V/STOL configurations, namely, attention to aerodynamic cleanliness to reduce the parasite power and a wing of appreciable span to reduce the induced power.

INTRODUCTION

During the past few years a great variety of V/STOL type aircraft have been proposed and investigated. The choice among these of a particular V/STOL configuration to fill a given mission will depend largely

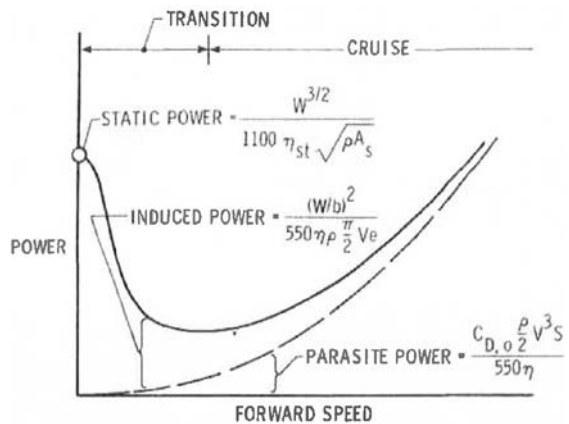

FIGURE 1. Power required in steady level flight.

upon the specifications of the mission and a matching of the mission requirements with the airplane performance. This paper reviews the principal factors that govern the performance of V/STOL aircraft in the hovering, cruise, and transition speed ranges.

One of the primary performance considerations in any airplane is the power required. Most points concerning the performance of V/STOL aircraft can be made on the basis of the typical power-required curve for V/STOL aircraft such as shown in figure 1. The expressions that determine the power requirements in the three areas to be discussed are also shown.

SYMBOLS

A	disk area of propeller or rotor, sq ft
A_e	exit area of duct, sq ft
A_s	cross sectional area of slipstream, sq ft
b	wing span, ft
$C_{D,o}$	parasite drag coefficient
$c_{l,i}$	design section lift coefficient
D	slipstream diameter, ft; also exit diameter of duct, ft
e	span efficiency factor
$(L/D)_{MAX}$	maximum lift drag ratio
P	shaft power, hp
q	average downwash dynamic pressure, lb/sq ft
r	inlet radius, ft
S	wing area, sq ft
SFC	specific fuel consumption, lb/hp/hr
T	thrust, lb
t	time, hr
V	velocity, ft/sec unless otherwise noted
W	airplane weight, lb
W_f	fuel weight, lb
η	propulsive efficiency
η_{st}	static thrust efficiency (ratio of slipstream kinetic energy to shaft power),
	$\frac{T^{3/2}}{1100 P \sqrt{\rho A_s}}$
ρ	mass density of air, slugs/cu ft

HOVERING PERFORMANCE

POWER REQUIRED

As is well known, all hovering aircraft support themselves by accelerating air downward. A helicopter imparts a low downward velocity to a large diameter stream of air, whereas a jet V/STOL gives a very small diameter stream of air a very high downward velocity to produce the same vertical thrust. In both cases the thrust is given by $T = mV$ where m is the downward mass flow of air per unit time ($m = \rho A_s V$).

The power required to produce this thrust, however, is a function of the thrust multiplied by downward velocity imparted $P = \left(\frac{T^3}{1100 \eta_{st}} \right)^{1/2}$. Thus the power increases rapidly as the diameter of the actuator used decreases as shown in figure 2.

The major difference between the shrouded and unshrouded configurations is shown by the sketch at the top of the figure. The presence of the shroud prevents the contraction of the slipstream which occurs with the unshrouded configuration. Thus the diameter of a shrouded configuration can be about 70 percent of that of an unshrouded configuration. Note that it is the exit area of a shrouded configuration that governs the power required of this configuration.

Experimental data have shown that, for the unshrouded configurations, static thrust efficiencies between 0.7 and 0.8 (depending on the degree of compromise required with the high-speed characteristics) can be achieved.

For the shrouded configurations the reduction in tip losses due to the presence of the shroud should give some improvement in efficiency. However, careful attention must be paid to the internal drag of the shroud, struts, and counter vanes to prevent these losses from nullifying the gains due to tip-loss reductions. Very little full-scale data are available for the shrouded configurations but in general it is expected that static thrust efficiencies of 0.75 to 0.85 should be obtainable with careful design.

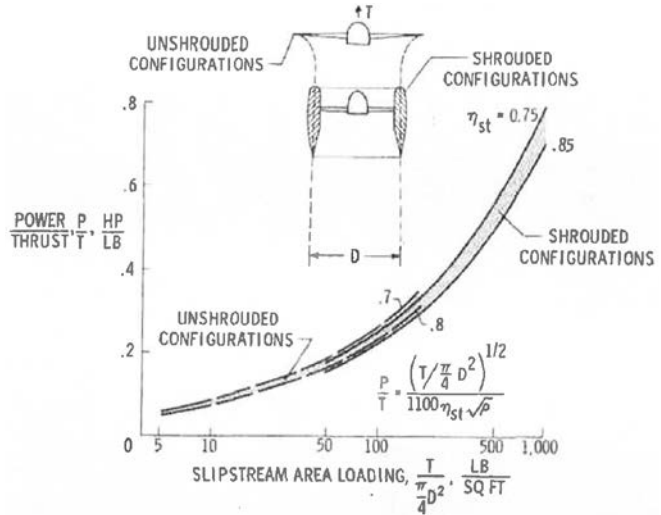

FIGURE 2. Power required in hovering.

FUEL CONSUMPTION

Two other quantities are of concern in hovering: the fuel consumption, which is directly proportional to the power required, and the downwash dynamic pressure, which is one-half the slipstream area loading. These are plotted in figure 3.

The leaders from the configuration sketches in figure 3 do not indicate a specific point but rather the general area in which

current practice usually places these configurations. All V/STOL configurations except jet pump schemes, which are not considered here, fall in one general band.

Turbojet and turbofan configurations, which were omitted from figure 2 because these engines are not usually thought of in terms of horsepower, are included in figure 3. If these configurations were presented in terms of power they would fall at or above the top edge of figure 2. These configurations have very high fuel consumption; one hour of hovering would burn a weight of fuel almost equal to the weight of the aircraft. Therefore, with these configurations, hovering time must be restricted to the 1½ to 2 minutes required for take-off and landing.

Obviously if long hovering time is required, a rotor configuration is dictated. A more complete discussion of power required and fuel consumption in hovering is presented in reference 1.

DOWNWASH

A point of concern with V/STOL aircraft is the effect of the downwash from these aircraft on the ground under the aircraft. The average downwash from unshrouded configurations is equal to the disk loading and that from shrouded configurations is equal to one-half the exit-area loading. Experience has shown that loose sand and dirt will be blown up by helicopters with disk loadings, and therefore downwash dynamic pressures, as low as 2 to 3 pounds per square foot. On the other hand, good sod can withstand downwash dynamic pressures as high as 1,000 to 2,000 pounds per square foot. The downwash problem is discussed more fully in reference 2.

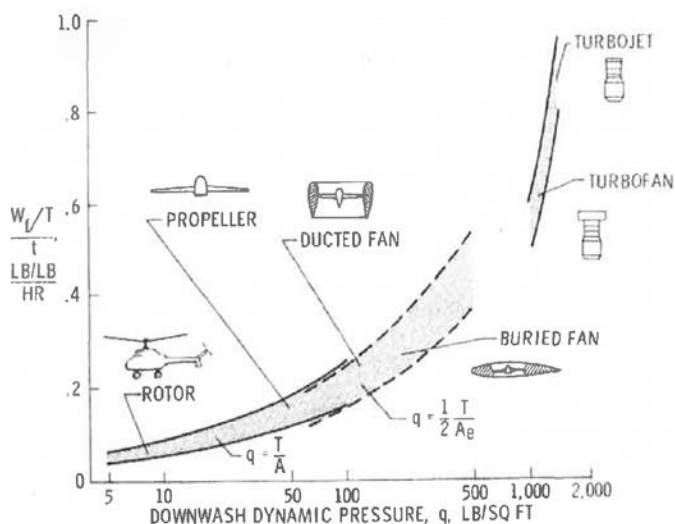

FIGURE 3. Fuel consumption in hovering.

CRUISE PERFORMANCE

GENERAL CONSIDERATIONS

In figure 4 the power required for 40,000-pound cargo-type aircraft operating at sea level is plotted as a function of speed. V/STOL aircraft can be classified in three categories: those that use rotors for both lift and propulsion in cruise (the pure helicopters), those that operate as conventional aircraft using wing lift and separate propulsion in cruise, and combination configurations (the compound or unloaded helicopter). Requiring the helicopter rotor to provide both lift and propulsion in cruising flight results in problems of retreating blade stall and advancing blade compressibility effects which increase the rotor profile power requirements of the helicopter and limit its cruising speed.

In the compound configuration the propulsion job is taken over by separate propellers or ducted fans and part of the lift is transferred to a wing; thus the rotor is unloaded and the speed capability is increased. The parasite drag of the rotor and pylon remains, however, with the result that the power required remains above that of more conventional aircraft.

The other V/STOL aircraft cruise on wing lift, and for these the same rules for obtaining good cruise performance that have always applied to conventional aircraft still apply, namely, aerodynamic cleanliness to reduce parasite drag and power and a wing designed for the desired cruising altitude and speed to minimize the induced power.

Good aerodynamic design is important not only at the highest speeds but throughout the speed range because most aircraft cruise in the speed range near the maximum lift-drag ratio where the span is important. A large wing span is needed to minimize induced drag and therefore power, as can be deduced from the expression of figure 1. A clean aerodynamic design is needed to minimize power throughout the speed range. A good case in point is the helicopter where the high parasite drag of current configurations is largely responsible for the difference in power between the helicopter and the airplane as shown in figure 4 near the speed for helicopter minimum power. This point is discussed more completely in reference 3.

The power required for the V/STOL aircraft in cruise is a little greater than that for the conventional airplane because of the reduction in propulsive efficiency which results from the fact that the propulsion units must also be designed to provide the lift in hovering for most V/STOL configurations; thus, a compromise in the design must be made.

PROPULSIVE EFFICIENCY COMPROMISE

Each V/STOL type has a different propulsion-hovering design compromise. An example of one such design compromise for the propeller-driven V/STOL aircraft is shown in figure 5. For best static thrust a relatively large amount of camber, as indicated by the design section lift coefficient, is required. With a lot of camber,

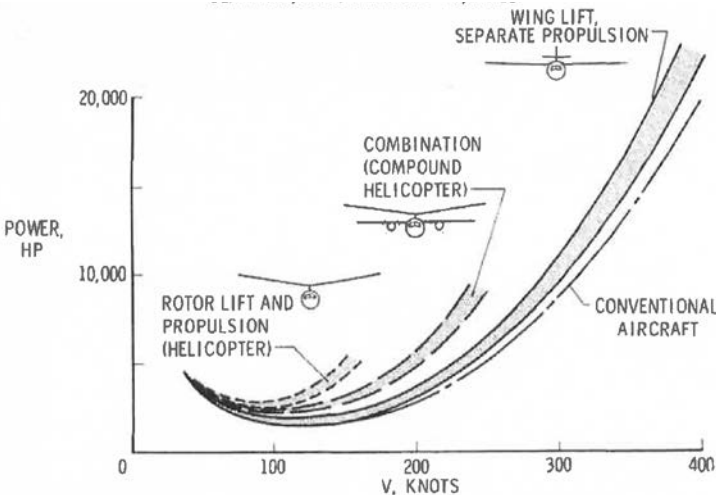

FIGURE 4. Power required in cruise. Sea level; gross weight = 40,000 lb.

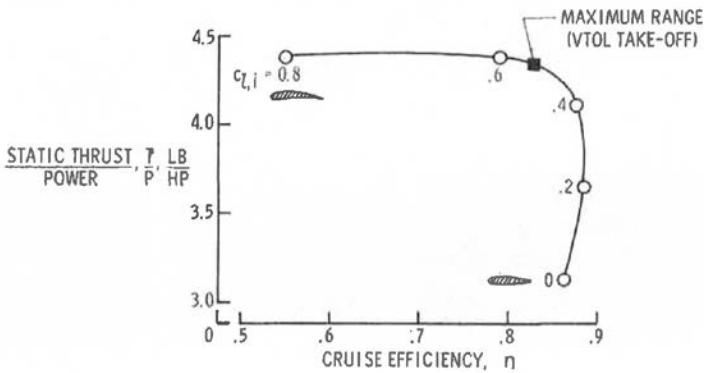

FIGURE 5. Propeller design compromise.

however, the cruise efficiency is relatively poor. Best cruise efficiency occurs with relatively little camber.

The design compromise for maximum range is shown by the solid symbol. If less camber is used, the weight of fuel that can be lifted in vertical take-off is reduced and this causes a reduction in range. Increases in camber above this point give a small increase in fuel weight lifted but the cruise efficiency decreases so rapidly that again the range is decreased.

Another compromise for the propeller aircraft occurs in connection with the operating rotational speed. If the relatively wide-blade large-diameter propellers required for good static thrust are operated at hovering rotational speed while in cruise, the tip sections of the blade are operating well below their most efficient angle of attack. A reduction in rotational speed (to 80 percent in the case of fig. 5)

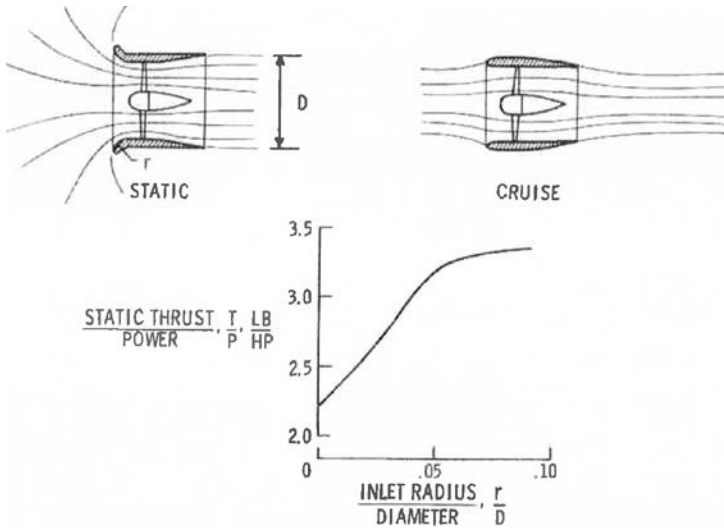

FIGURE 6. Ducted-fan design compromise.

is required to achieve good cruise efficiencies. This problem is even more severe for tilt-rotor configurations.

A different type of compromise is involved for the ducted-fan configuration as shown in figure 6. With a generous inlet radius a good level of static thrust is obtained. However, experimental investigations have shown that if a small inlet radius such as is desired for the cruise condition is used, the lip will stall internally and the thrust drops appreciably. Thus, either a thick shroud or a variable-geometry inlet must be used.

Also a compromise must be made at the duct exit. As mentioned in the section "Hovering Performance" the power required depends on the exit diameter. Thus a diffuser, as indicated, is desired to increase the exit diameter and thus reduce the power required. In cruising flight, however, the exit diameter is too large and the flow may separate from the diffuser. For the optimum duct performance it may in some cases be necessary to vary both the inlet and the exit geometry.

CRUISING SPEED

The cruising speed attained will depend on both the aerodynamic cleanliness and the power installed as shown in figure 7 where the compound helicopter, the flapped tilt wing, and the tilt-duct configuration are compared. The power installed must be somewhat greater than the bare power required to hover in order to allow for temperature and altitude effects and to provide a margin for climb.

At maximum cruise power the example compound helicopter used in figure 7 for illustration would have a speed of about 200 knots. The tilt-wing and tilt-duct configurations would have higher speeds, both because they can be cleaner aerodynamically and because of the higher installed power required for hovering. The

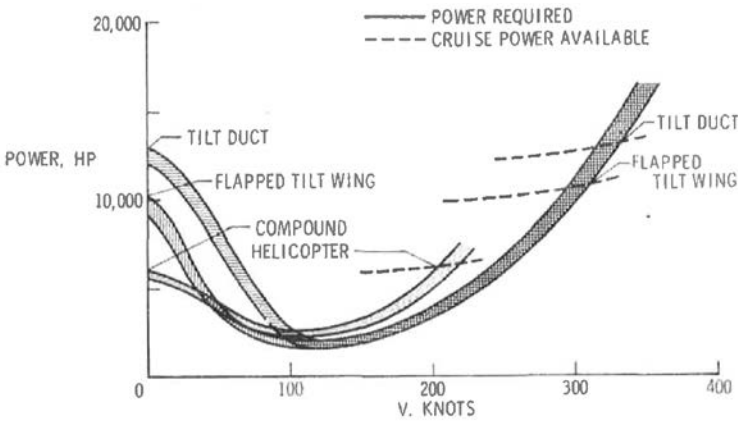

FIGURE 7. Cruising speed at sea level. Gross weight = 40,000 lb.

tilt-duct configuration is shown above the tilt-wing configuration because design studies of these usually utilize a higher slipstream area loading in hovering.

RANGE

At maximum cruising speed at sea level the engine specific fuel consumption is low ($SFC = 0.50$, see fig. 8); this indicates that the engine is operating near peak efficiency. The range would be severely limited, however, because the airplane is operating far beyond the point of maximum aerodynamic efficiency or $(L/D)_{MAX}$. However, when current turbine engines are throttled to 20-percent power (as in this case), the fuel consumption is more than doubled so that again the range is far from optimum. Actually maximum range would occur between 175 and 200 knots for the example shown.

Conventional turbine-powered airplanes also face this same problem, and therefore current turbine transports operate at high altitude. As shown in figure 8 an altitude can be found, in this case 40,000 feet, at which both the engine and the airframe can be operated at or near maximum efficiency. In the present example, the range obtained by operating at 40,000 feet would be about three times that obtained by operating at the same speed at sea level.

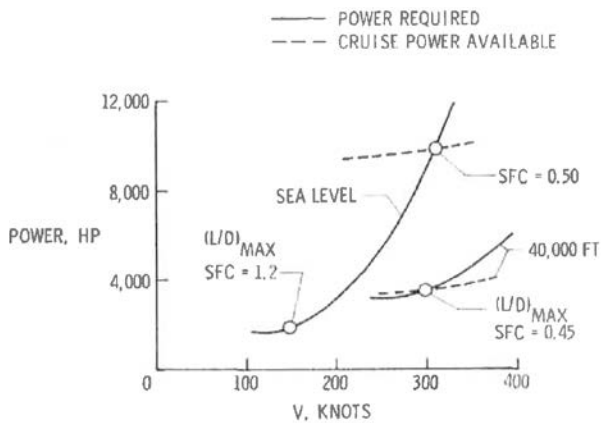

FIGURE 8. Effect of altitude.

It is recognized that in military operations it is sometimes desirable or necessary to fly "on the deck." The example airplane used could fly at about 180 knots on only one of four engines at a specific fuel consumption of about 0.50 and could thus almost match best aerodynamic efficiency and best engine efficiency at sea level. The resulting range would be only slightly less than that at altitude. Although it is recognized that shutting down and restarting engines in flight is not generally considered good practice, with current engines it will be necessary for operating personnel to make a choice between shutting down engines, flying at altitude, or accept the penalty in fuel consumption and range for high-speed on-the-deck flight.

As shown in figure 1, the parasite drag is the primary contribution to the power requirements at high speeds. For those missions in which very high-speed flight at sea level is of paramount importance, some decrease in power required and therefore increase in range at very high speeds can be achieved by reducing the wing size as shown in figure 9. The altitude capability and maximum firing range would be seriously reduced, however, because of the increase in power at the speed for $(L/D)_{MAX}$, as shown in figure 9. This increase in power is, of course, due to the increase in induced power which, as shown in figure 1, is proportional to $(W/b)^2$.

The relative speed ranges of application for turbojet and turboprop propulsion systems are indicated in figure 10. At the higher speeds the approach of the transonic drag rise and the reduction in propeller efficiency caused by the blade tips reaching transonic speeds causes a rapid increase in power required and therefore fuel consumption for the turboprop configuration as shown in figure 8.

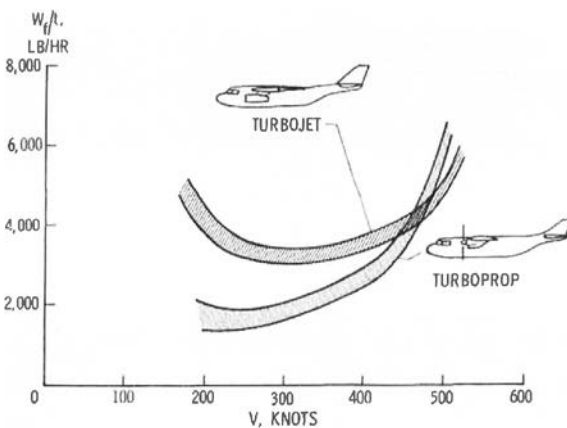

FIGURE 10. Fuel consumption in cruise. 40,000 ft altitude; gross weight = 40,000 lb.

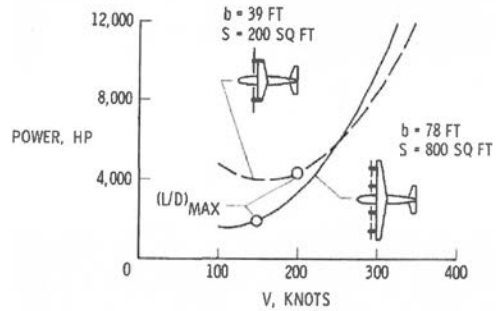

FIGURE 9. Effect of wing span and area. Sea level; gross weight = 40,000 lb; aspect ratio = 7.6.

At the higher speeds the approach of the transonic drag rise and the reduction in propeller efficiency caused by the blade tips reaching transonic speeds causes a rapid increase in power required and therefore fuel consumption for the turboprop configuration as shown in figure 8.

Because of the high exhaust velocity of the turbojet the propulsive efficiency is low at low speeds but increases with speed and above 450 to 500 knots is better than that of the turboprop; thus, less fuel is consumed. This is the obvious speed range of

operation for turbojet propulsion systems. However, the penalty for operating turbojet configurations at lower speeds is readily apparent.

TRANSONIC PERFORMANCE

GENERAL CONSIDERATIONS

Obviously, the most important requirement in transition is that the power required should not exceed the power required in hovering. However, two other considerations are also important. The first is the problem of the minimum speed at which flight can be continued in the event of partial power failure. The second is the problem of STOL performance with overload or in operation at altitudes and temperatures above those at which the airplane can hover. Both of these problems depend upon the rate of decrease in power with speed as the aircraft departs from hovering; a rapid decrease is desired from both considerations. The steepness of the back side of the power curve is definitely desirable from the viewpoint of performance; however, whether this steepness is a basic problem in handling qualities is yet to be decided.

The shape of the power-required curve in transition depends upon the following items: the disk loading, which determines the power required in hovering (the low-speed end point of the transition), and the wing span and the distribution of load on the span, which determine the power required at the high-speed part of the transition.

EFFECT OF SPAN

Figure 11 shows the effect of span on the power required as a function of speed for a 40,000-pound airplane. Because of the low speeds involved the parasite power is small or negligible throughout most of the transition. The power required is all induced power which is determined, as shown in figure 1, by the span loading—that is, the weight divided by the wing span. The calculated power required shown in figure 11 is based on conventional low-speed aerodynamics (calculations performed with expressions from fig. 1) and indicates that throughout most of the transition the airplane is operating on wing lift. Below about 30 knots there is a transition from wing lift to propeller lift in hovering.

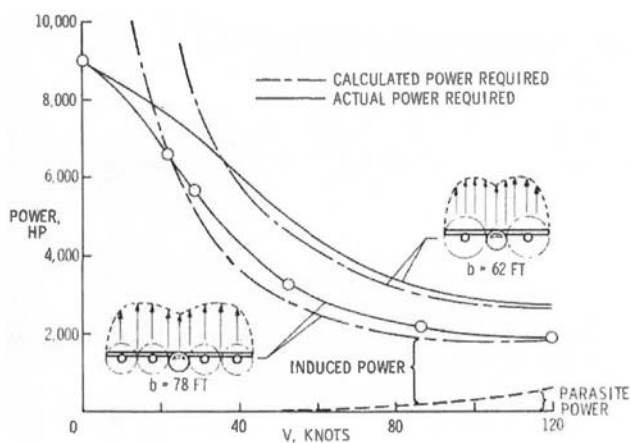

FIGURE 11. Effect of span on power required in transition. Gross weight = 40,000 lb.

A 25-percent reduction in wing span results in about a 50-percent increase in induced power because as shown in figure 1 the induced power is proportional to $(W/b)^2$. Thus, a decrease in span results in an increase in engine-out speed, and for the overloaded take-off condition, an increase in take-off distance because the short-span airplane would have to accelerate to a higher speed for take-off.

These curves are for the case without wing stall. If the wing stalls in transition, the power curve is even flatter. Design compromises necessary to avoid wing stall on flapped tilt-wing configurations are discussed in reference 4.

EFFECT OF LOAD DISTRIBUTION

The considerations shown in figure 11 are for the condition of a fairly uniform distribution of load. The effects of a poor load distribution are shown in figure 12. In cruising flight and at the high-speed end of the transition the load distribution would be fairly uniform, but as the airplane slows down in the transition the part of the wing that is not in the slipstream cannot continue to carry its share of the load. A load distribution of the type shown develops with the result that the power required corresponds to a wing of appreciably less span. These effects are shown for tilt-wing and tilt-duct configurations but apply also to buried-fan and even to a greater extent to jet V/STOL configurations.

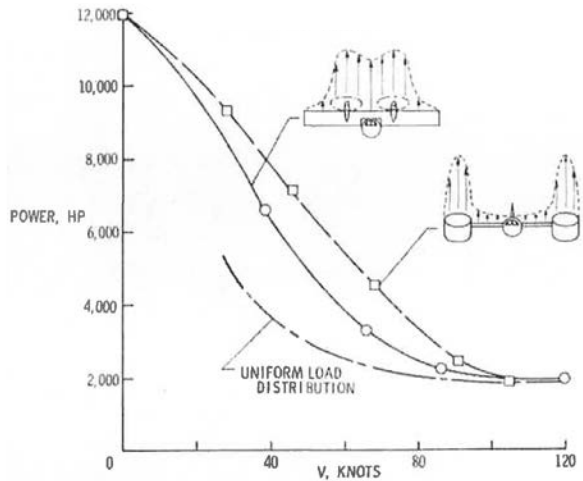

FIGURE 12. Effect of load distribution. Gross weight = 40,000 lb.

COMPARISON OF CONFIGURATIONS

In figure 13 the hovering and cruise considerations have been used to present a plot of hovering time against the cruising speed range of application for several V/STOL aircraft. This comparison assumes burning a weight of fuel equal to three percent of the gross weight of the aircraft. The choice of configuration will depend on the mission to be filled. If long hovering time is of paramount importance a rotor configuration would be dictated. Obviously jet types will be restricted to missions where the only hovering time required is the 1½ or 2 minutes required in take-off and landing.

Between these two extremes are several types that could find application as transport types but here no clear choice is indicated. For these configurations, as is frequently the case, off-design considerations may dictate the choice. One such off-design consideration is the STOL performance as shown in figure 14.

The comparison is for overloaded conditions of 120 percent of the VTOL weight. The rotor types have relatively high take-off distances because the low power requirement in hovering results in a relatively flat variation of power with speed in the transition. The flapped tilt wing makes efficient use of wing lift in the transition and the other types suffer to varying degrees from a short span or a relatively poor load distribution in transition.

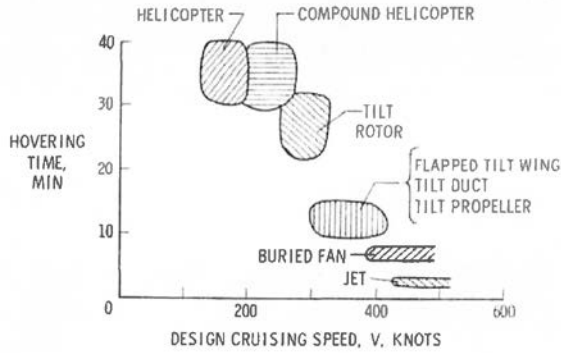

FIGURE 13. Hovering and cruise performance. $W_f = 0.03$ gross weight.

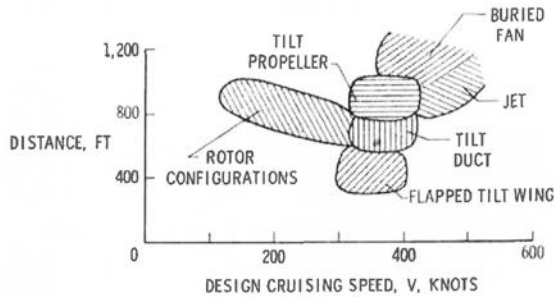

FIGURE 14. STOL performance. Take-off distance over 50-foot obstacle; $W/W_{VTOL} = 1.2$.

CONCLUDING REMARKS

In hovering the power required, the fuel consumption, and the downwash dynamic pressure are all determined by and increase with increasing slipstream area loading. In transition the wing span, the distribution of load on that span, and the power required in hovering determine the shape of the power-required curve and through this the engine-out safety and STOL performance. In cruise some compromises are required but, generally, the same rules for designing good cruise performance into conventional airplanes still apply to V/STOL configurations, namely attention to aerodynamic cleanliness to reduce the parasite power and a wing of appreciable span to reduce the induced power.

*Document 5-48 (b), Robert H. Kirby, Langley Research Center,
 "Aerodynamic Characteristics of Propeller-Driven VTOL Aircraft,"
 NASA Conference on V/STOL Aircraft, pp. 19-34.*

SUMMARY

This paper discusses the two major configurations that are usually considered for achieving VTOL while keeping the fuselage essentially horizontal—that is, the tilt-wing and the deflected-slipstream configurations.

Because of the high turning losses incurred by deflected-slipstream configurations in hovering and because of the wing-stalling problem of the pure tilt-wing configurations during the transition, it appears that a combination of the two principles should be used. This tilt-wing and flap configuration should make use of a programmed extensible-chord slotted flap together with a leading-edge high-lift device in order to avoid the performance and handling qualities problems associated with wing stalling during the transition while keeping the wing area as low as possible for efficiency in cruising flight.

INTRODUCTION

The purpose of this paper is to show some of the basic performance and aerodynamic characteristics of propeller-driven VTOL aircraft, to discuss the major problems involved, and to indicate solutions wherever possible. Under discussion are the two major propeller configurations that are usually considered for achieving VTOL while keeping the fuselage essentially horizontal—that is, the tilt-wing and the deflected-slipstream configurations. Only the hovering and transition ranges of flight are treated herein because in cruising flight these aircraft are essentially conventional propeller-driven airplanes with normal aerodynamic characteristics.

SYMBOLS

C_L	lift coefficient, Lift/ qS
c	wing chord, ft
D	propeller diameter, ft
M_α	pitching moment due to change in angle of attack, ft-lb/deg
q	dynamic pressure, $\frac{1}{2} \rho V^2$, lb/cu ft
q_t	dynamic pressure at the tail, lb/cu ft
S	wing area, sq ft
V	airspeed, ft/sec
α	angle of attack, deg
ϵ	downwash angle, deg
ρ	air density, slugs/cu ft

DISCUSSION

HOVERING

One of the major aerodynamic problems in hovering is illustrated in figure 1. In this figure the hovering effectiveness of deflected-slipstream configurations is shown in terms of the ratio of lift available for hovering to the propeller thrust plotted against the angle of slipstream deflection. For the deflected-slipstream configurations where large flaps are utilized to turn the slipstream through appreciable angles, there is a considerable loss in lift. The two curves in figure 1 are typical of the results obtained from tests on deflected-slipstream configurations. (See ref. 1.) The dashed curve, for a configuration employing two propellers, shows that only moderate angles of slipstream deflection can be achieved without incurring large losses. The solid curve, for a configuration with four propellers, shows that the turning losses are somewhat smaller. The effect resulting from the use of either two or four propellers is somewhat like an aspect-ratio effect—that is, the tip losses are greater for the two-propeller arrangement. These data are for conditions out of ground effect; the effect of the ground on these and other VTOL configurations is discussed in reference 2. A tilt-wing configuration exhibits essentially no loss in lift because the propellers are tilted instead of the slipstream being deflected. These are the only points to be made in connection with the performance in the hovering flight range and the rest of the paper considers the characteristics in the transition range of flight.

AERODYNAMIC FACTORS AFFECTING PERFORMANCE IN TRANSITION

In figure 2 is indicated the power required during transition for the tilt-wing and the deflected-slipstream configurations. These

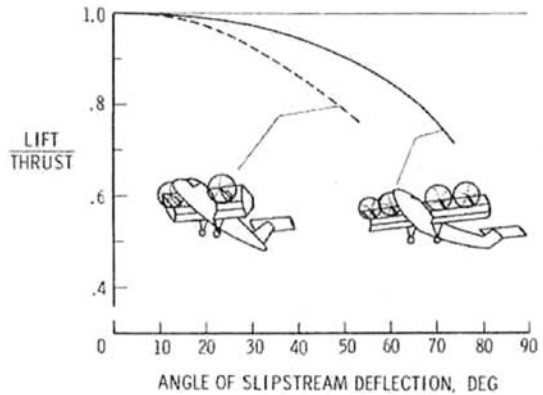

FIGURE 1. Hovering effectiveness of deflected-slipstream configurations.

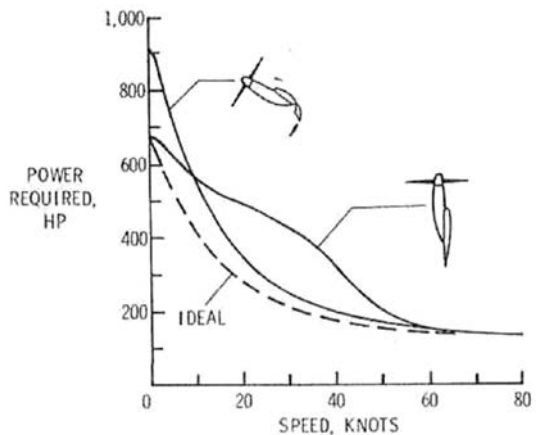

FIGURE 2. Power required during transition.

data and all other power-required data presented herein have been calculated for an assumed aircraft gross weight of 3,600 pounds. The dashed curve labeled "Ideal" shows the calculated induced power required with an assumed, uniform span loading without wing stalling, as discussed in reference 3. For hovering flight the deflected slipstream configuration required considerably more power than that indicated by the ideal curve because of the losses incurred in turning; however, the power required for this configuration rapidly approaches that of the ideal curve as the speed increases. On the other hand, the tilt-wing configuration requires no more power than the ideal in hovering but rapidly diverges with forward speed and requires considerably more power during the transition than either the deflected-slipstream configuration or that indicated by the ideal curve. The excess power required during transition is caused by wing stalling. This wing stalling is a problem not only because of its effect on power required which is reflected in poor overload STOL performance (ref. 4) but also because of its large effect on handling qualities as is brought out in reference 5.

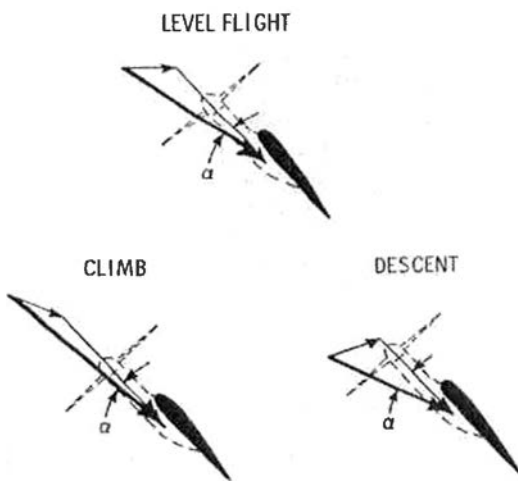

FIGURE 3. Wing angle of attack during transition flight.

In order to understand this wing stalling, figure 3 is presented and shows in schematic form the wing angle of attack during transition flight for the level-flight, climb, and descent conditions. For the level-flight condition, a horizontal vector represents the forward-flight velocity and another vector represents the incremental velocity added by the propeller. These two vectors give the resultant velocity that is experienced by the wing. The angle of this resultant vector to the wing is then the angle of attack that the wing experiences. Of course, changes in disk loading change the

incremental velocity added by the propellers. A higher disk loading gives a higher slipstream velocity and therefore reduces the wing angle of attack. Also, the portions of the wing that are not in the propeller slipstream experience a very high angle of attack under these conditions. This effect and the effect of changes in disk loading are discussed in the next paper by Mark W. Kelly. Also, in figure 3 are shown the effects of climb and descent on the wing angle of attack. The conditions shown are for maintaining constant forward velocity and wing attitude with respect to the ground. For the descent condition, the power is reduced which, in turn, reduces the slipstream velocity increment added by the propeller, and the direction of the free-stream velocity is also changed. As a result of these two changes, there is a

considerable increase in the angle of attack of the wing in descent. For the climb condition, the velocity changes are in the opposite direction and, therefore, the angle of attack is reduced.

Figure 4 shows a typical variation of angle of attack of the wing with forward speed for the descent, level-flight, and climb conditions. The dashed line shows the approximate stall angle of attack of a representative airfoil. Figure 4 shows that, if a wing was about at the stall angle in level flight, it would stall in descent over a wider range of speeds but would be unstalled in climbing flight. It also appears from this figure that stalling might not occur in level flight, except over a small range of speeds. However, the stall picture is not as clear cut as indicated by this figure. This representation is that which would be obtained with counterrotating propellers where there is no rotation in the slipstream. For the single-rotation propeller, the slipstream rotation complicates the problem, as indicated in figure 5.

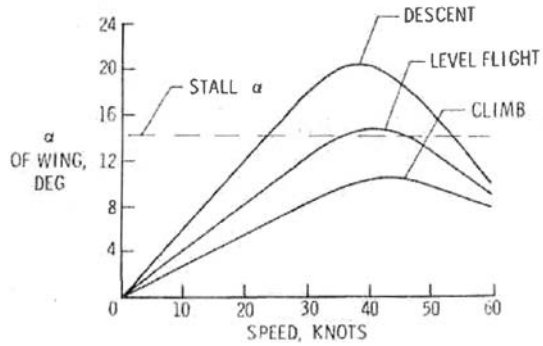

FIGURE 4. Typical variation of angle of attack with speed.

Figure 5 shows the variation of wing section angle of attack with speed. The curve for level flight with no rotation is reproduced from figure 4. Actually, as shown by the sketch at the bottom of figure 5, the slipstream rotation causes an increase in angle of attack on one side of the propeller disk and a decrease on the other side. The magnitude of the change in angle of attack for the case indicated by the sketch is shown by the other two curves. The top curve shows that the wing

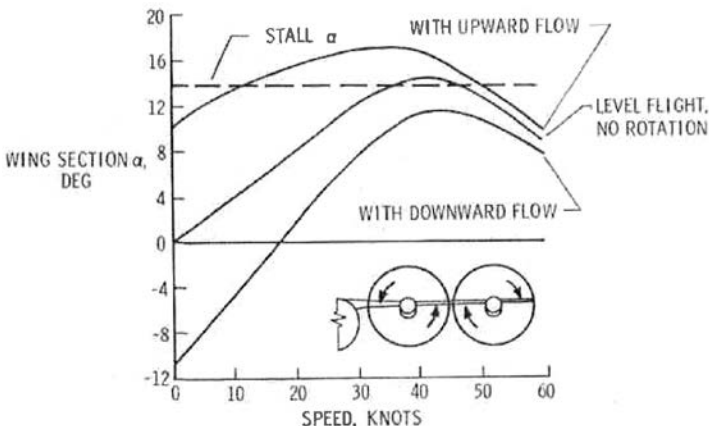

FIGURE 5. Effect of slipstream rotation on angle of attack.

sections experiencing upward flow from the slipstream are stalled for practically the entire transition range, whereas the bottom curve indicates an unstalled condition, at least for level flight, for the wing sections experiencing downward flow from the slipstream.

Figures 2 to 5 have presented the problem of wing stalling on tilt-wing configurations during the transition range of flight. Ways to reduce this problem are now considered. The approaches to use are indicated in a qualitative way in figure 6. This figure shows lift curves for a wing with high-lift devices. If the wing is near stall, one means of avoiding it is to increase the stall angle of the wing by the use of a slat or some other leading-edge device. Another means of avoiding stalling is to use a flap which, for the same lift, reduces the wing angle of attack to get away from the stall region. Of course, both the flap and slat can be used to get double benefit. Another way, which is not shown directly in figure 6, is to use more chord and therefore more wing area. With more wing area the required lift can be produced with a lower lift coefficient which again moves the wing farther from the stall region.

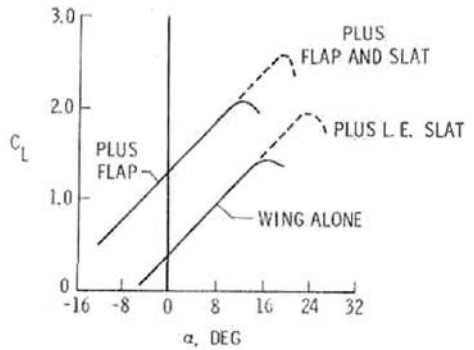

FIGURE 6. Changes in lift curves caused by high-lift devices.

Figures 7 to 9 show some experimental data demonstrating the use of these curves. Figures 7 and 8 are based on the data contained in reference 6 and figure 9 is based on the data in reference 7.

Figure 7 shows the effect of wing chord on power required as a function of speed for wings having chord-diameter ratios of 0.33, 0.50, and 0.75. This might also be considered the effect of wing area—that is, the area immersed in the propeller slipstream. Figure 7 shows very readily that as the wing chord is increased, the power required is markedly reduced.

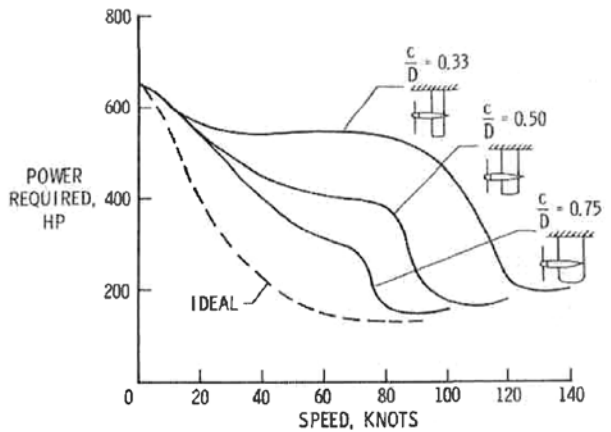

FIGURE 7. Effect of wing chord.

Figure 8 shows the effect of a slat on power required for the three wings of different chord-diameter ratios used in figure 7. For each wing[,]

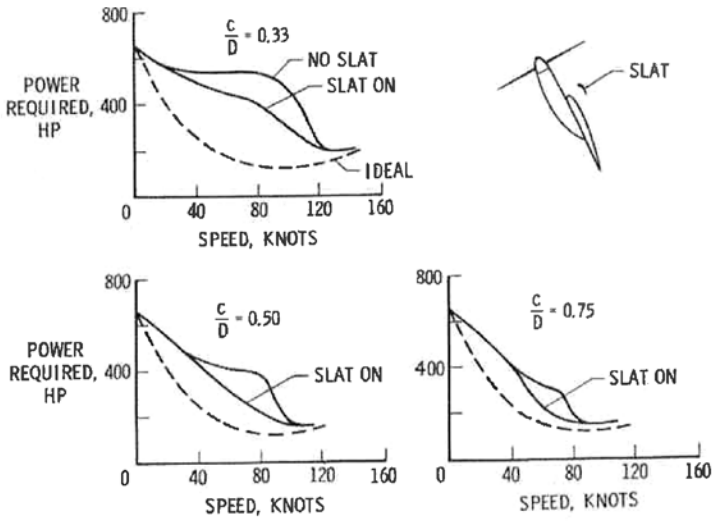

FIGURE 8. Effect of slats.

curves are shown for no slat, slat on, and the ideal case. Again, it is evident that the slat made a significant improvement in the power required and presumably in the wing stalling.

The effect of flaps on the power required is shown in figure 9 for the pure tilt-wing configuration and for the same wing with a 40-percent extensible-chord slotted flap deflected 50° throughout the range of flight. The use of this flap gives a power-required curve that very closely approaches the ideal curve. With the flap deflected 50° , however, a considerable increase in power is required for hovering. In actual practice, then, it would seem more logical to program the movement of the flap so that the flap would be at 0° for hovering and cruise but would be deflected for intermediate angles of tilt through the speed range.

From figures 7 to 9 it can be seen that the use of either adequate wing chord, slats, or flaps tends to reduce the effect of wing stalling during the transition range of flight. The question, then, is which approach and how much of each to use. For example, for the case illustrated in figure 9, the use of a large wing chord and a flap ($c/D = 0.84$ with flap extended) results in performance that probably cannot be improved by the addition of a slat. In actual practice, however, the wing of a propeller-driven airplane tends to be overly large for maximum performance in cruising

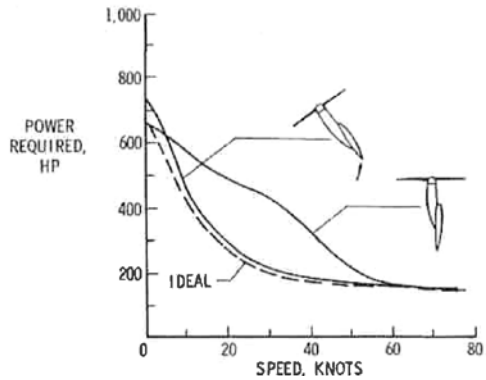

FIGURE 9. Effect of flaps.

flight and therefore it is of interest to keep the wing area or wing chord as small as possible for cruising flight. For this reason, it appears that flaps and slats should be used to their fullest extent during transition and the chord should be made just large enough to avoid serious stalling. Also, it seems logical that a flap that extends the chord of the wing when deflected should be used in order to keep the area of the basic wing to a minimum for cruising flight.

AERODYNAMIC FACTORS AFFECTING STABILITY AND TRIM

In figure 10 the pitching moment for the steady-flight condition throughout the transition range is shown for the tilt-wing and deflected-slipstream configurations. The pitching moment is presented as the amount of trim force required at the tail in percent of gross weight.

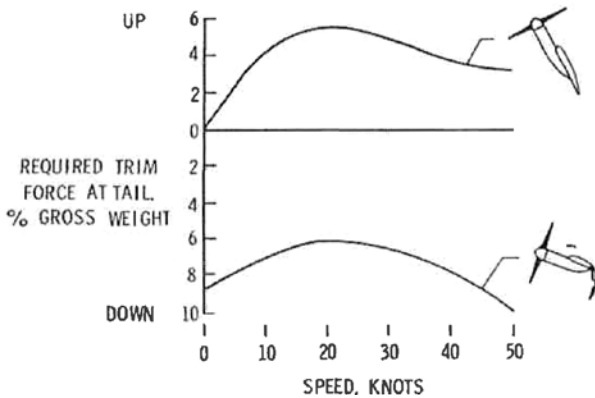

FIGURE 10. Variation of pitching moment with speed. Center of gravity at $0.25c$ in cruise.

Basically the tilt-wing configuration tends to give a nose-up pitching moment during transition because of a large nose-up moment produced by the propeller itself. The deflected-slipstream configuration has nose-down pitching moments because of the diving moments of the flaps about a center of gravity located at the quarter-chord station that was used in this figure. The magnitude of these pitching moments for

both configurations is such that large trim forces would be required at the tail at airspeeds that are so low that the horizontal tail could not be expected to have an appreciable effect. These moments would therefore impose a severe additional requirement on the hovering controls which, from other considerations, would be required to produce a force at the tail of about ± 5 percent of the gross weight.

The two curves in figure 10 indicate that for a combination tilt-wing and deflected-slipstream configuration, the flaps could be programmed to give effectively zero pitching moment throughout the whole transition range. This point has been checked out in wind-tunnel tests and it was found that the pitching moments can be trimmed out with a relatively modest amount of flap or by simply a single slotted or extensible-chord slotted flap. These tests also showed that for this combination tilt-wing and flap configuration the program of flap deflection required to eliminate the pitching moment was also very effective in minimizing wing stalling and in achieving a desirable low power-required curve.

Figure 11 indicates the characteristics of the air flow at the tail for an arrangement shown by the sketch. The data, however, are reasonably representative of the

flow for either the tilt-wing, deflected-slipstream, or combination tilt-wing and flap configuration. The top curve shows that there is a considerable range of speeds where the dynamic pressure at the tail q_t is so low that the horizontal tail would not have any effectiveness and the pilot would have to rely entirely on the hovering controls. The middle curve shows that there is a large variation of downwash angle over the speed range and, therefore, a variable-incidence horizontal tail would probably have to be installed to keep the tail from producing undesirably large nose-up pitching moments during the latter part of the transition. The bottom curve shows the variation of the downwash factor $(1 - (d\epsilon/d\alpha))$, a stability factor which influences the effectiveness of the tail for producing static longitudinal stability. Small values indicate that the tail will be ineffective, whereas large values indicate that the tail will be very effective.

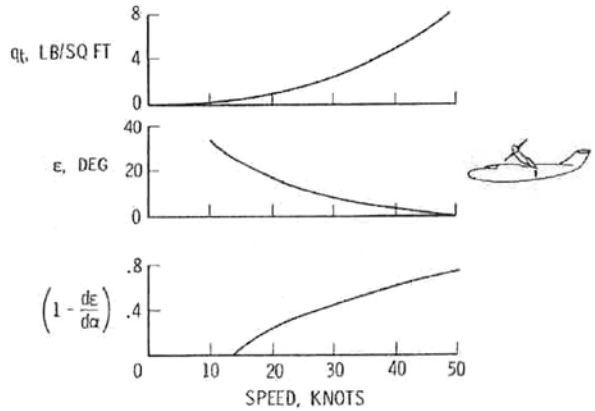

FIGURE 11. Characteristics of the airflow at tail.

From the bottom and top curves of figure 11, it is evident that at low speed, not only is the force produced small because of low q_t but the force produced is not very effective for static stability because of the unfavorable downwash characteristics.

In figure 12 the variation of static longitudinal stability—that is, stability of attitude—in the transition range is presented for seven different configurations that have been tested: two deflected-slipstream, three tilt-wing, and two combination

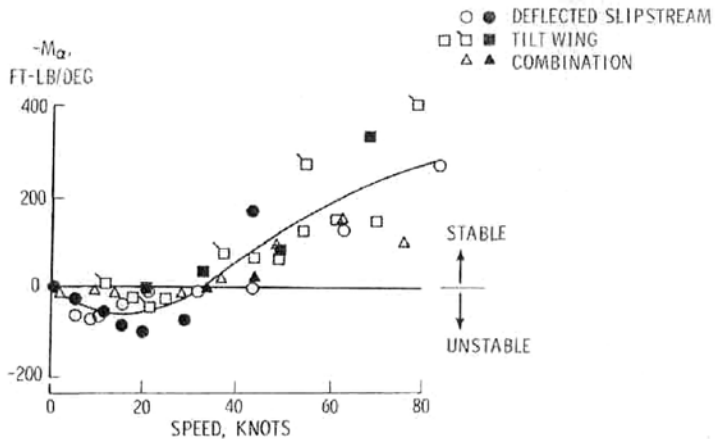

FIGURE 12. Static longitudinal stability.

tilt-wing and flap configurations. The data show that all these configurations tend to be unstable at low speed and become stable at higher forward speeds, as expected from the results of the data in figure 11.

The degree of static longitudinal stability is indicated in figure 12 in dimensional terms (ft-lb/deg) since ordinary nondimensional coefficients based on forward speed lose their significance as the speed approaches zero. The data from these different configurations, both full scale and model, were scaled to represent an aircraft weighing about 3,600 pounds in order to show them in the same plot. The actual numbers are not important. The significant point is that the trend is about the same for all the widely different configurations and all become stable at about the same speed. The instability in the low speed range has not seemed to bother the pilots flying the test beds, probably because of the low speeds involved. Also, it should be remembered that the static stability parameter M_α is only one of the factors affecting longitudinal flight characteristics.

CONTROL

The amount of control required for propeller driven VTOL aircraft is discussed in reference 8 but the point to be discussed in this paper is the means of obtaining this control in hovering and low-speed flight with propeller-driven configurations. Roll control and yaw control are fairly straightforward. It is evident that the variable pitch propeller controls that will already be on the airplane can be used for roll control. It also seems likely that the flaps or ailerons, which would be in the propeller slipstream, can be used for yaw control, although this idea has been only partially checked out by research. Pitch control, however, is not so straightforward and depends to a great extent on the wing position, as is indicated in figure 13.

Shown in figure 13 are three possible wing arrangements: a low wing with the pivot forward on the wing chord and two high wings—one with a forward pivot, such as that used on the tilt-wing test beds, and one with a rear pivot. Concerning the low wing arrangement, it can be seen that the trailing-edge flaps have an appreciable moment arm from the aircraft center of gravity which gives the possibility of obtaining pitch control from these flaps in hovering and low-speed flight. However, with the high wing arrangements, the

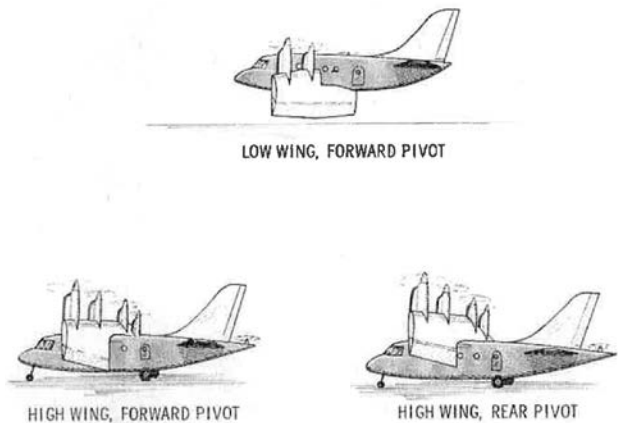

FIGURE 13. Low and high wing arrangements.

flap load is so close to the center of gravity that the flaps are ineffective for pitch control and some other means of control must be used. One method is the installation of cyclic pitch control and flapping blades. Another and perhaps a simpler method would be the use of an auxiliary control such as a tail rotor, as indicated in the sketches of figure 13. Of course, aerodynamics is not the only consideration in selecting a wing arrangement. For example, two other considerations that are obvious from the sketches are that the low wing gives a high fuselage which results in loading problems (particularly for military applications) and that the high wing with forward pivot gives very little structural carry-through in the center of the wing since most of the wing chord has to pivot beside the fuselage.

CONCLUDING REMARKS

Because of the high turning losses incurred by deflected-slipstream configurations in hovering and because of the wing-stalling problem of the pure tilt-wing configuration during the transition, it appears that for a propeller-driven VTOL aircraft, a combination of the two principles should be used. This tilt-wing and flap configuration should make use of a large extensible-chord slotted flap together with a leading-edge high-lift device in order to avoid the performance and handling qualities problems associated with wing stalling during the transition while keeping the wing area as low as possible for efficiency in cruising flight.

The flap should be programmed so that it is at zero deflection with 90° wing incidence for high hovering efficiency and is deflected only in the transition range of flight. The actual flap programming can be chosen to give both minimum pitch trim through the transition range and near optimum results from the power-required and wing-stalling considerations. Since this arrangement results in a low power-required curve, it would also have good STOL performance.

*Document 5-48 (c), Richard C. Dingeldein, Langley Research Center,
"Considerations of Methods of Improving Helicopter Efficiency,"
NASA Conference on V/STOL Aircraft, pp. 101-117.*

SUMMARY

Recent NASA helicopter research indicates that significant improvements in hovering efficiency, up to 7 percent, are available from the use of the NACA 63A015(230) airfoil section. This airfoil should be considered for flying-crane-type helicopters. Application of standard leading-edge roughness causes a large drop in efficiency; however, the cambered rotor is shown to retain its superiority over a rotor having a symmetrical airfoil when both rotors have leading-edge roughness.

A simple analysis of available rotor static-thrust data indicates a greatly reduced effect of compressibility effects on the rotor profile-drag power than predicted from calculations.

Preliminary results of an experimental study of helicopter parasite drag indicate the practicability of achieving an equivalent flat-plate parasite-drag area of less than 4 square feet for a rotor-head-pylon-fuselage configuration (landing gear retracted) in the 2,000-pound minimum-flying-weight class. The large drag penalty of a conventional skid-type landing (3.6 square feet) can be reduced by two-thirds by careful design. Clean, fair, and smooth fuselages that tend to have narrow, deep cross sections are shown to have advantages from the standpoint of drag and download. A ferry range of the order of 1,500 miles is indicated to be practicable for the small helicopter considered.

INTRODUCTION

This paper summarizes the results of recent research relating to improving the efficiency of a helicopter in hovering and in forward flight. The reader having competence in the field of helicopter aerodynamics will recognize no new or startling concepts. The data presented, however, are believed to assure the practicability of large helicopter performance improvements.

Large gains in rotor hovering efficiency are shown for a special airfoil formed by combining an NACA 6A-series thickness distribution and an NACA forward-camber mean line. The reduction in efficiency accompanying two different conditions of rotor-blade leading-edge roughness is given. Available static-thrust data obtained on a large number of helicopter rotors operated at high tip speeds are summarized to show the general effect of compressibility on the rotor profile-drag power coefficient and are compared with calculated predictions. In addition, preliminary results obtained from an experimental study of helicopter parasite drag are presented to show the relative drag of the different helicopter components.

This information forms the basis of calculations used to demonstrate significant improvements in helicopter cruising efficiency.

SYMBOLS

b	number of rotor blades
c	blade chord at station x
c_e	equivalent blade chord, $(\int_0^1 cx^2 dr)/(\int_0^1 x^2 dr)$
D	parasite drag, lb
L	lift, lb
T	rotor thrust, lb
M	Mach number
P	rotor power, ft-lb/sec
R	rotor radius, ft
C_T	rotor thrust coefficient, $T/[\rho(\Omega R)^2 \pi R^2]$
C_P	rotor power coefficient, $P/[\rho(\Omega R)^3 \pi R^2]$
\bar{C}_L	rotor mean lift coefficient, $6C_T/\sigma$
r	radius to blade element, ft
x	r/R
SFC	specific fuel consumption, lb/hp-hr
α	angle of attack
ρ	density of air, slugs/cu ft
Ω	rotor angular velocity, radians/sec
σ	rotor solidity, $bc/\pi R$
θ_1	rotor blade geometric twist (negative sign denotes washout), deg

Subscripts:

0	profile drag
t	blade tip
div	denotes drag divergence of two-dimensional airfoil
f	fuselage

RESULTS AND DISCUSSION

HOVERING EFFICIENCY

Effect of camber—The advantages of cambered rotor blades in respect to producing improved hovering and forward-flight efficiency are well known. (See refs. 1 to 3.) In an effort to define a rotor-blade airfoil section that would essentially realize the largest practicable gains in hovering efficiency that are available through airfoil selection, an NACA 63A015 thickness distribution was mated to an NACA 230 mean line. This thickness distribution was chosen because helicopter tower tests of a rotor having an NACA 63₂-015 airfoil section (ref. 4) indicated the highest overall

combination of high maximum mean rotor lift coefficients and resistance to compressibility drag rise of a number of full-scale rotors previously tested. The NACA 63A015 thickness distribution should have essentially the same aerodynamic characteristics as the NACA 63₂-015 thickness distribution (refs. 5 and 6) and its larger trailing-edge angle avoids construction problems associated with the cusped trailing edge. The expectation, then, was to realize the benefits of camber without introducing large quarter-chord pitching moments or early drag divergence. Rotor blades having the new airfoil (denoted as the NACA 63A015 (230)) were tested on the Langley helicopter tower (ref. 7). A sample of the results is shown in figure 1, in which the rotor hovering efficiency (defined as the rotor figure of merit) is plotted against the rotor-blade tip Mach number for values of the rotor mean lift coefficient \bar{C}_L of 0.5, 0.7, and 0.9. This parameter is proportional to the rotor-blade loading. A utility helicopter would probably operate at the lower value shown, a flying-crane type at the higher values. Also shown are the data for the rotor having an NACA 63₂-015 airfoil section. These rotors were similar in respect to solidity, twist, and surface condition. Substantial gains due to camber, up to 6 or 7 percentage points, are indicated. At typical rotor disk loadings, a 5-percent gain in figure of merit is equivalent to an extra one-half to two-thirds of a pound of rotor thrust per horsepower delivered to the rotor. This value is equivalent to a 5- to 8-percent increase in the gross rotor thrust, or a 10- to 15-percent or more increase in the helicopter payload. The gains due to camber disappear as the rotor-tip Mach number increases past 0.6; however, this is not a range generally associated with a flying-crane helicopter.

It should be noted that the gains indicated in figure 1 did not require extreme care with the airfoil contour and surface condition. For example, the high efficiencies shown in figure 1 do not depend on a section drag polar having the familiar bucket shape. The contour was good and the blades were smooth and fair, but no elaborate quality-control procedures were taken.

It should also be stated that the data shown for the NACA 63₂-015 rotor average some 2- to 4-percent higher hovering efficiencies than were obtained on the helicopter tower from tests of a rotor having the widely used NACA 0012 airfoil.

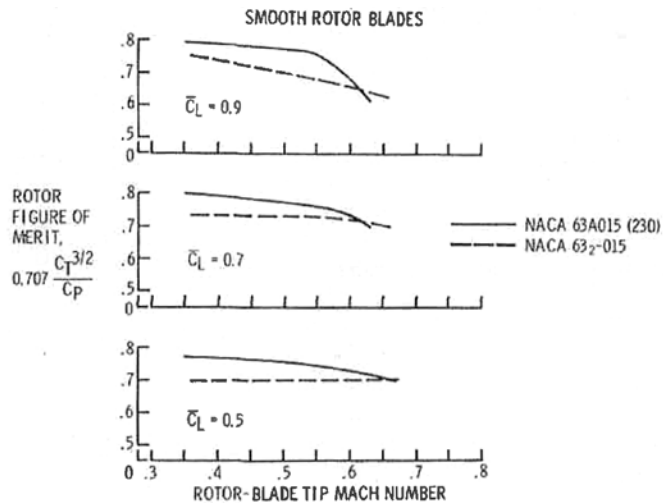

FIGURE 1. Effect of camber on hovering efficiency.

Effect of leading-edge roughness—Since rotor blades may not be operated in the smooth condition due to the abrading effects of field operation, two different amounts of leading-edge roughness were investigated. First, shellac of rather thick consistency was applied over an area extending 8 percent of the chord (measured along the surface) back from the leading edge on both the upper and lower surfaces. The resulting spanwise brush marks produced surface waves 0.002 to 0.004 inch in height. Next, the aforementioned condition was removed and NACA standard leading-edge roughness was added. This roughness consisted in applying fresh shellac over the same area previously described and sprinkling with 0.005-inch grains of carborundum distributed to cover about 5 percent of the area. Measurements of the typical roughness heights showed variations from about 0.006 inch to 0.009 inch. The resulting hovering efficiencies are compared with the smooth rotor in figure 2. The shellac alone had very little effect, but the standard roughness caused up to a 12- or 13-percent drop in the hovering efficiency. This decrease in hovering efficiency, of course, corresponds to a similar increase in the power required to produce a given rotor thrust. The high hovering efficiency capabilities of the NACA 63A015(230) airfoil, therefore, cannot be expected unless the rotor blades are built and kept fairly smooth. The condition of NACA standard leading-edge roughness is believed comparable to the severe erosion that has already been noted in certain helicopter operations and with present blade leading-edge materials.

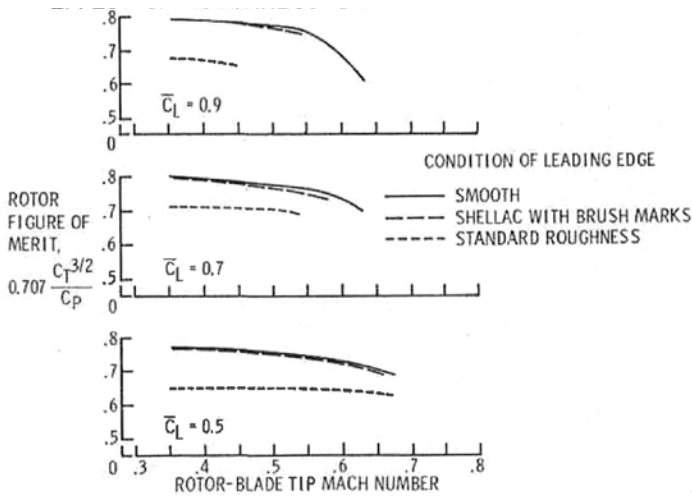

FIGURE 2. Effect of roughness on hovering efficiency.

In figure 3 is shown a comparison between the rotors having NACA 63A015(230) and NACA 632-015 airfoil sections for the condition of NACA standard roughness applied to both rotors. It is seen that the cambered airfoil retains its considerable superiority in hovering efficiency over the range of test conditions presented.

Effect of reduced thickness and camber—In an attempt to improve rotor hovering efficiency at rotor tip Mach numbers above 0.6 while retaining some of the advantages indicated for camber at the lower rotor tip Mach numbers, the NACA 63A012 thickness distribution was mated to an NACA 130 mean line. The results of testing a rotor having the resulting NACA 63A012(130) airfoil are shown in figure 4. The combined effects of reduced thickness and camber are seen to give reduced hovering efficiency compared with the NACA 63A015(230) rotor at $\bar{C}_L = 0.9$ and 0.7, and gains at $\bar{C}_L = 0.5$ only at the higher blade tip Mach numbers. For the range of conditions illustrated in figure 4, the NACA 63A012(130) rotor nevertheless indicates somewhat higher efficiencies than the NACA 63₂-015 rotor. It is believed that the NACA 63A015(230) airfoil represents as good a compromise for a load-lifter type helicopter as can be obtained from the standpoint of airfoil choice.

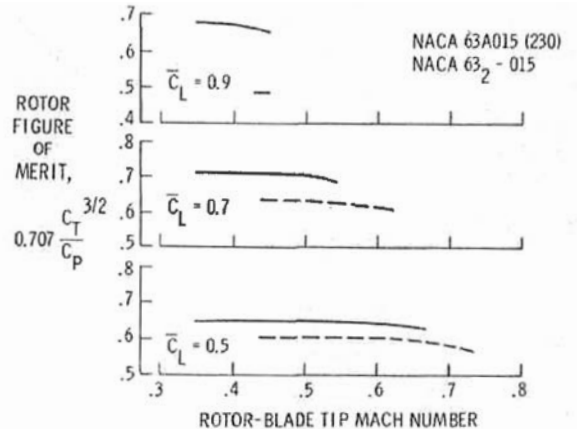

FIGURE 3. Effect of camber on hovering efficiency (NACA standard L.E. roughness).

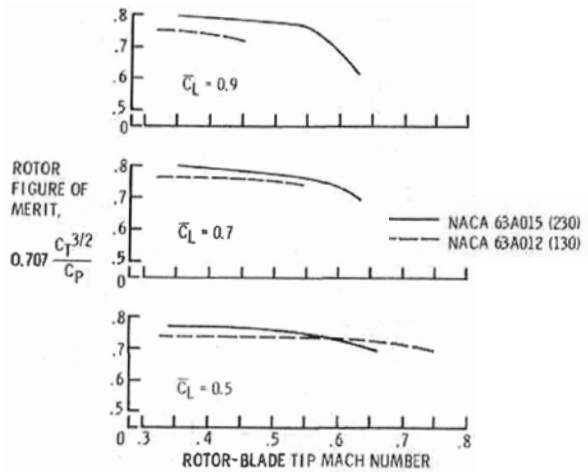

FIGURE 4. Effect of airfoil section on hovering efficiency.

Effect of compressibility on rotor power requirements—The preceding discussion of figures 1 and 3 has touched on the reduced hovering efficiency associated with the higher rotor-blade tip Mach numbers. From the standpoint of achieving higher forward speeds, the use of higher rotor tip speeds continues to be of interest. A number of large-scale helicopter rotors have been tested in static thrust at relatively high blade-tip Mach numbers, mostly on the Langley helicopter tower facility. (See, for example, refs. 4 and 8 to 11.) A summary of the test results, representing rotor-blade airfoil sections from 6 to 18 percent thick and rotational blade-tip Mach

numbers as high as 1, is shown in figure 5. The purpose of this figure is not to compare airfoils but to provide a quick, broad look at the overall effect of compressibility on the rotor hovering-power requirements. In an attempt to generalize the results, increments in the rotor profile-drag power coefficient measured over the available

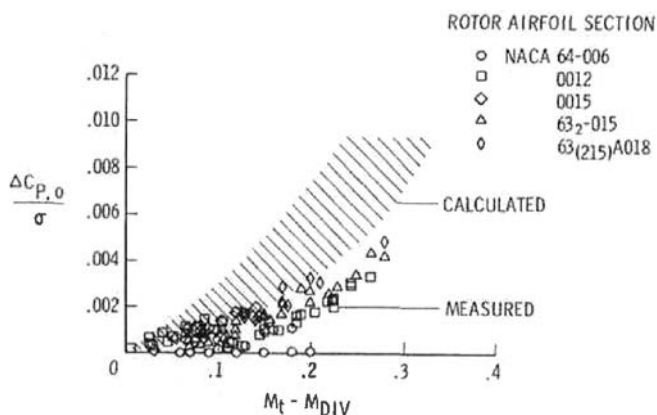

FIGURE 5. Compressibility effects on hovering helicopter rotors.

ranges of rotor tip Mach number and blade pitch angle afforded by the test data were divided by the rotor solidity and plotted against the amount by which the rotor-blade tip Mach number exceeded the drag-divergence Mach number determined from two-dimensional airfoil tests. Also shown is a shaded area representing the results of a number of strip calculations for two different NACA 0012 rotors using compressible airfoil section data and covering a range of blade pitch and tip Mach number. The experimental data are seen to group in a band that lies well below the calculated predictions. A substantial tip relief is also indicated. It therefore appears that greatly reduced effects of compressibility on the power required in forward flight were experienced compared with calculated estimates. The most serious effects of compressibility are probably associated with blade and rotor stability problems; however, these results can be considered as somewhat encouraging. This general research area requires more study.

CRUISING EFFICIENCY

Improvements in the forward-flight efficiency of helicopters, primarily with respect to cruising speed and range, are being sought by helicopter operators, particularly the military. Obtaining these improvements is mainly dependent upon the reduction of parasite drag. (See, for example, refs. 12 and 13; the powerplant installation is treated in ref. 14.) In the remainder of the paper the problem will be examined and the preliminary results of recent research will be discussed and used to illustrate the practicability of achieving significant improvements in helicopter forward-flight efficiency, particularly the ferry range.

Parasite drag.—There is considerable airplane-drag-cleanup experience to profit from. (See refs. 15 to 20.) However, the rotor-head-pylon-fuselage combination and the presence of potentially large fuselage downloads in hovering and in forward flight constitute problems peculiar to rotating-wing aircraft and hence warrant

special study. An experimental model and full-scale test program has been initiated to study means of achieving low helicopter drag and to assess the drag penalties of various helicopter components. The model tests, conducted at $\frac{1}{5}$ scale in the Langley 300-MPH 7- by 10-foot tunnel at a dynamic pressure of about 210 pounds per square foot, are primarily aimed at studying the effect of fuselage and pylon shape and to establish the primary problem areas. The full-scale tunnel test provides data essentially free of scale effects and permits the evaluation of actual hardware, such as antennas.

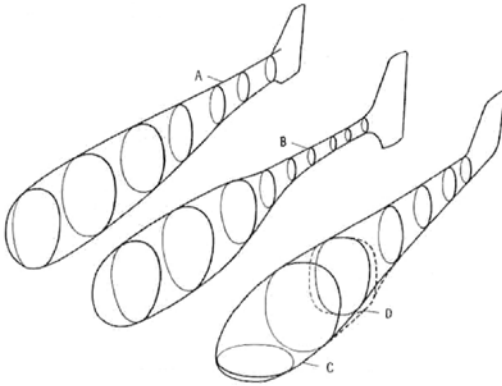

FIGURE 6. Fuselage shapes used in model tests.

5 feet long. The projected frontal areas of shapes A, B, C, and D were, respectively, 0.75 square foot, 0.71 square foot, 0.75 square foot, and 0.75 square foot.

Sample equivalent flat-plate parasite-drag areas obtained for fuselage shape C and for a pylon, rotating rotor head, and two different skid-type landing gears are shown in figure 7 for a fuselage angle of attack of 0° . No support-interference corrections have been applied. The model data have been scaled up to the full-scale values, which, in this case, can be taken as representative of a helicopter having a minimum flying weight of the order of 2,000 pounds. The drag of the basic smooth, clean, and fair fuselage is 1 square foot. Adding a clean, streamlined pylon brings the total to 3 square feet. Adding an estimated allowance for the tail rotor brings the total to 3.5 square feet. Installing a conventional skid landing

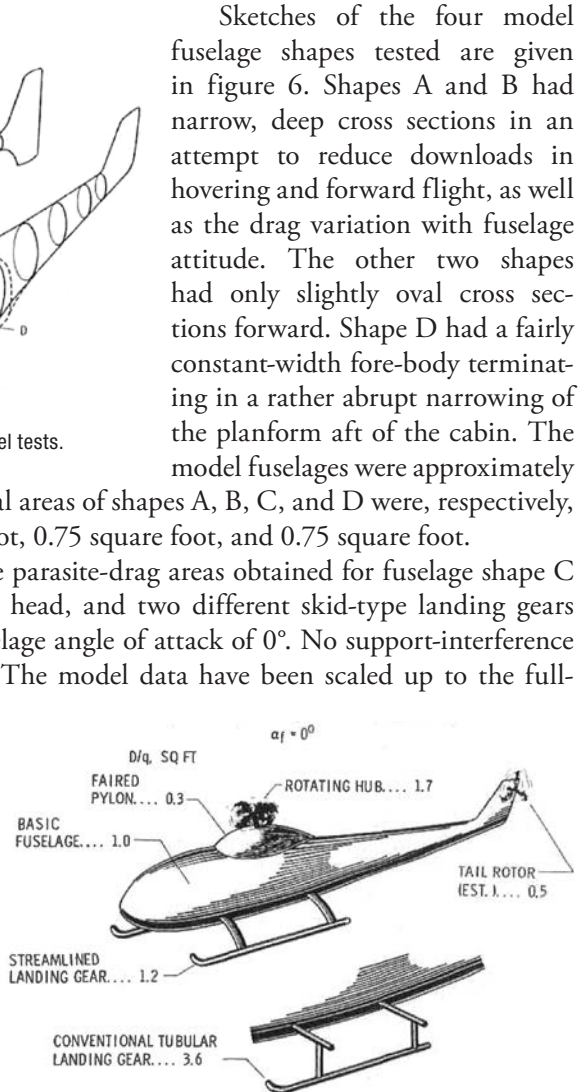

FIGURE 7. Equivalent parasite drag areas of various helicopter components.

gear of tubular construction doubles the parasite drag to a value of 7.1 square feet. A skid gear which is designed for low drag by using streamlined support struts that track at the cruise attitude and intersect the fuselage normal to the surface rather than at an acute angle is seen to add only about one-third the drag of the conventional gear for a total helicopter parasite-drag area of 4.7 square feet. The literature (refs. 18 to 20) indicates a similar increment from a clean wheel-type gear. The penalty for a dirty-wheel arrangement can be several times this increment. The data provide good arguments for cleaning up or completely retracting the landing gear of a high-performance helicopter.

The Reynolds number of the tubular gear, based on the cylinder diameter, was below the critical value for the model tests. A consideration of the full-scale landing gear that it was patterned after indicates that it, too, would be below the critical Reynolds number for cruising speeds below 110 knots.

The fuselage and pylon parasite-drag values shown are not at all representative of current helicopters, which customarily penalize an already poor aerodynamic shape with additional drag from leakage and nonflush doors, windows, hatches, and other protuberances which not only contribute their own drag but also cause flow separation on the basic fuselage.

Additional preliminary lift and drag data obtained from the $1/5$ -scale model tests are given in figures 8 and 9. From figure 8 it is seen that minimum equivalent flat-plate parasite-drag areas of fuselage shapes A and C of the order of 1 square foot were measured. Shapes B and D indicate progressively higher minimum-drag, which is probably the result of flow separation in the vicinity of the tail-boom juncture and the abrupt planform closure, respectively. The advantages of a fuselage shape that tends to be narrow and deep rather than broad in cross section is clearly shown in figure 8. Greatly reduced downloads are indicated for fuselages A and B at typical forward-flight attitudes compared with fuselages C and D. Reduced downloads in hovering would also be expected for shapes A and B. Somewhat more favorable variation in the fuselage drag with angle of attack is also apparent. The fact that two of the four fuselages showed relatively low drag, somewhat higher drag being indicated for the two shapes (B and D) that were more subject to flow separation, indicates the importance of designing a smooth and fair shape that avoids sudden changes in contour if low parasite drag is to be achieved. Improved aircraft-construction practice

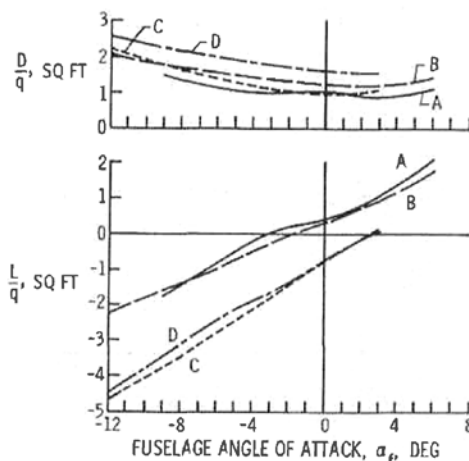

FIGURE 8. Lift and drag characteristics of basic fuselage shapes (model data presented for full-scale helicopter).

similar to that used on high-performance conventional aircraft will be necessary.

The increase in parasite drag with angle of attack noted in figure 9 (about 1/2 square foot in going from $\alpha_f = 0^\circ$ to $\alpha_f = -5^\circ$) constitutes a performance penalty. Improved cruising efficiency can be obtained by installing the rotor shaft at an angle in order to keep the fuselage level in cruise.

A consideration of area and volume relationships indicates that it should be considerably less difficult to achieve a proportionately low parasite drag for heavier helicopters.

Ferry-range capability—In order to determine a practicable ferry range for a clean turbine-powered helicopter of the type for which the previously presented drag data were obtained, limited performance estimates were made with available calculation procedures. (See refs. 21 to 23.) An equivalent parasite-drag area of 4 square feet, which assumes a retractable landing gear, was used. Also selected were a rotor solidity of 0.07, a blade twist of -8° , and a design rotor tip speed of 600 feet per second. These parameters were selected to provide good overweight performance. Calculations of the cruise performance were made over a range of gross weights. The maximum effective helicopter lift-drag ratios calculated, which occur at airspeeds of the order of 110 knots, are plotted in figure 10 over a range of ratios of gross weight to normal gross weight. The overload for the ferry mission would be primarily fuel.

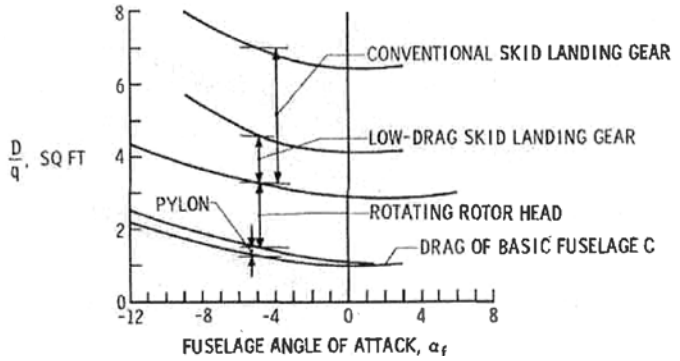

FIGURE 9. Sample model fuselage drag data. Results presented for full-scale helicopter.

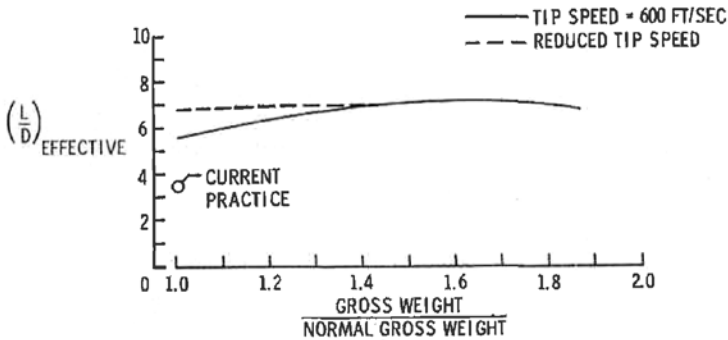

FIGURE 10. Lift-drag ratios calculated for sample helicopter. $\sigma = 0.07$; $D/q = 4$ sq ft; $\theta_1 = -8^\circ$.

An L/D of about 7 is indicated at weight ratios above 1.4, which, incidentally, would require a running take-off. Reduced efficiency is indicated at normal gross weight, although the clean helicopter is seen to show to advantage over current practice. A flight procedure of gradually reducing the speed of the power turbine to 85-percent rated speed at the normal gross weight has the effect of producing an almost constant value of L/D of 7 over the broad range of weight ratios shown.

By using a conservative average L/D of 6, a specific fuel consumption of 0.75 lb/hp-hr, and a minimum flying weight of 1,950 pounds (includes pilot and 1 crew), the ferry-range potential shown in figure 11 is calculated. The Breguet range equation was used; the results were multiplied by a 70-percent factor to allow for take-off, climb, headwinds, and fuel reserves. For a running take-off with 2,000 pounds of fuel onboard, a ferry range of 1,500 miles is indicated. The assumptions of this analysis are believed to be realistic, if not conservative.

CONCLUDING REMARKS

Considerations of the results of recent NASA helicopter research programs have indicated the practicability of large improvements in rotor hovering efficiency by the use of a smooth NACA 63A015(230) rotor airfoil section. Increases in the rotor figure of merit as high as 6 or 7 percent have been demonstrated over an improved rotor having symmetrical airfoil sections. Leading-edge roughness of the type that has been experienced in some helicopter operations is shown to reduce the hovering efficiency drastically. The gains associated with camber, however, are retained over the symmetrical airfoil with standard leading-edge roughness applied. The advantages of camber in this particular case tended to disappear above rotor-blade tip Mach numbers of 0.6.

A simple presentation of available helicopter rotor hovering data obtained over a broad range of airfoil sections, blade-tip Mach numbers, and pitch angles indicates

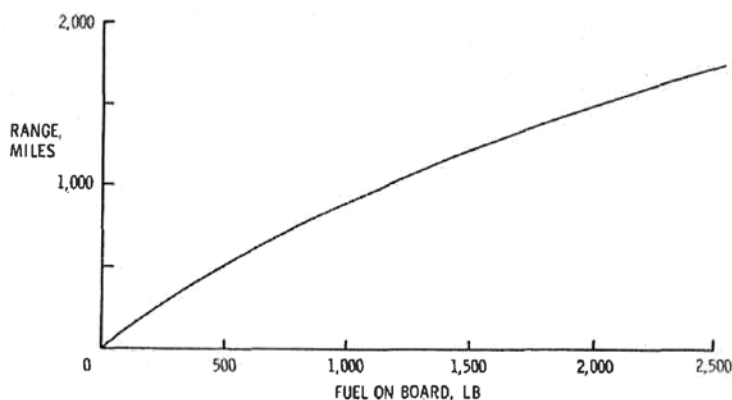

FIGURE 11. Ferry range potential. $L/D = 6$; SFC = 0.75 lb/hp-hr; minimum flying weight = 1,950 lb.

greatly reduced rotor profile-drag power losses due to compressibility effects than predicted by calculations.

Preliminary results of a model study of helicopter parasite drag indicate the importance of using clean, fair, and smooth fuselage shapes if low drag is to be achieved. The use of fuselage cross sections that tend to be narrow and deep is shown to give a lower drag variation with angle of attack and greatly reduced downloads. The importance of cleaning up or completely retracting the landing gear is demonstrated. Equivalent total flat-plate parasite-drag areas of 7.1 square feet, 4.7 square feet, and 3.5 square feet are indicated for a full-scale helicopter (minimum flying weight of the order of 2,000 pounds) equipped with conventional skid gear, a low-drag skid gear, and a retractable gear, respectively. A ferry-range capability of 1,500 miles is estimated.

*Document 5-48 (d), F. B. Gustafson, Robert J. Pegg,
and Henry L. Kelley, Langley Research Center, "Aerodynamic
Observations from Flight Tests of Two VTOL Aircraft," NASA
Conference on V/STOL Aircraft, pp. 149-169.*

INTRODUCTION

The purpose of this paper is to help bridge the gap between pilot experience and wind-tunnel or theoretical results by presenting flight measurements of aerodynamic characteristics for two types of VTOL aircraft. The experience thus represented is interpreted in terms of design philosophy for improvement. The two aircraft to be discussed are the tilt-wing (VZ-2) and tilt-duct (VZ-4) test beds shown in figures 1 and 2. The gross weights and horsepower of these two aircraft are about the same; the tilt-wing configuration uses tail fans for control at low speeds, whereas the tilt-duct configuration uses the exhaust jet. In addition to the data obtained by NASA test pilots, some data have been included which were obtained by the respective company pilots while the programs were being monitored by NASA.

SYMBOLS

V	airspeed, knots
α_f	fuselage angle of attack, deg
i_w	wing incidence referenced to fuselage reference line, deg
δ_d	duct angle, referenced to fuselage reference line, deg
β	angle of sideslip, deg



FIGURE 1.

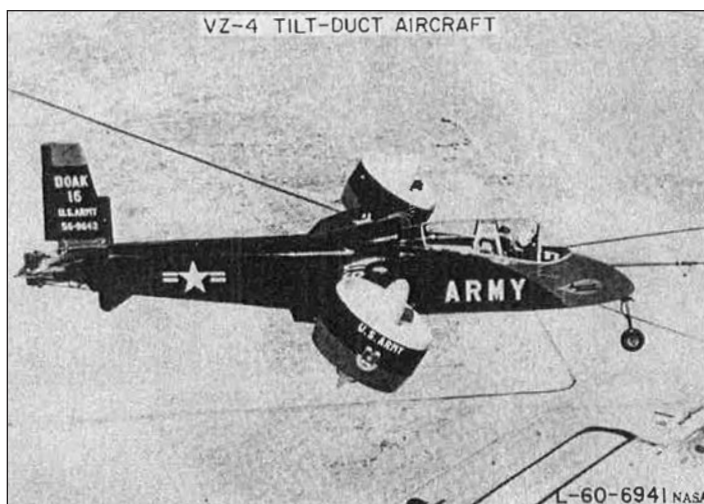

FIGURE 2.

DISCUSSION

Four phases of research are discussed: effects of ground proximity, wing-stall phenomena, aircraft pitching moments, and power-required variations. Additional information is included in the appendix on control moments, static stability, trim changes, and oscillations.

The first point to be observed is that the approach to the ground can cause severe unsteadiness. Figures 3 and 4 show the behavior of the tilt-wing configuration in and out of ground effect, without any artificial stabilization, for a near-hovering

condition. Note that the aircraft and control motions are moderate out of ground effect (fig. 3). For the aircraft in the region of ground effect (fig. 4), note that the aircraft and control motions are many times greater, with erratic angular velocity changes of about 10° per second and with frequent control motions of several inches. As has already been discussed in the paper presented by Robert O. Schade, the presence of the ground causes the slipstream to rebound and hit the tail surfaces, and this is at least a contributing cause to the instability. This problem can be expected to arise in practice for a variety of designs, especially when the aircraft are operated over uneven terrain.

The use of airframe design changes, such as larger tail rotors, to damp these motions would, unfortunately, be expected to increase the erratic moments from the rebounding flow and perhaps even to increase the motions. Therefore, the best recommendation that can be offered now is the use of artificial damping to minimize the piloting problem. This damping was used with considerable success in the test aircraft.

The tilt-duct aircraft has thus far given little evidence of this type of unsteadiness, but there are indications of lateral instability from flow reflected from the ground. Piloting difficulty at certain heights has occurred in roll. Unstable rolling moments equal to about $\frac{1}{3}$ of the available control moment have been indicated by rough measurements. Figure 5 shows a part of the mechanism of this instability. The aircraft was supported from a crane and was operated at fairly high power. Tuft

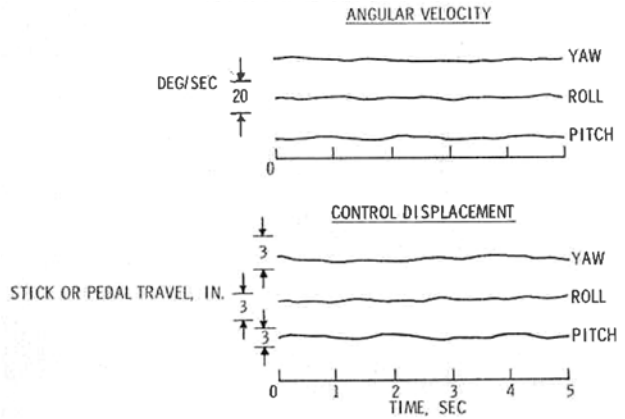

FIGURE 3. Aircraft behavior out of ground-effect region; tiltwing; near hovering.

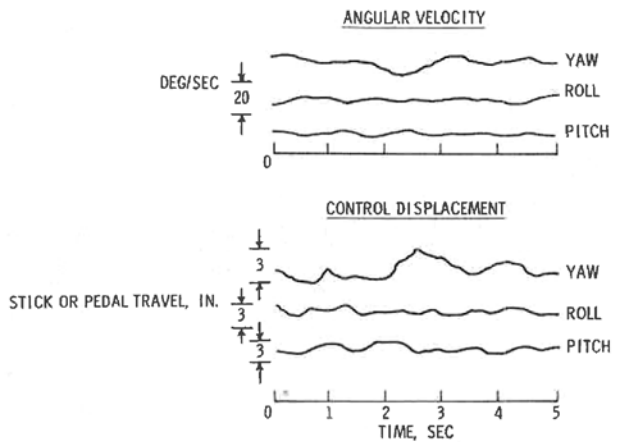

FIGURE 4. Aircraft behavior in ground-effect region; tiltwing; near hovering.

grids were used to determine the flow paths shown. When the aircraft is banked, the upflow shifts to the wing which is already high. Since flow pressures as well as direction have a bearing on this problem, another check on the variation of moment with roll angle was made with most of the wing area removed. Unstable moments were no longer evident.

One step in the solution of such a problem would be the use of high-lift devices as a substitute for part of the wing area. Another step might be a modification to the planform.

The next topic of this discussion is the wing-stall phenomena; these effects have been mentioned in several papers. Figure 6 shows a sample flow pattern for the tilt-wing aircraft. Separation is indicated over a considerable area for this marginally acceptable flight condition. For the more extreme, unacceptable conditions, as shown in figure 7, the flow remained smooth over only a small area (near the tip at the leading edge).

The expedient of leading-edge droop as an approach to cleanup of the flow produced successive improvements in the flow for part-span and full-span coverage. Figures 8 to 10 show the successive shifts in rate of descent boundaries. Figure 8 is for the basic wing. The shaded area marked "poor" represents a region of difficult but feasible flight. The area beneath the solid lines is considered unacceptable; in fact, dangerous. The regions to the right and above are acceptable. Figure 9 shows the results for the outboard leading-edge-droop installation. Note that the peak of the boundary drops from climb at 500 feet per minute to just under level flight. In figure 10 for the full-span leading-edge droop, considerably more improvement is noted, with the peak down an extra

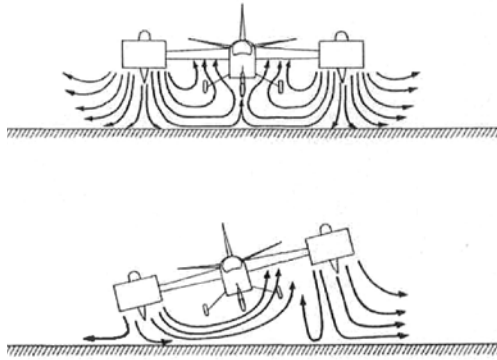

FIGURE 5. Source of destabilizing ground effect.

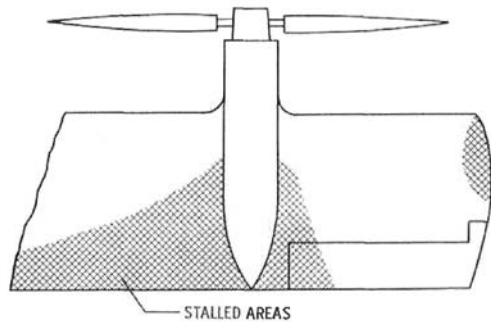

FIGURE 6. Partially stalled wing; 40° wing angle.

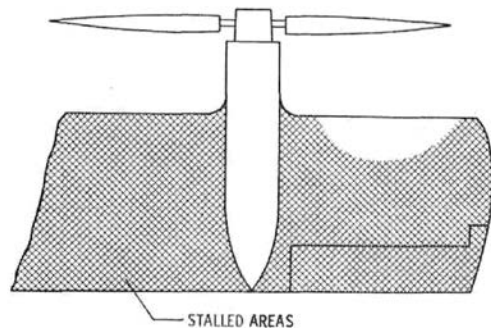

FIGURE 7. Stalled wing; 40° wing angle.

500 feet per minute; it is thus apparent that both inboard and outboard areas are important.

With leading-edge droop, not only were the "unacceptable" boundaries lowered, but flying in the "poor" areas was made far easier. Incidentally, the power required was reduced by an average of about 5 percent over this range of airspeeds with this approach to separation control.

These separation effects can be controlled either by high-lift devices and other approaches to flow control or by increasing wing area. Consideration of overall low-speed flying-qualities effects indicates that high-lift devices or flow control are preferable to a wing-area increase; in fact, wing-area decrease appears attractive if these flow-separation problems can still be handled. For example, two points are covered in more detail in the appendix; the undesirably high value of speed stability and the related short period of the longitudinal oscillations would (at low speeds) be aggravated by adding wing area and would be relieved by reducing it.

Further consideration is now given to leading-edge droop. It is not to be implied from one success with this device that a thorough understanding of this flow-separation problem has been attained. The leading-edge camber, as such, should not have

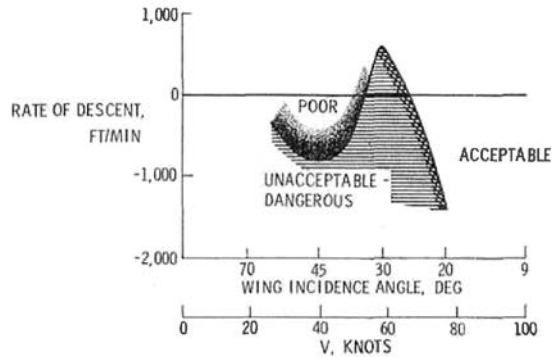

FIGURE 8. Tilt-wing rate of descent limitations; basic wing.

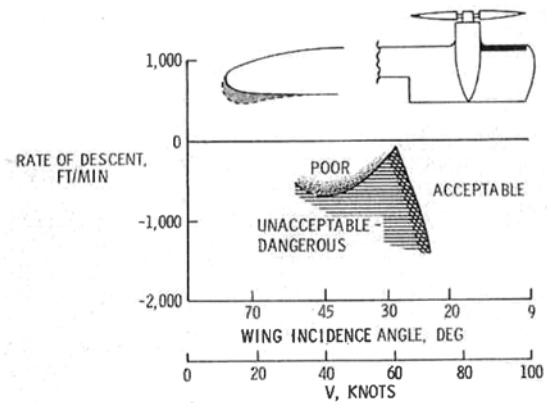

FIGURE 9. Rate-of-descent limitations, outer-panel leading-edge droop.

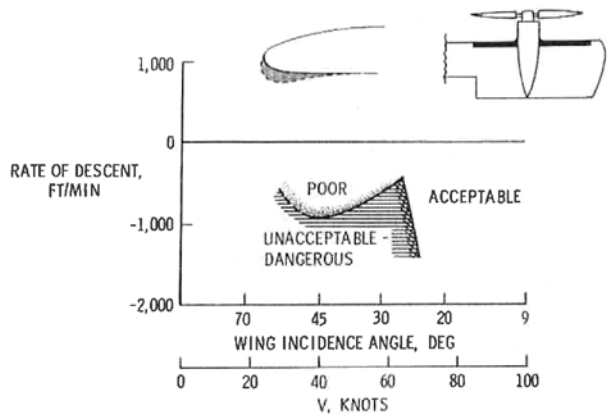

FIGURE 10. Rate-of-descent limitations, full-span leading-edge droop.

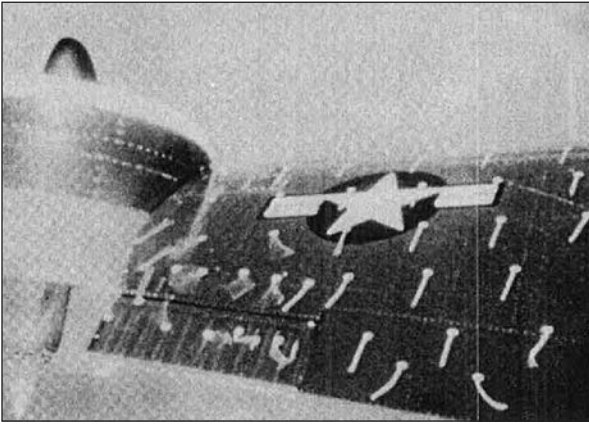

FIGURE 11. Flow separation near duct.

a moderate wing angle of attack, about 7° , and is in keeping with other observations which indicated that the duct produced considerable upflow on the wing. This upflow is believed beneficial to performance, especially if flow separation can be minimized. Some adverse effects of the flow separation on flying qualities were noted, but some of these would be avoided if the aileron action were irreversible. Both the flow separation and the effects on flying qualities increase with increased rate of descent. Rates of descent [of] up to 1,200 feet per minute are usable as is, at approach speeds. To further improve the descent characteristics, and also to avoid rapid roll-off when aircraft stall is encountered, some form of flow-separation control, probably including leading-edge slots or the equivalent over the outer part of the wing, again appears desirable.

The nose-up pitching moments during decelerating flight are next considered. These moments have been a problem with successive types of low-speed aircraft for over 20 years and deserve specific and continued attention from designers. The tilt-wing configuration has shown a reasonable control margin in the recorded data, although pilots' comments indicate a problem in rapid decelerations at low speeds. Power-available limitations have prevented recorded data from being obtained on this point, but study of the control and trim characteristics points up the need for an increase in control moment available as one means of improvement.

For the tilt-duct aircraft, figure 12 shows a pitching-moment problem. These

been nearly so effective as is indicated, and the changed position of the leading edge relative to the propeller axis may have had a material effect on the results.

For the tilt-duct aircraft, this flow-separation problem is of far less concern, but interesting effects do occur for this type also (fig. 11). The duct angle for this test was 50° . This out-board flow separation was observed in level flight at a

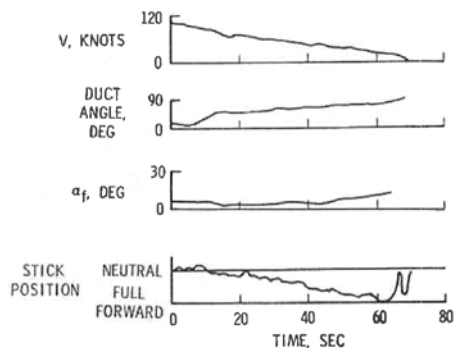

FIGURE 12. Longitudinal control in transition, tilt-duct aircraft.

results are representative of a decelerating transition; the decrease in airspeed in this interval of approximately 1 minute was obtained by an increase in the duct angle as shown. The aircraft angle of attack is seen to increase. The important point is that the longitudinal stick position moves slowly forward and, at low speeds, is essentially full forward, even though the nose was allowed to rise. Records of this type will vary in detail but show, in effect, that pilots have at best roughly no control margin under generally favorable circumstances; whereas, if the aircraft is to be handled in gusts or is to make short landings, a decisive margin of control is needed, as is recommended in the paper by Robert J. Tapscott. For this case, the longitudinal-control power is, in its own right, high enough. It is therefore recommended that the moment be reduced at its source, namely, at the ducts. Both tunnel and flight measurements have shown the ducts to be the source of this moment, and the previous paper by Paul F. Yaggy and Kenneth W. Goodson covers this point in some detail. Since the problem arises in large measure from normal force at the duct lip, one major step appears to be to shift the duct so that the lip is closer to the pivot axis; this axis would remain near the wing quarter-chord line and the aircraft center of gravity. Current tests of this aircraft at Langley involve use of moment-offsetting vanes in the rear portion of the ducts, so linked as to change angle as the ducts are rotated relative to the fuselage. As was shown in the previous paper by Yaggy and Goodson, such vanes can logically be used to handle part of the moments. The use of the vanes as the only device is, however, primarily an expedient to permit more control margin under favorable conditions. Such vanes should not be used in the future as the only device, because they will not relieve the pitch-up moments caused by gusts or by rapid maneuvers. Incidentally, the use of such vanes differentially is recommended as a powerful source of much-needed yaw control.

The final item for consideration is power required, relative to potential gains suggested by effects shown for varying the aircraft attitude at given wing or duct angle. This effect is relatively small, and also less fundamental in origin for the tilt-wing configuration, and therefore results for only the tilt-duct aircraft are presented. Figure 13 includes data that have been presented in the previous paper by John P. Reeder, which indicated the favorable flying-qualities significance of the short, constant-duct-angle curve. The added point to be made from figure 13 is

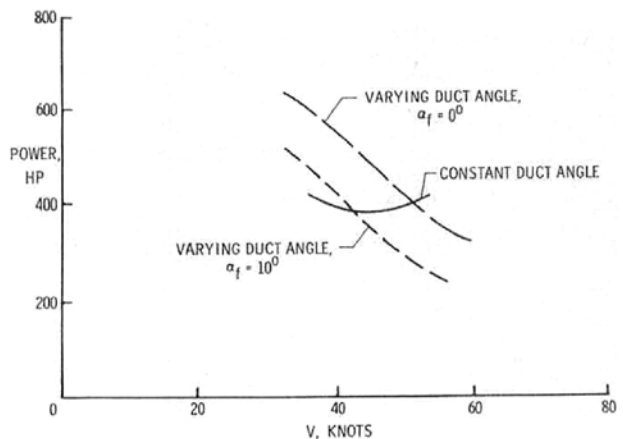

FIGURE 13. Power required.

that there is a large effect of attitude on power required at a given airspeed. The horsepower required is seen to be considerably less for the 10° -attitude curve than for the level-attitude curve ($\alpha_f = 0^\circ$). This power saving is shown not only as cruise flight is approached, where it would certainly be expected, but also at much lower airspeeds. Figure 11 showed separated flow over part of the wing at a moderate angle of attack; performance gains are shown in figure 13 to continue to higher angles of attack before large amounts of separation eventually limit the gains. It follows that use of high-lift devices, including flaps, should materially shorten take-offs and landings for the tilt-duct aircraft, since more load could be transferred to the wing without the aircraft getting too close to the angle for serious stall effects. Any increase in the usable length of the fixed-duct-angle curve obtained by such high-lift devices would also provide more freedom of piloting action in a steady approach at a fixed duct angle.

CONCLUDING REMARKS

Suggestions have been made concerning V/STOL design philosophy for taking greater advantage of favorable power-required effects and for dealing with the problems resulting from ground proximity, from flow-separation effects, and from pitching moments arising in decelerating flight. Perhaps the most general observation to be drawn from this material is the desirability, at this stage of development, of exploiting potential flying-qualities and performance gains by use of high-lift devices or by other ways of getting more lift from less wing area.

APPENDIX MEASURED CHARACTERISTICS OF TILT-WING AND TILT-DUCT CONFIGURATIONS

This appendix presents a number of additional measured characteristics of the VZ-2 and VZ-4 test aircraft. It should be noted that, except where otherwise stated, no automatic stabilization was used when the data presented were obtained.

STABILITY

Speed stability—The speed stability variation of longitudinal-control position with airspeed for each of several fixed wing angle and constant power positions is shown in figure 14 for the tilting aircraft. The steepness of the

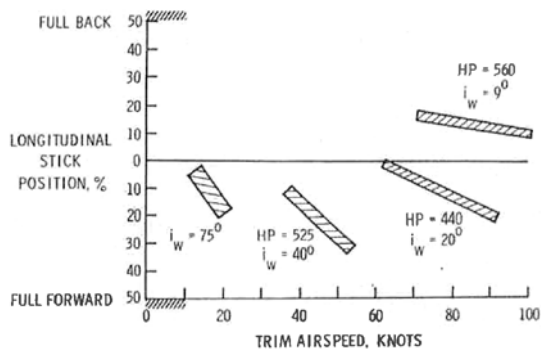

FIGURE 14. Speed stability. Tilt-wing aircraft.

slopes at the low-speed wing settings indicates that large pitching-moment changes will be experienced with inadvertent changes in airspeed; for example, in gusty air and during longitudinal oscillations. Pilots' comments indicated that flatter slopes would result in more favorable flight characteristics.

Longitudinal oscillations—Sample oscillations resulting from deliberate disturbances (longitudinal pulse input) on the tilt-wing aircraft are shown in figure 15. In the hovering configuration ($i_w = 85^\circ$), the response is essentially a simple, rapid divergence, though in a direction opposite to the input. At moderate speeds ($i_w = 40^\circ$), a lightly damped motion of undesirably short period is indicated. At cruise speeds ($i_w = 9^\circ$) the oscillation is well damped, but still of short period. It should be possible to improve the low-speed characteristics by reduction in speed stability (for example, by reduction of wing chord) and by increased damping of the aircraft.

The corresponding variation of the longitudinal oscillation period with airspeed is shown in figure 16.

Angular velocity response to longitudinal pulse inputs for the tilt-duct configuration are presented in figure 17 for duct angles of 7° , 20° , and 50° . In all of these conditions, pilots' comments indicated that the damping was very good, as confirmed by data presented in figure 17.

Static directional stability—The static directional stability characteristics of the tilt-wing aircraft are shown in figure

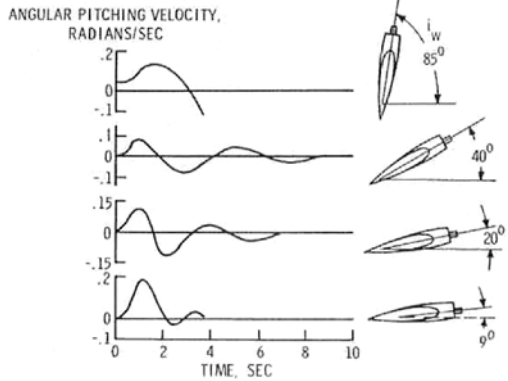

FIGURE 15. Oscillations due to a pulse input. Tilt-wing aircraft.

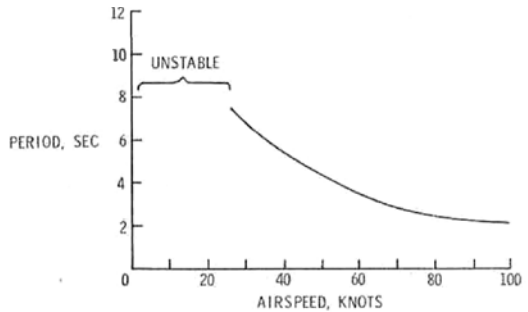

FIGURE 16. Period of longitudinal oscillation. Tilt-wing aircraft; approximately level flight.

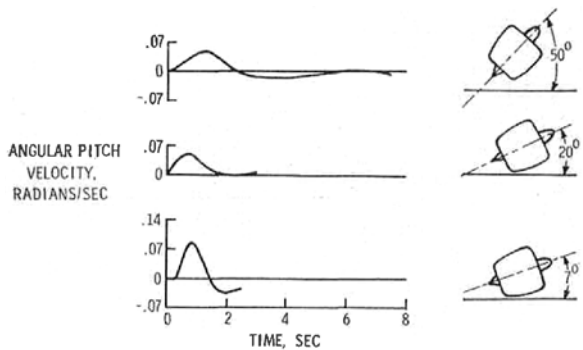

FIGURE 17. Oscillations due to a pulse input. Tilt-duct aircraft.

18. The unstable (center) portion of the curves is believed to be caused, at least in part, by interference of the bifurcated exhaust pipe (and the exhaust flow) with the airflow over the vertical tail. Tuft surveys showed the portion of the tail behind the exhaust flow to be ineffective. Oval (flattened) tail-pipe assemblies have been designed and are expected to reduce this problem.

The static directional characteristics of the tilt-duct configuration are shown in figure 19. According to pilots' opinion, this plot is typical for a range of duct angles of at least 0° to 50° . The curve shows the static directional stability characteristics to be stable; however, at a left sideslip angle of about 8° there is a small region of instability as indicated by the curve.

Dihedral effect—A positive dihedral effect is shown in figure 20 for the tilt-wing test bed. At the high end of the speed range, the tilt-wing aircraft exhibits a strong lateral static stability, whereas at lower speeds this effect is decreased.

A sample curve, showing the dihedral effect characteristics of the tilt-duct configuration, is presented in figure 21. Pilots' comments indicated that the dihedral effect was so strong, for a range of duct angles of at least 0° to 50° in right sideslip, that he ran out of aileron control before rudder control was exhausted.

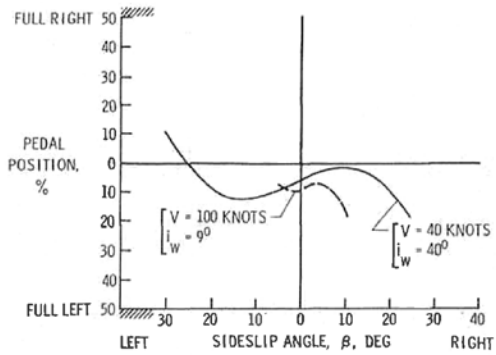

FIGURE 18. Static directional stability. Tilt-wing aircraft.

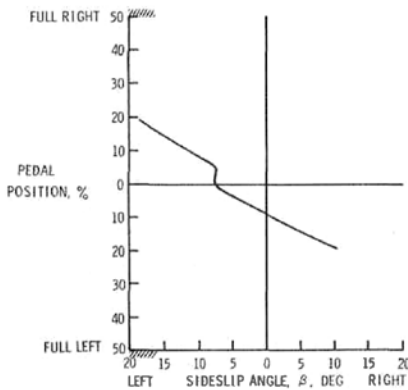

FIGURE 19. Static directional stability. Tilt-duct aircraft; $V = 57$ knots; $\delta_d = 40^\circ$.

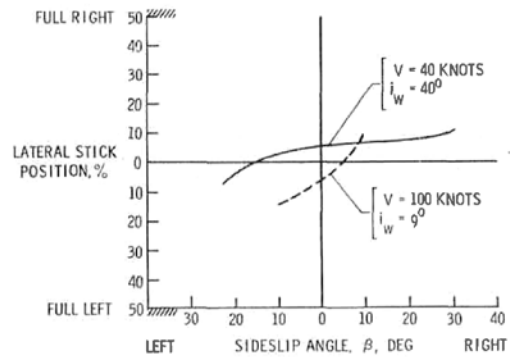

FIGURE 20. Dihedral effect. Tilt-wing aircraft.

CONTROL

Control power—Control moment per inch of stick deflection in the near hovering configuration for the tilt-wing aircraft was considered marginal in yaw, adequate in pitch, and excessive in roll. In the paper by John P. Reeder, values of control power are given for the tilt-wing and tilt-duct aircraft in the hovering configuration.

Angular velocities in roll—Maximum roll velocities encountered in hovering flight on the tilt-wing test bed, according to existing criteria, are greater than is desirable. No reason was found for not reducing materially the control power in roll; an alternate solution, however, which would permit retaining the moment available, would be to use a damper on the control stick. In figure 22, the maximum roll rate per inch of stick motion is plotted as a function of trim airspeed.

Yaw fan thrust—The yaw-fan thrust variation with pedal displacement for the tilt-wing aircraft is shown in figure 23. These nonlinear control characteristics (particularly those near neutral) are objectionable to the pilots in this case, as in past aircraft experience.

TRIM

Longitudinal trim change with airspeed—For fixed fuselage attitude of 0° and also for a fuselage attitude variation up to 10°, figure 24 shows the corresponding longitudinal stick position changes over flight range of the tilt-wing VTOL aircraft. The varying flight attitude is shown to require materially less change in longitudinal stick than the 0° fuselage flight attitude.

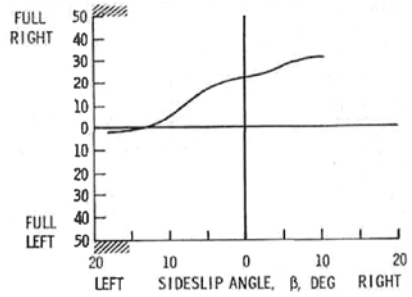

FIGURE 21. Dihedral effect. Tilt-duct aircraft; $\delta_o = 40^\circ$; $V = 57$ knots.

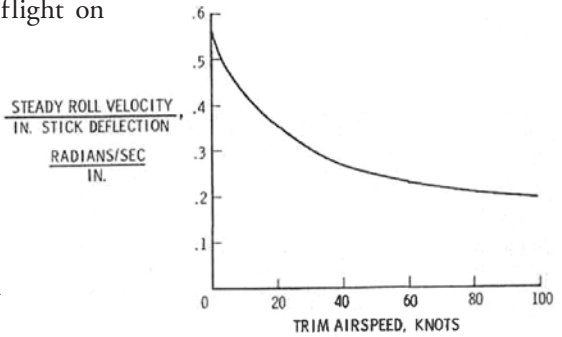

FIGURE 22. Roll velocity per inch of stick deflection for trim. Tilt-wing aircraft.

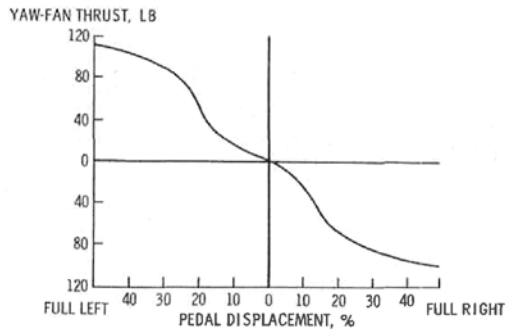

FIGURE 23. Yaw-fan thrust against pedal displacement. Tilt-wing aircraft.

Wing angle of attack as a function of airspeed—Figure 25 gives the variation of wing angle of attack of the tilt-wing aircraft with trim level-flight airspeed. Fuselage attitudes ranged from 0° to ±10°; these variations did not introduce appreciable scatter.

POWER REQUIRED

In figure 26, power required for level flight of the tilt-wing aircraft is given as a function of trim airspeed. The test points spotted below the power curve indicate the power required for the aircraft with full-span drooped leading edges on the wings.

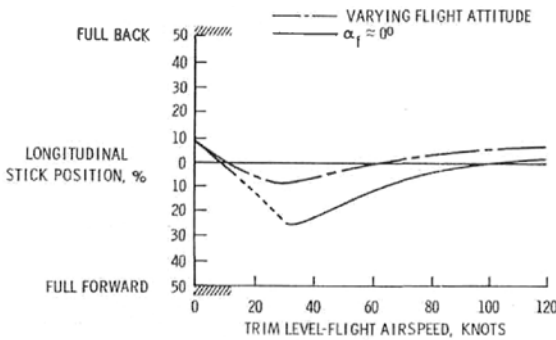

FIGURE 24. Trim change with airspeed.

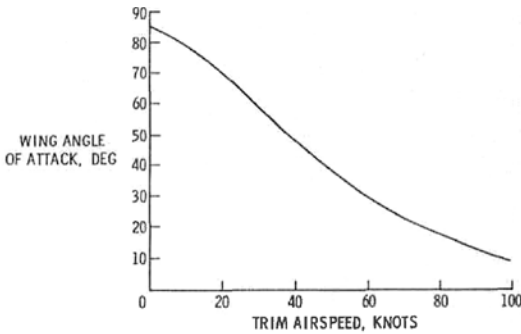

FIGURE 25. Trim velocity variation with wing angle of attack. Tilt-wing aircraft; power for level flight.

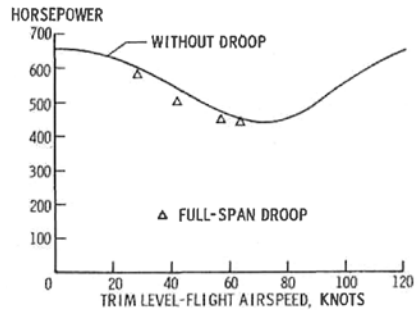

FIGURE 26. Power required. Weight, 3,400 lb.

*Document 5-48 (e), Charles H. Zimmerman, Langley Research Center,
"Summary of V/STOL State of the Art,"
NASA Conference on V/STOL Aircraft, pp. 335-345.*

It is the purpose of this paper to summarize briefly the major points which have been presented in the preceding papers to aid the designer in forming an overall picture of the status of research on V/STOL aircraft and to present some of the needs for future research in this area.

The basic aerodynamic principles which govern aircraft design have been reviewed briefly and the mission capabilities of various V/STOL types have been presented in figures 1 and 2 [*not reproduced*]. It can be seen that the conventional helicopter, which was the only practicable aircraft capable of hovering when power plants were relatively heavy and bulky, remains the most desirable configuration when hovering is a major part of the mission. Because of considerations of rotor-blade stall, rotor-hub drag, and rotor instabilities, helicopters are not well suited to achievement of high speeds or large ranges. However, the power required in cruising can be greatly reduced by careful attention to drag reduction as compared with the power required when drag has been given little or no consideration. This decrease in drag will make possible both the achievement of a reasonably large ferry range for the helicopter and a substantial increase in its productivity in normal missions.

The speed limitation imposed by rotor-blade stall can be alleviated by transferring the propulsion function from the rotor to propellers and using a fixed wing to carry a large percentage of the weight in high-speed flight. The drag of the rotor and tendencies toward rotor instabilities remain serious problems and have caused many engineers to look for more suitable configurations where high speed and long range are the primary considerations and hovering is necessary only for the short time periods required to permit vertical take-offs and landings. Years of research, design, development, and experience have resulted in the conventional high-aspect-ratio, propeller-driven, subsonic airplane configuration as the one most suitable where range, efficiency, and operational flexibility [are] necessary and speeds greater than 400 knots are not required. It has been natural therefore to attempt to add to this configuration the capability of vertical take-off and landing.

Figure 3 [*not reproduced*] shows a family of V/STOL aircraft which represent various approaches to this general solution. In this figure are four wing-propulsion systems which have been proposed. It has been assumed that a given load is to be carried in a given cargo-type fuselage. This fuselage requires substantially the same stabilizing and control means regardless of the wing-propulsion system and will obviously require the same lifting and thrust forces for its sustentation and propulsion. With the exception of the tilt-rotor aircraft, the aircraft shown have roughly the same effective span in cruising flight and the same downwash velocity when hovering if the same gross weight is assumed. The tilt-rotor configuration has a lower effective span and a lower hovering downwash velocity.

Test-bed aircraft representing in a general way each of these concepts have been flown. An aircraft for operational evaluation can be built based on any one of these concepts. This does not mean that sufficient information is available to build the optimum aircraft of any one type or that the answers are known to all the problems that will be encountered. A great deal of research and development will be required before a completely satisfactory service aircraft of any of these types can be built.

The main problem now is to decide where research should be concentrated in order to proceed most efficiently and rapidly toward the final service aircraft. Unfortunately, a rational answer to this question can come only from operational experience which will provide answers to such questions as:

1. How much downwash velocity can be tolerated?
2. How much emphasis should be placed on speed?
3. How important is good hovering capability?
4. What is the acceptable pilot work load?

Operational experience will not, however, give all the answers. All of these machines have deficiencies which must be eliminated by careful design and development or at least reduced to tolerable levels. As pointed out in previous papers these machines all have, to a greater or lesser degree, special problems inherent in placing the fuselage in the upwash generated by pairs of lifting jets operating about a plane of symmetry. They all are subject, to a greater or lesser extent, to unpleasantness associated with wing stalling at some point in their flight envelopes. They each present a problem in connection with the requirement for adequate center-of-gravity travel. And, finally, they each present a problem of compromise between design requirements for static lift and high-speed propulsion.

As shown by figure 1, the requirement for high speed strongly indicates the use of a jet propulsion system. Here the problem is one of finding a configuration suited to jet propulsion at high subsonic or supersonic speeds with a jet lifting system compatible with those high-speed requirements. Some of the aerodynamic problems associated with jet and fan lift arrangements have been presented. The major problems are thrust loss near the ground, pitching moments in transition, and high jet velocities.

These problems are not considered unsolvable except for the basic problem of high lifting jet velocities which will preclude use of such aircraft over many types of unprepared soils. It is expected that research directed toward solution of these problems will continue but it is believed that the future of jet V/STOL aircraft hinges largely on the availability of jet engines, or engine combinations, which can meet the requirement for extremely low weight and for both low drag and low specific fuel consumption at high speed.

The preceding discussion has concerned aerodynamics and, to a certain extent, propulsion problems; however, flying and handling qualities must also be considered. As pointed out and discussed previously, experience with conventional helicopters and airplanes plus that gained from the various test-bed vehicles and

from studies with variable-stability helicopters and simulators has made possible specification of handling-qualities requirements which will be entirely adequate for V/STOL aircraft suitable for operational evaluation. On the other hand, sufficient information is not available to permit specification of detailed requirements for a service V/STOL aircraft and such specification should not be attempted until operational experience has been gained with suitable aircraft of this type.

It is relatively easy to specify the handling qualities desired in an aircraft; it is much harder to define the degree of departure from perfection that can be tolerated; and it is still harder, in general, to build an aircraft which fully complies with these requirements. The handling qualities of various test-bed aircraft, the reasons for their deficiencies, and, in most cases, the corrective measures which can be taken have been discussed. It should be clearly borne in mind that the test beds are undeveloped aircraft with novel features, and actually the surprising fact is not that they have deficiencies but rather that they fly as well as they do. No attempt will be made to review the deficiencies and their remedies but rather to point out general areas for attention. These problem areas are as follows:

1. Ground interference effects
2. Stalling or flow separation
3. Control power and damping
4. Pilot work load

In regard to the behavior near the ground, it is very clear that careful attention must be paid to fuselage shape, wing placement, control-surface or control-rotor location, and to the possible use of auxiliary shielding surfaces to minimize undesirable effects and maximize desirable characteristics. A program is underway which should provide better understanding of these phenomena but it is strongly indicated that model tests representing hovering near the ground will, in a development program for this type of aircraft, be as essential as conventional wind-tunnel tests.

It has been indicated that the stalling of lifting surfaces can be avoided or reduced to acceptable levels in certain cases but there is still a great deal to be done in the investigation of wing-rotor, wing-propeller, and wing-fan combinations in order that optimum configurations may be evolved. The National Aeronautics and Space Administration expects to continue to prosecute vigorously research in this area.

The provision of adequate control power and damping is largely an engineering problem. In this area efforts will be directed toward evolution of configurations which minimize those undesirable moment characteristics which impose unnecessary loads on the control system and toward the determination, through experience with variable-stability aircraft, simulators, existing test beds, and future experimental and service aircraft, of realistic control and damping requirements.

There is also the very real problem of pilot work load due to the necessity for changing the configuration during transition. Research, design, and development effort should be devoted to minimization of this problem by increasing the ranges

of speed and power through which the aircraft can be safely operated without a configuration change. It is probable that automatic programming equipment can be used to alleviate the pilot's load in most instances but the designer must be fully aware of and respect the limitations inherent in his aircraft which automatic equipment cannot overcome. Also, it is true that, in general, automatic equipment increases costs and introduces maintenance and reliability problems, all of which are generally agreed to be undesirable.

In the area of loads and structures several papers have indicated that cyclic loadings present a major problem for the designer of V/STOL aircraft. This problem is one which requires better understanding and means of estimating the extent of the cyclic loadings so that the designer can minimize these loadings as much as possible in his design approach and can design rationally for the greatest structural efficiency to bear those loads which cannot be avoided. Some of the available information was presented. Efforts are being continued in this area, aided to a very important extent by support from the armed services. Better analytical methods for estimation of dynamic loads have become available which also assist in making possible efficient rational design. However, it seems evident that despite all efforts to avoid or minimize them the cyclic loadings will continue to be a very important factor in the design of V/STOL aircraft and the problem of getting the greatest efficiency of design from a fatigue standpoint has been discussed.

V/STOL aircraft will bring with them serious operational problems, many of which have been encountered with helicopters. The problem of steep descents in connection with all-weather operation has been discussed and the very important point made that all-weather operation with any type of V/STOL aircraft will not be feasible until means can be developed to provide the pilot with reliable and adequate cues to enable him to find and maintain the proper position and orientation for landing at a selected spot while being plagued by wind shears and shifts and turbulence.

There are very serious problems associated with the operation of V/STOL aircraft from unprepared sites, a necessary requirement if certain military missions are to be accomplished with the desired high degree of mobility and flexibility. The maximum disk loading of the supporting rotors or propellers will almost certainly be dictated by the amount of dynamic pressure which can be tolerated without excessive troubles due to erosion of the types of terrain over which such operations must be conducted as indicated in figure 4 [*not reproduced*]. This may well dictate the type of aircraft required, and can be determined only by realistic field experience with suitable aircraft. Both the NASA and the armed services are continuing investigations in this area to extend to larger scale the small-scale results presented in figure 6. Another major problem in this area, that of the effect of the hurricane velocities in the vicinity[,] is a function of aircraft weight, as shown by figures 5 and 6 [*not reproduced*], and is actually worse in some respects for machines supported by lightly loaded rotors. In this area it is undoubtedly true that operational practices

will have to be adapted to the velocities created in the vicinity of heavy V/STOL aircraft of any type.

The noise of airplanes and helicopters is one of the very objectionable features of their operation both in civilian and military service. The noise associated with the high powers necessary for large V/STOL aircraft can be alleviated somewhat by careful design and by engineering compromises but will remain a serious problem which will have to be taken into account in operational procedures, some of which have been discussed. Intensive research may indicate methods of reducing the noise output of high-powered turbine engines and lifting rotors but it is unlikely that any completely effective solution will be found in this area.

The most important problem in connection with the development of practical V/STOL aircraft which can support themselves financially in the civilian field and on the basis of usefulness in the military field is indicated in tables I and II. These tables show that, with the exception of the conventional helicopter which uses the same rotor for support in both hovering and forward flight and can hover with a relatively high power loading, all V/STOL aircraft suffer from the fact that the useful load which can be carried in vertical take-offs is a relatively small percentage of the gross weight. These tables also indicate the areas in which the weight penalties of V/STOL exist and hence the areas in which research, design, and development effort will provide the greatest returns in increasing the productivity of the aircraft. The weight of propulsion and lifting systems for all these aircraft, including the helicopter, is a very large item compared with that for the conventional airplane and is tied up in items such as propellers, rotors, and power transmission systems, the stress levels of which are dictated by fatigue considerations. Basic research in metallurgy tending to raise allowable fatigue stress levels in metals otherwise suitable for these components could result in substantially increased productivity of V/STOL aircraft of all types. The high installed power and refined mechanical components necessary in V/STOL aircraft make these aircraft relatively expensive. Research, design, development, and manufacturing techniques which will reduce the cost in money and manpower of producing and maintaining these items is urgently needed and will pay off to a far greater extent than would be true for the conventional airplane.

Tables I and II [*not reproduced*] are based on weight breakdowns of existing aircraft and on manufacturer's estimates for the unconventional types. They are shown only to illustrate general points and are not suitable for close comparisons of competing types.

Conclusions which may be drawn in regard to the V/STOL state of the art are as follows:

1. With the information now available it is possible to build V/STOL aircraft suitable for operational testing and evaluation and, probably with some modification, useful as service aircraft.

2. A great deal of intensive research is still required to permit the construction of optimum V/STOL aircraft having the greatest utility and productivity.
3. In order that research may be properly guided and expended most productively toward the ultimate goal of practical, useful service aircraft, the type of information needed is that which can be obtained only from operational experience with V/STOL aircraft incorporating those features which on the basis of present knowledge and engineering judgment most nearly approach those which will finally be found most satisfactory.
4. There is no reason to expect a breakthrough which will materially alter this situation. Design and construction should proceed now of the best aircraft which the state of the art can produce.

Documents 5-49 (a–d)

Selections from Martin D. Maisel, Demo J. Giulianetti, and Daniel C. Dugan, *The History of the XV-15 Tilt Rotor Research Aircraft: From Concept to Flight*, Monographs in Aerospace History, no. 17 (Washington, DC: NASA, 2000).

(a) “XV-3 Program,” pp. 12–19.

(b) “Building the Technology Base,” pp. 20–27.

(c) “Flight Research,” pp. 65–82.

(d) “Epilogue,” pp. 105–114.

What would become a long history of V/STOL R&D at Ames Research Center (located outside San Francisco) began in the summer of 1957 when a team of researchers at what was then still NACA Ames became involved in the Bell XV-3 tilt-rotor program. Between July 1957 and October 1958, Ames not only helped to flight-test the experimental tilt-rotor but also put its full-scale performance behavior through exhaustive tests in the lab’s mammoth 40- by 60-foot wind tunnel. Results indicated the need for several improvements, which, once they were made, enabled the XV-3 to accomplish “the elusive goal of completing a dynamically stable full conversion to the airplane mode” (Maisel et al., p. 114). Ames personnel remained active with the XV-3 program into the late 1960s, when Bell ended the program after clearly demonstrating the feasibility of the tilt-rotor concept, though with limited hover capability and cruise performance by the XV-3 itself.

The following four selections provide insights into the history of NASA’s tilt-rotor research from the XV-3 program of the late 1950s, through the XV-15 of the 1970s, to the design of the V-22 Osprey in the 1980s from three NASA engineers who participated actively in the research programs. Martin Maisel (B.S. in aeronautical engineering, 1960, Polytechnic Institute of Brooklyn) became a member of the NASA-Army project that developed the XV-15 tilt-rotor research aircraft in 1970, after working for 10 years on propeller and rotor aerodynamic design and technology development at the Hamilton Standard Division of United Technologies Corporation, Windsor Locks, Connecticut, and at the Boeing Helicopter Company, Riddley Park, Pennsylvania. Demo Giulianetti (B.S. in general engineering, 1956, San Jose State University) joined NASA Ames’s Tilt Rotor Research Aircraft Project Office in 1975, where he participated in the development of two XV-15 aircraft. After he began working at Ames in 1956, early on he took a

special interest in the possibility of V/STOL configurations. Daniel Dugan (West Point graduate, 1955) flew for 14 years as one of the main test pilots for the XV-15, accumulating 200 hours in the aircraft. He went on, from 1990 to 1995, to pilot the V-22 as part of NASA's test team. This work came after his already distinguished service as an experimental test pilot for the Army and the Navy and a term of combat service in Vietnam.

Document 5-49 (a), Selections from Martin D. Maisel, Demo J. Giulianetti, and Daniel C. Dugan, The History of the XV-15 Tilt Rotor Research Aircraft: From Concept to Flight, Monographs in Aerospace History, no. 17 (Washington, DC: NASA, 2000), "XV-3 Program," pp. 12-19.

Long before Transcendental initiated flight tests of the Model 1-G, Bob Lichten had joined Bell Aircraft where he was given the opportunity to further the advancement of the tilt rotor with the research and development resources of a major rotorcraft company. At Bell, Lichten began the task of developing a new technology base associated with the tilt rotor aircraft. In 1951, in response to the Convertible Aircraft Program Request For Proposal (RFP) for the design of a "convertiplane," the Bell proposal offered Lichten's tilt rotor, the Bell Model 200. With the subsequent award of a contract for two full-scale "tilting-thrust-vector convertiplanes" in October 1953, and the infusion of Army and Air Force funds, the exploration of this new technology was accelerated. The Bell Model 200, designated the XV-3 by the Army and Air Force, produced some interesting technical challenges for Lichten and his team during the next thirteen years. Figure 17 [*not reproduced*] shows Bob Lichten, the principal advocate of the tilt rotor concept, standing in front of his creation, the XV-3.

INSTABILITY

Following an extensive series of ground tests by Bell, the initial hover trial of the XV-3 was flown on August 11, 1955 (figure 18) [*not reproduced*]. After noting satisfactory characteristics during the beginning of the flight, Bell test pilot Floyd Carlson experienced a high vibration in hover. During a subsequent flight on August 18, 1955, a reappearance of the rotor dynamic instability problem resulted in a hard landing that caused minor airframe damage. A thorough ground investigation was conducted to understand and resolve the cause of the dynamic instability. Flight testing resumed on March 29, 1956, but on July 25 the instability occurred again, causing Bell to conduct another series of ground tiedown tests which lasted until late September of that year.

It is important to note that the ability of the rotorcraft dynamicists of that period to analyze complex systems (such as the rotor/pylon/wing of the tilt rotor) was quite primitive compared to the computational capabilities of the 1990s. The

attempts to correct the instability that occurred on the XV-3 had to be done by combining the available analytical methods with experimental data. Therefore, ground tiedown tests were needed to expand the database documenting the fundamental characteristics of the tilt rotor as well as to evaluate configuration changes.

Following the second ground test effort, flight testing continued with the goal of expanding the speed and conversion envelope of the XV-3. On October 25, 1956, as Bell test pilot Dick Stansbury moved the rotor shaft 17 degrees forward from the vertical, a severe rotor instability occurred that resulted in extremely high cockpit vibrations and caused the pilot to black out. The subsequent loss of control caused the number 1 XV-3 (aircraft tail number 4147) to crash, seriously injuring the pilot (figure 19) [*not reproduced*].

The XV-3 program faced a crisis. The inability to solve the instability using traditional analyses, experimentation, and trial-and-error empirical methods made even some of the tilt rotor's most avid supporters question the readiness of this technology. But the believers held on. A satisfactory solution to the rotor/pylon/wing dynamic instability problem had to be found. Advocates of the tilt rotor at Bell and the Government decided to continue the work and authorized the initiation of a major design change as well as plans for testing the XV-3 in the NACA Ames Aeronautical Laboratory 40- by 80-foot wind tunnel. The original three-bladed, 25-ft diameter articulated rotor was replaced with a two-bladed stiff-inplane rotor. By July 18, 1957, with isolated two-bladed rotor static tests and rotors-installed XV-3 tiedown tests completed (figure 20) [*not reproduced*], investigations of the performance and dynamic behavior of the modified XV-3 began.

In the following 18 months, the XV-3 (tail number 4148) with its new rotor system underwent two wind tunnel entries in the 40- by 80-foot wind tunnel (September–October 1957 and October 1958) and an additional series of ground tiedown and flight tests. During this period further changes were made to improve stability, including the reduction of the rotor diameter to 23 feet, the addition of external struts to stiffen the wing, and a significant increase in the stiffness of the rotor controls. The configuration that emerged accomplished the elusive goal of completing a dynamically stable full conversion to the airplane mode. This occurred at Bell on December 18, 1958, with test pilot Bill Quinlan at the controls. Subsequent flights explored the effect of wing stiffness (by modifying the strut attachments) and expanded the flight envelope within the fairly narrow range of the XV-3's performance capabilities.

GOVERNMENT FLIGHT TESTS

The XV-3 was transported to Edwards Air Force Base where, from May through July 1959, Air Force Major Robert Ferry conducted a Government flight evaluation. The tests included handling qualities assessments, Short Takeoff and Landing (STOL) operations, and autorotation demonstrations. The Air Force test

report, authored by Project Engineer Lt. Wallace H. (Wally) Deckert, USAF, and Major Ferry, noted numerous deficiencies in the performance and flying qualities of the aircraft. However, in spite of the deficiencies, the report concluded that “the fixed-wing prop-rotor (i.e. the tilt rotor) principle is feasible and should be given serious consideration in future Vertical or Short Takeoff and Landing (V/STOL) aircraft design competition.” “The XV-3 demonstrated that the fixed-wing prop-rotor concept is operationally practical with safety and complexity comparable to helicopters.”

After the conclusion of the flight program at Edwards AFB, the XV-3 was transported to NASA ARC onboard an Air Force C-130, where flight testing continued until July 1962 (figure 21) [*not reproduced*]. The first full tilt rotor conversion at Ames was performed by test pilot Fred Drinkwater on August 12, 1959 (figure 22) [*not reproduced*]. This flight program was followed by an additional entry in the Ames 40- by 80-foot wind tunnel (in June–July 1962, figure 23) [*not reproduced*] to investigate the effects of changes to the pitch-flap coupling on rotor flapping and high-speed airplane mode stability.

Pitch-flap coupling refers to a feature provided by the hub design wherein the blade pitch angle is changed in a manner that alters the amount of out-of-plane flapping motion that occurs.

A standard stabilizing pitch-flap coupling, referred to as *d*, reduces the flapping displacement by reducing the pitch angle as flapping increases. After another modification (this time to increase the pylon/wing stiffness) the XV-3 was able to reach a speed of 155 knots before indications of low damping, i.e. aeroelastic instability, were seen. While this was a definite improvement over the earlier stability limits of the XV-3, it would still be inadequate for the intended military mission application of the tilt rotor aircraft and was substantially below the predicted performance capability of this aircraft type.

STABILITY VALIDATION

In 1965, after a period of model-scale testing and analytical studies, Bell funded a ground test to continue its investigation of XV-3 tilt rotor dynamics. To further pursue this work in a full-scale wind tunnel test, Robert (Bob) Lynn, Bell’s Chief of Research and Development (who later was Bell’s Senior Vice President, Research and Engineering), obtained support from C. W. (Bill) Harper, Chief of the Aeronautics Division in the Office of Advanced Research and Technology (OART) at NASA Headquarters, for another entry in the Ames 40- by 80-foot wind tunnel. This test involved configuration variations that were predicted to alter the rotor/pylon/wing aeroelastic stability. The test results were compared with the pre-test predictions to determine if the evolving analytical methodology adequately represented the aircraft’s structural dynamics. Without a speed capability well in excess of the helicopter’s maximum speed, the tilt rotor aircraft did not fulfill the

performance requirements of the VTOL mission. Lacking a valid structural stability prediction method, the design of a new tilt rotor aircraft was considered to have a high level of uncertainty and therefore an unacceptable high-risk undertaking.

The planned test could have exposed the XV-3 aircraft, as well as the 40- by 80-foot wind tunnel, to possible damage due to the potential for an explosively rapid failure caused by instability. Could Ames accept this unusual risk? Showing great confidence in the technical approach, the decision to accept the test was made by Mark Kelly, NASA's Chief of the Large Scale Aerodynamics Branch, and Woodrow L. (Woody) Cook, Chief of the Advanced Aircraft Programs Office.

The Bell test team was led by Kipling (Kip) Edenborough, who served as test director, and included Claude Leibensberger, Flight Test Engineer for the XV-3 project. The test, which ran from October to November 1968, proceeded remarkably well for all of the planned test conditions. The level of damping (i.e. stability) was assessed by disturbing the pylon and measuring the resulting vibrations. Decaying vibration amplitudes indicated a stable structure, constant amplitude vibrations indicated neutral stability, and growing amplitudes revealed a dangerous unstable condition. Test results showed that configurations predicted to be stable were in fact stable, and those predicted to be unstable showed signs of decreasing stability as the stability limit speed was approached. With the aircraft in its most stable condition, a run at maximum wind tunnel speed, recognized as a high risk condition, completed the test activity. When the wind tunnel was taken to its maximum airspeed capability (of nearly 200 knots), the vibratory loads data once again verified the predicted stability.

DISASTER STRIKES

Suddenly both pylons separated from the wing and were blown down the tunnel. The XV-3 was extensively damaged in what appeared to be the result of the inability to design an aeroelastically stable tilt rotor aircraft. However, after months of careful examination of the damaged structure and analyses of the incident, the test data revealed this was not the case. The failure was traced to a fatigue crack and rivets working loose in the left wingtip spar. The progressing crack and loose rivets reduced the stiffness of the pylon attachment to the level where a resonance occurred, producing the high oscillatory loads that led to the subsequent massive structural failure. The right rotor, exposed to extremely high overloads as the aircraft was being shaken during the initial failure, failed under a whirl divergence condition. In the final analysis, the wind tunnel investigation successfully accomplished its goals, but this wind tunnel entry would be the final research activity conducted with the XV-3 experimental aircraft.

XV-3 LEGACY

At first look, an assessment of the results of 13 years of flight, ground, and wind tunnel investigations with the XV-3 did not present a favorable prospect for the future of the tilt rotor aircraft. The severely underpowered XV-3 had limited hover capability and cruise performance. The maximum level flight speed of 115 knots (155 knots in a dive) was not adequate to prove that the tilt rotor had a useful airplane mode capability. However, it was fortunate that the airplane-mode speed was so restricted since the aircraft would likely have been destroyed in flight, due to the rotor/pylon/wing aeroelastic instability. The XV-3 also suffered from handling qualities problems, including lateral and roll instabilities when hovering in ground effect (IGE), and a directional divergent oscillation and poor control responses in the longitudinal and directional axes at low airspeeds. In addition, a complex gear shifting process, required to reduce rotor RPM after converting to the airplane mode (to improve rotor efficiency), produced an unacceptably high pilot workload.

On the positive side, the significant achievement of the XV-3 project was clearly the demonstration of the ability of the tilt rotor aircraft to perform in-flight conversion from the helicopter configuration to the fixed-wing (airplane) configuration and back to the helicopter mode in a safe, stable, controllable manner. This was accomplished with sufficient airspeed margins and maneuverability and adequate tolerance to gusts and turbulence throughout the process. A total of 110 full conversions were performed during the 125 flight hours logged by the 10 XV-3 test pilots (three Bell, three Army, two Air Force and two NASA). The proven conversion capability, coupled with the predicted but unproven performance potential in the hover and cruise flight regimes, provided the basis for continued interest in the tilt rotor concept in the military and within the NASA Langley and Ames Research Centers that were focusing on the search for new VTOL vehicle technologies. A description of the XV-3 is provided in Appendix A [*not reproduced*].

Encouraged by the outcome of the flight and wind tunnel test of the XV-3, Bell management continued to show interest in pursuing the development of tilt rotor technology. In 1966, to ensure they could legally proceed with the work, Bell paid Haviland Platt for the rights to the convertible (tilt rotor) aircraft described in his patent.

*Document 5-49 (b), Selections from Martin D. Maisel,
Demo J. Giulianetti, and Daniel C. Dugan,
The History of the XV-15 Tilt Rotor Research Aircraft:
From Concept to Flight, Monographs in Aerospace History, no. 17
(Washington, DC: NASA, 2000), "Building the Technology Base," pp. 20–27.*

AEROELASTIC STABILITY

One of the principal areas of interest was the structural instability that plagued the XV-3 when operating in the airplane flight mode. Although this condition was found to occur on aircraft with wing-mounted propellers, such as the Lockheed Electra, a complete understanding of the phenomenon and a validated analysis capable of assessing the tilt rotor configuration did not exist in the late 1960s. Therefore, the rotor/pylon/wing aeroelastic instability subsequently became the focus of analytical and experimental work initially at the NASA Langley Research Center and then at NASA Ames.

A basic understanding of the physical phenomenon that causes the airplane mode aeroelastic instability problem was developed by Earl Hall of the Bell Helicopter Company in 1966. By 1968, this insight was applied by Troy Gaffey, a Bell dynamicist *[sic]* (and later, Bell's vice president for engineering) who developed an effective solution to provide the required high-speed airplane-mode rotor/pylon/wing stability for the tiltrotor aircraft. His solution involved the use of a hinged, or "gimballed," rotor hub design with a pitch change mechanism that increased blade flapping when out-of-plane motion occurred. This pitch-flap coupling, called $-\delta_3$, combined with a high wing stiffness and a reduced rotor-hub to wing torsional axis distance, was predicted to provide stability up to and beyond the desired airspeeds. Small-scale wind tunnel test data cited in Gaffey's paper demonstrated that satisfactory high-speed aeroelastic stability was achievable.

Meanwhile, the Boeing Vertol Company of Morton, Pennsylvania, was also actively pursuing the development of VTOL aircraft technology. In 1956, they built a tilt wing research aircraft, the Vertol Model 76, later designated the VZ-2 (figure 24) *[not reproduced]*. Although the major focus at Vertol throughout the 1960s remained on the higher disc loading tilt wing vehicle, evaluations of variants included lower disc loading tilt wing aircraft, and the low disc loading tilt rotor for certain applications.

By 1967, preliminary designs for transport-size tilt rotor aircraft had been developed (Vertol had been producing at that time the heavy payload CH-46 and the CH-47 helicopters) and a concentrated effort at Vertol to develop and validate methodology for all relevant VTOL technologies had begun. The leading advocates for this work were Kenneth B. (Pip) Gilmore, V/STOL Technology Manager, and David (Dave) Richardson, Chief of Preliminary Design. To support these efforts, during the mid-1960s, Boeing Vertol recruited engineers with technical expertise

in the key areas and toward the end of the decade had established a fully staffed Research and Development organization devoted to the development of VTOL aircraft technology. Appendix B presents the key technical personnel involved in these activities at Boeing Vertol during the late 1960s and the early 1970s.

The Boeing Vertol Company's technical approach to tilt rotor aeroelastic stability employed a hingeless rotor hub (i.e. with no blade flapping or lead-lag hinges and no rotor-flapping gimbal) and structurally tailored blades. With the appropriate wing stiffness, $-\delta_3$, and the short-coupled hub/wing distance, wind tunnel tests would later show that this design approach allowed high speed airplane mode flight free of aeroelastic instability. While Boeing's rotor would contain fewer parts and would provide higher helicopter mode pitch and yaw control moments than the gimballed rotor approach resulting in increased aircraft control responses, it produced higher blade, hub, and main transmission-component loads which could impose weight or life penalties on these structures.

Nevertheless, both the Bell and Boeing technical approaches offered some desirable attributes and Government-funded analytical and experimental investigations were continued to compliment [*sic*] work being done by both companies.

Meanwhile, during the early 1970's, Dr. Wayne Johnson at Ames developed a comprehensive code that would evolve into the accepted standard for rotor dynamics and stability analysis. This code would prove to be an important tool used by Ames and industry engineers to predict the aeroelastic stability margins of safety in later wind tunnel and flight test programs. In the same timeframe, a number of small-scale wind tunnel tests were conducted (largely by LaRC and industry) to produce the empirical databases for validating the analyses being developed. However, the small-scale model tests did not accurately represent the full-scale aircraft with respect to both the structural and the aerodynamic characteristics. Since the small-scale effects of these factors required analytical corrections to represent full-scale hardware, a large model test was deemed necessary. Therefore, in 1969 a contract was awarded to the Bell Helicopter Company for the Ames 40- by 80-foot wind tunnel tests of Bell's 25-foot diameter proprotor, figure 25 [*not reproduced*]. This test was jointly sponsored by NASA, the Army, and the Air Force. While wind tunnel speed limitations prevented operation at the actual design maximum airspeed of the tilt rotor aircraft, the high speed operating condition was simulated by running the 25-foot diameter Bell Model 300 rotor at reduced rotational speeds. The test results confirmed the predicted stability margins and trends within the required accuracy level, and provided the needed confidence in the ability to adequately predict these critical tilt rotor aircraft characteristics.

The Boeing technical approach was also evaluated for dynamic stability in the Ames 40- by 80-foot wind tunnel. In August 1972, under Army funding, Boeing conducted dynamics tests of its 26-foot diameter proprotor with the hingeless, soft-in-plane hub on the same semispan wing and rotor nacelle used for the Bell full-scale

aeroelastic stability test (figure 26) [*not reproduced*]. Performance tests of that prop-rotor in the 40- by 80-foot wind tunnel were completed in December 1972.

PERFORMANCE AND CONTROL

In a related effort, a folding version of the Bell 25-foot diameter rotor (figure 27) [*not reproduced*] was tested in the Ames 40- by 80-foot wind tunnel in February 1972. The stop/fold tilt rotor eliminated the rotor/pylon/wing aeroelastic instability by stopping the rotor while in the airplane configuration. The aerodynamic drag of the stopped rotor blades was then reduced by folding them back along the nacelle while a convertible engine was used to produce the jet thrust required for airplane-mode flight up to higher speeds than would be attainable with a rotor as the thrust-producer. This test, also conducted with Bell Helicopter as the hardware and technical support contractor (jointly funded by the NASA, the Army, and the Air Force), demonstrated the feasibility of the airplane-mode rotor stopping and blade folding, and of the blade deployment and spin-up process. The stop/fold tilt rotor, however, had the additional penalties of the increased complexity and increased weight of the stop/fold mechanism, and, with the lack of a developed convertible engine, it was put aside as a potentially feasible concept that would require further advancements to be an effective contender.

Another major deficiency revealed by the XV-3 was the poor propulsive efficiency of the rotor (frequently referred to as a “proprotor” when used on a tilt rotor aircraft) in the airplane (or cruise) mode as well as poor performance in hover. The tilt rotor design philosophy that evolved during this period was that the proprotor should meet stringent performance requirements in the hover and airplane modes of flight but should not be significantly compromised to meet helicopter-mode (edgewise flight) design conditions. This meant that the proprotor blades could be designed with considerable twist, similar to that of airplane propeller blades, instead of the moderate twist of helicopter rotor blades (to accommodate the edgewise operation). While the opportunity to use twist more freely as a design variable could improve performance, the significant differences in blade loading (both in distribution and level) and in the distribution of air inflow to the proprotor between the hover- and airplane-mode conditions provided a challenging problem for the design engineers. Furthermore, the large diameter (low disc loading) proprotor which allowed the tilt rotor aircraft to hover at helicopter-like low levels of horsepower, results in a proprotor that is much larger than is required for maximum efficiency in the airplane mode. A search of prior experimental reports for applicable airplane mode test results showed that insufficient empirical data existed at this unusually light airplane-mode loading. NASA Ames and the Army AMRDL, therefore, sponsored and conducted several analytical and test activities to investigate both the hover performance level and airplane mode efficiency achievable with a properly designed proprotor.

In 1968, Boeing Vertol was awarded a contract by Ames to investigate the effect of blade twist on the performance of model-scale proprotors. Under this and an additional contract, Boeing conducted analytical design studies and performance predictions for a range of tilt rotor hover and cruise operating conditions. A series of 5-foot diameter proprotors was tested in the Army 7- by 10-foot wind tunnel at Ames (figure 28) [*not reproduced*]. Also, to investigate the effect of model scale on measured performance, 13-foot diameter proprotors of the same blade configurations were fabricated. Between 1969 and 1973, these proprotors (as well as others having additional twist configurations) were tested in the ONERA (Office National d'Etudes et de Recherches Aerospatiales) 8-meter (26 feet) diameter S-1 wind tunnel in Modane-Avrieux, France (figure 29) [*not reproduced*], the Ames 40- by 80-foot wind tunnel (figure 30) [*not reproduced*], and at the Air Force Aero Propulsion Laboratory, Ohio. Test operations covered a range of axial-flow flight conditions including hover-mode and airplane-mode flight from slow speeds up to a high-speed flight Mach number of 0.85. These experimental investigations also examined the changes in blade twist due to the aerodynamic and rotational loads and the effect of this "live twist" on cruise performance. The resulting data enabled the validation of analytical proprotor performance codes by Government and industry engineers.

For large-scale performance characteristics, the Bell 25-foot diameter proprotor was tested in the Ames 40- by 80-foot wind tunnel in November 1970 (figure 31) [*not reproduced*] as part of an earlier contracted effort. Ames also contracted with Bell and made arrangements with the Air Force Aero Propulsion Laboratory (AFAPL) for the March 1973 proprotor hover performance test at Wright-Patterson Air Force Base.

While the fundamentals of tilt rotor aeromechanics were being explored, another group of researchers and engineers were investigating the flying qualities, crew station, and control law aspects of this class of VTOL aircraft. Model-scale wind tunnel tests, analytical modeling, and piloted simulations were used to address these issues.

A series of tests was conducted with a $\frac{1}{5}$ -scale powered aeroelastic model of the Bell Model 300 tilt rotor aircraft design under an Ames contract. Hover tests conducted in September, October, and December of 1972 with this model examined the performance and dynamic characteristics for operations near the ground. It was discovered that, in the helicopter mode, the downward flow from the rotors impinging on the ground produced a strong upward-moving flow below the aircraft's longitudinal axis. This upwash, known as the "fountain," impacts the lower surface of the fuselage with increasing strength as the aircraft descends to the ground. Because this fountain is somewhat unsteady, the major portion of this air mass is seen to skip from one side of the fuselage to the other (particularly on round cross-section fuselages), causing this fountain-flow to impinge, alternately, on the lower surface of the right or left wing. This condition can contribute to

the lateral darting observed during the XV-3 flight tests and lead to a considerably high pilot workload during the landing operation. Also, the occurrence of the unsymmetrical aerodynamic loading on the wing surfaces produces a rolling moment that increases in magnitude, i.e., [.] is statically destabilizing, as the aircraft descends toward the ground. Recognition of these phenomena contributed to the development of improved stability augmentation control algorithms for future tilt rotor aircraft.

Subsequent wind tunnel tests, conducted in the Vought Aeronautics low speed wind tunnel, Texas, from January through March 1973, documented the performance, static stability in yaw and pitch, and determined trimmed control positions in all flight configurations. These data were critical for the flight dynamics analytical models that were being developed in order to validate control systems designed to meet the handling qualities requirements throughout the flight envelope. The tests also included flow surveys which revealed the presence of rotor tip vortices in the vicinity of the tail surfaces. These vortices could influence the effectiveness of the tail surfaces and produce oscillatory loads and disturbing vibrations.

AIRCRAFT DESIGN AND SIMULATION

With the tilt rotor technology efforts producing positive results, the managers of the joint AMRDL and NASA Ames activities could now justify the initiation of the next step, the development of a new tilt rotor proof-of-concept aircraft. As part of this plan, in August 1971 Ames awarded contracts to Boeing Vertol and Bell to conduct preliminary tilt rotor aircraft design studies. These efforts defined the characteristics and performance of a first generation military or commercial tilt rotor aircraft using a hingeless (Boeing Vertol) or gimbaleed (Bell) rotor system, provided a preliminary design for a minimum size "proof-of-concept" aircraft, developed a total program plan and cost estimates for the proof-of-concept aircraft program, and developed a wind tunnel investigation plan for the aircraft.

In January 1972, with Air Force funding, Ames extended an existing Boeing contract to produce a preliminary design on an advanced composite wing and to define a gust and blade load alleviation feedback control system for the tilt rotor aircraft. This study addressed the concern that the low-disc-loading proprotor may experience significant thrust, torque, and blade load excursions due to a high sensitivity to gusts and turbulence.

Work under the Boeing and Bell contracts also included the development of a mathematical model for simulation and for participation by each contractor in a piloted flight simulation investigation. These models allowed the test pilots to evaluate the workload and the handling qualities of the basic aircraft, both without automatic control-enhancing systems and with various control configurations, employing Stability and Control Augmentation System (SCAS) control-enhancing algorithms. The simulation also enabled the pilots to evaluate the thrust/power

management characteristics, the Force-Feel System (FFS), and failure mode design philosophy and aircraft behavior. The math models were developed not only as an evaluation tool for a particular aircraft control system design, but also as a device for the development of improved generic tilt rotor control law and crew station configuration. Initial piloted simulations were conducted in the Ames Flight Simulator for Advanced Aircraft (FSAA) in November and December of 1973. The math model created by P. B. Harendra and M. J. Joglekar of Bell during this period for the tilt rotor design selected for the flight program, through extensive development and refinement by Roger Marr and Sam Ferguson, became the basis for the generic tilt rotor math model used to evaluate various tilt rotor aircraft designs and related air traffic management issues in the Ames Vertical Motion Simulator in the late 1990s.

Document 5-49 (c), Selections from Martin D. Maisel, Demo J. Giulianetti, and Daniel C. Dugan, The History of the XV-15 Tilt Rotor Research Aircraft: From Concept to Flight, Monographs in Aerospace History, no. 17 (Washington, DC: NASA, 2000), "Flight Research," pp. 65–82.

In 1981, after a number of maintenance test flights, the Project Office began a series of ground and flight investigations to acquire a comprehensive data base to meet the fundamental and advanced technical goals of the TRRA (Tilt Rotor Research Aircraft) project. These test activities would eventually address structural loads, handling qualities, flight dynamics, structural dynamics and stability, acoustics, performance, and proprotor downwash.

HOVER PERFORMANCE

One of the first experiments at Ames explored several characteristics of the TRRA in the hover mode. The scope of this hover test included an evaluation of performance, acoustics, and the documentation of the "outwash" (the flow parallel to the ground generated by the proprotor downwash) at various hovering heights. These data were required by the Navy for the planned operational evaluation of the XV-15 onboard an aircraft carrier. To measure the proprotor wake flow in the vicinity of the hovering aircraft, the Naval Air Test Center of Patuxent River, Maryland, provided data acquisition equipment and a supporting research team. The outwash test apparatus consisted of a remote-controlled motorized cart that carried an array of sensitive electronic (ion-beam) anemometers (to measure the low-speed airflow) mounted on a 10-foot high pole. While the aircraft hovered (figure 50) [*not reproduced*] over a point on the hover pad at a selected height, the instrumented cart was moved to various predetermined positions along a track radiating from the point below the XV-15. To survey the region around the hovering aircraft, the heading orientation of the TRRA was varied 180 degrees in 30-degree increments, thereby

documenting the outflow from the region directly forward of, to the region directly aft of the aircraft.

The outwash test required that the aircraft hover at a precise height, heading, and position for a 15- to 20-second data acquisition period. The method devised to accomplish this involved the use of sets of visual targets mounted on tall poles around the hover pad. By lining up two sets of selected targets, the aircraft was positioned at the desired point in space (figure 51) [*not reproduced*]. Hover conditions for these tests ranged from an in-ground-effect (IGE) 2-foot wheel height to an out-of-ground effect (OGE) 50-foot wheel height. In addition to the outwash data, these steady hovering operations conducted in near-zero wind conditions enabled the simultaneous acquisition of excellent performance data.

Also during this period, an evaluation of electromagnetic interference (EMI) effects on the XV-15's electronic systems was conducted at Ames to ensure compatibility with Navy shipboard operations.

An associated test to measure download performed during the same test period was conducted with the XV-15 N702NA mounted on the tiedown stand at Ames. Load cells placed between the aircraft's two-wing and one-tail support "hard" points and the tiedown structure provided a means of determining the net vertical force of the aircraft. This information was then coupled with the aircraft weight and the free hover performance data to determine the download, the downward force acting on the aircraft due to the impingement of the proprotor wake on its wing and fuselage surfaces.

The magnitude of the download deduced from this test series turned out to generate a technical dilemma. Previous estimates of the download for a tilt rotor aircraft using deployed plain flaps ranged from 7 percent to 8 percent of the rotor thrust. This, combined with the estimates of rotor hover efficiency obtained from earlier hover tests of an isolated proprotor, appeared to properly account for the thrust produced and the wing-in-proprotor wake (interference) losses. Now the download obtained from the hover/tiedown tests indicated that the interference loss was twice the expected value.

The question would not be completely resolved until nearly three years later when several full-scale rotors were tested at the Ames Outdoor Aerodynamic Research Facility (OARF, figure 52) [*not reproduced*]. Further investigations of the proprotor wake interaction with the aircraft in 1985 provided a better understanding of the flow phenomenon that caused the higher than expected download. These tests involved the use of a new "balance" designed to provide highly accurate proprotor thrust and torque data. The balance, mounted between the proprotor and the drive motors, was developed by Boeing Helicopters (previously Boeing Vertol) under the contract that provided for the development of new composite-material proprotors for the XV-15 aircraft. The original XV-15 metal blades obtained from Bell for performance and stability wind tunnel tests in the early 1970s were one of the full-scale configurations tested. Data obtained from this test showed that the

XV-15 proprotor performance was, in fact, better than the earlier estimates. The somewhat mixed blessing that came out of these investigations was that highly twisted proprotor blades could be designed to produce high performance, but the high download generated by the proprotor wake consumed all of the unexpected performance gains. It was clear that the hover performance, and therefore the effectiveness of the tilt rotor aircraft, could benefit from an understanding and reduction of the download loss.

AEROELASTIC STABILITY EVALUATIONS

Of all of the technical areas to be explored in the TRRA test program, none would be as important as the investigation of the aeroelastic stability of the XV-15 in high-speed airplane-mode flight. The future of the tilt rotor aircraft depended on the outcome of these tests.

The instability problem encountered by the tilt rotor aircraft is caused by elastic deformation of the wing, pylon, and proprotor which oscillate when disturbed. The flexing of the wing and pylon imposes a pitching and/or yawing motion on the proprotor. This produces a proprotor in-plane force acting in the same direction as the original motion. Under some circumstances these in-plane forces are sufficient to make the displacements in amplitude grow with each oscillation, in effect acting as a powerful negative spring, producing an aeroelastic instability.

Both Bell and the Army/NASA TRRA project offices produced predictions of the structural dynamic stability of the XV-15. Bell used a company-developed method and the Government used predicted values determined from the analysis generated by Dr. Wayne Johnson. Both analyses indicated satisfactory stability throughout the envelope of the XV-15 except for one operating condition. The predicted instability occurred only at high airplane mode airspeeds and at the high RPM that was used for the hover and helicopter mode flight. The solution was to set an airplane mode speed limit above which the proprotor RPM had to be reduced to a level where the "one-per-rev" excitation of the natural mode could not occur. Fortunately, this RPM reduction was planned during the design of the XV-15 to improve the performance of the proprotor so that it became standard procedure to reduce RPM just after converting to the airplane mode.

To evaluate the aeroelastic stability of the TRRA in flight it was necessary to create rotor/pylon/wing displacements at the frequencies that corresponded to the various natural "modes" of the tilt rotor structure (as illustrated in figures 53 and 54) [*not reproduced*] and to measure the response of the aircraft's structure to these deformations. Diminishing oscillation amplitudes following the excitations occurred for a stable system (called "positively damped"), while potentially dangerous increasing amplitude oscillations indicated an unstable (negatively damped) structure at that operating condition.

The initial approach taken by researchers at Ames and Bell involved the installation of limited-authority (i.e. limited-motion) electrohydraulic actuators in the flaperon and collective-pitch control linkages on the right side of the aircraft. These “excitation” actuators were controlled from the cockpit where amplitude and oscillatory rates (frequency) were set.

The flight tests required special care. While confidence was high in the predictions of stability within and beyond the XV-15’s flight envelope, this evaluation was treated as having a significant risk because of the potential for a catastrophic failure if the predictions were wrong. Testing was initiated in airplane-mode level flight. When steady, level flight conditions were established, the crew activated the excitation system in accordance with the test plan. To minimize hazard, the series of test operations were initiated at lower airspeeds where the risk of encountering an instability was very low. After a thorough analysis of the data and a projection that the next test condition would be stable, the airspeed was increased in small increments and the test cycle was repeated.

Early flight tests involved oscillating the right-hand excitation actuators (one at a time) at a fixed frequency to drive a selected structural mode at resonance. The oscillations were then abruptly turned off and the resulting rate of decay of the structural vibrations was measured to determine the level of damping (an indication of stability). Since the resonant frequency for each of the modes was not precisely known in advance, the test had to be repeated several times to excite the desired mode. Another early method used to excite the various structural modes of the tilt rotor aircraft involved natural (or wake) turbulence excitation. The results of these initial structural dynamic evaluations are presented in reports by Bell and Government researchers.

An extensive series of airplane mode aeroelastic stability tests were conducted in March and April of 1987 by Wally Acree, the Ames TRRA principal investigator. The analysis of these test results revealed several problems. Many of the important mode-shape natural frequencies were closely spaced and some modes were not easily excited, especially with the natural turbulence excitation. Most significantly, the resulting damping-estimate scatter, although always indicating positive stability, was too extensive for meaningful correlation with, and validation of, the analytical predictions. The addition of left-hand flaperon and collective-pitch actuators similar to those on the right side of the aircraft enabled the excitation of specific symmetric and anti-symmetric mode shapes but the damping level scatter remained too large.

Another modification to the excitation system provided the capability to input “frequency sweeps,” the continuous variation of the excitation frequency from a pre-selected low setting to a pre-selected high setting (over a period of 23 seconds), at a chosen amplitude. Each test point required the test pilot to maintain the flight condition for about 30 seconds. Again, using the prior analytical methods, the damping level for many modes was poorly defined.

The search for improved aeroelastic stability test and data analysis technology led to the application of frequency-domain methodology by Dr. Mark B. Tischler of the Army Aeroflightdynamics Directorate at Ames. This work improved the quality of the flight test results, improved the identification of the modes and, coupled with the frequency sweep excitation, was demonstrated to reduce the total flight time required for flight envelope expansion stability evaluation.

The aeroelastic stability flight program at Bell, led by Jim Bilger, evaluated various experimental methods and conducted extensive investigations of two configurations of titanium proprotor hub yokes and one steel hub. No significant effects on stability were detected for the three hub configurations.

An important result of the aeroelastic stability flight test evaluations done at Ames and Bell was that positive damping (i.e. positive stability) was verified for all identified elastic modes at all airspeeds and altitudes examined. The most significant and technically difficult objective of the TRRA project and the goal set nearly 30 years earlier during the XV-3 project had finally been achieved.

SHORT TAKEOFF INVESTIGATIONS

In August, 1982, the Ames TRRA Project Office continued performance and handling qualities evaluations of the XV-15, aircraft N703NA. This included investigations of the tilt rotor's short takeoff performance (STO) characteristics. To vary the weight and center-of-gravity (c.g.), lead[-]shot-filled bags were placed in the fuselage and lead plates were affixed at the nose and tail of the aircraft. Following a series of evaluations at various c.g. locations, a number of flights were conducted to assess STO performance at high gross weights. Because of the high risk involved, these tests were performed at the sparsely populated and remote Crow's Landing Naval Auxiliary Landing Field (NALF), located about sixty miles from Ames. With the aircraft at or near the maximum takeoff gross weight, and the nacelles positioned at a preselected angle, the pilot released the brakes as the proprotors were brought to the desired torque level. The aircraft was then rotated for liftoff at a target ground speed and an attitude for maximum rate-of-climb was established (see figure 55) [*not reproduced*]. The aircraft position was measured using a laser operated by Ames Flight Operations Division personnel and contractors. The tracker utilized a laser retro-reflector mounted on the landing gear pods of the aircraft and the data was recorded for later correlation with aircraft data. Even at the maximum gross weight of the XV-15, the short takeoff operation was a rapid and very dynamic maneuver. This investigation enabled the effect of nacelle angle on STO performance to be evaluated. Too high an angle (at reduced torque to simulate a condition for which only STO and not vertical takeoff was possible) resulted in lower rates of acceleration, therefore extending the ground roll before liftoff could occur. Too low a nacelle angle provided improved ground roll acceleration, but the reduced vertical lift vector from the proprotors delayed the liftoff.

It was determined (for the XV-15 at its maximum takeoff gross weight, and at approximately 60 percent of the normal power) that the optimum nacelle position for minimum ground roll to clear a 50-foot obstacle was 75 degrees. Evaluations of this type verified the capability of the tiltrotor aircraft to perform short takeoffs at gross weights well above its vertical takeoff gross weight, adding an important performance capability to this new aircraft type.

As often happens in developmental work, a totally unforeseen incident involving a critical proprotor hub component occurred during the STO tests. This component, called the “yoke,” to which the blades are attached, was manufactured of Titanium because it afforded valuable weight saving over steel while still providing the required fatigue life.

On October 1, 1982, while performing STO operations at the Crows Landing NALF, at the XV-15’s maximum takeoff gross weight, a telephone call was received by the Ames test director[,] Shorty Schroers, from engineers at the Bell facility in Texas. They informed Schroers that they had just discovered that the strength of Titanium material used for the rotor yokes was significantly lower than that used in their design. The flight crew was informed about this new and somewhat disturbing development while in flight. They landed the XV-15 safely and removed the weights added for the STO tests. After further consultation with Bell engineers, it was decided to “gingerly” fly the aircraft back to Ames taking special care to keep the hub yoke oscillatory loads at a low level.

The full story regarding the Titanium fatigue strength anomaly emerged later. While performing design work for another project, a Bell engineer came across a published fatigue strength allowable load level for Titanium that was lower than that used for the design of the XV-15 yokes. Although the Titanium identified by the Bell engineer and the Titanium used for the proprotor were the same, a difference existed in their fatigue strength because of heat treatment (a process by which the strength and other properties of metals are altered by exposure to specific thermal conditions). As luck would have it, the heat treatment for the Titanium used for the XV-15 yokes was the one which resulted in the lower fatigue strength. This meant that aircraft N703NA had been operating at significantly higher loads than the lower strength Titanium could bear for the duration of the flight program.

Operation of both XV-15 aircraft was continued but with the installation of a new set of Titanium yokes and with the allowable loads reduced until a better solution was found. The solution was replacement of the Titanium yokes with steel yokes of the same design. Steel yokes were installed on aircraft N703NA in July of 1985 and have been used continuously since then without incident.

FLOW VISUALIZATION STUDIES

In the early 1980s, a number of tilt rotor technical issues remained unexplained. One of these was that acoustic measurements in the hover mode of flight revealed

that noise, rather than being at about an equal intensity around the aircraft, was greater behind the aircraft than at an equal distance along its sides. Another issue was that, although the magnitude of the download was now accepted as being greater than initially estimated (based on recent performance investigations), verification of the reason for this was needed. In an attempt to answer these questions and to better understand the airflow around the tilt rotor aircraft in general, in-flight flow visualization studies were made using tufts taped to the wing and flaperon upper surfaces. Flow direction was recorded in flight with a movie camera mounted at the tail of the XV-15. These studies surprisingly showed a spanwise inboard flow over the wing instead of the expected chordwise flow from hover through low-speed helicopter flight mode.

Another simple but unusual test was set up on the Ames tiedown test stand to investigate the flow conditions above the wing. The approach involved video taping smoke ejected over the wing while the aircraft was operated in the hover mode. Since the XV-15 was full-scale with accompanying high airflow velocities through the rotor, a high volume smoke source was required. Nontoxic, non-corrosive, smoke grenades of the type usually used by downed aircrew were selected.

The test apparatus consisted of a heat-insulated "smoke" box into which the smoke grenade would be dropped, a blower at the outlet of the box, and ducting leading from the blower to the top of the wing. Since this was a low budget test operation, an electrically powered leaf blower, generously provided by TRRA project engineer Jim Weiberg, was used to pump the smoke. To everyone's satisfaction, the first test of this system (without the aircraft in position) was a resounding success. When a smoke grenade was ignited and dropped into the smoke box everything looked fine. A thick jet of colored smoke emerged at high speed from the duct exhaust accompanied by the comforting roar of the blower. However, success was short lived. In very short order the sound of the leaf blower changed from a roar to a high pitched squeal and smoke started flowing from the box instead of from the end of the duct. Clearly something was not right. Following a fast shutdown, it was discovered that the leaf blower was equipped with a plastic fan which had melted from the heat generated by the smoke. Thus, Jim Weiberg's leaf blower became a casualty in the quest for advancement of tilt rotor aircraft technology. The leaf blower was replaced with a commercial blower having metal fan blades and an electric motor. This new smoke generating system functioned well and provided the smoke needed for the flow visualization study.

The flow visualization data revealed that near the wing tips, as expected, the proprotor wake impinged on the wing upper surface and spilled over the leading- and trailing-edges of the wing in a chordwise direction (figure 56) [*not reproduced*]. As the smoke was moved to the wing midspan position, it showed that the proprotor wake was also moving in a spanwise direction toward the fuselage (figure 57) [*not reproduced*]. With the smoke source moved further inboard, it was seen that the flows from the two proprotors moved spanwise toward each other

and combined above the fuselage centerline, turning vertically upwards to form a “fountain flow” above and along the aircraft’s longitudinal plane of symmetry (figure 58) [*not reproduced*].

These observations confirmed the inboard flow observed from the tuft study mentioned earlier. Furthermore, the large air mass involved in the over-fuselage fountain flow created a large downward force which accounted for the higher than expected download in the hover mode of flight. As explained later, this fountain flow was also found to contribute to the nonuniform distribution of noise around the hovering tilt rotor aircraft.

SIDESTICK CONTROLLER

Among the many decisions made early in the development of the TRRA was the cockpit control configuration. Simulation and flight evaluations by Bell and Government pilots resulted in the selection of a helicopter-type power lever for rotor control and a conventional center stick and rudder pedals for longitudinal, directional, and pitch control inputs. The tall center stick, however, with its mass-center several inches above its pivot point, introduced undesirable dynamic effects (called “bobweight” motions) during maneuvers. This issue, coupled with the possible interference of the center stick with crew station structure (instrument panel), problems with cockpit ingress or egress, and the general interest in conserving limited cockpit “real estate,” led researchers to investigate the use of a sidestick controller as the principal flight control for the developing military JVX tilt rotor aircraft (later called the V-22 Osprey). The principal concerns with this type [of] controller were whether it would be able to provide the same level of control as the conventional center stick, and whether it could perform adequately during “degraded” flight control system conditions (such as a malfunctioning or battle-damaged control system).

To answer these questions, it was decided to perform a piloted simulation evaluation and a full flight investigation of a 3-axis sidestick controller on an XV-15 TRRA for both normal and “degraded” flight control system conditions. Gary Churchill, senior controls engineer with the TRRA Project Office, developed the control laws and was the primary investigator.

The XV-15 TRRA was ideal for the installation of the sidestick controller because it had bulging side windows (designed into the aircraft for better visibility) and an uncluttered side console which provided room for a functional installation, including an adjustable arm rest. A control and status panel for the sidestick controller was added to the instrument panel.

Initial sidestick control system gains and sensitivities were established using the Ames Vertical Motion Simulator (VMS) and a refined simulation math model based on the one originally developed in the early stages of the XV-15 project. These control law parameters were adjusted during XV-15 installation/hangar checks, and the resulting configuration was taken into the flight program.

In July 1985, an intensive flight evaluation of a three-axis sidestick controller was performed in XV-15 N703NA. During a nine day period, a total of 13 flights were flown with eight pilots from six agencies (the NASA, Army, Navy, Marine Corps, Bell Helicopter Textron, and Boeing Helicopters). Control characteristics of the center stick and the sidestick controller were compared. Each pilot received a familiarization flight in the left seat using a conventional center stick control and flew an evaluation flight in the right seat which was equipped with a sidestick controller. Without exception, all of the evaluation pilots found the sidestick to be a viable controller and that the aircraft was safe to fly with a degraded control system (i.e. with the SCAS turned off). The pilots even reported that some tasks could be performed with more precision with the sidestick controller than with the conventional center stick.

While the sidestick investigation successfully achieved its objectives, the V-22 Osprey was nonetheless configured with a center stick control. However, the sidestick controller continues to be considered by the V-22 Project Office for future application to the tilt rotor aircraft.

ACOUSTICS

By the late 1970s, communities adjacent to airports and heliports had become quite sensitive to the noise generated by aircraft operations, in particular, to the disturbing character of the sound of rotorcraft noise. Therefore, if the tilt rotor were to be used as a civil transport aircraft, it was important to document its noise in the terminal area. In addition, it was necessary to establish a tilt rotor noise database for various flight modes and operating conditions for use in the development of prediction methodology. The XV-15 became the test bed for a wide range of tilt rotor acoustics studies.

Some very limited initial noise data were obtained with the XV-15 at Bell and consisted of only a few data points acquired during early hover tests. The next opportunity to measure tilt rotor noise occurred during hover performance testing at Ames in February and March 1981. An array of 16 microphones was distributed around a selected hover point to fully document the noise around the aircraft. The resulting acoustic data (refer to footnote 34) [*not included*] surprisingly showed that the noise varied by a few decibels around the aircraft, rather than remaining nearly constant. An explanation was later provided by Professor Al George of Cornell University[,] who postulated that this was caused by the reingestion of the turbulent fountain flow (revealed during the flow visualization test) into the prop rotor over the root end of the wing.

Several subsequent tests were conducted to explore the sound generated during flyover or terminal approach conditions. The first was conducted at Crows Landing in September 1982 by a NASA/Army team and again in April 1986 with support from Bell. The NASA[-]operated radar-coupled laser tracker was used

at the isolated Crows Landing NALF to measure the track of the XV-15 during approach and flyover operations. This allowed the researchers to relate the exact position of the aircraft with respect to each microphone with the recorded noise data. The initial evaluation of these data was reported by John Brieger, et al. Later analysis of this and other acoustic data was reported by Bell's Bryan Edwards.

Another area of interest was the proprotor noise at the external fuselage walls of the aircraft (which would affect cabin acoustics). The cabin noise, especially for civil transports, would have to be at or below acceptable comfort levels. Furthermore, if large amounts of noise-reducing insulation were required, it would impose a significant weight penalty and impact the economic viability of the civil tilt rotor aircraft. Measurements of the distribution of sound pressure along the side of the XV-15 fuselage and at two locations within the cabin were obtained for various flight conditions during tests of N703NA at Ames. Later tests focusing on cabin interior noise were conducted by Suzanna Shank of Bell.

A further series of noise measurements was made during hover tests at Ames in December 1990, and during terminal area and flyover tests at the Crows Landing NALF in August and September 1991, with the new composite blades installed on XV-15 N703NA. These were the first such experimental measurements from flight data with a proprotor blade configuration other than the original metal blades. The data were acquired to validate acoustics analyses being developed by researchers at the Langley Research Center, under the NASA Short-Haul Civil Tiltrotor (SHCT) program. These tests were a joint effort between the Langley acoustics engineers and technicians and the Army/NASA TRRA team at Ames. Operations were conducted just after sunrise (shown in figure 59) [*not reproduced*] to ensure low wind conditions (usually less than 3 knots) during noise data measurements.

Additional investigations of the terminal area noise generated by the XV-15 with metal blades were conducted by Bell at a remote site near Waxahachi[e], Texas, in October and November of 1995. The relatively level, undeveloped terrain, far from major roads and undesirable background noise, provided an ideal environment for this work. A large microphone array was set up around the target landing point while a mobile laser tracker from Ames was placed nearby to measure the position of the XV-15 during the tests. This study focused on the effect of approach profile on the intensity of the noise propagated to the ground, and utilized approach conditions examined earlier during simulation evaluations of terminal area operations in the Ames Vertical Motion Simulator. Bill Decker, the NASA Ames principal investigator for the simulation studies, participated in the terminal area test planning and test operations. To provide flight path guidance, the XV-15 used a Global Positioning System (GPS) monitoring research flight director which was developed by Mark Stoufflet and Colby Nicks of Bell. A Langley team acquired acoustic data from an array of 33 microphones covering an area of five miles long and 1.25 miles wide. The test results confirmed that appropriate combinations of aircraft configuration and flight path profile

could be used to significantly reduce the noise level and footprint area during tilt rotor approaches.

In December 1995, with plans being developed for an acoustics test of the XV-15 metal-bladed prop rotor in the acoustically treated test section of the Ames 80- by 120-foot wind tunnel, a special flight investigation was required to obtain comparable free flight noise data to determine the effect of the wind tunnel walls on the measured sound. The evaluation involved flying the XV-15 behind, and in close formation to[,] a quiet research aircraft (the Lockheed YO-3A) which was equipped with microphones and recording equipment. By maintaining the YO-3A microphone location at a fixed distance and position with respect to the XV-15 prop rotor (shown in figure 60) [*not reproduced*] corresponding to a microphone location in the test section of the wind tunnel, and by operating at the same prop rotor operating condition, a direct comparison (with corrections for the second prop rotor) between the flight data and wind tunnel test data was obtained. This experiment was conducted by Ames researchers. The tests involved a Bell flight crew in the XV-15, and a NASA flight crew in the YO-3A.

COMPOSITE PRO ROTOR BLADES

From the very beginning of the TRRA project the prop rotor blades were of special concern to the Government Project Office. The metal blades used on the XV-15 were designed in the late 1960s under Bell's IR&D funding for the predecessor tilt rotor aircraft, the Bell Model 300. This aircraft had a design gross weight of 12,400 pounds, 600 pounds lighter than that of the XV-15. The concern was that the prop rotors would be too highly loaded, i.e. operating too close to aerodynamic stall, to provide adequate reserve thrust for control when operating in hover at high gross weights. This could result in a reduction of control effectiveness or the need for a substantial increase in power when operating at the high gross weight condition.

Flight tests of the XV-15, however, did not indicate deficiencies. The metal bladed prop rotor, although sized for a smaller aircraft, performed well at all XV-15 operating weights and flight conditions. While performance was satisfactory, another problem emerged that could threaten the future of the XV-15. This was the possibility that one or more blades could become unserviceable or unflightworthy due to mishandling or deterioration of the blade's structural integrity.

Concern centered on the aft blade section, an aerodynamic fairing constructed of a lightweight aluminum honeycomb core covered with a thin steel skin (figure 61) [*not reproduced*]. Over the first few years of aircraft operations, minor surface damage was incurred due to ground handling. More significantly, small areas of separation of the bond between the skin and the honeycomb was [*sic*] detected on several blades. While the size of these "voids" was monitored during frequent inspections, the discovery of a rapid growth in size or an unacceptably large separation area

could render the blade unusable for flight. The limited number of spare blades (two right and one left) meant that the loss of two left flightworthy blades would ground an aircraft.

Part of the TRRA Project Office advanced flight research program goals was the “investigation of alternate or advanced proprotor configurations.” This was consistent with the Project Office’s perceived need to replace the blades, both to assure the continuation of flight testing and to explore the application of new materials technology. The activity, to design, build, and flight test a new set of proprotor blades for the XV-15, was known as the Advanced Technology Blade (ATB) project.

Although there were no immediate prospects for funding an upgraded transmission that would allow a larger amount of the installed engine power to be used (providing a significant enhancement of the XV-15’s performance), the ATB project was considered the first step in this direction. Therefore, on August 12, 1980, an RFP was issued by the TRRA Project Office for the procurement of the ATB’s. The design objectives called for the development of “a blade design compatible with the XV-15 tilt rotor research aircraft which improves static stall margin and cruise speed performance using advanced structural materials and design techniques to improve the strength and service life of the tilt rotor blades.” Proposals in response to this RFP were received from Bell and Boeing Helicopters, and were evaluated by an SEB comprised of NASA and Army technical and procurement specialists. While both proposals were determined to be acceptable, the decision was made to award the contract to Boeing. Among the factors that influenced this decision was the significant experience Boeing had acquired with composite rotor blades provided for the Army’s fleet of CH-47 helicopters. Also, the Boeing blade design provided the ability to alter blade sweep and incorporate removable tip and cuff (inboard fairing) sections which allowed them to propose alternate blade configurations for research purposes. These features are illustrated in figure 62 [*not reproduced*]. It was noted that the Boeing blade had a larger solidity (effective area) than the Bell blade which contributed to the desired improvement in the stall margin. This would prove to have an unexpected effect on the XV-15/ATB flight program. A contract to develop the composite proprotor blades was awarded to Boeing Helicopters on July 9, 1982.

As part of the ATB qualification and evaluation program, a series of hover performance tests were conducted on the OARF at the Ames Research Center between February and April of 1985. These tests, evaluated three tip configurations and two cuff configurations on the ATB, as well as the XV-15 metal bladed proprotor, and an approximate $\frac{2}{3}$ -scale model of the proprotor designed for the JVX military tilt rotor aircraft. Figure 63 [*not reproduced*] shows the ATB on the OARF Prop Test Rig.

This test series produced a large amount of high quality performance data. The isolated proprotor hover data validated the predicted ATB performance and showed that the XV-15 metal blades actually performed slightly better than previously expected.

Following the completion of controllability flight evaluations at Ames with modified SCAS components installed in N703NA, efforts began to prepare the ATB for flight tests. XV-15/ATB ground runs on the ramp and on the tiedown stand were conducted between September and early November of 1987[,] and the first hover flight with the new blades was performed on Friday, November 13, 1987.

From the first operations with the ATB there were problems. The initial difficulties surfaced during the runs required to obtain a satisfactory proprotor track and balance. Balance of the two interconnected proprotors presented problems on the XV-15 since a change on one proprotor provided an excitation that resulted in a change in the dynamic behavior of the other proprotor. Obtaining a proper balance with the ATB presented a special problem which stemmed from the frequent addition or removal of small weights from a fiberglass weight block located at the tip of each blade within a removable tip cover. The frequent removal of the tip covers to alter the weights resulted in the failure of the metal screw-retention inserts installed in the fiberglass weight blocks. Other problems included the deformation of the skin material under the retention screws at the fiberglass tip requiring the installation of metal washers, the failure of the bonds within the tip-weight assembly, and the delamination (unbonding) of the blade skins from the underlying nomex honeycomb material. Many of these material issues continued to cause problems during operations with the ATB.

When the expansion of the flight envelope in the helicopter mode with the ATB began in June 1989, higher than expected oscillatory blade control loads were measured at airspeeds as low as 40 knots. These loads increased with airspeed and reached the allowable limit at about 65 knots, too low to allow a safe envelope for initiating conversion. At that point, efforts were intensified to analyze test results and initiate analytical studies in order to determine the cause of the high loads. In addition, the loads investigation, headed by John Madden from Ames, included a series of tests on the XV-15 control system to determine stiffness characteristics as a function of the rotational (azimuthal) position of the proprotor. The results of this evaluation revealed that a major mechanical rotor control component, called the swashplate inner ring, did not provide uniform stiffness at all azimuthal positions. The lower than expected stiffness, coupled with the increased blade mass and inertia of the ATB (due to the larger solidity than the metal blades) resulted in lowering the natural frequency of the control system to the 3/rev (3 vibrations per proprotor revolution). When the three-bladed proprotor was flown in forward helicopter mode flight, the 3/rev aerodynamic excitation coupled with the system's natural frequency to produce high structural loads.

A temporary remedy was proposed by John Madden and was subsequently implemented. A set of shims was installed between the inner ring and the transmission housing which locked out the lateral cyclic input to the rotor (used for flapping reduction in helicopter mode flight) and provided the required increase in the

control system stiffness. A permanent modification to change the inner swashplate ring material from aluminum to steel was planned if the shims proved effective.

After another series of ground runs, tiedown tests, envelope expansion flights and tip repairs, the XV-15 with the ATB achieved airplane mode flight on December 14, 1990. The oscillatory control loads were sufficiently reduced by the shims to allow full conversion. Then another problem appeared.

The ATB, having a larger solidity than the metal blades which the control system was designed for, required greater steady control forces to hold the blade at the collective blade angles required for high-speed airplane mode flight. The dual hydraulic collective actuator was, in fact, capable of providing this force, but since only one of the dual units was equipped with an automatic switchover to the backup hydraulic system in case of a primary hydraulic system failure, flight operations had to be limited to loads within the capability of one half of the dual actuator. This imposed a restriction on the maximum airplane mode airspeed with the current control system configuration. To correct this limitation, Bell was tasked to develop a design for the automatic hydraulic backup for the unprotected side of the dual collective actuator. The task order, under the XV-15 support contract, also required Bell to provide steel swashplate inner rings to correct the low control system stiffness and restore the lateral cyclic control.

With the dynamics and loads issues associated with the ATB understood and with corrective actions taken, the Army/NASA TRRA team once again focused on tilt rotor research. In a cooperative program with acoustics experimenters from Langley Research Center, ATB noise surveys in the hover mode were conducted at the Ames Research Center in December 1990. Starting on August 21, 1991, a series of flyover and terminal area noise measurements were also performed at Crows Landing.

On September 6, at Crows Landing, while NASA test pilots George Tucker and Rickey Simmons were on a downwind leg of the traffic pattern prior to setting up another test approach, they heard a loud noise in the cockpit followed by a sudden and violent increase in the vibration level. At the same time, in the control room at Ames, the normally narrow traces on the strip chart recorder showing safe, within-limit, oscillatory loads and moments instantly blossomed to the full width of the bands, indicating that the safe load levels had been greatly exceeded. In the cockpit, the vibration was so severe that the instruments were not readable. George Tucker reduced power and turned toward the runway while Rickey Simmons contacted the control tower requesting an immediate landing. The tower asked if emergency vehicles were required and the response was affirmative. With fire and rescue trucks rolling, the aircraft was brought to a safe landing about 80 seconds after the high vibration started, followed by a rapid shut-down.

After the proprotors stopped, the problem became obvious. The cuff fairing on one of the left proprotor blades had moved outboard about eight inches. Analysis revealed that the displacement of the cuff was due to the failure of metal retaining

clips to carry the cuff's centrifugal loads to the blade structure, as intended by the design. Instead, because of tolerance buildup and poor workmanship and assembly, the loads were borne by the fiberglass flange rather than the metal retaining clips. This eventually led to the failure of the fiberglass flange. Following inspection, the aircraft was disassembled with the assistance of a Bell crew, and transported to Ames onboard flatbed trucks.

After reassembly, a structural dynamics "shake test" was performed at Ames with aircraft N703NA. This activity was conducted by Wally Acree to provide accurate aircraft resonant frequency characteristics for aeroelastic stability analyses. Upon completion of the shake test in January 1991, the aircraft entered a 100-hour major inspection.

Meanwhile[,] the high oscillatory loads imposed on the aircraft's structure were analyzed to determine the amount of fatigue life consumed by the sliding cuff incident. While the fatigue damage was considerable for a single event, it was determined that aircraft N703NA was safe to fly again.

Before the ATB could be used again, however, the cuff retention configuration would have to be redesigned to prevent a reoccurrence of the failure. An improved cuff retention was designed and fabricated by Ames and successfully proof tested. Changes in NASA Ames' role in flight research soon occurred and altered plans for further flight testing of the XV-15.

Document 5-49 (d), Selections from Martin D. Maisel, Demo J. Giulianetti, and Daniel C. Dugan, The History of the XV-15 Tilt Rotor Research Aircraft: From Concept to Flight, Monographs in Aerospace History, no. 17 (Washington, DC: NASA, 2000), "Epilogue," pp. 105–114.

The XV-15 continues to contribute to the advancement of aeronautical technology through its flight test activity at Bell, thereby further increasing the benefits derived from the TRRA project. It is appropriate, however, to note the costs incurred by the Government in the performance of this work. By September 1981, sufficient data had been acquired in the two research aircraft flight test program for the Government to declare that the primary proof-of-concept objectives had been successfully completed. At that time, the cost of the TRRA contract was \$39.5M. An additional \$5.0M was used during this period for supporting research and technology. Research and support work continued with the prime contractor (Bell) for several years under the same contract, and when it was terminated in August 1993, the final cost to the Government was \$50.4M. Bell had contributed over \$1.5M to the effort in accordance with the incentive fee arrangements of the contract. In recent years it has become apparent that the Government's investment in tilt rotor aircraft technology, through the new programs now under development, will likely provide thousands of new jobs and may even improve the U.S. balance of trade. The key events leading to the validation of tilt rotor technology by the XV-15, and

the subsequent development of production tilt rotor aircraft (discussed later in this section) are listed in the chronology provided in Appendix C [*not included here*].

In addition, the contributions of many people associated with these projects over the years have been recognized by leading U.S. technical organizations and societies. A summary of the key awards and new speed and climb records set with the XV-15 are described in Appendix D [*not included here*]. A collection of pictures showing the tilt rotor aircraft during the flight program is provided in the photo-gallery, Appendix E [*not included here*]. Also, Appendix F [*not included here*] contains a comprehensive bibliography of tilt rotor related publications.

The remarkable achievements, both technical and operational, of the XV-15 TRRA were directly responsible for the introduction of the world's first military and civil tilt rotor aircraft. Without the technology validation and the demonstrations provided by the TRRA, it would not have been possible for the leaders of industry and the Government to be confident enough to launch these new aircraft production programs. Thumbnail sketches of these programs, as well as brief summaries of the Government activities spawned by the TRRA project[,] are provided here.

JVX/V-22 OSPREY

Beginning in the late 1960s, and continuing for more than a decade, the Marines studied the options available for their future vertical assault role and transport needs. However, because of the relatively small number of vehicles required, coupled with the specialized missions, they could not establish the necessary level of support in the Department of Defense (DoD) and in the Congress to initiate acquisition of a new purpose-built aircraft. By the end of 1981, the DoD identified additional vertical lift missions for the Army and the Air Force which could make use of the same flight vehicle that would satisfy the Marine[s'] requirements. If a common aircraft could be designed to fill the operational needs of these three services, the aircraft procurement might then be large enough to justify development and unit acquisition costs. Therefore, an assessment of the feasibility for identification of a single vehicle which could satisfactorily perform these diverse missions and the identification of the most suitable vehicle type for these applications was directed by the DOD. This study was conducted by a Joint Technology Assessment Group (JTAG) consisting of Government engineers and military specialists at the Ames Research Center, between February and May of 1982. Col. Jimmie Creech, USMC, was the study manager. The study was to include both current and advanced VTOL aircraft. Four vehicle types were selected for this investigation, with a team leader and a technical staff appointed to assess each type. The helicopter and compound helicopter teams were led by Dr. Michael Scully of the Army Advanced Systems Research Office (ASRO), the fan-in-wing team was headed by Sam Wilson of NASA Ames, and John Magee, also of NASA Ames, directed the

tilt rotor study team. The latest design methodology and performance data were applied to develop a credible and practical design configured and sized to meet, to the best degree possible, the various and often conflicting mission requirements.

The results of the study made it clear that the tilt rotor aircraft was best suited to meet diverse missions. These included the Marine vertical assault, Navy rescue and logistics, Air Force long-range special operations, as well as the Army medical evacuation, long-range combat logistics support, and combat air assault support missions. With a single technical approach identified that could satisfy the requirements of the three military services, advocacy of the multi-service tilt rotor aircraft to the Congress and to the administration was initiated. The XV-15 proof-of-concept and flight research programs had established that performance, loads, and structural dynamics of the military tilt rotor transport could be predicted with high confidence. However, major changes occurred that affected the course of the JVX (Joint Vertical Experimental) program.

First, at the time of the advocacy of the new aircraft, the Army was engaged in the initiation of another major high cost weapons system procurement, the LHX (Light Helicopter, Experimental). With a commitment to develop a world-class fighting machine that would use state-of-the-art structures, propulsion, avionics and weapon systems technology, it was not economically or politically feasible for the Army to simultaneously advocate and manage the development of a new technology transport rotorcraft. Since the primary user of the JVX aircraft would be the Marines, the task of managing this program was handed to the Navy, the weapon systems procurement agency for the Marine Corps.

Second, as the flight tests of the JVX aircraft, now called the V-22 Osprey, were about to get under way, a new administration came into office under President George Bush. With a focus on reducing DoD expenditures, Secretary of Defense Richard Cheney identified major procurements selected for cancellation. Since the JVX activity had recently begun and relatively little funding had been invested at this point, it became a target for elimination. The battle for the survival of the advanced rotorcraft transport aircraft would be waged for several years. Advocates included the potential military users, members of Congress, and elements of the rotorcraft industry. The opposition was the administration and the upper management of the DoD.

Other issues surfaced. In accordance with a longstanding DoD procurement policy, contractors for major new acquisitions were selected from competitive bids. In this case only two rotorcraft companies had sufficient technical expertise to bid. These were Bell and Boeing, and only Bell had extensive flight test experience with the tilt rotor aircraft. Furthermore, in the early 1980s, there was a DoD mandate for prime contractor teaming arrangements seen as a means of sharing Research and Development costs by the prime contractors, thus reducing the financial risk to any one company, as well as permitting the development of a broader technology base.

To satisfy the teaming requirement, two companies that had been competitors, Bell and Boeing, joined forces. Although this would bring together the world's greatest resources of tilt rotor technology, it left no credible competitors in the U.S. rotorcraft industry. When the RFP for the V-22 was issued, only the Bell-Boeing team responded. While this presented a dilemma for advocates of competitive procurements, the qualifications of the team, coupled with strong political advocacy from the powerful Texas and Pennsylvania congressional representatives, provided the support needed to proceed. The successful advocacy of this program is credited to strong congressional support, confirming the observation by political analyst Brenda Foreman that "if the politics don't fly, the hardware never will."

On March 19, 1989, the first flight of the Osprey was conducted at Bell's Flight Research Center at Arlington[,] Texas, the site of the first XV-15 flight twelve years earlier. Bell test pilot Dorman Cannon (who was also onboard the XV-15 during its first test flight) and Boeing Helicopter test pilot Dick Balzer were at the controls. The first full conversion to airplane mode was flown on September 14, 1989. Figure 75 [*not reproduced*] shows one of the V-22 EMD (Engineering Manufacturing Development) aircraft during early flight tests.

The flight test program of the V-22, however, was not without serious problems. Of the six Full Scale Development (FSD) aircraft planned for the flight test efforts (of which only five were completed), two crashed and were destroyed, with one crash taking the lives of all seven people on board. However, it was determined that these accidents were not due to the inherent characteristics of this vehicle type[,] and the program survived.

As of late 1999, the V-22 Osprey is undergoing operational testing by the U.S. Navy and initial operational capability (IOC) is planned for the year 2001. On September 8, 1999, the first production V-22 delivered to the U.S. Marine Corps landed at the Pentagon for a tilt rotor demonstration hosted by Secretary of Defense William S. Cohen. A CH-46 (the helicopter that will be replaced by the V-22) and XV-15 proof-of-concept aircraft, in Coast Guard colors, landed along side the Osprey. After several members of Congress flew in the new V-22 tilt rotor transport, Secretary Cohen described it as a "revolution in military affairs." Based on the technology demonstrated by the XV-15 TRRA, the V-22 will bring capabilities to the U.S. armed services that are not available in any other vehicle.

UAV

Tilt rotor aircraft technology also offers performance and operational capabilities that are highly desirable for unmanned aircraft being developed for military applications. The ability to takeoff and land from a very small area, such as a landing pad onboard a ship, coupled with a large radius of action, high altitude performance, and a high cruise speed to get to the target area[,] quickly provides a combination of attributes that meet the needs of the military users.

To demonstrate the readiness of tilt rotor technology for this application, Bell Helicopter Textron developed the Eagle Eye Unmanned Aerial Vehicle (UAV), (figure 76) [*not reproduced*]. This aircraft performed flight evaluations at the Naval Air Test Center, Patuxent River, Maryland, in 1995 and at the Proving Grounds in Yuma, Arizona, in 1998. The later activity demonstrated the ability to take-off from and land within a 24-foot landing spot (and consistently touch down within a 10-foot square area), hover with the required fuel and payload, fly at over 200 knots, and cruise at 14,600-foot altitude with the 200-pound payload. The Eagle Eye uses a highly automated, command based flight control system, that includes two inertial navigation systems and a GPS (Global Positioning System).

As of this writing, Bell continues to explore missions and applications for the tilt rotor UAV.

MODEL 609

In November 1996, Bell and Boeing announced that they had agreed to jointly design and build the world's first production civil tilt rotor aircraft, the Bell Boeing 609 (BB 609). This major and multiyear commitment of company resources represented the culmination of the early research and technology efforts begun with flight tests of the XV-3 in the mid-1950s and completed with the technology validation provided by the XV-15 proof-of-concept tilt rotor research aircraft in the 1980s and 1990s.

In addition to the fundamental engineering and design capabilities provided by the joint Government and industry research programs, the model 609 will incorporate many features developed for the V-22 Osprey. This technology transfer will include state-of-the-art fly-by-wire flight controls and avionics, advanced composites in the rotors and structure, and Health and Usage Monitoring (HUM) systems. The 609 aircraft will have a crew of two and carry six to nine passengers. It is designed to cruise at 275 knots (316 miles per hour) and have a range of 750 nautical miles (863 statute miles), which is nearly twice the speed and range capability of current helicopters of the same payload class. Takeoff gross weight will be about 16,000 pounds with an approximate useful load of 5,500 pounds, which means that it can carry a full complement of passengers and plenty of cargo and/or baggage, an important consideration for civil aircraft. The fuselage will be pressurized to 5.5-psi pressure differential providing a passenger cabin altitude of 8,000 feet at a 25,000-foot ceiling. Although the BB 609 has VTOL capability, it is anticipated to be utilized as a fixed wing, turboprop airplane using rolling takeoffs during more than 90 percent of its operations. This will give it the ability to increase payload and/or range when VTOL operations are not required, thus lowering operating costs. Efforts are underway with the Federal Aviation Administration (FAA) and the European Joint Aviation Authorities (JAA) to establish certification for this aircraft type, anticipated by early 2001, followed by first deliveries of the aircraft later that year.

A full-scale mockup of the aircraft (figure 77) [*not reproduced*] was displayed at the June 1997 Paris Air Show where the V-22 Osprey with the XV-15 TRRA flew daily flight demonstrations. The interest generated by the mockup and flight demonstrations was such that Bell received 36 advanced orders at that time for the new aircraft. Bell President Webb Joiner, speaking of the early customers for the Model 609, said that “These are not just customers, these are visionaries,” noting their commitment to a new aircraft type two years before design freeze and four years in advance of first delivery. Bell further anticipates a market of up to 1000 Model 609’s over the next 20 years, serving needs such as executive transport, off-shore oil operations, search and rescue, emergency medical service, drug enforcement and border patrol.

In March of 1998, shortly after the Boeing Company purchased McDonnell Douglas Helicopters, and subsequently made the decision to focus on military helicopters only, Boeing removed itself as a major contributing partner in the BB 609 program. However, at the Farnborough Air Show in September of 1998, Bell announced a joint venture with the Agusta Helicopter Company of Italy wherein Agusta will participate in the development, manufacture, and final assembly of 609s delivered in Europe and other parts of the world. The 609 was now renamed the BA 609 (for Bell Agusta 609).

Agusta has had a long history of joint programs with Bell and also worked with other European aerospace companies on the development of tilt rotor technology under a program called EUROFAR (European Future Advanced Rotorcraft). Following the Bell-Agusta teaming announcement, Eurocopter, a French-German company, stated that it too was seeking funding for a civil tilt rotor project.

As a commuter aircraft operating in a growing worldwide short-haul commuter market, the BA 609 can operate to/from vertiports or conventional airports and will go a long way toward relieving congestion and delays at many of the world’s major airport hubs. The BA 609 will be breaking new ground (or should we say “new air”) in aviation.

CTRDAC

The development of the V-22 Osprey and the initiation of flight testing provided the encouragement needed by tilt rotor advocates to press for a civil application of this new aircraft type. Earlier FAA- and NASA-funded studies, managed by Dr. John Zuk of NASA Ames, showed that the tilt rotor aircraft had potential worldwide market application and could be economically beneficial to the manufacturers as well as the operators. In late 1992, results were brought to the attention of members of Congress who directed Secretary of Transportation Samuel (Sam) Skinner to establish a Civil Tiltrotor Development Advisory Committee (CTRDAC) to examine the costs, technical feasibility, and economic viability of developing civil tilt rotor aircraft (CTR). The CTRDAC was to also consider

issues associated with the integration of CTR aircraft into the national transportation system and assess the resulting national economic benefits. Furthermore, the Committee was charged with determining the required additional research and development, the needed regulatory changes to integrate the CTR into the transportation system, and how the CTR aircraft and related infrastructure development costs should be allocated between Government and industry.

The members appointed to the CTRDAC represented a broad spectrum of private and public sector agencies, companies, and associations, as well as the Department of Transportation (DOT), the National Aeronautics and Space Administration, and the Department of Defense. The chair of the CTRDAC was Frank E. Kruesi, Assistant Secretary for Transportation Policy (DOT). Among the 31 committee members were Dr. Hans Mark of the University of Texas (UT) (previously Director of the NASA Ames Research Center and later Chancellor of the UT), and Webb Joiner, president of Bell Helicopter Textron, Inc.

The findings of the Committee issued in December 1995 stated that the CTR is technically feasible and can be developed by the U.S. industry. However, additional research and development and infrastructure planning are needed before industry can make a CTR production decision. Furthermore, under the assumptions made during the study, it was concluded that a CTR system could be economically viable and could operate profitably without Government subsidies in heavily traveled corridors. The CTR, the Committee found, could reduce airport congestion, create jobs, and have a positive impact on the balance of trade.

The Committee recommended the creation of a public/private partnership to address CTR infrastructure issues and the initiation of associated planning. Work should begin, they stated, on regulatory and certification issues and on changes to the air traffic control system to safely and effectively use the capabilities of the CTR. In addition, the CTRDAC recommended that an integrated CTR aircraft and infrastructure research, development, and demonstration program should be conducted and the costs for this should be shared by the Government and industry.

In response, elements of work suggested by the CTRDAC have been included in the NASA rotorcraft program that are consistent with the NASA aeronautics technical thrusts.

FUTURE TILT ROTOR AIRCRAFT

By the early 1990s, an extensive tilt rotor data base had been developed from the Bell and Government XV-15 flight test activities. The larger military V-22 tilt rotor aircraft, which was designed using methodology validated with the XV-15 data, was well under way and was showing promise of meeting important performance goals. Also at that time, NASA's investigation of technical solutions to the growing air transport system congestion problems led to the identification of the tilt rotor aircraft as a part of the solution. However, significant advancements in

several technology areas would be required before the tilt rotor aircraft could be accepted as a civil transport. To address these “barrier issues,” researchers at the Ames, Langley, and Lewis Research Centers, led by Bill Snyder of Ames, developed a comprehensive effort called the Advanced Tiltrotor Transport Technology (ATTT) Program to develop the new technologies.

The research, started in 1994, was to be conducted as an element of NASA’s Advanced Subsonic Technology Program. Due to funding limitations, the initial research activity, the Short-Haul Civil Tiltrotor (SHCT) Program (a subset of the ATTT Program), was restricted to issues of primary concern, noise and safety. The noise investigations focused on the reduction of the sound levels generated by transport-size tilt rotor aircraft while operating to and from downtown vertiports of major metropolitan areas. Community and regulatory acceptance requires much lower noise levels for this environment than is generated using V-22 technology. The research activity included the development of refined acoustics analyses, the acquisition of wind tunnel small- and large-scale proprotor noise data to validate the new analytical methods, analytical and wind tunnel investigations of innovative proprotor and blade configurations designed to reduce the most disturbing content of the noise signature, and flight tests to determine the effect of different approach profiles on terminal area and surrounding community noise. The Boeing and Bell Helicopter Companies, McDonnell Douglas Helicopter Systems, and the Sikorsky Aircraft Company, participated in the noise investigations. Mike Marcolini was the lead researcher at Langley Research Center for many of these efforts.

The safety effort was related to the projected need to execute approaches to and departures from confined vertiports. For these conditions the capability to operate safely with one engine inoperative (OEI) would be required and a safe/low pilot workload (referred to as Level 1 handling qualities by the FAA) must be maintained under adverse weather conditions. This area was addressed by conducting engine design studies seeking the ability to produce high levels of emergency power in the event of an OEI condition without adversely impacting weight, reliability, maintenance, or normal operation fuel economy. These studies were conducted by Allison, Allied Signal and General Electric under the technical guidance of Joe Eisenberg of Lewis Research Center (LeRC). Further safety investigations involved piloted simulations at the Ames Vertical Motion Simulator (VMS) to assess crew station issues, control law variations, advanced configurations such as the variable diameter tilt rotors, and terminal area approach path profiles including nacelle position variations. Bill Decker of Ames was the principal investigator for the simulation efforts.

As the SHCT Program nears the scheduled 2001 completion date, a new follow-on research effort is being developed by NASA to apply and evaluate relevant technologies that emerged during the SHCT activity. One key area of interest is the feasibility evaluation of Simultaneous Non-Interfering (SNI) terminal area

operations. SNI operations are expected to increase the capacity of existing airports by allowing VTOL tilt rotor transport aircraft to takeoff and land using terminal area flight paths separate from that used by the fixed-wing transports. Furthermore, if short-haul aircraft utilize the SNI operations and are thereby removed from the runway queue, the larger capacity long-range aircraft would occupy the limited slots, thereby increasing the number of passengers that can be transported on existing airport runways. The planned research would identify the technologies and procedures needed for the aircraft and Air Traffic Management (ATM) system to obtain maximum aviation system benefits. The evaluations would involve the use of piloted simulations and flight tests, employing helicopters to represent the tilt rotor aircraft in near-terminal area operations. A separate program element includes ATM systems integration work and addresses adverse weather operations (such as icing conditions). This effort also deals with the automated cockpit and will examine methods of maintaining safe control during emergencies.

A new element of this follow-on activity is focused on Variable Diameter Tilt Rotor (VDTR) technology. This tilt rotor variant, being developed by Sikorsky, employs a proprotor system that provides a larger diameter and lower disc loading for higher efficiency in hover and low speed helicopter mode flight and, by the use of a blade retraction mechanism, a smaller diameter "prop" for airplane mode flight. The lower disc loading also contributes to safety by improving OEI performance and, if lower tip speeds were employed, would reduce the noise level. The planned five-year VDTR effort would address full-scale system design, system integration and reliability and would be conducted with shared funding by the Government and the contractor.

Additional investigations planned for this initiative address the application of conformable proprotor blade technology or other advanced proprotor designs to improve performance and reduce noise. The selected system would be wind tunnel and flight tested to validate predictions. The last major element deals with economic viability and passenger comfort issues. These issues include the improvement of high speed performance by reducing wing thickness while maintaining the required stability margins, the reduction of proprotor/airframe interaction losses, and the development of methods to control interior noise and reduce cabin vibrations.

In a more aggressive effort developed in response to the CTRDAC recommendations, NASA planners have proposed the advanced technology demonstrator tiltrotor aircraft program. This program carries some of the vehicle technology proposed in the SHCT follow-on program to flight demonstration with a highly modified V-22 Osprey. To accomplish this high cost program, it is expected that Government and industry would participate and cost share in order to make it affordable. While support for funding major new programs is usually difficult to obtain, Army planners have cited possible applications for the large tilt rotor aircraft technologies being considered here in their joint transport rotorcraft (JTR)

program (for a CH-47 helicopter replacement) and in the recent “Army After Next” study of future Army tactics and related technology.

The rest of the tilt rotor aircraft story begins now. The dream has become a reality.

Document 5-50

J. C. Narramore, “Advanced Technology Airfoil Development for the XV-15 Tilt-Rotor Vehicle,” presented at AIAA/NASA Ames VSTOL Conference, 7–9 December 1981, Palo Alto, CA, copy in Technical Library, NASA Langley.

As indicated in Document 5-49 (c), one of the major concerns in the U.S. Army/NASA Tilt Rotor Research Aircraft (TRRA) program involved some serious deficiencies that came to be identified in the XV-15's proprotor blades. Bell had designed these blades in the late 1960s, at a time when the target prototype weighed some 600 pounds less than the 13,000-pound XV-15. This difference in weight alone spelled danger. It meant that the blades had extremely high loadings, forcing them to operate perilously close to aerodynamic stall. When operating in hover while carrying a lot of weight, the machine did not have an adequate reserve of thrust from its rotors, threatening a fatal loss of control. Another issue for the XV-15 original proprotor blades was that they had been made out of bonded metal. Flight experience indicated that there might be some serious dangers due to deterioration of the blades' structural integrity. By 1980, it was clear to all concerned that the XV-15's blades needed to be replaced. As a result, NASA and the Army established the Advanced Technology Blade (ATB) project to design, build, and test superior proprotor blades, ideally a set made from one of the new “composite” materials.

The course of this program has been reviewed previously in Document 5-49. A more detailed look into the results of this airfoil program is provided below, in this 1989 AIAA/NASA paper by J. C. Narramore, Specialist Engineer, Aerodynamic Technology, at Bell Helicopter Textron in Fort Worth, Texas. In it, Narramore reported on how his company sought to take advantage of recent advances in airfoil design technology to develop optimized airfoil sections for the new composite-material blade that Bell, the Army, and NASA wanted to use to enhance the performance of the XV-15. In a test program involving a competitive “fly-off” between 13 candidate airfoil sections, Narramore and his associates at Bell found that advanced technology airfoils did, in fact, result in some improved aerodynamic characteristics compared to the blades that the XV-15 had been using. These improvements included increased maximum-lift capability of the rotor blades, which had been “the first priority goal” of the test program. Secondary goals involving low-drag performance, drag divergence Mach number, and maximum lift-to-drag ratios were also satisfied. In his “Summary,” Narramore indicated that use of the advanced technology airfoils should increase the maximum thrust by 16 percent and the propeller efficiency by 5 percent.

Document 5-50, J. C. Narramore, "Advanced Technology Airfoil Development for the XV-15 Tilt-Rotor Vehicle," presented at AIAA/NASA Ames VSTOL Conference, 7-9 December 1981, Palo Alto, CA.

ABSTRACT

An extensive airfoil design, analysis, test, and evaluation effort has been carried out for a new XV-15 tilt-rotor blade. State-of-the-art analysis and design computer programs were used to produce sections specifically for the aerodynamic and geometric design goals and constraints at four radial stations on the blade. A two-dimensional wind tunnel "competitive fly-off" test of thirteen candidate sections was conducted. The test results confirmed that airfoils designed using new state-of-the-art technology provide significant improvements in aerodynamic characteristics compared to existing XV-15 airfoils.

INTRODUCTION

The XV-15 is a proof-of-concept VTOL vehicle that has satisfied all of its performance goals. However, advances in the state of the art in aerodynamics, dynamics, and structures suggest that the flight envelope of this tilt-rotor vehicle can be expanded by an improved rotor blade design. Studies indicated that improvements in the airfoil performance characteristics could provide the most significant increases in aerodynamic performance.

Four major aircraft performance improvement objectives were established. These included improvements in maneuverability in helicopter mode, propeller efficiency in the airplane cruise mode, speed with minimum compressibility drag build up on the rotor blades in airplane mode, and hover performance in helicopter mode. Therefore, an effort to design improved airfoils that would satisfy these goals for the XV-15 tilt rotor vehicle was carried out. After a theoretical evaluation of many candidate sections, thirteen two-dimensional wind tunnel models were built and tested. The best of these airfoils were selected and compared to the existing XV-15 airfoils.

An overview of the design approach and performance comparisons between existing and new technology airfoils for the XV-15 is presented here.

OBJECTIVE

The objective of this study was to take advantage of recent advances in airfoil design technology to develop optimized sections specifically for four different radial stations on a new composite blade for the XV-15.

TECHNICAL APPROACH

In order to accomplish this goal, design criteria were established based on the desired flight envelope. From these blade conditions, the airfoil performance goals were established to provide XV-15 performance improvements at the critical conditions in its flight envelope. These criteria were then used to develop new advanced technology airfoils specifically for the XV-15.

A multifarious approach was taken for this problem to assure that an optimal design would be produced. In addition to the Bell in-house design study, three separate contracts were let by Bell for XV-15 airfoil design. Two of these contracts went to the Vought Corporation and one went to the General Aviation Airfoil Design and Analysis Center at Ohio State University. Each organization used a different approach to the design. The Vought Corporation derived applicable sections from the recently developed NASA supercritical, mid-speed, and low-speed airfoils. The General Aviation Airfoil Design and Analysis Center (GA/ADAC) developed airfoils by using a superposition of thickness and camber. At Bell, two different approaches were taken. Some of the Bell sections were designed using the Airfoil Design and Analysis Methodology (ADAM) system airfoil design method, while some were defined [*sic*] using a manual iterative-direct refinement method.

THE ADAM SYSTEM

The Airfoil Design and Analysis Methodology (ADAM) is a synergistic, modern information system that incorporates the latest data base management, data processing, and aerodynamic technology into a user friendly design tool. The overall objective of this system is to provide the maximum amount of information to the design process in the minimum amount of time. It is composed of several components designed to eliminate the manual tasks and computer printouts usually associated with design studies. Within the system are both subsonic and transonic design routines and several state-of-the-art analysis codes. The system is data-base oriented, and results from theoretical analysis or wind-tunnel tests can be stored and retrieved for plotting. All of the capabilities combine to form a very useful tool that greatly increases productivity.

ADAM SYSTEM DESIGN APPROACH

The airfoil designer is given the task of producing the best section that will satisfy a set of performance requirements.

These requirements may include aerodynamic specifications such as low drag at specified lift values, high drag divergence Mach numbers, low pitching moments, high maximum lift, and gentle stall characteristics. Geometric specifications may

include maximum thickness, nose radius, trailing edge thickness, and thickness distribution for structural and manufacturing considerations.

Figure 1 [*not reproduced*] depicts the types of design procedures currently used to obtain airfoils with specified characteristics.

With iterative-direct and geometric optimization techniques, an initial airfoil is selected and analyzed to determine its aerodynamic characteristics. The results are compared to the requirements, and if they are not satisfied, the shape of the airfoil is modified. This procedure is repeated until the requirements are met and the design is complete.

With an inverse airfoil design procedure, an initial estimate for the velocity distribution is made and the resulting airfoil determined. The aerodynamic characteristics are determined and compared to the requirements. If they are not satisfied, the velocity distribution is modified; this process is repeated until all of the requirements are met. The problem with all of these procedures is that they require a large number of iterations that must be performed by hand or by complex computer programs.

A desired procedure is one in which no iterations occur as depicted in Figure 2 [*not reproduced*]. First, the velocity distribution that will satisfy the design requirements is determined; this is used as the input to an inverse program to determine the airfoil shape.

The approach taken in ADAM to approximate this procedure is to assume generalized equations for the velocity distribution along the perimeter of the airfoil. This technique has been used by Liebeck, Narramore, and Powers and Sattler to generate airfoils for a wide variety of applications. Advantages of using equations for the velocity distribution stem from the fact that it minimizes the input (since only a few coefficients are used), allows for fast evaluation of lift, moment, etc., by direct integration and thus minimizes the number of design iterations. Families of velocity distributions are evaluated to determine which apportionment on the airfoil will best satisfy the performance requirements. The best velocity distribution is then used as the input to an inverse airfoil procedure to determine the airfoil shape. The ADAM system subsonic design and transonic design methods, which have proven to be fast-practical design tools, use this approach.

During this design study, only the subsonic design method was operational and experimentally validated. This method was used to design three airfoils of 28 percent, 18 percent and 12 percent thicknesses to satisfy the design goals.

SPECIFIC DESIGN GOALS

All of the designers were assigned the same task: Develop four airfoils[,] one each for the 0.25, 0.5, 0.75, and 1.0 r/R blade radial stations. Table 1 represents the design objectives and priorities established for airfoils at these radial stations based on the flight conditions of the XV-15. The maneuverability in helicopter mode at

40 knots is limited on the current blade. This is due to the fact that the retreating blade of the current XV-15 is stalling at this condition. Therefore, the first priority goal for the new airfoils was to increase the maximum lift. The second priority for the new sections was to maintain the low drag characteristics of the existing sections at the 300 KTAS at 20,000-foot flight condition. This is to maintain at least the same propulsive efficiency in airplane cruise mode as the existing XV-15 blade. Third in priority was the drag divergence Mach number for the high-speed airplane cruise condition. It was established to allow for speeds [of] up to 350 KTAS at 20,000 ft. without compressible divergence drag on the rotor blades. A final priority was established for the hovering helicopter condition. This can be interpreted as a high lift/drag ratio requirement for the new airfoils at the hover flight conditions at their respective blade stations.

Constraints on the thickness and maximum pitching moment were also imposed upon the design problem.

THEORETICAL EVALUATIONS

In order to select the best candidates to be tested, an extensive theoretical evaluation of candidate sections was carried out using the ADAM system. The baseline airfoils to which the new airfoils were compared were the NACA 6-series airfoils that are on the current XV-15 metal blade.

The ADAM system contains several state-of-the-art airfoil analysis codes. During the design and evaluation phase, both transonic and subsonic, analysis programs were exercised to assess the candidate airfoils. Many airfoils were examined for their applicability on the new blade and thirteen candidate airfoils were selected for testing based on the theoretical calculations.

WIND TUNNEL TEST

Fifteen wind-tunnel models, including two baseline comparison airfoils, were built and tested in the two-dimensional channel insert of the United Technologies Research Center's Large Subsonic Wind Tunnel. The models ranged in chord length from 12 to 18 inches to ensure that the test Reynolds number and Mach number combinations would be very close to the actual flight conditions that will be experienced on the new blade. They were numerically machined and equipped with 59 pressure taps distributed on the upper and lower surfaces of the sections.

Lift, drag, and pitching moment aerodynamic performance data were acquired for a series of Mach numbers up to 0.81 at low angles of attack, and at angles of attack up to 34 degrees at low Mach numbers. For each model, emphasis was placed on combinations of Mach number, Reynolds number, and angle of attack for which the airfoil was designed. Sufficient data to complete a helicopter performance airfoil data table were acquired for all of the candidate sections.

TEST RESULTS

Figure 3 [*not reproduced*] depicts the airfoils that were tested and indicates their respective region of applicability on the blade. It should be noted that for each radial station there were several candidate sections. This was done to facilitate a “fly-off” between the best candidate sections. Therefore, actual test data could be used to determine the best airfoil for each category.

Cross plots of the wind-tunnel data for the candidate sections were generated, and a thorough evaluation of the measured performance was carried out.

Since there were several candidate airfoils for each station and no single section was best in all priorities established, a systematic method was utilized to select the final airfoil from the candidate sections. A weighted sum index was determined for each airfoil in the respective categories. This allowed the effectiveness of each airfoil in all the performance areas to be determined by a single consolidated number and allowed the final airfoil at each station to be selected in a consistent manner.

The best performing airfoils were chosen as the sections for the proposed blade. The airfoils selected by this process are designated the XN28, XN18, XN12, and XK08 sections.

It should be noted that airfoils designed by the ADAM system provided high performance at every station for which it produced a candidate. As an example of the efficiency obtained by using this method, the best 12 percent airfoil was designed in one week using the ADAM system subsonic design method.

PERFORMANCE IMPROVEMENTS

In order to evaluate the gains that can be anticipated by using the advanced technology airfoils, a direct comparison of the wind tunnel test results for the new sections and the NACA 6-series airfoils, which are on the existing XV-15 blades, was carried out. Again, emphasis was placed upon the design requirements and priorities shown in Table 1 [*not reproduced*].

25% RADIAL STATION

Figure 4 [*not reproduced*] shows a comparison of the 64-(5.7)27 $a = 0.3$ (Sta 28 on the XV-15) test data to the new technology XN28 airfoil data. This 6-series airfoil is designated 64-X27 here for convenience. The advanced technology airfoil (XN28) produces a maximum lift that is 36 percent higher than the existing XV-15 airfoil (64-X27). The drag at zero lift is 13.5 percent lower for the XN28 than the 64-X27. Also, the maximum lift-to-drag ratio is increased 126 percent by using the new airfoil. These significant improvements can be attributed to the fact that the ADAM system subsonic design method was used to design the XN28 specifically for the XV-15 operating conditions at 0.25 r/R while the 64-X27 was scaled from an airfoil, designed for other conditions, that was much thinner than 27 percent.

50% RADIAL STATION

A comparison of the XN18 and the NACA 64-118 $a = 0.3$ performance characteristics at a hover Mach number condition is given in Figure 5 [not reproduced]. The 64-118 $a = 0.3$ is located at Station 75 on the current XV-15 blade. Maximum lift of the advanced technology airfoil is 15 percent higher than the 64-118. The drag coefficient at zero lift of the two sections is identical. However, the low drag range of the XN18 is much wider than the 64-118. The maximum lift-to-drag ratio of the new section is 23 percent higher than the existing XV-15 blade section.

Figure 6 [not reproduced] shows the drag as a function of Mach number at a lift coefficient of 0.0. The new section provides an increase in drag divergence Mach number of .005. The XN18 was designed using the ADAM system design model.

75% RADIAL STATION

The 0.75 r/R station exhibits characteristic aerodynamic properties of the blade in hover. The existing airfoil on the XV-15 at Station 112.5 is NACA 64-(1.5)12 $a = 0.3$ airfoil. For convenience, it will be designated 64-X12 here. Figure 7 [not reproduced] shows the comparative performance of an advanced technology airfoil developed using the ADAM system to the 64-X12 at a hover condition. Again, significant aerodynamic improvements are obtained.

The maximum lift for the XN12 is 14 percent higher than the 64-X12. Drag at 0.2 lift coefficient is equivalent for the XN-12 and the 64-X12, and the XN12 has a much larger low drag range. The maximum lift-to-drag ratio has been increased by 25 percent over the 64-X12. All of this was accomplished with no increase in pitching moment of the XN12 over the 64-X12. The drag rise characteristics of these airfoils at a lift coefficient of 0.2 are shown in Figure 8 [not reproduced]. It indicates that the new section will have a drag divergence Mach number that is .031 higher than the 6-series section.

100% RADIAL STATION

The tip section of the current XV-15 is a NACA 64-208 $a = 0.3$ airfoil. Figure 9 [not reproduced] illustrates the performance differences of the 64-208 and the XK08 airfoil at a hover blade condition. The XK08 airfoil was designed by a manual iterative-direct refinement technique utilizing results from the Garabedian-Korn transonic program. Maximum lift of the XK08 is 9 percent higher than the 64-208. At a lift coefficient of 0.3, the drag of the new section is equivalent to the 64-208. However, the maximum lift-to-drag ratio for the XK08 is 26 percent higher than the 64-208. Figure 10 [not reproduced] gives the drag as a function of Mach number for the two 8 percent thick sections. It shows that the new section may have some drag increase due to a shock on the lower surface at the nose at the design lift coefficient of 0.3.

SUMMARY

Figures 11, 12, 13, and 14 [*not reproduced*] give a summary of the results of the new airfoils compared to the existing XV-15 airfoils and the design goals.

The maximum lift as a function of the radial station where each section applies is shown in Figure 11. In this figure, a curve is faired between the results for the airfoils for the existing, design goal, and realized maximum lift coefficient at a retreating blade condition. It indicates that the new sections provide a substantial increase in the maximum lift capability over the 6-series sections. This was the first priority goal.

The second priority was to maintain the low-drag characteristics of the existing 6-series airfoils at the cruise Mach number and local lift coefficient. Figure 12 gives the drag of the existing section (which was the desired level) and the drag of the advanced technology sections at this condition. In this case, the drag is lower for the .25 and .75 r/R radial stations but is slightly higher than the 6-series sections at the .5 and 1.0 r/R radial stations.

The drag divergence Mach number was the third priority goal. For this characteristic, the goal was to obtain a drag divergence Mach number for the airfoil that was higher than the local blade value at a speed of 350 knots. Figure 13 shows the goal, the existing airfoil results, and the new technology airfoil results. The new technology sections exceeded the desired results at all stations except the tip.

Maximum lift-to-drag ratio at the hover condition was the final airfoil design goal. Figure 14 shows the differences between the values obtained from the existing airfoils, the desired values, and the values obtained by using the advanced technology sections. It can be seen that the new sections maintain maximum lift-to-drag ratios of over 100 while the 6-series sections only provide maximum values in the 80's.

When the advanced technology airfoils are applied to the current blade configuration, forward flight and hover helicopter performance predictions indicate that the advanced technology airfoils increase the maximum thrust by 16 percent and increase the propeller efficiency by 5 percent beyond the current 6-series airfoil levels.

CONCLUDING REMARKS

An intensive airfoil development study has been carried out for the XV-15 tilt-rotor vehicle. State-of-the-art design techniques were used to produce the new sections, and a wind tunnel "fly-off" between the best airfoils was held. Advanced technology airfoils demonstrated significant improvements in aerodynamic characteristics compared to existing XV-15 blade airfoils.

Document 5-51

**Michael K. Farrell, Bell Helicopter Textron, Fort Worth, TX,
“Aerodynamic Design of the V-22 Osprey Proprotor,”
presented at the 45th Annual Forum of the American
Helicopter Society, Boston, MA, 22–24 May 1989,
copy in Technical Library, NASA Langley.**

First flown experimentally on 19 March 1989, two months before this American Helicopter Society presentation by Bell Helicopter engineer Michael K. Farrell, the V-22 Osprey tilt-rotor ranks as the first aircraft designed from the ground up to meet the needs of all four U.S. armed services. Not only was it meant to transport Marine Corps assault troops and cargo using its medium-lift and vertical takeoff and landing capabilities, but it also met U.S. Navy requirements for combat search and rescue, fleet logistics support, and special warfare support. It was also designed to be used by Special Operations Forces. As it moved through its development in the late 1980s and 1990s, the V-22 demonstrated that it could carry 24 combat troops, or up to 20,000 pounds of internal or external cargo—and at twice the speed of a conventional helicopter. A partnership between Boeing and Bell Helicopter Textron produced this unique aircraft, with Boeing responsible for its fuselage and all subsystems, digital avionics, and fly-by-wire flight-control systems, and Bell for the wing, transmissions, empennage, rotor systems, and engine installation.

By the late 1990s, the Osprey had set unofficial world records for rotorcraft for carrying very heavy loads at very high speeds. In April 1999, for example, one of the Ospreys demonstrated this weight-lifting capability by externally lifting a new 155-millimeter howitzer, one that weighed about 9,200 pounds. Never before had any rotorcraft ever carried such a heavy load externally, especially at speeds of up to 220 knots. During the course of its flight testing, the V-22 also demonstrated that it flew with such stability that it could successfully hook up to an aerial refueling drogue behind a KC-130 tanker. In the view of its proponents, this in-flight refueling capability would permit the V-22 to deploy worldwide. Beyond that, flight tests demonstrated its great effectiveness in landing in confined areas during both day and night and operating tactically at low altitudes over complicated terrain. The Osprey could dispense flare decoys and radar-defeating chaff, which greatly enhanced its chances of survival in threatening environments. In airplane mode, the V-22 proved that it could sustain flight at altitudes of only 500 feet above ground level (AGL) and at only 200 feet AGL while “partially converted,” i.e., with engine nacelles rotated between airplane and hover mode. In the view of military test pilots who flew the machine, these tactical abilities would prove critical to V-22 pilots as they flew during missions to avoid detection and take

advantage of the element of surprise. Ten different V-22s had flown experimentally by the late 1990s, with the test fleet compiling over 2,000 flight-test hours during over 750 flights.

So happy was the U.S. Department of Defense with the V-22 by September 1999 that it hosted a Tiltrotor Technology Presentation on the Pentagon's River Entrance parade ground to demonstrate the capabilities and versatility of its tiltrotor. Speaking at the event, then-Secretary of Defense William Cohen asserted:

Every few decades of this century the world has witnessed the arrival of weapons platforms that have truly revolutionized national security. The powerful and innovative aircraft that you see here today, the tiltrotors, will have just that effect in the coming century. They are going to revolutionize not only our force projection, they are going to transform the entire way that America conceives and sustains its policy of engagement in the decades ahead.... Every major study and major review of the future capabilities have pointed to the need for exactly this type of capability.... The V-22 represents a design that combines efficiency with flexibility; it provides greater survivability so that our pilots and airmen can return home safely. The V-22 is going to cut our response times from weeks down to days and days down to hours. These aircraft can fly twice as fast, twice as high, and two to five times farther than the traditional helicopters—everything from assault operations to disaster relief and humanitarian aid, and peacekeeping. (Quoted in Boeing News Release 99-151, "Tiltrotor Technology Demo Day—MV-22 Makes Public Debut at Pentagon," 10 September 1999, at <http://boeing.mediaroom.com/1999-09-10-Tiltrotor-Technology-Demo-Day-MV-22-Makes-Public-Debut-at-Pentagon>)

Clearly, the Defense Secretary felt that the V-22 represented a revolution in military affairs.

Based on the successful completion of sea trials on the U.S.S. Saipan in August 1999, the Navy planned to procure a fleet of 48 HV-22Bs and quickly deploy them for combat search and rescue, special warfare, and logistics support. The U.S. Air Force planned to have 50 CV-22s, an Air Force special operations variant. And the U.S. Marine Corps announced that it would purchase 5 CV-22s and hoped to have 360 of the machines in service by 2013. In January 2000, a group of Marines from the 2nd Reconnaissance Battalion II Marine Expeditionary Force (MEF), Camp Lejeune, North Carolina, jumped into the history books of V-22 developmental testing when they made the first-ever parachute jumps from a tilt-rotor aircraft, deploying from an MV-22 in free fall from 10,000 feet. The Marines made 24 successful jumps, thereby qualifying the V-22 for parachute service. The jumpers landed in a surveyed drop zone at Fort A.P. Hill, Virginia, an Army base near the Patuxent River. Tragically, a group of Marines died on board an MV-22B when it

crashed near Tucson, Arizona, on 8 April 2000. As our manuscript went to press, the Pentagon still had not determined the cause of the accident.

There is no reason, however, to speculate that the cause of the accident had anything to do with the Osprey's basic aerodynamic design. More than 10 years of developmental research and flight testing has confirmed the basic findings reported by Bell's Michael Farrell in 1989. Though the design of an effective tilt-rotor aircraft—one that takes off and lands like a helicopter but, once airborne, rotates its engine nacelles to convert the aircraft to a turboprop airplane capable of high-speed, high-altitude flight—faces many challenges, the V-22 has very successfully met and exceeded its design goals.

Document 5-51, Michael K. Farrell, Bell Helicopter Textron, Fort Worth, TX, "Aerodynamic Design of the V-22 Osprey Proprotor," presented at the 45th Annual Forum of the American Helicopter Society, Boston, MA, 22–24 May 1989

ABSTRACT

This paper describes the aerodynamic design of the V-22 Osprey proprotor in terms of design objectives, design parameters, and design verification. During the development of the proprotor, the three design objectives were a hover Figure of Merit of 0.8, a propulsive efficiency of 0.8, and a maximum proprotor blade loading or t_c of 0.4. Based on these design objectives and in conjunction with performance, operational, and service constraints, the diameter, number of blades, tip speed, airfoil, twist, chord, taper ratio, and spinner configuration were selected. These design parameters were verified by means of numerous small and large scale model tests.

NOTATION

b	number of proprotor blades
c	proprotor chord, ft
C_d	drag coefficient, d/qS
C_e	proprotor thrust weighted equivalent chord, $(\int_{x=0}^{x=1} cX^2 dX)/(\int_{x=0}^{x=1} X^2 dX)$
C_l	lift coefficient, l/qS
C_m	pitching moment coefficient about the quarter chord, pm/qSC
C_p	proprotor power coefficient, $(550 \text{ RSHp})/(\rho\pi R^2(\Omega R)^3)$
C_{pp}	propeller power coefficient, $(550 \text{ RSHp}_n^3)/(4\rho R^2(\Omega R)^3)$
C_t	proprotor thrust coefficient, $T/(\rho\pi R^2(\Omega R)^2)$
d	drag, lb
g	aircraft normal load factor
F.M.	proprotor figure of merit, $(1/\sqrt{2})(C_t^{3/2}/C_p)$

J	propeller advance ratio, $(1.688\pi V)/(\Omega R)$
l	lift, lb
L/D	lift/drag ratio
M	Mach number
M_{dd}	drag divergence Mach number
pm	pitching moment, ft lb
q	dynamic pressure, lb/ft ²
R	proprotor radius, ft
r/R	non-dimensional proprotor radius
RSHP	proprotor shaft horsepower, hp
S	airfoil reference area, ft ²
t/c	airfoil thickness to chord ratio
T	proprotor thrust, lb
t_c	blade loading coefficient, $2C_t/\sigma T$
η	airplane mode propulsive efficiency, $J(C_{tp}/C_{pp})$
σ_T	proprotor thrust weighted solidity, $(bC_c/\pi R)$
σ'	non-dimensional air density ratio
ρ	air density, slugs/ft ³
ΩR	proprotor tip speed, ft/sec

INTRODUCTION

The V-22 Osprey is a tilt-rotor aircraft being developed for use by the United States Marine Corps (USMC), the United States Navy, and the United States Air Force. Six aircraft are currently in various stages of fabrication and testing as part of the Full Scale Development (FSD) Program contracted to Bell Helicopter Textron Inc. (BHTI) and Boeing Helicopter Company (BHC). First flight of V-22 took place on March 19, 1989, at BHTI's Flight Research Center in Arlington, Texas, as shown in Figure 1 [*not reproduced*]. Flight testing of the first aircraft is continuing to expand the flight envelope. The V-22 is expected to enter into full scale production in the 1990s.

The V-22 is characterized by two 38-foot, three-bladed proprotors located on the tips of the wing. Located in each nacelle is a transmission and a 6150 horsepower turboshaft T406-AD-400 Allison engine. The proprotors are synchronized by means of an interconnect shaft that runs through the wing between the nacelles. This shaft provides power to both proprotors for single-engine operation. The nacelles can be tilted from 97.5 degrees to 0 degrees (airplane mode) enabling flight from a vertical takeoff and landing like a conventional helicopter, to high speed cruise flight similar to that of turboprop aircraft. The aircraft is 57.33 feet long and 84.57 feet wide (blade tip to blade tip). The normal operating weight of the aircraft is around 45,000 pounds with a VTOL capability of 55,000 pounds. A significant increase in payload/range is achieved by partially tilting the nacelles and

performing an STOL takeoff. For self-deployment missions, internal fuel tanks are provided for a gross weight of 60,500 pounds. The aircraft can fly at level speeds up to 320 KTAS at 14,000 feet on a hot day and can reach dive speeds of 345 KTAS. The Osprey has a full digital fly-by-wire flight control system and is capable of instrument flight, day or night, including moderate icing conditions. The airframe is constructed almost entirely of composite materials.

The mission requirements of the V-22 were a crucial factor in development of the aerodynamic design of the proprotor. The primary factor was the requirement to be shipboard compatible with LHA/LHD class ships. This required that the proprotors maintain a reasonable clearance from the ship's control island. In addition, both the wing and proprotor needed to be folded for storage aboard ship as shown in Figure 2 [not reproduced]. These dimensional constraints on width, height, and length were significant design drivers in the selection of the proprotor diameter, taper ratio, and spinner shape.

DESIGN OBJECTIVES

Three specific objectives were established during the proprotor design process. The first was to achieve a hover Figure of Merit of 0.8 at the design operating gross weight. Figure of Merit is used to evaluate hover efficiency by comparing the actual power required to produce a given thrust with the minimum possible power required to produce a given thrust. The equation is:

$$\text{F.M.} = \left(\frac{1}{\sqrt{2}} \right) \left(\frac{C_t^{3/2}}{C_p} \right) = \left(\frac{T}{550 \text{ RSHP}} \right) \left(\frac{\sqrt{\text{disk loading}}}{2\rho} \right)$$

As indicated in the equation, the larger the Figure of Merit for a given proprotor, the more efficient the proprotor is or the less the power required to produce a given thrust. Typical helicopter rotors have a Figure of Merit between 0.5 and 0.7, while tilt-rotors have between 0.7 and 0.8. Achieving a high Figure of Merit was considered essential because of its impact on payload and range capability. For example, for the basic V-22 mission, a 0.01 increase in Figure of Merit increases the payload and mission radius by approximately six percent. In addition, studies indicated that a Figure of Merit of 0.8 would satisfy the multimission requirements of the V-22.

The second design objective was to achieve an airplane propulsive efficiency of 0.8 at the design cruise speed. Propulsive efficiency is used in evaluating cruise efficiency in airplane mode and is a comparison of the useful power with the total power required to produce a given thrust. The equation is:

$$\eta = J \left(\frac{C_{tp}}{C_{pp}} \right) = \frac{\text{useful power}}{\text{total power}}$$

It will be discussed later that the design propulsive efficiency achieved was slightly less than desired in order to achieve the desired Figure of Merit. However, analysis showed that a small reduction in propulsive efficiency did not have as much impact on payload/range capability as Figure of Merit. For the basic mission, a 0.04 decrease in propeller efficiency decreases the payload or range of the V-22 by one percent, with a decrease in best range airspeed of one knot. The same 0.04 decrease in propeller efficiency reduces the maximum airspeed by five knots.

The third design objective was to have a maximum proprotor blade loading or $t_{c\max}$ of 0.4. Unlike a helicopter, the tilt-rotor can derive its maneuver capability from both the proprotor and the wing. The proprotor t_c :

$$t_{c\text{ proprotor}} = \frac{2T}{\rho\pi R^2(\Omega R)^2\sigma_T}$$

where T is the vertical component of the thrust.

To form an equivalent proprotor/wing t_c , the wing lift may be described as:

$$t_{c\text{ wing}} = \frac{gGW}{\rho\pi R^2(\Omega R)^2\sigma_T}$$

The combination of these two terms provides an equivalent t_c for the tilt-rotor. This equivalent t_c can be used to describe the maneuver capability or g capability of the tilt-rotor.

$$t_{c\text{ tiltrotor}} = \frac{2T + gGW}{\rho\pi R^2(\Omega R)^2\sigma_T}$$

As shown in Figure 3 (Reference 1), for the XV-15, the wing lift can be used to provide an additional 20 percent maneuver capability at 60 knots, a 36 percent improvement at 100 knots, and a 50 percent improvement at 130 knots. For the XV-15, $t_{c\max}$ has been measured at 0.36 (Reference 2). Based on being able to improve blade aerodynamics over the XV-15 proprotor, the objective for the V-22 was to provide a 10 percent improvement over the XV-15 proprotor's thrust capability. This resulted in a design objective of 0.4.

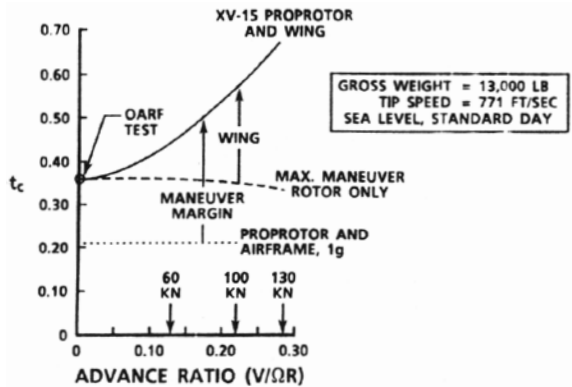

FIG. 3. XV-15 t_c capability.

DESIGN PARAMETERS

Seven design parameters were required to satisfy these design objectives. These were diameter, number of blades, tip speed, airfoils, twist, chord, and taper ratio. An additional parameter, blade root/spinner clearance, was also considered and found to be a significant performance parameter. The process of selection and verification of each item will be discussed.

DIAMETER

The first parameter selected in the matrix was the diameter. As mentioned, the V-22 is shipboard compatible and operates from LHA/LHD class ships. The diameter was therefore set by this constraint, as shown in Figure 4. Given the fuselage

width, width of the landing gear, distance between the proprotor and fuselage, [and] clearance required between the deck edge and the LHA island, the proprotor diameter was defined. The given dimensions were to provide a 12-foot 8-inch clearance between the proprotor and the LHA island, a 5-foot clearance between the main landing gear and the edge of the deck, and a 12-inch clearance between proprotor and the fuselage (when operating in airplane mode). Given these constraints, the maximum available proprotor diameter

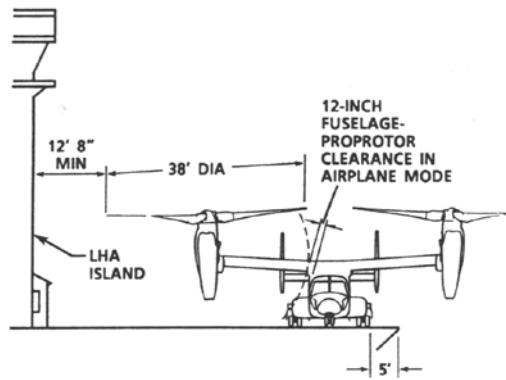

FIG. 4. Shipboard operational constraints on proprotor diameter.

was 38 feet. It was desirable to maximize the proprotor diameter from a hover standpoint to minimize the proprotor induced power, which makes up approximately two-thirds of the power required to hover.

NUMBER OF BLADES

Based on previous tilt-rotor designs, mainly the XV-3 and the XV-15, the three-bladed configuration was a known quantity in terms of dynamics. It was also determined that the three-bladed configuration was easily adaptable to meet the shipboard folding requirement. Based on these two criteria, the number of blades selected was three.

TIP SPEED

The next parameter selected was tip speed. To evaluate this parameter, trade studies of performance and acoustic noise levels were conducted. Figure 5 shows the variation of thrust with tip speed on maximum proprotor thrust at a constant power.

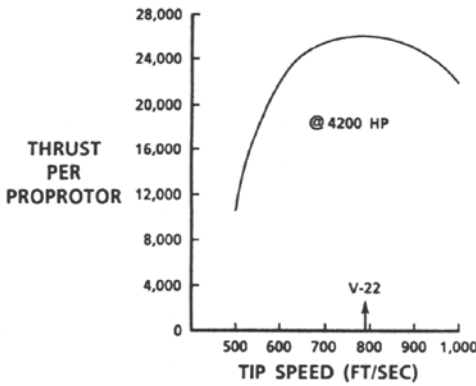

FIG. 5. Effect of proprotor tip speed on hover performance.

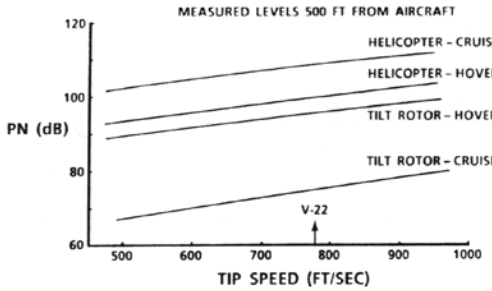

FIG. 6. Effect of proprotor tip speed on sound levels.

The calculations were made using Bell's lifting surface program, AR7906. Based on a blade element rotor model, this program uses a lifting surface theory with a circulation-coupled prescribed wake. The maximum thrust is achieved at tip speeds from 750 to 825 ft/sec. Thus, a tip speed in this region would provide the maximum hover thrust from the proprotor at a given horsepower.

One of the benefits of the tilt-rotor, due to its ability to tilt its nacelles with airspeed, is that it can have lower acoustic noise levels than a helicopter. Figure 6 presents sound levels measured from a typical helicopter as compared with those measured from the XV-15. The primary difference in the higher sound levels of the helicopter in hover is due to the sound created by the helicopter's tail rotor.

A maximum sound goal of 96 Pn dB was selected for the V-22 in helicopter mode. As previously mentioned, a high tip speed is desired for hover performance. This and the sound goal led to the selection of a tip speed of 790 feet per second for normal VTOL operation.

In airplane mode, the cruise efficiency of the tilt-rotor increases significantly when the tip speed is reduced from the hover tip speed. This allows the airfoil sections to operate at their optimum L/D . It also reduces compressibility on the blade tips. The reduction in tip speed also has a favorable effect on sound levels. Trade studies were conducted to determine the effect of tip speed on cruise airspeed,

service ceiling, specific range, and best range airspeed. As Figures 7 and 8 show, the tip speed required for maximum speed and maximum service ceiling is around 690 feet per second. The optimum for maximum specific range is around 500 feet per second, whereas the optimum for best range airspeed

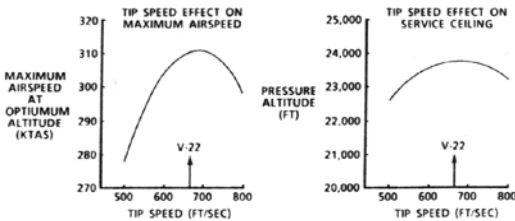

FIG. 7. Effect of proprotor tip speed on cruise performance.

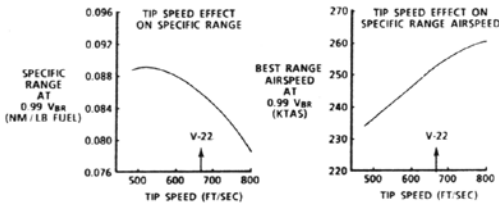

FIG. 8. Effect of proprotor tip speed on cruise performance.

occurs at approximately 800 feet per second. An average for these performance parameters would be about 670 feet per second. This tip speed was slightly modified because of dynamic frequency placement considerations. Studies showed that a tip speed of 662 feet

per second provided the best payload-range capability when the additional weight required for the dynamic frequency placement was considered.

AIRFOILS

During the selection of the airfoil sections, the goal was to provide a 15 percent overall improvement in maximum C_p , minimum C_d , maximum drag divergence Mach number, and maximum L/D as compared with the NACA 64-series airfoils used on the XV-15's proprotor. These goals are shown in Table 1 (Reference 3). Two design constraints were placed on the airfoil designs. These were the thickness ratios and the pitching moment coefficients, which were constrained by dynamic frequency placement and control system loads. Four airfoil sections were developed for the 0.25, 0.5, 0.75, and 1.0 blade radial stations. They were developed using the BHTI Aerodynamic Design and Analysis Methodology (ADAM) (Reference 4). A subsonic inverse design process, which is one of the options in the ADAM system, was used to design the airfoil sections. Numerous design iterations were performed with ADAM to optimize the performance at the critical design points. Four

TABLE 1. Proprotor airfoil design goals and constraints.

Radial Station r/R	Design Constraints		Aerodynamic Design Goals			
	t/C	Incomp. C_m	Maneuver (C_{lmax})	Cruise (C_d)	Max. Speed (M_{DD})	Hover (L/D) _{max}
1.0	0.08	-0.02	1.35 @ $M = 0.6$	0.006 @ $C_l = 0.3$ $M = 0.75$	0.81 @ $C_l = 0.3$	80 @ $M = 0.65$
0.75	0.12	-0.03	1.40 @ $M = 0.45$	0.006 @ $C_l = 0.2$ $M = 0.65$	0.72 @ $C_l = 0.2$	95 @ $M = 0.5$
0.50	0.18	-0.05	1.50 @ $M = 0.3$	0.006 @ $C_l = 0.0$ $M = 0.57$	0.64 @ $C_l = 0.0$	80.0 @ $M = 0.3$
0.25	0.28	-0.12	1.35 @ $M = 0.19$	0.006 @ $C_l = 0.0$ $M = 0.51$	0.59 @ $C_l = 0.0$	50.0 @ $M = 0.2$

airfoils that met the design goals were selected. Figure 9 shows theoretical analysis for the 12-percent-thick section that predicts the design goals would be met. The results for the other sections are similar. The final airfoil contours are compared with the NACA 64-series airfoils used on the XV-15's proprotor in Figure 10. An XN-28 was selected for the root region. It provided the structural volume required at the root to house the blade folding mechanism, yet still provided good aerodynamic performance. The XN-18 and XN-12 were selected for the working sections of the blade because they provided the desired performance as compared with the other designs studied. The XN-09 was selected for the tip region because it operates efficiently over the large angle of attack ranges in which the tip must operate.

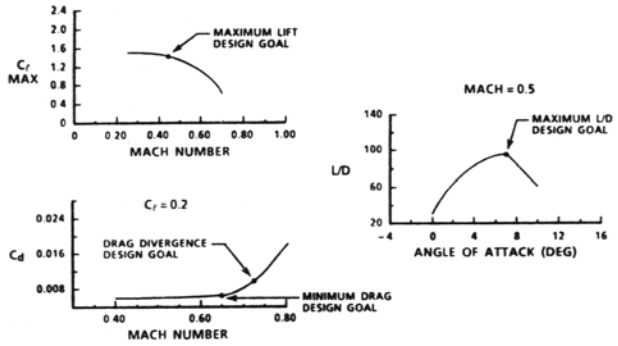

FIG. 9. Airfoil analysis.

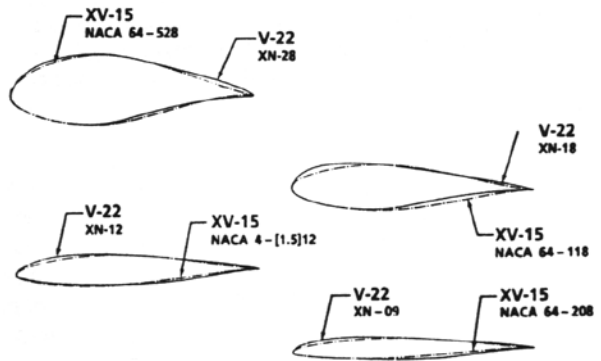

FIG. 10. Comparison of V-22 and XV-15 airfoil contours.

The XN-09 was selected for the tip region because it operates efficiently over the large angle of attack ranges in which the tip must operate.

It should be noted that the airfoils were designated using a Bell naming convention. In the case of the XN-28, for example, the XN signifies that the airfoil is a tilt-rotor design and 28 signifies that the airfoil has a thickness-to-chord-ratio of 28 percent.

CHORD AND TWIST

Selection of chord and twist distributions was based on a trade between Figure of Merit and propeller efficiency, as shown in Figure 11. The analytical proprotor models used to calculate the proprotor performance were two of BHTI's lifting surface programs, AR7906 (hover) and AR7907 (airplane).

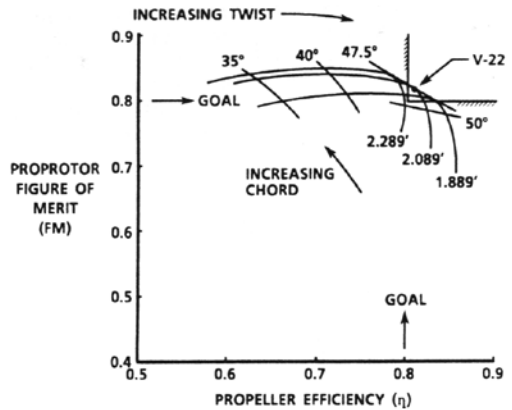

FIG. 11. Proprotor twist/chord tradeoff study.

The USMC Troop Assault Mission was used to define the operating conditions for calculating the Figure of Merit and propeller efficiency, shown in Figure 11. The Troop Assault Mission is representative of a typical V-22 mission. The analytical models used linear twist rates and thrust-weighted equivalent chords. By comparing variation in Figure of Merit with propeller efficiency, the optimum chord and twist was selected to meet both of the design goals. As expected, increasing blade chord produces an increase in Figure of Merit. Likewise, increasing twist increases Figure of Merit and the propeller efficiency. It is shown that increasing the twist past 47.5 degrees degraded both Figure of Merit and propeller efficiency. One can see from the plot that the chord and twist selections will be a compromise between hover and airplane modes. Based on this, a 47.5-degree twist was selected.

Once the twist magnitude was selected, the twist rate was optimized to produce a more uniform downwash distribution along the blade span. This was achieved by providing the optimum blade angle of attack along the blade radial stations based on momentum theory, as shown in Figure 12. The twist rate selected was a compromise between hover and cruise flight. Beyond the blade radial station of 0.75, the twist was biased toward hover in order to improve the Figure of Merit.

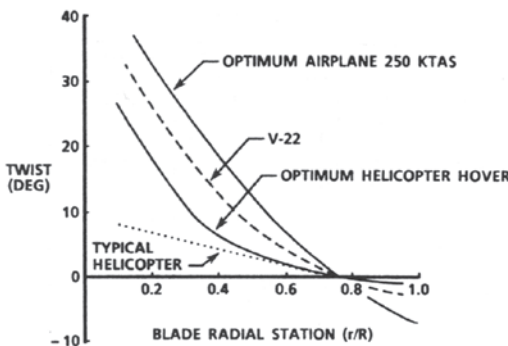

FIG. 12. Final nonlinear twist selection.

Beyond the blade radial station of 0.75, the twist was biased toward hover in order to improve the Figure of Merit.

Figure 11 shows that several chord lengths could be used to meet the Figure of Merit and propulsive efficiency goals at a 47.5-degree twist. The chord selection was based on comparisons between low speed maneuver capability and payload margins. The V-22 low speed maneuver requirement is a load factor of 1.75 g at 60 knots, sea level standard day, at the design mission takeoff gross weight. As shown in Figure 13, the g capability increases with chord, whereas the payload margin is optimum at a chord of around 2.04 feet; therefore, a chord of 2.089 feet was selected. It provided the required g capability without a significant decrease in the payload margin.

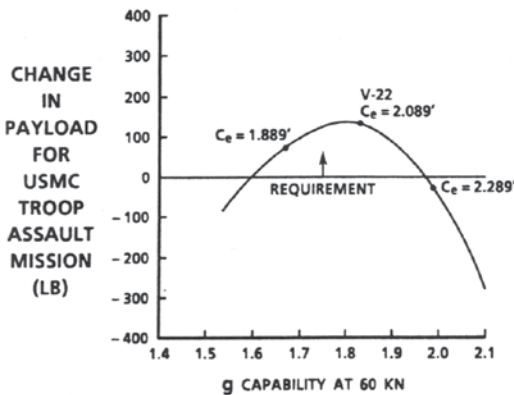

FIG. 13. Proprotor chord selection.

TAPER RATIO

Blade taper ratio was the next parameter selected. Taper is used to

move the blade loading inboard, which reduces the required torque. It is also effective in decreasing the hover power required, which improves the Figure of Merit. Two design constraints on the root chord were used in selecting the taper ratio: the folding requirement limited its maximum size, and structural considerations limited its minimum size. Performance calculations for various taper ratios were made to determine the effect on hover power required and propeller efficiency. As shown in Figure 14, decreasing taper ratio decreases hover power required, but also decreases propeller efficiency. The minimum taper ratio of 0.637 was selected as limited by the blade root constraint.

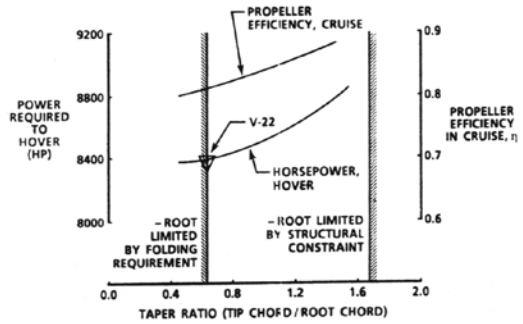

FIG. 14. Taper ratio selection.

DESIGN SUMMARY

Table 2 summarizes the resulting geometric and aerodynamic design parameters as selected for the V-22 along with the selection criteria. The chord and twist distributions of the proprotor are shown in Figure 15. The final design parameter, the blade root/spinner clearance, was obtained during wind tunnel testing and will be discussed in the design verification section.

TABLE 2. Proprotor aerodynamic design summary.

Parameter	Selection	Criteria
Diameter	38 Ft	Operation Adjacent to LHA Island
Number of Blades	3	Folding Requirement, Blade Dynamic Response
Tipspeed	Hover 790 Ft/Sec Cruise 662 Ft/Sec	Performance, Sound Best Performance Tradeoff
Airfoils	XN-28, XN-18, XN-12, XN09	Optimize Performance in Hover, Cruise and Low Speed Maneuver
Twist	47.5° Nonlinear	Best Hover/Cruise Tradeoff
Chord	$C_r = 2.089$ Ft	Best Hover/Cruise Tradeoff, g Capability at 60 kn
Taper Ratio	0.637	Best Hover Performance Constrained by Folding Requirement

DESIGN VERIFICATION

The design verification of the analytically selected proprotor parameters was achieved through use of both small and large scale model tests. These tests not only supported the analytical database of the V-22, but also developed a data base that could be used in supporting the flight test program, as well as other tilt-rotor designs. It was considered beneficial in reducing the program performance risk.

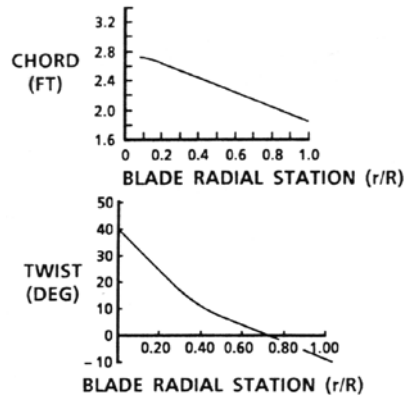

FIG. 15. Proprotor geometric characteristics.

AIRFOIL VERIFICATION

Fifty-percent-scale models of the selected airfoil sections were tested in the two-dimensional insert of the Boeing Supersonic Wind Tunnel (BSWT) (Reference 3) in October and November of 1983. Figure 16 [not reproduced] shows one of the airfoil sections mounted in the tunnel. The airfoils were tested at Mach numbers that corresponded to the operational range of the V-22 proprotor. Force and moment data was obtained by measuring static surface pressures. The test results, which are shown in Figure 17 and compared with the calculated analysis for the 12-percent-thick section, are an example of the type of results achieved. As shown, the design goals were met or exceeded. The test results for the remaining airfoil sections are similar to those obtained for the 12-percent-thick section. Thus, airfoil sectional characteristics were confirmed during the 2-D testing.

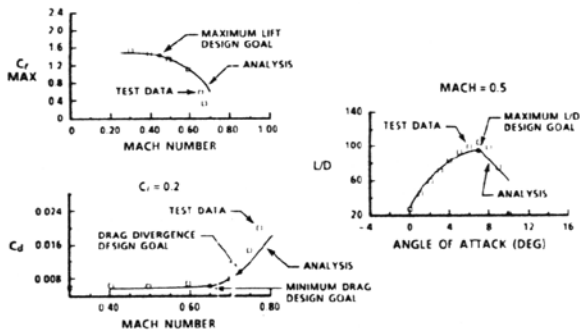

FIG. 17. Airfoil verification.

HOVER FIGURE OF MERIT VERIFICATION

The hover Figure of Merit has such a significant impact on the design that it was realized that hover performance would have to be verified on a large scale model to minimize significant scale effects. Therefore, a 25-foot scale model of the proprotor was selected and tested at NASA-Ames Outside Aerodynamic Research Facility (OARF) to measure the hover performance. Figure 18 [not reproduced] shows the proprotor mounted on the test stand. The proprotor was both Mach and dynamically scaled, and had a thrust-weighted solidity of 0.1138, which is slightly

greater than the final solidity of 0.1050. The proprotor was mounted horizontally to minimize the ground interference effects.

Both the isolated and installed performance of the proprotor was measured during the test, as well as the wing download. The installed performance was measured by testing the proprotor in combination with a reflection plane and fuselage model. The installed performance includes the effects of re-circulation and partial ground effect due to the wing. A comparison of isolated and installed test

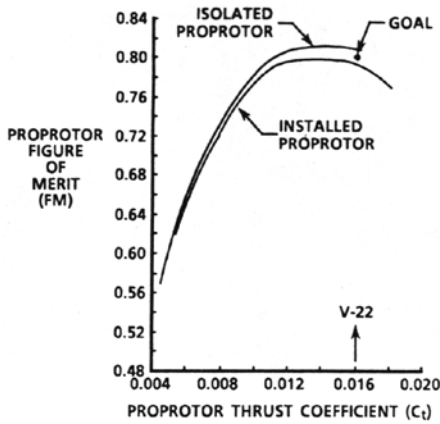

FIG. 19. Hover Figure of Merit verification.

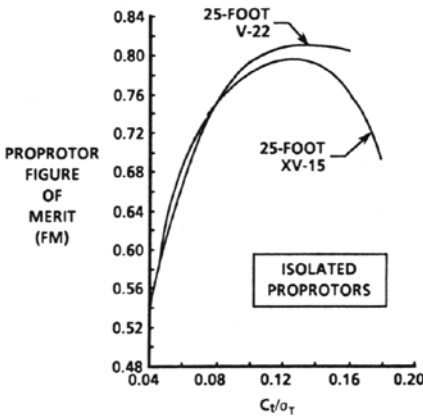

FIG. 20. V-22 and XV-15 Figure of Merit comparison.

an entire drive system. The proprotors, drive system, and controls are identical to those of the flight test aircraft. It is capable of extended operation in helicopter, conversion, and airplane modes at symmetrical or asymmetrical power levels and at anticipated operational proprotor rpm ranges. Preliminary data taken from the GTA and Aircraft No. 1 compares very favorably with the corrected OARF

results corrected to full scale and solidity is shown in Figure 19 (Reference 2). The maximum Figure of Merit reached was 0.808 at a $C_t = 0.016$, slightly greater than the hover design goal of 0.80. The Figure of Merit of the installed proprotor was slightly less than that of the isolated proprotor. This is due to a region of re-circulating flow between the proprotor and the wing, which was observed during the test. This was simulated using a reflection plane to represent the side-by-side effect of the proprotors.

A full scale XV-15 proprotor was also tested during this test, permitting a direct comparison of the isolated performance characteristics of the two proprotors with the same test conditions and using the same test facility. As shown in Figure 20, when non-dimensionalized by the thrust-weighted solidity, the V-22 proprotor Figure of Merit is improved over that of the XV-15 proprotor.

At the time of this paper, the only full scale verification data available was that obtained during testing on the Ground Test Article (GTA) and initial flights on Aircraft No. 1. The GTA, shown in Figure 21 [not reproduced], consists of an actual wing-pylon assembly and includes

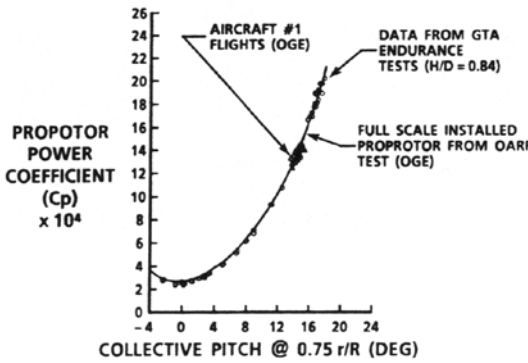

FIG. 22. Collective pitch/power comparison.

data was also measured without the inboard cuff fairings, but was out of ground effect. As shown, there is good agreement between the two.

PROP-ROTOR $t_{c,max}$ VERIFICATION

Data from a 15 percent scale-powered model test conducted in the Boeing Helicopter Company 16 × 16-Foot Low Speed Wind Tunnel (BVWT) helped validate the maximum proprotor t_c . The model had the necessary provisions to determine the maximum t_c of the proprotor. Figure 23 [not reproduced] shows the model in the BVWT. The model was primarily used for airframe/proprotor interactions. It had Mach-scaled proprotors, each powered by 120-horsepower air motors in the nacelles. It also had strain gauge balances in each nacelle to measure the thrust of each proprotor.

Figure 24 shows the test data from the 0.15-scale powered model. The maximum thrust of both proprotors was measured during the test. It should be noted that the test data has not been corrected for scale effects. For comparison, the full scale corrected installed data from the OARF test is shown. As shown, the differences for scale effects are significant. At the higher thrust levels, the full scale proprotor t_c 's are approximately 12 percent higher than those measured on the 0.15-scale powered model. Even with the scale effects present, a $t_{c,max}$ of 0.395 was reached during the 15-percent-scale powered model test. Based on

data as shown in Figure 22. Since there are no provisions to measure proprotor thrust only, the proprotor power coefficient and the collective pitch at the 0.75 radial station can be compared with the full scale installed OARF data. It should be noted that the GTA was tested with the proprotor slightly in ground effect at a height-to-proprotor-diameter ratio of 0.84 and without the inboard cuff blade fairings. The Aircraft No. 1

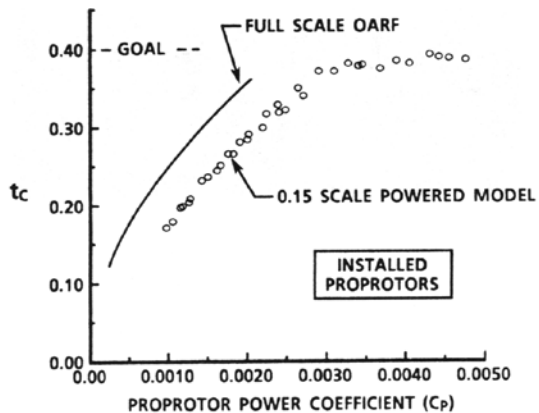

FIG. 24. Maximum proprotor t_c verification.

Even with the scale effects present, a $t_{c,max}$ of 0.395 was reached during the 15-percent-scale powered model test. Based on

these comparisons, the full scale proprotor is expected to meet the maximum t_c goal of 0.4.

PROPULSIVE EFFICIENCY VERIFICATION

The analysis used for calculating airplane propulsive efficiencies was previously validated by correlation during the full scale test of the XV-15 proprotor conducted in the NASA Ames 40 × 80-Foot Wind Tunnel, shown in Figure 25 (Reference 6) [not reproduced]. Both performance and loads were measured in airplane mode, in helicopter mode, and over a range of conversion angles.

Figure 26 compares the measured with the calculated efficiencies and demonstrates the validity of the calculations.

In addition to the XV-15 test, a test of a 25-foot scale V-22 proprotor was also conducted in the NASA Ames 40 × 80-Foot Wind Tunnel in June 1988, as shown in Figure 27 [not reproduced]. The proprotor used during the test was the same as the one used during the OARF test, except for the blade cuff region, which was slightly modified to reflect the final proprotor design. The goal of the test was to obtain propulsive efficiencies throughout the power, airspeed, and nacelle range. However, this was not fully accomplished due to test rig difficulties. A comparison of the measured efficiencies corrected for scale and solidity with the calculated efficiencies at three different propeller advance ratios is presented in Figure 28. The data shows good agreement with the calculated efficiencies, demonstrating that the design goal was exceeded. The proprotor is scheduled for further testing in the NASA Ames wind tunnel in the fall of 1989.

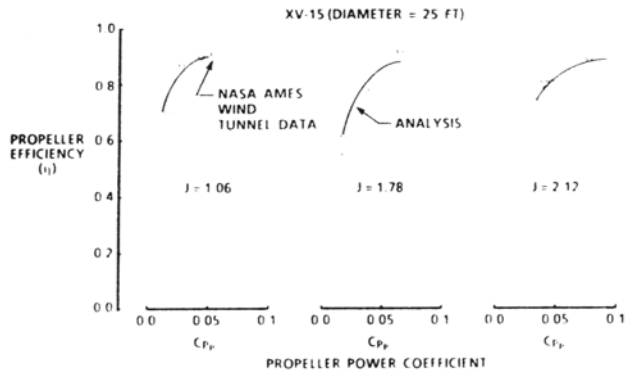

FIG. 26. Propulsive efficiency analysis verification.

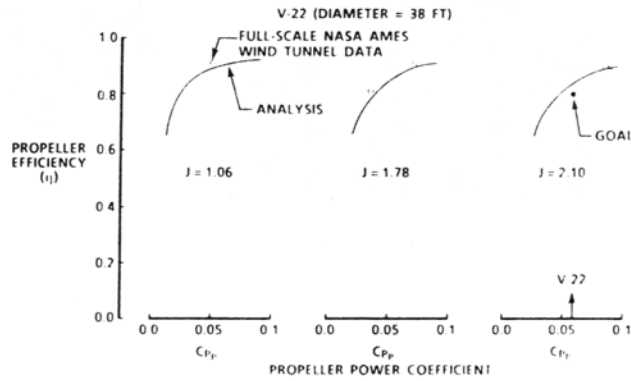

FIG. 28. V-22 proprotor propulsive efficiency.

BLADE ROOT/SPINNER OPTIMIZATION

The blade root/spinner area was an important area in the design of the proprotor. The V-22 proprotor control system requires very large cutouts in the spinner to allow for blade pitch and flapping changes. The spinner also has a small fineness ratio because of the shipboard folding requirement: the nacelle must not extend past the vertical tail when the V-22 is folded (Figure 29). In airplane mode, the large cutouts allow freestream air to flow into the spinner, creating large amounts of drag and decreasing the aircraft's propulsive efficiency.

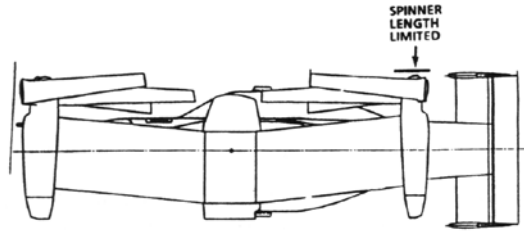

FIG. 29. Plan view of folded V-22.

Two 0.3-scale non-rotating blade root/spinner tests were conducted in the LTV Aerospace and Defense Company's Low Speed Wind Tunnel (LSWT), shown in Figure 30 (References 7 and 8) [*not reproduced*]. The overall objectives of the tests were to evaluate spinner shapes and to investigate methods to reduce the blade root/spinner drag and interference effects. Incremental effects were considered acceptable. This avoided adding the complexity of rotating the spinners. Several different spinner shapes were tested—a North American P-51 type spinner, several blunted spinners, and several spinners designed using the computer code VSAERO (Reference 9). The models were tested with and without blade cutouts, aerodynamic fairings (or "eyebrows"), and stub proprotor blades. Drag, rolling moment, and yawing moments were measured using an internal strain gauge balance. A splitter plate test rig was used to allow drag measurements to be made on the stub blades (Figure 31) [*not reproduced*]. By using combinations of the measurements taken from the splitter plate rig and the normal test rig, the drag of the various components could be determined and then optimized. Figure 32 shows a summary of the test results, along with a side view of the final configuration.

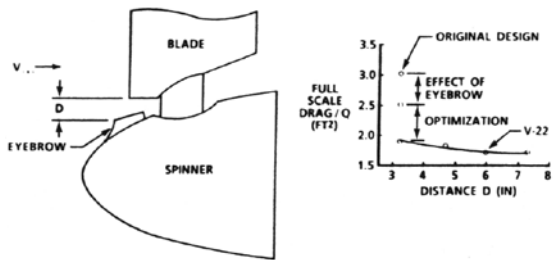

FIG. 32. Blade root/spinner optimization.

The baseline configuration consisted of a basic spinner. When eyebrows were added to the leading edges of the blade cutouts,

the configuration drag was reduced by 22 percent. This was achieved by diverting the airflow around the blade cut-out holes, rather than allowing the freestream air to flow into them. The eyebrows were further optimized by changing their shape, size, length, and leading edge angle to provide an additional 24 percent reduction

in drag. The tests also showed that there was an optimum spinner-to-blade distance that minimized the interference drag between the blade root and spinner. This reduced the configuration drag by an additional 12 percent. Together these changes reduce the total configuration drag to 58 percent of that of the baseline design.

CONCLUSIONS

The following conclusions are reached:

1. All the aerodynamic design objectives established during the design of proprotor were met or exceeded.
2. A proprotor can be designed to achieve a higher Figure of Merit than a helicopter while still giving acceptable propulsive efficiency.
3. The design of the V-22 proprotor was biased towards providing good hover performance.
4. The shipboard compatibility constraints were met and had a major impact on the design.
5. Design of the blade root/spinner area was an important consideration in the design. Significant performance improvements were made by considering the blade root/spinner area.
6. The use of wind tunnel testing was vital in validating the analysis used in the proprotor design process and demonstrating the achievement of the design goals.

Document 5-52 (a–c)

- (a) Eric Umansky, “Chopper Troubles: The Army’s New Attack Helicopter Has a Little Weight Problem,” *Mother Jones* (January/February 1999), accessed at <https://www.motherjones.com/politics/1999/01/chopper-troubles/>.
- (b) Nick Kernstock, “Sikorsky S-92 Helibus Makes First Flight,” *Rotor & Wing* 33 (February 1999), accessed at <https://web.archive.org/web/19991009215029/http://www.defensedaily.com/reports/rotorwing/previous/february99/rotorcrafft0299.htm>.
- (c) Jim Wilson, Stefano Coledan, and Steve Ditlea, “21st Century Sky Trooper,” *Popular Mechanics* 176, no. 4 (April 1999): 21.

As our text indicates, an Internet search in the year 2000 using the word “helicopter” resulted in some 635,200 “hits,” a clear indication of how important helicopters had become by the end of the 20th century. In 2012, that same word search produced 136 million hits, indicating at least in part a much-expanded role for rotary-wing aircraft in aviation worldwide. The following three articles, all dating from 1999, represent an interesting sampling of the mega-mountain of material relevant to what was going on in the year 2000 in the field of rotorcraft development.

The first article reports on serious concerns by the federal government’s General Accounting Office (GAO) that the AH-64D Apache Longbow, a new Army attack helicopter made by Boeing, had not been performing well and that the Pentagon should think twice before proceeding with its plans to spend nearly \$5 billion to buy 758 of the machines. In the article, Pentagon analyst Ernie Fitzgerald makes a general point important to many, if not most, procurements of advanced technological systems: “There are only two phases to these programs. Too early to tell. And too late to stop.” It would take another set of volumes to document this economic and political aspect of the history of American aircraft development.

The second article reports on the debut of the Sikorsky “Helibus,” what many consider to be the world’s most advanced medium-lift helicopter. Behind the Helibus’s development stands an international team of companies led by Sikorsky (a subsidiary of United Technologies Corporation) and including Embraer in Brazil, Gamesa in Spain, Mitsubishi Heavy Industries in Japan, Jingdezhen Helicopter Group/China National Aero-Technology Import and Export Corporation

(CATIC) of the People's Republic of China, and Aerospace Industrial Development Corporation (AIDC) in Taiwan. Never before has such a broad international group ever cooperated in the development of a single aircraft of any kind.

The final selection is a brief item that appeared in the "Technology Watch" section of *Popular Mechanics* magazine in April 1999. Accompanied by a picture that is not included here, the article provided a capsule feature on a new experimental combat rotorcraft known as the "Dragonfly," which was in development by Boeing for the U.S. Army under the direction of the Defense Advanced Research Projects Agency (DARPA). This innovative design, thanks to its rear canard rotor wing, promised a transition from helicopter mode to fixed-wing mode faster than any tilt-rotor and fly at speeds in excess of 375 knots. In November 2003, the Boeing X-50A Dragonfly made its first demonstration flight, with the idea that the U.S. Marine Corps would use the aircraft as escorts for its MV-22 Osprey troop carriers. Unfortunately, the prototype aircraft—known as the Canard Rotor/Wing Demonstrator—exhibited some inherent design flaws, leading DARPA to withdraw its funding in 2006.

In just these three short Internet articles, the reader should find abundant evidence of the vitality of the rotorcraft field as we move into the 21st century.

Document 5-52 (a), Eric Umansky, "Chopper Troubles: The Army's New Attack Helicopter Has a Little Weight Problem," Mother Jones (January/February 1999).

If you bought a brand-new pickup truck, only to find out that it could either drive on the highway or carry cargo, but not both, you wouldn't be a happy customer. Yet the Pentagon is in a similar situation with the AH-64D Apache Longbow, a new attack helicopter from Boeing, and it appears to be satisfied—it plans on spending \$4.9 billion to buy 758 of them.

According to a little-noticed General Accounting Office (GAO) report released in September, the Longbow lacks the "agility to operate successfully in combat." At issue is the helicopter's "vertical rate of climb" (VROC), a crucial measure of maneuverability. The Army required the Longbow to have a VROC of 450 feet per minute at an altitude of 4,000 feet and a temperature of 95 degrees, and the helicopter can indeed pass that test. But when loaded with fuel and a full complement of 12 missiles—an additional 1,721 pounds—the Longbow falls short of that goal. Literally.

Do the math: When not fully loaded, the Longbow's VROC is an impressive 895 feet per minute. Army engineers say that for every pound the Longbow gains, the helicopter loses .839 feet per minute of lift. Multiply .839 by the additional weight of missiles and fuel, subtract that number from the unloaded Longbow's VROC, and the result is negative 549 feet per minute. In other words, the Longbow would, in theory, not only be unable to climb, it wouldn't be able to maintain altitude—even at maximum power.

While a fully loaded Longbow can definitely fly, the negative VROC would, in the words of the GAO report, "decrease the helicopter's ability to evade enemy fire, thereby decreasing survivability."

In its response to the report, the Pentagon claimed the GAO "incorrectly combined requirements." It agrees that the Longbow must have a VROC of 450 feet per minute, and that it has to carry 12 missiles. It just doesn't think it has to do both at the same time.

"That's ludicrous," says one GAO analyst. "The Joint Requirements Oversight Council [the Pentagon agency charged with overseeing requirements for major weapons programs] confirmed that the helicopter had to meet VROC requirements while carrying 12 missiles." According to the GAO, the Longbow is only supposed to be able to do one thing at all times: kill the enemy. In order to do that, it needs to be both maneuverable and carry as many missiles as possible. (When contacted by Mother Jones, Army officials referred us to the Pentagon's response to the GAO.)

The Longbow isn't the first case in which the Pentagon has dumbed down requirements for a major weapons program. The practice is so common that critics have given the elastic requirements a name: "rubber baselines." When a weapons

program doesn't meet one of its goals, the Pentagon simply redesigns the goal. Taxpayers end up paying the same amount, or more, for a weapon that does less.

Chuck Spinney, a Pentagon analyst, points to the C-17, a new Air Force transport plane, as a classic example of a rubber baseline. Because the C-17 is overweight, the Pentagon lowered its range and payload requirements—crucial performance parameters for the plane—three times.

Local inspectors rejected the C-17, confirms Ernie Fitzgerald, another Pentagon analyst, “but an Air Force inspection team came out and overruled them. That plane never met its original specs and it never will.”

Some officials, both inside the Pentagon and out, suggest there's nothing surprising about weapons development programs failing to meet their original requirements. The problem, they say, is that goals are set too high in the first place. Often, it's a result of contractors wanting to impress the Pentagon, which in turn wants to impress Congress.

Contractors look to “turn on the cash flow,” says Spinney, “and then lock the spigot open.” They rush weapons into production without adequate testing, and by the time they find problems, “[the Pentagon has] too much invested to change anything. So they just dumb down the requirements.”

“There are only two phases to these programs,” says Fitzgerald. “Too early to tell. And too late to stop.”

Document 5-52 (b), Nick Kernstock, “Sikorsky S-92 Helibus Makes First Flight,” Rotor & Wing 33 (February 1999).

SIKORSKY AIRCRAFT CORP., STRATFORD, CT, successfully completed the first flight of its 19-seat S-92A Helibus at its Development Flight Center in West Palm Beach, FL.

Sikorsky hopes that operators will see the multi-mission S-92 as an updated equivalent and replacement for its popular S-61, many of which are flown in the offshore oil support role in the North Sea and the Americas. While serving as president and CEO, Sikorsky Chairman Eugene Buckley championed the helicopter as a possible contender in the international competition for that market-competition that includes Eurocopter's enhanced AS-332 Super Puma Mk III and EH Industries' EH101 Heliliner.

“This is a historic day for the S-92 Helibus development program,” said Sikorsky Chairman Eugene Buckley. “It represents how a team of international manufacturers have been able to work together to accomplish a common goal.”

The Helibus was developed by an international consortium led by Sikorsky. Also participating in the project are: Mitsubishi Heavy Industries, Tokyo, Japan; Jingdezhen Helicopter Group/CATIC, People's Republic of China; Gamesa Aeronautica, Minano, Alava, Spain; Aerospace Industrial Development Corporation (AIDC), Taichung, Taiwan; and Embraer, Sao Jos dos Campos, Brazil.

Not everyone in the industry is as enthusiastic about the helicopter as Buckley. At press-time, the Helibus has failed to attract any orders, and it's still unclear whether there is a sufficient military and commercial market to make the S-92 a viable program.

Carroll Suggs, CEO of Petroleum Helicopters, Inc., echoes that opinion, suggesting that Sikorsky will have to show operators that the Helibus is more cost-effective than the alternatives. (Turn to "For the Record," page 38 [*not reproduced*].)

Despite industry concerns, Sikorsky Chief Pilot John Dixson and S-92 Program Chief Pilot Bob Spaulding executed a flawless maiden flight on Dec. 23, 1998. The 50-minute test consisted of eight takeoffs and landings; in-flight maneuvers included hover, forward flight and sideward flight. Sikorsky did not release further details on what airspeeds the helicopter achieved.

In the months ahead, four of the S-92's five prototypes will be put through a series of flight tests designed to develop the helicopter's full flight envelope. The maximum gross weight for the S-92A will be 25,200 pounds with an alternative gross weight of 26,500 pounds. Powered by twin General Electric CT7-8 turboshaft engines, the helicopter will have a range of 400 nautical miles with fuel reserves, a cruising speed of 155 knots, and a service ceiling of 15,000 feet.

Main cabin sections, the largest subassemblies, are shipped from Mitsubishi Heavy Industries and mounted on special tooling in Sikorsky's Development Manufacturing Center. The vertical tail fins come from China's Jingdezhen Helicopter Group/CATIC.

Gamesa provides the aft transition tailcones and strongback composite structures (sliding pylons and upper deck fairings), complete with supporting hardware and the titanium and aluminum supporting structures.

The cockpits—including electrical harnesses, hydraulic lines, equipment cooling, environmental ducts, windows and flight controls—are manufactured by Taiwan's AIDC. Brazilian airframe manufacturer Embraer is under contract to provide the complete sponson assembly, including fuel cells and landing gear.

Document 5-52 (c), Jim Wilson, Stefano Coledan, and Steve Ditlea, "21st Century Sky Trooper," Popular Mechanics 176, no. 4 (April 1999): 21.

America's next generation of combat helicopters will have more in common with vertical-takeoff jets than with whirlybirds.

The rear, or canard-positioned, wing of the experimental Dragonfly, shown above, will enable the aircraft to make optimal use of the exhaust from a conventional turbofan engine.

During takeoffs, landings and vertical flight, a diverter valve will direct the jet's exhaust to the rotor.

As forward movement produces more lift, the exhaust will be progressively diverted to the rear. When the rotor locks, all thrust will be diverted aft.

"An operational canard rotor wing unmanned aerial vehicle would be able to take off and land in confined areas without a launch or recovery system, rapidly transition to and from a fixed-wing mode, and fly at speeds in excess of 375 knots," says Larry Birckelbaw, who is managing the project for its sponsor, the Defense Advanced Research Projects Agency.

The Boeing Phantom Works, which is building an unmanned version, says the first demonstration flight will take place within two years. The Marines are eyeing full-size Dragonflies as escorts for MV-22 Osprey troop carriers, for development early in the next century.

[Editor's Note: The Boeing Dragonfly never made it into production due to development problems related to the inability to transition to forward flight. DARPA canceled the project in 2006.]

Document 5-53

**Dennis Bushnell, “The Personal Helicopter,”
in *The Personal Aircraft—Status and Issues*
(NASA Langley Research Center, Hampton, VA: NASA
Technical Memorandum 109174, December 1994), pp. 37–44.**

In the view of one of NASA’s most visionary aerodynamicists, Dr. Dennis Bushnell, the massive problems and costs of contemporary automobile use in the early 21st century will virtually dictate that some form of personal air transportation be tried in the near future. His answer: a combination automobile/helicopter or “helo-converticar” that will revolutionize transportation and society by creating a new form of mass personal mobility. Bushnell believes that in a matter of a decade or two, such a hybrid vehicle will become eminently feasible. Different forms of advanced technology will make it successful where all previous concepts for “roadable aircraft” or “flying cars” failed. Thanks to computer and satellite navigation systems, they should be able to operate safely, effectively, economically—in fact, virtually automatically. A well-designed helo-converticar should also be able to meet all the necessary environmental and nuisance regulations in terms of collision avoidance, survivability, noise, emissions, ground-vicinity operations, and reliability while providing reasonable ride quality, all-weather operation, and minimal maintenance requirements and costs. Such a vehicle will not replace the automobile or rail lines for short-distance and other commuter transportation, but it will add to a healthier mix. Like the ubiquitous Ford Model T of the early years of automobility, a helo-converticar will reduce population density by stimulating expansion over much greater areas, lessen the tremendous capital investments required for constant building and rebuilding of roads and highways, and otherwise revolutionize transportation and society.

All of the papers at this 1994 NASA conference titled “The Personal Aircraft” proved stimulating, but Bushnell’s did the most to lay out the larger picture of America’s and the world’s transportation needs as we move into the 21st century.

*Document 5-53, Dennis Bushnell, "The Personal Helicopter,"
in The Personal Aircraft—Status and Issues
(NASA Langley Research Center, Hampton, VA: NASA Technical
Memorandum 109174, December 1994), pp. 37–44.*

INTRODUCTION

The developed nations entered the 1900s with a transportation system [for people] centered upon the horse, the railroad and the steamship, with associated travel times [on] the order of hours-to-days/weeks, depending upon distance. In the closing years of the same century the automobile has long supplanted the horse and the fixed wing aircraft has nearly driven the railroads and steamship companies from the long haul passenger business. Travel times have shrunk to minutes-to-hours. In the process of supplanting older transportation systems, these newer approaches have had a profound influence upon the structure of modern societies. Cities have expanded out of 18th century seaports and 19th century railheads, where much of the developed region was within walking distance of the transportation terminals, into tremendous suburbs with attendant reductions in crowding/increased opportunity for individual home ownership, etc. The existing transportation system fulfills a variety of purposes including travel to and from work and stores, and for various business, service and pleasure related activities. Transportation and related activities currently constitute [on] the order of $\frac{1}{5}$ of the U.S. GDP.

The present report will center upon future possibilities/options for a specific portion of the transportation spectrum, short-to-moderate range, nominally from 10s to 100s of miles. The current dominant transportation mode for this mission is the automobile, which, possibly more than any other single technical achievement, has enabled the current life style enjoyed by the developed nations. In this process the auto has created massive safety problems and been responsible for the expenditure of truly prodigious sums on roads and bridges, etc. The current status of the auto infrastructure is that we continue to clear and pave more of the watershed, contributing to flooding, desiccation and the formation of heat islands. Also, the average trip time is increasing due to expansion of the suburbs and increased congestion, causing non-trivial changes in family life as travelers attempt to utilize non-traditional time slots, or suffer long/nonproductive commutes. The interstate highway system is finally finished and is already clearly overburdened and in need of very expensive repairs and expansion.

Society cannot, easily or otherwise, continue to bear the costs imposed by almost sole reliance upon the automobile for short-to[-]intermediate passenger transport[;] alternatives are necessary for the future—both for the developed societies and those that desire to/are developing. Probably the most commonly advocated alternatives involve some form of mass transit, which have, along with tremendous capit[a]l costs, several other drawbacks such as passenger wait time, weather

exposure and lack of privacy, security, pride of ownership and personal stowage. Additional drawbacks are the fact that they are not portal-to-portal and there is no guarantee of having a seat. Undoubtedly, the future mix of short-to-intermediate transport systems will include both mass transit and automobiles of some variety, probably operated on “intelligent” highways to improve safety and throughput/trip time [ref. 1, *not reproduced*].

There is, however, both a need and an opportunity to include in the transportation mix a personal air vehicle which would provide, percentage-wise, the same increase in speed [compared to the auto in traffic], as the auto has provided over the horse. Personal air transportation is both revolutionary and the next logical step in the development of human infrastructure and corporal communication. The increased speed of such a capability, along with the greatly reduced capit[a]l requirements in terms of highways/bridges etc.[,] should allow significant increases in the quality of life as well as reduced state and national public works budgets. Specific benefits include distribution of the population over a much larger area, allowing a more peaceful/less damaging co-existence of man and nature, along with improved transportation safety. The “vision” is of multi-level highways in the sky, controlled and monitored by inexpensive electronics as opposed to narrow, single level, exceedingly expensive “ribbons of concrete” [e.g. ref. 2, *not reproduced*]. Such air systems/vehicles could also obviously be used for longer haul[s], as are automobiles today. The various wait times associated with commercial air travel, along with the inefficiencies in terms of transit time of the hub and spoke system[,] mitigate in favor of reduced overall trip time for slower, but more direct, travel via personal aircraft [compared to the “faster” commercial jet]. Various options exist for personal aircraft systems. The discussion herein will address one such option, a helo-converticar, and attempt to defend that particular recommendation.

PERSONAL HELICOPTER ISSUES

Certain requirements/desirements are common to any personal transportation vehicle/system. These include short transit time/speed, direct portal-to-portal, privacy and security, constant availability, personal stowage and suitability for transport of the “non-pilot” with all that implies in terms of athletic prowess/physical and mental capabilities etc. From the outset an obvious [and probably attainable] goal should be an *automatic* personal air transport system, automatic with respect to navigation [e.g. refs. 3–5, *not reproduced*], air traffic control and operation. The technology to accomplish this is either currently employed by/for the long haul air transport application, or in the research pipeline, thanks to the microchip “electronics revolution” and GPS. Such automatic operation provides vastly improved safety, as the preponderance of accidents are due to operator error. In addition, it makes personal air vehicle transportation available to the general public, as

opposed to the few who have the opportunity, money, and physical characteristics to become pilots.

Conventional wisdom holds that, to be successful, an alternative transportation system must be not only faster, but also relatively inexpensive, or at least not more expensive, or perhaps not significantly more so [depending upon which income strata one is targeting]. The costs involved in any system include acquisition, operation, maintenance, and depreciation. To be competitive with the automobile a personal helicopter should have an acquisition cost in the vicinity of a quality automobile. In 1994, this is [on] the order of 30k+. Although in terms of the current helicopter industry this is a ridiculous target, the advantages of a production run of millions instead of hundreds, along with a recent offering of a single seat helo for 30k [refs. 6 & 7, *not reproduced*] makes the outlook to achieve such a goal possible if not probable. Operational costs include fuel, insurance, parking fees, etc., and need not be greater than the auto. Maintenance is considerably greater for present helos than for autos, and therefore this issue would have to be addressed in the personal helo technology development program.

All-weather operation is also a requirement, the same all-weather capability one now has in an automobile, which is by no means absolute. Heavy rain, and extreme winds, ice and snow will all either slow or stop the auto, and similar restrictions will hold for the personal helo. Obviously the evolving “detect and avoid” technology could be utilized by the personal helo [either on or off board] to increase safety vis-a-vis extreme weather. In terms of speed and range, the helo must provide a significant speed advantage or it is simply not viable. As compared to a fixed wing personal aircraft, the helo speed advantage is much less vis-a-vis the auto, but at a nominal factor of 4 [for the traffic case] still sufficient. We are currently spending significant sums to gain a factor of 2+ in the high speed civil transport program [vis-a-vis subsonic transports]. Another key issue is rider acceptance in terms of acoustics, vibration, ride quality, and reliability/safety. All of these technical areas will require further work, although the helo community has made significant strides in these already and considerable further gains/technological advances are in the pipeline. A final major set of issues involve community acceptance in terms of acoustics and downdrafts during near surface operations. Again, more work is needed, but these could be addressed by operational as well as technological approaches. Previous approaches to the “personal helicopter” have mainly considered existing machines as opposed to the advanced technology/farther term vision discussed herein [e.g., refs. 8–10, *not reproduced*]. There have been, however, calls for such an approach [refs. 11, 12, *not reproduced*].

PERSONAL HELICOPTER TECHNOLOGY

Over the years, particularly since the 1930s, there have been suggestions, and in some cases strident calls, for the development and marketing of personal aircraft.

Although “general aviation” has made considerable advances, the “aircraft for the masses” never really caught on for a variety of reasons, mainly involving COST and requisite technology readiness. History is replete with examples of concepts which are good ideas and which keep resurfacing until the technology base is ready. An obvious example is the gas turbine engine. Since the last personal aircraft campaign in the late 40s–50s, major strides have occurred in several enabling technologies. These include light weight, miniature, inexpensive and tremendously capable electronics/computing, light-weight composite materials with essentially infinite fatigue life, computational fluid mechanics, smart-to-brilliant materials/skins, flow control of several types, active controls/load alleviation and direct energy conversion. Such advances significantly change the personal aircraft discussion, particularly for the helo. “The helicopter looks, 35 to 40 years after its invention, to be poised in the position the fixed wing aircraft were in the late 40s and early 50s, again 40 years after the first flights were being made” [ref. 13, *not reproduced*]. In particular, the personal helicopter would profit from much of the sizable investment made in military machine research, albeit the civilian application is in many ways less severe in terms of “rough usage” etc. This is again directly analogous to the fixed wing situation where the 707 class of transport aircraft profited immensely from/ was enabled by, the military investments in swept wing/jet propelled bombers/tankers/transport.

Key helo-specific technologies either available or in the pipeline include high reliability turbines with 100,000 hour time-between failures [allowing single engine operation], composite blades with 10,000 hour fatigue life, the hingeless-bearingless rotor with low drag hub, automatic health monitoring to allow significant reductions in maintenance costs, anti-vibration and anti-noise for enhanced rider comfort, automatic piloting and navigation/nap-of-the-earth operation, composite structure and skins and smart skins for flow and load control. Taken together these advances will address many of the issues identified in the previous section [see, for example, refs. 14–21, *not reproduced*].

There are other key technologies which should probably also be addressed for application to the personal helo. These include the possibility of utilizing an electric drive via direct conversion and fuel cells. Such an approach may provide simplicity and reduced vibration, noise and emissions [refs. 22–26, *not reproduced*]. Another interesting farther term technology involves the development of “ice-phobic” surfaces, via surface chemistry tailoring, for anti-icing. Blade motion/flexing usually helps obviate ice buildup on the blades, but icing is a general problem in terms of all-weather operation. If speeds faster than 160+ mph are desired then several candidate techniques could be studied such as the tilt-rotor, x-wing, variable diameter rotor, stopped/stored rotor and the M-85 large hub fairing concept [e.g. refs. 27, 28, *not reproduced*]. Further work in active flow control holds the promise of reduced downwash effects, improved performance, improved ride quality and reduced vibration and acoustics. Also, a viable means must be worked to provide

safe mission abort for a single engine machine below 500 ft. altitude. Parachute systems are an obvious candidate, as is autorotation.

Recent examples of personal helos include the well-known Robinson R22 Beta and the recently marketed Ultrasport 254 [refs. 6 & 7, *not reproduced*]. The former is a two-place helo with an annual operational cost [on] the same order as a GA fixed wing machine-11k. The rotor diameter is 25 ft., the mileage is 15 MPG at 110 MPH, and the initial cost is [on] the order of 100k for a production run of 300/year. The cost for the one-person ultralite Ultrasport machine [no pilot license required] is 30k, with a direct operating cost of \$8/hr, which begins to sound affordable. The safe mission abort problem appears to be in hand for the Ultrasport. The bottom line regarding technology for the personal helo is that, if we are not within striking distance we are at least very close. As in most cases of such systems, it is not one single technology which is enabling, but an assemblage of technologies which will result in this revolution in personal transportation.

THE HELO-CONVERTICAR

There are several “systems level” issues and critical choices regarding the personal aircraft which served as key discriminators in the selection of the particular personal aircraft discussed herein, a helo-converticar. The first such issue is whether the personal aircraft [either “fixed” or rotary-wing] should be a separate air vehicle, or a “converticar”, i.e. a combination automobile and air vehicle capable of economically performing both missions. Economics and utility strongly favor the “converticar” option. There are numerous elements common to both the air and ground vehicles, such as passenger compartments, engines, etc[,] and therefore, if it is technically feasible to reduce the weight of an auto to what is reasonable for an air vehicle, then a single device should be considerably more economical [initial cost as well as maintenance-wise] than buying and maintaining two separate vehicles, particularly when one considers the present cost of autos [25k+ for a quality midsize]. Simplex estimates of the flight-specific component weights indicates a value of less than 1000 pounds, indicating that, with shared utilization of common systems such as the engine, the “all-up” weight of the converticar could be in the [reasonable] range of 2600 to 3000 pounds. From an operational viewpoint, usage as well as maintenance-wise, a single vehicle should be much more convenient. Once the converticar option is selected, some decision/recommendation has to be made regarding the provision for the “air-unique” components, particularly the lift-producing surfaces which require, for reasonable levels of drag-due-to-lift, non-trivial span/aspect ratio. Options include towed “traileered” wings [utilized in early versions of the converticar], fixed wings of inherently low aspect ratio for “roadability” [ref. 29, *not reproduced*], airport “rent-a-wing” concessions where the wings are attached prior to, and removed at the conclusion of, flight, and telescoping wings. The present author favors the telescoping option as offering the best compromise between convenience and performance.

The next critical choice is between conventional/“fixed wing” operation and a VTOL device. An essential difference is that the fixed wing machine/operation requires an airport and although there are many thousands of GA airports in the U.S., one would still have to begin and end the air portion of the trip at an airport. In the opinion of the present author, this is simply too restrictive and contravenes several of the fundamental purposes of the personal air vehicle such as independence of/reduced requirement for large civil works, portal-to-portal transportation, and access to remote sites [remote from roads, etc.]. The VTOL option would allow development/usage of currently undeveloped nations/regions at a fraction of the cost of the roads/bridges etc. usually required for such development, and at much less disruption to the environment [ref. 30, *not reproduced*]. Conversion from ground to flight and back again for a helo-converticair requires only a relatively hard surface with a diameter [on] the order of 25 ft., something which could be placed at intervals alongside the existing highway system to provide convenient ground-to-air “merging” away from existing builtup housing areas to minimize acoustic/downdraft etc[.], influences upon the population. Further advantages of the helo include the provision for both lift and propulsion in a single device during air operation and ATC “margin” [in the event of an ATC conflict the vehicles involved could “hover” or [vertically] land while the problem is addressed/resolved].

Another major option involves the extent to which the operation in the air mode should be automatic as opposed to pilot/human derived. While sport models could be somewhat human-controlled [within the confines of the ATC/safety regulations] the optimal solution is clear. The portion of the population physiologically capable of becoming pilots is not large and there is considerable cost and time involved in doing so, most accidents are due to pilot error [ref. 31, *not reproduced*], and the ATC system requires, for the large numbers ultimately envisaged, automatic operation. Therefore, a user-orientated personal air capability should, ultimately, be automatic in operation as well as navigation and ATC, as already suggested herein.

A personal transportation machine capable of both ground and [VTOL] air operation could be an automobile with an IC engine [ref. 32, *not reproduced*], probably *initially* a two-seater and at least somewhat pilot-controlled, which is light enough to also fly and which has built into its roof an erectable low drag, large taper [ref. 33, *not reproduced*] rotatable hub with a diameter consist[en]t with the vehicle width containing [on] the order of four telescoping rotor blades. In addition, a rear deck vertical fin is required within which is a, perhaps electrically driven, tail rotor. An alternative approach would involve circulation control on the “afterbody” in li[e]u of the tail rotor. As stated several times in this discussion [see the quote from Henry Ford in ref. 34, *not reproduced*], the central issue is COST and usability. As a result of technological advances in several areas, many of them momentous, and the tremendous requirement/market for such an affordable/user-friendly capability, the issue of personal air transportation should be revisited. The probable course of development for personal air transportation is parallel to that of the automobile in

the early 1900's. The initial machines were expensive ["rich man's play toys"] with many impediments to their operation such as poor roads, noise sensitivity and laws which were in many cases "anti-automobile". Once industrialists [e.g. Henry Ford] addressed the problem via "design to cost/PRICE", simplicity [any color as long as it's black] and mass production, the price dropped drastically and the resulting wide-spread sales/utilization of the product revolutionized, in many ways, our entire society.

Document 5-54

E. K. Liberatore, “Epilogue,” *Helicopters Before Helicopters*
(Malabar, FL: Krieger Publishing Company, 1998),
pp. 157–169.

It seems fitting to end the first two volumes of this larger study with a thoughtful essay that compares the process by which the helicopter came to be invented with the process related to the invention of the airplane by the Wright brothers. Exactly how this was accomplished is explained in the concluding section of E. K. Liberatore’s excellent book *Helicopters Before Helicopters* (1998)—a provocative technical analysis of what made the Wright brothers succeed compared with designers of the earlier helicopter prototypes.

At the conclusion of this persuasive article, Liberatore delivers a commentary on what he sees as the role of the helicopters in transportation systems of the future. Most of his points mirror those we encountered in the previous document by NASA’s Dennis Bushnell. Our love of the automobile has put us in a Malthusian bind: “The number of cars keeps increasing...but the number of new, desirable urban venues is practically constant.” The result is congestion, gridlock, pollution, ineffective use of more and more time, and “emotional dysfunction.” More and more people moving through the air is the only answer, Liberatore suggests, and the helicopter is the only way to keep our means of transportation personal. Like Bushnell, Liberatore indicates that mass use of some sort of helo-converticar is inevitable, at least in the modern industrialized nations: “When the need becomes a necessity, the public will accommodate the new aerial system that will one day be as comprehensive and pervasive as the present automobile system.”

As the authors of this study of aerodynamic development, we can only hope to still be around to document what would indeed amount to the most revolutionary development in mass personal transportation since the Ford Model T.

Document 5-54, E. K. Liberatore, "Epilogue," Helicopters Before Helicopters (Malabar, FL: Krieger Publishing Company, 1998), pp. 157–169.

In view of the consistent failure of the helicopter entrepreneurs before Focke, it is of interest from an engineering viewpoint to examine what made the Wright brothers succeed compared with the designers of prototypes described here, and why the Wright Flyer (also Flyer I) was the first successful airplane. This when the Wrights were faced with the same set of problems confronted by other flying machine adherents.

Below is a technical analysis, of the Wright design approach contrasted with the helicopter equivalent in the early 20th century.

The mere fact of successful mechanical flight in [*sic*] December 17, 1903 was in time so overwhelming subjectively, that technical analysis of why it succeeded became of minor interest. Technical factors usually recounted concern the early gliding flights, use of a modest wind tunnel, and the (decisive) invention of wing warping for lateral control. Subsequent copying of the machine by others was not a technical analysis but an endorsement of the design.

In the first years of the 20th century the major problems faced by all addressing mechanical flight relate to the following: stability (i.e., instability), controllability, power, structural integrity, and weight. Nominally, all but power and weight involved safety of flight.

As mentioned before, a certain amount of instability can be tolerated if controllability is positive and effective. Both conditions, especially in the case of helicopters, prevail without taxing the pilot's human limits. The wings alone of the Wright Flyer were very unstable but invention of wing warping (effectively, ailerons), along with a simple rectangular wing platform and forward placement of the elevators, resulted in an airplane manageable by the pilot.

An important corollary is that the Wright design minimized power, weight, and structural integrity. The installed engine power, and consequently weight and high speed, were minimized by launching the airplane into flight. This approach avoided the higher power required for takeoff, even though low power compromised flight speed, in order to favor the goal of practical flight itself. The choice reflects the Wrights' understanding of priorities.

Even the environment was factored in. For men from Dayton, Ohio to select Kill Devil Hills (Kitty Hawk), North Carolina for its steady winds does not come to mind immediately. Steady headwinds would reduce the power required by taking advantage of the energy in the wind, and this favors controllability in its smoothness (like a wind tunnel). However this favorable wind would discourage them from making a turn to fly downwind. The first complete circle was flown in 1904 with the improved Flyer II. Flyer III[,] flown in June 1905, was the first "practical" airplane, a year and a half after the success with Flyer I.

Elimination of a wheeled landing gear not only reduced weight but its high drag (and power increment) as well. Equally drag-reducing was the prone position of the pilot, which in turn reduced weight by eliminating seating and other unessential equipment. The last for example would include an elaborate control actuating system required with upright seating, as well as airborne instruments. Minimization extended to leaving wood surfaces unpainted.

Use of two, large diameter, chain-driven propellers not only balanced torques but provided greater disk area, giving greater thrust per available power. (The disk loading effect also described for [*sic*] helicopter rotors.) Their own propeller design of carved wood is by mere inspection more efficient than the tube and fabric type (Figure 3.1) [*not reproduced*] used by others. The Wrights recognized the propeller as a wing flying in a circle, a concept later accepted in helicopter rotor analysis. Choosing two propellers rather than one large one of the same area and locating them between the wings, probably resulted from choice of short (skid) landing gear and a prone, centrally located pilot. Actually the pilot was off center, balancing the engine weight.

A single central propeller set higher than the engine, which was mounted on the plane of the lower wing, would be a hazard to the pilot. Hence in a tradeoff, two propellers were used either side of the pilot, mounted high enough to clear the ground, and at the same time providing a favorable airflow past the biplane wings.

Structural integrity concerned three main factors: wing loads in maneuvering, the propeller drive system, and powerplant operation (i.e., powerplant reliability) itself. Most likely the Wrights learned wing strength and minimum wing weight from their glider experience. The bridge-like rectangular, biplane structure that is wire-braced, is the simplest and strongest for the wing area desired. Wire-braced monoplane wings were more of a challenge and appeared 6–9 years later. The unsuccessful contemporaries favored the more difficult monoplane wings, probably because there were no biplane birds around to copy.

In flight demonstrations there is no evidence that the Flyer I developed high load factors. Aerodynamically they probably could not pull high “Gs.” For example, they avoided turns that would develop load factors. This was unlikely in any case since the plane flew only a few feet above the ground, and in ground effect (another minimum).

A less obvious consideration is the fact the Wrights were further into development and solved problems (reflected in the design) not confronted by their contemporaries because flights of the latter were marginal or bound to the ground.

Powerplant reliability was verified by bench tests with an engine of their own construction, a design emphasizing low weight and functional simplicity.

Overall one can conclude the design of the Wright Flyer I was marginal in all respects but the decisive one of controlled flight. It was a highly integrated design, with a well-defined priority, serving a single and successful purpose. It was the first

aeronautical “proof-of-concept” design, and could not be used for anything else, including repeated flying.

The Wrights’ contemporaries[,] though they accomplished “something”, failed to a major extent because they missed the point of leaving on the ground every thing and every idea but the essential ones for practical flight, and in not knowing there was only one crucial factor: adequate control of instability. The latter they did not learn empirically, for few machines left the ground into free flight long enough to deal with the problem. The Wrights’ sophisticated totality of the pre-flying tradeoffs and design integration along with minimization and focus are not evident features when analyzing contemporary flying machines. This lack of evidence applies to the early helicopters as well.

For a helicopter, the problems are more demanding because it must hover. On the ground or in the air, a helicopter is always alive. Of a modern helicopter as a design problem it is said the creature is a flying fatigue machine, one that resists being what the engineer insists it must be. This aphorism reflects an appreciation of the uncompromising problem prototype builders of the early 20th century were willing to take on, despite the failures around them. A corollary aphorism: “nature is a jealous mistress.”

Weight control even today is a greater requirement, again because of the hovering feature. In prototypes, the light weight, self-cooling rotary engine was found good-fortune [*sic*]. Hovering cooling became a development problem in the 1940–1945 period when the lighter, airplane piston engines were adapted to helicopters.

Some of the early entrepreneurs chose the propeller-type rotor accepting weight for strength, but at the same time settling for a reduced diameter, both associated with higher power required. As described in the Glossary, selecting a larger rotor of wing construction reduced weight and power, but this choice introduced vibration problems in the blades and slender shafting.

Helicopter structural integrity was more demanding. Everything was vibrating whether on the ground or briefly in the air. Structural fatigue, a fundamental consideration in all modern helicopters, was little understood in aircraft until the late 1930s. Rotor blade fatigue, with the blades bending cyclically as they rotate, first appeared as a problem in the autogiro era. It was not until the late 1950s that analytical techniques were developed to deal with blade fatigue and service life (flight hours before retirement) of blades. The object is to design blades with “infinite life”.

Relative to fixed wings, the conflict in early machines between stability and controllability was more severe, and there was a misunderstanding of rotor design and behavior. None of the experimenters produced a control design that could be considered effective, nor did they understand rotors except as a [*sic*] simple, but perverse, lifting devices. The Wrights understood fixed wings before the first powered flight. Contrary to 19th century belief, they rejected the notion stability was achieved by some pendulous mass below the machine. The helicopter experimenters showed no sense of priorities as did the Wrights, and bundled all the

development problems in one grand trial and error effort with prototypes. However they were only acting in the spirit of the age (particularly in America). Few were as deliberate as Robert Fulton. Only Hewitt had a grasp of rotor performance and only Rochon understood blade articulation and elastic flexure. Focke, consistent with the Wrights' approach[,] reduced the helicopter to practice. Like the Flyer I, the FW-61 as a design was just enough to prove helicopter flight was feasible and not much more.

The systematic approach, as remarked before, is known elaborately today as systems engineering. It is the fundamental methodology in taking on vast problems (particularly, one of a kind) in aeronautical and space engineering. The methodology has spread to other fields as well, commercial architecture for example. Ultimately the systematic approach was the common quality that Fulton, the Wrights, and Focke demonstrated in common.

If there is a general lesson from their work it is this: work methodically, seek out the critical element, and minimize everything else. What results is not optimum but it proves the point. With this particular methodology one is compelled to update that almost forgotten 19th century remark critical of flight: "If God wanted man to fly He would have given him wings". Or brains.

Considering the previously noted good ideas (of Veyrin, Rochon, Hewitt, and Cierva in particular), a provocative thought is why historically, these progressive ideas on helicopters were not followed up. The assumption here is that "progress" moves in a straight line, that good ideas are immediately picked up to enhance the process of innovation. There are at least three explanations for this.

1. Fixed wing was demonstrated by the Wrights as the proven approach to mechanical flight. This marginalized helicopter investigations. A machine with a questionable future, in the light of its unsuccessful past.
2. There was no useful, analytical engineering base, i.e., theory initiated or extant on such concepts as performance and stability. The lack was recognized by Chanute in 1894, and it applied nominally to helicopters until the late 1920s and 1930s. It is very desirable to have a theory first to know what is important in observations, and to know the rational avenues of research. Part of the problem here was individuals who could contribute were more interested in fixed-wing principles.
3. A corollary of the second explanation is the general absence of analytical sophistication in this particular field, in contrast to pure mathematics, for example. Invention, intuition, and accident were the ways of creativity. A well-known example of "reverse theory" applies to thermodynamics. It emerged as a discipline only after steam engine development proved itself in practice.

With regard to modern, evolving helicopter technology, the trend is toward augmenting knowledge by extensive and detailed analyses. (Such an approach is more American than European.) One relies less on deliberate invention and more

on sound, interacting analytical and experimental methods. This view does not minimize scientific discovery but there is less possibility of this in helicopters today. Today, relatively more and varied intellectual energy can be brought to a problem. The modern effort is based on extensive use of computers in analysis, design, and manufacturing, computers for example have made possible an entirely new approach to structural analysis: the finite element method. This method applies to such complex components as rotor blades and airframes as well as simple parts (e.g., critical bolts).

In sum, ideas can be ahead of their time because the environment for appreciation or understanding is simply not there. The only "fault" here is using today's knowledge to judge that of yesterday's.

In view of the erratic technological way to the successful helicopter as discussed above, one can reflect on the public and professional response to such an advanced idea as a flying machine in general, and the helicopter in particular.

As described before, this activity followed both inventive and scientific directions. Remarkable to the helicopter itself was the prolonged duration in public view of the mostly unsuccessful efforts to make it practical. For an ultimately successful and unusual product as a flying machine, one may postulate five discrete stages to both the public and professional response to the work of its adherents.

1. On introducing the idea of human flight by mechanical means, the initial reaction is to see it as impossible. Only in mythology, fantasy, and religion did humans have wings.
2. In time, the dogmatic view softens as the notion develops a life of its own. Disputation involves broad philosophic principles and claims.
3. In the third stage the concept is deemed impractical. Criticism is now on specific technical or barrier problems that inhibit feasibility.
4. The idea is taken seriously in the fourth stage. Technical problems are discussed. There is tentative, and at times skeptical, acceptance.
5. Finally there is general acceptance. Because the concept (the flying machine) has been reduced to practice; an accomplished fact. Nothing makes things so obvious as a detailed explanation.

Not every critic or adherent necessarily ran the full course. One could enter the discourse at any stage.

For helicopters and flying machines in general, the first three stages are identified here with the 19th century. Recall the *Scientific American* criticism of 1848 and its attitude change in 1869. Other (French) criticism was described in the 19th century summary.

The fourth and fifth stages apply to the early 20th century. The success of the Wrights in 1903 ultimately removed doubts about flying machines, but not immediately, for there were skeptics. That consummate aeronautical engineer Igor Sikorsky witnessed those early years and recounts in a paper in 1971 initial

skepticism toward the 1903 flights. He recalls a newspaper article headlined “Fliers or Liars”. Below this was the editorial comment:

When a man of profound scientific wisdom has demonstrated with unassailable logic why a man could not fly, why should the public be fooled by silly stories about two bicycle repair men who have never been to college....

Sikorsky witnessed the initial flight demonstration of the Wright machine in Europe (France, 1908) and wrote in the same paper...“the impression and enthusiasm were tremendous.” With this demonstration the world accepted the airplane as here to stay. About 30 years later one could say the same about the helicopter.

In the 1920s and 1930s, the helicopter went through its own third and fourth stages of reaction. Such took the form of both personal and technical criticism. The limited publicity on the Beach (1920) model dwelt on his novel approach to using “planetary engines” that whirled in circle-like gyroscopes. Editorial comment on the idea concluded with the remark that apparently there was a “total eclipse” of the system.

Exel, who worked on many variants (1920–1923) was considered a “nut” and chronic “tinkerer,” a typical character of that era. He married late, preferring to spend his time and funds (he ran a garage) courting the helicopter.

During World War II helicopter development was at a low level. After the war, American engineers could not dump the autogiro and deprecate its prominent engineers fast enough for the helicopter. This put the latter on the defensive, even though they were not anti-helicopter. This technological drift was a resounding and lasting statement of the importance of hover capability. Enthusiasm peaked in the early 1950s when about 120 American companies and entrepreneurs were involved in its development. Today one could count 10 at most.

After the war the author had conversations with the pioneer Isacco, then a resident of Paris, and the Italian D’Ascanio, on their treatment in the early days, before they were justified in their beliefs. Isacco was invited to the Soviet Union to build a giant helicopter with a 24.4-meter (80 foot) diameter rotor, which he produced in 1935. He was deported when construction was completed not knowing the fate of his machine. Years later it was revealed the craft never flew, due to rotor problems.

In 1930 the D’Ascanio helicopter in Italy set a world record. After the war he visited the United States to follow up on current helicopter activities. Considering the vindication of belief in the helicopter, he was asked what bothered him most in those early days. It was the public head-shaking in his presence, implying he was foolish and mad to get involved in such a crazy idea. (His second problem was the constant contention with the financial backers.)

Another aspect of the last two stages is the professional, or scientific approach to the helicopter. In the United States, NACA took the lead as suggested before. If

one includes its autogiro work, rotary wing aircraft got fair treatment before World War II. The first NACA report on helicopters was released in 1920 (Technical Note 4). Aside from other reports on European activities, this document was followed by one in 1925 by Alexander Klemin. The author was an early proponent of the helicopter and an early educator on the subject. Within this time interval, the only testing at NACA involved a propeller-type rotor in forward flight. All helicopter work was dropped with the advent of the autogiro in the early 1920s, but it was revived in the 1940s. Practically all the basic helicopter theory and testing emerged from work by this organization.

In general, the criticism directed at mechanical flight in the 19th century was not differentiated. But there was divergence toward the end of the century and into the next one. Certainly the drift was due to the positive progress with the fixed wing principle. In contrast rotary wing proponents still had to endure criticism and apparently rely mostly on faith that the machine could be made practical.

Considering the variety of prototype flying machines and their powerplants, comment is sparse on the noise signature such devices make, something that becomes very evident even to its creator on the first runup of these unique devices. Noise pattern can be reviewed from both historical and contemporary aspects. The latter is a problem of increasing concern.

Noise as a positive value was mentioned in conjunction with James Watt. Chalmers (1908) vividly described the sound of his rotor system. A contraption that looked suspect to begin with could easily sway public to ridicule by the sound it made. The notion of unanticipated acoustical phenomena extended into the 1950s when blade tip engines on jet-propelled helicopters were first run up. In one case the noise of a two-seat pulsejet helicopter with its tip-mounted (buzz bomb) engines could be heard about 7 kilometers (6 miles) away. The pulsejet emitted an organ-trumpet sound while the ramjet produced a high pitch sound due to the high tip speeds necessary for operation.

With the modern, tail rotor helicopter one could anticipate the tail rotor noise because it is a kind of propeller. But it is unlikely anyone expected the “blade slap” sound characteristic of helicopters under certain flight conditions. Blade slap is due to rapid air pressure variations on the main rotor blades. The phenomenon is strongest (loudest) when the helicopter is descending in its own wake (air vortices), particularly in the 113–145 km/h (70–90 mph) speed range. However the slap is not always very loud. The movie *Apocalypse Now* had a long helicopter sequence featuring as much blade slap as helicopters. As suggested above, helicopter noise has become a major design problem regarding wider, close-in public acceptance.

The specifics described immediately above do not suggest the underlying social view of science and technology that is spotted throughout this book. 19th century attitudes were highly favorable of their benefits, ignoring the human consequences. A general optimism and faith that science and technology could solve all problems was strong in America in the last half of that century. Aspects of the view are

touched on in different parts of the book: the New York Crystal Palace Exhibition of 1853, steam power, the telegraph, interest in balloons and aerial flight in general, and the periodical, *Scientific American*[,] created (1845) to record this spirit. The truth is technical solutions do not solve social problems, but they can create them.

The turn of the century revealed an attitude change. There emerged skepticism that all science in conjunction with a pliable and abundant Nature produced nothing but good. Science fiction writers, particularly the later Verne described here, and H. G. Wells wrote of the dark side of this benevolence. It is curious a similar skepticism is emerging at the turn of the 20th century, a subject fit for a new, revealing book on social philosophy. Even so, there is no stopping the evolution of technology.

The foregoing accounted for public reaction to the helicopter of the past. There is also a public reaction to the helicopter of the present. While there seems to be a general acceptance of the helicopter as an appealing and useful aircraft, there are significant numbers who perceive this machine in negative ways, implying fear and dread, at least as a result of presentations in TV shows, in films, and in the print media, i.e., novels, science fiction, and comics. (Use for TV news reporting tells a different story.)

The helicopter is seen and presented as a lethal instrument devoid of accountability, representing law and order, arrogance, and power. Advertising offers its own image, exhibiting the helicopter as a symbol of status, privilege, and wealth. Mysterious government activities, with potential for destruction devoid of credible explanation[,] reinforce even further this negative view. These perceptions are hardly the ones of its early visionaries, way back to Mortimer Nelson (1865). Nonetheless it is a practical statement of the uses of technology when released to the public.

The proper response to these unfavorable views is for its sources to present a balanced picture, ultimately favorable to what the helicopter is about. This response is unlikely so long as sensationalism sells. The helicopter today is a novelty, a ready subject for this exploitation. It is important for individuals to understand the helicopter is far more than the fantasies created by various forms of entertainment.

Consider the following. Combining military and civil versions, there are about 38,000 helicopters flying today, the world over. Roughly half are in civil operations. All these helicopters are doing work less desirable or not feasible by other means, work that is not often brought to public attention in the news or via the entertainment media. Some such as emergency medical services (EMS) when shown are taken for granted.

Military operations include extensive flight training, combat simulation, field exercises, and others of a utility nature (transport, search and rescue, EMS). Civil operations are more varied, covering training, corporate services, charter work (logging, crop dusting, EMS, aerial photography—including filming evil helicopters, fire-fighting), and scheduled transport, as oil rig servicing.

One possible explanation for the subjective, negative view of many, is the general public has little personal contact to date with the helicopter and no control of it, unlike the association with fixed-wing aircraft. Whatever are the failings of the latter, these are kept in perspective because of airplanes' utility in daily life. As a prospect, the more people are familiar and involved usefully with helicopters the more control they will have over them. The less will be the alienation and speculation over the true role of the helicopter in their lives.

The concluding part of this account of early rotary wing ideas and projects is a reflection on this activity in a wider context. Specifically, the part considers the work in relation to technical progress in general, today's counterparts of the early entrepreneurs and inventors, the military and civil systems that have emerged, the political and international environment, and finally an overview of what the pioneers of the 19th and early 20th centuries were all about.

Here technical progress has two features. One is the time-lag between the idea and its practical application, commented on previously in specific cases. The other is progress itself in technology creation.

Considering the time-lag first, it was noted that heated activity in mechanical flight began in the middle years of the 19th century, about 70 years after the first manned balloon flight. A second lag in this period concerns the initial development of the internal combustion engine, with its delay in aircraft application of about 40 years. A third lag refers to the practical rotor for a helicopter, including the flapping hinge (along with low disk loading). The idea of a flapping hinge was published as early as 1911. A hinge patent existed in 1913 and in the early 1920s the autogiro demonstrated the practical need for the hinge. Yet it was not until the late 1930s that the idea was incorporated in the successful helicopter.

These lags are acceptance anomalies that have diminished with time into the present era. That is, today the gap between a new concept (or problem) and its practical application (or resolution) is much narrower. A new idea seems to find spontaneous applications. Most likely the receptivity phenomenon is due to the effects of global mobility and communication. Both are brought on by technology itself. This dispersion has been called "stimulus diffusion". People catch on faster today than they did years ago.

The interest in mechanical flight in mid-19th century took place during the Industrial Revolution. But such is not an explanation. Most likely it involves a system of circumstances. Supporting a previous remark, a reason the balloon pre-empted other ideas is that it worked, becoming the accepted way to travel through the air. As Robur discovered, progress in manned flight was then merely a matter of improving the idea, by adding propellers and shaping the bag.

The dominance of the balloon for such a long period revealed its shortcomings and limitations, important preconditions for change. The deficiencies reinforced the view of advocates of mechanical flight, even though some others believed the quest was in the same category as perpetual motion.

Refuting the negatives were measurements with lifting surfaces that demonstrated feasibility, followed by manned glider flights. Now the focus was on fixed wings. There was obvious progress in this approach, and the reasoned view put priority on this form of flight. While there was convergence toward practical fixed wing flight, helicopter advocates had to wait longer to show comparable progress.

The second feature listed above referred to technical progress itself in technology creation. In the long view technological innovation has proceeded along a line that can be seen as logarithmic. There were “bursts” of innovation along the way, and periods of stagnation. (One author postulated “geniuses” through history appeared in clusters.) “Stagnation” refers to periods when the status-quo resisted such progress. Even so, such a curve describes the general trend. Until the Second World War the creation and diffusion of knowledge was relatively slow. That war represents the bend in the curve that shoots upward (the eminence of stimulus diffusion). One could argue the bend existed in the First World War. In terms of human history the 25 year difference is not significant.

The idea of the wheel is at least 5000 years old, and carts and four wheel wagons are just as old. However it was not until about 800 A.D. that wagon builders introduced the pivot for the front wheels useful for making tighter turns. Today the idea is one that would almost immediately suggest itself. The Romans thought of it but chose the short wheel base wagons instead, apparently an early example of an army favoring mission and maintainability over maneuverability and vulnerability. (An army of maneuver would have made the opposite choice.) The steam and windmill ideas of Heron mentioned earlier in conjunction with toys, also had no followup until centuries later. It took a millennium for the helicopter toy to travel from China to Europe, if it came that way at all.

The notion of “progress” itself is relatively new. Most likely in old times before the “bend”, technology responded to immediate needs. People lived by tradition, a solidifying concept. Aside from religion, they had little else to go by. Their vision was limited to the seasons, not technology. Innovation implies a break in the traditional way of doing things. Today progress, being “modern”, is a value in itself regardless of the worth of the output. Needs are created in a consumer economy. Consistent with the location of this bend is the remark by a 19th century historian (Henry Adams), anticipating the oncoming 20th century. “The American boy of 1854 stood nearer the year 1 than the year 1900.”

Today, evolving technical innovation is different because it affects social human factors and the individual’s very biological structure, with a concurrent impact on values. (A value attached to an object becomes an attitude.) “Technology”, critical as it is, still lacks the status or focus of, for example “the economy”. Often technology is subsumed by it even though technology has a separate existence, and is driving society. The availability is such that priorities must be established in the specific technologies through its social value. The view impacts on helicopters as well as other forms of technical innovation. Progress

in this field is not defined by the technology itself, but by the social value and politics it engenders.

A characteristic of the 21st century is the concern for placing limitations on technical progress not by technology but by a new social, environmental, and global consciousness that will impose moral values and priorities on it. The helicopter with its simple and significant hover capability will always be part of this progress. The question is, how many?

The introductions and narratives revealed two types of investigators termed inventive and scientific (or technical). The former described one who relies more on intuition than formal technical discipline, in undertaking helicopter work. The latter applies a trained, systematic approach to this activity. One can identify the current counterparts of these advocates.

Except possibly for patents, the (helicopter) inventive type has disappeared from public notice. As mentioned before, in the 1950s there were numerous helicopter projects in the United States. (A repeat of fixed-wing builders after the First World War.) Many were independent, inventive individuals who worked with models or prototypes. Their disappearance is attributed to the success of the helicopter itself, the complexity in defining current problems, the development costs, the lack of investor interest, and the idea the hovering problem was “solved”.

Today these inventive individuals are replaced by amateur technicians (home or kit builders) interested in constructing their own helicopters of a proven design. Those who design the kits are innovators but work at a different level from those who searched for the practical helicopter. Equally significant is the difference in available knowledge, materials, and components.

The scientific counterpart is found mostly within the helicopter industry itself (often including academia). The maturing process leads to specialization. Now specialists are the foundation of the industry. This specialization leads to projects led by a program or systems manager. One replaces the independent entrepreneur of earlier years, but they are not interchangeable.

The modern manager should have both the tenacity of the entrepreneur (“defending the design”) and a technical understanding of one’s subject. The earlier scientific type showed more interest in technology than management. The specialized approach depersonalizes the program. With large programs (or large companies) visibility is lost, except for the few at the top level. The systems engineering concept in the present sense does not create, for it deals with process or methodology. An organization will have a special creative staff, typically the “advanced design” group. Here is the place for today’s technical entrepreneur. Methodology itself as a discipline is an important characteristic of modern engineering, replacing the “groping” of earlier years. Today in industry there are both “technical engineers” and “systems engineers.”

The startup technical entrepreneur in the helicopter field is scarce today, in contrast to software applications designers, for example. As suggested above, the

scarcity is due mainly to the costs involved and the lack of venture capital interest. A more subtle point concerns the fact a hovering rotor is a very simple, unsophisticated device, once they got the parameters right. As a result there is little room for a breakthrough in hovering systems, except in simplifying the helicopter itself. Further, there is a limit to how fast a rotor can be flown edgewise through the air. For these reasons the VTOL is the direction for major changes but at the sacrifice of hover capability.

Technology always had two branches, military and civil. In fact military engineering was one of the first technical professions. Except for the ephemeral, Civil War activity and the DeBothezat helicopter project, the full span of the narratives reveal no military influence. Since the advent of the practical helicopter, the military have been the driving force behind helicopter development. This branch of technology has lived up to all the expectations put on the military idea of the helicopter, and in a relatively short time. From the historical viewpoint this is a remarkable achievement by the industry, yet one taken for granted.

In reflecting on the number of good ideas the early entrepreneurs advanced that were ignored, one can appreciate the value of urgent military necessity in forcing positive development. This notion is exemplified in the dramatic difference in aircraft quality before and after two world wars, and in today's progress in military helicopters versus commercial ones.

One can conclude it is an aspect of human behavior passed down in history that the absence of war is an opportunity cost to technology, not made up by the "commercial spirit". Being "lean and mean" by definition creates nothing. It means withdrawal and consolidation. The kind of technology described here requires patrons. Often with technology, the government is the biggest patron of all. In recent times the military role has been in a state of flux as is its financial support of the helicopter. The prospects are for integration of civil and military requirements and technology. International trends indicate a widening of the use of helicopters in matters of prominence in the 21st century: conservation, ecology, inspection and peacekeeping, these in addition to humanitarian missions. Oddly enough, the last is not free of hostile resistance.

In recent years the civil (commercial) branch benefited from the military developments. The two, fundamental vehicles envisioned by the early rotary wing advocates have yet to be realized. These are the personal or private helicopter and the scheduled intercity or feeder helicopter. Success in both these areas would increase use far beyond the present operations. Despite progress in the technology itself, the helicopter today is a special purpose vehicle. Its strong suit waits to be played.

In the 1940s a well-known helicopter pioneer predicted in a decade or so, people would be visiting each other in their private helicopters. Toward the end of World War II many articles were written on the privately owned helicopter to come (Figure 4.1) [*not reproduced*]. Now the concept is given little thought. In the light of today's helicopters, the notion is fanciful. Aside from the vehicle design problem

itself, such a concept (the private helicopter) cannot exist except as part of a vast system of its own.

The common motor vehicle, a modern utensil, is part of a system so extensive that a substantial part of the population is employed in the field of transportation. The environment has been altered in many ways, first to accommodate it, but now to its disadvantage. Today its negative impact is increasingly in public consciousness.

The problem of introducing a new system concerns not only vehicle design, but it encompasses the new, extensive system itself, one that must compete with the old existing vehicle system. Even though there is a case for the private helicopter, the technology requires development, and there is always room for optimism. Humans used the horse for at least 4000 years, yet it was wiped out by the motor vehicle in about 40 years. By doing nothing the latter will get its four thousand year run. Think of it.

The technology does exist for the commercial, short haul transport helicopter. Considering “public convenience and necessity”, ground and air traffic congestion, limited airport space, and noise, the helicopter offers more in new possibilities than the fixed wing aircraft, when moving goods and people over short distances.

Like the private helicopter, the early vision remains unfulfilled (Figure 4.2) [*not reproduced*]. The industry has failed to capitalize on the inherent advantages of the transport concept, the very reason historically individuals aspired and strived to produce a craft that could hover and fly vertically. Once the helicopter was created, this idea was set aside.

A basic problem is the craft attempts to compete with the fixed-wing counterpart on the latter's terms. The helicopter (in studies at least) tries to fit into the fixed-wing system that pervades the country. Needed is a new philosophy for an independent heliport system, a national grid taking in the whole country, dedicated to intercity (including small city) transport and shuttle service. City-center operations and airline through traffic, physically are not part of this concept. Integration with the latter would require future reshuffling of the total concept of air travel.

The heliports are scaled down, unique versions of airports created in uncongested areas. Each is paired to another city and assigned its own “catch region”. The philosophy resembles that in creating a modern mall, but not in imitation of it. The venue suggests the idea behind location of industrial parks, which imply the same geographical purpose. Such heliports are accessible by surface vehicles (autos, buses, taxis, limousines) via new roads, away from today's traffic flow.

A pilot system would spot the heliports near New York City and Washington. The vehicle should carry around 100 passengers, with noise attenuation and all-weather capability as major design requirements. The useful load is to include passengers, mail, and express goods. To the benefits of public transportation are those related to new forms of employment including one that maintains a skilled technical pool.

Funding for such a system is accounted for in phases. The startup activity is a joint venture including government, industry, and capital (venture, debt, equity). The initial shortfall is made up in (federal, state, local) subsidy.

It can be noted the airlines were originally subsidized. The above financing approach makes more sense than the endemic, periodic bailout of private ventures, a kind of unwitting subsidy paid retroactively. With responsible regulation, the money would be put to use in serving useful social ends.

In general it is likely every public transportation system worldwide requires a subsidy, either visible or invisible. It is inherent in any public transportation system that the more people who are served, the more inefficient the service is. The most efficient government provides no service at all. Aside from being anarchic[,] consider the following. Many people do not fly, but pay their share of the national airway system. If only fliers paid, the airfare would include a substantial, pro-rated portion of the airway operation and maintenance costs. To argue the non-flier benefits indirectly is correct. But this presumes two classes of citizens. Ultimately the decision is one of the cost-benefit to society of this new mode of travel.

The civil-military boost should come from a basic, purposeful national industrial policy. A concept of increasing need in view of the intense competitiveness of the modern, interdependent global economy.

The 1950s bend in the curve described previously has a peculiar American significance. Around that time there was a coarse rule (the author's) regarding technology. Whatever were the fruits of it, the United States owned 40–50 percent of the world total. A check of an almanac will verify this. (History is repeating itself today with computers.) Since that period the rest of the world is rightfully gaining an increasing share. Even so, the wealth of a country is not what it owns, but what it produces and exports.

Without a vision as described above, the worldwide helicopter industry is greater than is the demand for helicopters. Added to this problem is the large number of military surplus helicopters on the market. Devoid of vision[,] the industry implodes rather than explodes. In view of the increasing global interaction and interdependence, people of all nations are questioning their identity and the limits of nationalism. If history teaches anything it is that change is normal, that we have not reached the rotary wing End of Technology, that the goal of social expenditure is now only to support its entropy.

An industrial policy should not only support the helicopter industry but aviation in general. For its aeronautical achievements have benefited world commerce, and at the same time upgraded the technology and methodology of other disciplines. This wider support should involve the ultimate transportation concept (terrestrial, at least). Such a concept implies activity well into the 21st century.

Two voids in this ultimate spectrum refer to global mass travel (GMT), and the previously noted personal helicopter. The automobile will continuously amplify its qualities as both a boon and bane to society.

The boon is in low cost global travel by means of Atlantic and Pacific car ferries, traveling over water at high speed using the air cushion principle. Such giants will carry thousands of cars in a roll-on, roll-off mode. The powerplant system is in the thousand megawatt range. With fusion energy as the power source, electricity is supplied to super-conducting motors, used for both lift and propulsion.

Considering the bane, the private auto is in a Malthusian bind. The number of cars keeps increasing (even with possible population control) but the number of new, desirable urban venues is practically constant. This bind results in increasing congestion, gridlock, quality time loss (in engine-idle), exhaust pollution, and emotional dysfunction.

By default people will be compelled to take to the air, opening up more desirable land in the process. The helicopter is the only vehicle that can meet this need. When the need becomes a necessity, the public will accommodate the new aerial system that will one day be as comprehensive and pervasive as the present automobile system. Recall the horse and the improbability of the auto replacing it. The total concept involves more than travel. The new technologies will provide work for women and men in a stream for generations. There is little doubt of the enduring social value of these concepts.

Such ventures require leadership, possessing inspired vision combined with the drive and resources to follow through. These ventures can and should be defining features of the 21st century.

Viewing in retrospect the helicopters and variants of the 19th and early 20th centuries, it is unusual for an ultimately successful technology to unfold such consistent inappropriateness even though the components for success were being revealed with time and in parallel. One cannot conclude the helicopter "evolved" in this period, as did the airplane. In truth the helicopter "mushroomed" in the late 1930s. These early efforts were a chaotic collection of ideas and activities, all sharing a common objective.

Hindsight is good vision, and hindsight teaches something. While of little significance to evolution, one values in these helicopter pioneers the dedication, seriousness, enthusiasm, and entrepreneurial spirit. One recalls an Italian saying, "the results were indifferent, but the performance was spectacular". They knew what they wanted but overall, they were a group whose reach exceeded their grasp.

NASA History Series

Reference Works, NASA SP-4000

Grimwood, James M. *Project Mercury: A Chronology*. NASA SP-4001, 1963.

Grimwood, James M., and Barton C. Hacker, with Peter J. Vorzimmer. *Project Gemini Technology and Operations: A Chronology*. NASA SP-4002, 1969.

Link, Mae Mills. *Space Medicine in Project Mercury*. NASA SP-4003, 1965.

Astronautics and Aeronautics, 1963: Chronology of Science, Technology, and Policy. NASA SP-4004, 1964.

Astronautics and Aeronautics, 1964: Chronology of Science, Technology, and Policy. NASA SP-4005, 1965.

Astronautics and Aeronautics, 1965: Chronology of Science, Technology, and Policy. NASA SP-4006, 1966.

Astronautics and Aeronautics, 1966: Chronology of Science, Technology, and Policy. NASA SP-4007, 1967.

Astronautics and Aeronautics, 1967: Chronology of Science, Technology, and Policy. NASA SP-4008, 1968.

Ertel, Ivan D., and Mary Louise Morse. *The Apollo Spacecraft: A Chronology, Volume I, Through November 7, 1962*. NASA SP-4009, 1969.

Morse, Mary Louise, and Jean Kernahan Bays. *The Apollo Spacecraft: A Chronology, Volume II, November 8, 1962–September 30, 1964*. NASA SP-4009, 1973.

Brooks, Courtney G., and Ivan D. Ertel. *The Apollo Spacecraft: A Chronology, Volume III, October 1, 1964–January 20, 1966*. NASA SP-4009, 1973.

Ertel, Ivan D., and Roland W. Newkirk, with Courtney G. Brooks. *The Apollo Spacecraft: A Chronology, Volume IV, January 21, 1966–July 13, 1974*. NASA SP-4009, 1978.

Astronautics and Aeronautics, 1968: Chronology of Science, Technology, and Policy. NASA SP-4010, 1969.

Newkirk, Roland W., and Ivan D. Ertel, with Courtney G. Brooks. *Skylab: A Chronology*. NASA SP-4011, 1977.

Van Nimmen, Jane, and Leonard C. Bruno, with Robert L. Rosholt. *NASA Historical Data Book, Volume I: NASA Resources, 1958–1968*. NASA SP-4012, 1976; rep. ed. 1988.

Ezell, Linda Neuman. *NASA Historical Data Book, Volume II: Programs and Projects, 1958–1968*. NASA SP-4012, 1988.

Ezell, Linda Neuman. *NASA Historical Data Book, Volume III: Programs and Projects, 1969–1978*. NASA SP-4012, 1988.

Gawdiak, Ihor, with Helen Fedor. *NASA Historical Data Book, Volume IV: NASA Resources, 1969–1978*. NASA SP-4012, 1994.

Rumerman, Judy A. *NASA Historical Data Book, Volume V: NASA Launch Systems, Space Transportation, Human Spaceflight, and Space Science, 1979–1988*. NASA SP-4012, 1999.

Rumerman, Judy A. *NASA Historical Data Book, Volume VI: NASA Space Applications, Aeronautics and Space Research and Technology, Tracking and Data Acquisition/Support Operations, Commercial Programs, and Resources, 1979–1988*. NASA SP-4012, 1999.

Rumerman, Judy A. *NASA Historical Data Book, Volume VII: NASA Launch Systems, Space Transportation, Human Spaceflight, and Space Science, 1989–1998*. NASA SP-2009-4012, 2009.

Rumerman, Judy A. *NASA Historical Data Book, Volume VIII: NASA Earth Science and Space Applications, Aeronautics, Technology, and Exploration, Tracking and Data Acquisition/Space Operations, Facilities and Resources, 1989–1998*. NASA SP-2012-4012, 2012.

No SP-4013.

Astronautics and Aeronautics, 1969: Chronology of Science, Technology, and Policy. NASA SP-4014, 1970.

Astronautics and Aeronautics, 1970: Chronology of Science, Technology, and Policy. NASA SP-4015, 1972.

Astronautics and Aeronautics, 1971: Chronology of Science, Technology, and Policy. NASA SP-4016, 1972.

Astronautics and Aeronautics, 1972: Chronology of Science, Technology, and Policy. NASA SP-4017, 1974.

Astronautics and Aeronautics, 1973: Chronology of Science, Technology, and Policy. NASA SP-4018, 1975.

Astronautics and Aeronautics, 1974: Chronology of Science, Technology, and Policy. NASA SP-4019, 1977.

Astronautics and Aeronautics, 1975: Chronology of Science, Technology, and Policy. NASA SP-4020, 1979.

Astronautics and Aeronautics, 1976: Chronology of Science, Technology, and Policy. NASA SP-4021, 1984.

Astronautics and Aeronautics, 1977: Chronology of Science, Technology, and Policy. NASA SP-4022, 1986.

Astronautics and Aeronautics, 1978: Chronology of Science, Technology, and Policy. NASA SP-4023, 1986.

Astronautics and Aeronautics, 1979–1984: Chronology of Science, Technology, and Policy. NASA SP-4024, 1988.

Astronautics and Aeronautics, 1985: Chronology of Science, Technology, and Policy. NASA SP-4025, 1990.

Noordung, Hermann. *The Problem of Space Travel: The Rocket Motor.* Edited by Ernst Stuhlinger and J. D. Hunley, with Jennifer Garland. NASA SP-4026, 1995.

Gawdiak, Ihor Y., Ramon J. Miro, and Sam Stueland. *Astronautics and Aeronautics, 1986–1990: A Chronology.* NASA SP-4027, 1997.

Gawdiak, Ihor Y., and Charles Shetland. *Astronautics and Aeronautics, 1991–1995: A Chronology.* NASA SP-2000-4028, 2000.

Orloff, Richard W. *Apollo by the Numbers: A Statistical Reference.* NASA SP-2000-4029, 2000.

Lewis, Marieke, and Ryan Swanson. *Astronautics and Aeronautics: A Chronology, 1996–2000.* NASA SP-2009-4030, 2009.

Ivey, William Noel, and Marieke Lewis. *Astronautics and Aeronautics: A Chronology, 2001–2005.* NASA SP-2010-4031, 2010.

Buchalter, Alice R., and William Noel Ivey. *Astronautics and Aeronautics: A Chronology, 2006.* NASA SP-2011-4032, 2010.

Lewis, Marieke. *Astronautics and Aeronautics: A Chronology, 2007.* NASA SP-2011-4033, 2011.

Lewis, Marieke. *Astronautics and Aeronautics: A Chronology, 2008.* NASA SP-2012-4034, 2012.

Lewis, Marieke. *Astronautics and Aeronautics: A Chronology, 2009*. NASA SP-2012-4035, 2012.

Flattery, Meaghan. *Astronautics and Aeronautics: A Chronology, 2010*. NASA SP-2013-4037, 2014.

Siddiqi, Asif A. *Beyond Earth: A Chronicle of Deep Space Exploration, 1958–2016*. NASA SP-2018-4041, 2018.

Management Histories, NASA SP-4100

Rosholt, Robert L. *An Administrative History of NASA, 1958–1963*. NASA SP-4101, 1966.

Levine, Arnold S. *Managing NASA in the Apollo Era*. NASA SP-4102, 1982.

Roland, Alex. *Model Research: The National Advisory Committee for Aeronautics, 1915–1958*. NASA SP-4103, 1985.

Fries, Sylvia D. *NASA Engineers and the Age of Apollo*. NASA SP-4104, 1992.

Glennan, T. Keith. *The Birth of NASA: The Diary of T. Keith Glennan*. Edited by J. D. Hunley. NASA SP-4105, 1993.

Seamans, Robert C. *Aiming at Targets: The Autobiography of Robert C. Seamans*. NASA SP-4106, 1996.

Garber, Stephen J., ed. *Looking Backward, Looking Forward: Forty Years of Human Spaceflight Symposium*. NASA SP-2002-4107, 2002.

Mallick, Donald L., with Peter W. Merlin. *The Smell of Kerosene: A Test Pilot's Odyssey*. NASA SP-4108, 2003.

Iliff, Kenneth W., and Curtis L. Peebles. *From Runway to Orbit: Reflections of a NASA Engineer*. NASA SP-2004-4109, 2004.

Chertok, Boris. *Rockets and People, Volume I*. NASA SP-2005-4110, 2005.

Chertok, Boris. *Rockets and People: Creating a Rocket Industry, Volume II*. NASA SP-2006-4110, 2006.

Chertok, Boris. *Rockets and People: Hot Days of the Cold War, Volume III*. NASA SP-2009-4110, 2009.

Chertok, Boris. *Rockets and People: The Moon Race, Volume IV*. NASA SP-2011-4110, 2011.

Laufer, Alexander, Todd Post, and Edward Hoffman. *Shared Voyage: Learning and Unlearning from Remarkable Projects*. NASA SP-2005-4111, 2005.

Dawson, Virginia P., and Mark D. Bowles. *Realizing the Dream of Flight: Biographical Essays in Honor of the Centennial of Flight, 1903–2003*. NASA SP-2005-4112, 2005.

Mudgway, Douglas J. *William H. Pickering: America's Deep Space Pioneer*. NASA SP-2008-4113, 2008.

Wright, Rebecca, Sandra Johnson, and Steven J. Dick. *NASA at 50: Interviews with NASA's Senior Leadership*. NASA SP-2012-4114, 2012.

Project Histories, NASA SP-4200

Swenson, Loyd S., Jr., James M. Grimwood, and Charles C. Alexander. *This New Ocean: A History of Project Mercury*. NASA SP-4201, 1966; rep. ed. 1999.

Green, Constance McLaughlin, and Milton Lomask. *Vanguard: A History*. NASA SP-4202, 1970; rep. ed. Smithsonian Institution Press, 1971.

Hacker, Barton C., and James M. Grimwood. *On the Shoulders of Titans: A History of Project Gemini*. NASA SP-4203, 1977; rep. ed. 2002.

Benson, Charles D., and William Barnaby Faherty. *Moonport: A History of Apollo Launch Facilities and Operations*. NASA SP-4204, 1978.

Brooks, Courtney G., James M. Grimwood, and Loyd S. Swenson, Jr. *Chariots for Apollo: A History of Manned Lunar Spacecraft*. NASA SP-4205, 1979.

Bilstein, Roger E. *Stages to Saturn: A Technological History of the Apollo/Saturn Launch Vehicles*. NASA SP-4206, 1980 and 1996.

No SP-4207.

Compton, W. David, and Charles D. Benson. *Living and Working in Space: A History of Skylab*. NASA SP-4208, 1983.

Ezell, Edward Clinton, and Linda Neuman Ezell. *The Partnership: A History of the Apollo-Soyuz Test Project*. NASA SP-4209, 1978.

Hall, R. Cargill. *Lunar Impact: A History of Project Ranger*. NASA SP-4210, 1977.

Newell, Homer E. *Beyond the Atmosphere: Early Years of Space Science*. NASA SP-4211, 1980.

Ezell, Edward Clinton, and Linda Neuman Ezell. *On Mars: Exploration of the Red Planet, 1958–1978*. NASA SP-4212, 1984.

Pitts, John A. *The Human Factor: Biomedicine in the Manned Space Program to 1980*. NASA SP-4213, 1985.

Compton, W. David. *Where No Man Has Gone Before: A History of Apollo Lunar Exploration Missions*. NASA SP-4214, 1989.

Naugle, John E. *First Among Equals: The Selection of NASA Space Science Experiments*. NASA SP-4215, 1991.

Wallace, Lane E. *Airborne Trailblazer: Two Decades with NASA Langley's 737 Flying Laboratory*. NASA SP-4216, 1994.

Butrica, Andrew J., ed. *Beyond the Ionosphere: Fifty Years of Satellite Communications*. NASA SP-4217, 1997.

Butrica, Andrew J. *To See the Unseen: A History of Planetary Radar Astronomy*. NASA SP-4218, 1996.

Mack, Pamela E., ed. *From Engineering Science to Big Science: The NACA and NASA Collier Trophy Research Project Winners*. NASA SP-4219, 1998.

Reed, R. Dale. *Wingless Flight: The Lifting Body Story*. NASA SP-4220, 1998.

Heppenheimer, T. A. *The Space Shuttle Decision: NASA's Search for a Reusable Space Vehicle*. NASA SP-4221, 1999.

Hunley, J. D., ed. *Toward Mach 2: The Douglas D-558 Program*. NASA SP-4222, 1999.

Swanson, Glen E., ed. *"Before This Decade Is Out..." Personal Reflections on the Apollo Program*. NASA SP-4223, 1999.

Tomayko, James E. *Computers Take Flight: A History of NASA's Pioneering Digital Fly-By-Wire Project*. NASA SP-4224, 2000.

Morgan, Clay. *Shuttle-Mir: The United States and Russia Share History's Highest Stage*. NASA SP-2001-4225, 2001.

Leary, William M. *"We Freeze to Please": A History of NASA's Icing Research Tunnel and the Quest for Safety*. NASA SP-2002-4226, 2002.

Mudgway, Douglas J. *Uplink-Downlink: A History of the Deep Space Network, 1957–1997*. NASA SP-2001-4227, 2001.

No SP-4228 or SP-4229.

Dawson, Virginia P., and Mark D. Bowles. *Taming Liquid Hydrogen: The Centaur Upper Stage Rocket, 1958–2002*. NASA SP-2004-4230, 2004.

Meltzer, Michael. *Mission to Jupiter: A History of the Galileo Project*. NASA SP-2007-4231, 2007.

Heppenheimer, T. A. *Facing the Heat Barrier: A History of Hypersonics*. NASA SP-2007-4232, 2007.

Tsiao, Sunny. “Read You Loud and Clear!” *The Story of NASA’s Spaceflight Tracking and Data Network*. NASA SP-2007-4233, 2007.

Meltzer, Michael. *When Biospheres Collide: A History of NASA’s Planetary Protection Programs*. NASA SP-2011-4234, 2011.

Gainor, Christopher. *Not Yet Imagined: A Study of Hubble Space Telescope Operations*. NASA SP-2020-4237, 2020.

Center Histories, NASA SP-4300

Rosenthal, Alfred. *Venture into Space: Early Years of Goddard Space Flight Center*. NASA SP-4301, 1985.

Hartman, Edwin P. *Adventures in Research: A History of Ames Research Center, 1940–1965*. NASA SP-4302, 1970.

Hallion, Richard P. *On the Frontier: Flight Research at Dryden, 1946–1981*. NASA SP-4303, 1984.

Muenger, Elizabeth A. *Searching the Horizon: A History of Ames Research Center, 1940–1976*. NASA SP-4304, 1985.

Hansen, James R. *Engineer in Charge: A History of the Langley Aeronautical Laboratory, 1917–1958*. NASA SP-4305, 1987.

Dawson, Virginia P. *Engines and Innovation: Lewis Laboratory and American Propulsion Technology*. NASA SP-4306, 1991.

Dethloff, Henry C. “Suddenly Tomorrow Came...”: *A History of the Johnson Space Center, 1957–1990*. NASA SP-4307, 1993.

Hansen, James R. *Spaceflight Revolution: NASA Langley Research Center from Sputnik to Apollo*. NASA SP-4308, 1995.

Wallace, Lane E. *Flights of Discovery: An Illustrated History of the Dryden Flight Research Center*. NASA SP-4309, 1996.

Herring, Mack R. *Way Station to Space: A History of the John C. Stennis Space Center*. NASA SP-4310, 1997.

Wallace, Harold D., Jr. *Wallops Station and the Creation of an American Space Program*. NASA SP-4311, 1997.

Wallace, Lane E. *Dreams, Hopes, Realities. NASA's Goddard Space Flight Center: The First Forty Years*. NASA SP-4312, 1999.

Dunar, Andrew J., and Stephen P. Waring. *Power to Explore: A History of Marshall Space Flight Center, 1960–1990*. NASA SP-4313, 1999.

Bugos, Glenn E. *Atmosphere of Freedom: Sixty Years at the NASA Ames Research Center*. NASA SP-2000-4314, 2000.

Bugos, Glenn E. *Atmosphere of Freedom: Seventy Years at the NASA Ames Research Center*. NASA SP-2010-4314, 2010. Revised version of NASA SP-2000-4314.

Bugos, Glenn E. *Atmosphere of Freedom: Seventy Five Years at the NASA Ames Research Center*. NASA SP-2014-4314, 2014. Revised version of NASA SP-2000-4314.

No SP-4315.

Schultz, James. *Crafting Flight: Aircraft Pioneers and the Contributions of the Men and Women of NASA Langley Research Center*. NASA SP-2003-4316, 2003.

Bowles, Mark D. *Science in Flux: NASA's Nuclear Program at Plum Brook Station, 1955–2005*. NASA SP-2006-4317, 2006.

Wallace, Lane E. *Flights of Discovery: An Illustrated History of the Dryden Flight Research Center*. NASA SP-2007-4318, 2007. Revised version of NASA SP-4309.

Arrighi, Robert S. *Revolutionary Atmosphere: The Story of the Altitude Wind Tunnel and the Space Power Chambers*. NASA SP-2010-4319, 2010.

General Histories, NASA SP-4400

Corliss, William R. *NASA Sounding Rockets, 1958–1968: A Historical Summary*. NASA SP-4401, 1971.

Wells, Helen T., Susan H. Whiteley, and Carrie Karegeannes. *Origins of NASA Names*. NASA SP-4402, 1976.

Anderson, Frank W., Jr. *Orders of Magnitude: A History of NACA and NASA, 1915–1980*. NASA SP-4403, 1981.

Sloop, John L. *Liquid Hydrogen as a Propulsion Fuel, 1945–1959*. NASA SP-4404, 1978.

Roland, Alex. *A Spacefaring People: Perspectives on Early Spaceflight*. NASA SP-4405, 1985.

Bilstein, Roger E. *Orders of Magnitude: A History of the NACA and NASA, 1915–1990*. NASA SP-4406, 1989.

Logsdon, John M., ed., with Linda J. Lear, Jannelle Warren Findley, Ray A. Williamson, and Dwayne A. Day. *Exploring the Unknown: Selected Documents in the History of the U.S. Civil Space Program, Volume I: Organizing for Exploration*. NASA SP-4407, 1995.

Logsdon, John M., ed., with Dwayne A. Day and Roger D. Launius. *Exploring the Unknown: Selected Documents in the History of the U.S. Civil Space Program, Volume II: External Relationships*. NASA SP-4407, 1996.

Logsdon, John M., ed., with Roger D. Launius, David H. Onkst, and Stephen J. Garber. *Exploring the Unknown: Selected Documents in the History of the U.S. Civil Space Program, Volume III: Using Space*. NASA SP-4407, 1998.

Logsdon, John M., ed., with Ray A. Williamson, Roger D. Launius, Russell J. Acker, Stephen J. Garber, and Jonathan L. Friedman. *Exploring the Unknown: Selected Documents in the History of the U.S. Civil Space Program, Volume IV: Accessing Space*. NASA SP-4407, 1999.

Logsdon, John M., ed., with Amy Paige Snyder, Roger D. Launius, Stephen J. Garber, and Regan Anne Newport. *Exploring the Unknown: Selected Documents in the History of the U.S. Civil Space Program, Volume V: Exploring the Cosmos*. NASA SP-2001-4407, 2001.

Logsdon, John M., ed., with Stephen J. Garber, Roger D. Launius, and Ray A. Williamson. *Exploring the Unknown: Selected Documents in the History of the U.S. Civil Space Program, Volume VI: Space and Earth Science*. NASA SP-2004-4407, 2004.

Logsdon, John M., ed., with Roger D. Launius. *Exploring the Unknown: Selected Documents in the History of the U.S. Civil Space Program, Volume VII: Human Spaceflight: Projects Mercury, Gemini, and Apollo*. NASA SP-2008-4407, 2008.

Siddiqi, Asif A., *Challenge to Apollo: The Soviet Union and the Space Race, 1945–1974*. NASA SP-2000-4408, 2000.

Hansen, James R., ed. *The Wind and Beyond: Journey into the History of Aerodynamics in America, Volume 1: The Ascent of the Airplane*. NASA SP-2003-4409, 2003.

Hansen, James R., ed. *The Wind and Beyond: Journey into the History of Aerodynamics in America, Volume 2: Reinventing the Airplane*. NASA SP-2007-4409, 2007.

Hansen, James R., and Jeremy R. Kinney, eds. *The Wind and Beyond: A Documentary Journey into the History of Aerodynamics in America, Volume III: Other Paths, Other Flyways*. NASA SP-2021-4409, 2021.

Hogan, Thor. *Mars Wars: The Rise and Fall of the Space Exploration Initiative*. NASA SP-2007-4410, 2007.

Vakoch, Douglas A., ed. *Psychology of Space Exploration: Contemporary Research in Historical Perspective*. NASA SP-2011-4411, 2011.

Ferguson, Robert G. *NASA's First A: Aeronautics from 1958 to 2008*. NASA SP-2012-4412, 2013.

Vakoch, Douglas A., ed. *Archaeology, Anthropology, and Interstellar Communication*. NASA SP-2013-4413, 2014.

Asner, Glen R., and Stephen J. Garber. *Origins of 21st-Century Space Travel: A History of NASA's Decadal Planning Team and the Vision for Space Exploration, 1999–2004*. NASA SP-2019-4415, 2019.

Monographs in Aerospace History, NASA SP-4500

Launius, Roger D., and Aaron K. Gillette, comps. *Toward a History of the Space Shuttle: An Annotated Bibliography*. Monographs in Aerospace History, No. 1, 1992.

Launius, Roger D., and J. D. Hunley, comps. *An Annotated Bibliography of the Apollo Program*. Monographs in Aerospace History, No. 2, 1994.

Launius, Roger D. *Apollo: A Retrospective Analysis*. Monographs in Aerospace History, No. 3, 1994.

Hansen, James R. *Enchanted Rendezvous: John C. Houbolt and the Genesis of the Lunar-Orbit Rendezvous Concept*. Monographs in Aerospace History, No. 4, 1995.

Gorn, Michael H. *Hugh L. Dryden's Career in Aviation and Space*. Monographs in Aerospace History, No. 5, 1996.

Powers, Sheryll Goecke. *Women in Flight Research at NASA Dryden Flight Research Center from 1946 to 1995*. Monographs in Aerospace History, No. 6, 1997.

- Portree, David S. F., and Robert C. Trevino. *Walking to Olympus: An EVA Chronology*. Monographs in Aerospace History, No. 7, 1997.
- Logsdon, John M., moderator. *Legislative Origins of the National Aeronautics and Space Act of 1958: Proceedings of an Oral History Workshop*. Monographs in Aerospace History, No. 8, 1998.
- Rumerman, Judy A., comp. *U.S. Human Spaceflight: A Record of Achievement, 1961–1998*. Monographs in Aerospace History, No. 9, 1998.
- Portree, David S. F. *NASA's Origins and the Dawn of the Space Age*. Monographs in Aerospace History, No. 10, 1998.
- Logsdon, John M. *Together in Orbit: The Origins of International Cooperation in the Space Station*. Monographs in Aerospace History, No. 11, 1998.
- Phillips, W. Hewitt. *Journey in Aeronautical Research: A Career at NASA Langley Research Center*. Monographs in Aerospace History, No. 12, 1998.
- Braslow, Albert L. *A History of Suction-Type Laminar-Flow Control with Emphasis on Flight Research*. Monographs in Aerospace History, No. 13, 1999.
- Logsdon, John M., moderator. *Managing the Moon Program: Lessons Learned from Apollo*. Monographs in Aerospace History, No. 14, 1999.
- Perminov, V. G. *The Difficult Road to Mars: A Brief History of Mars Exploration in the Soviet Union*. Monographs in Aerospace History, No. 15, 1999.
- Tucker, Tom. *Touchdown: The Development of Propulsion Controlled Aircraft at NASA Dryden*. Monographs in Aerospace History, No. 16, 1999.
- Maisel, Martin, Demo J. Giulanetti, and Daniel C. Dugan. *The History of the XV-15 Tilt Rotor Research Aircraft: From Concept to Flight*. Monographs in Aerospace History, No. 17, 2000. NASA SP-2000-4517.
- Jenkins, Dennis R. *Hypersonics Before the Shuttle: A Concise History of the X-15 Research Airplane*. Monographs in Aerospace History, No. 18, 2000. NASA SP-2000-4518.
- Chambers, Joseph R. *Partners in Freedom: Contributions of the Langley Research Center to U.S. Military Aircraft of the 1990s*. Monographs in Aerospace History, No. 19, 2000. NASA SP-2000-4519.
- Waltman, Gene L. *Black Magic and Gremlins: Analog Flight Simulations at NASA's Flight Research Center*. Monographs in Aerospace History, No. 20, 2000. NASA SP-2000-4520.

Portree, David S. F. *Humans to Mars: Fifty Years of Mission Planning, 1950–2000*. Monographs in Aerospace History, No. 21, 2001. NASA SP-2001-4521.

Thompson, Milton O., with J. D. Hunley. *Flight Research: Problems Encountered and What They Should Teach Us*. Monographs in Aerospace History, No. 22, 2001. NASA SP-2001-4522.

Tucker, Tom. *The Eclipse Project*. Monographs in Aerospace History, No. 23, 2001. NASA SP-2001-4523.

Siddiqi, Asif A. *Deep Space Chronicle: A Chronology of Deep Space and Planetary Probes, 1958–2000*. Monographs in Aerospace History, No. 24, 2002. NASA SP-2002-4524.

Merlin, Peter W. *Mach 3+: NASA/USAF YF-12 Flight Research, 1969–1979*. Monographs in Aerospace History, No. 25, 2001. NASA SP-2001-4525.

Anderson, Seth B. *Memoirs of an Aeronautical Engineer: Flight Tests at Ames Research Center: 1940–1970*. Monographs in Aerospace History, No. 26, 2002. NASA SP-2002-4526.

Renstrom, Arthur G. *Wilbur and Orville Wright: A Bibliography Commemorating the One-Hundredth Anniversary of the First Powered Flight on December 17, 1903*. Monographs in Aerospace History, No. 27, 2002. NASA SP-2002-4527.

No monograph 28.

Chambers, Joseph R. *Concept to Reality: Contributions of the NASA Langley Research Center to U.S. Civil Aircraft of the 1990s*. Monographs in Aerospace History, No. 29, 2003. NASA SP-2003-4529.

Peebles, Curtis, ed. *The Spoken Word: Recollections of Dryden History, The Early Years*. Monographs in Aerospace History, No. 30, 2003. NASA SP-2003-4530.

Jenkins, Dennis R., Tony Landis, and Jay Miller. *American X-Vehicles: An Inventory—X-1 to X-50*. Monographs in Aerospace History, No. 31, 2003. NASA SP-2003-4531.

Renstrom, Arthur G. *Wilbur and Orville Wright: A Chronology Commemorating the One-Hundredth Anniversary of the First Powered Flight on December 17, 1903*. Monographs in Aerospace History, No. 32, 2003. NASA SP-2003-4532.

Bowles, Mark D., and Robert S. Arrighi. *NASA's Nuclear Frontier: The Plum Brook Research Reactor*. Monographs in Aerospace History, No. 33, 2004. NASA SP-2004-4533.

Wallace, Lane, and Christian Gelzer. *Nose Up: High Angle-of-Attack and Thrust Vectoring Research at NASA Dryden, 1979–2001*. Monographs in Aerospace History, No. 34, 2009. NASA SP-2009-4534.

Matranga, Gene J., C. Wayne Ottinger, Calvin R. Jarvis, and D. Christian Gelzer. *Unconventional, Contrary, and Ugly: The Lunar Landing Research Vehicle*. Monographs in Aerospace History, No. 35, 2006. NASA SP-2004-4535.

McCurdy, Howard E. *Low-Cost Innovation in Spaceflight: The History of the Near Earth Asteroid Rendezvous (NEAR) Mission*. Monographs in Aerospace History, No. 36, 2005. NASA SP-2005-4536.

Seamans, Robert C., Jr. *Project Apollo: The Tough Decisions*. Monographs in Aerospace History, No. 37, 2005. NASA SP-2005-4537.

Lambright, W. Henry. *NASA and the Environment: The Case of Ozone Depletion*. Monographs in Aerospace History, No. 38, 2005. NASA SP-2005-4538.

Chambers, Joseph R. *Innovation in Flight: Research of the NASA Langley Research Center on Revolutionary Advanced Concepts for Aeronautics*. Monographs in Aerospace History, No. 39, 2005. NASA SP-2005-4539.

Phillips, W. Hewitt. *Journey into Space Research: Continuation of a Career at NASA Langley Research Center*. Monographs in Aerospace History, No. 40, 2005. NASA SP-2005-4540.

Rumerman, Judy A., Chris Gamble, and Gabriel Okolski, comps. *U.S. Human Spaceflight: A Record of Achievement, 1961–2006*. Monographs in Aerospace History, No. 41, 2007. NASA SP-2007-4541.

Peebles, Curtis. *The Spoken Word: Recollections of Dryden History Beyond the Sky*. Monographs in Aerospace History, No. 42, 2011. NASA SP-2011-4542.

Dick, Steven J., Stephen J. Garber, and Jane H. Odom. *Research in NASA History*. Monographs in Aerospace History, No. 43, 2009. NASA SP-2009-4543.

Merlin, Peter W. *Ikhana: Unmanned Aircraft System Western States Fire Missions*. Monographs in Aerospace History, No. 44, 2009. NASA SP-2009-4544.

Fisher, Steven C., and Shamim A. Rahman. *Remembering the Giants: Apollo Rocket Propulsion Development*. Monographs in Aerospace History, No. 45, 2009. NASA SP-2009-4545.

Gelzer, Christian. *Fairing Well: From Shoebox to Bat Truck and Beyond, Aerodynamic Truck Research at NASA's Dryden Flight Research Center*. Monographs in Aerospace History, No. 46, 2011. NASA SP-2011-4546.

Arrighi, Robert. *Pursuit of Power: NASA's Propulsion Systems Laboratory No. 1 and 2*. Monographs in Aerospace History, No. 48, 2012. NASA SP-2012-4548.

Renee M. Rottner. *Making the Invisible Visible: A History of the Spitzer Infrared Telescope Facility (1971–2003)*. Monographs in Aerospace History, No. 47, 2017. NASA SP-2017-4547.

Goodrich, Malinda K., Alice R. Buchalter, and Patrick M. Miller, comps. *Toward a History of the Space Shuttle: An Annotated Bibliography, Part 2 (1992–2011)*. Monographs in Aerospace History, No. 49, 2012. NASA SP-2012-4549.

Ta, Julie B., and Robert C. Treviño. *Walking to Olympus: An EVA Chronology, 1997–2011*, Vol. 2. Monographs in Aerospace History, No. 50, 2016. NASA SP-2016-4550.

Gelzer, Christian. *The Spoken Word III: Recollections of Dryden History; The Shuttle Years*. Monographs in Aerospace History, No. 52, 2013. NASA SP-2013-4552.

Ross, James C. *NASA Photo One*. Monographs in Aerospace History, No. 53, 2013. NASA SP-2013-4553.

Launius, Roger D. *Historical Analogs for the Stimulation of Space Commerce*. Monographs in Aerospace History, No. 54, 2014. NASA SP-2014-4554.

Buchalter, Alice R., and Patrick M. Miller, comps. *The National Advisory Committee for Aeronautics: An Annotated Bibliography*. Monographs in Aerospace History, No. 55, 2014. NASA SP-2014-4555.

Chambers, Joseph R., and Mark A. Chambers. *Emblems of Exploration: Logos of the NACA and NASA*. Monographs in Aerospace History, No. 56, 2015. NASA SP-2015-4556.

Alexander, Joseph K. *Science Advice to NASA: Conflict, Consensus, Partnership, Leadership*. Monographs in Aerospace History, No. 57, 2017. NASA SP-2017-4557.

Electronic Media, NASA SP-4600

Remembering Apollo 11: The 30th Anniversary Data Archive CD-ROM. NASA SP-4601, 1999.

Remembering Apollo 11: The 35th Anniversary Data Archive CD-ROM. NASA SP-2004-4601, 2004. This is an update of the 1999 edition.

The Mission Transcript Collection: U.S. Human Spaceflight Missions from Mercury Redstone 3 to Apollo 17. NASA SP-2000-4602, 2001.

Shuttle-Mir: The United States and Russia Share History's Highest Stage. NASA SP-2001-4603, 2002.

U.S. Centennial of Flight Commission Presents Born of Dreams—Inspired by Freedom. NASA SP-2004-4604, 2004.

Of Ashes and Atoms: A Documentary on the NASA Plum Brook Reactor Facility. NASA SP-2005-4605, 2005.

Taming Liquid Hydrogen: The Centaur Upper Stage Rocket Interactive CD-ROM. NASA SP-2004-4606, 2004.

Fueling Space Exploration: The History of NASA's Rocket Engine Test Facility DVD. NASA SP-2005-4607, 2005.

Altitude Wind Tunnel at NASA Glenn Research Center: An Interactive History CD-ROM. NASA SP-2008-4608, 2008.

A Tunnel Through Time: The History of NASA's Altitude Wind Tunnel. NASA SP-2010-4609, 2010.

Conference Proceedings, NASA SP-4700

Dick, Steven J., and Keith Cowing, eds. *Risk and Exploration: Earth, Sea and the Stars.* NASA SP-2005-4701, 2005.

Dick, Steven J., and Roger D. Launius. *Critical Issues in the History of Spaceflight.* NASA SP-2006-4702, 2006.

Dick, Steven J., ed. *Remembering the Space Age: Proceedings of the 50th Anniversary Conference.* NASA SP-2008-4703, 2008.

Dick, Steven J., ed. *NASA's First 50 Years: Historical Perspectives.* NASA SP-2010-4704, 2010.

Societal Impact, NASA SP-4800

Dick, Steven J., and Roger D. Launius. *Societal Impact of Spaceflight.* NASA SP-2007-4801, 2007.

Dick, Steven J., and Mark L. Lupisella. *Cosmos and Culture: Cultural Evolution in a Cosmic Context.* NASA SP-2009-4802, 2009.

Dick, Steven J. *Historical Studies in the Societal Impact of Spaceflight.* NASA SP-2015-4803, 2015.

Index

- 7- by 10-foot wind tunnel (Ames Research Center), 803
- 7- by 10-foot wind tunnel (Langley Research Center), 330, 331, 333, 334, 382, **387, 388**, 424, 772
- 8-foot high-speed wind tunnel (Langley Research Center), 408
- 16-foot transonic tunnel (Langley Research Center), 656
- 20-foot wind tunnel (Langley Research Center), 94, 97, 101, 102, 315, 324, 325, 586
- 30- by 60-foot full-scale wind tunnel (Langley Research Center), **2, 53**, 88, 94, 99, 100, 127, 341, 413, 584, 585, 688, 631, 641, 647, 648, 654, 656, 663, 674, 772, 797
- 40- by 80-foot wind tunnel (Ames Research Center), 59, 796–98, 801–03
- ACE Aviation, 456, 457
- Acebo, Don Felipe Gomez, 526
- Achgelis, Gerd, 42
- Advanced Technologies Group (ATG), 194–96
- AT-10, 196–97
- SkyCat 15, 196–97
- SkyCat 200, 197
- StratSat, 197
- Advisory Group for Aerospace Research and Development (AGARD), 697
- Aereon Corporation, 16
- Aerodrome, 19
- Aerojet-General Corporation, 462
- Aerospatiale, 50, 51, 56, 62, 63
- SA-315B Lama helicopter, 62
- SA.341 Gazelle, **51**
- SNCA-SE 3130 Alouette II helicopter, 50, 51
- Agusta, 56, 63, 824
- Aikman, Barry T., 441
- Aircraft Development Corporation, 78, 85
- Air Force Aero Propulsion Laboratory (AFAPL), 803
- Air Ministry, 84, 288, 290, 291, 319, 532, 547, 548, 552, 555, 562, 564, 565, 578
- Airship Guarantee Co., 84
- Airship Industries, 195
- Sentinel 1000, 195
- Skyship 500, 195
- Skyship 500HL, 195
- Skyship 600, 195
- airships
- AEROS 40-A, 191
- AEROS 40-B, 191
- AEROS 40-C, 191
- AEROS D-1, 191–92
- AEROS D-4, 192
- AEROS D-8, 192
- Bodensee, 157
- C-7, 103–05, 107
- Defender blimp, 139
- Esperia, 84
- Goodyear blimp, **17**
- Hindenburg, **3**, 12, 14, 70, 95, 102, 122, 129, 146, 147, 173, 178, 179, 181–85, 187
- K-type non-rigid, **15**
- L-33, 140
- L-49, 140
- MC-38, 115
- R-34, 10
- R-38 (ZR-2), 72, 73
- R.100, 86
- R.101, 11
- Roma, 10, 70, 72
- RS-1, 74, 75, 78
- TC-11, 93
- TC-13, 93
- U.S.S. Akron, 11, 13–15, 89–92, 127, 143, 144, 171
- U.S.S. Los Angeles (ZR-3), 10, 11, 77, 82, 83, 85, 86, 90, 92, 100, 104, 105, 107, 116, 122, 126, 142, 157, 158, 169, 172, 183, 185
- U.S.S. Macon, **11**, 14, 15, 171
- U.S.S. Shenandoah (ZR-1), **10**, 11, 72, 73, 76, 81, 107, 140, 142
- ZMC-2, 85, 92, 97
- ZRS-4, 85, 86, 94, 97, 107–11, 113–16
- ZRS-5, 85, 94
- Airship Technologies Services, 195
- Allward, Maurice F., 437, 439, 440
- Amer, Kenneth B., 673
- American Institute of Aeronautics and Astronautics (AIAA), 697
- American Society of Mechanical Engineers, 488
- Ames, Joseph S., 81, 122, 123, 127, 221
- Ames Aeronautical Laboratory/NASA Ames Research Center (ARC), 52, 55, 59, 413, 794, 796–806, 808–10, 813–20, 824–26

- 7- by 10-foot wind tunnel, 803
 40- by 80-foot wind tunnel, 59, 794, 796–98, 801–03
 Ames Flight Simulator for Advanced Aircraft (FSAA), 805
 Ames Outside Aerodynamic Research Facility (OARF), 849
 Ames Vertical Motion Simulator (VMS), 805, 812, 814, 826
 Anderson, John D., 220
 Aquila Airways, 437, 441
 Army Aeronautical Research Laboratory (AARL), 59
 Army Air Forces Materiel Command, 415
 Army Air Service, 34, 53, 74, 75, 248, 487
 Army Mobility Research and Development Laboratory (AMRDL), 802, 804
 Arnold, H. H. “Hap,” 143
 Arnstein, Karl, 96–98, 109, 113, 127, 140, 145, 148, 151
 Arthurs, John E., 613
 Asboth, Oscar (Oszkár Asbóth) (Oskar von Asboth), 462, 591, 592, 598, 604
 Astor, Vincent, 241
 Autogiro Company of America, 53, 575, 577
 Avro, 38, 44, 540, 542, 543
 Axtater, Karl S., 96–97
- Bairstow, Leonard, 544, 548, 552
 Bane, Thurman H., 53, 517
 Bateman, H., 476, 499–500
 Baynes Heliplane, 56, 711
 Beach, Stanley Y., 711
 Beatty, George, 217
 Beil, David A., 613
 Bell, Lawrence “Larry” D., 46, 606, 620–24, 626
 Bell Aircraft Corporation/Bell Helicopter Corporation/Bell Textron, Inc., 46–48, 53, 58–61, 63, 616, 617, 620, 626, 628, 697, 712, 740, 795–804, 813, 823, 825, 829, 837, 839, 840
 Bell AH-1 Cobra (Model 209), 62, 628
 Bell Boeing MV-22, 63, 838, 856, 860
 Bell Boeing V-22 Osprey, 59, **60**, 61, 63, 794, 795, 812, 813, 820–27, 837–44, **846**, 846–50, **850**, **852**, **853**, 854
 Bell H13-B, **678**
 Bell Model 30, 47, **48**, 622, **623**, **624**, **625**
 Bell Model 42, 624, 626
 Bell Model 47 (H-13 Sioux), 47, **48**, 61, 616, **625**, 626, 628
 Bell OH-58 Kiowa, 628
 Bell UH-1 Iroquois, **4**, 628
 Bell XV-3 (Model 200), 59, 736, 794–800, 802, 804, 809, 823, 843
 Bell XV-15 (Model 301), 59, **60**, 794, 795, 800, 805–25, 829–36, **842**, 842–46, **846**, **850**, 852
 Bendix experimental coaxial helicopter, **679**
 Benoist Company, 218
 Berliner, Emil, 36, 485, 487
 Berliner, Henry, 36, 485–87, 515, 617, 711
 Berliner helicopter, **33**, 36, 485, 487, **515**, 516, 521, 598
 Bernoulli, Daniel, 19, 225, 497
 Bertrandias, Victor, 241
 Bingham, Hiram, 80, 84
 Birckelbaw, Larry, 860
 Bleeker, Maitland B., 37, 38
 Bode, Carl, 53
 Boeing Aircraft Company, 56, 330, 456, 628
 Boeing 314 Clipper, 328–30, 337–38, 346, 348, 351, 353
 Boeing 747, 16
 Boeing Clippers, 27
 Boeing PB-1 flying boat, 319
 Boeing Helicopter Company, 794
 Boeing-Sikorsky aircraft
 RAH-66 Comanche, 63
 Bonham-Carter, D. W. F., 571, 573
 Booth, Harris, 545
 Botezatu, Georges, 34. *See de Bothezat, George*
 Brabazon Committee, 436, 439
 Brancker, Sefton, 545, 549, 571, 572
 Breguet, Louis, **42**, 598, 601, 617, 619
 Breguet-Dorand helicopter, **42**, 599
 Brennan, Louis, 38, 532
 Bright, Henry, 31
 Bristol Aeroplane Company, 437
 Type 167 (Brabazon), 437, 442, 445
 Bristol Helicopters, 56
 British Ministry of Civil Aviation, 437
 British Overseas Airways Corporation (BOAC), 437, 440, 441, 444
 British Royal Navy Air Service (RNAS), 23
 Bucken, Hans, 141
 Burgess, C. P., 115
 Burgess Co. & Curtis, 218
 Bushnell, Dennis M., 64, 65, 861, 862, 869
- California Institute of Technology, 128, 129, 141–44, 463
 Canadian Armed Forces, 238
 CargoLifter AG, 198–200
 CargoLifter CL 160, 198–200
 Carlson, Floyd, 53, 622, 623, 795
 Cayley, Sir George, **30**, 31, 711
 Cessna
 Cessna 180, 455

- Cessna 208 Caravan, 458
 Chambers, Washington I., 306
 Chanute, Octave, 21, 202, 873
 Charles, J. A. C., 6
 Christenson, Anders J., **448, 449**
 Cierva, Juan de la. *See* de la Cierva, Juan
 Cierva Autogiro Company, 135, 576
 Cierva C.8 autogiro, **578**
 Cierva C.8V autogiro, **39**
 Cierva C.30 autogiro, 602
 Civil Aeronautics Administration (CAA), 673
 Clipper Ships, 25, **26**, 295, 328–29, 337, 353–58,
 404, 411, 607
 Cohen, William, 63, 838
 Collier Trophy, 216, 239, 241, 579
 Collins, H. E., 492, 493
 Compton, Karl T., 145
 Conklin, Henry S., 249, 250, 256
 Consolidated Aircraft Corporation, 307, 360
 Consolidated B-24 Liberator, 361, 404, 413
 Consolidated PB2Y Coronado, 26, 250, 404, 411,
 419
 Consolidated PBV Catalina, 25, 250, 404, 411, 419
 Consolidated PBV-5A Catalina, 250
 Convair (Consolidated Vultee Aircraft Corporation),
 370, 371, 373, 418
 XF2Y-1 Sea Dart, 418
 Cook, Woodrow L., 798
 Cooper Hewitt, Peter, 617
 Cornu, Paul, 32–34, **33**, 598
 Courtney, Frank T., 542, 544, 549
 Crafton, Robert W., 613
 Creighton, Russ, 621
 Curtiss, Glenn, 19, 21–25, **22**, 37, 38, 202, 204, 209,
 211, 213, 215–17, 238, 306, 711
 Albany Flyer, 23
 June Bug, 21
 Loon, 21, **22**, 23
 Curtiss Aircraft Company, 23, 24, 37, 248
 Curtiss F9C-2 Sparrowhawk, **11**
 Curtiss F-5L, 23, **24**, 248–53, 255, 257
 Curtiss H-16, 23–25, 248, 250, 256
 Curtiss HS-2L, 248
 Curtiss Hydro, **22**, 23
 Curtiss JN Jenny, 25
 Curtiss Model E flying boat, 23, 202
 Curtiss Model F flying boat, **22**, 447
 Curtiss Model H flying boat, 23
 Curtiss NC-4, 23, 306, 363
 flying boat, 211, 213–18
 Curtiss-Bleeker, **37**, 598
 Curtiss-Bleeker helicopter, **37**
 Curtiss-Wright Corporation, 239
 Damblanc, Louis, 496, 519, 521, 522
 Damblanc helicopter, 518, **519**
 D'Amécourt, Vicomte Ponton, 31
 Daniel Guggenheim Airship Institute, 14, 67, 127,
 129, 130, 140, 141, 148
 Daniel Guggenheim School of Aeronautics, 488
 d'Ascanio, Corradino, **35**, 37, 43, 595, 598, 617, 875
 da Vinci, Leonardo, 19, 29, **30**, 594
 Dawson, John R., 412, 415
 de Bothezat, George, 34, 512
 de Bothezat helicopter, **33**, **53**, **517**, 518, 522, 598
 Deckert, Wallace H., 797
 de Forest, A. V., 145, 146
 de Havilland Aircraft Company Limited, 38, 244,
 567
 DH-4B, 244
 DHC-2 Beaver, 455
 Turbine Otter, 455
 de la Cierva, Juan, xxiii, 38, **39**, 505, 524, 526,
 529, 530, 532–34, 542–50, 552–53, 562–67,
 569–72, 575, 576, 594–95, 604
 de la Cierva's autogiro (autogyro), **503**, 505, **521**,
 524, **525**, 529, 532–73, 589, 594
 Autogiro No. 1, **526**, **535**
 Autogiro No. 2, **526**, **535**, 527
 Autogiro No. 3, **527**, 536
 Autogiro No. 4, **528**, **530**, 537
 Autogiro No. 5, 530, 539
 Autogiro No. 6, 540–41
 de La Landelle, Gabrielle, 31
 de Lome, Dupuy, 8
 Deutsche Zeppelin-Reederei, 173, 174, 177, 185
 Diehl, Walter S., 115, 261–63, 275, 300, 304, 305
 Dieuaide, Emmanuel, 31
 Dingeldein, Richard C., 677, 766
 Doak VZ-4, 776, 783
 Donnet-Lévêque flying boat, 23, 217
 Dorand, René, **42**
 d'Orcy, Ladislas, 240
 Dornier, Claude, 436, 598
 Dornier flying boats, 289
 Dornier Do-X, **12**, 436
 Douglas, Lee L., 628
 Douglas Aircraft Company, 249
 Douglas DC-3, 25, 328, 464
 Douglas DC-4, 329
 Douglas DC-6, 329
 Douglas Dolphin flying boat, 447
 Dresel, Alger H., 142
 Drinkwater, Fred, 797
 Driskill, Dave, 53, 575
 Dryden Flight Research Center/NASA Armstrong
 Flight Research Center, 59

- Dugan, Daniel C., 59, 795, 800, 805, 819
- Durand, William F., 13, 101, 145, 146, 148, 149,
151, 157, 464, 465, 479, 492, 494, 495, 506–08,
512, 627
- Easton, John, 627
- Eckener, Hugo, 16, 146, 147, 183, 185, 186
- Edenborough, Kipling, 798
- Edison, Thomas Alva, 31, 32, 61
- Edson, Lee, 462
- Edwards Air Force Base, 796, 797
- Einstein, Albert, 44
- Eisenhower, Dwight D., 143
- Ellehammer, Jens, **33**, 34
- Ellyson, Theodore G. “Spuds,” 211–13
- Ely, Eugene, 23
- Erickson, Frank A., 611
- Estefani y Caballero, Don Jose Gonzalez, 529
- Euler, Leonhard, 19
- Eurocopter, 63, 824, 858
Tiger attack helicopter, 63
- Eurofar, 59
- European Helicopter Industries, 63
- Fabre, Henri, 21, 23, 204–06
- Page, A., 492, 493, 511
- Fairey Aviation Company, 56
FB-1, 56
Jet Gyrodyne, 56
Rotodyne, 56
- Farren, William, 146
- Federal Aviation Administration (FAA), 48, 193,
455, 456, 823, 824, 826
- Federal Aviation Commission, 93
- Fédération Aéronautique Internationale (FAI), 35,
185, 482
- Ferry, Robert, 796, 797
- Fiat, 56
- Fleetwings model F-5 Sea Bird, 447
- Flettner, Anton, 38, 43, 44, 46, 616–18
Flettner Fl 282 Kolibri (“Hummingbird”), 43–44
- Flettner cylinders, 44
- Focke, Heinrich K. J., 42, 53, 576, 591–93, 606,
616, 617, 870, 873
- Focke-Achgelis (Fa), 46
Fa 61, 42, **43**
Fa 223 Drache (“Kite”), 44
Fa 226, 43
Fa 233, 43
- Focke’s helicopter, 42, 43, 53, 591–93, 598, **602**
- Focke-Wulf (Fw)
Fw 44 “Stieglitz,” 602
Fw 61 (FW-61), 42, 43, 591, 592, 602, 606, 873
- Fokker, 63
- Ford, Henry, **22**, 867, 868
- Forlanini, Enrico, 31
- Fowler, Harold, 242, 243
- Freeman, Hugh B., 110, 113, 122, 123, 125, 126
- Froude, William, 19, 21, 431, 489–91, 566
- Fullerton, J. D., 550
- Fulton, Garland, 96–98, 109, 113, 145
- Gaffey, Troy, 800
- Gallaudet, Edson, 21
- Gauchot, Paul, **20**
- General Electric Company, 725, 728
- Georgia Institute of Technology, 643, 645, 677
- German Air Force, 44
- Gessow, Alfred, 53, 54, 55, 677, 678, 697
- Giffard, Henri, 6, 7
- Gilruth, Robert R., 677
- Giulianetti, Demo J., 59, 794, 795, 800, 805, 819
- Glauert, Hermann, 324, 594, 595, 643, 644
- Golder, Fred, 241
- Goldmark, Henry, 74
- Goodyear Enterprise blimp, **17**
- Goodyear Tire and Rubber Co., 75, 140
- Goodyear Zeppelin Corporation, 14, 84–86, 96–98,
102, 107–09, 113, 115, 145, 148
ZRS-4 airship, 85, 86, 94, 97, 107–11, 113–16
ZRS-5 airship, 85, 94
- Gough, Melvin N., 673, 674, 676
- Graf Zeppelin, 11, **12**, 86, 139, 147, 171, 173, 178,
179, 181
- Gray, George W., 403
- Green, F. M., 542–44, 547, 567
- Gregory, H. Franklin, 463, 611
- Grover Loening Aircraft Company, 239
- Grumman, LeRoy, 240, 245, 247
- Grumman Aircraft Engineering Corporation
Grumman G-21A Goose, **27**, 411, 437, 447,
448
- Guggenheim, Harry, 140
- Guggenheim Competition, 573
- Gustafson, Frederic B., 42, 43, 52, 54, 663, 664,
673, 677, 776
- Gutenberg, Beno, 143
- Hafner, Raoul, 38, 589, 598
- Hall, Earl, 800
- Hall Aluminum Aircraft Corporation, 249
Hall PH-1 flying boat, 311
Hall XP2H-1, 249
- Hamrick, George, 612
- Handley Page, Frederick, 543, 545, 551, 565
- Hanle, Paul, 219

- Hansen, James R., 487, 580
 Hargrave, Lawrence, 19, 21
 Harman, Carter, 45
 Harper, C. W., 797
 Harris, Harold R., 53, 487
 Hatcher, Robert S., 307
 Hefner, Ralph A., 677
 Hele-Shaw, Henry Selby, 567
 Herrera y Linares, Don Emilio, 529, 530
 Herrick Convertaplane, 715
 Hiller, Stanley, 46, 606
 Hiller Aircraft Company, 56
 Hiller UH-12, 61
 Hiller X-18 Propelloplane, 737
 Hiller XH-44, 46
 Hiller YH-32, 52
 Hindenburg, 3, 12, 14, 70, 95, 102, 122, 129, 146,
 147, 173, 178, 179, 181–85, 187
 Hodgson, J. L., 546, 551
 Hovgaard, William, 74, 145
 Hovgard, Paul, 575
 Hughes Aircraft Company/Hughes Helicopters,
 575, 697
 Hughes H-4 Hercules, 437
 Hunsaker, Jerome C., 95, 220, 221, 306, 307
 Hydroavion, 20
- Ickes, Harold, 147
 Institute of Aeronautical Science, 418
 Interface Airships, Inc., 192–193
 Isaaco, Vittorio, 38, 598, 617, 618, 875
- Jacobs, Eastman N., 115, 117–20, 128
 Jacuzzi, R., 478, 479
 Jeffers, Harry, 612
 Jewett, F. B., 145
 Johnson, Wayne, 55, 697, 698, 703, 801, 807
 Jones, Robert T., 13, 14
 Josephson, A. G., 38
 Joukowski, Nicolai, 34, 482
- Kaman, Charles, 46, 49, 50, 663
 Kaman Aircraft, 680
 K-125A, 46
 K-225, 49, 50
 Kamov Design Bureau, 56
 Karman helicopter, 512, 513
 Kawanishi, 436
 Kawasaki, 56
 Keck, Louis K., 613
 Kellett Aircraft Corporation, 41, 53, 575, 628
 Kellett YG-1, 41
 Kellett YG-1B, 41, 589, 590
 Kellett YG-2, 41
 Kellett YO-60, 628
 Kelley, Bartram, 620, 625, 626, 628, 629
 Kelley, Henry L., 776
 Kelly, Mark W., 758, 798
 Kenmore Air, 454
 Kepner, William E., 98
 Kettering, C. F., 145
 Keystone Aircraft Corporation, 249
 Kirby, Robert H., 756
 Klemin, Alexander, 35, 36, 37, 55, 488, 489, 629,
 876
 Klemperer, Wolfgang, 133, 139, 140, 148, 151
 Knight, Montgomery, 677
 Ko-Hung, 29
 Kranzberg, Melvin C., xxiii
 Kress, Wilhelm, 21, 202
 Krick, Irving, 143, 144
 Küchemann, Dietrich, 1, 2, 3, 5, 65
 Kuhn, Richard E., 744
- la Cierva's autogyro. *See* de la Cierva's autogyro
 (autogyro)
 Lakehurst Naval Air Station, 3, 10, 12, 77, 78,
 83, 85, 92, 94, 100, 107, 146, 173, 182, 183,
 185
 Lamb, Sir Horace, 19
 Langley, Marcus, 263, 284
 Langley, Samuel P., 19
 Langley Field, 10, 38, 40, 41, 78, 93, 94, 97, 108,
 113, 123, 126, 127, 241, 284, 296, 300, 304,
 309, 316, 336, 355, 375, 397, 674
 Langley Memorial Aeronautical Laboratory
 (LMAL)/NASA Langley Research Center, 2,
 14, 36, 37, 38, 52, 53, 59, 67, 96–103, 107, 110,
 113, 117–23, 126, 154, 261, 295, 296, 298, 300,
 304, 313, 336, 372, 382, 397, 404, 409–14, 418,
 426, 464, 522, 547, 581, 642, 643, 663–64,
 673–74, 743, 744, 756–66, 788, 799–801, 814,
 818, 826
 7- by 10-foot wind tunnel (Langley Research
 Center), 330, 331, 333, 334, 382, 387, 388,
 407, 424, 772
 8-foot high-speed wind tunnel (Langley Research
 Center), 408
 16-foot transonic tunnel (Langley Research
 Center), 656
 20-foot wind tunnel (Langley Research Center),
 94, 97, 101, 102, 109, 315, 321, 324, 325, 586
 30- by 60-foot full-scale wind tunnel (Langley
 Research Center), 2, 53, 88, 94, 99, 100, 127,
 341, 413, 584, 585, 588, 631, 641, 647, 648,
 654, 656, 663, 674, 772

- Flight Research Division, 663, 673–74
 Helicopter Apparatus and Rotor Test Facility
 (helicopter test tower), 52, 632, 635, 636, 638,
 640, 641, 647, 650, 656, 660, 663, 674, 768,
 770, 776
 Langley gust tunnel, 651
 NACA Tank No. 1, 99, 262, 265, 284, 295–300,
 302, 307, 309–13, 315–22, 324–27, 330, 386,
 405, 408, 409, 411, 418, 424
 propeller research tunnel (PRT), 86, 87, 96,
 98–100, 106, 107, 110, 113, 114, 122, 297,
 299, 584–86, 588
 stability tunnel, 649
 Tank No. 2, 295, 409, 412, 413, 415, 418, 423,
 425, 435
 two-dimensional low-turbulence pressure tunnel
 (Langley Research Center), 635, 638, 649
 variable-density wind tunnel (Langley Research
 Center), 86–88, 91, 97, 98, 107, 108, 113–21,
 128, 152, 296–97
 Lansdowne, Zachary, 140
 Larsen, Agnew, 575
 Larson, Harry, 245, 247
 Launoy and Bienvenu, **30**
 Laurent, François (Marquis d'Arlandes), **6**
 Leavitt, Lou, 53, 576
 Lehman, William B., 613
 Lehmann, Ernst, 182, 183, 184
 Leibensberger, Claude, 798
 Leinweber, Victor H., 711
 Leishman, J. Gordon, 28, 32, 38, 40, 41, 47, 55, 61,
 580, 581
 Lesley, Everett P., 464, 478, 492, 494, 495, 506–08,
 512
 Lewis, George W., 70, 96–98, 113, 121–23, 127,
 128, 139, 261, 298–300, 581
 Liberatore, Eugene K., 34, 36, 40, 50, 55, 65, 486,
 532, 533, 576, 580, 581, 591, 592, 616, 663,
 869, 870
 Lichten, Robert L., 58, 711, 712, 735, 795
 Liebert, H. R., 170
 lighter than air (LTA), xxiii, 9, 14, 15, 16, 67, 68,
 70, 93, 95–99, 108, 129, 140, 144–46, 173,
 183–85, 187, 188, 191, 194–96, 198
 Lock, C. N. H., 499, 500, 551, 555
 Lockheed aircraft, 697
 Lockheed 186 (XH-51), 62
 Lockheed C-130 Hercules, 459, 797
 Lockheed Constellation, 329
 Lockheed Martin, 196
 Lodygin, Alexander Nikolaevich, 31
 Loening, Grover, **20**, 202, 207, 208, 218, 238–41,
 244, 245–47, 307, 628
 Loening Aeronautical Engineering Corporation,
 238, 239, 244
 Loening OA-1C Amphibian, 212, 239, 244, 247
 Loening S-1 Flying Yacht, 240, 241, 447
 Lomonosov, Mikhail Vasilyevich, 29, **30**
 Loriga, J., 540
 Low, Major, 548, 570
 low-turbulence pressure tunnel (Langley), 635, 638,
 649, 653
 Luftschiffbau Zeppelin GmbH, 67
 Lundquist, Eugene E., 412
 Lynn, Robert “Bob,” 797
 MacDonald, George, 241
 Maisel, Martin D., 59, 794, 795, 800, 805, 819
 Manning, W. O., 545, 569
 Margoulis, Wladimir, 36, 482, 499, 500, 502, 503,
 510
 Mark, Hans, 59, 825
 Martin Company (Glenn L. Martin Company), 25,
 26, 249, 297, 418
 Martin 130 Clipper, **26**, 328, 329
 Martin PBM-3, 411
 Martin PBM Mariner, 26, 361, 373, 411, 419
 Martin PM-1, 249
 Martin YP6M-1 Seamaster, 417, 418
 Mashman, Joe, 53
 Massachusetts Institute of Technology, 95, 644,
 646, 657
 Mayo, R. H., 566, 573
 McCord, Frank C., 142
 McCulloch, David H., 240
 McDonnell Aircraft Corporation, 679, 680
 McDonnell “Little Henry” helicopter, **679**
 McDonnell XHJD-1 side-by-side helicopter,
680
 McDonnell Douglas Helicopter Co., 697
 McGovern, Vincent H., 612
 McPhee, John, 16
 Messerschmitt-Bölkow-Blohm (MBB), 56, 63
 Mil, Mikhail Leontyevich, 56
 Mil Design Bureau, 56
 Mil Mi-6, 63
 Mil Mi-12 Homer, 63
 Miller, John, 53, 128
 Millikan, Clark, 127, 128, 141, 143
 Millikan, R. A., 127, 145
 Ministry of Civil Aviation, 437, 440, 441
 Mitsubishi, 56
 Moffett, William A., 10, 11, 13, 70, 142, 212, 249,
 259, 260, 487
 Montgolfier, Joseph and Etienne, 6, 31
 Montgolfier balloon, **6**

- Moore-Brabazon, J. T. C. (The Lord Brabazon of Tara), 436, 437, 439
- Moore, Harold, 612
- Moreno-Caracciolo, M., 40, 524
- Morgan, H. Cary, 242, 243
- Morris, Charles L. "Les," 611
- Mouillard, Louis, 19
- Munk, Max M., 13, 67, 68, 74, 129, 130, 148, 149, 219, 221, 559, 574, 581
- Munk, Roger, 194, 195
- Myers, Garry C., Jr., 53–55, 677, 678, 697
- Nagler, Bruno, 598
- Narramore, J. C., 59, 829, 830, 832
- National Advisory Committee for Aeronautics (NACA), 10, 13, 14, 19, 26, 28, 31, 34–42, 50–55, 58, 59, 67, 70–74, 76, 77, 80, 81, 85, 86, 89, 91, 93–99, 103, 107–10, 113–23, 126, 152, 219–22, 239, 261, 262, 271, 283, 284, 295, 296, 298–302, 306, 307, 309–11, 313, 315, 316, 318–24, 326, 327, 330–332, 336, 338, 340, 341, 355, 360, 372, 373, 381, 382, 386, 397, 403, 405, 408, 410, 412–14, 417–419, 422, 423, 425–28, 430, 432, 434, 464, 466, 476, 478, 482, 485, 488, 489, 492, 524, 531, 580–83, 586–93, 605, 627–30, 632–35, 638, 640–47, 649, 650, 654, 655, 657, 658, 660, 663, 664, 673, 674, 676–79, 697, 730, 740, 743, 796, 833, 834, 835, 845–76
- Committee on Aerodynamics, 95, 221, 261, 295, 298, 627
- NACA Exceptional Service Medal, 418
- Subcommittee on Airships, 95–102, 107, 108, 110, 113, 114, 121
- Subcommittee on Helicopters, 50, 51, 55, 627, 629, 633, 635, 638
- Subcommittee on Seaplanes, 306, 313, 316, 318, 320, 323, 326, 360, 421–23, 425
- National Aeronautics and Space Administration (NASA), 50, 55, 56, 58, 59, 64, 418, 677, 697, 743, 744, 766, 775, 776, 790, 791, 794, 795, 797–805, 807, 813–16, 818–20, 824–27, 829, 849, 852, 861, 869
- National Physical Laboratory, 464, 466–68
- Naval Aircraft Factory, 10, 248, 249–52, 256, 263
- F-5-L, 250–53, 255–57
- P3M-1, 310
- PN-7, 250–53, 255–56
- PN-8, 252, 253, 255, 256, 311, 315
- PN-9, 248–50, 252, 253, 255, 256
- PN-10, 256, 258
- PN-12, 249, 256, 257
- Naval Air Development Center's Aeronautical Instruments Laboratory, 612
- NC flying boat hull, 254, 267, 319, 325
- Nelson, William, 262, 263, 273
- New York–Newport Air Service Company, 241, 243
- NH Industries, 63
- NH-90, 63
- Noeggerath, J. E., 712
- Oehmichen, Étienne, 35, 36, 482–84, 520, 595, 598, 617–19
- Oehmichen helicopter, 35, 482, **520**
- Oehmichen-Peugeot Laboratory, 484
- Office National d'Etudes et de Recherches Aérospatiales 8-meter (26-foot)-diameter S-1 wind tunnel, 803
- Oriol, Ramon, 712
- Pagon, W. Watters, 75
- Pan American Airways (Pan Am), 26, **29**, 239, 247, 297, 328, 329, 337, 347, 353, 358
- Pan American Goodwill Flight, 239, 247
- Parkinson, John B., 407, 408, 418
- Patrick, Mason, 487
- Paucton, A. J. P., 30
- Pegg, Robert J., 776
- Pénaud, Alphonse, **20**, 21, 31
- Pescara, Raul Pateras, 516, 517, 595, 598, 617
- Pescara helicopter, **516**
- Petróczy, Stefan, 461, 462, 617
- Peugeot, Jules, 482–84
- Peugeot (company), 484
- Phillips, Horatio, 31
- Piasecki, Frank, 45–47, 606, 663
- Piasecki PV-2, 45, **47**, 631
- Piasecki PV-3 "Dogship," 46
- Piasecki Helicopter Corporation/Piasecki Aircraft Corporation, 58, 576, 628, 680, 711
- Piasecki HJP-1, **680**
- Piasecki HRP-1, **52**, 673, 674, 676
- Pilâtre de Rozier, Jean-Francois, **6**
- Pilotless Aircraft Research Division, 654
- Pitcairn, Harold F., 38–40, **39**, 575–77, 579
- Pitcairn Aviation, Inc., 38, 575–77
- Pitcairn Mailwing, 577
- Pitcairn PAA-1, **41**
- Pitcairn PCA-2, 41
- Platt, Haviland, 799
- Prandtl, Ludwig, 19, 67, 129, 141, 219–22, 548
- Prewitt, Richard H., 55, 575, 628
- Prewitt Aircraft Company, 55, 628
- Princeton University, 461, 635, 636, 643, 645
- propeller research tunnel (PRT) (Langley Research Center), 86, 87, 96, 98–100, 107, 110, 113, 114, 122, 297, 299, 584–86, 588

- Prospective Concepts AG, 193
 Prouty, Raymond W., 697
 Pruss, Max, 182–84
- Queen Aeroplane Company, 238
 Quinlan, Bill, 796
- R-38 (ZR-2), 72, 73, 84
 R.101, 86
 Rawson, Arthur, 570, 573
 Ray, James G., 53
 Reeder, John P. “Jack,” 52, 53, 663, 664, 673, 674, 677, 782, 786
 Reichelderfer, F. W., 139
 Reid, Henry J. E., 40, 110, 114, 296, 298, 581
 Reinhard, Andreas, 193
 Reitsch, Hanna, 42, 605
 Rhode, Richard V., 412
 Riabouchinsky, Dimitri, 474, 475, 495, 507, 508
 Richardson, Holden C., 202, 239, 266, 306, 307
 Rickenbacker, Eddie, 412
 Robert, Aine, 6
 Robinson, Douglas H., 16, 17, 173
 Rodgers, John, 249
 Rohlf, Ewald, 53, 600, 604
 Roland, Alex, 38, 39, 123, 307, 403, 580, 581
 Roma airship, 70, 72
 Roosevelt, Franklin D., 144
 Rose, Don, 576
 Rosendahl, Charles E., 142
 Royal Aero Club of Spain, 40, 524
 Royal Aeronautical Society, 38, 519, 532–34, 552, 562
 Royal Aircraft Establishment (RAE), 36, 40
 Royal Air Force (RAF), 44, 45, 238, 443
 RS-1, 74, 75, 78
- Santos-Dumont, Alberto, 8, 9
 Demoiselle monoplane, 8
 No. 6 airship, 8
- Saunders-Roe, 437, 440, 442, 446
 Saunders-Roe Duchess, 437, 440, 442–44
 Saunders-Roe SR.45 Princess, 437–42, 445, 446
- Schneider Cup, 416
 Schrenk, M., 600
 Scott, William A., 613
 Scott Field, 78, 83
 SeaAirNY, 458
 Seawind, 456, 457
 SEAWOLF, 459
 Seiferth, R., 40
 Shell International Oil Company, 195
 Shoemaker, James M., 279, 487
 Shortal, Joseph A., 330, 336
- Short Brothers, 297, 299, 436
 Short Calcutta flying boat, 319
 Short Sealand flying boat, 440, 441, 443
 Short Singapore I flying boat, 290
 Short Singapore II-C flying boat, 319–20
 Short Solent, 438–41, 444
 Short Sunderland, 443
- Sikorsky, Igor S., 28, 29, 34, 45, 46, 55, 576, 606, 607, 616, 617, 663, 874
- Sikorsky Aviation Corporation, 297, 312, 612, 697
 Sikorsky H-5, 61
 Sikorsky H-19 (Chickasaw), 61, 62
 Sikorsky R-4 (XR-4) (YR-4B) (HNS-1) (Hoverfly), 44, 45, 52–54, 53, 606, 610–11, 618, 663–66, 668–70, 672
 Sikorsky S-5, 45
 Sikorsky S-40 (American Clipper Class), 312, 319
 Sikorsky S-42, 328, 329
 Sikorsky S-51 (HO3S-1), 612, 659
 Sikorsky S-55, 606, 612
 Sikorsky S-56, 606, 612–13
 Sikorsky S-58, 606, 612–13
 Sikorsky S-61 (SH-3A) (CH-3B, Otis Falcon), 606, 612–13, 858
 Sikorsky S-61R (CH-3E, HH-3E), 613
 Sikorsky S-65, 606, 613
 Sikorsky VS-100, 606
 Sikorsky VS-300, 45, 46, 607–10
 Sikorsky UH-60A Black Hawk, 62, 64
- Smith, Art, 34, 53
 Smith, J. Henry, 461
 SNA Inc., 456–57
 Snyder, Howard O., 464, 478
 Sorenson, Edgar P., 96
 Soule, Fred “Slim,” 53
 Special Committee on Airships, 145, 146
 Spencer, Alejandro Gomez, 524, 527–29, 539
 Stanford University, 101, 145, 148, 464, 466, 467, 478–79, 627
- Stansbury, Dick, 796
 Steffes, Dirk, 199, 200
 Stevens Institute of Technology, 426
 Stingray aircraft, 193–94
 Stout, Ernest G., 307, 360
 Sturdevant Aeroplane Company, 238
 Sud Aviation, 56
 Sud-Est Aviation, 50
 Sullivan, Mortimer, 242
 Supermarine Seagull flying boat, 443
 Swanson, Claude, 145–46
- Tailer, T. Suffern, 241
 Tasman Empire Airways, 441, 443

- Taylor, David W., 306
- Taylor, Geoffrey I., 117–18
- Taylor, John W. R., 437, 439–40
- Thompson, Floyd L., 122, 126
- Thorburn, 242, 243
- Tichenor, Frank, 39–40, 580–81
- Tilt Rotor Research Aircraft Project Office, 59, 794
- Timoshenko, Stephen, 145
- Transcendental Aircraft Corporation, 58, 711, 795
Model 1-G, 57, 58, 795
- Trimble, William F., 13, 70, 212, 248
- Troller, Theodor, 127, 141
- Truman, Harry S., 624
- Truscott, Starr, 96–98, 298–300, 303–05, 404, 405, 407
- Tuckerman, L. B., 75
- two-dimensional low-turbulence pressure tunnel (Langley Research Center), 635, 638, 649
- U.K. Ministry of Defence, 196
- United States Air Force, 463, 612, 613, 673, 795, 796, 801, 802, 804, 838
- United States Army, 8, 20, 21, 44, 45, 59, 71, 73, 76, 96–98, 112, 238, 239, 247, 413, 606, 610, 628, 673, 794, 795, 801, 802, 829, 856
- United States Army Air Corps, 78, 104, 105, 112, 143, 309, 587
- United States Army Air Forces (USAAF), 45
- United States Army Research and Technology Laboratories, 55
- United States Coast Guard, 26, 45, 239, 247, 249, 611
- United States Department of the Navy, 74, 76–78, 84–86, 89, 90, 92, 94, 98, 103, 113, 116, 125, 127, 315, 370
Bureau of Aeronautics, 10, 36, 52, 70, 94, 98–101, 103–05, 108, 109, 111, 115, 116, 125, 142, 212, 249–51, 259–62, 295, 300, 306–08, 315, 324, 360, 370, 373, 379, 404, 485, 487, 663, 673
- United States Marine Corps, 59, 63, 239, 247, 612, 613, 628, 813, 821, 822, 837, 838, 840, 856
- United States Navy, 9–11, 14, 15, 17, 20, 21, 23, 26, 59, 70–73, 76, 81, 93, 96–98, 103–04, 113, 115, 140, 145, 146, 202, 221, 238–39, 247–49, 261, 262, 295, 307, 311, 317, 319, 324, 409, 418, 422, 448, 485, 612–13, 663, 673, 822, 837, 840
Construction Corps, 262
- University of Maryland, 677, 678
- Upson, Ralph H., 96–98
- U.S.S. Akron, 11, 89, 90, 92–94, 97–99, 101, 104, 105, 107, 116, 127, 142, 143, 171
- U.S.S. Los Angeles (ZR-3), 10, 11, 77, 82, 83, 85, 86, 90, 92, 100, 104, 105, 107, 116, 122, 126, 142, 157, 158, 169, 172, 183, 185
- U.S.S. Macon, 11, 14, 15, 93, 99, 124, 142, 144, 145, 157, 171
- U.S.S. Shenandoah (ZR-1), 10, 11, 72, 73, 76, 81, 107, 140, 142
- Vanaman, Arthur W., 610
- Vanderbilt, Harold S., 241
- variable-density wind tunnel (Langley Research Center), 86–88, 91, 97, 98, 107, 108, 110–121, 128, 152, 296–97
- Verne, Jules, 31, 174, 182
- Vertol Aircraft Corporation/Boeing Vertol, 52, 56, 800, 801, 803, 804, 806
Boeing CH-47, 800, 816, 828
Boeing Vertol CH-46, 800, 822
Boeing Vertol CH-46A, 613
Vertol VZ-2 (Model 76), 56, 57, 736, 737, 776, 783, 800
- Victory, John F., 95
- Vietnam War, 4, 4–5, 61, 628
- Voisin, Gabriel, 21, 204
- von Achenbach, Wilhelm, 31, 36, 606
- von Gablenz, Carl, 198–200
- von Kármán, Theodore, 12, 14, 36, 123, 127–29, 140, 144, 155, 165, 168, 461–63, 512, 596, 617
Karman helicopter, 512, 513
- von Meister, F. Willy, 184, 185
- Vought Aeronautics low-speed wind tunnel, 804
- V/STOL Projects Office, 59
- Walker, Charles Clement, 567, 573
- Warner, Edward P., 35, 95–98, 464, 465, 478–79, 488
- Washington Aeroplane Co., 218
- Water-Based Aviation Award, 418
- Wattendorf, Frank, 141
- Webster, Clifford, 240, 241
- Webster, W. W., 256
- Weick, Fred E., 36, 110, 113, 485–87
- Wenzinger, Carl J., 330, 336
- Westervelt, George C., 306
- Westland Aircraft/Westland Helicopters, 32, 38, 56, 63
EH-1, 63
Westland Lynx, 63
- Wheatley, John B., 677
- Whitten, James B., 52, 674
- Wiley, Herbert V., 144
- Wilford, Burke, 619
- Wilford aircraft
Wilford XOZ-1, 41, 589

- Williford, James R., 613
- Wimperis, H. E., 543, 548, 549, 564, 566, 573
- wind tunnels
- 7- by 10-foot wind tunnel (Ames Research Center), 803
 - 7- by 10-foot wind tunnel (Langley Research Center), 330, 331, 333, 334, 382, **387, 388**, 407, 424, 772
 - 8-foot high-speed wind tunnel (Langley Research Center), 408
 - 16-foot transonic tunnel (Langley Research Center), 656
 - 20-foot wind tunnel (Langley Research Center), 94, 97, 101, 102, 109, 315, 321, 324, 325, 586
 - 30- by 60-foot full-scale wind tunnel (Langley Research Center), **2, 53**, 88, 94, 99, 100, 127, 341, 413, 584, 585, 588, 631, 641, 647, 648, 654, 656, 663, 674, 772
 - 40- by 80-foot wind tunnel (Ames Research Center), 59, 794, 796–98, 801–03
- Office National d'Etudes et de Recherches Aérospatiales 8-meter (26-foot)-diameter S-1 wind tunnel, 803
- propeller research tunnel (PRT) (Langley Research Center), 86, 87, 96, 98–100, 106, 107, 110, 113, 114, 122, 297, 299, 584–86, 588
- two-dimensional low-turbulence pressure tunnel (Langley Research Center), 635, 638, 649
- variable-density wind tunnel (Langley Research Center), 86–88, 91, 97, 98, 107, 108, 113–21, 128, 152, 296–97
- Vought Aeronautics low-speed wind tunnel, 804
- Wise, John, 7
- Wood, McKinnon, 565, 574
- World War I, 9, 10, 23, 25, 28, 34, 67, 140, 148, 185, 212, 219, 248, 456, 711
- World War II, 9, 13–16, 25–28, 39, 40, 42, 44, 45, 49, 51, 55, 61, 70, 143, 185, 239, 250, 295, 328, 329, 360, 361, 403, 418, 419, 436, 438, 533, 580, 663, 677, 711, 712
- Worldwide Aeros Corp. (Aeros), 188–190
- AEROS 40-A, 191
 - AEROS 40-B, 191
 - AEROS 40-C, 191
 - AEROS D-1, 191–192
 - AEROS D-4, 192
 - AEROS D-8, 192
- Wright, Milton, 203
- Wright, Orville, 23, **39**, 201–03, 238, 487
- Wright, Wilbur, 201–03, 238
- Wright aircraft, 591, 592, 871
- Model G, 202, 238
 - Wright Model C, 201
- Wright brothers, 6, 21, 32, 34, 201, 203, 238, 522, 523, 545, 546, 591–93, 624, 703, 869–74. *See also* Wright, Orville, *and* Wright Wilbur
- Wright Company, 202
- Wright Efficiency Trophy, 240
- Wright Field, 96–98, 413, 415, 611
- Wulf, George, 42
- Yakovlev Design Bureau (Yak), 56
- Young, Arthur, 46, **47**, 49, 576, 616, 617, 628, 663
- Yuan, S. W., 463
- Yuriev, Boris N., 34, 606
- Zeppelin, Count Ferdinand von, 9, **12**
- Zeppelin Company, 109, 140, 146, 158, 184, 221
- Zimmerman, Charles H., 58, 788
- ZR-1. *See* U.S.S. Shenandoah
- ZR-2. *See* R-38
- ZR-3. *See* U.S.S. Los Angeles



The NASA History Series

National Aeronautics and Space Administration
NASA History Division
Office of Communications
Washington, DC
2021