

20
22

ANNUAL
HIGHLIGHTS
of RESULTS
from the

INTERNATIONAL SPACE STATION

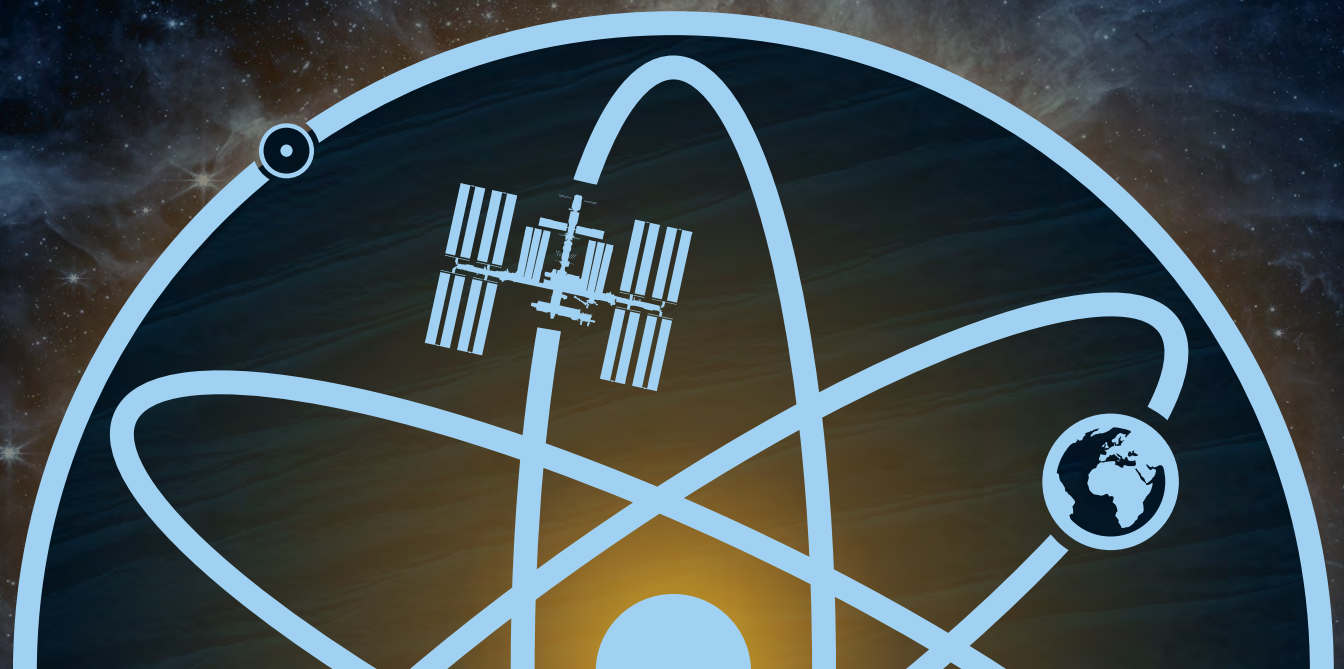

Annual Highlights of Results from the International Space Station

Oct. 1, 2021 - Sept. 30, 2022

A product of the International Space Station Program Science Forum

This report was developed collaboratively by the members of the Canadian Space Agency (CSA), ESA (European Space Agency), Japan Aerospace Exploration Agency (JAXA), National Aeronautics and Space Administration (NASA), and the State Space Corporation ROSCOSMOS (ROSCOSMOS). Visit the [Space Station Research Results Library](#) to find all previous and current editions of the Annual Highlights of Results from the International Space Station.

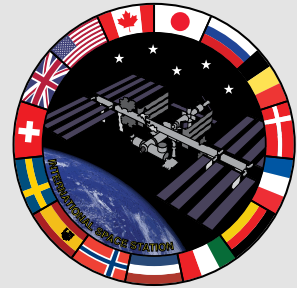

Executive Editor

Kirt Costello, Ph.D.

Managing Editors

Pilar Archila, Ph.D.

David Brady

Library Scientist

Nekisha Perkins

Technical Editor

Carrie Gilder

Graphic Designer

Chris Getteau

Subject Matter Experts

Destiny Doran

Al Cofrin

Digital Editors

Roger Weiss

Ana Guzman

Video Editor

Nicole Rose



Table of Contents

Introduction	1
Publication Highlights	
Biology and Biotechnology	6
Human Research	12
Physical Sciences	17
Technology Development and Demonstration	22
Earth and Space Science	27
List of Archived ISS Publications	32
Resources	75

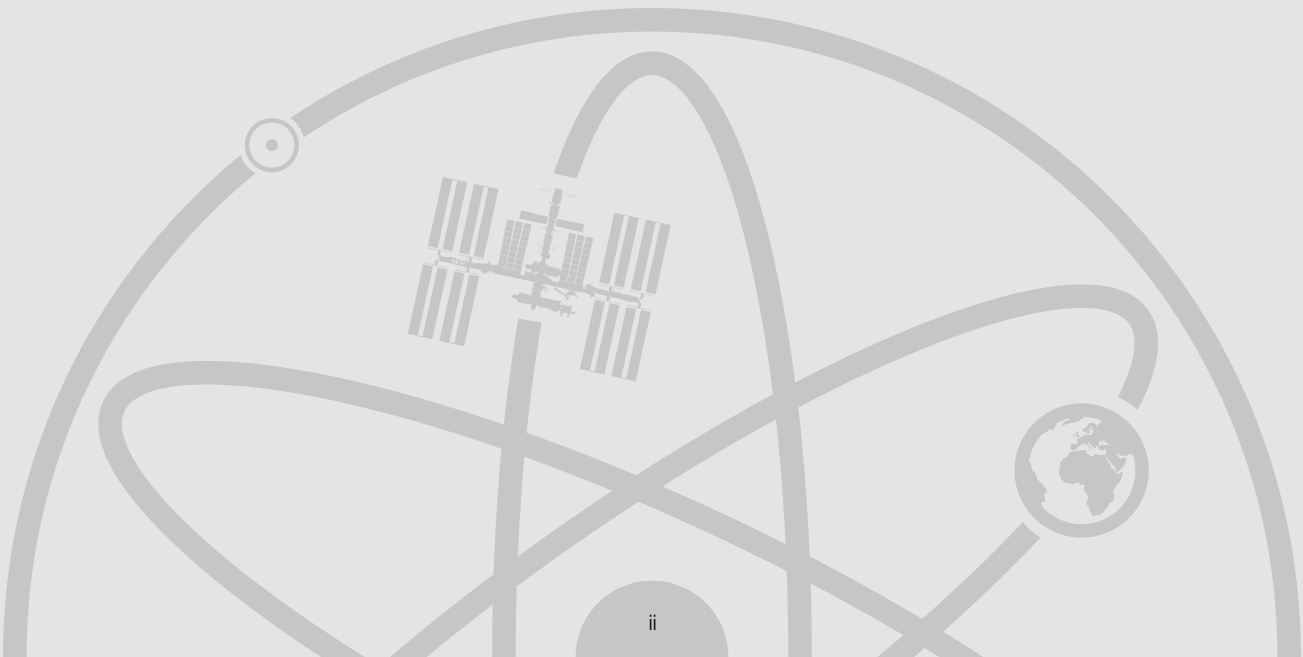

Introduction

Extensive international collaboration in the unique environment of LEO as well as procedural improvements to assist researchers in the collection of data from the ISS have produced promising results in the areas of protein crystal growth, tissue regeneration, vaccine and drug development, 3D printing, and fiber optics, among many others. In this year's edition of the Annual Highlights of Results, we report findings from a wide range of topics in biotechnology, physics, human research, Earth and space science, and technology development – including investigations about human retinal cells, bacterial resistance, black hole detection, space anemia, brain health, Bose-Einstein condensates, particle self-assembly, RNA extraction technology, and more. The findings highlighted here represent only a sample of the work ISS has contributed to society during the past 12 months.

As of Oct. 1, 2022, we have identified a total of 3,679 publications associated with ISS research since 1998 (roughly a 12% increase since last year). Of the 414 articles collected during the 2021-22 fiscal year, 381 appeared in peer-reviewed journals, 30 in conference proceedings, and 3 in gray literature such as books, magazines, or patents. Publications are also categorized based on how authors obtained their results. There were 262 publications that reported direct implementation of the science aboard station (i.e., ISS results), 69 that reported development of the payload prior to operation on the ISS (i.e., Flight Preparation), and 83 that emerged as follow-ups to station science (i.e., Derived). Figure 2 shows a stacked chart of these tallies. ISS publications collected over the years constitute the work of more than 6000 researchers around the world.

The scientific results presented in this Annual Highlights of Results broadly represent the research activities of all the space agencies – National Aeronautics and Space Administration (NASA), the State Space Corporation ROSCOSMOS (ROSCOSMOS), the Japanese Aerospace Exploration Agency (JAXA), ESA (European Space Agency), the Canadian Space Agency (CSA), and the Italian Space Agency (ASI). In addition, a complete list of collected publications in FY-22 is included. This list identifies 131 articles published prior to Oct. 1, 2021.

A publicly accessible database of ISS investigations and publications can be found through the [Space Station Research Explorer \(SSRE\)](#), and all editions of the Annual Highlights of Results can be found through the [Space Station Research Results Library](#).

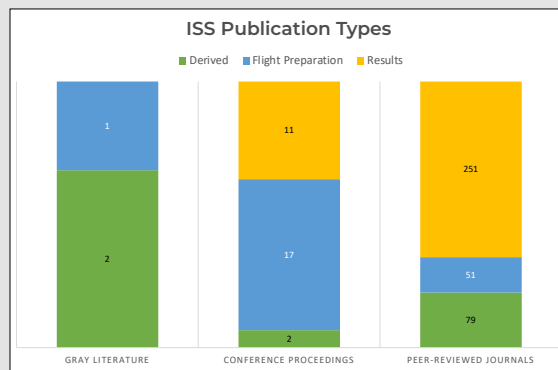

Figure 2. Count of FY-22 ISS publication types. A total of 414 publications were collected. Publications are categorized based on journal format (peer-review, conference proceeding, gray literature) and science acquisition (Flight preparation, Results, and Derived).

MEASURING SPACE STATION IMPACTS

The significant impact of sustained international multidisciplinary research in microgravity can be observed through the findings published in world-class scientific journals that adhere to a rigorous scientific peer-review process.

Bibliometric analyses measure the impact of space station research by quantifying and visualizing networks of journals, citations, subject areas, and collaboration between authors, countries, or organizations¹. Using bibliometrics, a broad range of challenges in research management and research evaluation can be addressed. The network visualizations, stacked charts, and line graphs provided in this introduction demonstrate the growth and impact of ISS research over time.

With the assistance of Clarivate Analytics, a global database that collects publication and journal information for annual journal ranking and metrics, we identified the top science produced by ISS

1. Van Eck NJ, Waltman L. Software survey: VOSviewer, a computer program for bibliometric mapping. *Scientometrics*. 2010; 84(2):523-538. DOI: [10.1007/s11192-009-0146-3](https://doi.org/10.1007/s11192-009-0146-3).

Introduction

	Clarivate Analytics® Rank	Journal (Number of Publications)
ISS Publications in Top 20 Sources	1	Nature Communications (1)
	2	Scientific Reports (8)
	3	Nature (2)
	7	PNAS (1)
ISS Publications in Top 100 Sources	13	Physical Review Letters (4)
	19	Science Advances (2)
	21	International Journal of Molecular Sciences (3)
	25	Nature Medicine (1)
	26	Cell Reports (1)
	30	The Astrophysical Journal (33)
	31	Monthly Notices of the Royal Astronomical Society (20)
	38	Physical Review D (1)
	43	Frontiers in Microbiology (5)
	50	Astronomy & Astrophysics (6)
	57	Geophysical Research Letters (1)

Table 1. ISS publications reported in Top 100 journals, as ranked by Clarivate Analytics Eigenfactor score, during FY 2021-2022.

researchers. One parameter, the journal's Eigenfactor score², identifies the importance of each journal based on readership and influence, including the different citation standards of each discipline.

From Oct. 1, 2021, to Sept. 30, 2022, 89 ISS publications appeared in Top 100 journals, according to Eigenfactor rankings. Of the 89 top-tier publications, 12 were reported in Top 10 journals (see Table 1). Compared to last year's counts, an additional 15 publications were reported in Top 100 journals.

The completion of ISS investigations has contributed to the growth of top-tier publications seen today. As shown in Figure 3, many more ISS studies have been published in high-ranking journals recently compared to previous years. From our earliest record of top-tier ISS science in 2003* to Oct. 1, 2022, there have been **488 articles** published in Top 100 journals, with a large quantity of publications produced by researchers in the Earth and Space Sciences.

In addition to the research diversity and the top-tier results obtained from ISS, a new comparison to global and US standards of category-normalized citation impact shows that the influence of ISS on world science has been much greater since 2010. The authority of ISS research was particularly prominent in 2019, and it continues to permeate the scientific community to date. Figure 4 illustrates this important comparison.

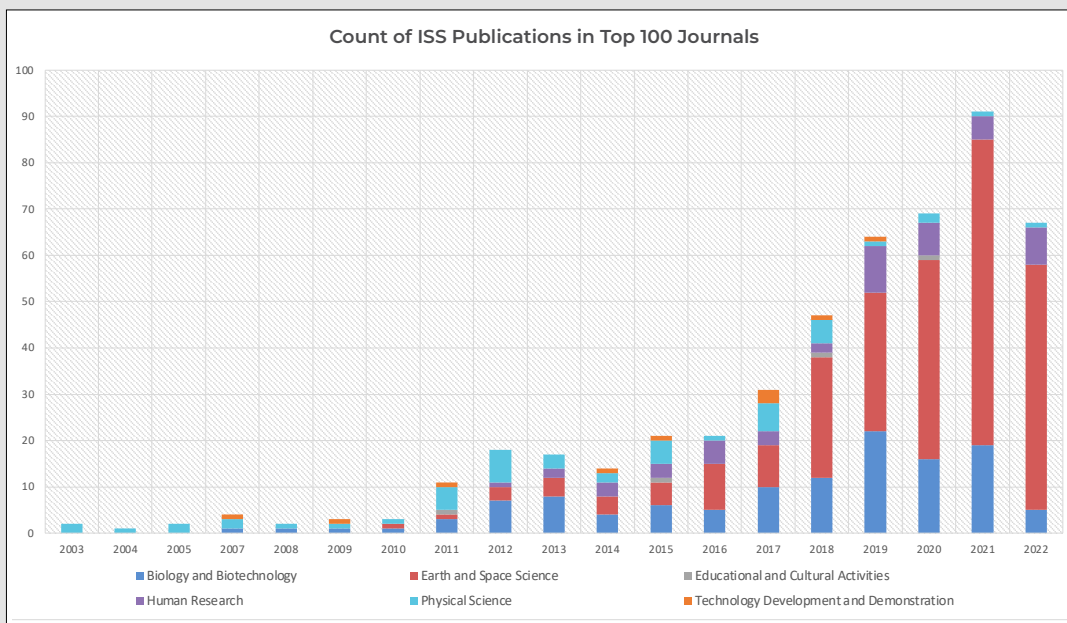

Figure 3. Count of ISS publications reported in journals ranked in the first 100 spots according to global standards of Clarivate Analytics. The 488 publications are shown by year and ISS research category.

2. West JD, Bergstrom TC, Bergstrom CT. The Eigenfactor Metrics™: A Network approach to assessing scholarly journals. College and Research Libraries. 2010;71(3). DOI: [10.5860/0710236](https://doi.org/10.5860/0710236).

Introduction

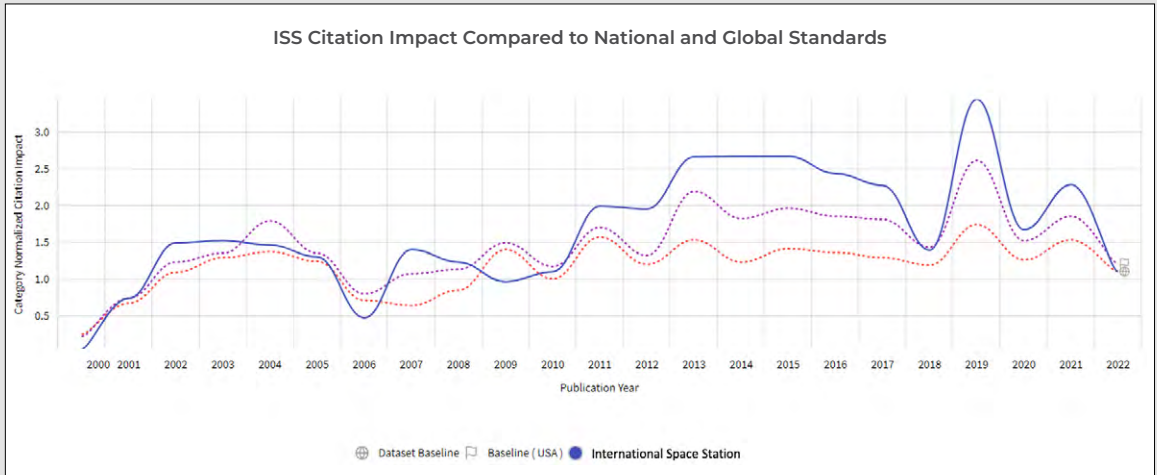

Figure 4. Citation impact (normalized by research area) of ISS publications compared to national and global standards.

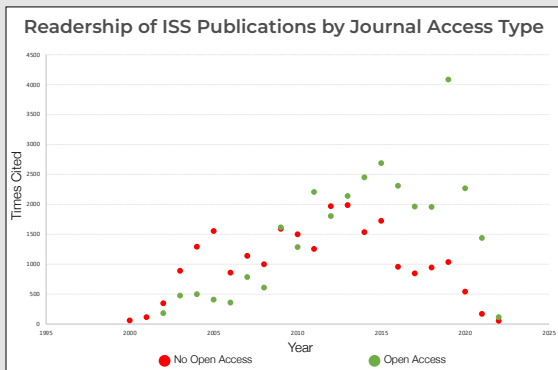

Figure 5. Number of times publications are cited depending on journal access type.

The global impact of ISS science may be explained in part by the types of journals in which ISS researchers publish. Recently, more microgravity research has been published in open-access journals. Accessibility to the latest research findings has led to more reads and citations since 2015, as shown in Figure 5. In addition, journals that are consistently ranked highly according to their Eigenfactor

score (Nature, Scientific Reports, PLOS One, PNAS, and Science) publish scientific articles that accrue up to 500 citations from other researchers. As shown in Figure 6, the ISS investigations Fungal Pathogenesis, RNA Interference (CERISE), Microbial Drug Resistance, and Mice Drawer System (which published articles in years prior to the citation peak in 2013), led the way in ISS research impact through numerous citations that year. In 2019, the ISS investigations Biological Rhythms, JAXA PCG, Otolith, Biomolecule Sequencer, Ice Crystal, Neurospat, and Wearable Monitoring received more attention.

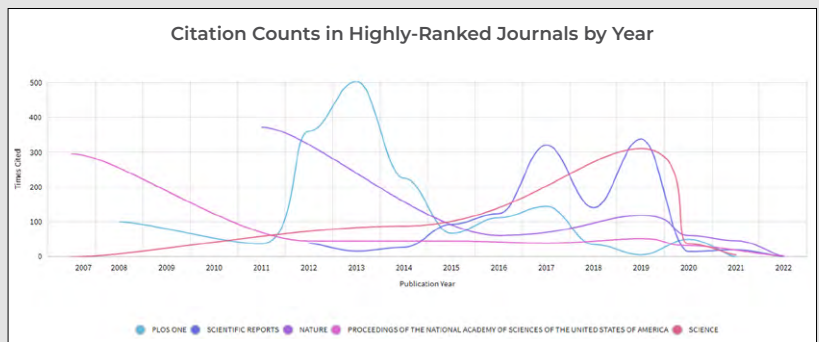



Figure 6. Number of times publications reported in Top 5 journals have been cited since 2007.

Introduction

EVOLUTION OF SPACE STATION RESULTS

The archive of ISS investigations went online in 2004. Since that time, the Research Results team has implemented changes in how investigations are tracked. The team has split and added new research disciplines as more investigations become active, and many fields have been redefined since the roll out of the archive. Currently, the following publication types are included in the Program Science Toolbox:

 **ISS Flight Preparation Results** - publications about the development work performed for the investigation, facility, or project prior to operation on the ISS.

 **ISS Results** - publications that provide information about the performance and results of the investigation, facility, or project as a direct implementation on ISS or on a vehicle to ISS.

 **Derived Results** - publications that use data from an investigation that operated on ISS, but the authors of the article are not members of the original investigation team. Derived Results articles have emerged as a direct outcome of the open-source data initiative, which gives access to raw data for new researchers to analyze and publish innovative results, expanding global knowledge and scientific benefits.

 **Patents** - applications filed based on the performance and results of the investigation, facility, or project on ISS, or on a vehicle to ISS.

 **Related** - publications that lead to the development of the investigation, facility, or project.

LINKING SPACE STATION BENEFITS

ISS research results lead to benefits for human exploration of space, benefits to humanity, and the advancement of scientific discovery. This year's Annual Highlights of Results from the International Space Station includes descriptions of just a few of the results that were published from across the ISS partnership during the past year.



ISS investigation results have yielded updated insights into how to live and work more effectively in space by addressing such topics as understanding radiation effects on crew health, combating bone and muscle loss, improving designs of systems that handle fluids in microgravity, and determining how to maintain environmental control efficiently.



Results from the ISS provide new contributions to the body of scientific knowledge in the physical sciences, life sciences, and Earth and space sciences to advance scientific discoveries in multi-disciplinary ways.



ISS science results have Earth-based applications, including understanding our climate, contributing to the treatment of disease, improving existing materials, and inspiring the future generation of scientists, clinicians, technologists, engineers, mathematicians, artists, and explorers.



Preflight image of the JAXA Cell Experiment Small Prefixation Apparatus for the ISS investigation Fish Scales from which researchers will examine regenerating scales collected from anesthetized goldfish in microgravity. NASA ID: jsc2010e089995.

Publication Highlights

Biology and Biotechnology

The ISS laboratory provides a platform for investigations in the biological sciences that explores the complex responses of living organisms to the microgravity environment. Lab facilities support the exploration of biological systems, from microorganisms and cellular biology to the integrated functions of multicellular plants and animals.



Researchers from the ASI investigation [The Coenzyme Q10 as an Antiapoptotic Countermeasure for Retinal Lesions Induced by Radiation and Microgravity on the ISS: Experiment on Cultured Retinal](#)

[Cells \(CORM\)](#) are currently examining how the antioxidant Coenzyme Q10 can serve to protect against the damaging effects of microgravity and radiation in astronauts.

Microgravity and ionizing radiation, two of the most detrimental stress factors impacting astronaut health, have been found to cause cell death in the ocular tissue of mice as well as numerous alterations involving structures of the brain and the eyes (i.e., Spaceflight Associated Neuro-ocular Syndrome – SANS) in over 50% of astronauts.

In a recent study published in *Cellular and Molecular Life Sciences*, researchers set out to better understand the effect of spaceflight on reported ocular abnormalities to gain new knowledge for potential treatments. Methodologically, researchers exposed several human retinal cell cultures (ARPE-19) to space for 3 days in the cold stowage unit [MELFI](#). Some cell cultures were treated with the well-known bioenergetic antioxidant coenzyme CoQ10 to prevent cell death. Control retinal cells were also cultured on Earth using comparable experimental hardware and following a temperature cycle similar to the one applied in space. Upon return to Earth, researchers examined the anatomy and RNA transcripts of the CoQ10-treated and untreated cells via a TUNEL assay, immunofluorescence, and transcriptomic analysis.

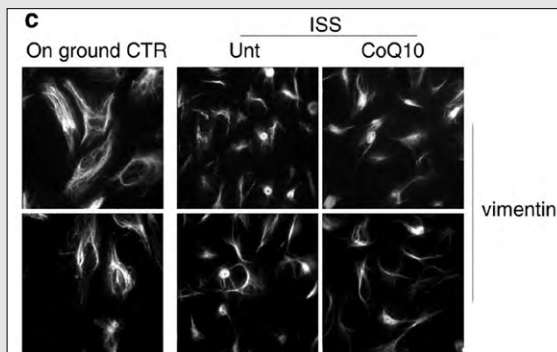

Figure 7. Immunofluorescent images of human retinal cells in different conditions. Image adopted from Cialdai, *Cellular and Molecular Life Sciences*.

Analyses showed that exposure to microgravity did not influence cell proliferation or cell death, regardless of the cell culture's CoQ10 treatment status. However, the vimentin network – critical for cytoskeleton cohesion – showed marked changes and disorganization that indicated disintegration. Additionally, numerous spaceflight adaptation gene expression pathways involved in metabolism, protein processing in the endoplasmic reticulum, and cell aging were affected compared to ground controls. Importantly, researchers noted that fewer pathways were impacted in cells treated with CoQ10, likely because CoQ10 induces the activation and deactivation of certain genes (i.e., TFRC and SLC7A11), increasing death resistance in iron-dependent cells. These results contribute to a better understanding of the cellular and genetic pathology of SANS and to the development of effective countermeasures.

Cialdai F, Bolognini D, Vignali L, Iannotti N, Cacchione S, et al. Effect of space flight on the behavior of human retinal pigment epithelial ARPE-19 cells and evaluation of coenzyme Q10 treatment. *Cellular and Molecular Life Sciences*. 2021 October 29; DOI: [10.1007/s00018-021-03989-2](https://doi.org/10.1007/s00018-021-03989-2).

Publication Highlights

Biology and Biotechnology

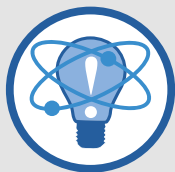

The ROSCOSMOS investigation **Magnetic 3D Bioprinter** is a high-tech device aboard the ISS that uses a magnetic field to assemble bacteria. In a new study published in the *International*

Journal of Molecular Sciences, researchers examined the additive effect of spaceflight and magnetic levitation on the structure, protein expression, and proliferation of the intestinal bacteria *E. coli*. The experiment was conducted during Expedition 58-59 (December 2018).

Intestinal bacteria, which plays a role in many areas of astronaut health, is altered by spaceflight. Bacteria ranging from pathogens to tissue growth receptors are subject to changes in response to external stimuli and as a result, become more prolific or grow excessively when compared to Earth conditions. To understand how bacteria respond to spaceflight and an external magnetic force, researchers observed how the common non-virulent bacterium *E. coli* strain M17 behaved under magnetic levitation on orbit and on the ground. Researchers inspected changes to bacteria morphology, protein activity, and used electron microscopy to evaluate bacteria proliferation. Overall, results suggest that magnetic forces strengthen the effects of microgravity on bacterial metabolism that eventually leads to bacterial self-assembly.

Magnetic levitation was used in microgravity as a force to induce clustering of bacterial cells. To achieve high magnetic force, the bacterial cells were treated with media containing Gadovist, an agent isolated from the rare element gadolinium that has a slightly attractive magnetic field.

Researchers grew bacteria cells under pure microgravity conditions for 144 hours and simultaneously studied the effects of magnetic levitation on Earth. When subjected to both microgravity and a magnetic field, some bacteria showed structural defects in their cell walls. There were also changes in the expression of 23 proteins, and bacteria congregated in the area of least magnetic field, which increased competition for oxygen as a primary resource. Additionally, bacterial enzymes involved in energy regulating processes were more active under magnetic field conditions than those without, both on Earth and in space. Researchers concluded that the morphology, physiology, and behavior of *E. coli* was affected by spaceflight and microgravity more significantly than by microgravity alone.

Interestingly, the ground magnetic force studies had similar results to the combined spaceflight and magnetic field. These results show that magnetic levitation of bacteria on Earth may be useful for spaceflight simulation because similar results were observed across spaceflight and

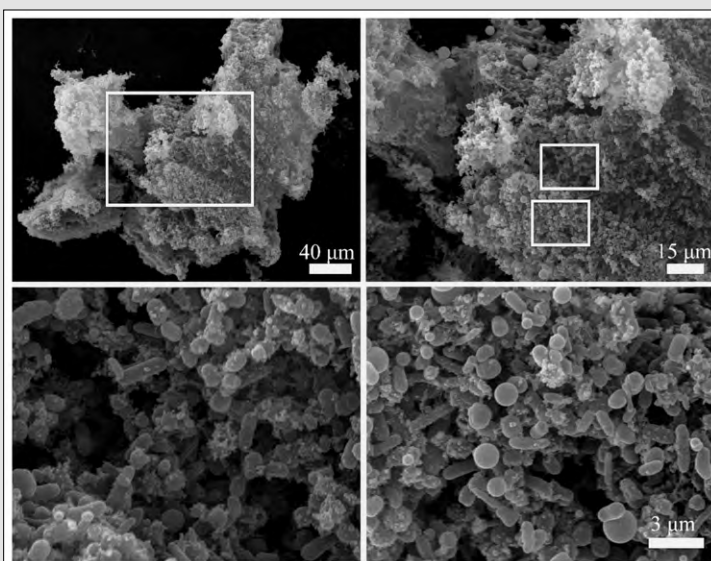

Figure 8. Scanning electron microscopy image of *E. coli* clusters. Image adopted from Patel, *International Journal of Molecular Sciences*.

Publication Highlights

Biology and Biotechnology

ground conditions. These results contribute to the growing understanding of how magnetic force affects bacteria, potentially improving future production of therapeutic bioproducts that could treat arthritis, wounds, and digestive issues.

Patel D, Parfenov V, Kononikhin A, Petrov S, Shevlyagina N, et al. Combined Impact of Magnetic Force and Spaceflight Conditions on *Escherichia Coli* Physiology. *International Journal of Molecular Sciences*. 23.3 (2022), 1837. DOI: [10.3390/ijms23031837](https://doi.org/10.3390/ijms23031837).

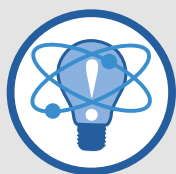

The JAXA investigation [The Effect of Space Environment on Embryonic Stem Cells and their Development \(Stem Cells\)](#) observes how radiation impact the DNA of mouse embryonic stem cells. In the past,

radiation measurements have been focused on the physical environment of microgravity through active or passive dosimeters. However, quantitative predictions by space radiation on biological tissue or cells have proven difficult due to various factors such as interactions between different radiation types (cosmic, solar, magnetic) in microgravity, continuous low doses of radiation on astronauts, individual differences in response to radiation, and reliance on ground simulation experiments.

In this study published in the journal *Heliyon*, researchers compared standard physical radiation estimates defined as dose equivalent by the International Commission on Radiological Protection (ICRP60) to direct biological measurement using chromosome aberration in frozen wild-type and genetically modified mouse embryonic stem cells preserved. The goal was to extrapolate the risks of radiation on humans during spaceflight through the use of an animal cell model. The genetically modified cells lacked the H2AX gene involved in DNA repair; therefore, these H2AX-deficient stem cells were rendered more sensitive to radiation damage.

After 4 years of space exposure in MELFI, stem cells were returned to Earth, thawed, and cultured before conducting an analysis of chromosomal abnormalities. Results showed no differences in chromosomal abnormalities

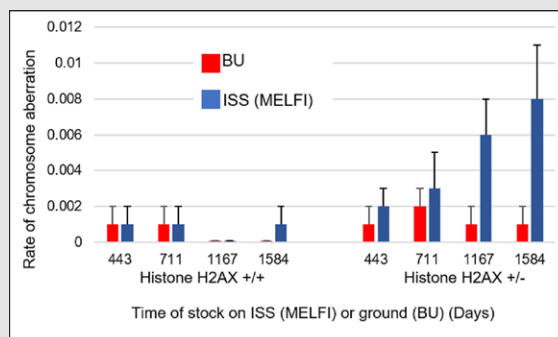

Figure 9. Rates of chromosomal abnormalities in mouse embryonic stem cells. Genetically modified cells more sensitive to radiation (H2AX-deficient) showed more damage after exposure to space. Image adopted from Yoshida, *Heliyon*.

between wild-type stem cells and ground controls. Therefore, length of exposure to space radiation did not play a role in genetic changes. However, the genetically modified stem cells with an increased sensitivity to radiation showed more abnormalities in DNA translocations compared to modified stem cells on the ground. This result suggests that H2AX-deficient stem cells would not be able to completely repair DNA damage accumulated in space, but wild-type cells could. By using a biologically compromised sample of frozen stem cells, researchers were able to detect accumulated radiation damage quantitatively in mouse cells once thawed and cultured on Earth.

Irradiation of the genetically modified stem cells to proton beam by an accelerator on Earth allowed researchers to identify the referential effect of radiation resulting in chromosome translocations. An analysis showed that the biological effect of space radiation in MELFI was

Publication Highlights

Biology and Biotechnology

1.54-fold of proton, while the estimated dose equivalent in MELFI using ICRP60 formulas and data of absorbed doses obtained through the [PADLES](#) physical dosimeter on ISS was 1.48-fold of proton, indicating that they were almost equal. This comparison led researchers to conclude that current predictions of space radiation effects calculated from dosimeters does not over- or underestimate the effects of space radiation on animal cells. These results enhance the understanding of radiation effects on human cancer and increase the confidence in risk assessments for long-duration missions to the Moon and Mars.

Yoshida K, Hada M, Kizu A, Kitada K, Eguchi-Kasai K, et al. Comparison of biological measurement and physical estimates of space radiation in the International Space Station. *Heliyon*. 2022 August 1; 8(8): e10266. DOI: [10.1016/j.heliyon.2022.e10266](https://doi.org/10.1016/j.heliyon.2022.e10266).



The NASA investigation [Microbial Observatory-1](#) examines the diversity of microbes living on the surfaces of the ISS to understand their adaptive changes, their effect on crew health, and contamination of food and air.

In a new study published in *Frontiers in Microbiology*, researchers sampled ISS surfaces from various locations and identified three novel strains belonging to the *Agrobacterium* genomospecies 3 (G3) through ribosomal RNA gene sequencing.

Hundreds of microbial species have been previously isolated from the ISS for a full mapping of microbial diversity. *Agrobacterium* is particularly known for its disease-causing characteristics, and it has been isolated from a variety of inhospitable environments and locations on Earth, including a cave, a hospital, a tobacco plant, and in human cerebrospinal fluid.

The objectives of the study were to describe the phylogenomic novelty and characterize



Figure 10. Microbial Observatory-1 aboard the ISS. NASA ID: iss043e198394

the taxonomic affiliations of the strains, perform comparative genomic analysis with strains from other *Agrobacterium* species, and run a pangenome analysis to identify core homologous gene clusters.

Analysis showed unique phenotypic and genotypic characteristics of *Agrobacterium* genomospecies 3 (G3), demonstrating that the ISS isolate is a separate and authentic bacterial species. Researchers proposed naming the new bacteria *Agrobacterium tomkonis* in honor of David Tomko, a well-known NASA Space Biology scientist who advanced space research in the United States.

The results suggest that *Agrobacterium tomkonis* novel strains can colonize in habitats with fewer nutrients. This capability is advantageous because it eliminates competition for survival with other agrobacteria that grow better in richer environments. The study of microbes offers insight into maintaining the safety of the environment of living spaces for astronauts in spaceflight and for humans on Earth.

Singh NK, Lavire C, Nesme J, Vial L, Nesme X, et al. Comparative genomics of novel *Agrobacterium* G3 strains isolated from the International Space Station and description of *Agrobacterium tomkonis* sp. nov. *Frontiers in Microbiology*. 2021 December 6; 12: 765943. DOI: [10.3389/fmicb.2021.765943](https://doi.org/10.3389/fmicb.2021.765943).

Publication Highlights

Biology and Biotechnology



The ROSCOSMOS investigation [Identifying the Genetic Features Determining Individual differences in the Resilience of Biological Objects to Long-term Spaceflight Factors Studies with the Fruit](#)

[Fly *Drosophila Melanogaster* \(Poligen\)](#) examines chromosomal abnormalities and repair in the fruit fly as an animal model.

Preliminary intergenerational studies of gametogenesis and embryogenesis in fruit fly *Drosophila Melanogaster* have shown reduced development after spaceflight. Researchers think that changes in the expression of genes encoding for cytoskeletal proteins could impact stem cells that eventually become differentiated as eggs and sperm cells.

In the present study published in the *International Journal of Molecular Sciences*, scientists examined reproductive health (respiration, cytoskeletal gene expression, and motility of sperm cells) in the fruit fly *Drosophila Melanogaster* after 12 days in microgravity. Because the fruit fly's lifespan is only about 15 days, young maggots were sent to space so that a full cycle of development, including the development of sperm cells, was achieved during spaceflight. Upon return of adult fruit flies, researchers removed the testes of the males and froze them for subsequent analysis. Samples of *Drosophila Melanogaster* kept on Earth for control purposes were part of a simulation study that replicated the G-forces of launch and landing as well as weightlessness in a random positioning machine.

Results showed that the sperm motility of ISS fruit flies decreased by 35% compared to the fruit flies in the control group on Earth. Adding the protein synthesis inhibitor Ser/Thr phosphate restored motility speed in ground controls but not in the flight sample. However, adding a broad-spectrum protein kinase inhibitor did not restore motility in ground controls but it did do

so for the flight sample. These results suggest that sperm motility is associated with the content of the proteins present in the organism. Because the simulation study that manipulated the gravity forces of launch, orbit, and landing showed significant motility decreases during landing, researchers believe that hypergravity during descent could be the cause of reduced motility in sperm cells.

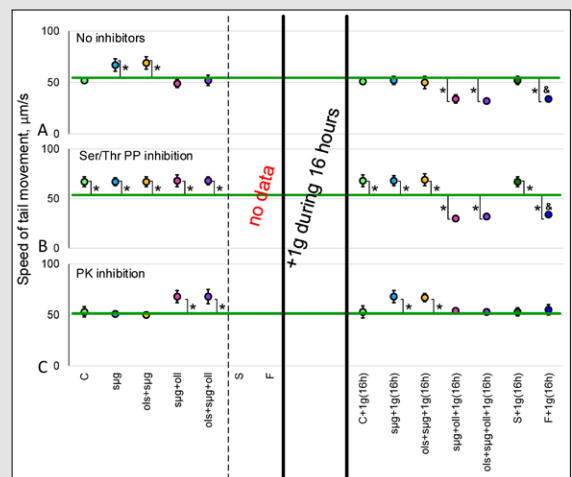

Figure 11. Sperm tail speed across different control conditions and spaceflight. Image adopted from Ogneva, *International Journal of Molecular Sciences*.

As an animal model for the understanding of reproductive health in astronauts, this study demonstrates how spaceflight affects sperm cell motility so that future investigations can develop countermeasures to protect reproductive potential in space.

Ogneva IV, Zhbankina YS, Kotov OV. Sperm of fruit fly *Drosophila melanogaster* under space flight. *International Journal of Molecular Sciences*. 2022 July 6; 23(14): 7498. DOI: [10.3390/ijms23147498](https://doi.org/10.3390/ijms23147498).



ESA crew member Andre Kuipers during his first orbital *Neurospat* session. Kuipers wears an Electroencephalogram (EEG) cap to investigate the effect of spaceflight on visual and spatial perception. NASA ID: iss030e022627.

Publication Highlights

Human Research

ISS research includes the study of risks to human health that are inherent in space exploration. Many research investigations address the mechanisms of these risks, such as the relationship to the microgravity and radiation environments as well as other aspects of living in space, including nutrition, sleep, and interpersonal relationships. Other investigations are designed to develop and test countermeasures to reduce these risks. Results from this body of research are critical to enabling missions to the lunar surface and future Mars exploration missions.

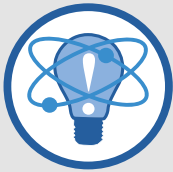

The CSA investigation [Bone Marrow Adipose Reaction: Red Or White? \(MARROW\)](#) assesses the effect of space environment, microgravity in particular, on bone marrow.

Reduced red blood cell (RBC) count, known as space anemia, was reported during the early days of spaceflight. Researchers initially thought that the decrease in RBC was a sudden adaptive response to the fluid shift changes experienced in space. However, recent reports have challenged these early views, showing increased concentration of cell elements in the blood through the entire duration of a flight and positive correlations between anemia severity, recovery time, and flight duration.

Using a new technology that combines breath and blood samples to precisely measure carbon monoxide as a direct indicator of hemoglobin degradation, researchers found increases in RBC destruction that persisted through the duration of the space mission.

Results were published in a recent study in *Nature Medicine*. Relative to preflight, elimination or expiration of carbon monoxide from the body increased by 54% in space. Destruction of RBCs sharply decreased upon astronauts' return to Earth. Moreover, researchers discovered that the hormone erythropoietin, which is involved in the stimulation of new red blood cells, was over-produced during spaceflight. Increased erythropoietin indicated the presence of anemia in astronauts during spaceflight and about 6 months postflight.

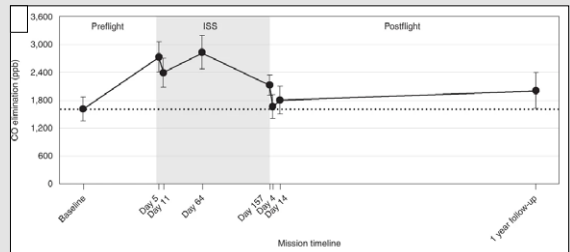

Figure 12. Exhalation of carbon monoxide increased during spaceflight and had not returned to baseline levels one year after spaceflight. Image adopted from Trudel, *Nature Medicine*.

These results demonstrate that early RBC count changes are not an adaptive response. Instead, it indicates that RBC degradation is a primary effect of being in space, and longer exposure to spaceflight worsens space anemia. Anemia is tightly linked to fatigue, dizziness, and an inability to stand upright or exercise; close monitoring of RBC destruction in space is necessary to ensure the health of astronauts and space tourists for safer space exploration.

Trudel G, Shahin N, Ramsay T, Laneuville O, Louati H. Hemolysis contributes to anemia during long-duration space flight. *Nature Medicine*. 2022 January 14; 1-4. DOI: [10.1038/s41591-021-01637-7](https://doi.org/10.1038/s41591-021-01637-7).



Findings from various research studies tracking astronaut health in space are archived in our [ISS medical monitoring](#) investigation. This collection contains a wealth of knowledge regarding the effects of spaceflight on multiple body systems. In a collaboration between ESA and ROSCOSMOS, a new study classified as ISS

Publication Highlights

Human Research

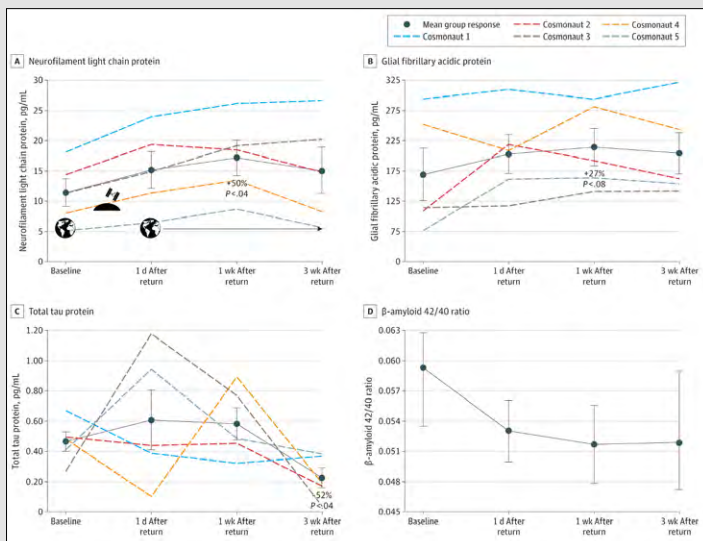

Figure 13. Line graphs of blood-based indicators assessed. Image adopted from zu Eulenburg, *JAMA Neurology*.

medical monitoring reported recent findings in the journal *JAMA Neurology*.

Despite the knowledge gained in the last decade regarding brain health after spaceflight (i.e., ventricular enlargement at the expense of gray and white matter), neuroscientists for the first time have conducted a full assessment of brain tissue integrity after cosmonauts' extended exposure to microgravity.

Blood-based indicators of brain health (i.e., neurofilament light chain, glial fibrillary acidic protein, tau protein, and two amyloid- β proteins) were collected from cosmonauts before and after spaceflight.

Biochemical tests showed a significant increase in neurofilament light chain, tau, and amyloid- β three weeks after flight, indicating axonal injury and increased astrocytic response. Furthermore, a ratio of the two amyloid- β proteins showed a downward trajectory typically associated with poor brain health outcomes. Researchers hypothesize that the increased levels of amyloid proteins observed after spaceflight may

represent an unresolved cleansing from months of accumulated proteins in space.

Further investigation of the subject is necessary to understand the relationship between spaceflight and brain health. A robust understanding of the effects of spaceflight on the human brain supports the safety of astronauts and mission success.

zu Eulenburg P, Buchheim J, Ashton NJ, Vassilieva G, Blennow K, et al. Changes in blood biomarkers of brain injury and degeneration following long-duration spaceflight. *JAMA Neurology*. 2021 October 11; 78(12): 1525-1527. DOI: [10.1001/jamaneurol.2021.3589](https://doi.org/10.1001/jamaneurol.2021.3589).



Findings from various research studies tracking astronaut health in space are archived in the [ISS medical monitoring](#) investigation. This collection contains a wealth of knowledge regarding the effects of

spaceflight on multiple body systems. In a new study sponsored by ROSCOSMOS, researchers take advantage of the connections and influences that exist between the cardiovascular and nervous systems to understand spaceflight-induced changes in human physiology.

The autonomic nervous system (ANS), involved in the unconscious regulation of bodily functions, impacts the frequency of each heartbeat. When under stress or high alert, the sympathetic branch of the ANS signals the heart to beat faster. In a relaxed state, the parasympathetic branch of the ANS signals the heart to beat more slowly. In this study published in *Frontiers in Physiology*, researchers examined preflight-to-postflight concentration changes of 125 blood plasma proteins associated with heart beating frequency in cosmonauts grouped as sympathetic (i.e.,

Publication Highlights

Human Research

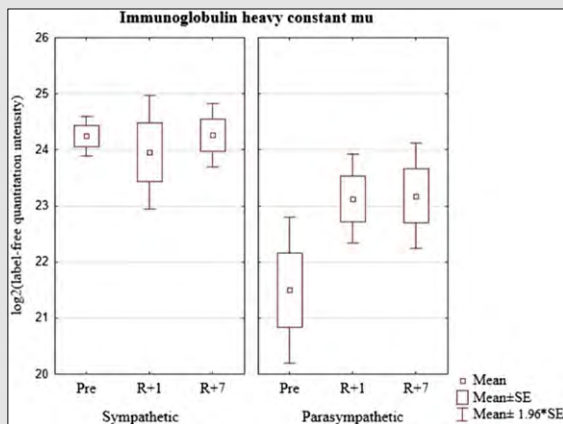

Figure 14. Differences in immunoglobulin heavy constant μ – a measure of autonomic regulation – between sympathetic and parasympathetic crew members before and after spaceflight. Image adopted from Pastushkova, *Frontiers in Physiology*.

stressed state) or a parasympathetic (i.e., calm state) based on an electrophysiological measure obtained before data analysis. Identification of each group's sympathetic and parasympathetic state prior to analysis was important to accurately reveal how spaceflight impacted the cardiovascular system of the cosmonauts. The proteins examined were indicators of cardiovascular regulation. Researchers used liquid chromatography along with mass spectrometry to examine the blood samples.

Results showed that while protein concentrations between the cosmonaut groups differed significantly before flight – making it easier to distinguish the groups at the beginning – such protein concentration differences dissipated after flight. The sympathetic group remained equally stressed postflight compared to preflight, while the parasympathetic group's stress levels increased postflight. The change in autonomic regulation in only the parasympathetic group made the groups indistinguishable after spaceflight. The dynamic changes in protein concentrations after flight suggested that the autonomic nervous system

reacts to internal and external factors to ensure the adaptation of the human body in space.

Proteomic analyses such as these can help researchers identify new biomarkers to better understand the connection between the cardiovascular and nervous systems as well as their influence on readaptation and rehabilitation after spaceflight.

Pastushkova LK, Rusanov VB, Goncharova AG, Nosovsky AM, Luchitskaya ES, et al. Blood plasma proteins associated with heart rate variability in cosmonauts who have completed long-duration space missions. *Frontiers in Physiology*. 2021; 12: 2011. DOI: 10.3389/fphys.2021.760875.



The JAXA investigation [The effect of long-term microgravity exposure on cardiac autonomic function by analyzing 48-hours electrocardiogram for 1YM \(Biological Rhythms 48 hrs\)](#)

monitors heart health in crew members during flight for a continuous 48 hours to understand the effect of spaceflight on human biological sleep/wake cycles.

Recent studies conducted in microgravity for extended periods of time (12 months) suggest that upon adaptation of the organism to space, an anti-aging benefit emerges. For example, changes in the gene expression of *C-elegans* and fruit fly *Drosophila Melanogaster*, as well as lengthened telomeres observed in the [Twins Study](#) suggest that spaceflight could extend the lifespan. Improvements in heart rate, sleep quality, and infraslow oscillations (ISOs) in the brain involved in unconscious processing – all signs of possible adaptation – have also been reported in long-duration spaceflight. In this study published in *Scientific Reports*, researchers were particularly interested in checking for signs of adaptation in the cardiovascular and nervous systems after a prolonged period of time in space.

Publication Highlights

Human Research

An astronaut's cardiac activity – which included various frequency bands, some indicating brain activity in the medial prefrontal cortex, posterior parietal cortex, or posterior cingulate cortex, respectively – was examined before, during,

and after a 12-month mission. Use of additional data of geomagnetic changes collected over the last 200 years allowed researchers to explore a potential contribution of the Earth's magnetic field to human adaptation in space.

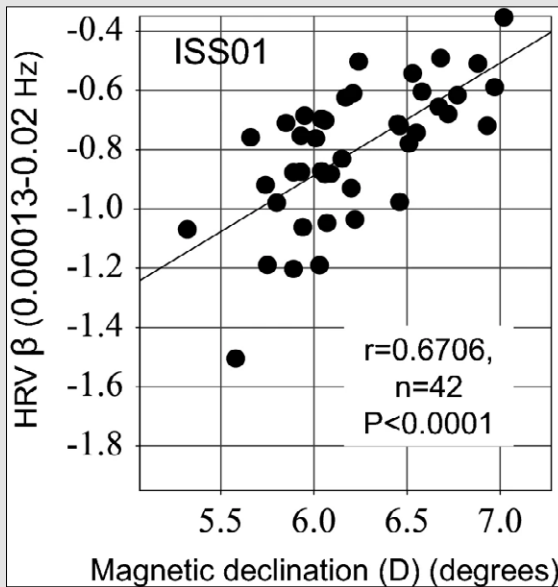

Figure 15. Relationship between Earth magnetic fluctuations and cardiovascular regulation. Results suggest that improved cardiac rhythms relate to magnetic changes in space. Image adopted from Otsuka, *Scientific Reports*.

Results showed that irregularity of the cardiovascular system improved 11 months later, during flight. Such improvement has not been observed in shorter missions. Researchers also noted that improvements in cardiovascular irregularities appear to be linked to increased ISOs in the brain. Moreover, geomagnetic fluctuations appear to have played a role in facilitating regulation of human systems. These results suggest that after a lengthy period of time in microgravity, joint adaptation of the cardiovascular and nervous systems takes place. These intriguing results shed light on the processes involved in neuro-cardiovascular coordination that potentially result in stable human adaptation during prolonged spaceflight.

Otsuka K, Cornelissen G, Furukawa S, Shibata K, Kubo Y, et al. Unconscious mind activates central cardiovascular network and promotes adaptation to microgravity possibly anti-aging during 1-year-long spaceflight. *Scientific Reports*. 2022 July 13; 12(1): 11862. DOI: [10.1038/s41598-022-14858-8](https://doi.org/10.1038/s41598-022-14858-8).



ROSCOSMOS cosmonaut Oleg Novitskiy runs a session for the *Plasma Kristall-4* experiment to investigate how low temperature gaseous mixtures lead to improved spacecraft designs. NASA ID: iss065e124411.

Publication Highlights

Physical Science

The presence of gravity greatly influences our understanding of physics and the development of fundamental mathematical models that reflect how matter behaves. The ISS is the only laboratory where scientists can study long-term physical effects in the absence of gravity without the complications of gravity-related processes such as convection and sedimentation. This unique microgravity environment allows different physical properties to dominate systems, and scientists are harnessing these properties for a wide variety of investigations in the physical sciences.



The ESA investigation [Transparent Alloys – SEBA](#) allows prolonged real-time observations of microscopic changes occurring during spaceflight to transparent metal mixtures.

When two liquid metals are mixed, parameters such as temperature, specific volume, and cooling velocity impact how the metallic blend solidifies. Either a single combined composition or two separate solids with bands and hexagonal arrangements can result, depending on the interaction and dynamics of such parameters. Nonequilibrium dynamical phenomena within the mix may explain the resulting pattern.

In this study published in *Scripta Materialia*, researchers for the first time present a real-time analysis of a two-solid microstructural formation in microgravity to describe the relative stability of the different patterns during directional solidification. Using optical imaging in microgravity, researchers observed the process of directional solidification of a metallic simulation mixture (SCN-DC). While this mixture is normally known only to create rod-like patterns during solidification, researchers discovered that at a slow growth rate, the metallic mixture forms both rods and bands separated by a sharp boundary. More specifically, the microstructural formations transitioned from band-like to rod-like patterns. The co-occurrence of bands and rods demonstrates a dynamic transition in an imbalanced system, given that the new configuration resulted from the variations of multiple physical parameters.

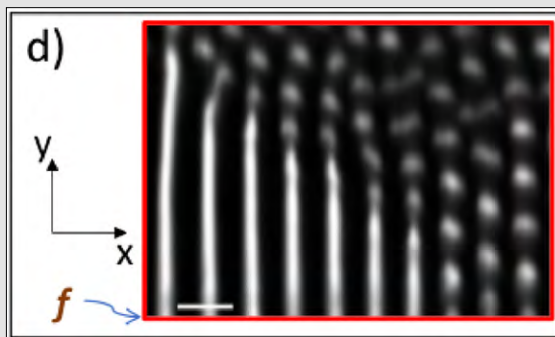

Figure 16. Optical image of rod-like and band-like patterns coexisting during directional solidification of a metal mixture. Image adopted from Bottin-Rousseau, *Scripta Materialia*.

Through this experiment, researchers showed how to produce a composite material with a self-organized architecture, thereby advancing the knowledge for conducting materials science research on particle self-assemblies and micropatterning.

Bottin-Rousseau S, Witusiewicz VT, Hecht U, Fernandez JJ, Laveron-Simavilla A, et al. Coexistence of rod-like and lamellar eutectic growth patterns. *Scripta Materialia*. 2022 January 15; 207: 114314. DOI: [10.1016/j.scriptamat.2021.114314](https://doi.org/10.1016/j.scriptamat.2021.114314).



The NASA investigation [Cold Atom Lab](#) uses microgravity to reach very cold temperatures that make atoms motionless. Immobilized atoms can be inspected for extended periods of time.

When atoms are cooled enough, they behave in a strange way not characterized by the

Publication Highlights

Physical Science

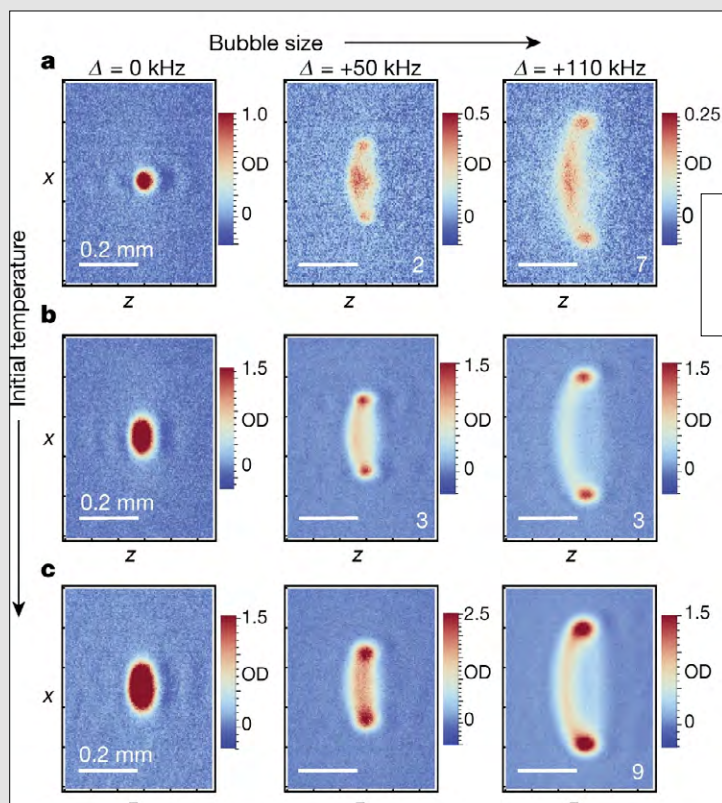

Figure 17. Bubble growth of ultracold atoms. Image adopted from Carollo, *Nature*.

four preexisting states of matter. When the temperature is extremely low, atoms slow down so much they almost stop moving and they stop behaving like individual atoms and more like a wave. When the atoms reach this state of slow, wavelike behavior, they are referred to as a Bose-Einstein Condensate—the fifth state of matter. In the Cold Atom Lab, researchers use multiple lasers and evaporative cooling to cool atoms down to temperatures of less than 100 picoKelvin, which is a billion times colder than the vacuum of space. Presently, researchers are looking to learn more about the shape and behavior of these atoms, as their behavior is still not well understood.

In a new study published in *Nature*, researchers used the Cold Atom Lab to observe the

geometry and topology of resulting ellipsoids and produced some of the first geometric and thermodynamic measurements made with ultracold atoms in space. Results show that by varying the initial temperatures of atom samples, researchers created extremely thin, hollow spheres of different sizes and demonstrated that more cooling was associated with larger bubble size. Additionally, researchers characterized excitement within the atoms and produced imagery of the transition of shape. This result can only be achieved in microgravity because atoms on Earth pool downward and form a shape more like a contact lens than a bubble.

The observed ultracold bubble systems allow researchers to establish a model and theoretical framework for Bose Einstein Condensates. This result paves the way for work on understanding Bose Einstein

Condensate thermodynamics and assists efforts to reach a condensed bubble state that allows for further discovery. These groundbreaking geometric results help advance fundamental quantum research by improving understanding of the shapes, dimensions, and interactions that exist in collections of ultracold atoms. Advancements of the Cold Atom Lab or similar future systems could help create new superconductors, improve quantum computing, and help us to better define how gravity interacts in our universe.

Carollo RA, Aveline DC, Rhyno B, Vishveshwara S, Lannert C, et al. Observation of ultracold atomic bubbles in orbital microgravity. *Nature*. 2022 May 18; 1-6. DOI: [10.1038/s41586-022-04639-8](https://doi.org/10.1038/s41586-022-04639-8).

Publication Highlights

Physical Science



The JAXA facility [Electrostatic Levitation Furnace \(ELF\)](#) is a containerless laser heater that melts materials such as oxides, semiconductors, insulators, and mixed metals to study their behavior in high temperatures

in microgravity. Because the samples do not touch the surface of a container during levitation, chemical reactions that would contaminate the sample do not occur in microgravity.

In physical science, levitated samples can be produced by electrostatic and aerodynamic methods. On Earth, the collection of thermophysical data is challenged by methods such as container contamination and the requirement for a large electric field and gaseous environment. While the invention of electrostatic levitation methods has improved some ground testing, there are still certain elements that cannot be accurately assessed on Earth. On station, containerless melts allow the use of a smaller electric field.

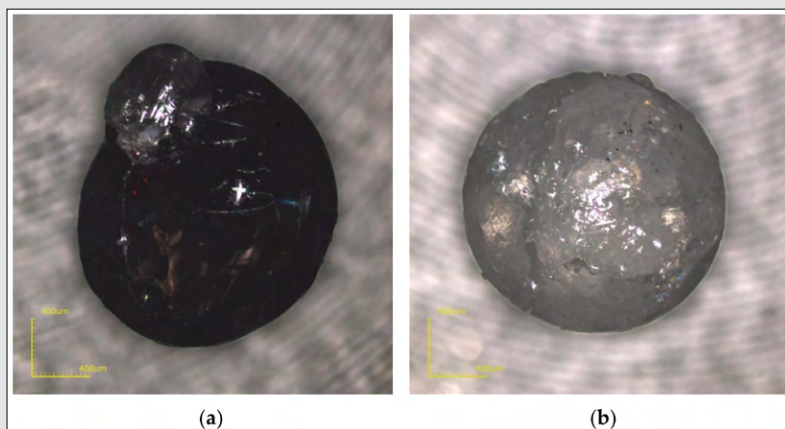

Figure 18. Lanthanoid Yb_2O_3 sample before (a) and after (b) spaceflight. Note that Earth-based impurities are not present in microgravity. Image adopted from Ishikawa, *Metals*.

Spherical samples of each material (Tm_2O_3 , Yb_2O_3 , and Lu_2O_3) were chemically treated to be reactive to radiation from the semiconductor laser. A collection of images from two different cameras were used to calculate the density. Slight mass losses were identified due to evaporation during the experiment, and densities were determined using the final masses weighed on the ground. However, the

densities of Tm_2O_3 , Yb_2O_3 , and Lu_2O_3 were successfully measured by the ELF, and results showed good agreement with literature values. These results allow researchers to work towards measuring surface tension and viscosity and uncover thermophysical properties of materials that have even higher melting temperatures, such as zirconium dioxide (ZrO_2) and hafnium oxide (HfO_2).

The advancement of 3D printing technology calls for the development and use of different industrial materials. Lanthanoid sesquioxides are rare Earth metals used in oxide melting that have high melting temperatures, and their thermophysical properties are not yet well understood. To obtain density data for three different lanthanoids (Tm_2O_3 , Yb_2O_3 , and Lu_2O_3), a new study published in the journal *Metals* used high powered lasers to heat and melt spheres of the materials. The density and mass values recorded are among emerging data of less documented properties and provide a helpful benchmark for future testing and experimentation of materials with even higher melting temperatures.

densities of Tm_2O_3 , Yb_2O_3 , and Lu_2O_3 were successfully measured by the ELF, and results showed good agreement with literature values. These results allow researchers to work towards measuring surface tension and viscosity and uncover thermophysical properties of materials that have even higher melting temperatures, such as zirconium dioxide (ZrO_2) and hafnium oxide (HfO_2).

Ishikawa T, Koyama C, Oda H, Shimonishi R, Ito T, Paradis P. Densities of liquid Tm_2O_3 , Yb_2O_3 , and Lu_2O_3 measured by an electrostatic levitation furnace onboard the International Space Station. *Metals*. 2022 July; 12(7): 1126. DOI: [10.3390/met12071126](https://doi.org/10.3390/met12071126).

Publication Highlights

Physical Science



The NASA investigation [Packed Bed Reactor Experiment- Water Recovery \(PBRE-WR\)](#)

investigation aboard the ISS studies the behavior of gases and liquids that flow simultaneously in open spaces (i.e., columns or beds). Different bed shapes and early introduction of gas-liquid mixing enhances interphase contact and promotes the formation of a homogeneous mixture.

packing size to eliminate external disturbances, minimize recirculation of gas and liquid, and increase overall pressure.

PBRE-2 uses the same glass material and random distribution of the packing beds, but each bed size was decreased from 3 mm to 2 mm to improve pressure readings during lower flow rates. After 400 gas-liquid flow rate combinations and their respective gas and liquid flushes, video observations, pressure traces,

and pressure drop data, researchers identified four flow patterns (i.e., bubble flow, pulse flow, gas channeling, and large bubble pattern) that qualitatively characterize the behavior of two-phase gas and liquid flows in microgravity.

This testing successfully demonstrated that the new PBRE-2 system provides accurate results during higher gas and liquid flows. Enhanced understanding of hydrodynamics in microgravity leads to improved design and operation of two-phase gas-liquid flows, which is critical for chemical and biological systems involved in fuel cells, life-support, nutrient transport, heat pipes, materials processing, and pharmaceutical production.

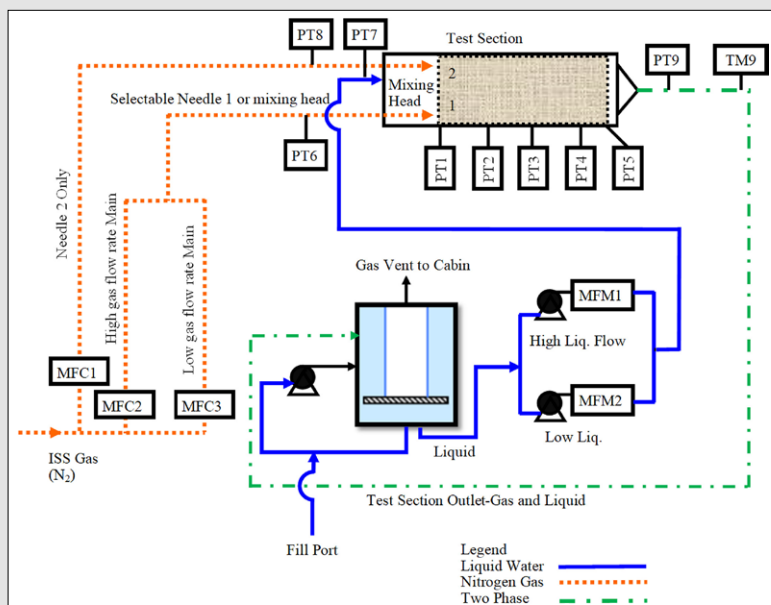

Figure 19. Diagram of Packed Bed Reactor Experiment-2. Image adopted from Taghavi, American Institute of Chemical Engineers (AIChE).

The first generation of the PBRE, designed to deliver controlled flows of gas and liquid in a loop system, generated small pressure oscillations during higher flow rates that were addressed by the second generation of the payload (PBRE-2). In a new report published in the journal *American Institute of Chemical Engineers (AIChE)*, researchers updated the PBRE-WR with perforations and a reduced bed

Taghavi M, Motil BJ, Nahra HK, Balakotaiah V. Gas-liquid flows through porous media in microgravity: Packed Bed Reactor Experiment-2. *American Institute of Chemical Engineers (AIChE) Journal*. 2022 April 19; DOI: [10.1002/aic.17727](https://doi.org/10.1002/aic.17727).



NASA crew member Megan McArthur observes the Astrobee robotic free-flyer inside the Kibo laboratory module. As part of the SoundSee Mission investigation, the robotic assistant "listened" to station equipment to detect anomalies in systems that may need maintenance or repair. NASA ID: iss065e162209.

Publication Highlights

Technology Development and Demonstration

Future exploration — the return to the Moon and human exploration of Mars — presents many technological challenges. Studies on the ISS can test a variety of technologies, systems, and materials that are needed for future exploration missions. Some technology development investigations have been so successful that the test hardware has been transitioned to operational status. Other results feed new technology development.

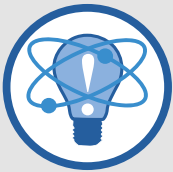

[Mochii](#), a scanning electron microscope for high-resolution imaging and elemental analyses of organic and inorganic materials, is a NASA investigation that was flown to the ISS in 2020 and 2021 to

acquire textural, morphological, and chemical information from multiple samples. Mochii is capable of measuring sample responses to radiation, recording changes over time such as sample growth, and recording the readings of ISS instruments for spacecraft and crew safety.

In a new study published in *Microscopy and Microanalysis*, Mochii's technology was tested by analyzing a fragment of a Martian meteorite found in Antarctica in 1984 thought to possibly contain traces of minerals suggestive of microbial life. The fragment was first analyzed on Earth with a full-size scanning electron microscope and a ground version of Mochii, then compared to the analysis of Mochii's flight version.

Once astronauts aboard the ISS loaded the meteorite sample into Mochii, researchers could analyze the samples remotely from Earth. Data processing showed good agreement between in-space and Earth analyses, indicating accurate functioning of Mochii in low-Earth orbit.

An ISS-certified scanning electron microscope that reads trace element information from various materials is crucial to support mining efforts searching for fuels to power Moon surface and orbital operations. Mochii provides a remarkable capability for researchers interested in understanding the formation of planets and the origin of life in the universe.



Figure 20. Mochii system. NASA Image iss067e123927.

Own C, Thomas-Keprta KT, Clemett S, Rahman Z, Martinez J, et al. Electron microscopy and analysis of Martian meteorite ALH84001 with MochiiSS-NL on the International Space Station. *Microscopy and Microanalysis*. 2022 August; 28(S1): 2712-2718. DOI: [10.1017/S1431927622010224](https://doi.org/10.1017/S1431927622010224).



The ESA investigation [Haptics-2: Real-time teleoperation experiment conducted by crew from Space to control robotic components on Earth with force-feedback \(ESA-Haptics-2\)](#) assesses

the ability of crew members to control robotic systems on Earth from the ISS. Understanding these crew capabilities enables remote operations from space stations to the Moon, Mars, asteroids, and other celestial bodies.

Hazardous conditions arise when automatic docking systems cease to function and manual input is required to guide spacecraft and manipulate large on-orbit modules. Knowing that task performance (i.e., pushing strength,

Publication Highlights

Technology Development and Demonstration



Figure 21. Cosmonaut operating the ESA Haptics-2 joystick and aiming task. Image adopted from Weber, *Applied Ergonomics*.

tracking, speed, and aiming) deteriorates during spaceflight due to the absence of Earth gravity, stress, sleep deprivation and altered proprioception, a focus on training is necessary to sharpen the crew's sensorimotor abilities and ensure successful human-machine interfaces.

In a new collaborative study between ESA and ROSCOSMOS published in *Applied Ergonomics*, researchers examined how aiming performance is supported or hindered by a variety of haptic settings before, during, and after spaceflight. Using a force feedback joystick that had different options for manipulating spring stiffness, motion damping (i.e., control), and virtual mass, three crew members controlled a cursor on a computer screen to match four different targets. A control ground study was simultaneously conducted to compare time performance differences.

Results showed faster reaction time from the first preflight session to the last postflight session. Similar faster times were observed for rapid motion, fine motion, and acceleration sign changes, demonstrating that microgravity did not impair the cosmonauts' ability to produce rapid movements or precise aiming, especially after a period of adaptation. However, some individual differences in sensorimotor skills

emerged. While two cosmonauts showed decreased speed in rapid and fine movement during the early phase of adaptation relative to the ground study, the cosmonaut with above-average skill showed unchanged rapid and fine movement speed during the early phase of adaptation. Researchers concluded that the low stiffness of the joystick supports aiming precision in microgravity and individual sensorimotor skill facilitates machine operation.

This study provides critical information for the safe remote manipulation of robots and flight control systems during spaceflight operations.

Weber B, Schatzle S, Stelzer M. Aiming performance during spaceflight: Individual adaptation to microgravity and the benefits of haptic support. *Applied Ergonomics*. 2022 September; 103: 103791. DOI: [10.1016/j.apergo.2022.103791](https://doi.org/10.1016/j.apergo.2022.103791).



The ESA investigation [Microbial Aerosol Tethering on Innovative Surfaces in the International Space Station \(MATISS\)](#) examines how bacteria adheres to surfaces in microgravity to develop better

cleaning products and antibacterial materials to reduce microbial contamination on surfaces aboard the ISS.

Many microorganisms on the ISS are brought there by crew members, with their origins coming from inside the body via mucus, or outside the body from bacteria and fungi on skin. The spread of these microbes is currently inevitable. When droplets containing small organisms land on a commonly touched surface on spacecraft, they attach themselves and eventually contaminate the surface. To inhibit prolific evolution of potentially harmful species, scientists are looking for ways to develop new surfaces that not only reduce surface-to-droplet interaction, but also reduce the possibility of microbial attachment. In order to find potential surface coatings that limit contamination,

Publication Highlights

Technology Development and Demonstration

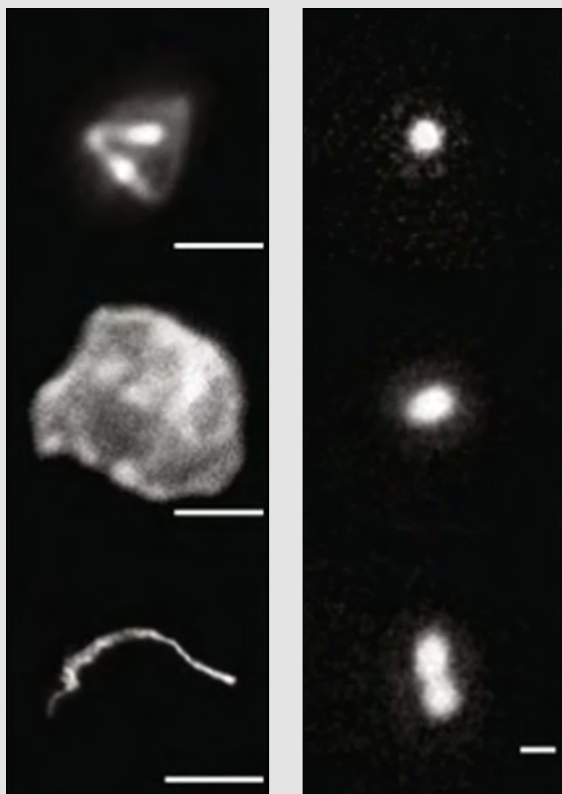

Figure 22. Optical images of coarse and fine particles observed on FDTS-coated surfaces. Image adopted from Lemelle, *Npj Microgravity*.

researchers used a special solvent called Perfluorodecyltrichlorosilane (FDTS) that has moisture-sensitive properties.

FDTS is a liquid chemical that bonds to surfaces such as glass. In a study published in *Npj microgravity*, glass holders were treated with FDTS, sterilized, and then placed in the Columbus module for periods varying from 40 days to nearly a year. Results show that FDTS is the most efficient hydrophobic coating that has been used to prevent the sticking of droplets and subsequently lessen surface contamination. Differences in sizes of particles collected within the holder offers a chance for further study on the movement of water droplets. Additionally, the data underscores the importance of developing

air filtration systems that remove larger particles from the air that may otherwise be inhaled.

Through three different MATISS investigations, the size of particles captured by the microbial monitoring device greatly varied, but the environment was cleaner overall. However, it was noted that the number of crew members present on board has an impact on surface contamination measurements, with lower crew numbers having the lowest surface contamination data. It should be noted that the lowest contamination data was found during the Covid-19 pandemic, which directly limited the number of crew on board.

The development of surface materials and preventative measures improves spacecraft sterility and decreases biohazardous risks to astronauts.

Lemelle L, Rouquette S, Mottin E, Le Tourneau D, Marcoux P, et al. Passive limitation of surface contamination by perFluoroDecylTrichloroSilane coatings in the ISS during the MATISS experiments. *npj Microgravity*. 2022 August 4; 8(1): 1-8. DOI: [10.1038/s41526-022-00218-3](https://doi.org/10.1038/s41526-022-00218-3).



The NASA investigation [One-Step Gene Sampling Tool](#) extracts ribonucleic acid (RNA) directly from plant or animal tissue for real-time analysis aboard the ISS.

Assessing gene expression changes in response to spaceflight allows researchers to understand adaptation processes in different organisms. Understanding the adaptation mechanisms of plants is critical because as crews become more independent in future missions to the Moon and Mars, they will need to rely on space-based plant cultivation for self-sustenance and survival.

Until the development of the One-Step Gene Sampling Tool, all plant genetic analyses were performed on Earth after spaceflight due to crew time limitations, reduced working area on ISS, and liquid handling concerns in microgravity.

Publication Highlights

Technology Development and Demonstration

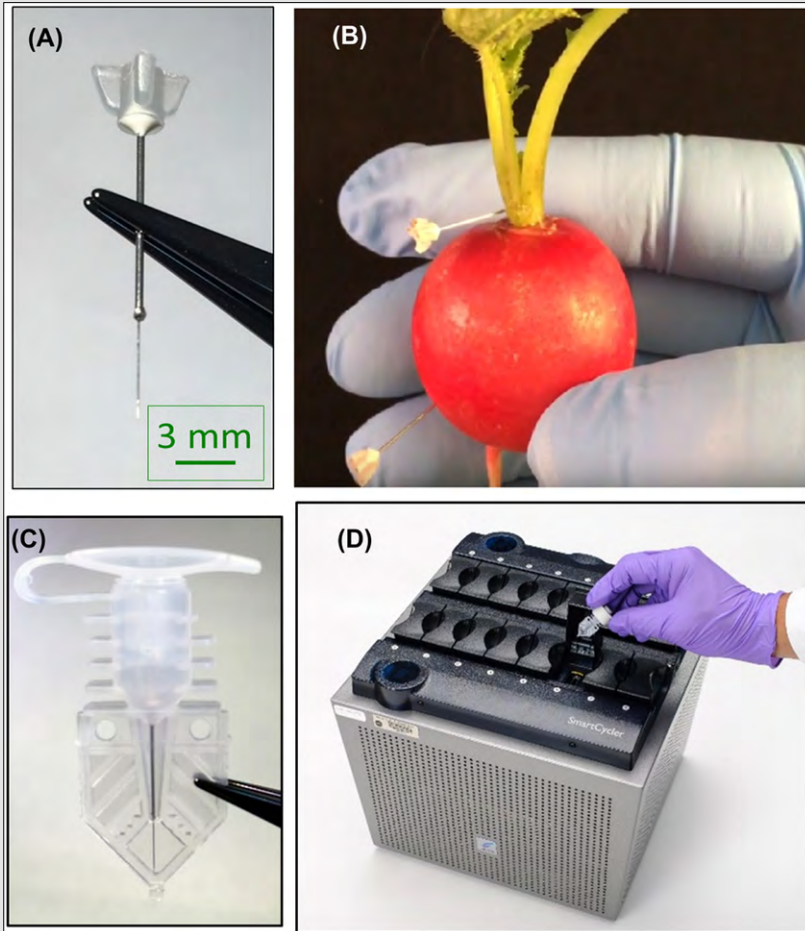

Figure 23. One-Step Gene Sampling Tool process. The small pin obtains plant tissue which is placed in the SmartCycler for the extraction of RNA. Image adopted from Nestorova, *Acta Astronautica*.

Unfortunately, long waiting periods between testing and analysis, few biological replicates, and changes associated with plant freezing or fixation can impact results. Therefore, a new technology that requires minimal liquid handling and power consumption is needed to conduct adequate plant genetic analysis in microgravity.

In this validation study published in *Acta Astronautica*, researchers report on-ground and spaceflight validation of this user-friendly and efficient technology for RNA extraction from plant or animal tissue without the use of

liquids. An RNA capture pin (RCP) selects and purifies high-quality mRNA from biological material without requiring pre-processing steps. This method is faster than the previous RNA prep protocol aboard the ISS and is completely dry, allowing collection of multiple samples of the same specimen and repeat genomic analysis with high spatial resolution. Using Cherry Bell radishes, researchers found that the ground control test showed similar results to the experiment onboard the ISS.

This new tool simplifies the procedures for genetic screening onboard the ISS, enhances analyses without destroying specimens, and creates new opportunities for assessment of long-term plant and animal adaptation responses to microgravity in real-time.

Nestorova GG, Crews N, Schramm AK, Aquilina RA, Parra MP, Chin M, Chinn T, Hee L. Spaceflight validation of one-step Gene Sampling tool for genetic analysis on the International Space Station. *Acta Astronautica*. 2022 September 1; 198: 225-232. DOI: [10.1016/j.actaastro.2022.05.023](https://doi.org/10.1016/j.actaastro.2022.05.023).



The ESA investigation ASIM examines the role of severe thunderstorms in Earth's atmosphere. NASA ID: iss057e080464.

Publication Highlights

Earth and Space Science

The position of the space station in low-Earth orbit provides a unique vantage point for collecting Earth and space science data. From an average altitude of about 400 km, details in such features as glaciers, agricultural fields, cities, and coral reefs in images taken from the ISS can be combined with data from orbiting satellites and other sources to compile the most comprehensive information available. Even with the many satellites now orbiting in space, the ISS continues to provide unique views of our planet and the universe.

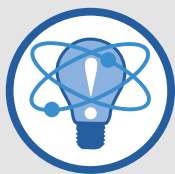

The NASA investigation [Neutron star Interior Composition Explorer \(NICER\)](#) is designed to observe the structure, physical properties, and changes of neutron stars.

In a new study published in *The Astrophysical Journal Letters*, a short burst from the soft gamma-ray repeater Swift J1555.2-5402 was detected by the Burst Alert Telescope (BAT) on June 3, 2021. Monitoring began 1.6 hours after the burst using the NICER telescope. In one month of monitoring, BAT detected 5 bursts and NICER detected 45 bursts. One hard x-ray of strong energy was detected by the Nuclear Spectroscopic Telescope Array (NuSTAR).

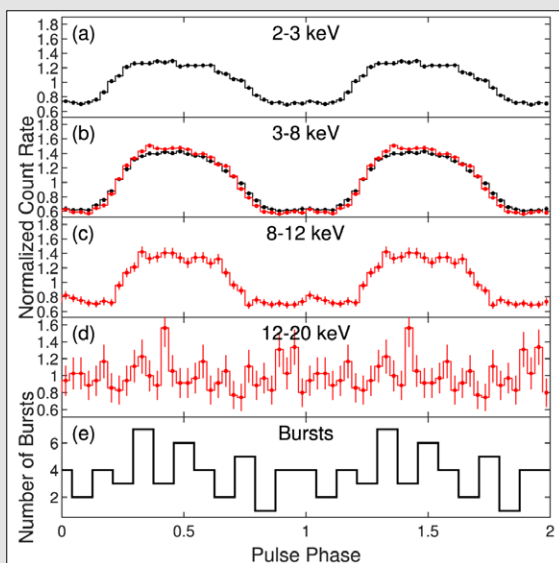

Figure 24. X-ray pulses of Swift J1555.2-5402 in different energy bands, NICER data points in black, NuSTAR data points in red. Image adopted from Enoto, *The Astrophysical Journal Letters*.

Pulse monitoring with NICER provided a time-series capability as well as the ability to examine the physical properties of Swift J1555.2-5402. The physical properties noted were a constant flow of energy with a slight decline at the end of the observation period; a single waveform of soft X-rays, which indicated low energy; temperature decline; a weak magnetic field; and decreased luminosity, indicating loss of energy.

All the measurements obtained suggested that Swift J1555.2-5402 is a young magnetar. Magnetars are highly magnetized neutron stars that are usually bright in X-rays as a result of the release of an enormous amount of magnetic energy. Understanding all the physical properties combined suggested to the researchers that Swift J1555.2-5402 is one of the youngest magnetars ever discovered.

Enoto T, Ng M, Hu C, Guver T, Jaisawal GK, et al. A month of monitoring the new magnetar Swift J1555.2-5402 during an X-ray outburst. *The Astrophysical Journal Letters*. 2021 October 5; 920(1): L4. DOI: [10.3847/2041-8213/ac2665](https://doi.org/10.3847/2041-8213/ac2665).



The ESA investigation [EXPOSE-R2 Biology and Mars Experiment \(BIOMEX\)](#) examines the survival of organisms in the extreme environment of space.

Improving microbial-based technologies is critical to the advancement of space exploration. Complex symbiotic interactions between microbes in artificial ecosystems can allow for oxygen production, conversion to organic compounds, water purification, waste recycling, and food production. Developing capabilities to live off

Publication Highlights

Earth and Space Science

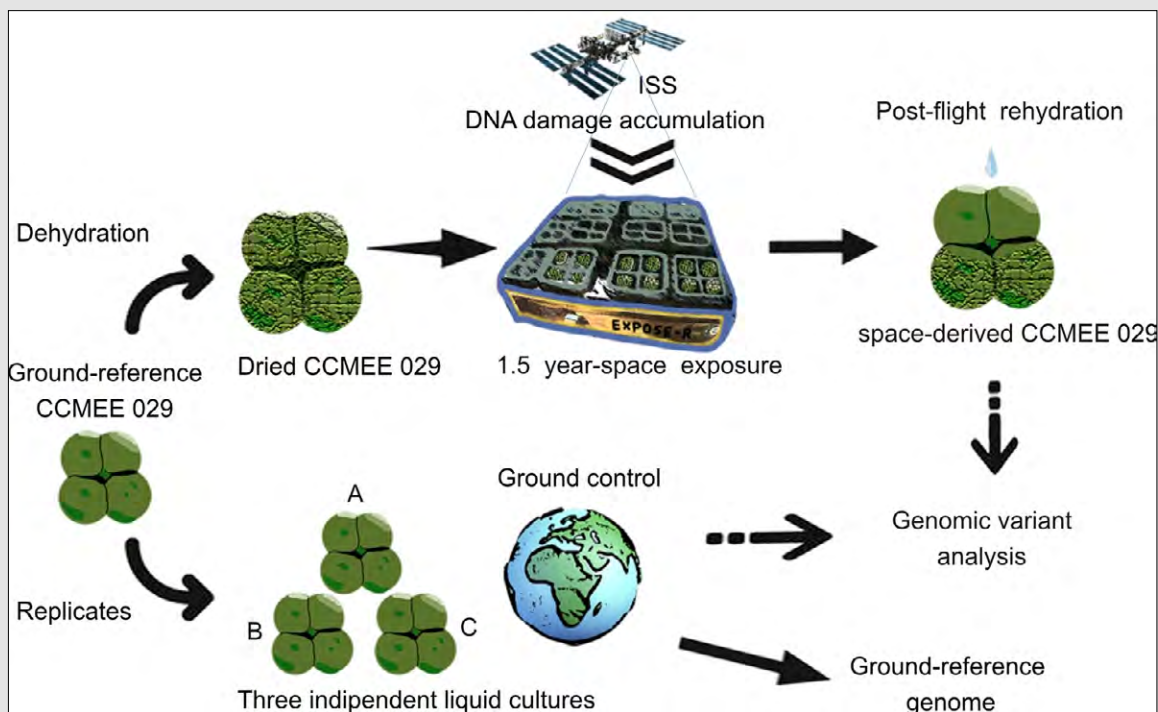

Figure 25. Experiment design of EXPOSE-R2 BIOMEX. Image adopted from Napoli, *Scientific Reports*.

the land would enable humans to create self-sustaining habitats on the Moon or on Mars.

Previous studies have demonstrated the survivability of bacterial spores in deep space and during long-term space exposure. Desiccated bacteria have also been found to retain their function upon reactivation after spaceflight. In this new study published in *Scientific Reports*, the desert cyanobacterium *Chroococcidiopsis*, known to be highly resistant to harsh environments and adequate for genetic manipulation, was flown to the EXPOSE facility of the ISS where dried cells were mixed with Martian regolith as nutrient source and exposed for 1.5 years to simulated Mars-like conditions (i.e., cosmic radiation, cold temperatures, and atmospheric pressure).

A strain of the *Chroococcidiopsis* genus derived in space was rehydrated and examined for its

genomic alterations and DNA robustness once back on Earth. Genomic sequencing showed no increased variants in the space strain compared to ground strains, demonstrating that the space-derivate strain did not involve any known proteins of DNA repair pathways. This finding suggested to the researchers that the space-derivate strain retained the ability to repair accumulated DNA lesions caused by radiation. These findings advance the possible use of cyanobacteria for artificial bioregenerative life support systems that provide oxygen and food as well as biotechnological applications in fuel, fertilizers, marine farming, and pharmaceutical production.

Napoli A, Micheletti D, Pindo M, Larger S, Cestaro A, et al. Absence of increased genomic variants in the cyanobacterium *Chroococcidiopsis* exposed to Mars-like conditions outside the space station. *Scientific Reports*. 2022 May 19; 12(1): 8437. DOI: [10.1038/s41598-022-12631-5](https://doi.org/10.1038/s41598-022-12631-5).

Publication Highlights

Earth and Space Science



The JAXA investigation [Monitor of All-sky X-ray Image \(MAXI\)](#), which contains high-precision X-ray detectors, is used to explore the cosmos by continuously tracking the appearance of random and

short-lived X-ray phenomena. Upon early detection of an event, MAXI notifies other observatories and satellites for follow-up observations. Operations began in 2009.



Figure 26. MAXI installed aboard the ISS. NASA ID: s127e009561.

Compact objects such as Neutron Stars and black holes undergo cycles of luminosity states that include outbursts and periods of quiescence. In a new study published in *The Astrophysical Journal*, MAXI and NuSTAR detected a new faint X-ray in the cluster GLIMPSE-C01 and named the source MAXI J1848015. Based on spectral and timing analyses, the light curve showed an increase and then a decrease in energy, indicating the presence of an accretion disk that extends close to the accretor.

The X-ray spectra changes between a low luminosity (dim) hard state and a high luminosity (bright) soft state. During the dim hard state, X-ray energy emissions originate from the hot plasma in the corona around the star. During the bright soft state, emissions originate from the inner regions of the accretion disk.

Reflection of thermal emissions in the bright soft state was observed and moderate disk truncation was observed in the hard state.

The high spin of this source indicated that the observation is a black hole rather than a neutron star. However, the low luminosity of the source is currently unexplained and may be due to many factors, including observational angles or emission scattering from the outer disk.

This work demonstrates how combining MAXI all-sky monitoring with NuSTAR's imaging and spectral capabilities can help to identify compact objects and distinguish between neutron stars and black holes.

Pike SN, Negoro H, Tomsick JA, Bachetti M, Brumback M, et al. MAXI and NuSTAR observations of the faint X-ray transient MAXI J1848-015 in the GLIMPSE-C01 cluster. The Astrophysical Journal. 2022 March 10; 927(2): 190. DOI: [10.3847/1538-4357/ac5258](https://doi.org/10.3847/1538-4357/ac5258).



The JAXA investigation [CALorimetric Electron Telescope \(CALET\)](#) is a charge detector able to distinguish between different chemical elements with high resolution.

Publication Highlights

Earth and Space Science

It includes an imaging and a total absorption calorimeter as well as two hodoscopes for observing the paths of high-energy cosmic ray nuclei. The hardware was launched to the ISS in 2015 and is installed on the Japanese Experiment Module Exposure Facility. Analysis of CALET data provides new insight into the source of cosmic rays, the nature of astrophysical energetic particle acceleration mechanisms, and characteristics of the interstellar space in our galaxy.

In a new study published in *Physical Review Letters*, researchers measured the energy spectrum of nickel from November 2015 to May 2021. Nickel is of interest to researchers because it is a highly abundant transition metal in the cosmos and few direct measurements have been reported. The current measurement of nickel follows a previous examination of iron in cosmic rays, expanding the researchers' investigation to obtain data values of several heavy metals. This data will eventually enable the

mapping of many different heavy nuclei propagating through space.

The analyses provided a measurement of the energy spectrum of nickel, along with statistical standards to learn about the level of error and certainty in the measurements. A flat nickel-to-iron ratio indicated that the energy spectral shapes of nickel and iron are the same and suggested a similar source and propagation of the nuclei.

Observing the abundance and stability of nickel energy spectra and cosmic rays is key to understanding theoretical accelerations and propagation mechanisms of charged particles in our galaxy.

Adriani O, Akaike Y, Asano K, Asaoka Y, Berti E, et al. Direct measurement of the nickel spectrum in cosmic rays in the energy range from 8.8 GeV/n to 240 GeV/n with CALET on the International Space Station. Physical Review Letters. 2022 April 1; 128(13): 131103. DOI: [10.1103/PhysRevLett.128.131103](https://doi.org/10.1103/PhysRevLett.128.131103).

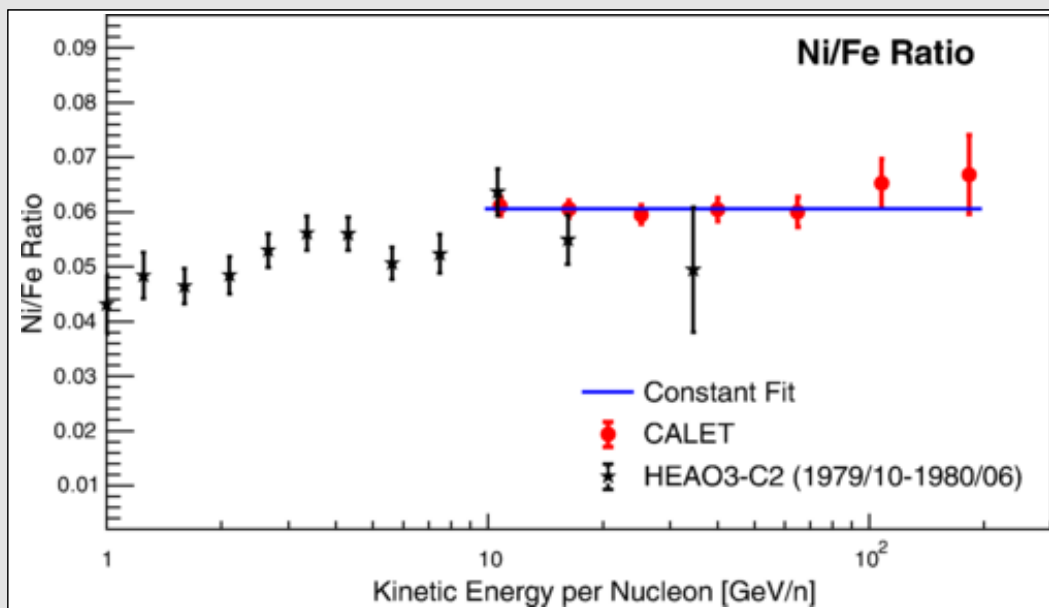

Figure 27. Nickel-to-iron ratio with statistical error bars. Constant fit demonstrates that the energy spectral shapes of the two nuclei are the same. Image adopted from Adriani, *Physical Review Letters*.

Resources

To Learn More...

National Aeronautics and Space Administration

<https://www.nasa.gov/stationresultsresourceibrary/>

<https://www.nasa.gov/stationexperiments/>

Canadian Space Agency

<https://www.asc-csa.gc.ca/eng/iss/>

European Space Agency

https://www.esa.int/Science_Exploration/Human_and_Robotic_Exploration/International_Space_Station

Japan Aerospace Exploration Agency

<https://humans-in-space.jaxa.jp/en/>

State Space Corporation ROSCOSMOS

<http://en.ROSCOSMOS.ru/202/>

Italian Space Agency

<https://www.asi.it/en/life-in-space/international-space-station/>





A PRODUCT OF THE PROGRAM SCIENCE FORUM