

# **Dynamic Onboard Ubiquitous Graphics**

**(DOUG)**

**Version 1.72**

**September 2018**

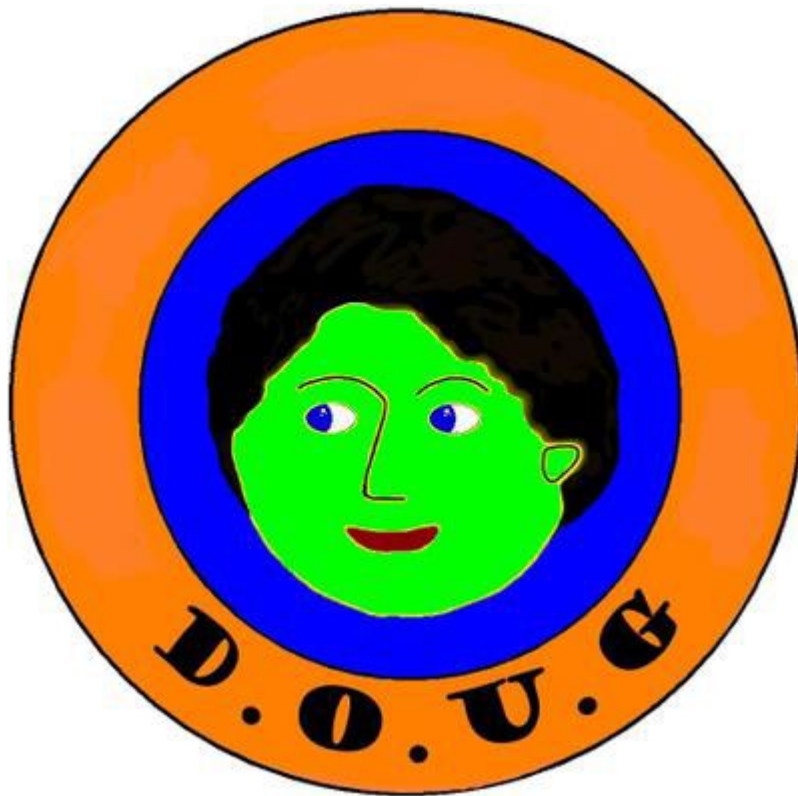

**User Guide**

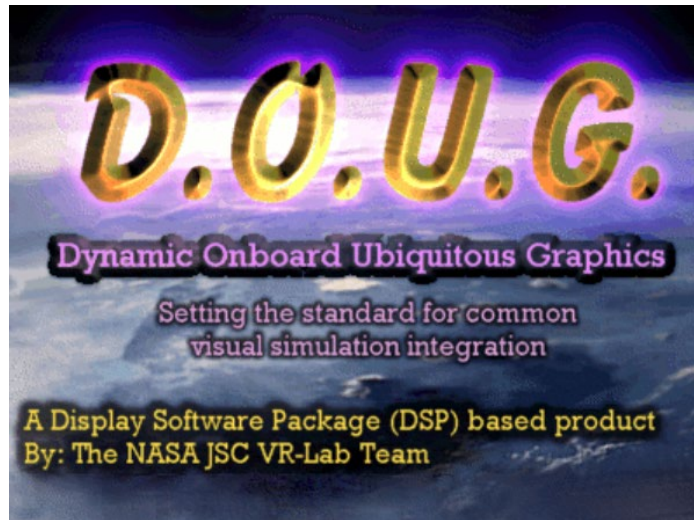

## Overview

DOUG is a 3D viewing tool or graphic engine designed by the Virtual Reality Training Laboratory at Johnson Space Center. DOUG produces mission specific scene configuration database(s) that are utilized in major simulations throughout NASA centers. These simulations include but are not limited to: Simplified Aid for EVA Rescue (SAFER), Space Station Remote Manipulator System (SSRMS), ground and on-board, Systems Engineering Simulation (SES), Dynamic Skills Trainer (DST), Space Station Training Facility (SSTF), and activities at the Virtual Reality Laboratory (VR Lab). The graphics engine is also used for exploration applications through the Engineering DOUG Graphics for Exploration (EDGE) tool.

The DOUG application is commonly used for Extra Vehicular Activities (EVA) and Robotics planning, review and situational awareness. It helps prepare crew for tasks required during their mission, as well as during Neuro-Buoyancy Laboratory (NBL) training. DOUG is also used to generate EVA procedure animations that includes both EVA crew procedures and SSRMS positions for crew review and training onboard International Space Station (ISS). The use of this software on the ground and onboard assures a commonality of scene configurations and user interfaces throughout all systems. DOUG's visual loads provides 3D graphics and animation capabilities of the ISS and the visiting vehicles in their current configuration. Other loads include NBL and DSG configurations to support other facilities and future missions.

The application is suited to run under Microsoft Windows, MAC and Linux operating systems. DOUG is continuously improving and evolving, this document aims to address the most commonly used features. For questions of specific functionality, technical support, or feature suggestions contact the VR Lab Team at [jsc-DOUG@mail.nasa.gov](mailto:jsc-DOUG@mail.nasa.gov).

# Table of Contents

Downloading and Installing DOUG Software.....	1
Procuring Software .....	1
Installation .....	1
Windows OS.....	1
MAC OS .....	1
Obtaining and Installing DOUG Visual Load Package .....	1
Windows OS.....	1
MAC OS .....	2
Opening DOUG Visual Load .....	2
Obtaining and Installing DOUG Plugin .....	3
Windows OS.....	3
Main Menu and User Interface Overview .....	3
Main Menu Overview .....	4
File Menu .....	4
Display Menu .....	4
Edit Menu.....	7
JntSystems Menu .....	8
Transporters Menu .....	9
Reconfig Menu .....	9
Toggles Menu.....	10
Options Menu .....	10
Help Menu .....	11
Pop Up Menu .....	12
Rulers Option .....	12
Overlays Option .....	14
Lighting Effects Option.....	15
Cross Hair Option .....	16
Camera Info Option.....	16

Save JPEG Option .....	16
Pick Model to Edit Option .....	16
Pick Model to Toggle Detail Option .....	17
Scene Detail Option .....	18
Assign Camera Option.....	18
Assign Window View Option.....	19
Edit Camera Option.....	19
Exit Option .....	19
Options Menu Tool Dialogs.....	20
HANDRAILS Dialog.....	20
Keep Out Zone Dialog .....	20
WIFs Dialog .....	22
ORUs & Stowage Dialog .....	23
EVA-A-TRON Dialog.....	24
Solar Tracking Dialog.....	25
Camera Targets Dialog .....	25
SSRMS Targets Dialog .....	27
JEMSFA Targets Dialog.....	28
JEMRMS Targets Dialog .....	29
SPDM Targets Dialog.....	30
SSRMS Proximity Dialog.....	31
JEM Proximity Dialog .....	32
Translation Paths Dialog .....	33
Ext HD Cam Dialog .....	34
BRT Handrails Dialog.....	35
MUTEE-A-Tron Dialog .....	36
Camera Groups Dialog .....	37
ORU-A-Tron Dialog.....	38
Other Menu Dialogs.....	39
Edit Node Dialog .....	39
Edit Model Dialog.....	40

Edit System Dialog .....	42
Extra Features and Plugins.....	43
EVA Reconfig Load Review.....	43
Virtual Reality (VR) Plugin and Controls .....	45
Gamepad Plugin and Controls .....	48
Telemetry Feature .....	49
NBL Visual Load.....	50
SAFER Run Review Tool .....	51
Specific Task Examples.....	55
Placing Scoops on ORUs.....	55
Reconfiguring MT and CETA Carts .....	59
Rotating SARJ and TRRJ.....	61
Change SSRMS Location.....	61
Acronyms .....	63

# Downloading and Installing DOUG Software

## Procuring Software

- Contact the VR Lab at [jsc-doug@mail.nasa.gov](mailto:jsc-doug@mail.nasa.gov) to procure software.

**Note: User must have Administrator privileges to install software**

## Installation

### Windows OS

- Run *setup.exe*
- If security warning boxes appear select **Run anyway** and **Yes**
- *Download – Security Warning* Dialog box will appear
- Click **Run**
- If a second security warning box appears click **Run** again
- If you are given a window that asks for authorization for an unknown publisher to make changes on your computer click **Yes**
- **Follow installation instructions**
- Once installation is complete, DOUG Icon should appear in Desktop. Double click the icon to launch DOUG.

### MAC OS

- Download *macDOUG.tar*
- Open Terminal
- Cd to directory containing *macDOUG.tar* file (i.e. “cd ~/Documents/”)
- Input “tar –xvf macDOUG.tar” in command line to extract contents
- Cd to “DOUG” folder extracted from *macDOUG.tar*
- Input “./run\_DOUG” to launch DOUG

## Obtaining and Installing DOUG Visual Load Package

- Make sure DOUG is closed
- Navigate to DOUG website <http://VRLab.jsc.nasa.gov/>
- Click *Flights*

### Windows OS

- Click and download desired flight (i.e. Stage\_56-6\_v7.exe)
- *Download – Security Warning* Dialog box will appear
- Click **Run**
- If a second security warning box appears click **Run** again
- If you are given a window that asks for authorization for an unknown publisher to make changes on your computer click **Yes**
- *Setup* Dialog box will appear
- Click **Next**

- Once installation complete, the box will disappear. To verify load has been installed open DOUG and the new load will be listed in the “*Select Visual Load Dialog Box*”.

## MAC OS

- Click and download desired flight (i.e. Stage\_56-6\_v7.txt)
- Save file under DOUG/flights directory
- Change file’s extension from “.txt” to “.pkg”

During DOUG’s start up, the installed flight package(s) list will appear with the visual load(s) available in the “*Select Visual Load Dialog Box*”. Make sure you have the most current version loads installed before running DOUG.

**Note:** *The VR Lab updates DOUG’s current mission configuration(s) or load(s) frequently. If something is significantly wrong in the configuration of the latest release please let the VR Lab know.*

## Opening DOUG Visual Load

- Launch DOUG from desktop icon or command line
- *Select Visual Load* box will appear
- Select desired load and press **OK**

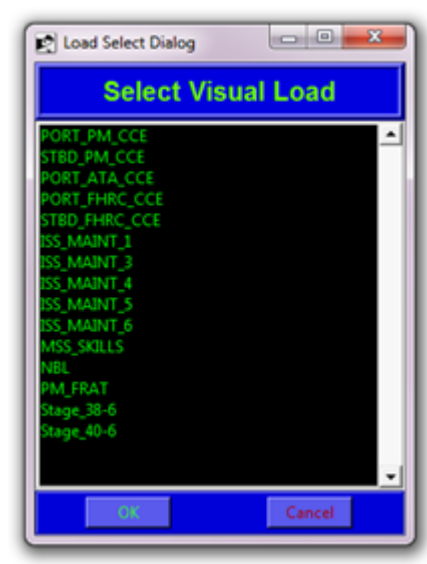

## Obtaining and Installing DOUG Plugin

- Make sure DOUG is closed
- Navigate to DOUG website <http://VRLab.jsc.nasa.gov/>
- Click *PLUGINS*

### Windows OS

- Click and download desired plugin (i.e. SaferReview.exe)
- *Download – Security Warning* Dialog box will appear
- Click **Run**
- If a second security warning box appears click **Run** again
- If you are given a window that asks for authorization for an unknown publisher to make changes on your computer click **Yes**
- *Setup* Dialog box will appear
- Click **Next**
- Once installation complete, the box will disappear. To check installation, run DOUG and check downloaded feature menu. (i.e. Review Safer Option)

## Main Menu and User Interface Overview

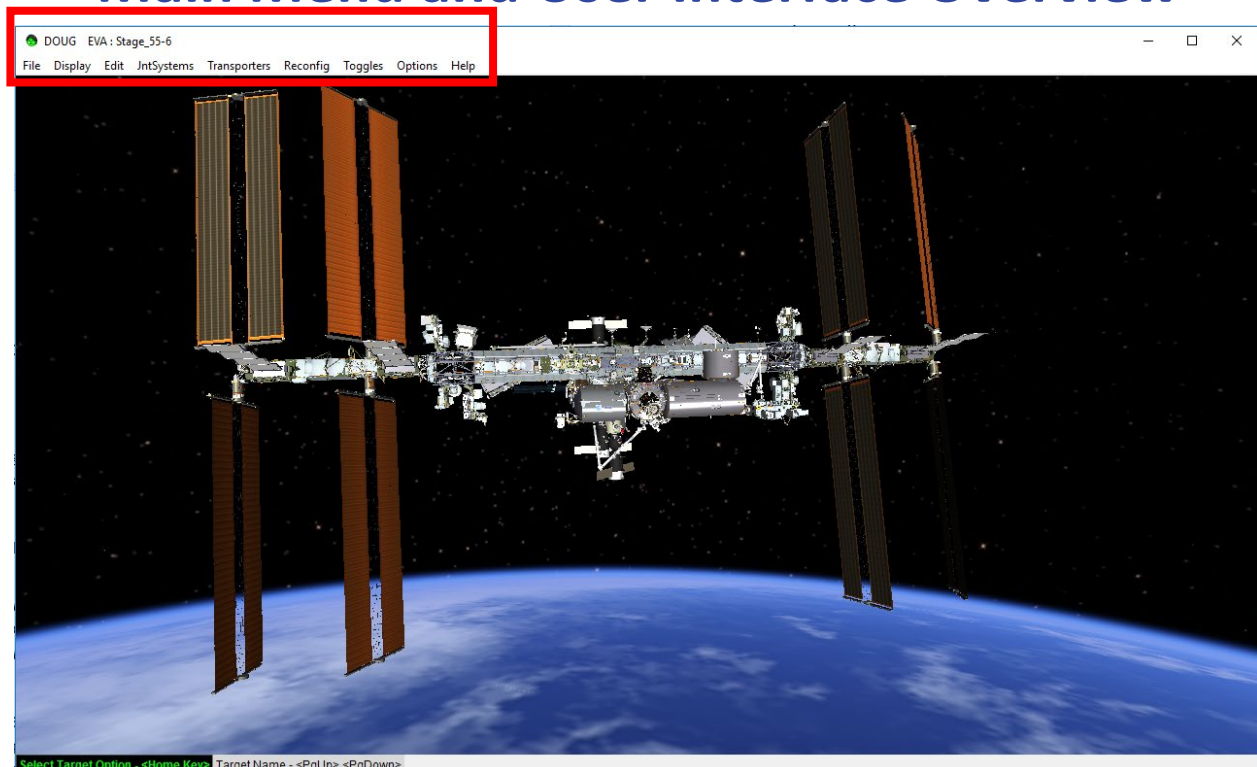



## Main Menu Overview

### File Menu

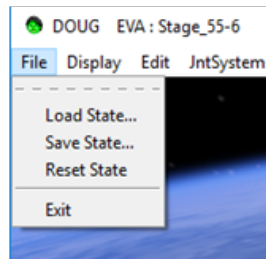

- **Load, save, and reset state**
  - Loading allows user to start working on a pre-configured scenario since configuring a scenario takes time (moving APFRs, configuring joints, etc.)
  - Saving a state allows user to save a desired scene configuration.
  - Resetting state will return to the 'default state' and all work done after the last save will be lost.
- **Exit**
  - Opens quit dialog to terminate program

### Display Menu



- **VR HEADSET**
  - If the VR hardware is ready and the VR DOUG plugin package is installed, selecting VR Headset will turn on the DOUG visuals on the connected VR Head Mounted Display (HMD). DOUG supports multiple HMDs and controllers including VIVE, Oculus, and all of the Windows Mixed Reality

HMDs. For instructions in how to utilize the VR hand controllers to navigate in DOUG, reference the VR Plugin and Controls section.

- **Background**

- Opens a Color Dialog that allows changes to the background color of DOUG's Main Window



- **Ideal Lighting**

- Toggles between a fake ideal lighting (a light source that is coming from the direction of the camera) and the present default lighting (a light source from a specific location). When the ideal lighting is on, every component in the scene is lit and the settings cannot be edited.

- **One, Two, or three views**

- One view displays DOUG Main Window showing 'JimboCam' as the default camera. Activate the camera by moving the mouse pointer over the window. Using the right mouse button on the window will display a popup menu described in the Popup Menu section. Using the Hot Keys (see Key Cue Card in the help menu) over the window will select and change view to other cameras.
- Two views divides DOUG Main Window into two sections. The left sections shows 'CAMERA D' as the default and the right section shows 'CAMERA A' as the default. Activate the camera by moving the mouse pointer over the desired window section. Using the right mouse button on a section will display the popup menu described in the Popup Menu section. Using the Hot Keys (see Key Cue Card in the help menu) over the window will select and change view to other cameras.

- Three views divides DOUG Main Window into three sections. The upper left section shows 'CAMERA D' as the default, the upper right section shows 'CAMERA A' as the default and the lower section shows the 'JimboCam' as the default. Activate the camera by moving the mouse pointer over the desired section. Using the right mouse button on a section will display a popup menu described in the Popup Menu section. Using the Hot Keys (see Key Cue Card in the help menu) over the window will select and change view to other cameras.

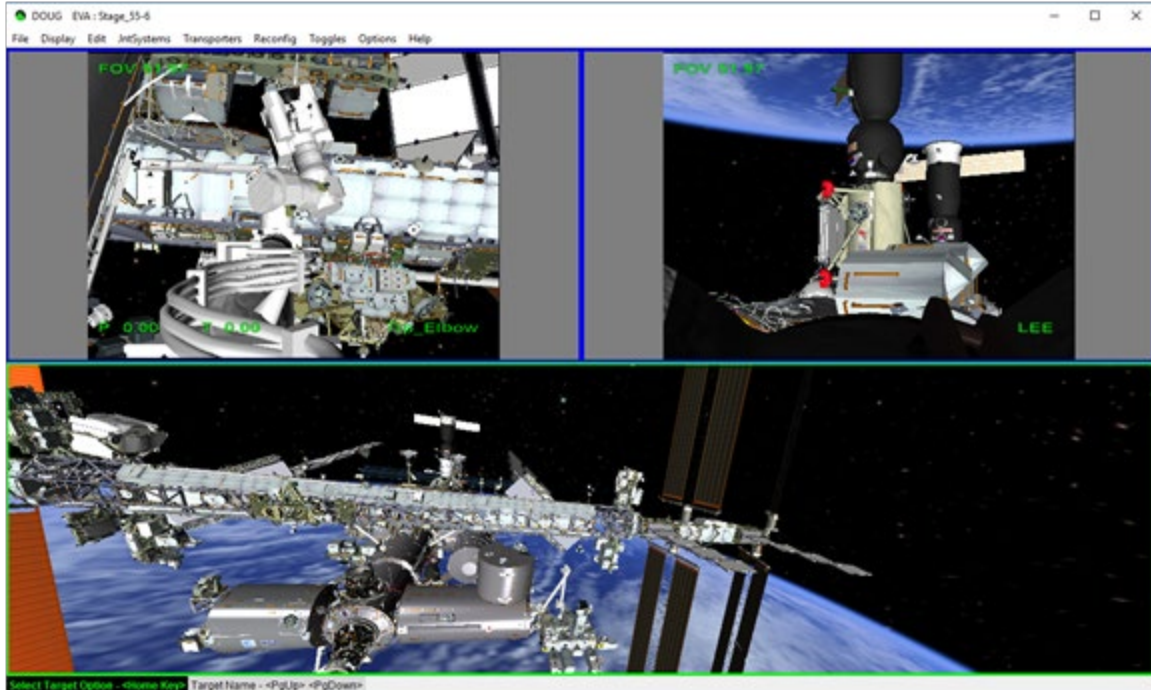

- Show SSRMS, JEMRMS, JEMSFA and SPDM targets

- Show SSRMS targets displays a shaded 'ghost' SSRMS target model. When used in conjunction with PCSDAS, DOUG will receive SSRMS joint angle information. This information is also displayed at the bottom of DOUG's main window.

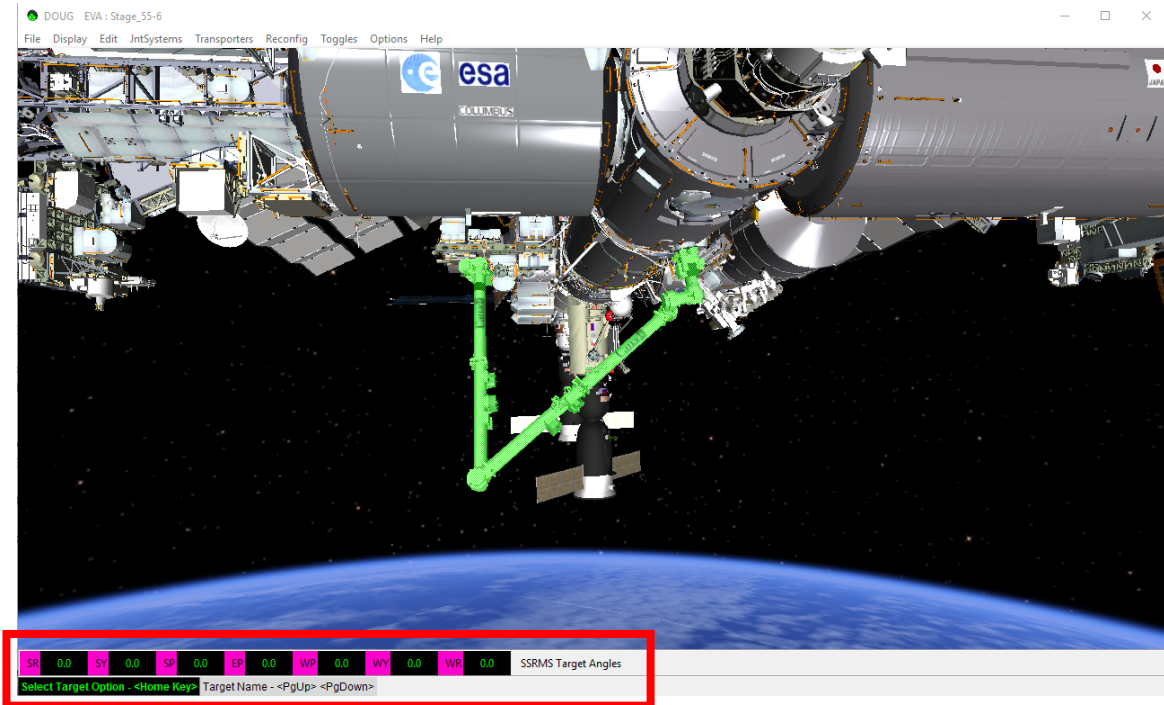

## Edit Menu

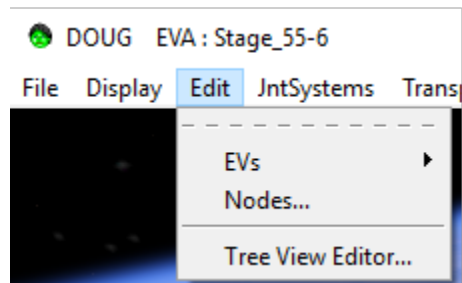

- **EVs**
  - Opens the *Edit System Dialog* which is used to manipulate the selected EVA body. See also the *Options Menu Tool Dialogs* for more details in how to manipulate EVAs.
- **Nodes**

- Opens the *Edit Node dialog* that displays all the components or nodes available in the scene. Double clicking on any of the items in the list will open the *Edit Dialog* to manipulate that specific component. More details on this dialog and the *Edit Dialog* are in the *Other Menu Dialogs* section.

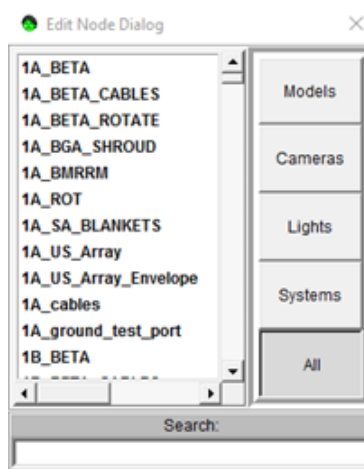

- **Tree View Editor**
  - Opens the *Tree View Editor Dialog* that displays all the nodes available in the scene in a tree view. Double clicking on any of the items in the list will open the Edit Dialog to manipulate that component. More details are in the *Other Menu Dialogs* section.

**Note:** The Edit Dialog and the Tree View Editor are color coordinated to Node types. **System Nodes** are **PURPLE**, **Model Nodes** are **BLUE**, **Camera Nodes** are **RED** and **Light Nodes** are **YELLOW**.

## JntSystems Menu

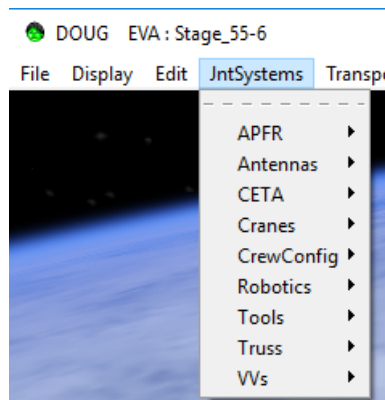

- Each Option in this menu is used to open a specific dialog box that manipulates selected joints items and positions such as:

- To manipulate the configuration of various joints (e.g. APFR, CETA cart swing arms, solar arrays, SGANT, and WIF extenders, Toolboxes, Cranes, etc.)
- Define new joint angles on robotic arms
- EV1 and EV2 body joint angles
- Reconfigure visiting vehicle attributes

## Transporters Menu

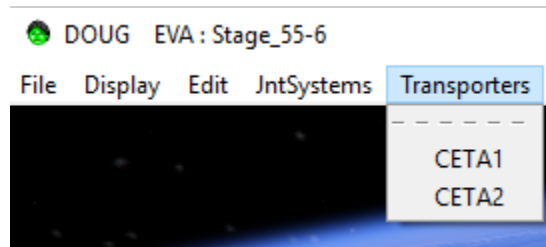

- Menu allows user to change the location of CETA carts along truss rails

## Reconfig Menu

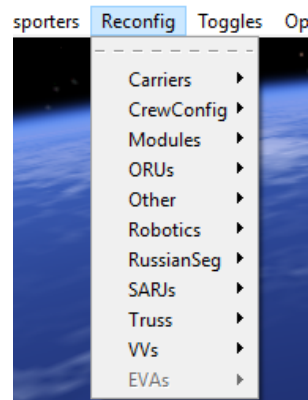

- This menu allows flight specific and generic configurations to allow simple changes in hardware arrangement, including:
  - Relocate external stowage carriers
  - Assign EV1 and EV2 foot restraint locations
  - MT and CETA cart positioning
  - Relocate and reconfigure modules
  - Stow and deploy radiators, PAS, etc.
- EVA specific “reconfiguration” animation procedure is available under EVAs tab after specific package installation.

## Toggles Menu

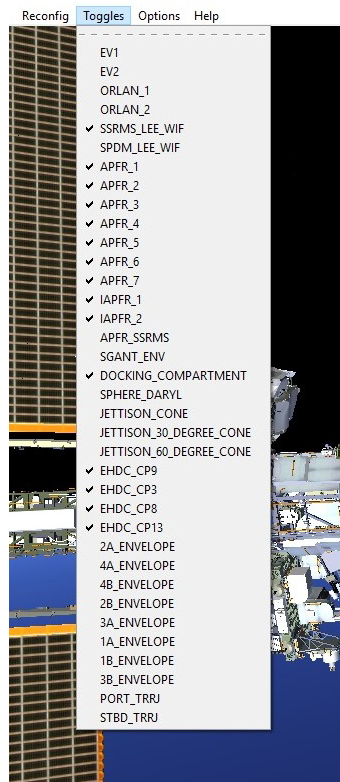

- Quick menu to turn a list of components and envelopes on and off, including: EVs, APFRs, ENVELOPEs, TRRJ, etc.

## Options Menu

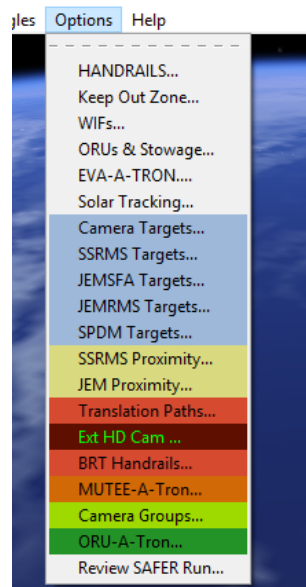

- Selecting any one item opens up a specific option menu. More detail on specific tool dialogs available in the *Options Menu Tool Dialogs* section. These option menus are available to make reconfigurations easier and some add more functionality to DOUG to complete specific tasks such as:
  - *Handles Dialog* used to FLASH specific handrails. These items are configured by the VR Lab and are flight specific.
  - *Keep Out Zone Dialog* is used to turn ON/OFF specific keep out zone areas. KOZ areas are around most of the antennas on Station in which the EMF generated by the antenna when operating could possibly endanger the EVA personnel. These items are configured by the VR Lab and are flight specific.
  - *Wifs Dialog* is used to FLASH and link a predefined joint system to a specific WIF. These items are configured by the VR Lab and are flight specific.
  - ORUs & Stowage opens a *ORUs & Stowage Dialog* with a list of the available ORU and stowage devices. Used to FLASH a specific device. These items are configured by the VR Lab and are flight specific.
  - SSRMS Proximity opens a *SSRMS Proximity Dialog* used to set alarms to monitor the SSRMS when moving close to structure. Distances are user defined in the dialog.
  - SSRMS Targets opens a *SSRMS Targets Dialog* used to show and define SSRMS targets.
  - Translation Paths opens a *Trans Path Dialog* that lists available translation paths by name. These are configured by the VR Lab and are flight specific.
  - *Camera Group Dialog* lists specific Camera Groups (ISS, EVA, ISS, JEM) available in the DOUG scene. You can select a camera and apply it to any view. These are configure by the VR Lab and are flight specific.

## Help Menu

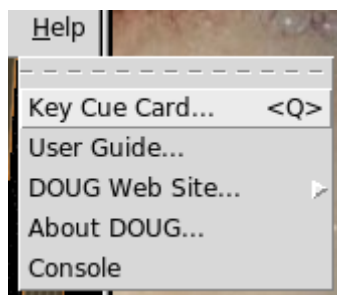

- Includes quick help references such as:
  - *Key Cue Card* lists hot keys to move around in DOUG and change camera views.



**Note:** User cannot translate around station while cursor is on a dialog box. Move cursor outside of box for movement. Hot keys are Caps Lock sensitive.

- User Guide opens link to this **amazing** User Guide document
- DOUG website opens link to DOUG's official site
- About DOUG opens dialog that displays information about DOUG and its version. Also allows user to see the scripts, configuration files and plugins available in the running version of DOUG. This feature is use mostly by developers or advanced users to debug and troubleshoot.
- Console opens up a TCL console. This feature is use mostly by developers or advanced users to debug and troubleshoot.

## Pop Up Menu

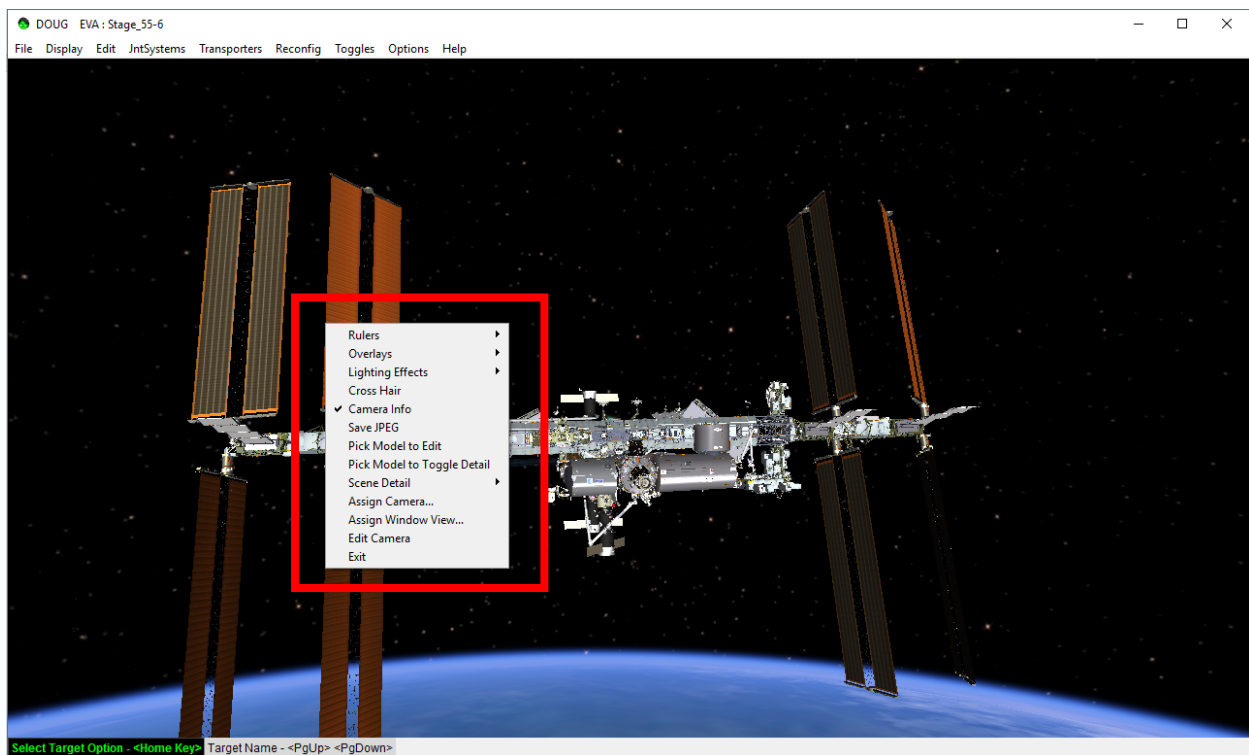

- To enable pop up menu, use the mouse to right click on the main DOUG window

### Rulers Option

**Note:** Use with caution. Ruler feature is to be use for approximation purposes ONLY. Measured estimations are not to be use as validated engineering values.

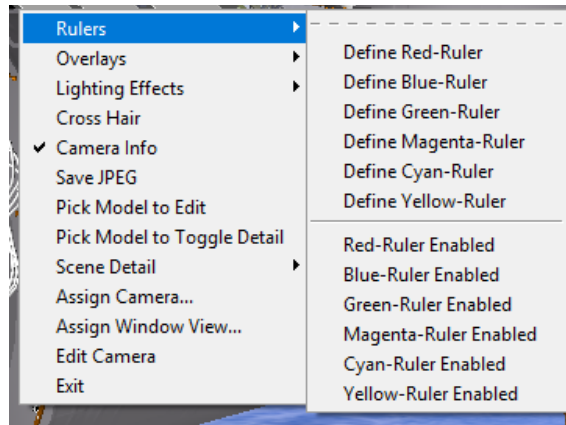

- Click Rulers
- Select desired ruler by clicking *Define color-Ruler*, there are six rulers available to use simultaneously.
- Select the desired ruler color, and then click anywhere on structure to set the initial point.
- Continue clicking along desired path dropping waypoints to generate measurement line segments. Note that the ruler generates line segments therefore it may take several segments to go around structure.
- The sum of the segment distances will appear on the top portion of the DOUG main window in the chosen ruler color.
- To end the measured line click off structure towards space.
- A ruler could be enable or disable by toggling the *color- Ruler Enabled* selection on the ruler option menu.

- **Note:** The ruler and the distance approximation values will update accordingly if the nodes in the scene move.

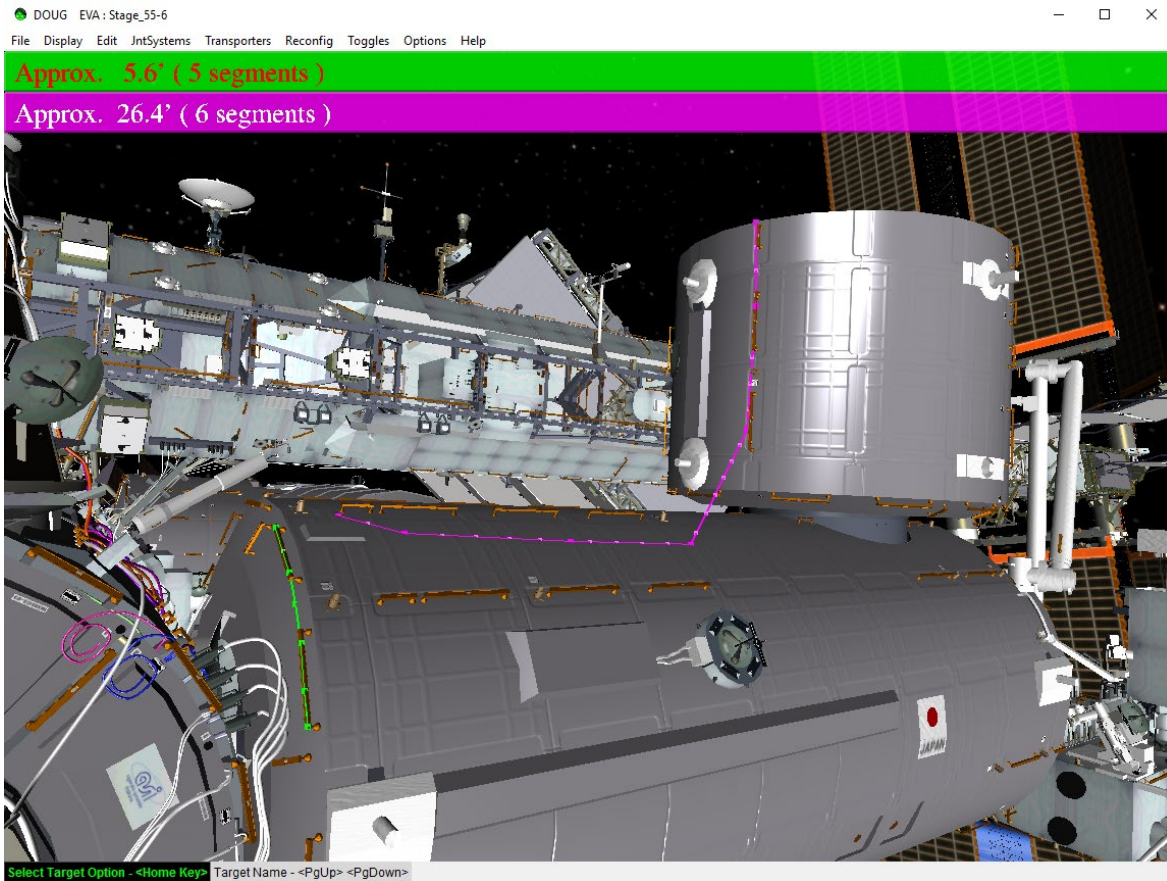

### Overlays Option

- Lists a selection of joint angles display on the lower part of the main screen.

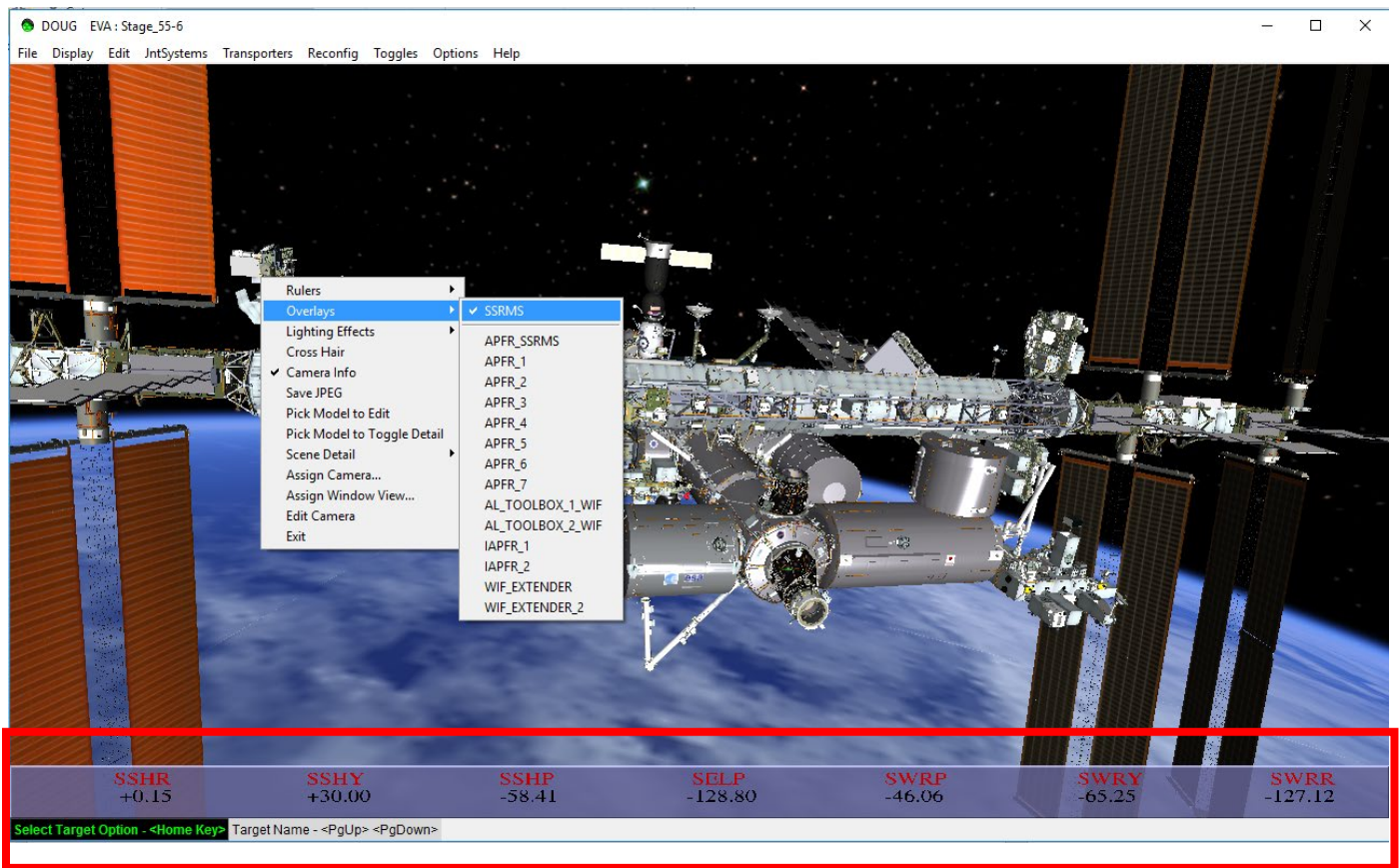

## Lighting Effects Option

***Note:*** To enable Lighting Effects, the Ideal Lighting setting under the Display menu has to be disabled. Changing Lighting Effects will affect DOUG performance significantly.

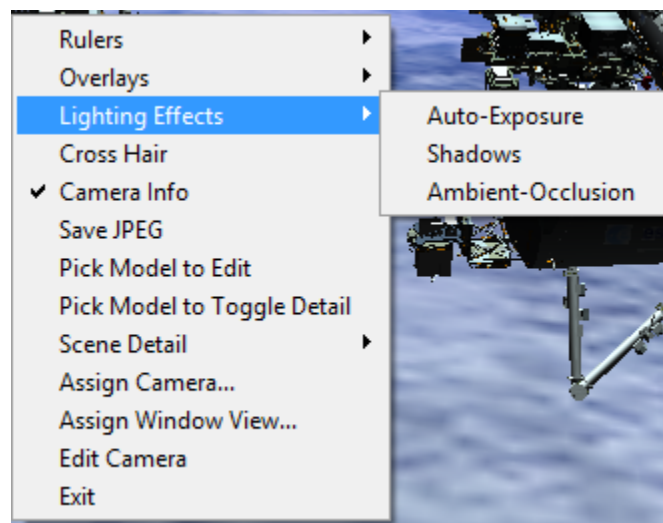

- Auto-Exposure option toggles intensity of the light on the scene making structure appear brighter.
- Shadows option toggles shadows in the scene.
- Ambient-Occlusion option toggles realistic lighting on scene surfaces based on light source.

### Cross Hair Option

- Toggles cross hair overlay in the center of the main window.

### Camera Info Option

- Toggles camera information overlay in the selected section of the window if pre-configured in the camera configuration by the VRLab. Information such as Field of View (FOV), Pan (P), Tilt (T) and camera name can be available.

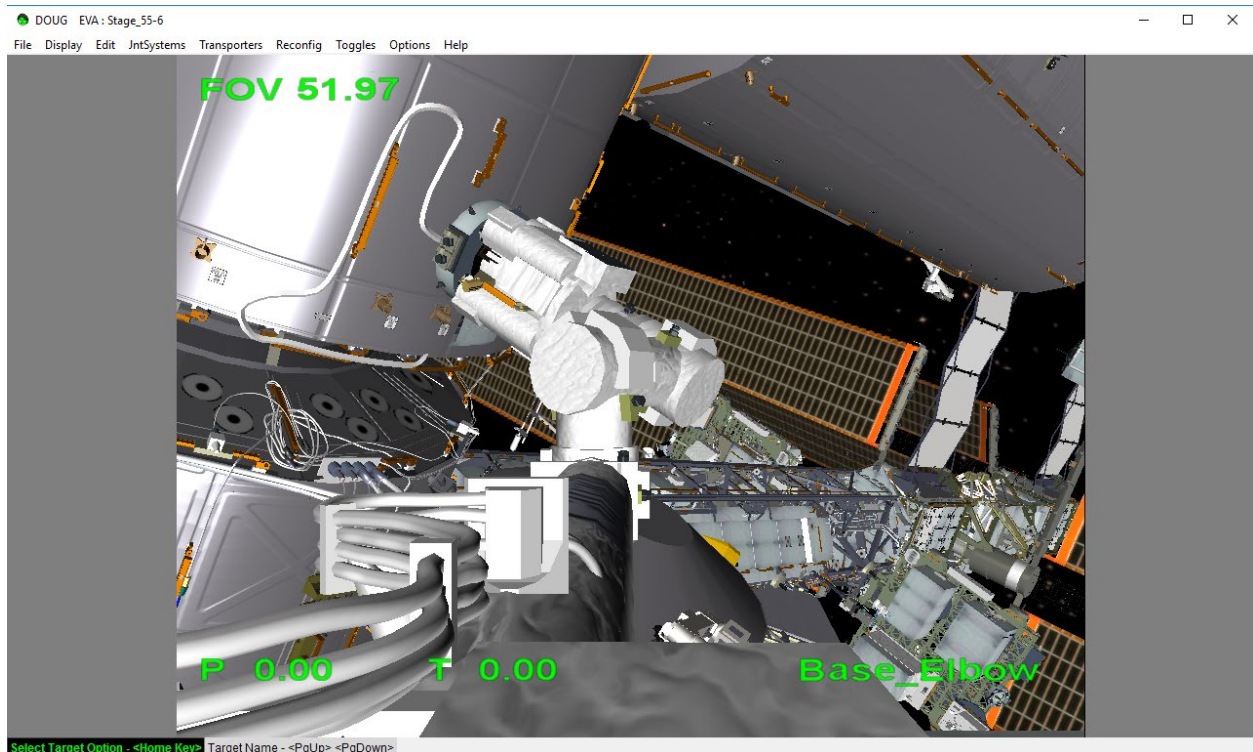

### Save JPEG Option

- Opens a *Save Image Dialog*. Allows user to save a screen capture of the DOUG main window to a JPEG image file format.

### Pick Model to Edit Option

- Enables Pick Model mode. Cursor arrow becomes pointer and hovering over models displays model name at the top of the main DOUG window. This enables user to find models before selecting them to edit.

- To select model click on the desired model and the *Edit Model Dialog* Box will appear for that model node.
- To exit the Pick Model mode, click anywhere on the scene where there are no models (i.e. space).



### Pick Model to Toggle Detail Option

- Enables Pick Model to Toggle Detail mode. Cursor arrow becomes pointer and hovering over models displays model name at the top of the main DOUG window. This enables user to find models before selecting them to toggle detail.
- To select model click on the desired model and the details of the selected model will disappear. A very basic model and texture will be display.
- To toggle model detail back on, select the Pick Model to Toggle Detail option from the Pop Up menu again and click on the simplified model. Detail on the selected model should reappear.

## Scene Detail Option

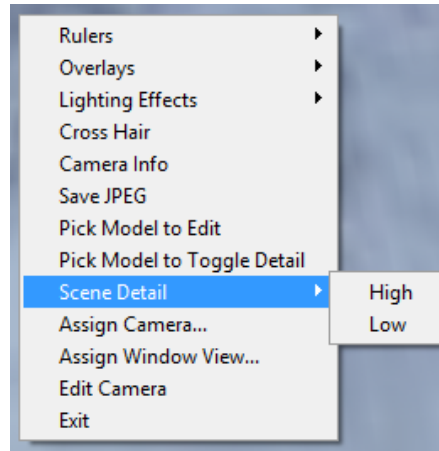

- Allows user to toggle scene detail. Similar to the Pick Model to Toggle Detail option but applied to the entire scene (all the models).
- High option renders the entire scene in high-resolution mode. Provides more detail.
- Low option renders the entire scene in low-resolution mode. Provides less detail.

## Assign Camera Option

- Opens a *Camera Select Dialog* Box with a list of available cameras to select and assign to the specific section of the window. If main window is divide into multiple sections, right clicking on a specific section and selecting the *Assign Camera* option will only assign the selected camera to that specific section.



### Assign Window View Option

- Opens a *Window Select Dialog* Box with a list of available ISS window views to select and assign to the specific section of the DOUG window. If main window is divided into multiple sections, right clicking on a specific section and selecting the *Assign Window View* option will only assign the selected window to that specific section.

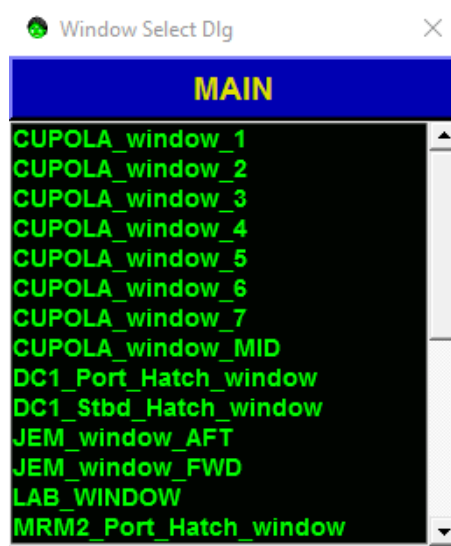

### Edit Camera Option

- Opens a *Camera Dialog* Box use to manipulate the current camera selected from the Assign Camera Option in the *Camera Select Dialog* box.

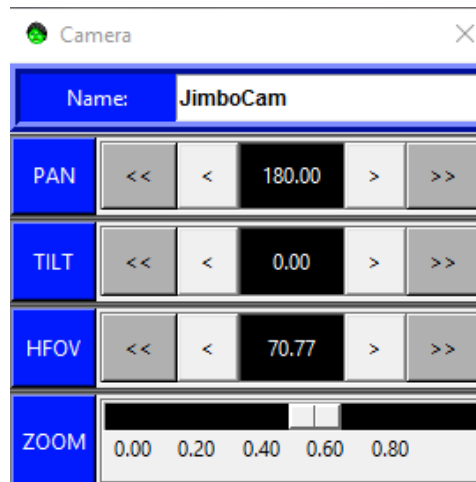

### Exit Option

- Opens a *Quit Dialog* box to exit the DOUG program.



# Options Menu Tool Dialogs

The *Option Menu* in the *Main Menu* has a list of tools to select from. Selecting any one item opens up a specific tool dialog. These tool dialogs are available to make reconfigurations of the DOUG scene and structure easier. Some also add more functionality to DOUG to complete specific tasks.

## HANDRAILS Dialog

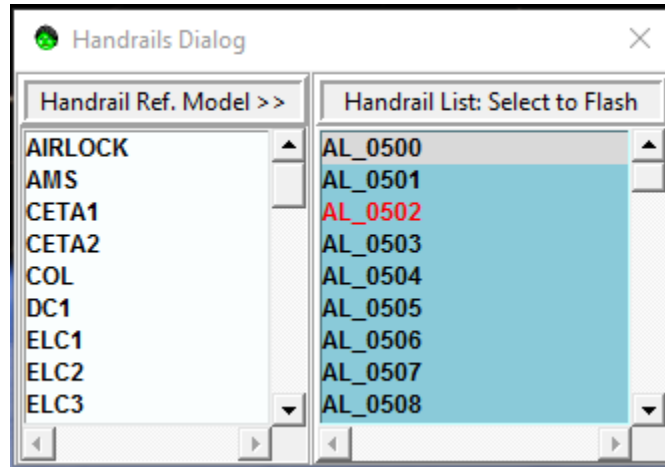

- Allows user to select a reference component with handrails on the left section (i.e. Airlock, AMS, ELCs, etc.) Then it populates a list of available handrails on the right section to select. Clicking any handrail from the list will flash the handrail model and will change the handrail label on the list to red font. Multiple handrails are selectable at the same time. To stop flashing, click once the desired handrail label again.

## Keep Out Zone Dialog

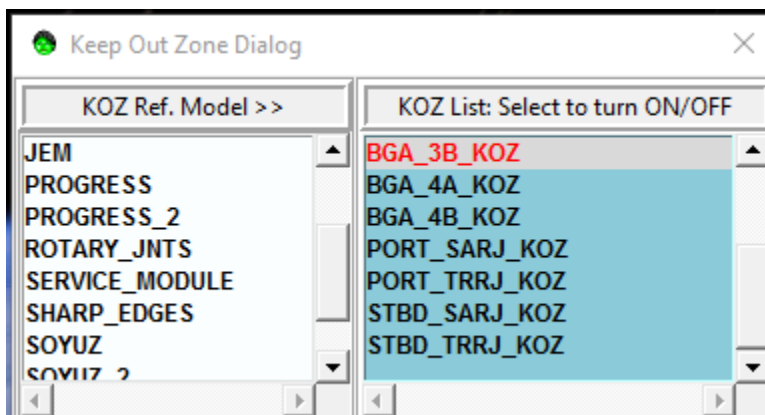

- Allows user to select a reference component with keep out zones on the left section (i.e. JEM, PROGRESS, ROTARY\_JNTS, etc.). Clicking a reference component populates a list of available keep out zones (KOZ) on the right section to select. Clicking any of the KOZ from the list in the right section will display KOZ overlays and will change the KOZ label on the list to red font. Multiple KOZs are selectable at the same time. To disable a KOZ from the view, click once on the desired KOZ label again.

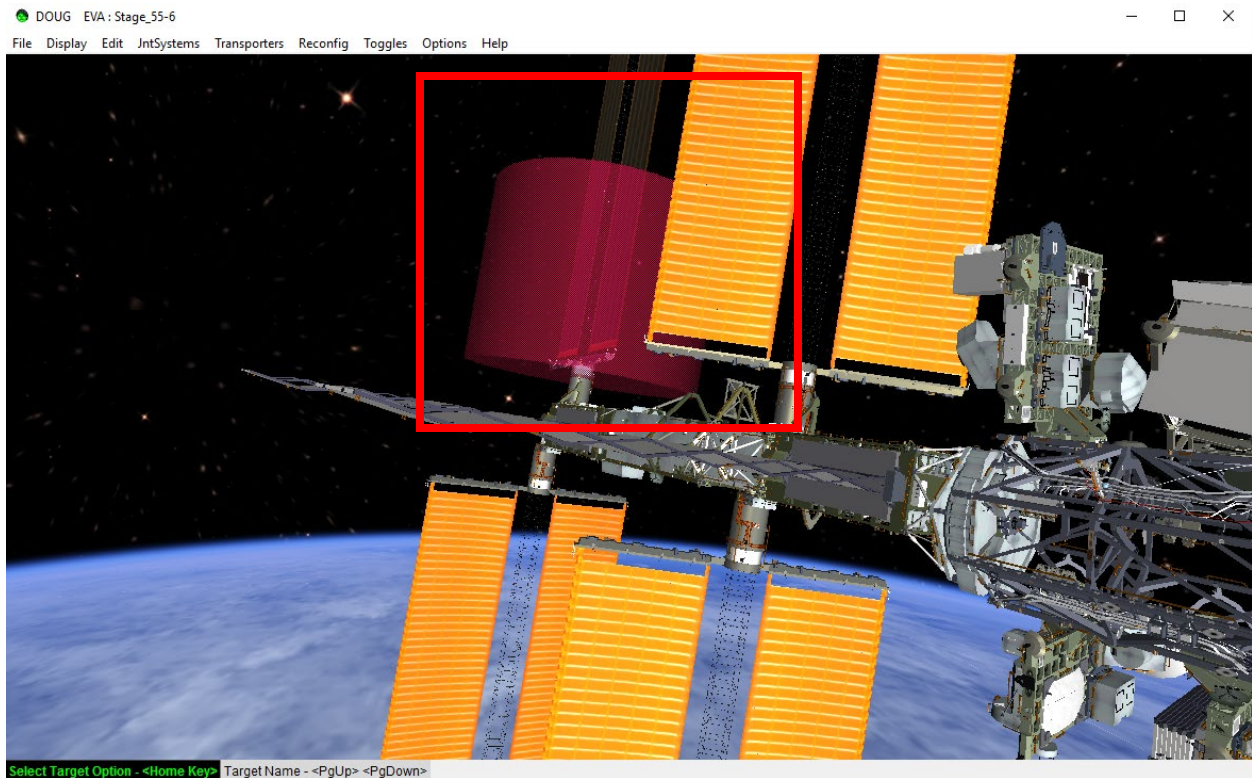

## WIFs Dialog

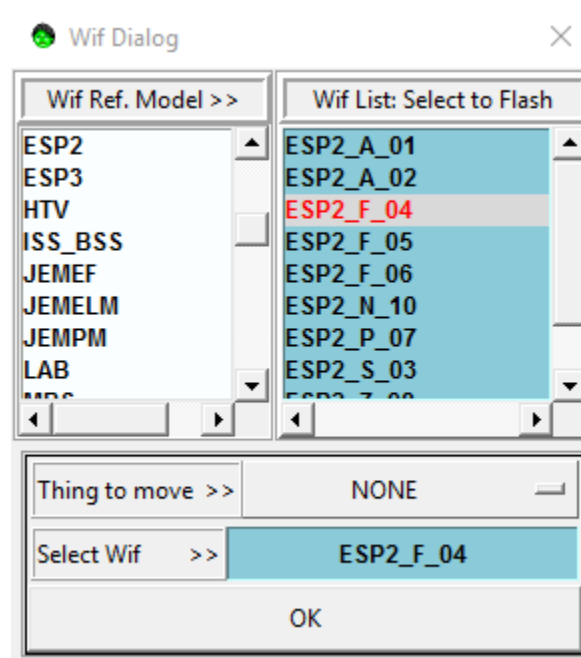

- Allows user to select a reference component with WIFs on the left section (i.e. Airlock, AMS, ELCs, etc.) Then populates a list of available WIFs on the right section to select. Clicking any of the WIF from the list in the right section will flash the WIF model and will change the WIF label on the list to red font. It will also change the “Select Wif >>” box at the bottom of the dialog to the selected WIF label. Multiple WIFs are selectable at the same time to flash but only the WIF clicked last will be shown in the “Select Wif >>” box at the bottom of the dialog. To stop flashing, simple click the desired WIF label again.
- The dialog is use to reposition pre-defined joint systems such as APFRs and WIF Extenders. Selecting a component from the “Thing to move >>” dropdown menu and clicking “OK” will reposition and join the selected component to the selected WIF. There are not any available “undo” feature. Once component is repositioned, the only way to undo link is to link the component manually or using this same dialog to original WIF.

## ORUs & Stowage Dialog

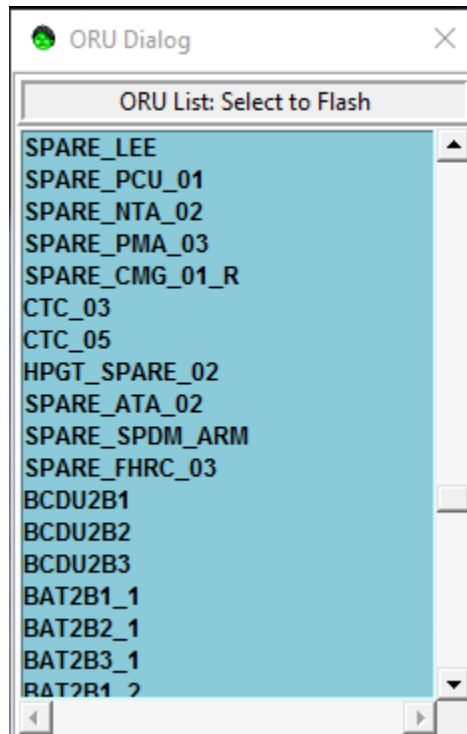

- Allows user to select ORUs or Stowage devices from a list dialog. Clicking any item from the list will flash the component and will change the item label on the list to red font. Multiple components are selectable at the same time to flash. To stop flashing, click the desired component label again.

## EVA-A-TRON Dialog

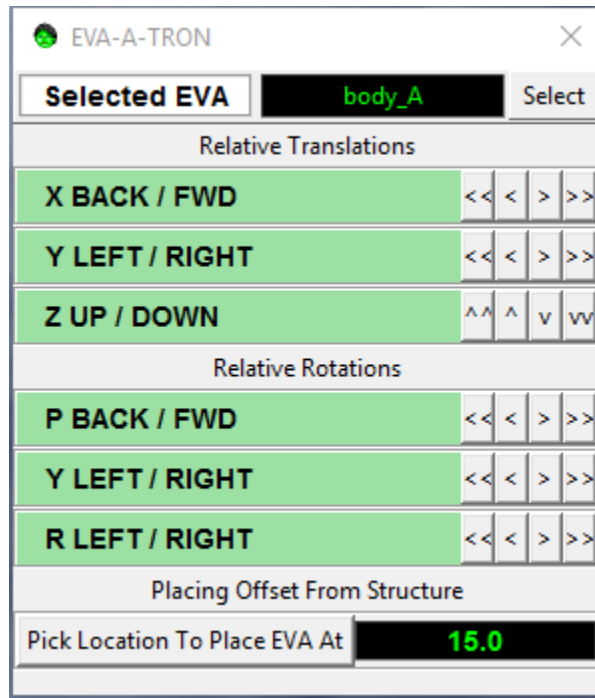

- Allows user to place EV Crewmember model anywhere on structure. Using the “Select” drop down, choose which EVA body to position: body\_A (EV1 model), body\_B (EV2 model), body\_OA (Orlan EV1), body\_OB (Orlan EV2), body\_VRT (used on VRT DOUG load). Once a selection is made, the name of the node should appear next to the “Selected EVA” box.
- To place the selected model, click the “Pick Location to place EVA At” button and then click on a location on structure to place model. An offset value from structure is defaulted to 15 inches but that value can be change on the edit entry.
- Once the model located, it can be move using the arrows from its relative position. Single arrow buttons produce small movements, double arrows buttons produce large movements.
- DOUG uses an estimated 72 inches (6ft) suit model. The EVA crewmember body joint angles articulate using the JntSystems menu EVA Dialog.

**Note: If model is not showing up when clicking the “Pick Location to place EVA At” button and then structure, be sure the selected model node tree is set to visible in the Edit Model Dialog. Details on the Edit Model Dialog is in the Other Menu Dialogs section.**

## Solar Tracking Dialog

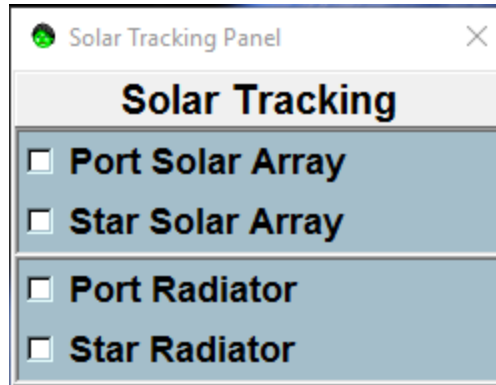

- Allows user to toggle solar arrays and radiators solar tracking ON/OFF. When toggled on, solar arrays and radiators will update and move according to DOUG simulated sun location. When off, arrays and radiators will not move or update and will retain their last location.

## Camera Targets Dialog

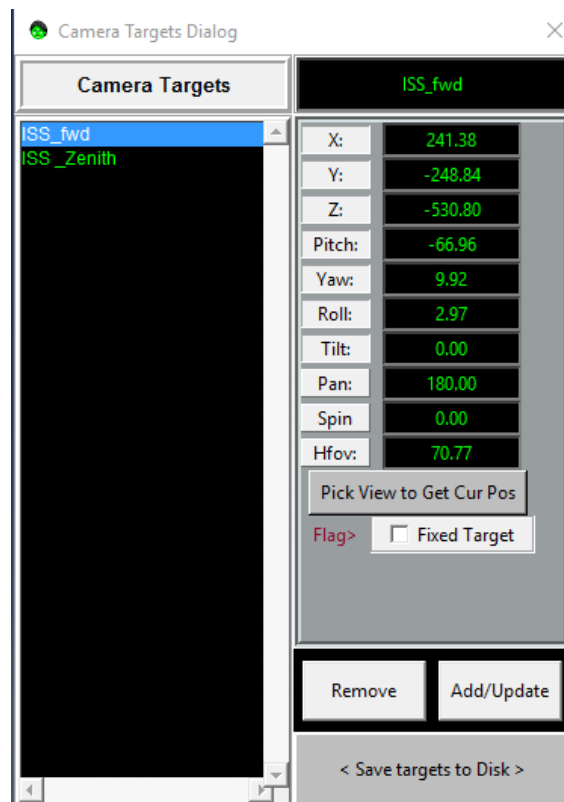

- Allows user add, remove, modify and save camera targets to DOUG run and to a file for later use.
- If Camera target file is available in the <DOUG install directory>/targets folder, DOUG will automatically load available camera targets file.
- To select camera target from list, select camera target name in the list on the left panel of the dialog. The name selected will appear in the top text box on the right panel. User can modify the name using this text box.
- Camera values can be input in their respective text box on the right panel or by selecting “Get Current Pos” button and clicking on the main DOUG window to update all the values to the current camera position.
- If the “Fixed Target” box is checked, targets are not modifiable. To modify targets, unselect box first.
- To Add/Update target, click the Add/Update button. If adding a new Camera to the Targets list, the new list item will appear before the selected item, if updating, the new value will update and saved at the current selected target.
- The remove selected target from list click on the “Remove” Button.
- Camera Target list modified is save for the current DOUG run until the “Save targets to Disk” button is selected. Once this button is click, DOUG automatically saves a camera target file in the <DOUG install directory>/targets folder for later use.

## SSRMS Targets Dialog

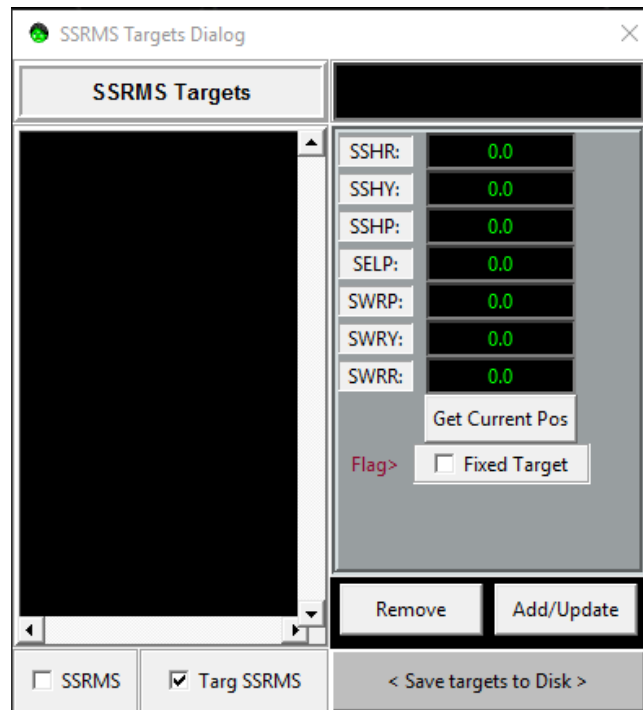

- Allows user add, remove, modify and save SSRMS targets to DOUG run and to a file for later use.
- If SSRMS target file is available in the <DOUG install directory>/targets folder, DOUG will automatically load available SSRMS targets file.
- To select SSRMS target from list, select SSRMS target name in the list on the left panel of the dialog. The name selected will appear in the top text box on the right panel. User can modify the name using this text box.
- Use edit text box to input SSRMS angle values or select the “Get Current Pos” button to update all the values to the current SSRMS position.
- If the “Fixed Target” box is checked, the targets cannot be change. To modify targets, unselect the box first.
- To Add/Update target, click the Add/Update button. If adding to SSRMS Targets list, item will appear on the list before the selected item, if updating, new values will be shown and save to the current selected target.
- The remove selected target from list click on the “Remove” Button.
- SSRMS Target list modified is save in current DOUG run until the “Save targets to Disk” button is applied. Once this button is click, DOUG automatically saves a SSRMS target file in the <DOUG install directory>/targets folder for later use.
- Selecting “Targ SSRMS” in the bottom left section will apply angle values to the target SSRMS.



- Selecting “SSRMS” in the bottom left section will apply angle values to the real SSRMS.

## JEMSFA Targets Dialog

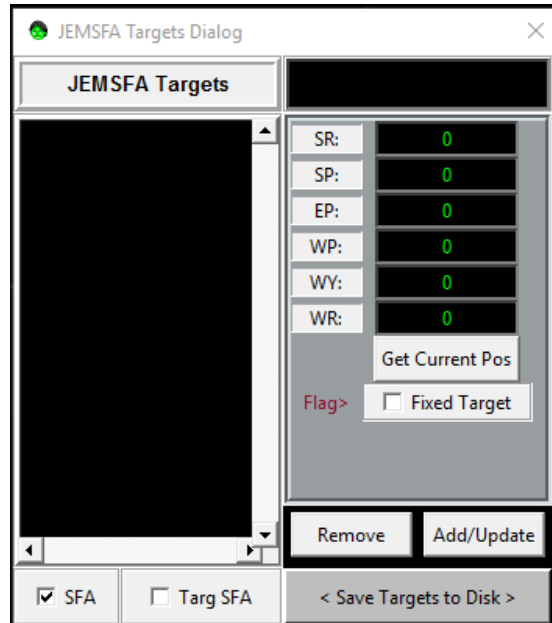

- Allows user add, remove, modify and save JEMSFA targets to DOUG run and to a file for later use.
- If JEMSFA target file is available in the <DOUG install directory>/targets folder, DOUG will automatically load available JEMSFA targets file.
- To select JEMSFA target from list, select JEMSFA target name in the list on the left panel of the dialog. The name selected will appear in the top text box on the right panel. User can modify the name using this text box.
- JEMSFA values modify by inputting values in their respective edit text box on the right panel or by selecting “Get Current Pos” button to update all the values to the current JEMSFA position.
- If the “Fixed Target” box is checked, the targets can’t be change. To modify targets, unselect box first.
- To Add/Update target, click the Add/Update button. If adding to JEMSFA Targets list, new list item will appear before selected item, if updating, new values will update and save to the current selected target.
- The remove selected target from list click on the “Remove” Button.
- JEMSFA Target list modified only applies for current DOUG run until the “Save targets to Disk” button selected. Once this button is click, DOUG automatically saves a JEMSFA target file in the <DOUG install directory>/targets folder for later use.

- Selecting “Targ SFA” in the bottom left section will apply angle values to the target JEMSFA.
- Selecting “SFA” in the bottom left section will apply angle values to the real JEMSFA.

## JEMRMS Targets Dialog

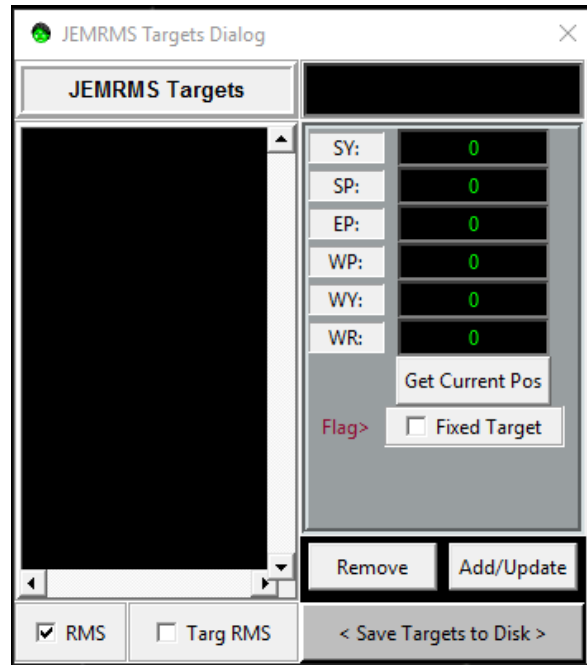

- Allows user add, remove, modify and save JEMRMS targets to DOUG run and to a file for later use.
- If JEMRMS target file is available in the <DOUG install directory>/targets folder, DOUG will automatically load available JEMRMS targets file.
- To select JEMRMS target from list, select JEMRMS target name in the list on the left panel of the dialog. The name selected will appear in the top text box on the right panel. User can modify the name using this text box.
- JEMRMS modify by inputting values in their respective edit text box on the right panel or by selecting “Get Current Pos” button to update all the values to the current JEMRMS position.
- If the “Fixed Target” box is checked, the targets are not selectable. To modify targets, unselect box first.
- To Add/Update target, click the Add/Update button. If adding to JEMRMS Targets list, new list item will appear before selected item, if updating, new values will update and save to current selected target.
- The remove selected target from list click on the “Remove” Button.

- JEMRMS Target list modified is save for the current DOUG run until the “Save targets to Disk” button is selected. Once this button is click, DOUG automatically saves a JEMRMS target file in the <DOUG install directory>/targets folder for later use.
- Selecting “Targ RMS” in the bottom left section will apply angle values to the target JEMRMS.
- Selecting “RMS” in the bottom left section will apply angle values to the real JEMRMS.

## SPDM Targets Dialog

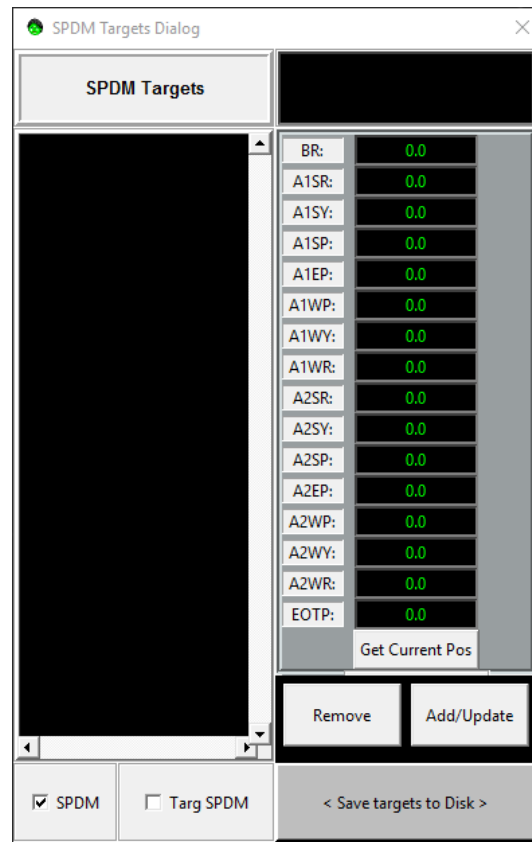

- Allows user add, remove, modify and save SPDM targets to DOUG run and to a file for later use.
- If SPDM target file is available in the <DOUG install directory>/targets folder, DOUG will automatically load available SPDM targets file.
- To select SPDM target from list, select SPDM target name in the list on the left panel of the dialog. The name selected will appear in the top text box on the right panel. User can modify the name using this text box.

- SPDM values changes by inputting values in their respective text box on the right panel or by selecting “Get Current Pos” button to update all the values to the current SPDM position.
- If the “Fixed Target” box is checked, targets will not change. To modify targets, unselect box first.
- To Add/Update target, click the Add/Update button. If adding to SPDM Targets list, new list item will appear before selected item, if updating, new values will update and save to the current selected target.
- The remove selected target from list click on the “Remove” Button.
- SPDM Target list modified is save for current DOUG run until the “Save targets to Disk” button selected. Once this button is click, DOUG automatically saves a SPDM target file in the <DOUG install directory>/targets folder for later use.
- Selecting “Targ SPDM” in the bottom left section will apply angle values to the target SPDM.
- Selecting “SPDM” in the bottom left section will apply angle values to the real SPDM.

## SSRMS Proximity Dialog

SSRMS Proxy Dialog	
Base Boom Dist (in):	24.0
Elbow Dist (in):	24.0
Tip Boom Dist (in):	24.0
<input type="checkbox"/> Audio Alarm	<input type="checkbox"/> Visual Alarm
<input checked="" type="checkbox"/> Nearest Vector Enable	
<input type="checkbox"/> Proxy Monitor Enable	

- Allows user to enable monitoring of individual SSRMS components: Base boom, elbow, and tip boom. Components will flash cyan when the specified envelop is violated. It enables by checking the “Proxy Monitor Enable” box.
- Enabling the “Audio Alarm” box turns on an audio alarm when the SSRMS gets close to structure.
- Enabling “Visual Alarm” box turns the SSRMS arm model yellow when the SSRMS gets close to structure.

- The size of the envelope on individual arm component modifies by editing the values of each respective component in the text box next to them. Values are represented in inches.

## JEM Proximity Dialog

JEMRMS Proxy Dialog	
UpperBoom Dist (in):	24
LowerBoom Dist (in):	24
<input type="checkbox"/> Audio Alarm	<input type="checkbox"/> Visual Alarm
<input checked="" type="checkbox"/> Nearest Vector Enable	
<input type="checkbox"/> Proxy Monitor Enable	

- Allows user to enable monitoring of individual JEMRMS components: Upper boom, and lower boom. Components will flash cyan when the specified envelop is violated. It enables by checking the “Proxy Monitor Enable” box.
- Enabling the “Audio Alarm” box turns on an audio alarm when the JEMRMS gets close to structure.
- Enabling “Visual Alarm” box turns the JEMRMS arm model yellow when the JEMRMS gets close to structure.
- The size of the envelope on individual arm components changes by editing the values of each respective component in the text box next to them.

## Translation Paths Dialog

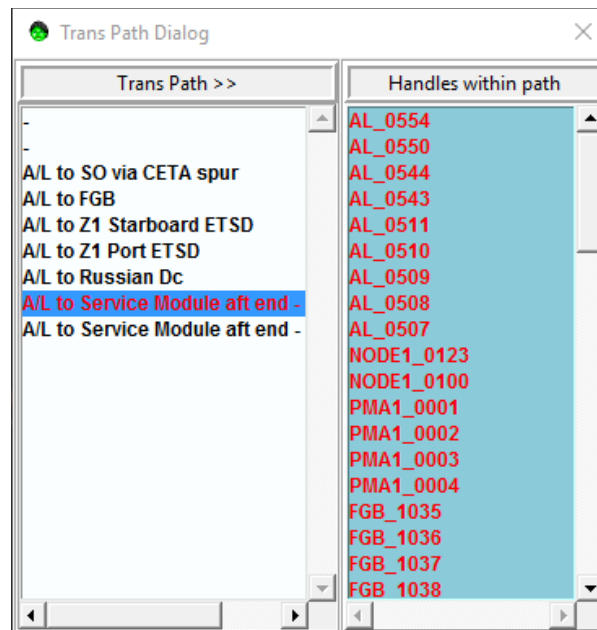

- Allows user to enable flashing of all the handrails in a pre-defined translation path.
- Select a Translation path from the list on the left section of the dialog, once selected, the list of handrails in the selected path will populate on the right section of the dialog. All the handrails in the list will automatically toggle on and the font of the labels will be red.
- To disable flashing, click on the enabled translation path name from the list on the left section of the dialog.

**Note: Translation Path Dialog does not have the ability to save new paths. A new state for a defined desired path are save. To have a new translation path defined in the Trans Path Dialog, contact the VR Lab to have one included with the next released load.**

## Ext HD Cam Dialog

The screenshot shows a dialog box titled "Ext HD Camera Dialog" with a close button (X) in the top right corner. It contains four sections, each for an external HD camera (EHDC #1 to #4). Each section includes a dropdown menu for the camera name, a text input field for HFOV (deg) with left and right arrow buttons, and a text input field for ZOOM (mm) with left and right arrow buttons. The camera names and their attached components are highlighted in yellow.

EHDC #	Attached to	HFOV (deg)	ZOOM (mm)
EHDC #1	ETVCG CP-8	10.17	206.03
EHDC #2	ETVCG CP-9	34.87	57.04
EHDC #3	ETVCG CP-3	22.18	91.41
EHDC #4	LAB ETVCG	9.15	230.02

- Allows user control HFOV and Zoom values for specific HD cameras. User can either input a numerical value, or use the arrow buttons to increase or decrease values. HFOV values are in degrees and Zoom are in millimeters.
- To change DOUG view to specific EHDC camera, use the pop up menu and select the Assign Camera option. Change Cameras using the *Camera Select Dialog*.

## BRT Handrails Dialog

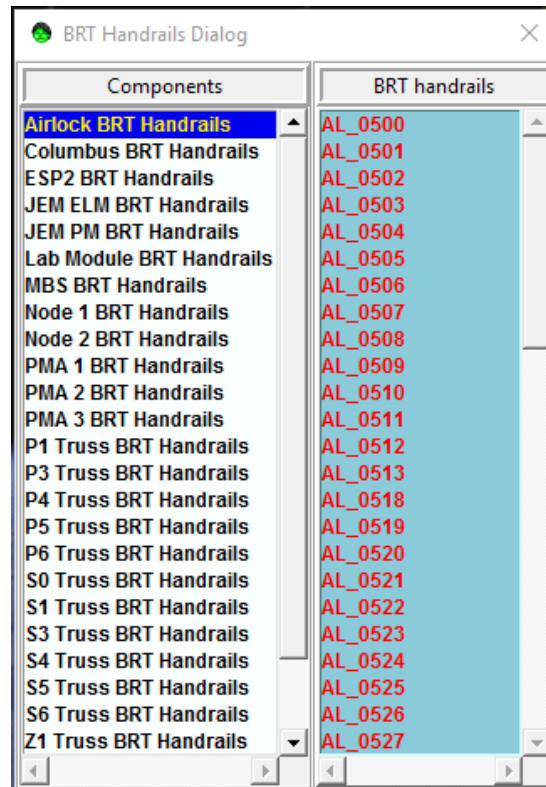

- Allows user to highlight green all available BRT Handrails on a selected component.
- To select, click desired component from the components list on the left section on the dialog window. The BRT handrails list on the right section on the dialog window will populate. All handrail available will highlight green and labels will be red.
- To disable flashing, click on the enabled component name from the list on the left section of the dialog.



## MUTEE-A-Tron Dialog

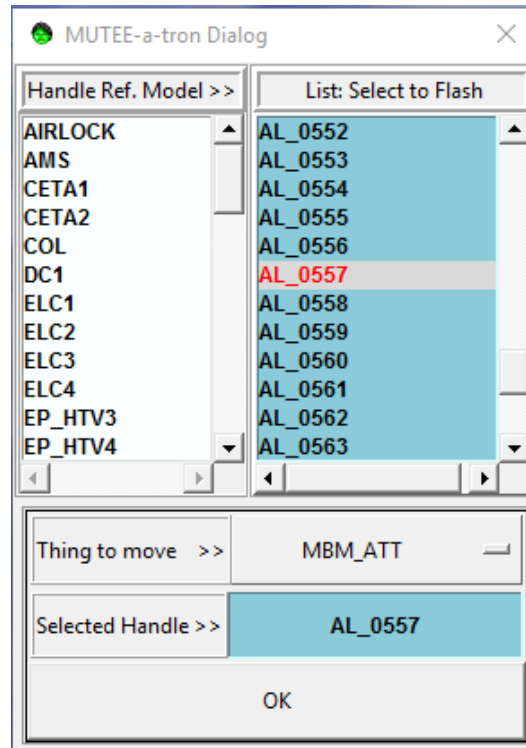

- Allows user to relocate MUT EE to a selected handrail on structure.
- To view a list of handrail options, click on a desired reference model on the left section of the dialog box. A handrail list will populate on the right section of the dialog box. Selecting any of the handrails on the list will flash the model in the DOUG view. The dialog allows the selection of multiple handrails to flash on but the last selected handrail name will appear in the text box next to “Selected Handle”.
- To move MUT EE select “MBM\_ATT” from the “Things to move” drop down menu, select a handrail and click “OK”. The MUT EE model will relocate to the selected handrail.
- To modify the angle position of the MUT EE, use the MBM JNTS dialog box under the *JntSystems > Tools > MBM JNTS* Option in the main menu.
- To stop handrail(s) or MUT EE model from flashing, click on the handrail label in the list on the right section of the MUTEE a-tron dialog box.

## Camera Groups Dialog

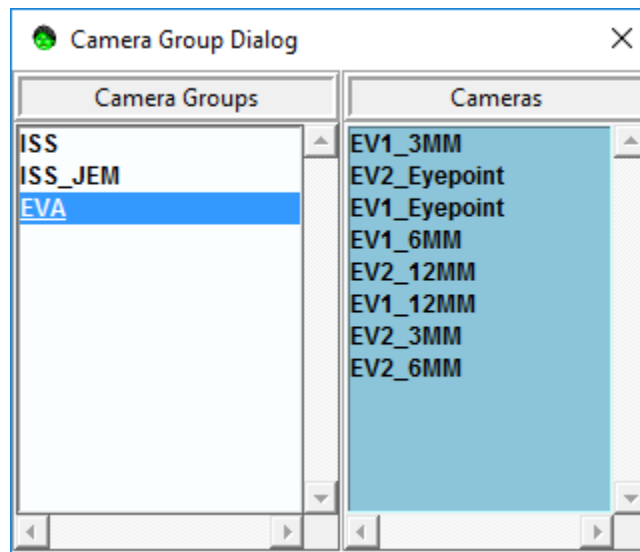

- Allows user to select and apply a camera view from a pre-defined camera group.
- To select a camera, click on a desired Camera Group from the list in the left section of the Dialog box. A list of available cameras will populate on the right section of the dialog box. Click on the desired camera from the list and the label will turn red and the cursor will become a pointer.
- To apply camera view to DOUG window, select the main DOUG window or the desired section of the DOUG window to apply the camera.

## ORU-A-Tron Dialog

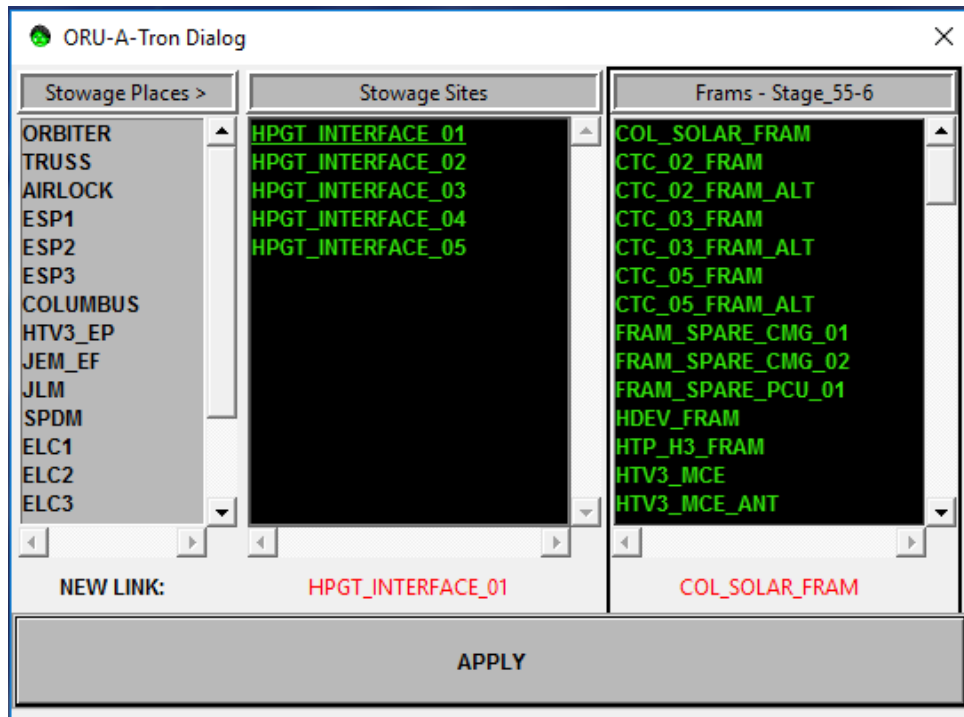

- Allows user to relocate ORUs to pre-defined stowage sites on structure.
- To select which ORU to relocate, click to select desired ORU FRAM from the list on the right section of the *ORU\_A\_Tron Dialog*. Clicking the ORU will update the “NEW LINK” text under the “Frams – Stage” list section.
- To select desired destination stowage site, select a Stowage Place from the list on left section on the dialog. A list of stowage sites on the selected stowage place will populate on the middle section of the dialog. Click the desired stowage site in the list on the middle section of the dialog. Clicking the stowage site will update the “NEW LINK” text under the “Stowage Sites” list section.
- To relocate ORU to new stowage site, after selecting ORU and site, click the “APPLY” button. ORU will relocate to selected site and will flash cyan. To stop flashing, click the selected ORU from the list.

# Other Menu Dialogs

## Edit Node Dialog

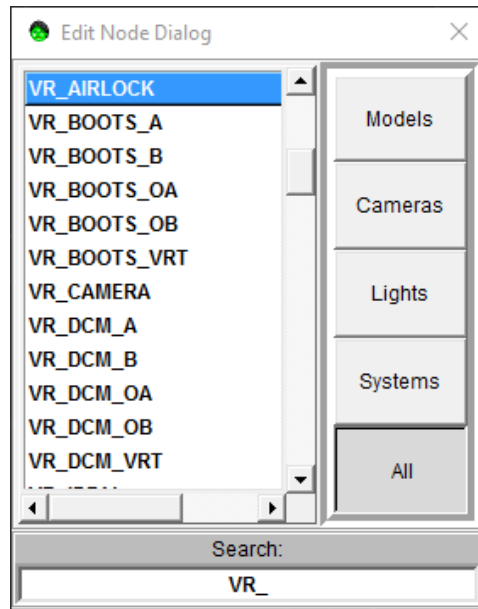

**Note:** The terms “node” and “model” is use loosely when using DOUG. For clarification, a node in DOUG can be a model, a camera, a light, or a system. A model is a specific type of node that has geometry and textures in the DOUG scene.

- Allows user to search and select node to modify. Find the dialog under the *Main Menu > Edit > Nodes...*
- To search for node, type a name or part of a name in the “Search” text box at the bottom of the dialog box. If the type of node is recognized, clicking any of the specific node buttons on the right side of the dialog box will filter the search to the selected node type.
- The node types are color coordinated throughout dialogs: System Nodes are purple, Model Nodes are blue, Camera Nodes are red and Light Nodes are yellow.
- Double-clicking on any node on the list will pop up its respective Edit Dialog Box. For example double clicking on a node that is a model will populate a blue *Edit Model Dialog* box and selecting a node that is a system will populate a purple *Edit System Dialog* box. These Edit Dialogs are described in detail in the following sections.

Every node has a hierarchy, which can be visualized in the *Edit > Tree View Editor Dialog*. This means every node has a “parent” and may or may not have a “child”. For example, the

VR\_AIRLOCK model node has parent node VR\_Node1 and multiple children i.e. handrails, toolboxes, etc.

## Edit Model Dialog

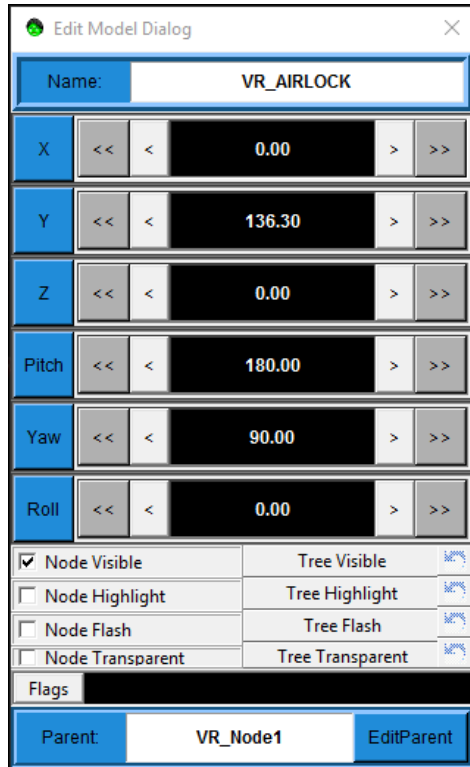

- Allows user to modify location and orientation of a selected model. Also allows user to toggle specific model attributes such as visibility (hiding/showing model), highlight (orange highlighting), flash (flashing cyan) and transparency. These attributes can be toggle for the whole model tree as well. **Use this dialog with caution. Modifying any of the values in this dialog could alter the scene's original configuration.**
- There are multiple ways to select model to modify:
  - From the *Edit Menu > Nodes... > Edit Node Dialog*
  - From the *Pop Up Menu > Pick Model to Edit* and click the desired model from the scene.
  - Typing valid model node name in the "Name" text box at the top of the *Edit Model Dialog* box.
- To modify the location and orientation of the model:
  - Type the value in the respective x, y, z, pitch, yaw, and roll text boxes or use the arrow buttons. When typing values, pressing enter after inputting a value will apply position or orientation changes to model.

- One arrow buttons increase or decrease the value in small intervals, double arrows buttons increase or decrease the value in large intervals. The model's location and orientation will update as buttons are pressed.
- Click the x, y, z, pitch, yaw, or roll buttons will reposition the model to the original configuration until the *Edit Model Dialog* box is closed. Once changes are apply and the Dialog is closed, the last values set are the new configuration values and the original values will be lost.
- To toggle specific model attributes:
  - Click on the check box next to "Node Visible", "Node Highlight", "Node Flash", or "Node Transparent" to toggle model visibility, highlight, flashing, and transparency respectively. Multiple attributes can be applied simultaneously. Attribute flag applied will populate in the "Flags" text box.
- Clicking "Tree Visible", "Tree Highlight", "Tree Flash", or "Tree Transparent" will propagate attribute through selected node and all its children. For example if VR\_AIRLOCK model node is selected and the "Tree Flash" button is click the airlock model will flash cyan including its children handrails, ORUs, etc.
- The *Edit Model Dialog* box also displays the current selected node's parent in the "Parent" Text box at the bottom of the dialog.
- To change model node parent node:
  - Type valid node name in the "Parent" text box at the bottom of the *Edit Model Dialog* box and press enter.
  - The node's parent will automatically update along with the position and orientation values relative to the new parent node. To center selected model to new parent node, set all position and orientation values to zero.
- Click the "EditParent" button in the *Edit Model Dialog* to change the selected model node to the parent node.

## Edit System Dialog

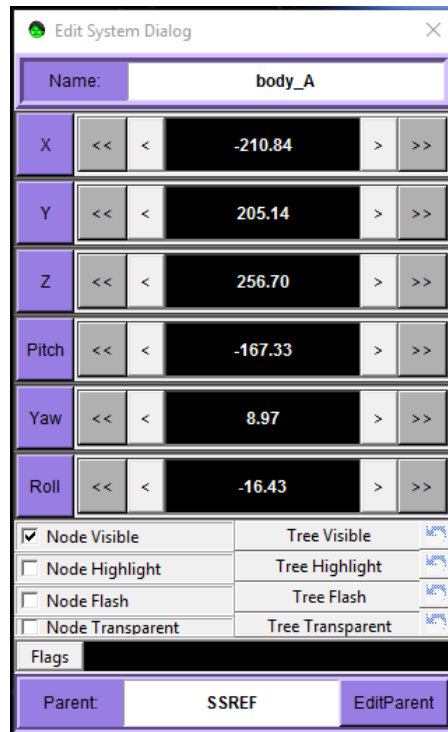

- Allows user to modify location, orientation and attributes of a selected system. This dialog is similar to the previously described *Edit Model Dialog*. The difference between a system node and a model node is that a system node has no geometry or textures in the DOUG scene. A system node is usually a parent node that is used to control the position, orientation and attributes of multiple children model nodes. For example any EVA body is made up of a torso model node, upper legs model node, lower legs model node, etc. The body\_A system node is the parent node to all those model nodes, thus modifying the values and attributes of the system node controls all children nodes. System nodes make moving multiple joint systems more efficient. **Use this dialog with caution. Modifying any of the values in this dialog could alter the scene's original configuration.**

# Extra Features and Plugins

## EVA Reconfig Load Review

The VRLAB Team generates a DOUG EVA Reconfig load for each EVA procedure. A package will provide the specific EVA configuration, including the EVA reconfiguration animations.

To review an EVA procedure the correct EVA package has to be installed and the specific EVA visual load has to be loaded. In the *Reconfig>EVAs* menu select the desired EVA. Once selected the *Reconfig Dialog Box* will appear.

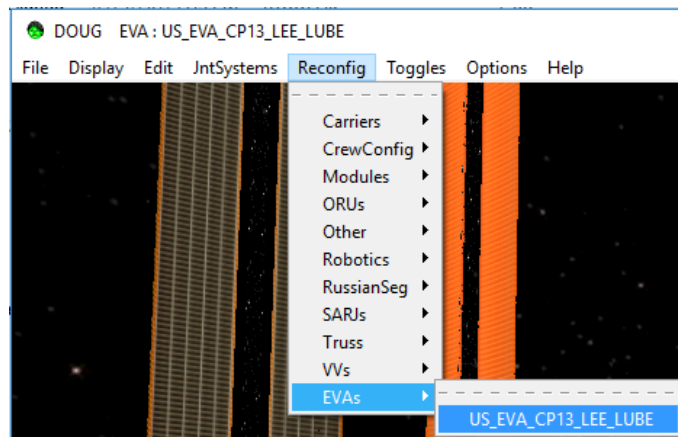



Using the *Reconfig Dialog Box*, the EVA procedures animation can be reviewed by clicking on each step in the *Reconfig Dialog* box. When the step is highlighted red, the procedure animation is in progress.

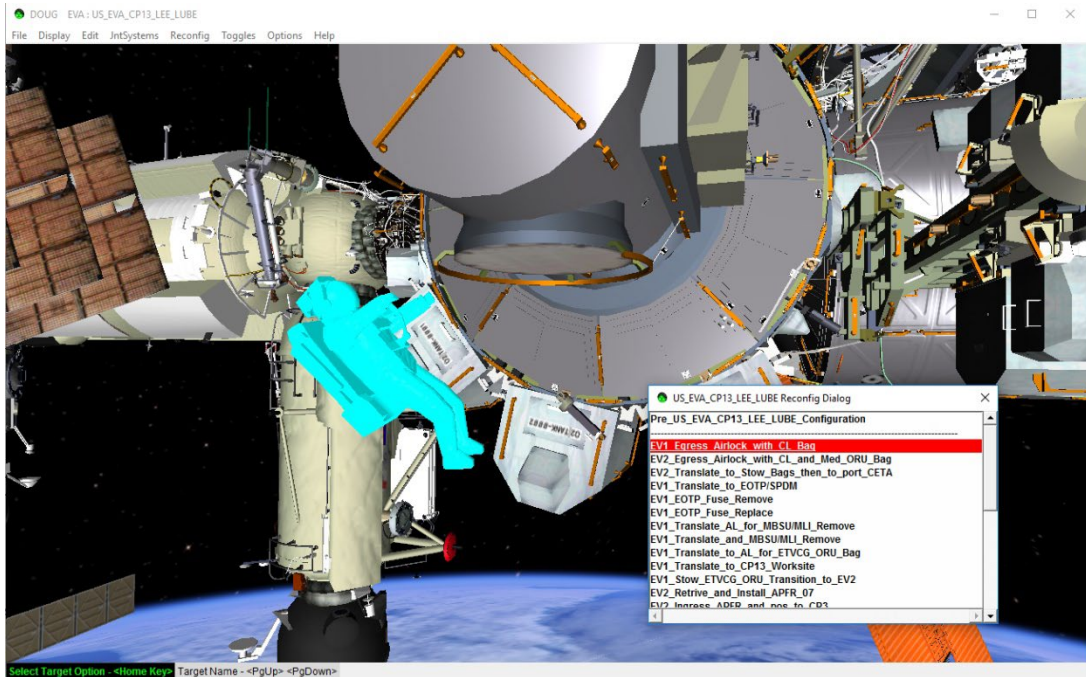

## Virtual Reality (VR) Plugin and Controls

The VR Plugin option is available for install when installing DOUG 1.72. If the machine the DOUG software is installed is VR ready, then the installer will notify the user that the VR plugin is available.

Once VR add-on plugin is installed, selecting *Display>VR HEADSET* will turn on the DOUG visuals on a connected Head Mounted Display (HMD). This option is only available if the VR add-on plugin is installed. DOUG supports multiple HMDs and controllers including VIVE, Oculus, and all of the Windows Mixed Reality HMDs. To set up specific HMDs, follow specific device installation guide provided by the manufacturer. This guide assumes MR/VR hardware has been successfully installed and HMD and controllers are connected, on, and tracking.



Once the DOUG visuals on the HMD are “enabled”, the user will be able to see and navigate the scene in VR. The computer screen will mirror what the user is viewing under the HMD. The DOUG VR plugin functionality is for visualization only. The user can navigate around the structure using the hand controllers and climb around using their virtual hands.

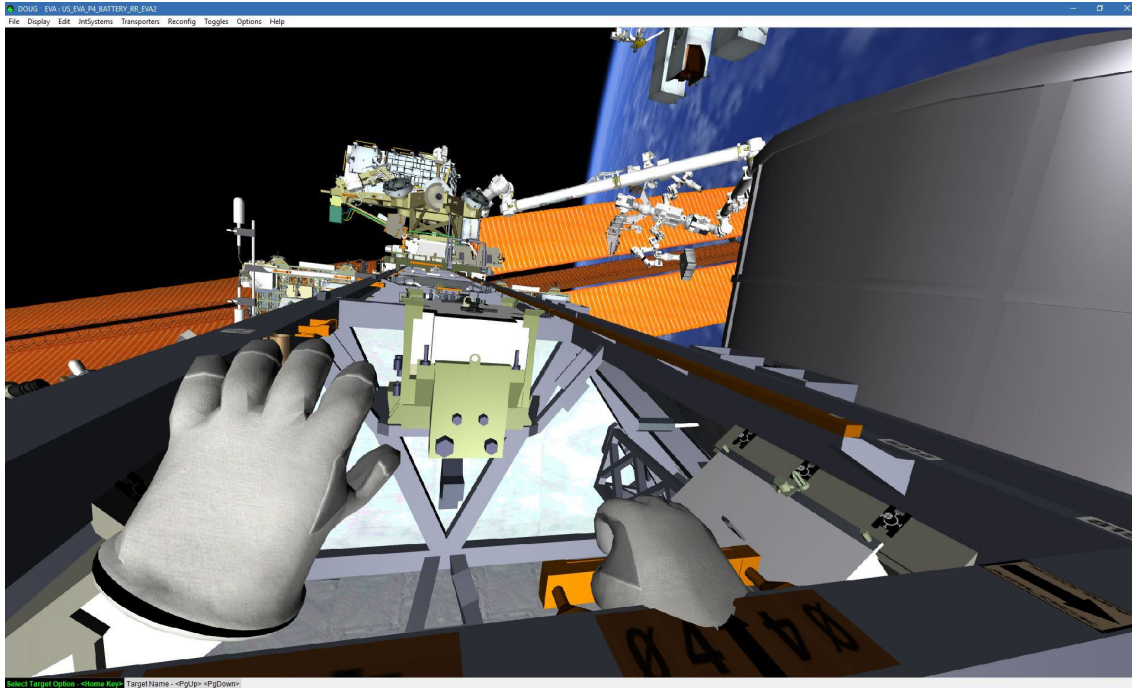

Most VR/MR hand controllers have similar input buttons. DOUG interaction using any hand controller should be the same throughout. In this user guide, the “MR” controllers are used as an example. Specific movement and interaction are achieved using either the left or right controller input. Left and Right hand controller tracks VR left and right gloves respectively.

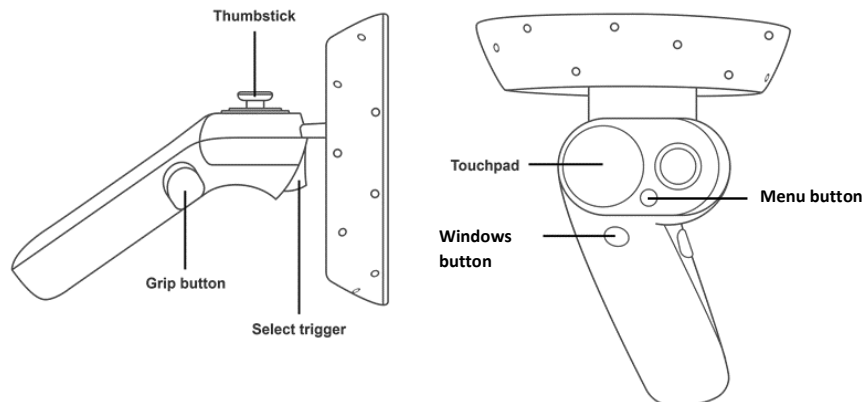

#### Left hand controller inputs:

- *Thumb stick* functions as kinematic translation (forward, backward, left and right) fly around with reference to HMD pointing direction (if you want to go down, look down and move joy stick forward)
- Index finger *Select Trigger* depression activates VR glove grasp
- *Menu Button* resets to EVA start position
- *Windows Button* brings user into MR Holodeck, not desired when moving around in the DOUG scene. To return to DOUG, remove HMD and re-don it. Unfortunately, this button is defaulted by Microsoft and cannot be disabled. Yet 😊

#### Right hand controller inputs:

- Index finger *Select Trigger* depression activates VR glove grasp
- *Windows Button* brings user into MR Holodeck, not desired when moving around in the DOUG scene. To return to DOUG, remove HMD and re-don it. Unfortunately, this button is defaulted by Microsoft and cannot be disabled. Yet 😊

#### Interaction:

- Hand controllers grasping (Select Trigger) gestures can be utilize for physics contact and grasping in VR environment.
- When both hand controllers have the Select Trigger button pressed (grasp gesture), the last one to grasp is the hand that controls the body movement and rotation. This enables a simple hand over hand locomotion method.

## Gamepad Plugin and Controls

The Gamepad Plugin is available by default with the DOUG 1.9 release. This plugin allows the user to utilize a gamepad to navigate the DOUG scene in addition to the keyboard controls. DOUG supports any gamepad/controller i.e Xbox, Logitech, etc. For this Guide the Xbox controller buttons shown in the diagram will be used to explain the controls. Note that the same controls apply to any other gamepad. Gamepad must be connected to the computer running DOUG and appropriate drivers must be installed BEFORE launching the DOUG application. If gamepad is connected after DOUG initialization, controls may not work properly.

- **Left Bumper** – Rotate camera view counter clock wise
- **Right Bumper** – Rotate camera view clock wise
- **Y Face Button** – Tilt camera view up
- **A Face Button** – Tilt camera view down
- **X Face Button** – Pan camera view left
- **B Face Button** – Pan camera view right
- **Left Stick**
  - Up – Move camera up
  - Down - Move camera down
  - Left – Move camera left
  - Right – Move camera right
- **Right Stick**
  - Up – Zoom camera in
  - Down – Zoom camera out
- **Start Button** – Speed up camera movement
- **Back Button** – Slow down camera movement

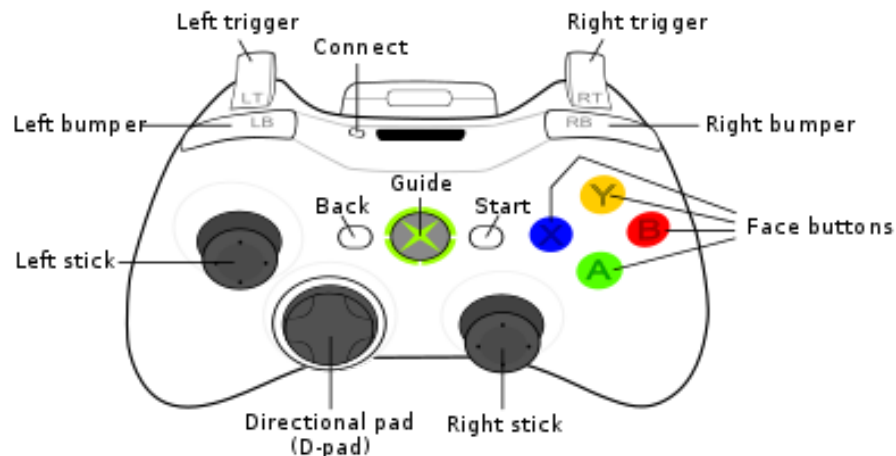

## Telemetry Feature

The telemetry feature supports live stream data from the ISS to DOUG. When enabled the feature updates DOUG components (models and nodes) in real-time via ISP server. Selecting the *Options Menu > Telemetry option* will show the available Telemetry Data Streams:

- Mobile Servicing System (MSS) (includes the SSRMS, MBS and SPDM)
- Solar Array Alpha Rotary Joint (SARJ)
- Japanese Experiment Module (JEM)

To view the joint values of the respective robotic system. The *Display Menu > Show SSRMS Telemetry/Show JEM Telemetry/Show SPDM Telemetry* toggle will display selected systems' angles in the information panel at the bottom of the DOUG main window.

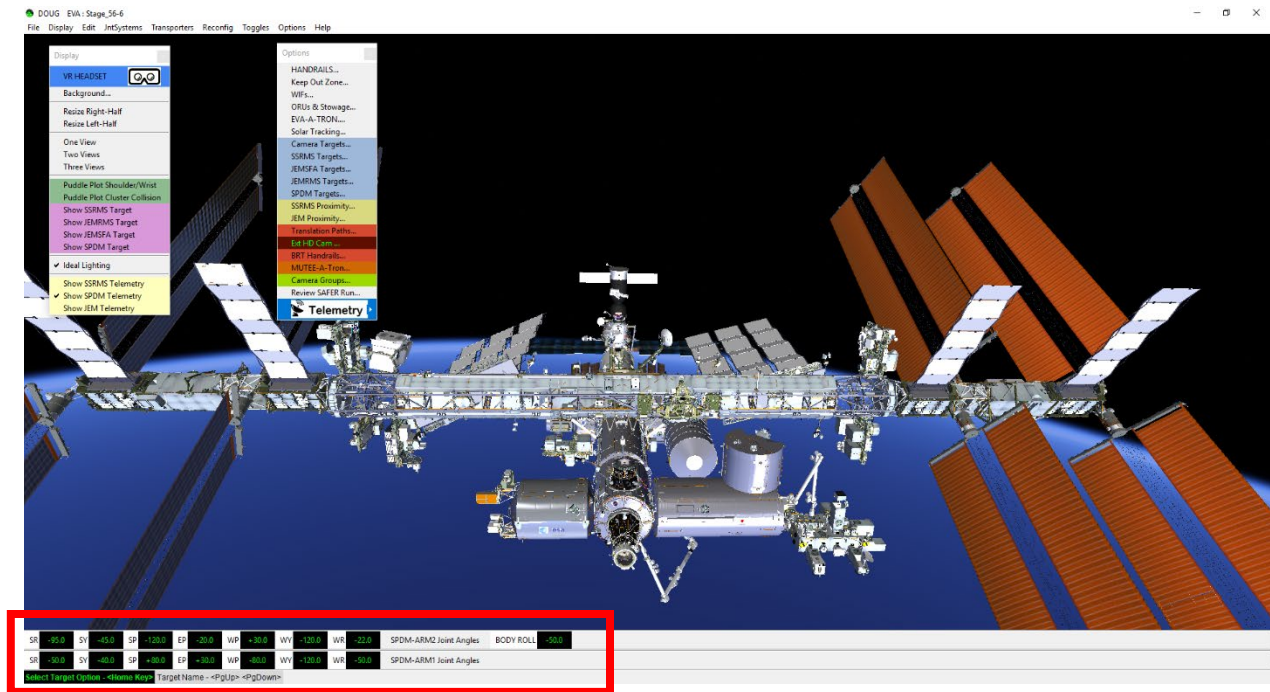

## NBL Visual Load

The NBL visual load provides the NBL configuration model stack and options. At DOUG start up, select the “NBL” visual load. This will run DOUG with an NBL configuration with all the nodes and structures needed to set-up a scenario for pool training. A list of components will be available in the *NBL Set-Up Dialog* under the *Options Menu*. In the *NBL Set-Up Dialog*, clicking a desired node will bring up an Edit Model Dialog. To modify node location and orientation, use the Edit Model Dialog as desired.

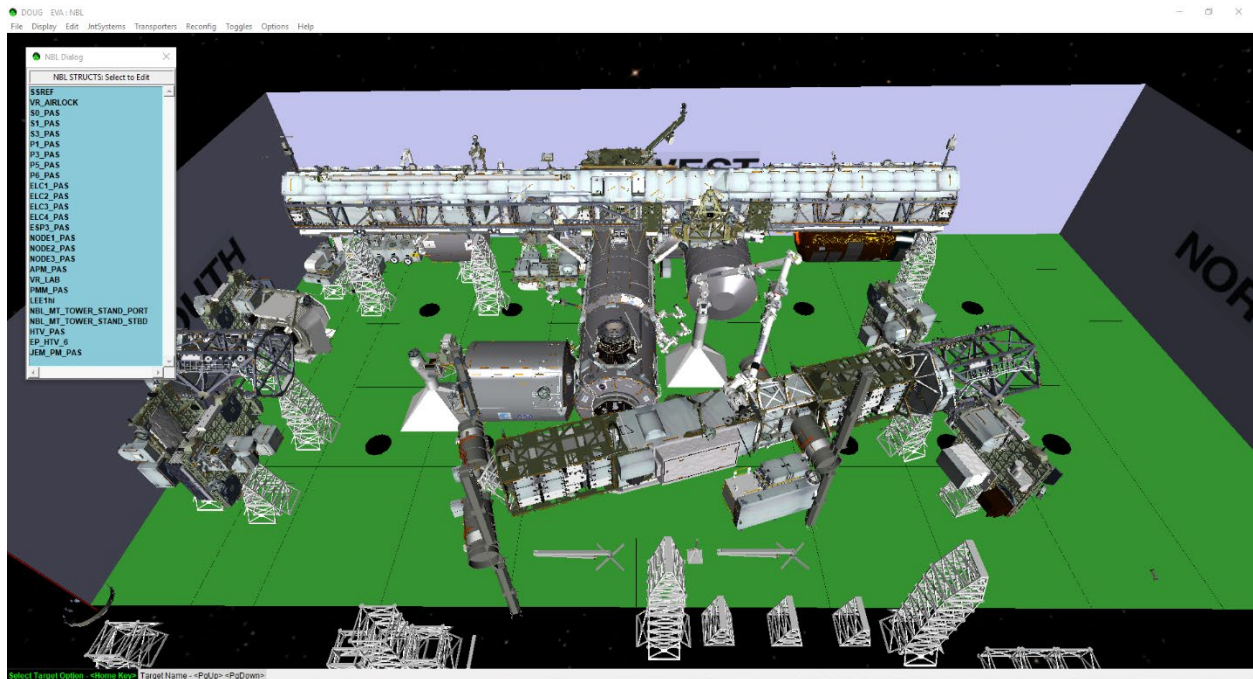

## SAFER Run Review Tool

The SAFER Review tool is a plugin available through the DOUG website and not included in the default DOUG 1.72 release. For instructions on how to download, reference the Obtaining and Installing DOUG Plugin section. This plugin allows the user to load a recorded SAFER run data text file (provided by the VR Lab team after SAFER sim class) and review simulation data, hand controller inputs and rescue flight trajectory.

- Once installed successfully, to launch the SAFER Review Menu dialog click on the *Main Menu > Options > Review SAFER Run...* option.

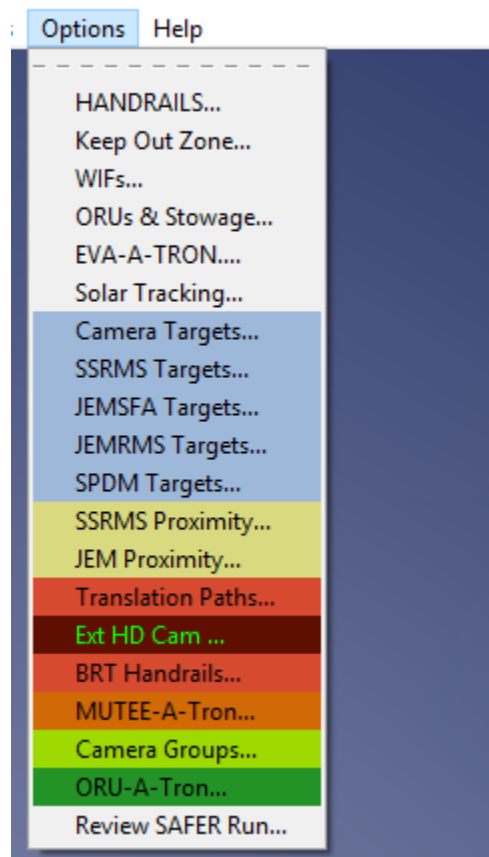

The SAFER Review Menu Dialog box will open up. To review a SAFER run:

- Click the “Select SAFER Run for Review” button at the top of the dialog box. A file selection dialog will appear.
- Navigate to the desired SAFER run data text file and select it. Once selected, the data will load automatically and the yellow trajectory trail line will appear in the main DOUG window.



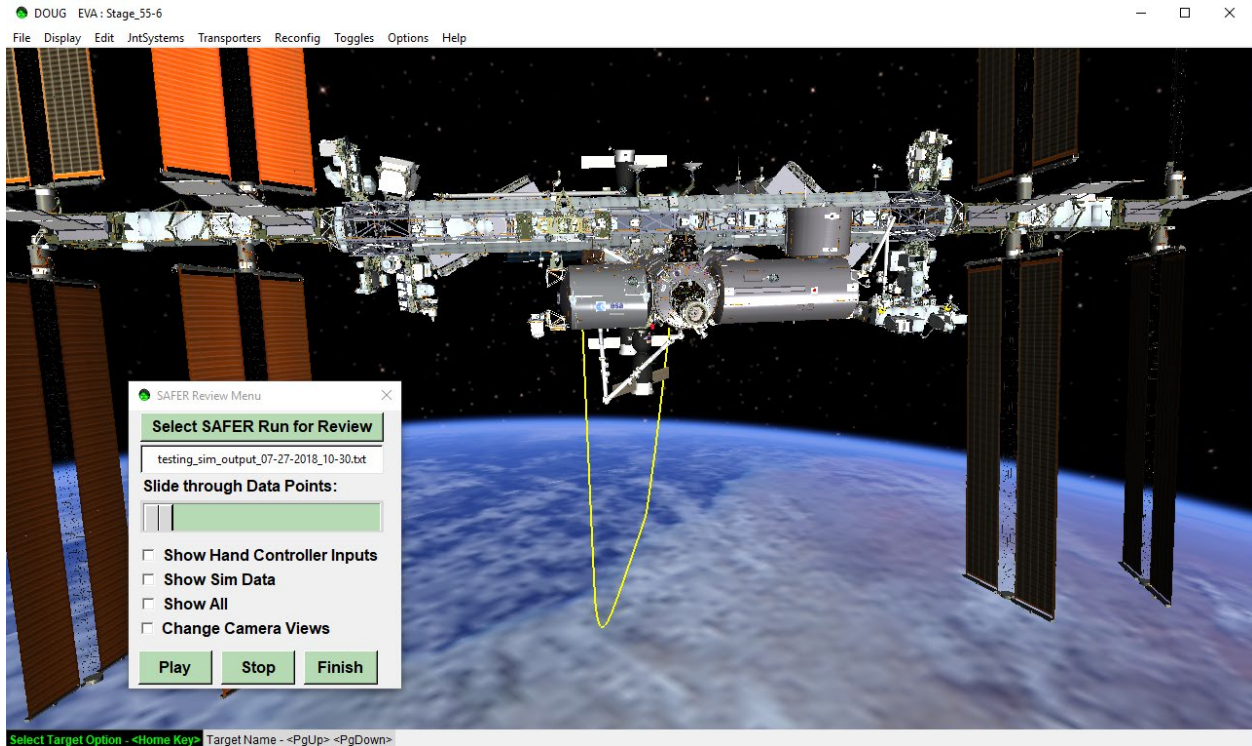

Once the selected SAFER run data is loaded, the user is able to review the data using the SAFER Review Menu.

- To toggle hand controller inputs visualization and/or simulation data select the “Show Hand Controller Inputs” and/or “Show Sim Data” checkbox. A hand controller will appear and display the inputs commanded at specific points in the run. Simulation data can also be displayed for that specific point. These will appear on the lower left corner of the main DOUG view.

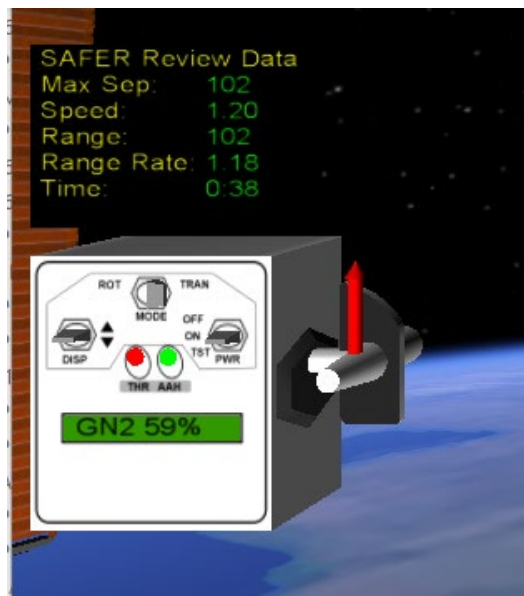

- To play through the data click the “Play” button at the bottom of the dialog.
- To stop the playback at any time, click the “Stop” Button at the bottom of the dialog.
- To slide through the data points, use the slider in the dialog or the “f” keyboard button to move forward on the trail or the “b” keyboard button to move backwards. To move at larger increments, hold down the left “Ctrl” keyboard button while pressing “f” or “b”.

**Note: The “Play” button can be used at any time and will start playback at the last position selected on the slider or with the keyboard buttons.**

During playback or when sliding through data points, the hand controller (if enabled) will show exaggerated inputs as well as axis lines. It will also show GN2 percentages, thruster lights, AAH lights and Rot/Tran mode inputs for the selected data point. An EV body will appear on the trail to represent the specific point in the data set. The EV body will be oriented accurately to the EV body position during the SAFER run. For clarity a red +X axis line has been added to the EV model to show the forward orientation.

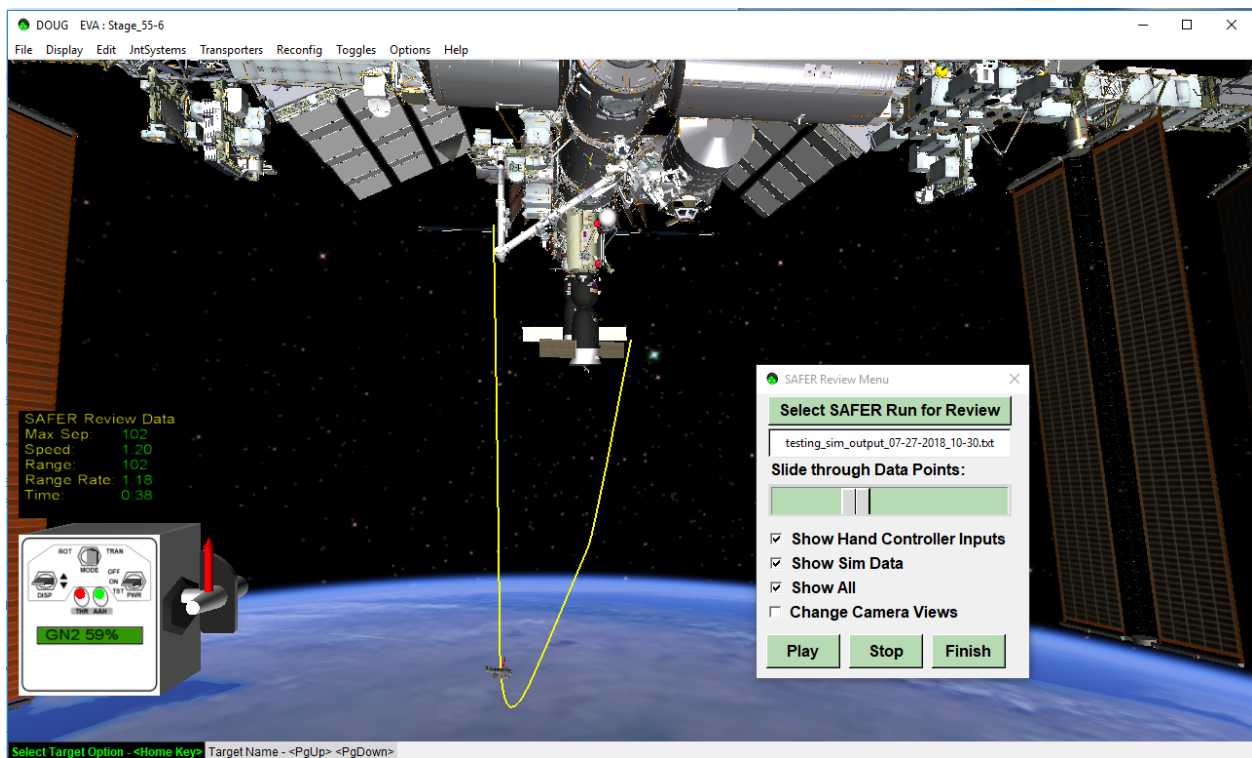

- To change camera views, select the “Change Camera Views” check box. The Main DOUG window will split into three views. The bottom view will become the default main view (JimboCam), the top left view will become a close up EV view and the top right view will become the EV eye view. These views can be changed to the default DOUG view by disabling the “Change Camera Views” checkbox.

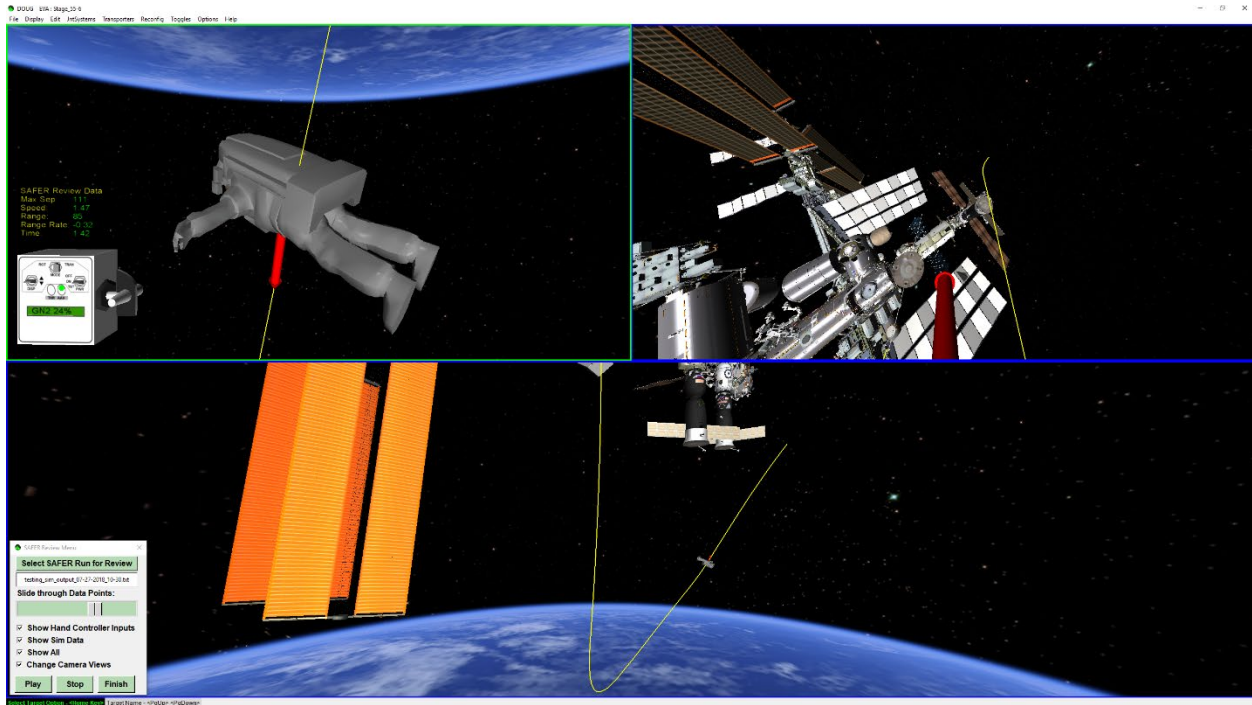

- To select another data file, click the “Select SAFER Run for Review” button again to load a different file. Once selected, the trail will automatically update to the new selected data file.
- To clear the trail and exit review mode, click the “Finish” button.

# Specific Task Examples

## Placing Scoops on ORUs

- Open the Edit Node Dialog using the main *Menu > Edit > Nodes..* option
- Use the search text box to search for a Scoop model node

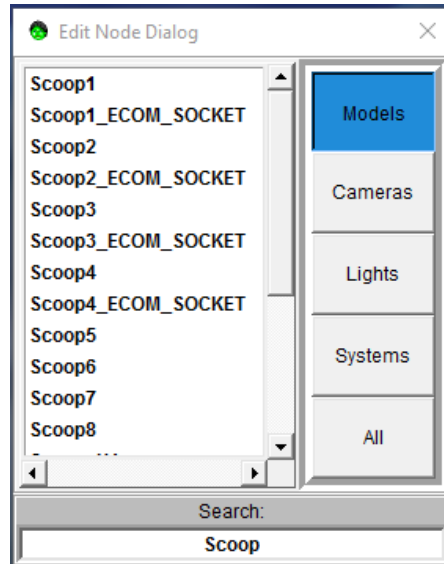

- Double click on any Scoop node from the list to open the *Edit Model Dialog*
- Keep both dialog boxes open. It is important to check if the selected scoop model node is already be used somewhere else. This can be determined by checking the node's parent and the visibility flag. If the node is set as HIDE, it usually means the model node is okay to be re-located. Typically if the parent node is NULL or VR\_AIRLOCK, the node is unused and/or a spare model node.



- If the current model node is use, click on another scoop model in the Edit Node Dialog box list to check other model properties.
- Once an available scoop model is located, navigate to desired ORU where the scoop can be place. The closer the view to the ORU the easier it is to position the scoop.

- Use the *Pop Up menu > Pick Model to Edit* option. Hover over the desired ORU location to check node name. The node name will show at the top left section of the screen.

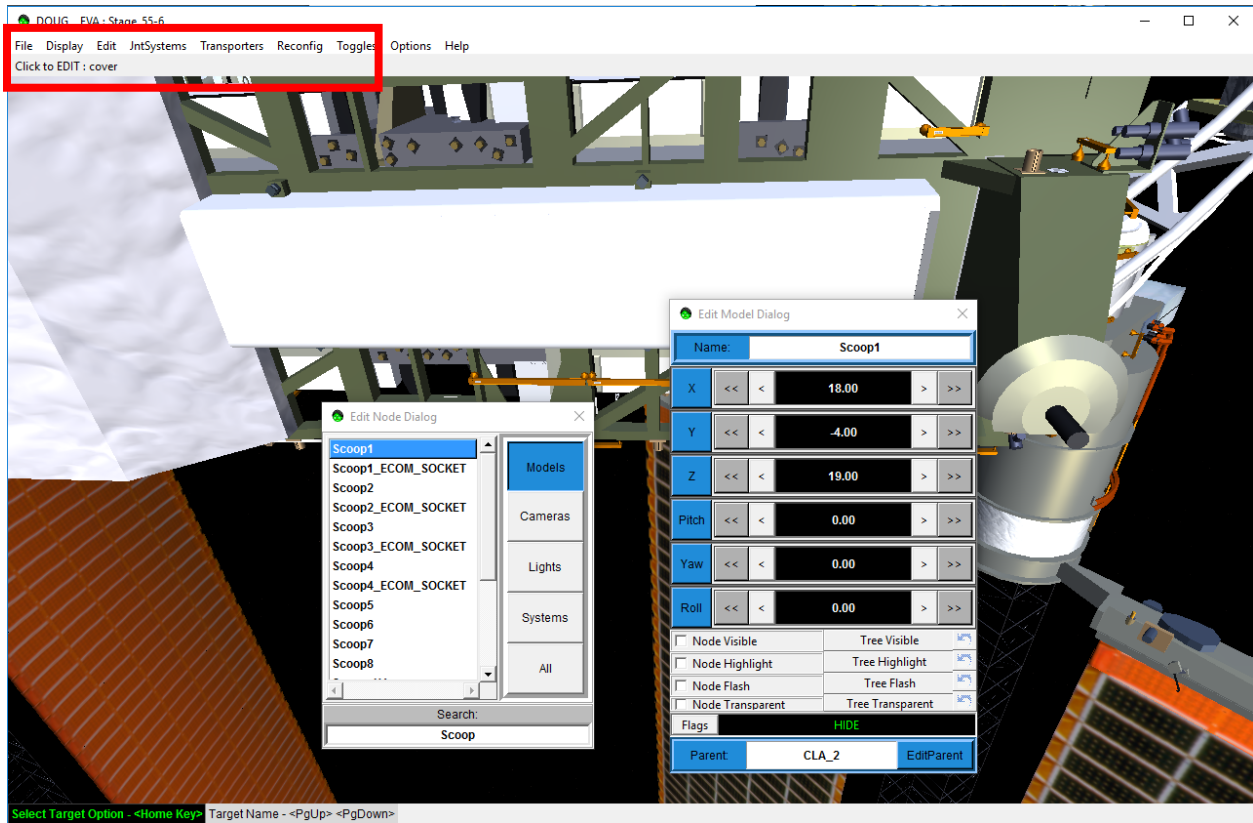

- Change the parent node name of the scoop to the ORU node name in the *Edit Model Dialog* box. Followed by “0 0 0 0 0” and press enter.

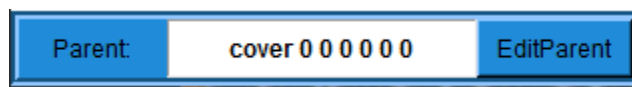

- If hidden, make node tree visible by clicking the “Tree Visible” button.
- To make it easier to find and position, highlight or flash the scoop using the “Tree Highlight” or “Tree Flash” buttons. The scoop should appear somewhere around the new parent node model.

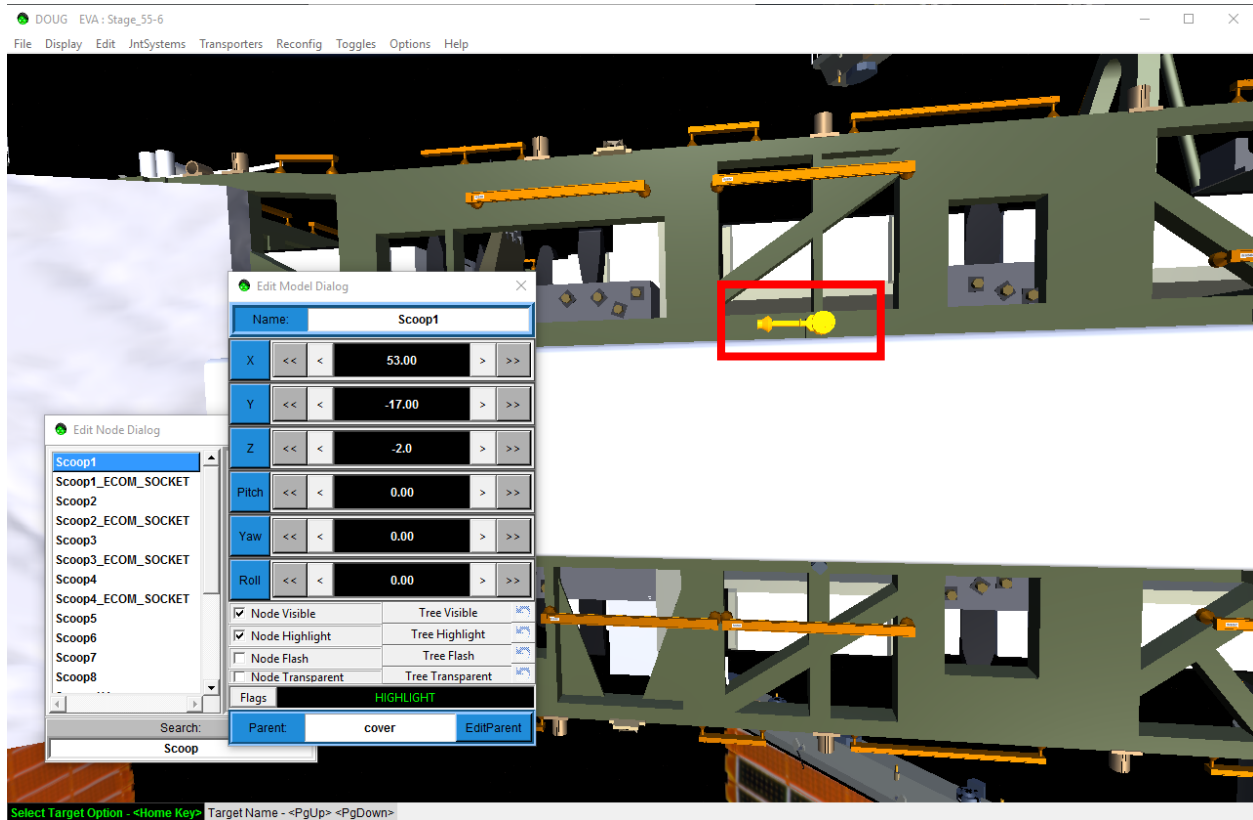

- Use the *Edit Model Dialog* arrow buttons to adjust the position of the scoop over desired location.

**Note:** This same process can be used to reconfigure any model node in DOUG scene.

## Reconfiguring MT and CETA Carts

- Open the MOBILE\_TRANSPORTER\_CETA\_CARTS *Reconfig Dialog* using the *Main Menu > Reconfig > Truss > MOBILE\_TRANSPORTER\_CETA\_CARTS* Option.

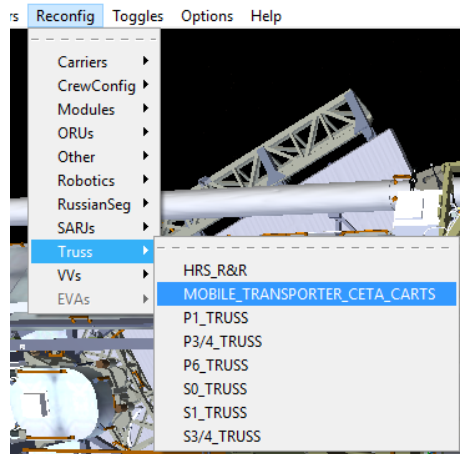

- Using the MOBILE\_TRANSPORTER\_CETA\_CARTS *Reconfig Dialog* select which worksite to move the MT to. Clicking any of the locations on the list will automatically update the MT position in DOUG scene.
- This dialog is also use to detach CETA carts from MT and reposition CETA carts starboard or port of MT, and to position the CETA Carts relative to each other. It also has CETA Cart options to:
  - Move Brake Handles
  - Latch/Unlatch Wheel bogies
  - Move Tool Stanchion
  - Attach Cart to EV
  - Detach/Attach Cart

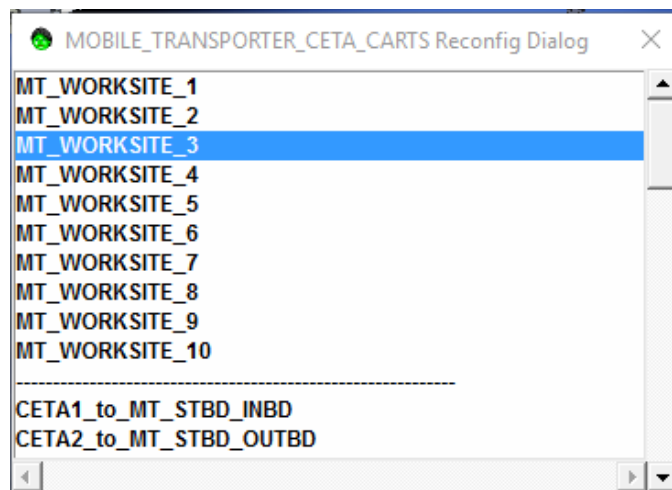



- To move CETA Carts detach desired cart from MT by selecting the “DETACH\_CETA1” or “DETACH\_CETA2” from the list on the MOBILE\_TRANSPORTER\_CETA\_CARTS *Reconfig Dialog*.
- Once detached, use the CETA1/2 Dialog from *Main Menu > Transporters > CETA 1 (or 2)* and the arrows to move the selected cart along the truss rails.

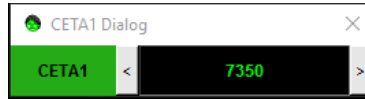

- Once detached, use the CETA1/2 Dialog from *Main Menu > Transporters > CETA 1 (or 2)* and the arrows to move the selected cart along the truss rails. The numbers correspond to the CETA rail numbers at approximate locations of the cart. An EV crewmember may need an identifier number corresponding to his eye level in the TFR or the cart edge. If view is close enough, numbers are modeled in DOUG matching those in the CETA Dialog.
- To change positions of CETA cart WIFs and Swing arms use the *Main Menu > JntSystems > CETA > CETA1 (or 2)* option. A different CETA1/2 Dialog will appear. WIF angles and Swing arm rotations can be modified by clicking the arrow buttons or inputting values in the text boxes and pressing enter to apply.



## Rotating SARJ and TRRJ

- To rotate the SARJ use the *Main Menu > JntSystems > Truss > Solar\_Array\_Alpha* or *Main Menu > JntSystems > Truss > Solar\_Array\_Beta* to open respective dialog box.
- Use the arrow buttons to rotate arrays.

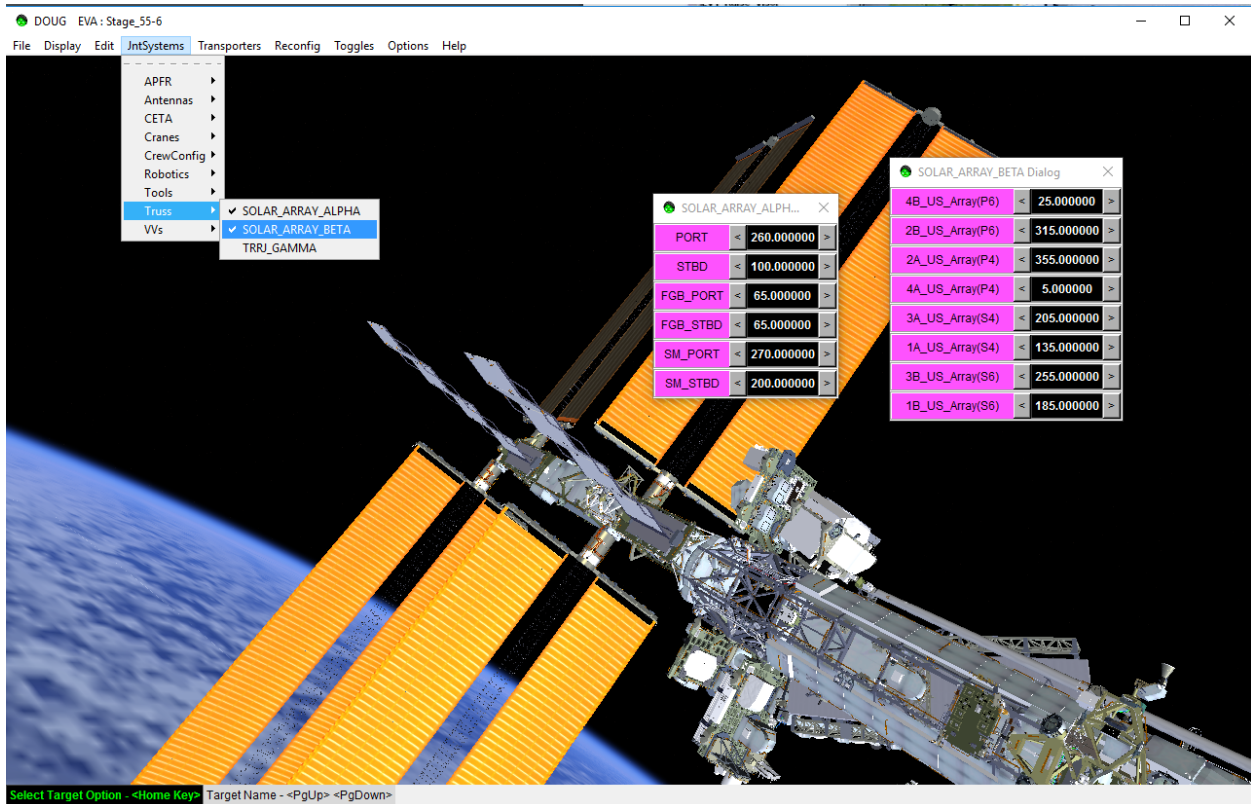

**Note:** In the *Solar\_Array\_Alpha* Dialog, *PORT* and *STBD* refer to SARJ off of P3 and S3, while *FGB* and *SM* rotate Russian Modules solar joints.

## Change SSRMS Location

- To change location of SSRMS use the *Main Menu > Reconfig > Robotics > SSRMS* to open the *SSRMS Reconfig Dialog* box.

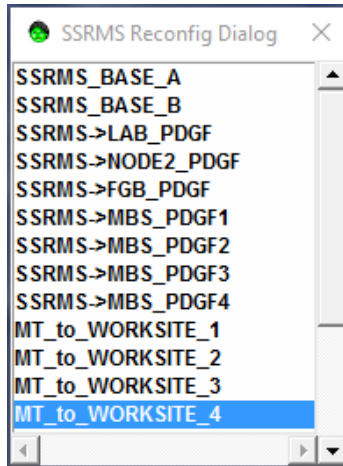

- Select location from the list to move SSRMS. Clicking any item from the list will automatically reposition the SSRMS to selection and update the DOUG scene.
- To change the SSRMS angles use the *Main Menu > JntSystems > Robotics > SSRMS* to open the *SSRMS Dialog*.



- Use the *SSRMS Dialog* to modify the joint angles of the SSRMS by inputting values into the text boxes or clicking the arrow buttons. Click *Update Models* button to apply changes.

# Acronyms

<b>APFR</b>	Articulating Portable Foot Restraint
<b>CETA</b>	Crew and Equipment Translation Aid
<b>COTs</b>	Commercial off the Shelf
<b>DOUG</b>	Dynamic Onboard Ubiquitous Graphics
<b>ELC</b>	Express Logistics Carrier
<b>ESP</b>	External Stowage Platform
<b>EV</b>	Extra Vehicular [crewmember]
<b>EVA</b>	Extra Vehicular Activity
<b>FHRC</b>	Flex Hose Rotary Coupler
<b>FRAM</b>	Flight Releasable Attachment Mechanism
<b>HMD</b>	Head Mounted Display
<b>HPGT</b>	High Pressure Gas Tank
<b>ISS</b>	International Space Station
<b>JEM</b>	Japanese Experiment Module
<b>JPM</b>	JEM Pressurized Module
<b>JSC</b>	Johnson Space Center
<b>KOZ</b>	Keep Out Zone
<b>LEE</b>	Latching End Effector
<b>MBS</b>	Mobile Base System
<b>MLI</b>	Multilayer Insulation
<b>MR</b>	Mixed Reality
<b>MT</b>	Mobile Transporter
<b>MUT EE</b>	Multiple Use Tether End Effector
<b>ORU</b>	Orbital Replacement Unit
<b>PAS</b>	Payload Attachment System
<b>PDGF</b>	Power Data Grapple Fixture
<b>PMA</b>	Pump Module Assembly
<b>SARJ</b>	Solar Alpha Rotary Joint
<b>SSRMS</b>	Space Station Remote Manipulator System
<b>SSU</b>	Sequential Shunt Unit
<b>TFR</b>	Translational Foot Restraint
<b>TRRJ</b>	Thermal Radiator Rotary Joint
<b>UCCAS</b>	Unpressurized Cargo Carriers Attachment System
<b>VR</b>	Virtual Reality
<b>WIF</b>	Worksite Interface Fixture