



# X-59



## PAPER DESKTOP MODEL

# X-59

NASA's X-59 experimental aircraft is designed to fly faster than the speed of sound and is being used to help open a new era of commercial supersonic air travel over land. Instead of the loud sonic boom produced by other supersonic aircraft, its unique shape will change shockwaves that come from the aircraft, resulting in a more gentle sonic "thump." Shockwaves are sharp changes in air pressure caused by an object moving faster than the speed of sound, which is approximately 660 mph at sea level.

The X-59 research aircraft will be used to conduct a series of flights over several communities around the United States to learn what residents think about the aircraft's sonic thump. NASA will give that information and other data to regulators to help

change the rules that currently ban supersonic flight over land.

NASA contracted Lockheed Martin Aeronautics Company to design, build, and conduct initial flight testing of the X-59 at its Skunk Works factory in Palmdale, CA. The single-seat X-59 is 99.7 feet long, 29.6 feet wide, and will cruise at an altitude of 55,000 feet while moving at a speed of Mach 1.4, or 925 mph.

All four of NASA's aeronautics field centers, working together with partners in government, industry, and academia, are pulling together to enable a new era in aviation.



Illustration Credits: Lockheed Martin

## X-59 Desktop Model Instructions

Materials Required: scissors, utility knife, glue, cutout sheets, pencil

For curves, wrap the paper around a pencil or roll on the edge of a desk.

**Only score and fold along dashed lines.**

For online printing, cardstock is recommended.

*If you are participating in NASA's Flight Log Experience, enter the code on the cover of these instructions to earn an X-59 endorsement stamp. The Flight Log can be found at [www.nasa.gov/flightlog](http://www.nasa.gov/flightlog).*

*For this and other hands-on X-59 building activities, go to our X-59 Maker Bundle: <https://www.nasa.gov/sites/default/files/atoms/files/x-59-maker-bundle-v8.pdf>.*

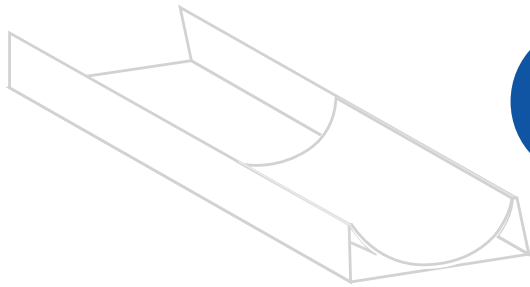

STEP  
1

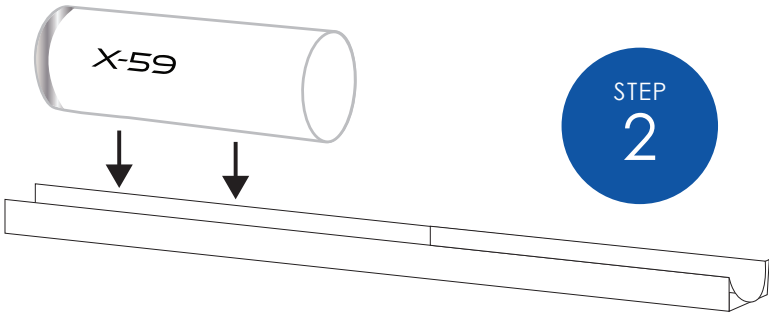

STEP  
2

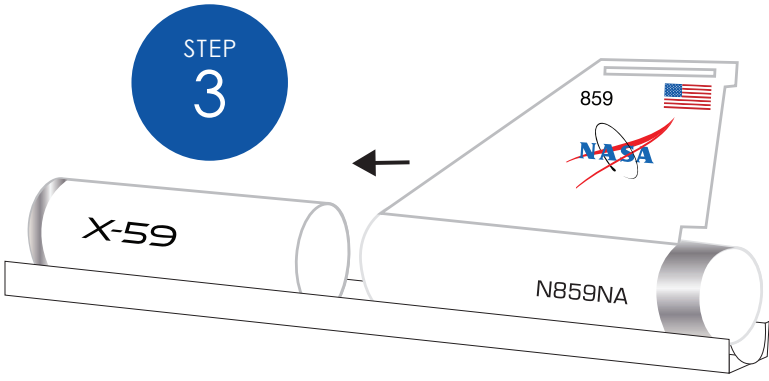

STEP  
3

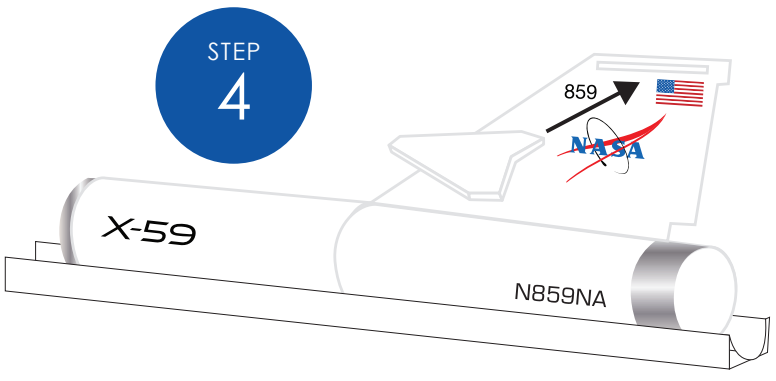

STEP  
4

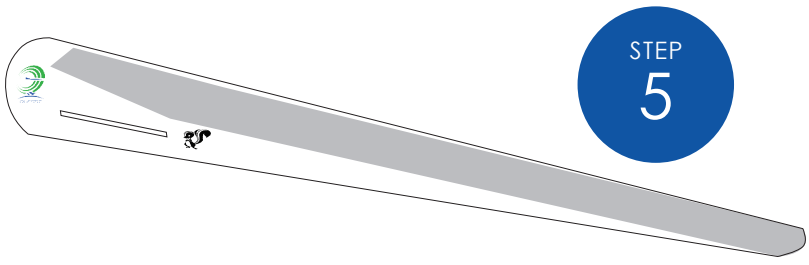

STEP  
5

1. Cut out all parts by following the outermost line of each piece.
2. Score along dotted lines on **PART 1**.
3. Fold **PART 1** as shown, and glue the tab on the right side.

---

4. Score on the dotted line on **PART 2**.
5. Roll **Part 2** into a cylinder (using a pencil, wrap it around to get the cylinder shape, then remove the pencil).
6. Glue it to itself using the tab.
7. Line up with the edge of **PART 1** and glue down.

---

8. Score on the dotted lines on **PART 3**.
9. Using a utility knife, cut a slit along the line on **PART 3**.
10. Fold **PART 3** using all the guide lines printed on the paper, then roll the lower half into a cone.
11. Glue the top wing together as well as the tab.
12. Glue the circular edges of **PART 2** and **PART 3** together.

---

13. Score and fold **PART 4** in half along the fold line and glue together.
14. Insert into the slit created in step 9 and glue in place.

---

15. Cut the slits on either side with a utility knife.
16. Score on the dotted lines.
17. Curl **PART 5** into a cone.
18. Fold the tip first, and glue it together.
19. Glue along the tab and join.



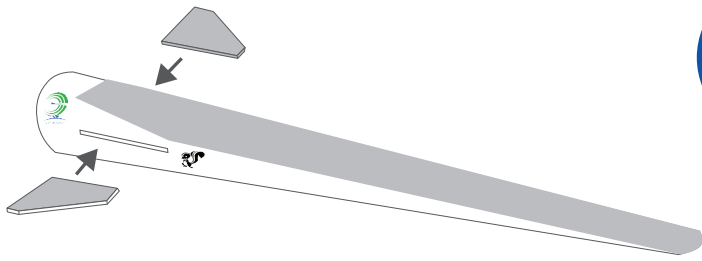

STEP  
6

20. Score on the dotted lines and fold the two **PART 6**'s along the fold line, and glue each of them to themselves.

21. Insert each into their respective slits, and glue them in place.

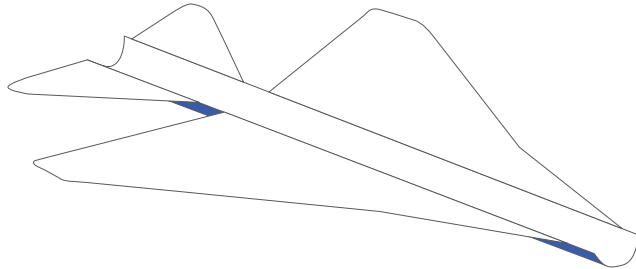

STEP  
7

22. Score on the dotted lines and fold **PART 7** as shown.

23. Remember to fold curves on something round like a pencil or on the edge of a desk.

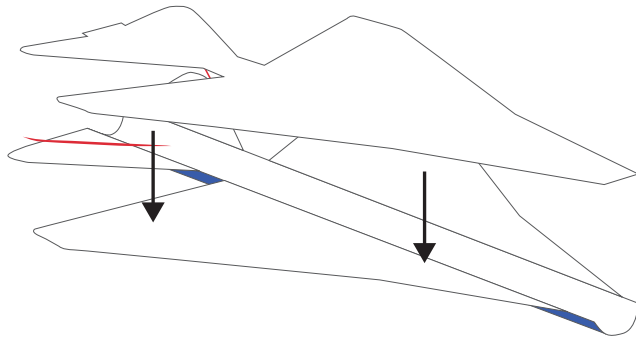

STEP  
8

24. Line up the wings of **PART 7** and **PART 8** and glue together. This will leave a semicircle on the bottom that is not glued to anything. Be sure the printed side is down on **PART 7** and visible from below.

25. Do not glue the entire wing, just the edges so it does not wrinkle.

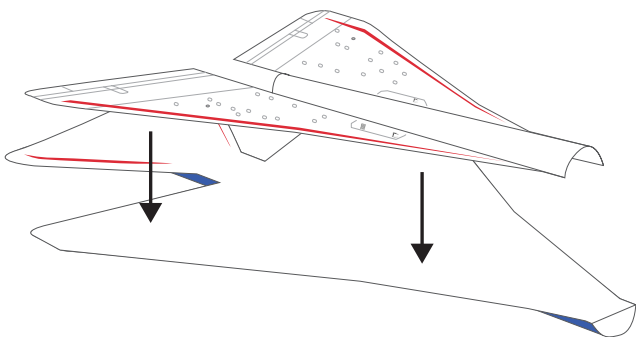

STEP  
9

26. Score on dotted lines and fold **PART 9** as shown. Designs should be visible from top.

27. Like step 24, line up the wings of **PART 8** and **PART 9**.

28. Glue the edges of the wings together.

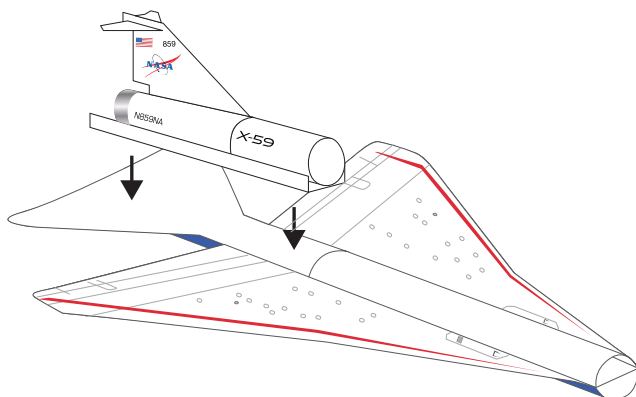

STEP  
10

29. Glue the two assemblies together.

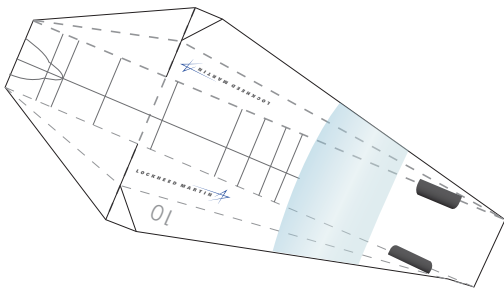

STEP  
11

30. Cut side slits and triangle shape on **PART 10**.
31. Score on the dotted lines and fold in on dotted lines to create a cockpit.
32. Tuck in sides to cover the open triangle shapes.

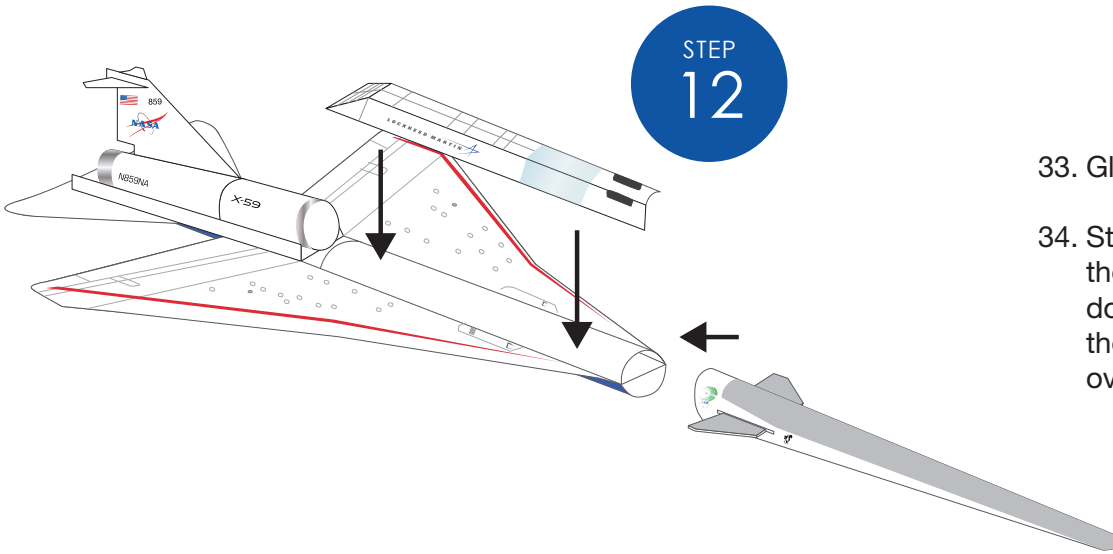

STEP  
12

33. Glue **PART 10** onto **PART 9**.
34. Stick the nose over the rest of the plane, and glue together. If it does not fit, bend in the body of the plane so that the nose will fit over it.

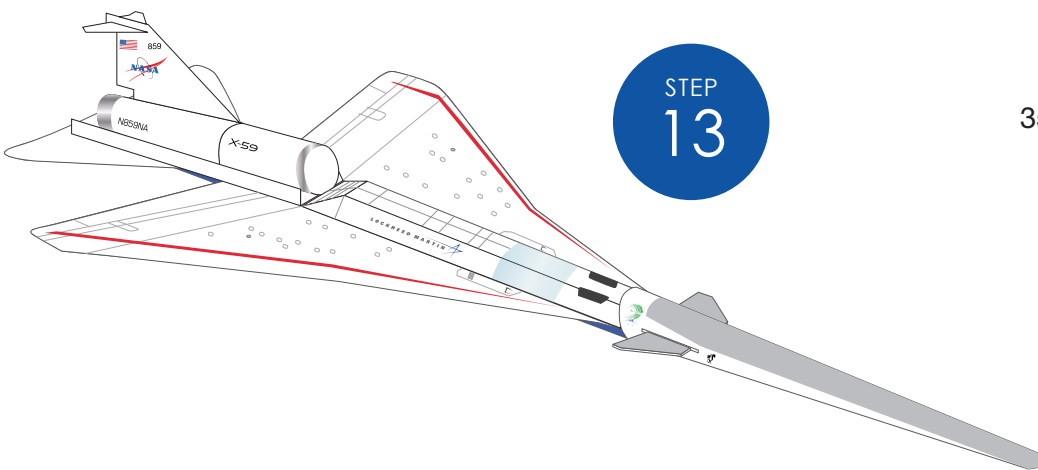

STEP  
13

35. Final assembled piece.



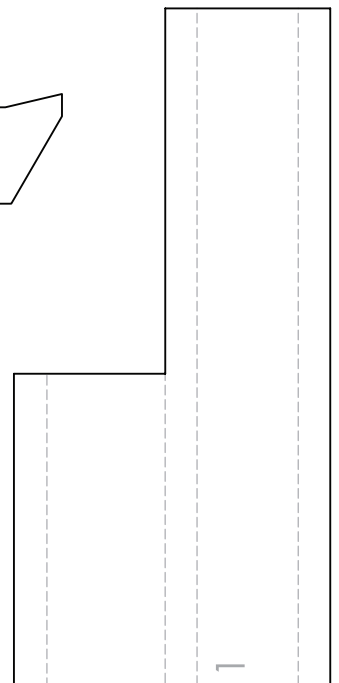
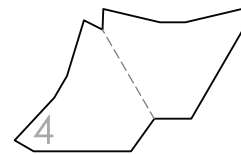
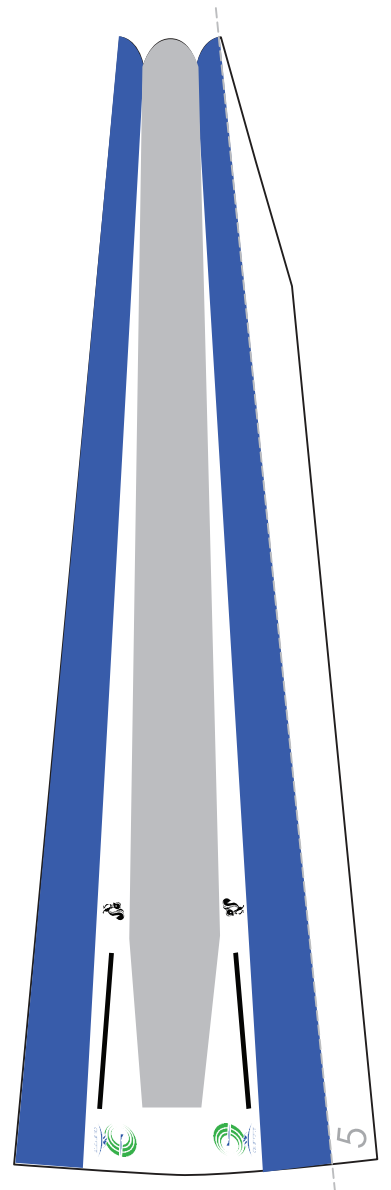
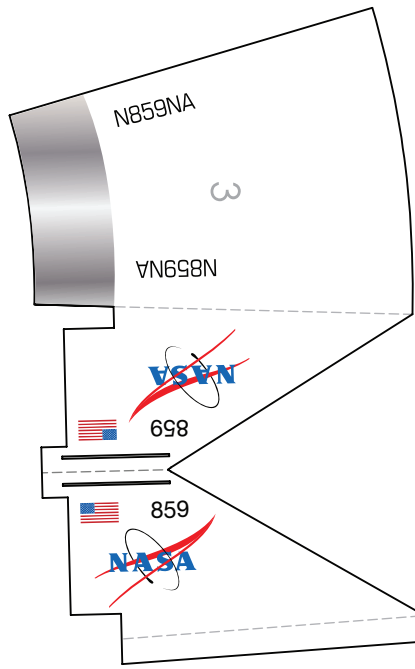
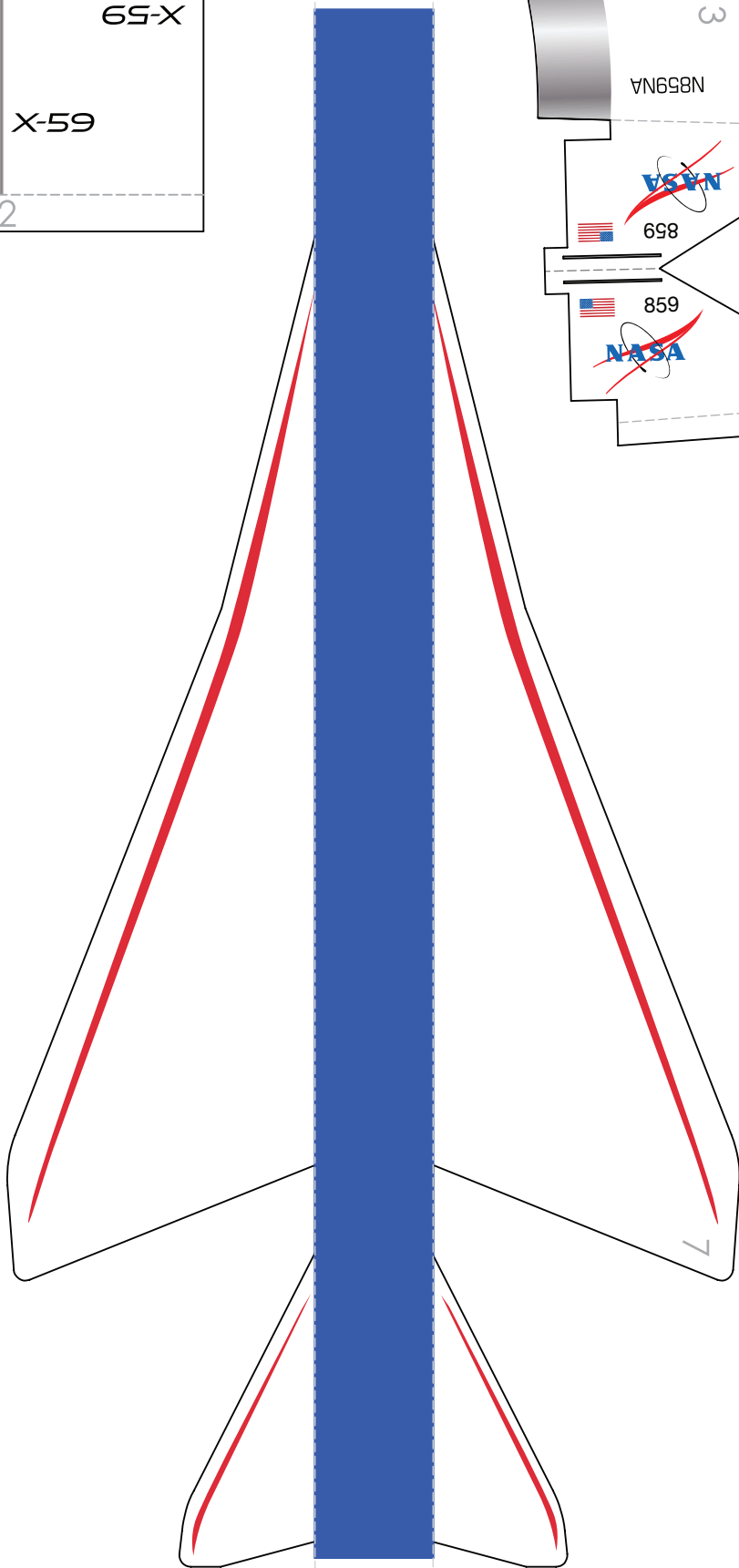
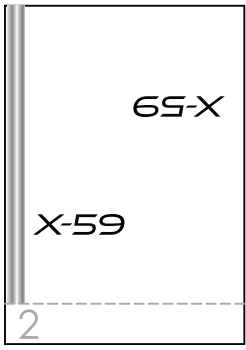

Page intentionally left blank



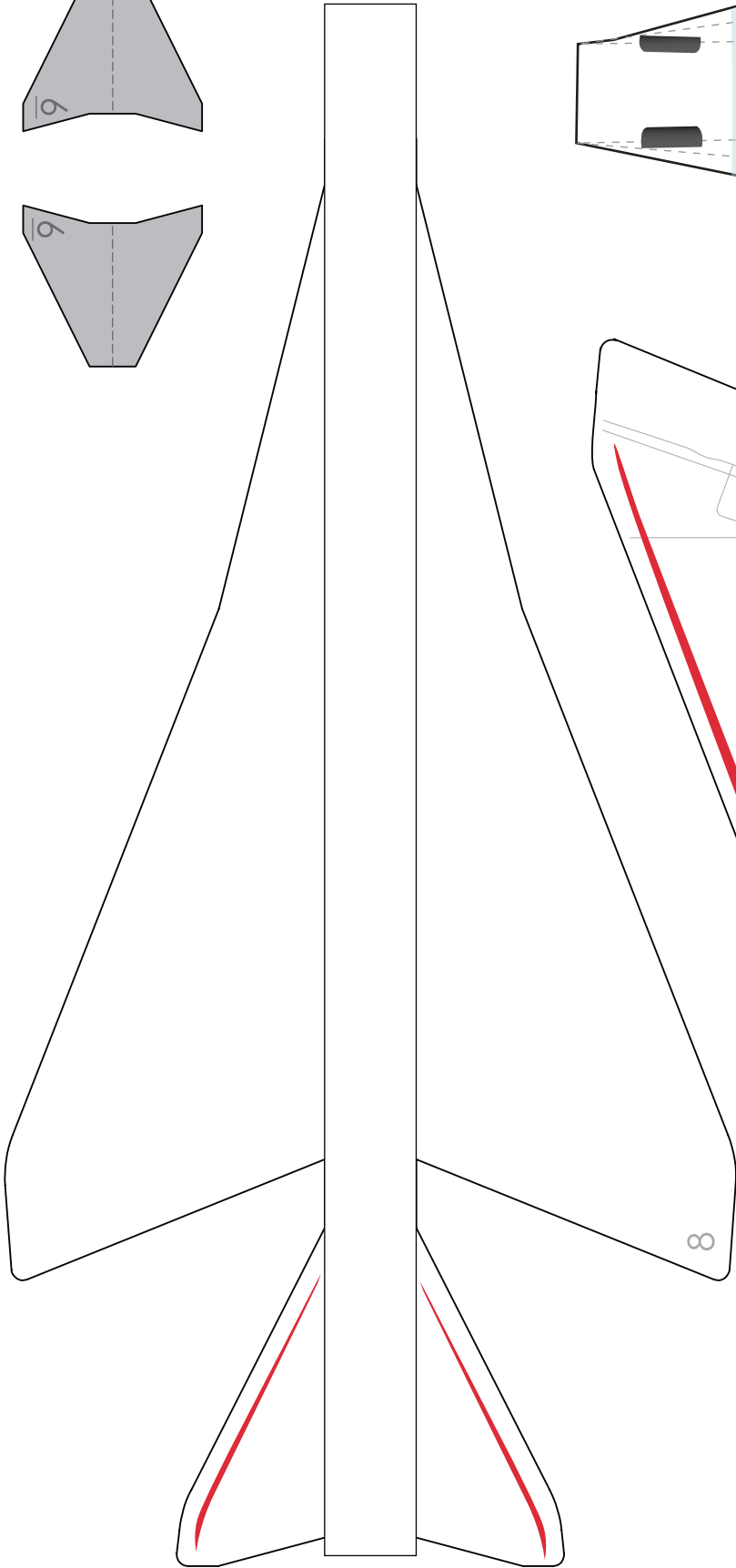
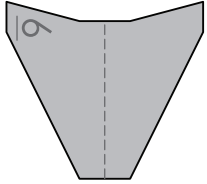
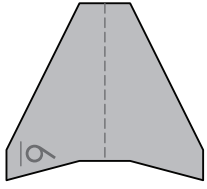
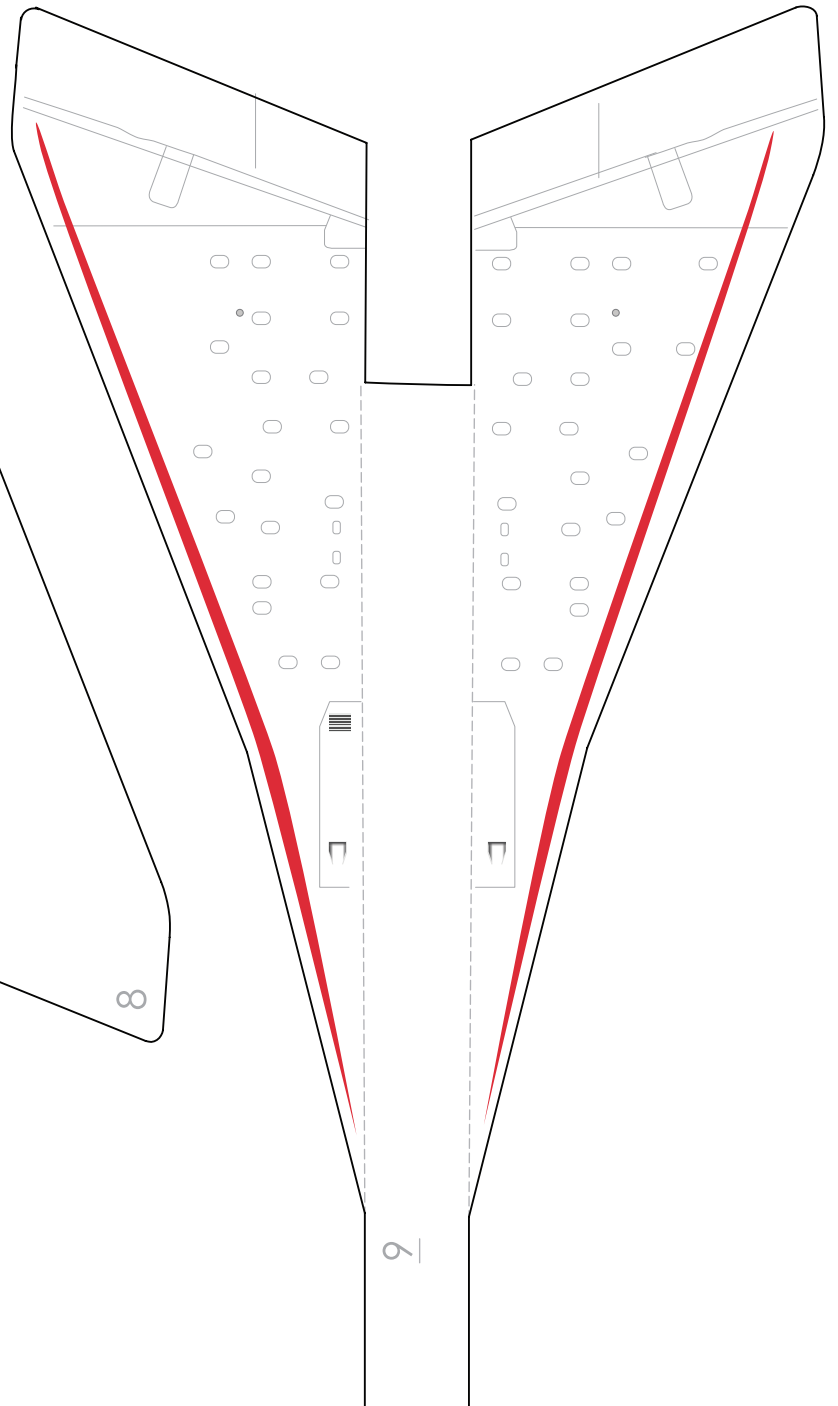
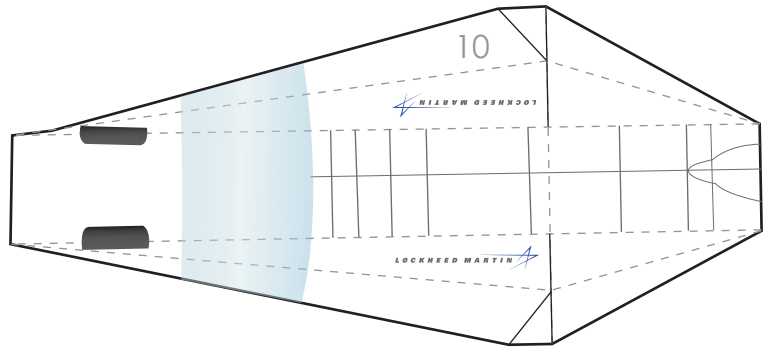

Page intentionally left blank





National Aeronautics and Space Administration

**Headquarters**

300 E. Street, SW

Washington, DC 20546

**[www.nasa.gov](http://www.nasa.gov)**