

First Ice Cores from Mars

A report from the NASA Mars Ice Core Working Group

February 2021

Working Group Members:

- Mary R. Albert, Dartmouth College (co-chair)
- Michelle Koutnik, University of Washington (co-chair)
- Seth Campbell, University of Maine
- Laurel Childress, Texas A&M University
- T.J. Fudge, University of Washington
- Jack Holt, University of Arizona
- Aaron Johnson, Carnegie Mellon
- Michael Mellon, Cornell University
- John Priscu, Montana State University
- Ted Schuur, Northern Arizona University
- Heidi Smith, Montana State University
- Michael Sori, Purdue University
- Kris Zacny, Honeybee Robotics

NASA Observers:

- Mitchell Schulte
- Catherine Walker

Recommended bibliographic citation:

Mars Ice Core Working Group (2021), *First Ice Cores from Mars*, co-chairs: M.R. Albert and M. Koutnik, 74 p. white paper.

Table of Contents

Executive Summary	3
I. Introduction	3
II. Ice cores from Earth	5
1. Background.....	5
2. Example past and future high-priority science questions for life (cryobiology) and climate on Earth	6
3. Evidence of life and climate within glacial ice	7
4. Ice core drill-site selection.....	12
5. Handling and preservation of ice cores on Earth for transport and storage	16
6. Initial measurements that can be made in the field on ice cores on Earth	20
7. Core allocation and measurements.....	21
III. Ice cores from Mars	24
1. High-priority science.....	24
2. Measurements on returned samples.....	37
3. Drill site selection and context to interpret ice core records	39
4. Initial measurements and on-site handling of the ice core	41
5. Criteria for preserving ice cores for transport and storage	42
IV. Ice core drill engineering on Earth and drilling concepts for Mars	44
V. Requirements from science for engineering an ice coring drill for Mars	52
1. Tradeoffs between optimal cores/science and drilling & logistical constraints	52
2. Characteristics of Martian ice cores and their potential to yield scientific results	52
3. Requirements of engineering to optimize the scientific return from ice coring in the mid-latitude of Mars.....	58
VI. Other enabling technologies for in-situ measurements on Mars	60
VII. Select relevant resources and organizations that may have related experience and technologies	61
VIII. Recommendations	62
References	65

Executive Summary

The NASA Mars Ice Core Working Group (NASA-MICWG) is an ad hoc interdisciplinary group of scientists and engineers who were invited by NASA Headquarters to collaborate on four primary tasks: 1) Define the key necessary characteristics of Martian ice cores crucial to support NASA’s research objectives, and relate those characteristics to anticipated research; 2) Describe the minimum attributes required to accomplish mission goals; 3) Provide examples of how similar ice cores are obtained and preserved by research teams on Earth; 4) Identify relevant organizations that may have experience and technologies to assist NASA in developing the needed requirements. The NASA-MICWG held virtual meetings and email discussions over a period of five weeks; this report articulates the findings. We found that the potential to significantly advance high-priority science will be optimized by retrieving a continuous ice core with associated borehole and probe measurements, but that further study would be required to determine whether chips instead of a continuous core should be collected. Requirements for drill engineering to optimize the scientific return of the core(s) are listed in the report. We also recommend that ground-based imaging of the subsurface should occur to confirm the optimal location before drilling commences.

I. Introduction

Subsurface ice sampling has been identified as the key science requirement by NASA planning for the first human mission to Mars. NASA envisions the endeavor to significantly advance two major, and not mutually exclusive, science research themes: the Search for Life and Understanding the Evolution of Mars Climate. In addition, understanding both the characteristics of the subsurface ice and the surrounding geology will supply essential context for the ice core, provide new geological understanding, and contribute to planning future in situ resource utilization (ISRU), where tapping the rich subsurface ice deposits will be a key enabler for larger, more sustained missions. The collection of perishable Mars ice core samples and complex nature of the protection, preservation, and return of ice cores will place significant demands on the mission concept, operational planning, and systems development. As such, it will provide a central focus for the mission architects as they trade various mission approaches and element designs and will evolve to be an important metric for NASA to use to compare and contrast competing mission design concepts. In December 2020, NASA invited a team of scientists and engineers to become the first Mars Ice Core Working Group, and asked the working group to identify potential scientific returns of ice cores from mid-latitude regions on Mars, and to translate the objective of meaningful ice cores into engineering requirements for mission designers.

Given assumptions that a mission to the Martian mid-latitudes would occur in the late 2030s with a short surface stay of ~30 days, and with two crew members on Mars and two crew in orbit, the Terms of Reference (ToR) requested the following from the Mars Ice Core Working Group:

- 1) Define the key necessary characteristics of Martian ice cores crucial to support NASA's research objectives. Relate those characteristics to anticipated research.
- 2) Describe the minimum attributes required to accomplish mission goals. Provide a range of attributes and requirements from which NASA can make an informed decision on mission scope, considering practical limitations of space flight missions such as technology and time. Provide scientific perspectives and information on activities relating to sample allocation; sample acquisition; ice core processing techniques; infrastructure; and archiving practices.
- 3) Provide examples of how similar ice cores are obtained and preserved by research teams on Earth, with an emphasis on how sites of interest are identified; how cores are taken; how they are preserved for transport; and what, if any, initial assessments are made in the field.
- 4) Identify relevant organizations that may have experience and technologies to assist NASA in developing the needed requirements.

The goal of this report is to provide high-level input to NASA on these four points in support of planning for the first ice cores from Mars. The scope of the report includes examples from terrestrial ice core science and the process of ice core drilling and analysis on Earth that are most informative to Mars, as well as identifying the requirements to meet high-priority Mars' science objectives. An interdisciplinary team of scientists and engineers was necessary for this task, and the contents include outcomes from approximately one month of discussion through remote meetings.

II. Ice cores from Earth

1. Background

Glaciers and ice sheets originate from snow that accumulates without experiencing significant melt over very long periods of time. This process results in a natural archive of meteoric ice that records local, regional, and/or global climate conditions. Water isotopes reflect variations in temperature and atmospheric pathways of the water vapor before it condensed as snowfall. Falling snow entrains dust, a variety of chemical species and microbes that provide evidence about surface conditions, atmospheric processes and how they have changed over time. Interstitial air in the firn eventually becomes trapped as bubbles in glacial ice, containing direct evidence of past atmospheric composition and associated biogeophysical processes on Earth. The layered nature of the ice is a direct result of the depositional process that originally formed the glacier or ice sheet, and it is this rich natural archive that has enabled the discoveries of ice core science.

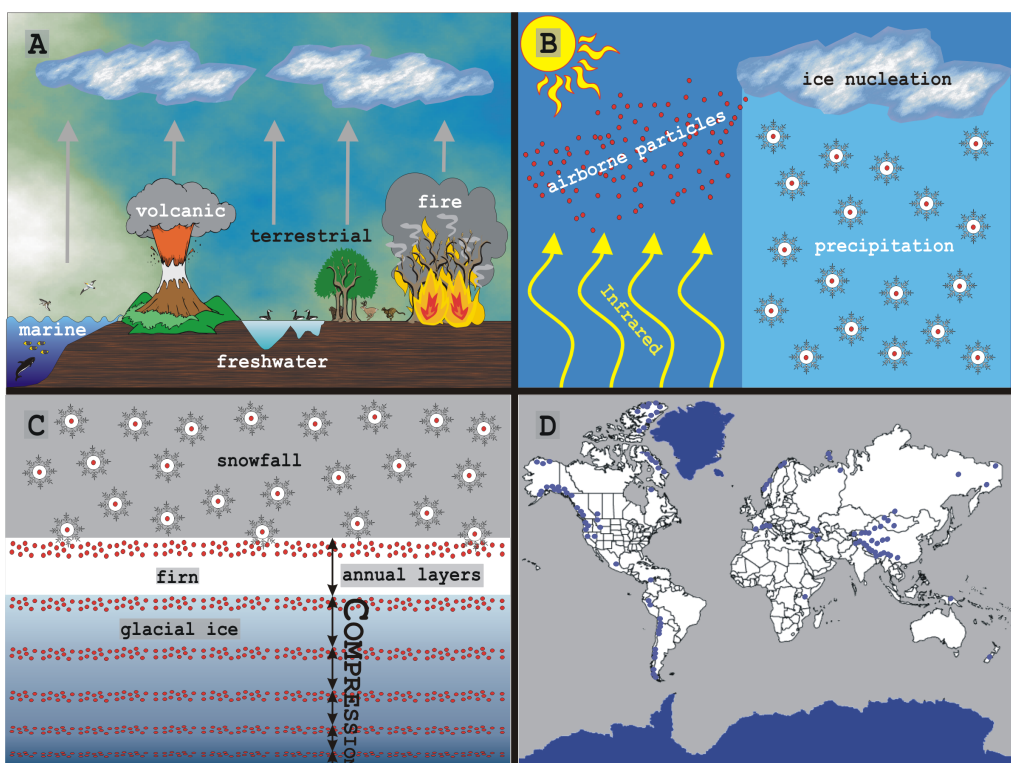
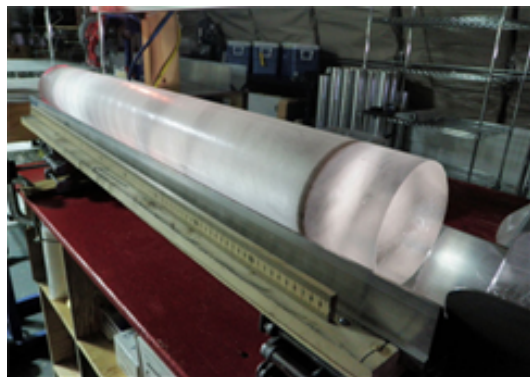

Figure II-1. From Priscu et al. (2007). History of entrapped particles in glacial ice and the present-day distribution of glaciers. (A) Schematic illustrating the range of source environments that contribute particles to the atmosphere. (B) Advective currents, created by solar generated infrared radiation, inject surface derived aerosols high in the atmosphere. Such aerosols (red dots) may serve as primary ice nuclei in clouds and are subsequently precipitated in snowfall or rain. (C) In geographical locations where the annual temperature remains cold enough that snowfall accumulates annually, particles from the atmosphere are archived in a chronological sequence in firn and glacial ice. (D) Global locations of present-day ice sheets and mountain glaciers (in blue). Each glacial environment is unique, as the nearest ecosystems that would most likely contribute the majority of airborne biological particles are very different. Distribution data based in part on *Satellite Image Atlas of Glaciers of the World* (USGS, 2002, *Satellite Image Atlas of Glaciers of the World*).



The stratigraphy of the ice resulting from the original depositional process of snowfall is evident even after the snow has been compacted into solid ice much deeper in the ice sheet, as seen in Figure II-2. The light layers resulted from different initial snow crystal types and the dark layer is ash from a major volcanic event.

Figure II-2. *An ice core from Antarctica showing layering including a volcanic ash layer (Photo: Heidi Roop).*

In other cold areas that do experience snow melt but where ice patches survive over long times, water on the surface of an ice patch adds mass upon refreezing. Very old patches of ice tens of meters deep may include bands of debris or deposited organic matter; these ice patches contain evidence of life, yet melt processes obscure much of the evidence of climate history within the ice (e.g., Chellman et al, 2021). Thus, understanding the many forms of evidence within a massive ice body depends on understanding the conditions under which the ice formed, compacted, and flowed. The search for clues about climate history that include associated evidence of life are most successful in locations where the original ice was deposited as snow and where ice sheet stratigraphy is preserved.

The scientific questions posed drive selection of the site to drill an ice core. In the following sections we provide examples of high-priority science drivers (Sections 2 and 3), describe how sites of interest are identified (Section 4), describe how cores are drilled and how ice core samples are preserved for transport (Section 5) and present initial assessments that may be made in the field (Section 6), as well as discuss aspects of ice core allocation and measurement strategies to maximize the use of ice cores on Earth (Section 7).

2. Example past and future high-priority science questions for life (cryobiology) and climate on Earth

Cryobiology: Twenty years ago Earth’s ice sheets were thought to be devoid of life. Recent discoveries of microbial life in the ice sheet and within subglacial lakes below the ice sheets has changed this view and shown that ice sheets and subglacial environments must be considered as part of Earth’s biosphere (Priscu and Christner 2004; Boetius et al., 2015; Hawkings et al. 2021). Recent studies in glacial ice have shown that bacterial densities, phylogenies, and organic matter signatures reflect past climatic history (Miteva et al. 2009; Santibáñez et al. 2016, 2018; D’Andrilli et al., 2017). In addition to the presence of microorganisms within the ice itself, recent research has revealed the presence of a genetically and metabolically diverse microbial ecosystem beneath the ice sheet (Christner et al. 2014; Vick-Majors et al. 2020). These subglacial ecosystems have been isolated from the surface for hundreds of thousands of years and are fueled by chemical energy and relict organic matter deposited by past marine incursions. Two primary driving questions

include: Are microbes reflective of depositional events? What post-depositional conditions support and maintain life in these entrapped icy habitats?

Climate: There are a multitude of questions regarding details of recent and past climate that drive the need to drill ice cores in specific locations. Ice cores have provided benchmark continuous climate records spanning hundreds of thousands of years and preserved discontinuous samples for at least several million years (e.g., Brook and Buizert, 2018). Paleoclimate records like ice cores reflect variations in solar radiation, especially those related to ice ages, and that are driven by Earth's orbital variations (Hays et al., 1976; Laskar et al., 2004). These Milankovitch cycles on Earth are controlled by eccentricity (~100ka and ~413ka cycles), obliquity (~41ka cycle), and precession (~19-23ka cycle).

Two unique properties of the massive polar ice sheets are critical to their utility: 1) the process of trapping air in bubbles in the near surface allows samples of the ancient atmosphere to be preserved for millions of years, and 2) the continuous deposition of centimeters or more of ice each year provides sufficient resolution to identify abrupt changes in climate. For example, high snow accumulation rates in Central Greenland motivated the world's first very high resolution, continuous, multi-proxy ice core evidence that, using records of ice stratigraphy, density, and isotopic and chemical records answered the question: how fast can climate change? The GISP2 ice core demonstrated that the local climate can change abruptly on timescales relevant to modern society and discovered that a 10 °C warming and doubling in accumulation rate could occur within a decade, which revolutionized climate science (Alley et al., 1993; Mayewski et al., 1993). The methane record further demonstrated that the abrupt changes were global in extent because the tropics are the primary methane source (Chappellaz et al., 1993). And the carbon dioxide records spanning multiple glacial cycles have provided an unequivocal record of global temperature-CO₂ coupling (Petit et al., 1999). An important question driving ice core climate science for the upcoming Hercules Dome ice core (Steig and Neff, 2018) is whether the West Antarctic Ice Sheet collapsed during the last interglacial period, and what the rate of collapse implies for future sea level rise. The answer to this question is critical for planning societal response to current climate change.

3. Evidence of life and climate within glacial ice

Cryobiology: The science of understanding the global importance of microorganisms immured in glacial ice on Earth is at an early stage. Recent research has shown that glacial ice contains an important temporal record of microorganisms on our planet that reveal biogeochemical processes and habitat types that occurred during past glacial and interglacial periods (Santibáñez et al. 2016, 2018). This record also contains important information on microbial evolution and physiology (Priscu et al. 2008). Work on the Vostok ice core has further shown the presence of diverse viral particles throughout the meteoric and accretion ice (Figure II-3 and II-4; Priscu et al., 2007). We now know that microorganisms and associated nonliving organic matter are present and may be metabolically active in virtually all ice core samples examined for biological properties. Paleoclimate studies have accurately dated layers within both the Antarctic and Greenland

Ice Sheets; investigating co-located evidence of life and climate provides an important stratigraphic timeline for these microbial ice repositories. In general, ice cores from non-polar locations have been found to contain larger numbers and species of cultivable bacteria than samples from polar ices. This spatial trend is presumably due to the closer proximity of terrestrial biological ecosystems and exposed landscape to these glacial environments, which provide a wide range of biological materials (i.e., insects, plant fragments, seeds, pollen grains, fungal spores and microorganisms) that create an influx of airborne biological particles that can become entrapped in the ice. Studies of bacteria from the permanent ice covers of lakes in Taylor Valley, showed that the organisms were closely associated with lithic particles, forming distinct ecosystems within the ice (Paerl and Priscu 1998; Priscu et al. 1998).

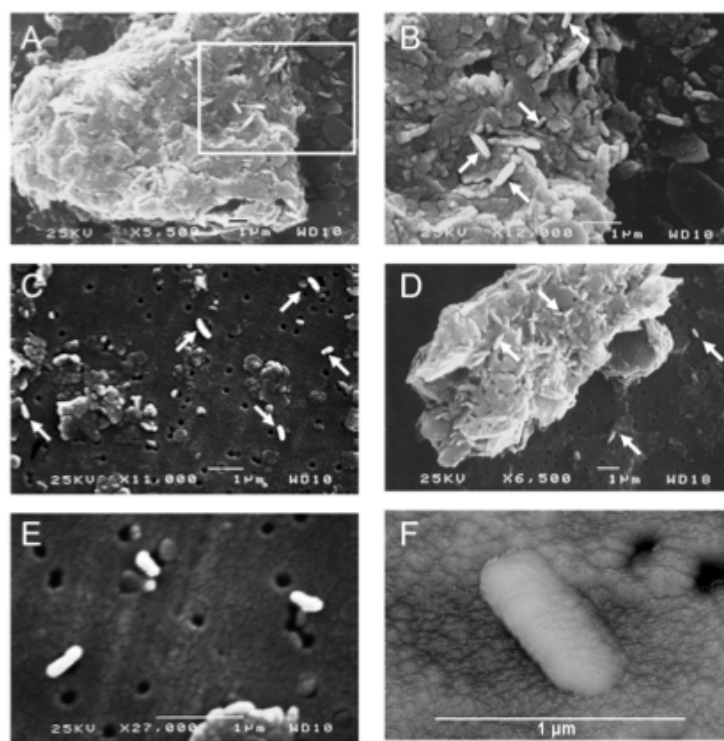

Figure II-3. From Priscu et al. (1999). Scanning electron (A-E) and atomic force (F) micrographs of particles within an ice core from Vostok accretion ice collected 3590 m beneath the surface. Arrows denote bacterial cells; Image "B" is a magnification of the area outlined in image "A".

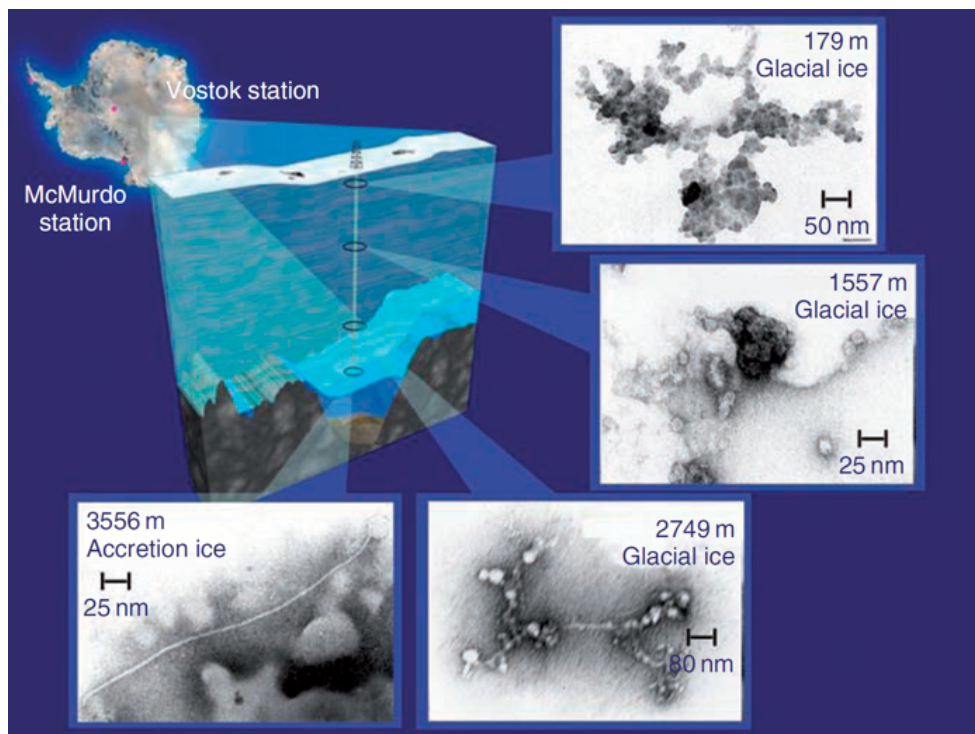

Figure II-4. From Priscu et al. (2007). Viral particles observed in the Vostok ice core from selected depths in the glacial and accretion ice. All images were obtained by transmission electron microscopy.

Highlights from these studies follow:

- **Prokaryotic cells and organic carbon:** The ice sheets of Greenland and Antarctica have been shown to contain a combined total of 4.4×10^{24} prokaryotic cells, which equates to 1.3×10^{-4} petagrams (Pg) of organic carbon. These cells represent a previously unrecognized carbon pool and approaches the values for bacterial carbon contained in all surface freshwater on our planet.
- **Dissolved organic matter:** The Greenland and Antarctic ice sheets have been estimated to contain about 10 Pg of dissolved organic matter. Microscopic analysis has revealed that most of the cells and dissolved matter are concentrated within triple junctions (veins) in the crystal matrix of the ice (Figure II-5). Vein volume in the Greenland and Antarctic ice sheets has been estimated to be 16.7 and 576 km³, respectively, representing habitable space which can support the metabolism of organisms that are capable of growing in cold, high ionic strength solutions with low pH (Barletta et al., 2012). In Antarctic near-surface environments, post-depositional organic matter processing has been demonstrated. Variations in organic matter composition between deep Antarctic ice cores have been shown to be correlated to specific microbial communities based on their metabolic capabilities; a concept of community evolution further supported by studies from Antarctic snow.
- **Fungi, bacteria, and viruses:** Ancient microorganisms provide an unexplored frontier for the study of microbial variability over at least eight glacial cycles (~1 million years) from the Greenland and Antarctic ice sheets. Phylogenetic diversity of microorganisms has been shown to vary across sampling locations and is generally

greater in Arctic vs. Antarctic cores, which is possibly attributed to differences in deposition rates resulting from spatial proximity to land masses.

- **Microorganisms attached to dust:** A positive correlation between dust and attached microorganisms in ice has been demonstrated from vertical ice profiles, which concluded that less dust and microbial species were deposited during warmer periods. While transport and deposition patterns of biotic and abiotic material onto ice sheets is the result of climate induced changes at the source, there is evidence for in-situ post-depositional microbial processing of organic resources.
- **DNA from microbes in ice:** Data collected from selected habitats on Earth shows that microbial cells can be revived after extended entrapment in geological materials and that DNA can remain viable for several million years in icy environments providing a repository for maintaining stable DNA (Prisco et al. 2007). Perhaps the most striking example of a microbial ice repository is the ancient ice collected from Beacon Valley, Antarctica. Bacteria immured in ice in the Beacon Valley, Antarctica, estimated to be ~8 million years old, were shown to incorporate radiolabeled substrates and many could be cultured in nutrient-enriched ice meltwater (Bidle et al. 2007). 16S rDNA-based community reconstruction suggested relatively low bacterial sequence diversity in the ice but metagenomic analyses of community DNA revealed many diverse orthologs to extant metabolic genes. DNA degradation in Beacon Valley ice indicated an exponential decline of community DNA size with a half-life of about 1 million years.

Collectively, these data show that ice cores represent “ice museums” containing novel records of evolution, habitat variability, and climate on our planet. Future ice-coring efforts that include a biological component will lead to new biological discoveries and provide a more comprehensive view of past conditions on Earth. Such information will benefit all sciences involved in deciphering the ice core record and will provide the necessary information in our search for life on other icy worlds. In order to understand life in ice we must understand the ice itself.

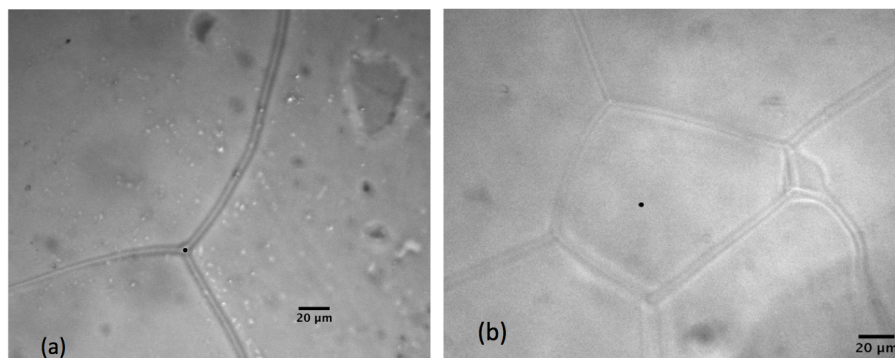

Figure II-5. Modified from Barletta et al. (2012). Triple junction from the GISP 2 core at a depth of 146.39 to 146.46 m (a) and from the Newall Glacier core at a depth of 7.75 to 7.774 m (b). Black dot represents the region of Raman laser focus. Micro-Raman spectroscopy was used to obtain the chemical composition of the liquid within the triple junction and the ice crystal itself. Note the high number of cells attached to lithic particles.

Climate: Ice cores from glaciers and ice sheets have played a critical role in transforming our understanding of past climate change from “what” happened, to “how” it happened. The temporal resolution of ice core records varies based on site characteristics including temperature and snow accumulation rate. Ice cores from low accumulation sites provide lower-resolution evidence of changes occurring over hundreds of thousands of years (e.g. Brook, 2013; Brook and Buizert, 2018).

Ice cores provide sequential records of environmental conditions, including:

- **Stable isotopes of water** have long enabled reconstruction of past temperature patterns.
- **Layer thickness and modeling of ice flow thinning** have enabled reconstruction of accumulation patterns. Patterns of atmospheric circulation can be inferred from multiple ice core records of temperature and precipitation.
- **Impurities** in the ice record non-local climate through their atmospheric transport and deposition with snow.
- **Methanosulfuric acid** can be linked to ocean conditions including open polynyas in ice cores from some high accumulation sites.
- **Dust** size and composition provide information on wind strength and transport pathways.
- **Black carbon and organic acids** provide evidence of biomass burning through forest fires.
- **Many additional proxies** indicate climate variations, ranging from wind strength to sea ice extent.
- **Gas** composition measurements from bubbles in ice cores have provided the foundational records of past greenhouse gas records, in particular carbon dioxide and methane, which have allowed quantification of the climate feedbacks associated with orbital cycles. These gases are globally well mixed and thus record processes largely unrelated to local climate conditions.
 - **Carbon dioxide** records have allowed determination of the iconic records of temperature and carbon dioxide co-varying for hundreds of thousands of years and have shown that the rate of anthropogenic emissions today exceeds the maximum rate from natural sources by an order of magnitude.
 - **Methane** records showing abrupt increases, coincident with temperature increases in Greenland, illustrate the global nature of abrupt climate change and provide the benchmark record that allows confident interpretation of other records, such as cave calcite oxygen isotope records.

Evidence within permafrost on Earth

Permanently frozen ground provides a rich environment that supports cryobiology. The distribution of ground ice in permafrost is heterogeneous, such that ice volume in a drill location can vary widely across 1–10 m scale, with locations of almost pure ice (wedges, frozen groundwater) interspersed with frozen sediment or soil material. Stratigraphic records from accumulated layered sediment records can provide information about past ecosystems and environment, including:

- **Organic matter:** Radiocarbon dating of organic matter within permafrost is used to indicate age.
- **Mineral grain size and composition** is used to indicate the origin of dust/loess layers in cases where the mineral composition of the source area is known.
- **Organic carbon, nitrogen, sulfur, and isotopes** characterizes the local biogeochemical environment.
- **Pollen** provides direct evidence of past vegetation communities.
- **Macrofossils** (testate amoebae, bones, teeth, insects) yield evidence of past local fauna.
- **Stable isotopes of water** indicate relative age with depth.

While permafrost yields information about cryobiology within its local habitat, the water that is in permafrost is a product of meltwater infiltration and thus permafrost cores have not been used with a primary goal of investigating past climate.

4. Ice core drill-site selection

Three critical tasks should be completed prior to and in conjunction with an ice drilling mission on Earth. These tasks include:

- 1) Site assessment and selection to assure the optimal drilling location based on mission objectives
- 2) Local to regional characterization of the study region to place any core or other sampling into the broader context
- 3) An assessment of borehole properties for comparison to the core and surrounding terrain observations

For ice core science objectives focused on cryobiology and climate, we describe traditional site selection on Earth along with their preferred assessments and considerations in this context. It is worth noting that, despite the fact that biology can help elucidate past climate conditions, the best site for assessing cryobiology from an ice core is not necessarily the best site for studying climate, and vice versa.

Preferred Ice Core Site Characteristics

Ice core site selection on Earth is initially focused on finding a location where ice that is the product of accumulated snowfall has experienced the least chemical and physical deformation or alteration since deposition. From a chemical perspective, this is traditionally considered to be locations where minimal surface melt and diffusion occurs. Surface melt and meltwater percolation through the snowpack and firn enhance diffusion of chemicals, thereby homogenizing the properties of interest which are used for climate reconstructions (e.g., Campbell et al., 2012). This requirement generally requires polar sites at high elevations or high northern or southern latitudes with low annual temperatures. It precludes low elevation or temperate glacier sites unless the annual snow accumulation is so high that it limits diffusion into deposition from previous years (e.g., Neff et al., 2012). One special scenario recently being considered on Earth includes elevations where some melting and refreezing occurs. In this scenario, the melt may cause some diffusion, however the ice lenses within snow and firn may diminish natural mixing

processes prior to pore close off, therefore retaining the original chemical structure. A second special scenario includes polar sites with low accumulation rates and temperatures. In this scenario, the natural compaction of snow to pore close off can occur over extended periods of time (>1000 years) resulting in significant chemical mixing due to open pore spaces; this yields a lower-resolution climate record such as from the Vostok and other ice cores from East Antarctica (e.g. Petit et al, 1999).

On Earth, ice deformation is critical to consider. We traditionally select sites to drill a vertical ice core near the highest elevations of an ice mass such as an ice divide or dome (e.g., Campbell et al., 2013a; Fischer et al., 2013). This choice is made because these sites have surface and bed conformable stratigraphy (with some exceptions such as wind-derived mega-dune formation), exhibit minimal horizontal deformation, and are dominated by vertical deformation. Each of these factors simplify local ice sheet evolution, which simplifies the ice-flow modeling required to interpret aspects of the ice core records, including to convert measured layer thicknesses to past accumulation rates by accounting for ice deformation. It must also be considered if the regional ice sheet geometry and basal flow conditions have been stable. It is reasonable to assume that the ice divide has been stable over the time represented by shallow ice cores. However, ice-divide migration, basal conditions, and the regional flow field must be considered at ice core sites with longer-term records, especially in Antarctica or Greenland. Additional assumptions and models that can account for more complex ice dynamics may be required to interpret ice core records at these sites that are not at a stable ice divide.

In areas where ice flows over terrain that brings very old layers up close to the surface, horizontal surface coring across an ablated blue ice region that exposes a sequence of exposed stratigraphy is a specialized target on Earth due to its easy access to potentially old ice (e.g., Kerhl et al., 2018; Spaulding et al., 2013; Petrenko et al., 2006). While access to significant stores of old ice is relatively easy at these sites, the history of ice deformation can make interpretation of the chemical and biological records more challenging.

Another site of ice coring includes lateral glacier margins where cores are retrieved in conjunction with subglacial bedrock access. Collection of subglacial samples can be used for cosmogenic nuclide analysis to determine the timing of when ice cover was present, marking past ice collapses or low stands (e.g., Spector et al., 2018).

Site Assessment Techniques

A range of techniques are used for ice core site selection including satellite and airborne remote sensing, geodetics, geophysics, and numerical modeling.

Satellite & Airborne Remote Sensing: The combination of satellite, airborne, and terrestrial-derived elevation and velocity fields provide large to local scale surveys, respectively, of Earth's ice masses to locate potential domes, flow boundaries, divides, blue ice areas, lateral margins, or other potential coring targets (for example, in searching for a site to drill for the oldest ice in East Antarctica; Young et al., 2017). Remote sensing also provides observations of debris cover, stratigraphic unconformities exposed at the surface, flow banding, surface fracturing, and lateral geomorphological features (or lack thereof for each of these characteristics). These are qualitative and quantitative measures of the

deformation field and history, mass balance, and stability, all useful for historical context of ice flow and ice sheet boundary conditions. Airborne radar sounding in the 60 to 600 MHz range is frequently used in Antarctica to map horizontal and vertical stratigraphic continuity, extrapolate age-depth relationships from existing ice core sites, and to detect basal melt/accretion at the tens to hundreds of kilometer scale, typically collected as gridded data sets.

Ground-Based Observations: Ground Penetrating Radar (GPR) between 1–900 MHz range is often used to map local scale (1–100 km) distances, in smaller or confined spaces where airborne radar is not possible (e.g., Campbell et al., 2013a), or along lateral margins in high vertical resolution to characterize stratigraphic continuity and refine specific coring sites from preliminary sites selected via more regional assessments (e.g., Schroeder et al., 2020; example of radar-layer evaluation in Figure II-6). Concurrently, installation of temporary GPS units in a grid provides higher-spatial and temporal resolution deformation fields than airborne or satellite methods, useful for future flow modeling as well as precision core site selection.

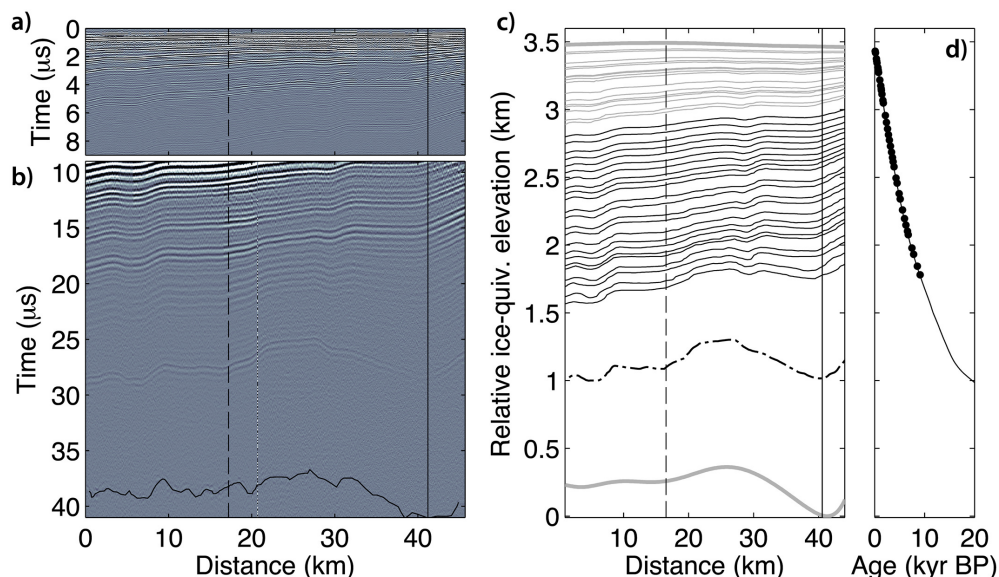

Figure II-6. From Koutnik et al. (2016). a) Segment of a 7 MHz radar echogram of the upper few hundred meters of the West Antarctic ice sheet. b) Segment of a 1 MHz radar echogram. (c) Traced layers from 7 MHz data (gray layers) and the 1 MHz data (black layers) and the smoothed bed topography (solid gray line). The deepest imaged layer (black dash-dot) is known as “Old Faithful”, with an age ~17,650 kyr B.P. The dashed vertical line is the modern ice-divide position, and the solid vertical line is the WAIS Divide core site. (d) All 39 radar-traced layers were dated using the WD2014 timescale. Elevation is relative to the deepest bed value set at zero, and elevations above the bed are in kilometers of ice-equivalent values.

Autonomous Phase Sensitive Radar (ApRES) is an instrument (Nicholls et al., 2015) that provides vertical deformation measurements at the millimeter scale. These are new data and can be used to measure vertical velocity in the ice sheet interior and improve ice-flow models (e.g., Kingslake et al., 2016). Recent use of terrestrial interferometry at the 1-10 km range, as well as at the centimeter scale around ice core sites, can provide local

observations of horizontal deformation that can be used together with ApRES measurements of vertical deformation.

Where it is relevant, geological and geomorphological observations are often collected near core sites in addition to on-ice observations. At core sites near bedrock exposures, nunataks, and lateral or terminal margins, geological and geomorphological mapping of moraines, erratics, sediment, lithic or clast deposits, coupled with cosmogenic nuclide dating (e.g., beryllium-10), carbon-14, or other chemical techniques provide historical context of ice surface elevation change, flow pathways via interpretations of deposit provenance, and erosion history via micro-to-macro-scale sediment-to-clast analysis. Assessment of overburden structure, overburden and ice mixing, or unconformities within the overburden and sub-burden ice provide evidence of shearing (or potential advance deposition), repeated stages of advance and retreat, or surface elevation changes over time. In areas devoid of bedrock exposures, lithic or sediment analyses within core samples, such as tephra or dust horizons also provide critical information such as absolute ages and atmospheric circulation processes, particularly if provenance can be determined.

In addition, shallow core sampling is often completed in snow, firn, and ice, prior to deep drilling campaigns in order to estimate the retention of chemical signatures and to estimate a baseline of current atmospheric properties. Accumulation or ablation rate may also be estimated if relative or absolute chemical markers are present within the samples that can be used as temporal constraints.

Numerical Modeling: Glaciological modeling, which includes applying thermal and mechanical ice-flow models, is a critical component of ice core site selection and ice core interpretation on Earth. The chronology and preservation of the ice depends on details of ice flow and deformation, basal temperature, and ice sheet and climate history. While the vertical velocity field, basal boundary conditions, and past ice sheet geometry and climate conditions are poorly known, ground-based and airborne radar data can provide valuable constraints. Numerical models of varying complexity rely on geophysical observations of bed topography (and ice thickness), and may also assimilate englacial stratigraphy, borehole temperature measurements, ice fabric and microstructure observations, and available constraints on ice deformation and ice physical properties in reconstructing ice evolution (e.g., Licciulli et al., 2020, Kerhl et al., 2018; Koutnik et al., 2016; Waddington et al., 2007; Hindmarsh et al., 2006). Models provide spatial and temporal information about ice temperature, ice flow, and ice age. Models are necessary to extrapolate the age scale to the bottom of the ice sheet for the deep ice cores.

Permafrost and Massive Ice Deposits

In addition to glaciological ice coring, ice-rich permafrost or massive ice deposits beneath and within sediment have been studied as potential paleoclimate or paleo-environmental records on Earth (e.g. Van Huissteden et al., 2003; Schirmer et al., 2001). However, permafrost structure is a less straightforward environment because deposits can be vertically or horizontally stratified depending on environmental and geological conditions and ice content within sediment can vary widely depending on water sources, subsurface pore space, and atmospheric thermal fluctuations. Interpretations of ice relative to

subsurface water or stratified sedimentary deposits generally relies on phase responses, comparisons in scattering, and surface evidence of permafrost or such as ice wedge polygons. Massive ice units can nearly replace subsurface sediments over time through water flow and successive refreezing events (e.g. Campbell et al., 2018). Massive ice provides clearly visible GPR targets within subsurface sediments due to less scattering relative to sediments. Near-surface permafrost or massive ice are most commonly imaged with 100-400 MHz GPR frequencies and penetration depth is limited by highly attenuative sediments relative to ice (e.g. Campbell et al., 2021).

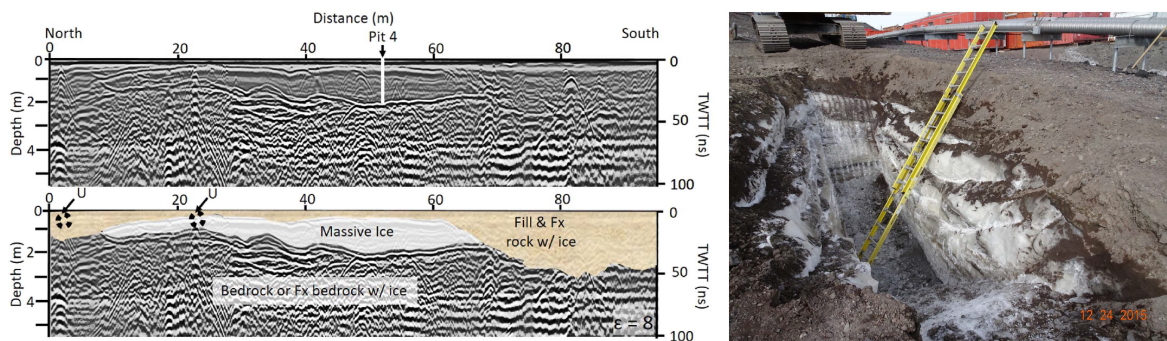

Figure II-7. From Campbell et al. (2018). Left: 200 MHz GPR profile (top) and interpretation (bottom) of a massive ice feature. Note the clear and speckle-free massive ice relative to the surrounding geology and buried utilities (U). Right: photo of excavated massive ice displaced within GPR profile.

5. Handling and preservation of ice cores on Earth for transport and storage

Handling of ice core segments retrieved from drilling operations is a manual operation requiring great care. Methods to ensure that the ice cores resist cracking and are kept free from contamination during the handling have been developed, and drill teams are trained in the procedures.

Drilling operations should use clean techniques (e.g., sterile drill, clean clothing) to obtain intact core with little occurrence of microfracture. Once extracted, care must be taken to ensure that the ice cores are properly preserved in order to ensure accurate scientific measurements. The primary concerns for the integrity of the ice core are contamination, melt loss, fracture, release of trapped gasses, grain evolution via vapor diffusion, and chemical or biological changes. In addition, the handling of the cores must take into account transportation and logistics at every stage in the recovery process. Souney et al. (2014) documented the core handling and processing procedures for the WAIS Divide ice core.

Certain ice cores require more involved handling procedures. For ice cores to be analyzed for particularly diffusive gases, such as He, samples are cut in the field and placed in vacuum sealed containers. Samples may also need to be shielded from radiation, such as ^{14}C of CO or CO₂. Ensuring that the cores are stored at a cold enough temperature is one key consideration. Cores are typically stored at or below -20 °C, with the NSF Ice Core Facility long term storage at -36 °C. This sub-freezing temperature is needed in order to minimize

melt loss, gas diffusion, chemical and biological reactions, as well as to create a buffer below freezing to protect the core if briefly exposed to warmer temperatures. In addition to ensuring a low temperature, it is important to minimize the change in core temperature in order to avoid fractures that can disrupt the sample and let in contamination.



Figure II-8. *West Antarctic Ice Sheet (WAIS) Divide drill site. Left: On site freezer units that keep ice at -26C. Right: Core sections in core trays, where the core diameter is 122 mm (4.8 inches).*

Logistics challenges exist in maintaining boxes of ice cores at constant low temperature from the time of drilling in the field to transport via air, sea, and land to the final storage location. Instances of ice cores experiencing too-warm conditions have occurred. Even if melting doesn't occur, the movement of ice via vapor exchange can impact the stratigraphy of the core and prevent robust interpretation.



Figure II-9. *Left: Cores wrapped for transport to keep at consistently cold temperature. Right: Cores at the NSF Ice Core Facility (Photo: Peter Rejcek).*

Methods of decontamination of ice cores on Earth

Core contamination can come from the mission itself, drilling technology, handling ice cores in the field, in transit, and in the laboratory. Contaminant sources include the environment (e.g., collection, laboratory personnel, tools, reagents, and air) during the processing of ice including ice sampling, concentrating cells, and DNA extraction and sequencing. Except at core breaks, contamination is generally confined to the outer regions of the core with the potential for contamination decreasing toward the center. Consequently, sampling from the inner portions of the core provides the cleanest ice.

Experiments to address biological contamination on cores of Vostok meteoric and accretion ice obtained using hydrocarbon drilling fluid showed that the outer portion of the core had up to three orders of magnitude greater bacterial density as the inner portion of the core (Christner et al. 2005). The extreme gradients that exist between the outer and inner portion of the cores makes contamination a very relevant aspect of geobiological investigations of ice cores, particularly when the actual numbers of bacterial cells are low. Although various protocols to eliminate microbial contamination have been developed in a number of laboratories, proving that a positive result is not an artifact is very difficult. To address this issue and the inherent concern it raises for the integrity of future microbiological investigations, a method to monitor decontamination procedures for biological work with ice cores was developed where each core is contaminated by “painting” the outer surface with a known bacterial species, a target DNA sequence, and a fluorescent molecule (Table II-1).

Table II-1. Tracers used for monitoring ice core sampling. From Christner et al. (2005).

Tracer	Specifics	[applied]	Rationale	Detection limit
Cell	<i>Serratia marcescens</i>	5 x 10 ⁷ cells	~10 ⁵ cells/ml observed on core exteriors	1 cfu/ml
Macromolecule	4.3kb DNA plasmid: pTOPO-ITS- <i>Naegleria</i> ^a Mol. wt. ~2.6 x 10 ⁶	1 ng (2.2 x 10 ⁸ molecules)	If ~10 ⁵ cells/ml on exterior, 10 ⁵ -10 ⁶ rDNA copies	500 molecules/ml/round of PCR (Theoretical)
Molecule	Rhodamine 6G: Mol wt. 479.0	0.1 ml of 1000 ppm rhodamine 6G solution	DOC values 2 log higher on core exterior, so use 3 log detection sensitivity for dye	0.5 ppb rhodamine 6G

^aPlasmid DNA is pCRII-TOPO vector (Invitrogen) containing ~400 nucleotide cloned DNA insert (Pélandakis et al. 2000) that would not be expected to be present in the sample. cfu = colony forming units of *S. marcescens* on defined media.

Following this intentional contamination, the outer 1 cm from the core was aseptically removed by physical scraping in a particle free environment (class 100 clean room or better) followed by washing with ethanol and sterile, particle-free deionized water. Results from these experiments have demonstrated that most cores are contamination free once at least 1 cm of the ice radius is removed (Figure II-11). These decontamination protocols provide a direct method to verify the authenticity of results obtained and eliminate core samples that fail to pass our monitoring procedure.

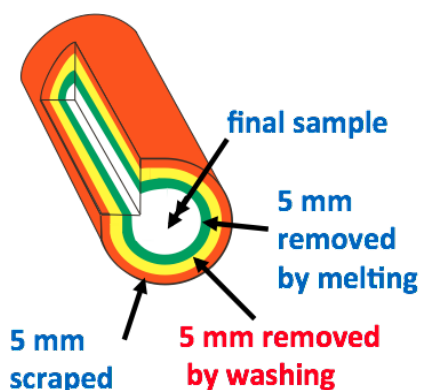

Figure II-10. From Christner et al. (2005). Schematic illustrating the removal of ice core veneers during each step of the decontamination procedure. This includes that 5 mm is scraped, then 5 mm was removed by washing, and then 5 mm was removed by melting.

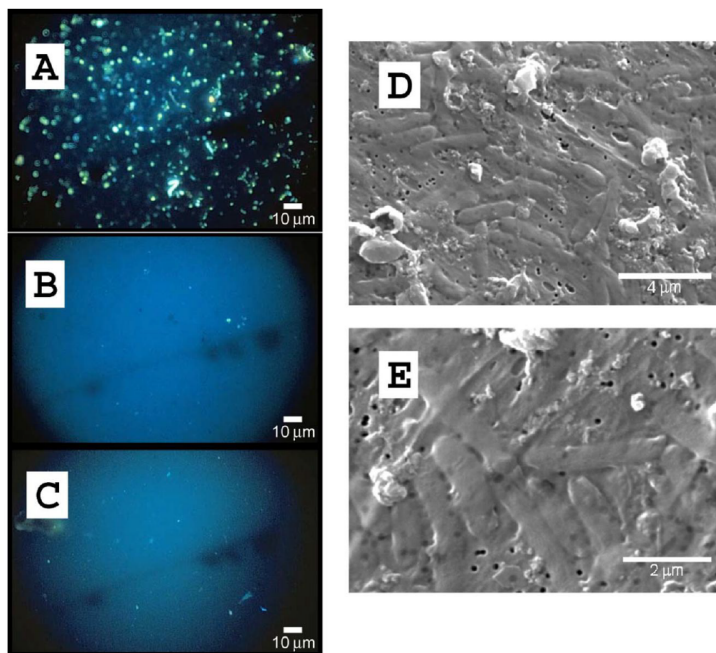

Figure II-11. From Christner et al. (2005). All images are from a Vostok meteoric ice core collected 1577 m below the surface. Epifluorescence images of DNA-containing prokaryotic cells (gold dots) in successive samples collected from the outer 0.47 cm (A) and after 0.57 cm (B) and 0.82 cm (C) of the original core radius was removed from the ice core. Scanning electron micrographs of bacterial contaminants on the outer portion of the core showing extensive contamination by large rod-shaped cells (D, E). All images are from a Vostok meteoric ice core collected 1577 m below the surface.

Sampling of the inner portions of an ice core can also be achieved along with chemical analysis when high resolution measurements are obtained using a closed, continuously melting system to measure geochemistry and particle abundance (e.g., McConnell et al. 2002); see Section 7. These systems typically consist of a titanium or ceramic concentric melting head that differentially melts selected portions of a core section and directs the

melt to various analytical instruments. Such melting systems have been used successfully to resolve small time-scale measurements of gases, black carbon, a host of geochemical constituents, dissolved organic carbon and bacteria. Measurements on the inner portions of the core minimizes contamination and allows a wide variety of measurements to be made on a relatively small sample.

6. Initial measurements that can be made in the field on ice cores on Earth

Measurements on the cores

As ice cores are removed from the drill, measurements of core density, length, diameter, and notes on condition of the core are manually recorded before the cores are put into sleeves or tubes to be packed in boxes for transport.

Borehole measurements

Initial signatures of organic matter within the borehole can be made using deep-UV spectroscopy of the borehole sidewalls. Deep-UV techniques have been demonstrated to distinguish microbes in situ in non-ice environments based on their fluorescence spectra, and field deep-UV fluorescence instruments have been deployed to study deep marine biospheres, successfully detecting microbe-like signatures (Eschelmann et al. 2019). This technology forms the basis for the SHERLOC instrument on the Mars 2020 rover. Deep-UV spectrometers have recently been incorporated into an ice coring drill to make high resolution spatial measurements in a borehole at Summit Station, Greenland (Malaska et al. 2020; Figure II-12).

The deep-UV/drill system revealed diverse spectral signatures in the Summit borehole. Most hotspots were less than 20 mm in diameter and were clearly isolated from other hotspots. The spectral signatures were consistent with organic matter fluorescence from microbes, lignins, fused-ring aromatic molecules, including polycyclic aromatic hydrocarbons, and biologically derived materials such as fulvic acids.

Additional borehole measurements include core imaging and borehole televiewing/optical stratigraphy ensures that the proper stratigraphy of the core is preserved, and serves as backup stratigraphic data. Borehole temperature measurements provide temperature estimates at different depths, including near the bed, which can help to constrain the heat flux entering the base of the ice and the rate of basal-ice melting.

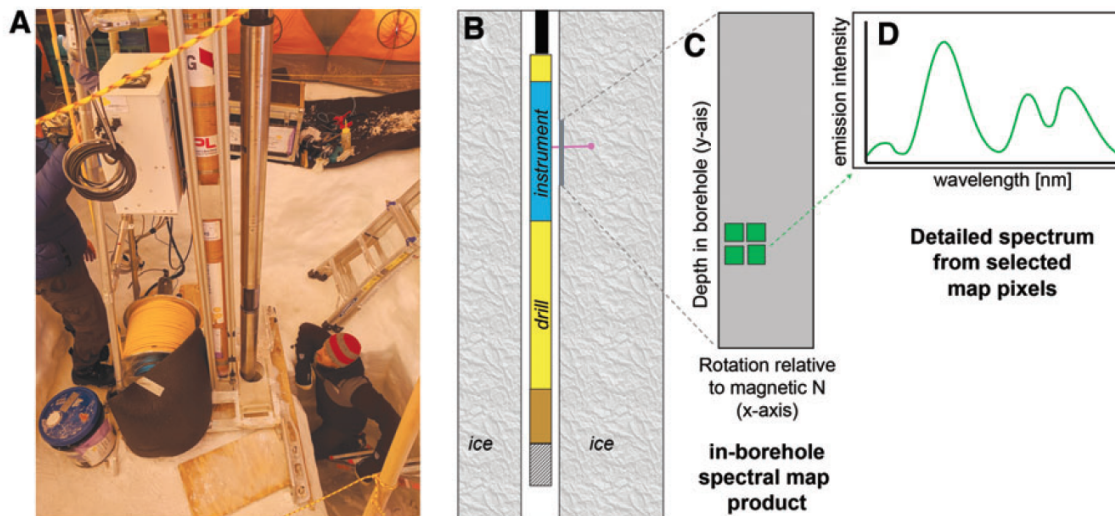

Figure II-12. From Malaska et al. (2020). Image and schematic of operations showing in-borehole operation and data flow. (A) Image of WATSON drill instrument in drill tent at Summit Station, Greenland. The upright silver tube at the center is the WATSON instrument. Optical window at lower center in image. The rest of the drill is inside the borehole at lower center in image. (B) Cutaway schematic showing drill-instrument combination in the ice borehole. The WATSON instrument is indicated by a blue rectangle in the schematic. The laser illumination (not to scale) is indicated as a purple beam penetrating into ice and hitting a target. During a point cloud measurement, the instrument is moved vertically as the laser is illuminated along the length of the borehole. During a map, the instrument is stationary, and the laser beam is moved by a series of internal windows to build up a raster map product. (C) Graphic of a map product showing a portion of the borehole. Green squares indicate pixels of interest. (D) Cartoon simulating a spectral response extracted from one of the map pixels.

7. Core allocation and measurements

Once the ice core is in the laboratory, it is cut into meter-long sticks of ice that are sent to various laboratories for measurements. Figure II-13 shows the cut plan for the WAIS Divide ice core and the South Pole Ice Core.

For multi-investigator group projects on Earth, the division of ice core samples is carefully coordinated among project participants to achieve an efficient use of the limited ice. A significant portion of the core is reserved as an archive to allow investigations in the future when new techniques are available and new questions arise. The face between the top and bottom slabs is used for optical and electrical imaging of the core. The top slab is used primarily for continuous sticks for chemistry, water isotopes and dissolved and particulate organic matter that will be melted as part of Continuous Flow Analysis systems (CFA), and these analysis streams are described in Figure II-14. The gases and physical properties pieces from the lower slab are cut into discrete pieces. These samples typically range in length from 5 cm to 20 cm depending on the measurement, and are sampled from every few meters to each meter based on the depth-age relationship to yield a desired temporal frequency.

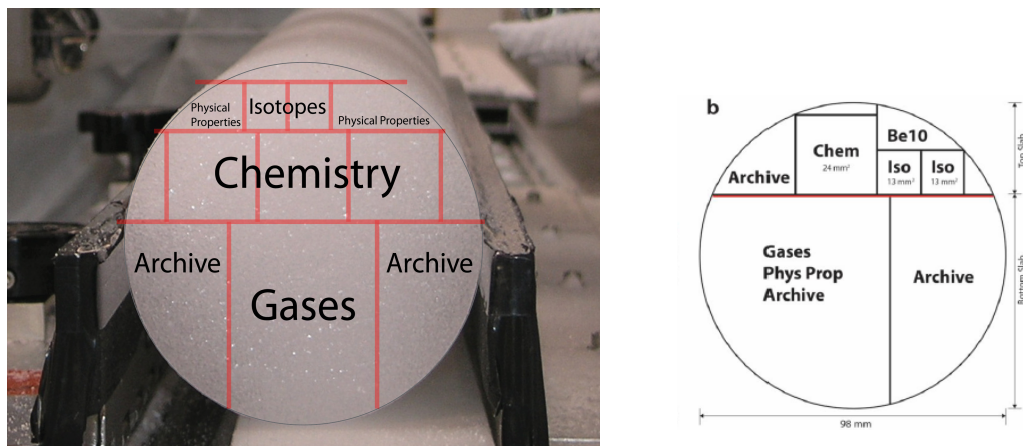

Figure II-13. a) Cut plan for the WAIS Divide ice core with a core diameter of 12.2 cm (Credit: Joe Souney). b) From Souney et al. (2014). Cut plan for the South Pole Ice Core with a core diameter of 9.8 cm. For the SP ice core, the sticks cut from the top slab are for continuous flow measurements. The Gases/Phys Prop portion is cut into discrete pieces, typically 5 to 20 m in length.

In ice core projects where smaller-diameter cores (~ 3”) are drilled for a single investigator or small team, sticks of core are not always available to be archived. In some cases much of the core is processed using one CFA device to yield a range of chemical and isotopic measurements that ensures co-located measurements. In this case the resulting CFA data is coordinated between the investigators for data interpretation, rather than sending sticks of the original core to separate labs for measurements.

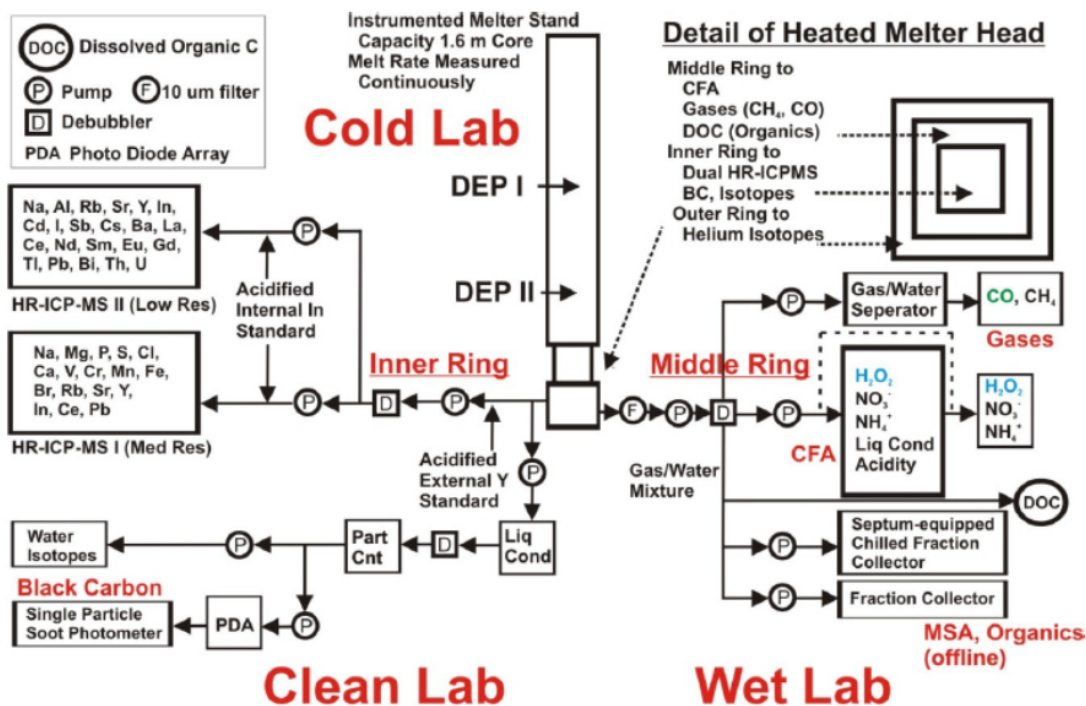

Figure II-14. From McConnell et al. (2017). Example of an ice core Continuous Flow Analysis system.

Continuous flow analysis is an efficient technique for making multiple chemical and isotopic measurements on a stick of ice. CFA refers to measurements where sticks of ice are melted at a constant rate, providing a steady stream of water and air for instruments. CFA typically requires what we have termed “continuous” ice because each break or penetrating fracture needs to be individually cleaned and thus cores with lots of breaks and fractures are more easily analyzed as discrete samples. Many different parameters, such as the elemental composition, dust and black carbon counts, bacteria, and atmospheric methane, can be analyzed as shown in the diagram below. This allows high depth resolution of the measurements and reduces the ice loss from cutting individual samples. Additionally, discrete samples of water can be stored for use by others. On typical Earth ice core projects, the chemistry and water isotopes are measured on separate CFA systems because the flow rate cannot be optimized for both.

III. Ice cores from Mars

1. High-priority science

High-amplitude obliquity variations on a planet with relatively simple climate dynamics make Mars an ideal laboratory from which to learn about the relationship between planetary climate and orbital cycles. Mars is also a high-priority environment in the search for evidence of life beyond Earth, one of the highest priority goals in planetary exploration. Understanding the fundamental processes of Mars' climate is a necessary step toward understanding the nature and temporal evolution of habitable space on Mars and if extinct and/or extant life is present. While it is understood that variations in Mars' orbit and obliquity drive changes in Mars' climate (e.g., Laskar et al., 2002), fundamental questions remain about past climate conditions and how mid-latitude ice was deposited, modified, and buried. Water ice is currently unstable on the surface in the mid-latitudes, but a cover of permafrost, regolith, dust and/or debris maintains the stability of water ice in many subsurface locations.

The geographic distribution of subsurface ice-rich deposits in the mid-latitudes of Mars has been mapped using multiple datasets and with numerous methods. For example, the Mars Odyssey Neutron Spectrometer (MONS) instrument measured the concentration of hydrogen in the top few centimeters of the ice table, found at depths less than 1 m, and high concentrations are found in the higher latitudes (e.g., Boynton et al., 2002; Diez et al., 2008; Pathare et al., 2018). SHallow RADar (SHARAD) soundings from the Mars Reconnaissance Orbiter (MRO) have been used to constrain the ice content of lobate debris aprons to be >80% ice (Holt et al., 2008; Petersen et al., 2018), and an inventory of such features indicates an equivalent global ice layer of up to 2.6 m (Levy et al., 2014). Radar observations in combination with high-resolution imagery has also identified significant stores of buried massive ice in the northern plains (e.g., Bramson et al., 2015; Stuurman et al., 2016). In select locations between 45–70° S and 45–65° N, vertical scarps directly expose water ice deposits up to ~100 m thick just below the surface (Dundas et al., 2018; Dundas et al., 2021; Figure III-10). Monitoring with the High Resolution Imaging Science Experiment (HiRISE) camera has detected numerous small, fresh craters – newly formed during the lifetime of MRO – that directly excavate and expose shallow ice (Byrne et al., 2009; Dundas et al., 2014; Dundas et al., 2021). In addition to local investigations, detailed regional “ice consistency maps” of the Northern Hemisphere of Mars were recently produced by the Mars Subsurface Water Ice Mapping (SWIM) project (e.g., Morgan et al., 2021; Figure III-1). These maps show which locations are most likely to have shallow subsurface ice based on how many different datasets (e.g., thermal, radar) are consistent with an icy interpretation at that location. Existing data make a compelling case for ice stores within the upper few meters below the surface and extending tens to hundreds of meters below the surface at many mid-latitude locations, but they do not resolve ~5–20 meters below the surface. New data that constrain the upper tens of meters below the subsurface and provide constraints on where ice is located in the shallowest subsurface, the depth to the ice, and the thickness of the ice deposit where it is shallow enough will be valuable to an ice coring mission. This report assumes that prior to the ice core mission, a different mission will have returned the highest resolution possible radar images of the top

20 meters of potential ice coring areas to inform drill site selection and to aid interpretation of eventual measurements.

Because buried ice is widespread in the Martian mid-latitudes, the drilling target of a 10 meter core that is primarily ice (but may contain dust, rocks, or soil debris) could be obtained from ground ice deposits where meters-thick ice in excess of the pore space (excess ice) occurs and from ice-rich glacial-type deposits (lobate debris aprons). To address the high-priority science highlighted here, we indicate where the science questions apply to drilling in ground ice or in glacial ice. Both environments should be considered as targets for drilling a core that is primarily composed of ice and that represents a stratigraphic sequence. We also indicate what science questions and measurements rely on a high-quality continuous ice core, compared to core fractures or pieces, or to collecting only core chips (see Section V and VIII).

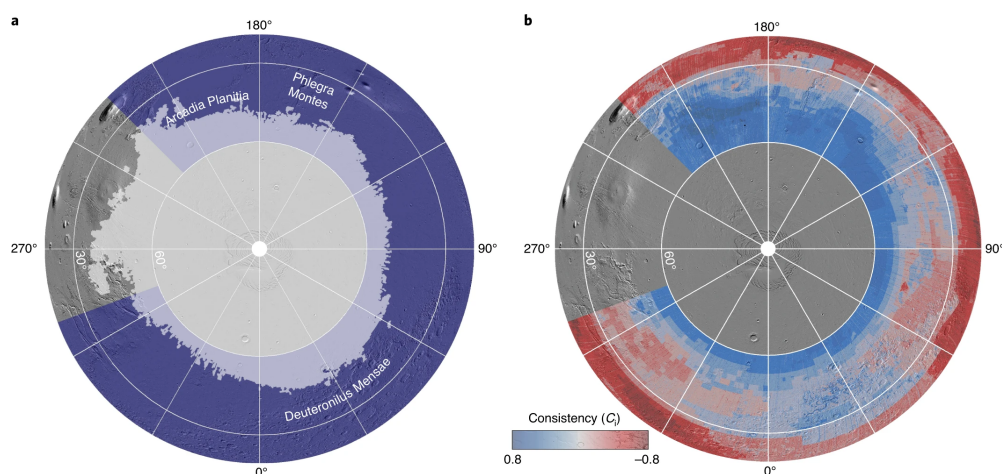

Figure III-1. From Morgan et al. (2021). Purple shading is studied region in the northern hemisphere, and grey shading shows the estimated areal extent of theoretical 3 m ice stability. b) Map of composite ice consistency (C_i). Bluer pixels are consistent with presence of ice and redder pixels are consistent with absence of ice.

Motivation for drilling in glacial-ice environments: Lobate debris aprons on Mars (Figure III-2) are up to hundreds of meters thick deposits of most likely meteoric ice in the mid-latitudes, and this ice should record past climate conditions similar to ice cores from glaciers and ice sheets on Earth. There is recent evidence that individual glaciers on Mars indeed record multiple episodes of accumulation linked to orbital forcing (Levy et al., 2021). Meteoric ice on Earth contains an important reservoir of information on past climatic events, extending back at least one million years as a continuous record, and multiple million year old discontinuous records have been found so far. Paleoclimatologists have used this information to determine past climate changes, and recent work on a deep ice core from West Antarctica has shown that polar ice cores provide archives of prokaryotic cells and other meteoric constituents over time (Santibáñez et al., 2018). These ice cores allowed for the examination of historical ecological forces shaping microbial communities on time scales at which climatic and environmental processes occur. Data from this ice core conclusively showed that airborne Antarctic prokaryotic concentrations from ice cores are sensitive to large-scale changes in mean climate states and millennial-scale variations. As such, meteoric ice contains an important record of microorganisms on

our planet that theoretically could be used to assess biogeochemical processes and habitat types that occurred during past glacial and interglacial periods. Investigations on Mars are similarly motivated by questions about cryobiology and climate.

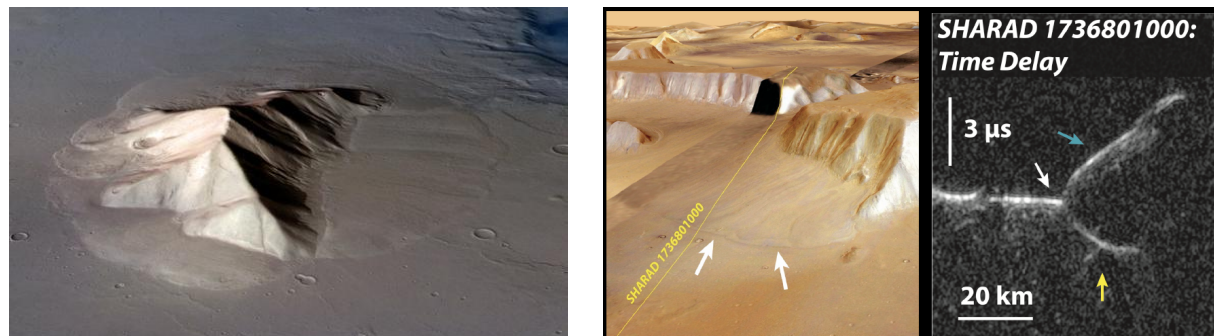

Figure III-2. Left: Lobate debris apron at $\sim 41^\circ \text{S}$, 103°E shown in perspective false color from HRSC image 0451 (Credit: ESA/DLR/FU Berlin). The diameter of the apron is $\sim 50 \text{ km}$. Right: SHARAD radar profile along a lobate debris apron (Credit: Eric Petersen).

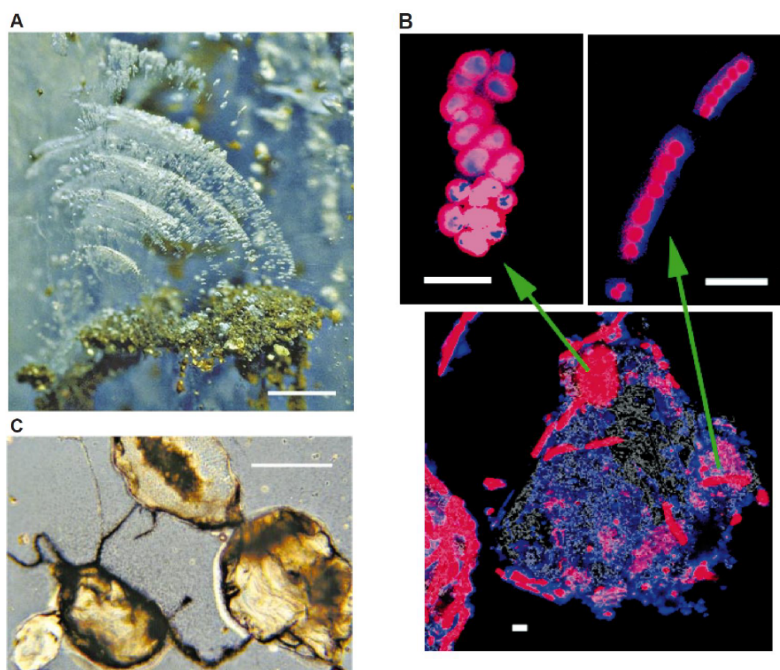

Figure III-3. From Priscu et al. (1998). A) A sediment aggregate and associated freezing front bubble pattern from 2 m beneath the surface of the permanent ice cover of Lake Bonney. B) Confocal laser photomicrographs showing microorganisms associated with a sediment particle, with enlarged views of two species of cyanobacteria (blue, DAPI-stained bacteria; red, chlorophyll autofluorescence; gray, sediment particle). Scale bars, $10 \mu\text{m}$. C) Microautoradiograph of sediment particles bound by cyanobacterial filaments (dark regions denote sites of active $^{14}\text{CO}_2$ accumulation, indicative of photosynthetic activity). Scale bar, $100 \mu\text{m}$.

Motivation for drilling in ground-ice environments: Collecting ice cores from ground ice is also motivated by high-priority questions in both biology and climate. In regards to biology, habitable space and associated life in Earth's icy environments are often associated with lithic material. Lithic matter, particularly near the surface, has been shown to provide permanent or transient films or inclusion of liquid water that can enhance the weathering

process of important life sustaining minerals and associated free energy couples. These relationships have been shown to support a seasonally active microbial ecosystem within the permanent ice covers of lakes in the McMurdo Dry Valleys (Figures III-3, III-4, and III-5) and entrained in cryoconite holes (Smith et al. 2016; Foreman et al., 2007; Figures III-7 and III-8).



Figure III-4. Lake ice aggregate during late winter before liquid water formation. The photograph was taken at an ice depth of 2m from a 3.5m deep trench cut into the ice cover of Lake Bonney, Antarctic Dry Valleys. The bubbles are a result of gas exsolution that occurs as the water occlusions freeze from the top down during autumn and early winter. Scale bar 2 cm (Credit: John Priscu).

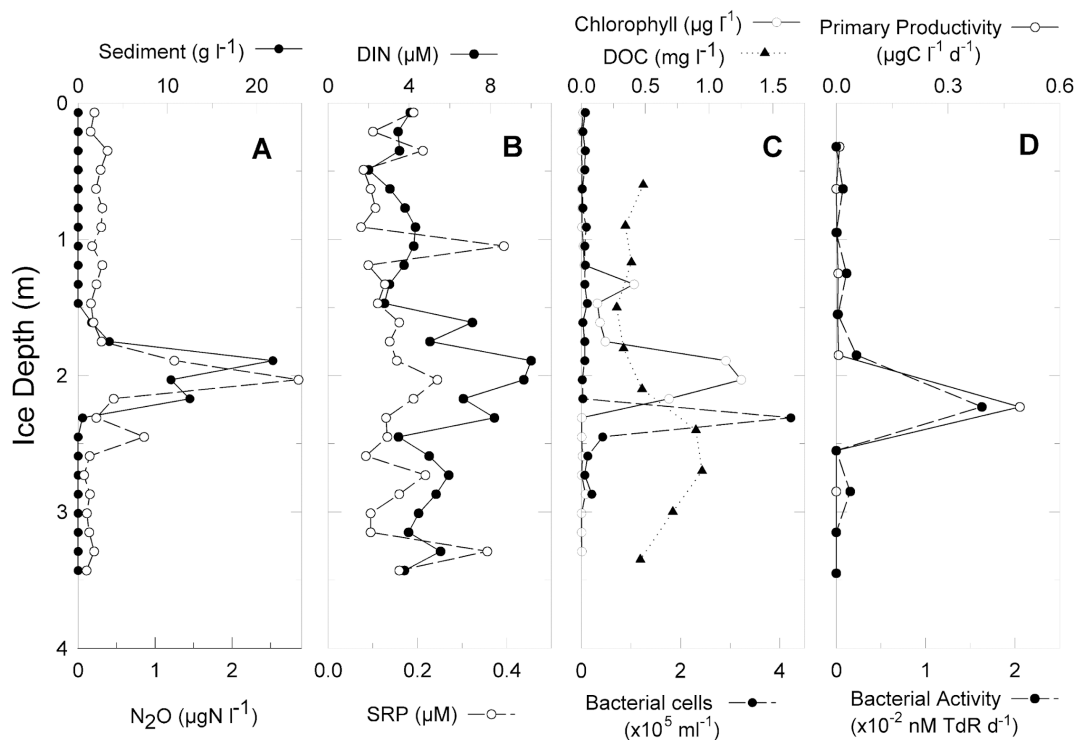

Figure III-5. From Priscu et al. (1998). Vertical profiles of selected constituents (A-D) in the lake ice cover of Lake Bonney. Individual points represent the mean from ice core sections approximately 14 cm long (10 cm diameter) except in (D) where points represent the mean from approximately 30 cm long core sections. DIN = $\text{NH}_4^+ + \text{NO}_3^-$, SRP = soluble reactive phosphorus, DOC – dissolved organic carbon, Primary productivity = light mediated photosynthetic activity, Bacterial activity (TdR) represents the rate of incorporation of ^3H -thymidine into bacterial cells.

The 4 to 20 m thick permanent ice covers of Antarctic lakes in the McMurdo Dry Valleys develop liquid water inclusions in response to solar heating of internal aeolian-derived sediments. These sediments typically reach their depth of downward melting about 2 m below the ice surface. The ice sediment particles serve as nutrient (inorganic and organic)-enriched microzones for the establishment of a physiologically and ecologically complex microbial consortium capable of contemporaneous photosynthesis, atmospheric nitrogen fixation, and decomposition. The consortium is capable of physically and chemically establishing and modifying a relatively nutrient- and organic matter-enriched microbial “oasis” embedded in the lake ice cover. The habitat in the Antarctic lake ice cover may serve as a model environment for past life on Mars. Although Mars may have had extensive liquid water at one time, it rapidly cooled, and ice would have become, as it is today, the dominant form of water on the surface. While lake ice environments are not found on modern Mars, they could be an analogue for crater lake environments on early Mars (e.g., McKay et al., 2017). In addition, solar heating of the ground surface during high-obliquity periods of Amazonian Mars could have resulted in subsurface melt layers similar to those that exist in the permanent ice covers in the McMurdo Dry Valley lakes.

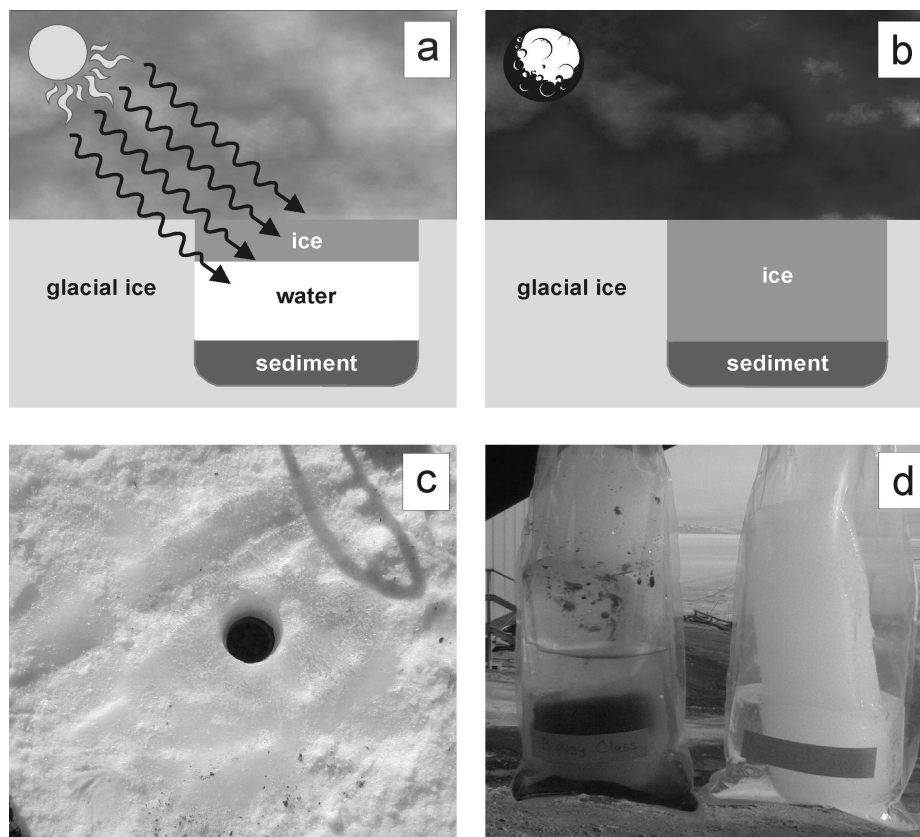

Figure III-6. From Priscu and Christner (2004). The cryoconite hole environment in the McMurdo Dry Valleys. In summer, sediment collects on glacial surfaces and exposure to solar irradiation produces melt pools within the ice (A), which may subsequently freeze on the surface, and completely freeze during the winter (B). The cryoconite hole illustrated (C) was located on the Canada glacier and was completely frozen when sampled in January 2001. (D) A comparison of cores retrieved from the cryoconite hole (left) with a core from the adjacent glacial ice. Note the dense layer of sediment and organic material present within the bottom 5 cm of the cryoconite hole core.

Cryoconite holes are depressions on glacial surfaces that have a characteristic sediment layer and melt to an equilibrium depth (Figures III-6, III-7, and III-8). In the Antarctic McMurdo Dry Valleys these entombed habitats harbor active microbial assemblages predominantly associated with lithic material and on average remain entombed (isolated from atmospheric conditions) over decadal timescales. Previously, cryoconites have been studied as analogs to Mars. It has been shown that microbial activity significantly decreases with increased distances from other organisms and lithic material (Figure III-8).

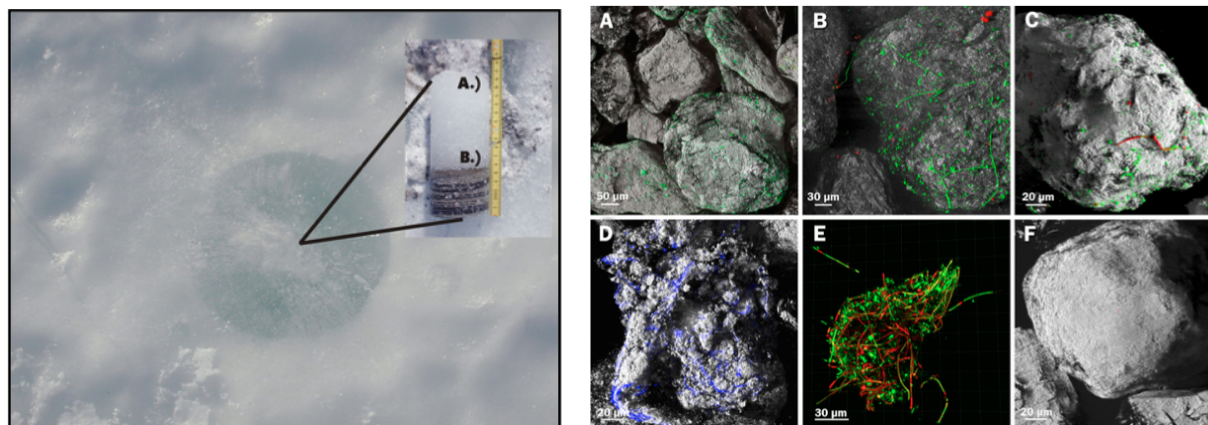

Figure III-7. Left: From Foreman et al. (2007) showing a cryoconite hole and core section through the hole. Cryoconite hole diameter is on the order 100 cm. Right: From Smith et al. (2016). Confocal scanning laser Microscopy images of cryoconite particles and associated microbial cells (A-C,E) and biofilm matrix (D) and control sediment (F).

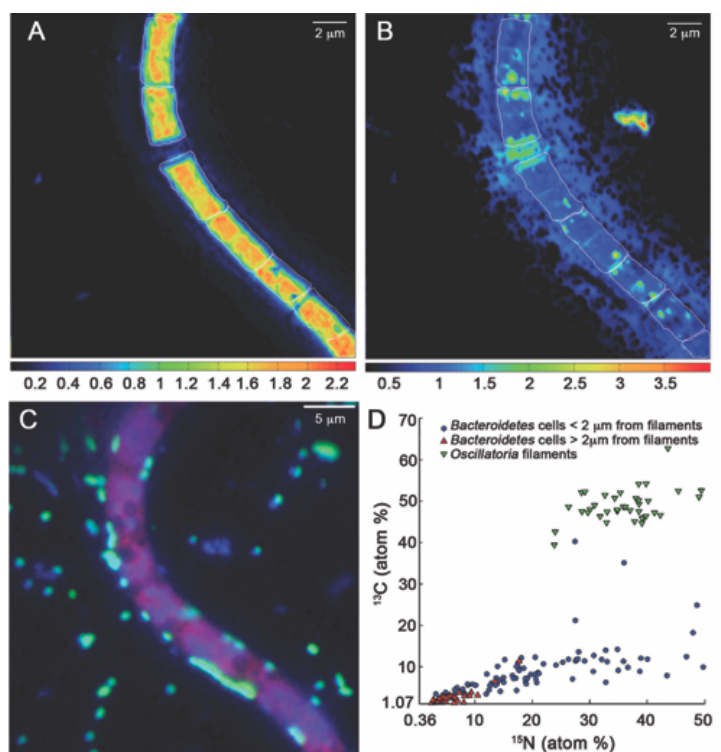

Figure III-8. From Smith et al. (2016). Analyzed aggregate of microbial cells from an Antarctic cryoconite hole. Representative nanoSIMS isotope ratio images of an analysed *Oscillatoria* sp. filament for a the $^{13}\text{C}/^{12}\text{C}$ ratio (B) the $^{15}\text{N}/^{14}\text{N}$ ratio (C) the epifluorescence overlay used to confirm cell identification of hybridised *Bacteroidetes* cells (green), DAPI stained (blue) and an autofluorescent filament (red). (D) NanoSIMS analysis of ^{13}C and ^{15}N enrichment measurements atom % (AT%) for *Bacteroidetes* sp. cells based on proximity to filamentous cells and particles. Showing a decrease in activity with increased distance.

In addition to the goals related to biology described above, collection of cores from ground ice is motivated by a number of outstanding questions related to the Martian climate. Ground ice in the shallow subsurface is widespread on Mars (e.g., Morgan et al., 2021), including in many mid-latitude regions that are likely to be the first sites visited by human explorers. This ground ice includes pore-filling ice, which refers to ice condensed from water vapor in the atmosphere that diffuses into the regolith. Theoretical models of the stability and dynamics of pre-filling ground ice (e.g., Mellon et al., 2009) correlate extremely well with observations (e.g., Boynton et al., 2002; Byrne et al., 2009; Dundas et al., 2014), including the ice observed at the Phoenix landing site (Figure III-9).

Excess ice (ice in excess of pore space) is also observed in some mid-latitude regions, and evidence for excess ice in different locations is increasing (e.g., Bramson et al., 2015; Stuurman et al., 2016; Dundas et al., 2018; Pathare et al., 2018; Morgan et al., 2021). While the formation of mid-latitude excess ice in the past is predicted by some models (e.g., Madeleine et al., 2009), its persistence and age are less well understood. In particular, for depths deeper than several meters, the minimum age of the excess ice is thought to be much more than recent obliquity cycles on Mars (Viola et al., 2015). This requires a mechanism for this ice to persist during times when mid-latitude ice is unstable. Possible mechanisms to preserve ground ice could include protective sublimation lags (e.g., Bramson et al., 2017) or high water vapor content in the lower atmosphere (e.g., Tamppari and Lemmon, 2020). Excess ice at shallow depths is periodically unstable as recently as 100,000 years, and shallow enough to be lost and reform on 1000 year time scales. Ultimately, the age and persistence of excess ice is important in understanding mid-latitude climate, but our knowledge of these subjects is currently limited, which motivates the need to collect ice cores.

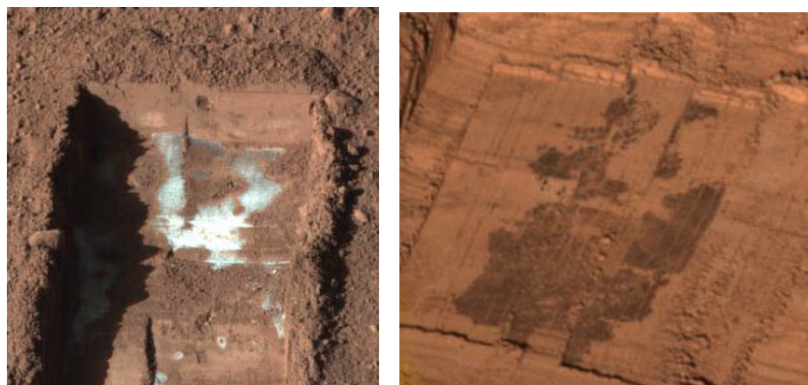

Figure III-9. From Mellon et al. (2009). Phoenix Lander images of subsurface exposures. Left: small patch of 99% pure water ice (trench is ~15 cm wide). Right: pore-filling ice-rich soil (trench is ~23 cm wide).

Broad motivation to understand Mars' climate history: Climate questions that motivate the collection of ice cores extend beyond mid-latitude-specific climate and include outstanding questions about Martian climate in general. Consider the extensive Martian polar layered deposits (PLDs), large water ice sheets at the north and south poles of Mars. These PLDs (see, e.g., review in Byrne, 2009) have been the subject of many studies that have sought to address questions about global Martian climate. In particular, the plentiful exposures of layered stratigraphic ice (Figure III-10) have been considered as “virtual ice

cores”, with many studies (e.g., Laskar et al., 2002, Milkovich and Head, 2005, Becerra et al., 2019) attempting to use patterns observed in the ice exposures with remote sensing data from orbiting spacecraft to test the long-standing hypothesis that Martian climate is strongly controlled by variations in the planet’s spin and orbit (e.g., Murray et al., 1973; Cutts and Lewis, 1982). These studies have made valuable progress, but the confident detection of such an orbital signal in Martian ice from remote sensing data alone is debated (e.g., Perron and Huybers, 2009). Ultimately, independent age constraints – such as those that can come from study of ice core samples – will be needed (Sori et al., 2014) to definitively test this important hypothesis. The orbital forcing of Martian climate is thought to be a global phenomenon, so physical collection and dating of mid-latitude ice cores (similar stratigraphic ice exists in the mid-latitudes, Figure III-10) can be used to study it, including study of hypothesized links and exchanges between polar and mid-latitude reservoirs (e.g., Head et al., 2003).

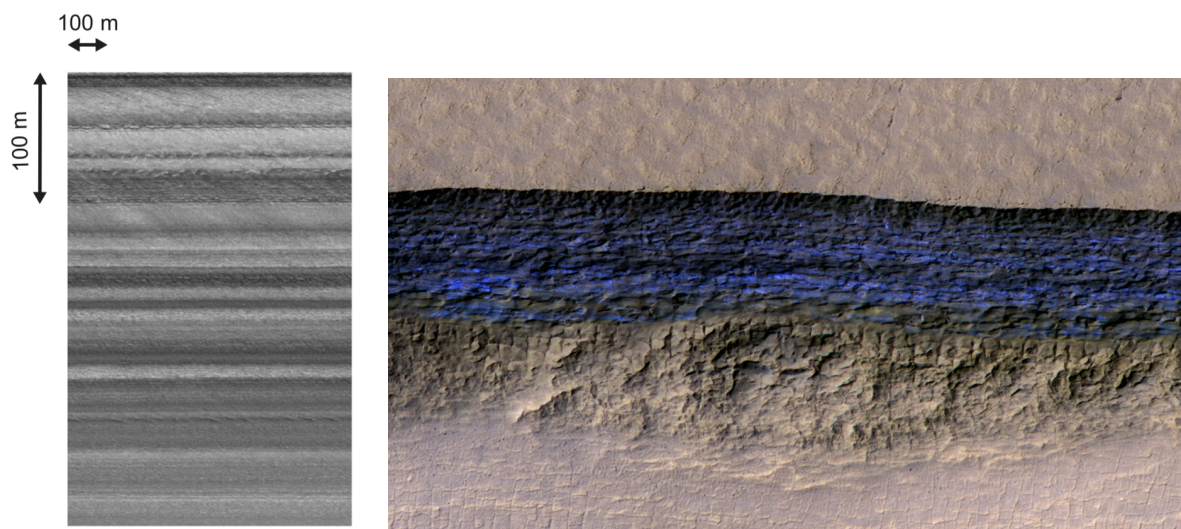

Figure III-10. *Left: Modified from Sori et al. (2014). Example of a stratigraphic sequence from the northern polar layered deposits on Mars, corrected for topography, from Mars Orbiter Camera (MOC) Image #M0001754. Vertical scale indicates vertical depth within the sequence, horizontal scale indicates distance along outcrop. Right: From Dundas et al. (2018). Enhanced color image of a mid-latitude ice cliff nearly 100 m high exposing a deposit of nearly pure ice (blue shading); NASA/JPL/University of Arizona/USGS.*

We emphasize that the biology and climate motivations for collecting ice cores are linked together. In addition to ice core collection, a local radar survey in order to pick the drill site (see Section III.3), as well as sampling from the surface to depth at the target ice core site, would answer questions about the distribution of ice that have implications for the climate controls on habitability.

Goals and Objectives

A human-led scientific mission to the mid-latitudes of Mars would transform our understanding of past and present conditions and processes related to life and climate, as

well as contribute to understanding Mars' geological history and further support human exploration. NASA goals and priorities have been defined by the planetary science community and are thoroughly discussed in the Planetary Science Decadal Survey (*Vision and Voyages for Planetary Science in the Decade 2013–2022*; NRC, 2013) and the Mars Exploration Program Analysis Group Goals Document (MEPAG, 2020). In addition, white papers submitted for the development for the 2023–2032 Decadal Survey and the report from the Ice and Climate Evolution Science Analysis Group (ICE-SAG, 2019) also define high-priority science areas.

The Mars Ice Core Working Group has adopted the first two MEPAG science goals as the overarching goals related to the majority of the science objectives and questions detailed here. These goals can be addressed from new in situ measurements and core samples that are primarily ice collected by a ground crew and returned to Earth. The first two goals from MEPAG (2020) include (I) Determine if Mars ever supported, or still supports, life and (II) Understanding the processes and history of climate on Mars. In-situ measurements and returned sample measurements associated with the first ice coring effort on Mars will also bring new understanding related to aspects of MEPAG Goals (III) and (IV), to understand Mars' as a geological system and to support human exploration.

Related to these goals, **the Mars Ice Core Working Group has defined the highest priority objectives that could be addressed with the first ice cores from Mars:**

1. Determine the nature and temporal evolution of habitable space in the subsurface ice environment
2. Determine if extinct or extant life is present and evaluate phylogenetic and metabolic relationships
3. Assess the potential to preserve biosignatures
4. Determine the ice stratigraphy and age of ice in the core
5. Determine the lithic stratigraphy and age of lithic matter in the core
6. Characterize climate processes on Mars and the relationship between orbital cycles and climate conditions
7. Characterize the geographic distribution and history of subsurface ice near the core site
8. Determine the context for interpreting the biological and climate records in the core

The following subsections discuss questions that can be answered with the first ice cores from Mars and describe measurements and protocols to maximize the scientific return from an ice-coring mission. Addressing the science questions presented here requires various measurements on the core, which put requirements on the characteristics of the core, as well as requirements on how the core is handled and stored. In addition, local measurements from the region near the core site provide necessary context to interpret the biological and climate records in the core.

Compelling science questions that can be addressed with returned samples

Linkages between life, climate, and geology: Much of Mars’ science is “cross cutting” (MEPAG, 2020), and high-priority science related to life, climate, and geology are inextricably linked. For example, a major discovery related to the presence of extant or extinct life on Mars would require consistent discoveries about past climate and the water cycle, as well as discoveries about geological and geochemical conditions conducive to life.

Cryobiology: Fundamental questions about the nature and temporal evolution of habitable space in the subsurface environment include understanding if the physical and chemical properties of icy environments can support life. Liquid water is critical to life, and questions about the physical and temporal distribution of subsurface liquid water are a priority. High priority is to address: Is “ancient” or “modern” DNA present? Are organism “skeletons” or fossil remnants present? Are metabolically active organisms present?

Table III-1. Questions related to Objectives 1-3. Color indicates if addressing the question requires a continuous ice core (*dark blue*), or if fractures or pieces of core/chips are acceptable (*light blue*).

<p>1. Determine the nature and temporal evolution of habitable space in the subsurface ice environment</p>	<ul style="list-style-type: none"> • Is liquid water present in ice veins, or at grain boundaries, or as thin films? Is this water mobile and able to transport soluble materials (inorganic or organic)? • Are the physical and chemical properties of icy environments conducive to life? • What is the physical and temporal distribution of subsurface liquid water? • What is the water activity in the subsurface? • What is the distribution of inorganic and organic resources?
<p>2. Determine if extinct or extant life is present and evaluate phylogenetic and metabolic relationships</p>	<ul style="list-style-type: none"> • Is “ancient” DNA present? Can it be sequenced? • Are organism “skeletons” or fossil remnants present? • Are metabolically active organisms present? • Are brine concentrations (bulk or in veins) adequate to preserve organic matter? • What is the metabolic potential of cells to repair damage induced by the oxidation potential of the habitat? Is the DNA fragmented?
<p>3. Assess the potential to preserve biosignatures</p>	<ul style="list-style-type: none"> • What is the speciation and depth distribution of organic molecules, organic resources, and/or potential biosignatures? • What is the oxidation potential and associated free-radical formation with depth and is it adequate to oxidize organic matter to smaller organic compounds or to carbon dioxide? • Can geochemistry and mineralogy provide a temporal history of oxidation potential and its association with aerobic and/or anaerobic life?

Stratigraphy: Measuring ice stratigraphy, lithic stratigraphy, and age of the ice are fundamental analyses. The ice stratigraphy allows investigation of whether samples of past atmosphere are preserved, and if clathrate hydrates are present. A core in ground ice would provide ground truth on the subsurface ice concentration with depth, as well as if unique thermal or depositional structures are present, if sediments are fractionated according to size and density, and if there is dissolved and particulate organic matter associated with sediment stratigraphy. For glacial ice, the ice stratigraphy would further

reveal any density variations, the frequency and thickness of dust layers in the core, the layer-thickness profile of ice layers, and if cells are associated with dust layers, clathrates, and/or bubbles. The lithic stratigraphy will define what constitutes a layer. In addition, the presence of dust, volcanic ash (if observed), and the lithic grain distribution provide direct constraints on atmospheric and geologic processes.

Table III-2. Questions related to Objectives 4-5. Color indicates if addressing the question requires a continuous ice core (*dark blue*), or if fractures or pieces of core/chips are acceptable (*light blue*).

<p>4. Determine the stratigraphy and age of ice in the core</p>	<ul style="list-style-type: none"> • What is the visual, chemical, and electrical stratigraphy? • Are samples of the past atmosphere preserved? • Are clathrate hydrates present and at what depths? • Is organic matter (dissolved and particulate) associated with physical and chemical stratigraphic markers? • Does the crystalline structure of the ice vary with other stratigraphic markers? • Does vein volume vary with other stratigraphic markers? • What is the age of the ice? What is the depth-age profile? • <u>Ground ice:</u> • Are unique structures present that may indicate thermal and depositional history (e.g., lenses, depth-hoar frost)? • Are gas bubbles associated with particles within the ice and can they be used as an indicator of past liquid water inclusions? • Are gases differentiated along stratigraphic markers? • What is the concentration of subsurface ice with depth? • Are sediments fractionated according to size and density? • <u>Glacial ice:</u> • At what vertical scale do changes in density and structure of the youngest ice layers occur? • What is the frequency and thickness of dust layers? • What is the layer-thickness profile of ice layers? • Does dissolved and organic matter support other stratigraphic markers? • Are cells or biosignatures associated with dust layers, clathrates, and/or bubbles?
<p>5. Determine the lithic stratigraphy and age of lithic matter in the core</p>	<ul style="list-style-type: none"> • What composes and defines a layer? • What is the overall thickness of dry permafrost (ice free soil), ice-rich permafrost (icy soil), and any underlying massive ice (glacial or other)? • What is the thickness of layers of substantial subsurface dust/debris found in between substantial layers of massive ice? • What is the vertical distribution of grain size, shape, and mineralogy of non-volatile materials? • What is the age of lithic matter? What is the depth-age profile? • What is the vertical distribution of the ratio of ice to lithic material? • Are clasts present and what is their exposure age? • Are dust layers present and are they periodic in distribution? • Are lithic grains oriented by bulk deformation? • Are volcanic ash layers observed?

Climate: Climate on Mars has long been hypothesized to be strongly controlled by variations in the planet’s spin and orbit (e.g., Murray et al., 1973; Cutts and Lewis, 1982). However, confident identification of this orbital signal in icy stratigraphy has remained debated (e.g., Laskar et al., 2002; Perron and Huybers, 2009), as have the exact sensitivity of stratigraphy to orbital cycles and many ice characteristics including accumulation rate,

age, deformational history, and more. Laboratory analysis of returned ice core samples would be a game changer in addressing these climate questions. For example: (1) Constraints on age and accumulation rate of mid-latitude ground ice cores would allow for determination of the relationship of mid-latitude ice to other Martian water reservoirs, including the polar layered deposits (e.g., Bramson et al., 2017). (2) In glacial-type deposits, these same constraints would allow for testing of hypotheses on the number of glacial transitions recorded (e.g., Levy et al., 2021). (3) Chemical analysis of atmospheric samples, if present, could allow for the quantification of carbon dioxide’s relationship with orbital cycles (e.g., Buhler et al., 2020). (4) Identification of impact sediments or volcanic ash, which have been putatively identified in the polar deposits (e.g., Sinha and Horgan, 2021), would represent a lithic source that is unlikely to be strongly controlled by obliquity and would be important to consider in addition to the likely more prevalent atmospherically deposited dust.

Table III-3. Questions related to Objectives 6. Color indicates if addressing the question requires a continuous ice core (*dark blue*), or if fractures or pieces of core/chips are acceptable (*light blue*).

<p>6. Characterize climate processes and the relationship between orbital cycles and climate conditions on Mars</p>	<ul style="list-style-type: none"> • What atmospheric or climate cycle (or event) does the smallest physical layer represent? • How have indicators such as temperature, accumulation, and windiness changed over time? • How do volatiles (H₂O, CO₂) and dust exchange between surface, subsurface, and atmospheric reservoirs? • Is there a relationship between oxidants and climate cycles? • What is the relationship of mid-latitude ice to other ice reservoirs (atmosphere, polar caps, hydrated minerals, adsorbate, and the broader hydrological system)? What is the history of this relationship? • What is the relationship between the climate records and orbital cycles? • How has the chemical composition of the atmosphere changed over time? • Is there evidence of volcanism? <p><u>Ground ice:</u></p> <ul style="list-style-type: none"> • What are the processes that form ‘excess ice’ (observed to be concentrated in excess of the pore space)? • Under what climate conditions does pore ice form, and under what climate conditions does excess ice form? • What is the relationship between pore ice and excess ice? <p><u>Glacial ice:</u></p> <ul style="list-style-type: none"> • What was the ice deposition rate in the past when glacial-type ice deposits were active? • What is the thickness of ice-rich permafrost lag over relatively soil-free glacial ice? • What are the thermal and deformational histories of glacial ice? • What is the variation of water isotopes and ice impurity chemistry with depth?
--	--

Geology, geochemistry, glaciology, and geomorphology: Characterizing the subsurface ice distribution is necessary for drill-site selection, but also addresses high-priority science. The geographic distribution of ice, as well as the geology and geochemistry in the vicinity of the drill site contribute necessary context to interpret the biological and climate records for

ice cores. Mapping and dating glaciological and geomorphological landforms, spanning periglacial, glacial, and paraglacial environments, as well analyses focused on past and present processes driving ice and organic evolution provide further context for the ice core records.

Table III-4. Questions related to Objectives 7 and 8. Addressing these questions requires in-situ measurements in combination with cores and/or chips. Color indicates if addressing the question requires a continuous ice core (dark blue), or if fractures or pieces of core/chips are acceptable (light blue).

<p>7. Characterize the geographic distribution and history of subsurface ice near the core site</p>	<ul style="list-style-type: none"> • What are the scales of heterogeneity in the ice distribution? Are layers isochrones? • Is there evidence of ice deformation on subsurface stratigraphy? • What is the vertical and horizontal distribution of sediment and ice within ~10 km of the core site? • What is the concentration of subsurface ice with depth on the scale of decimeters to kilometers? • What is the accessibility and usability of subsurface ice as a resource for exploration?
<p>8. Determine the context for interpreting the biological and climate records in the core</p>	<ul style="list-style-type: none"> • How much has ice within layers been altered since formation (e.g., by grain -growth, migration of thin liquid films, porosity reduction, isotopic exchange with pore-filling gas or neighboring layers, flow processes)? • What surface and subsurface processes play a role in organic evolution? • What is the water activity in the subsurface over time? • Is the present-day subsurface ice at the landing site stable, ablating/ sublimating, or accumulating/condensing? • At what burial depth does a layer stop interacting with the atmosphere? And what processes, if any, occur after a layer is cut off from the atmosphere? • What is the geochemistry of the surface and subsurface near the core site? • How has the deposition, deformation, and sequestration of ice modified the surface and influenced the development of surface landforms? • What distribution of geomorphological, geological, glaciological, and mineralogical features exist near the core site? • What are the relative and/or absolute ages of any observed periglacial, glacial, and paraglacial landforms? How old is the overburden layer? • What observations (imaging, remote sensing, etc.) can be used to extrapolate core-site conditions to other regions? • Ground ice: • How much exchange is there between pore space within recent layers and the current atmosphere?

Comparative planetology: Ice cores from Earth are distinctly rich records of Earth’s history. Ice cores from Mars would provide similarly rich records for Mars’ history, but also make it possible to understand the history of terrestrial planets more generally by comparing Earth and Mars. Indeed, terrestrial analogue studies have advanced our understanding of geological, geomorphological, glaciological, biological, and chemical processes on Mars. Simpler climate dynamics on Mars (e.g., lack of current oceans) allow us to evaluate the relationship between orbital cycles and climate, which may apply to other planetary bodies, and especially as we continue to learn about the other ice sheets of the solar system (including the nitrogen ice sheets of Pluto (Stern et al., 2015) and Triton

(Moore and Spencer, 1990)). In general, questions related to life and climate in our solar system are fundamental to understanding the evolution of terrestrial planets and exoplanets. Comparative planetology is a way to move beyond solar system exploration, toward the explanation of how planetary systems work (e.g., Glassmeier, 2020).

Solar storm events: Ice records are unique in how they preserve specifics of the hydrologic cycle during snow deposition, past atmospheric composition, and can record climate events on seasonal to millennial timescales. Ice cores records of ^{10}Be show correlation with solar activity (Vonmoose and others, 2006), and it has recently been confirmed that extreme solar storms can lead to increased atmospheric production of cosmogenic radionuclides (O’Hare et al., 2019), and evidence of ^{14}C , ^{10}Be and ^{36}Cl increases in ice core records have been linked to extreme solar storms from ~660 BC (O’Hare et al., 2019), as well as 775 and 993 BC (Mekhaldi et al., 2015). However recent studies have strongly stated that nitrate spikes in ice cores are not proxies for solar storms (e.g., Duderstadt et al., 2016; Mekhaldi et al., 2017). Even for the most extreme solar storms (including years 775, 994, 1859, 1956 BC), ice cores from Antarctica and from Greenland do not record a coincident global increase in nitrate, and the nitrate spikes that are observed are likely associated with biomass burning (Mekhaldi et al., 2017). These studies highlight the importance of high-resolution analyses (annual to multi-year resolution) of multiple radionuclides from ice cores and the possibility for a comparison between ice core records from Earth and high-resolution ice cores from Mars.

2. Measurements on returned samples

Section V and Table V-2 discuss the continuity, quality, and quantity of the returned samples required to enable specific measurements. We distinguish between three primary types of ice core samples, where the core is retrieved in lengths of approximately one meter:

- 1) **Continuous:** ice core is in five or fewer pieces per meter with relatively few cracks penetrating into the interior of the core
- 2) **Fractures:** ice core is in six or more pieces per meter with frequent cracks penetrating into the interior. The pieces and cracks are tight fitting such that the stratigraphic order is preserved at the mm and longer length scales
- 3) **Pieces:** ice core is broken into pieces and stratigraphic order is uncertain at cm length scales and shorter
- 4) **Chips:** chips are small ice shards and dust with maximum dimension 6 mm, as would be generated from an ice drill that shaves ice into chips but does not drill a core (*see section IV for further description*).

All ice samples from Mars will have scientific value, but the extent to which our high-priority objectives and questions can be addressed will depend on the characteristics of ice cores recovered from Mars. Section V discusses trade-offs between core characteristics and the measurements that will be possible to make, as well as discusses estimates for the

quantity of core required to make certain measurements based on contemporary technology.

Indicators of life

Multiple lines of evidence will be required to determine unequivocally if life does or did exist on Mars. Past reports from Viking tracer release experiments and Martian meteorites (Allan Hills 84001) have yet to be verified owing to the lack of corroborating data. The analysis of Martian ice in an earth-based laboratory setting will allow scientists to use a multifaceted approach to verify results. At a minimum, these measurements must contain experiments to both observe the presence of cellular matter (e.g., electron and optical microscopic analysis, multidimensional fluorescence), determine its phylogenetic character, and identify the presence of metabolic activity. Ideally, such measurements must also be made on parallel control samples to ensure that the results are not contaminants; for biological studies, controls are as important as the actual samples themselves. For this reason, Mars 2020 incorporated a number of control cores to examine contamination at various points in the mission.

In addition to measurements and experiments focused directly on biology, a suite of chemical and physical determinations must also be included to interpret and corroborate the biological data. These measurements should include, but not be limited to, geochemistry, crystal structure, bubble structure, lithic matter, and the temporal stratigraphy of the ice. Data from intact ice cores together with ice chips and shavings should be incorporated into the suite of measurements. If we are to understand life in Martian ice we must understand the ice itself and its potential to serve as a habitat. Finally, it is imperative that stringent sampling and decontamination protocols be applied to both the control and actual ice samples from Mars.

Indicators of climate

Measurements that provide constraints on Mars' climate include ice chemistry, stable isotopes, trapped gases (if preserved), ionic content, material properties of the ice (density, crystal/grain structure, bubble distribution), and electrical properties. Decimeter-scale analysis of ice stratigraphy over the meters-long core, as well as the lithic stratigraphy of the overburden, will reveal the frequency and thickness of dust layers.

Stable isotopes, including the ratio of ^{18}O to ^{16}O , the ratio of Deuterium to Hydrogen (D/H), and isotopes of trace gases (e.g., N, Ar, Kr), all fractionate over time, largely by loss to space, during time spent in the atmosphere. Water stable-isotope records from a Mars' ice core are particularly important to constraining the history of water on Mars. The D/H ratio has changed over Martian history due to fractionation loss to space, and to a lesser degree by sequestering in ice reservoirs (e.g., Alsaeed and Jakosky, 2019; Vos et al., 2019). Profiles of D/H from mid-latitude ice cores can be compared to the current atmospheric value or to polar ice, which would reveal relative ages of these reservoirs and their exchange history.

Measurement of ice age

Ice cores on Earth are dated with a variety of methods. Relatively young ice, <60,000 years, has been dated by counting annual layers of ice deposition (Svensson et al., 2008), while older ice with continuous stratigraphy has been dated by tuning different records to the known variations in Earth's orbit (Parrenin et al., 2007). Increasingly, ages are being determined by radiometric methods: cosmogenic ^{81}Kr in the trapped gas has a half life of 230,000 years (Buizert et al., 2014); and the $^{234}\text{U}/^{238}\text{U}$ ratio is useful on timescales of hundreds of thousands of years (Aciego et al., 2011). The amount of ^{40}Ar , relative to ^{36}Ar and ^{38}Ar , has been used on timescales of millions of years, as ^{40}Ar has accumulated in the atmosphere as ^{40}K has decayed and outgassed (Yan et al., 2020).

The techniques needed to date ice cores from Mars are not yet known in part because there is a large range in the possible age of the ice, ranging from hundreds of thousands of years if deposited during a recent obliquity cycle to hundreds of millions of years if the ice is from an earlier climate period. The techniques used on Earth will be useful if the ice is relatively young, or to place a minimum age constraint. Thus, additional dating techniques relating to losses to space will need to be developed if the ice proves to be older. Relative dating of the ice may be possible based on how D/H from mid-latitude ice is similar to or differs from the current atmosphere and from the polar ice reservoirs. If volcanic ash exists in the ice, radiogenic dating of the ash could provide valuable age constraints.

Permafrost and regolith/debris/dust samples

Dry soil may overlies all forms of ground ice, and pore-filling ice may overlies massive buried ice deposits. Surface and subsurface samples should be collected for geological context and to address high-priority science (see Table III-4). If permafrost is present, a core or an intact stratigraphic sequence should be collected. Subsurface samples provide information at depths poorly resolved by satellite remote sensing, and provide in-situ validation for remote data sets. Similar to measurements made on samples from Earth, measurements from samples on Mars could include: organic matter, mineral grain size and composition, organic carbon, nitrogen, sulfur, and isotopes, as well as pollen, microfossils, and stable isotopes of water.

3. Drill site selection and context to interpret ice core records

Prior to choosing the specific drill site on Mars:

- 1) Satellite remote sensing of subsurface structure from 0 to 20 meters below the surface will be critical in order to map the depth to ice, ice-deposit thickness, horizontal distribution of ice, and observable vertical or horizontal structures within target ice-rich deposits, and ultimately, select the final rough (~1 km x ~1 km) drill site.

- 2) Once the ground crew has reached the target region, on-site ground surveys would be conducted to pick the specific core site(s) within the satellite-selected region. Ground surveys should consider safety, topography, overburden (debris) cover, lateral extent of a relatively smooth working surface, and subsurface or surface-exposed stratigraphic features being targeted from the satellite platform. Given the slow deformation rates, the application of techniques to measure deformation fields such as those commonly used on Earth are not warranted or recommended in this case. However, assessment of stratigraphic horizons within satellite and ground-based geophysical observations should be relied upon to select a core site where surface conformable stratigraphy exists.
- 3) Short cores or samples should be collected from the overburden layer to the top of the ice layer, which may include sampling permafrost, regolith, debris, and/or dust.

Satellite remote sensing on Earth

In comparison to radar remote sensing on Earth, the most closely applicable airborne platforms relative to a proposed NASA Mars Ice Mapper may be the Center for Remote Sensing of Ice Sheets (CReSIS) VHF 150 to 600 MHz Ultra-Wideband (UWB) Radar which has a 50 cm vertical resolution depth range and reaches 1 km in Polar ice, operating at peak transmit power (400 W). CReSIS also operates a Snow radar operating at 2 to 18 GHz which provides 2 to 4 cm resolution in snow and 40 m depth penetration at 1 W peak transmit power. However, much shallower penetration depths associated with higher scattering and attenuation rates will likely occur over debris-covered ice and within debris-rich ice. In support of Mars Ice Mapper system design we recommend a comprehensive modeling effort tied to surface roughness and geological composition at high spatial resolution using existing data to determine conservative penetration depths in the types of environments where subsurface ice is likely present within a few to ten meters below the surface. Terrestrial analog studies with comparable systems over buried ice would be highly beneficial for this.

Local ground penetrating radar survey

Standard ground survey ground penetrating radar (GPR) systems operate between 2 to 900 MHz for deep to shallow applications respectively, and generally have a much lower power source than airborne systems. Most commercial impulse radar units in the 100 to 900 MHz range are used for on ground surveys to reach 80 m to 15 m, respectively, in polar snow, firn, and ice studies. Critical consideration should be given to high stacking and sampling rates per trace to improve signal-to-noise ratios. Stacking depends on the system and survey goals but can range from one to over 2000 pulses stacked per resulting trace. For Mars, ground acquisitions may have poor ground coupling due to debris cover resulting in surface scattering and high attenuation rates. Ideally a site will be selected that has small (pebble or smaller) surface debris where a GPR could be towed manually or by rover. It may be possible to mount the GPR to a rover above the ground surface for smoother acquisitions. Drone-based GPR is in the experimental stage but shows some promise for shallow mapping. The local survey should be tens of meters to multiple kilometers in scale, depending on what is known about the target region from satellite data. Survey wheels

which trigger impulses and a high-precision GPS are generally linked to GPR surveys on Earth to distance normalize data for post-collection processing and place data within geospatial context. Given the critical nature of georeferencing and distance-normalizing geophysical data for post processing, these or other techniques should be considered. If possible, grid GPR data should be collected around the drill site(s) because this will provide a three-dimensional understanding of subsurface structure. For example, in two-dimensions, stratigraphic features can only be assessed for apparent dip, whereas a three-dimensional grid provides the opportunity to quantify true dip of subsurface horizons. Lastly, observations made from Mars Ice Mapper should be repeated by ground-based surveys along a given segment near the selected core site(s). This repeat survey would: 1) tie local scale ground observations to more regional observations, 2) provide comparisons of attenuation, off-nadir responses from terrain, or other geophysical observations which may be challenging to interpret solely from only one survey method, and 3) ground-based surveys can provide both higher vertical resolution and better penetration depth to elucidate subsurface structure, thereby helping to understand satellite observations across broader regions.

Permafrost Surveys

It is likely that any selected drill sites are located at or near buried ice-rich soils or massive ice deposits which are traditionally classified as permafrost on Earth. In this instance, in-situ GPR surveying strategies should remain the same as above. However, there may be additional challenges to surveying ice-rich debris versus cleaner ice. Namely, attenuation rates will likely be higher within debris-rich ice versus cleaner ice and greater thickness of debris cover will also minimize penetration into subsurface ice. Given this limitation, a lower frequency (200 MHz) system would likely be warranted over permafrost terrain. Additionally, permafrost subsurface stratigraphic units are often far less continuous than units visible within glacier ice, therefore, local surveys to place features into lateral context will likely be on the order of tens to hundreds of meters instead of the km scale. Shallow core sampling into the subsurface to confirm GPR observations, if possible, are a traditional method used on Earth which should be considered on Mars, particularly if coring was completed solely with an auger device to assure rapid access. Core site selection ideally is located, as with glaciological coring, in sites where subsurface structure is surface conformable, or relatively consistent laterally, in space, relative to the specific drill site. Any core samples that are acquired to ground-truth GPR profiles should be assessed as discussed elsewhere in this report. However, at a minimum, auger depth to each visible stratigraphic horizon should be recorded along with other classical sedimentary analysis (e.g. lithology, grain size, shape, color, etc.).

4. Initial measurements and on-site handling of the ice core

Given stringent clean handling protocols, as well as the assumption that drilled cores should be kept at similar temperature and pressure conditions, we expect that Mars' ice cores will be sealed from within the drill before it is brought to the surface. On Earth, the

minimum on-site measurements include basic core logging of the length, diameter, weight, and condition of the core. Photographs to assess any loss of stratigraphic order during transport can also be useful. The on-site handling can also be kept to a minimum to avoid contamination, particularly if the ice is fractured. Keeping the ice at a constant temperature during handling is also important to avoid thermal shock introducing fractures.

5. Criteria for preserving ice cores for transport and storage

Once drilling is complete, care must be taken for the preservation and clean handling of ice cores at every step along the way, including:

- 1) Extraction to the Martian surface
- 2) On-site preparation for storage and transit
- 3) Storage during the remainder of the mission on the Martian surface
- 4) Launch and return trip to Earth
- 5) Landing and initial storage on Earth and ultimately archival storage

Critical factors for core handling and storage include temperature, pressure, radiation, vibration and contamination protocols.

Minimum criteria to preserve biological and climate records

During transport and storage cores must remain below -20°C , and ideally below -36°C , to minimize gas diffusion, chemical and biological reactions, and to provide a temperature buffer for storage transitions when the ice may be exposed to warmer temperatures. Minimizing fluctuations in temperature during transport and storage is required to reduce fractures forming in core pieces. Sample material, particularly cores, should be maintained at pressures equivalent to extraction at the Martian surface. This includes transport to Earth, initial and archival storage.

All ice samples (cores, chips, shavings) should be collected and handled using established clean protocols for collecting samples from sensitive regions of Mars (e.g., Chyba et al., 2005). Decontamination protocols for the cores should follow established protocols for ice cores on Earth (Section II.5), but are unlikely feasible on the Martian surface and thus should be integrated into post-mission research. Decontamination of chips and shavings is difficult and there is currently no established protocol. However, results from chips and shavings can be compared to cleaned cores for corroboration.

Considerations for handling and transportation of Mars ice cores

In addition to the considerations for handling ice cores on Earth, discussed in Section II.5, further issues will arise with the handling of Mars ice cores. During extraction and processing on site, the exposure to Martian atmospheric conditions should be minimized. Ice on Mars has a sublimation rate on the order of 1 mm/h (Chittenden et al., 2008), and

therefore must be sealed and placed in a controlled storage container soon after extraction. Rapid shifts in temperature and pressure can crack the ice, and contamination protocols in place for Mars 2020 should be followed.

In addition, many of the handling procedures developed on Earth are manual processes that will be more difficult on Mars for astronauts in space suits. If possible, robotic storage of cores in hermetically sealed tubes immediately upon extraction from the drill would be ideal. During the return trip, the ice cores will be exposed to higher accelerations, vibrations, and radiation levels than a typical terrestrial ice core transported from a field site to storage or laboratory facility. Appropriate storage and protection units will need to be designed and tested to ensure that they maintain the integrity of the ice samples (see also Section V.3).

Short-term and archival storage considerations on Earth

All ice samples (cores, pieces, and chips) should be returned to Earth following at least the basic protocols developed for returned Mars 2020 sediment core samples. This includes the storage of contamination references. The NASA Johnson Space Center (JSC), Astromaterials Acquisition and Curation Office in Houston, TX manages the curation of extraterrestrial samples returned by NASA missions (and international partners) and protects the integrity of these samples for future scientific study (e.g., Allen et al., 2011). As part of sample return missions, the Curation Office also curates flight and non-flight reference materials and space exposed hardware (any materials) that would have the potential to contaminate a present or future NASA astromaterials collection.

Samples from an ice-coring mission would include ice core samples, as well as surface samples (permafrost, regolith, dust, debris). Advances in the process and capacity for cold curation of astromaterials, including ice cores that require cold temperature and biological containment, is in progress, and the importance of contamination knowledge is recognized in order to maximize the science return from missions where samples are collected (McCubbin et al., 2019).

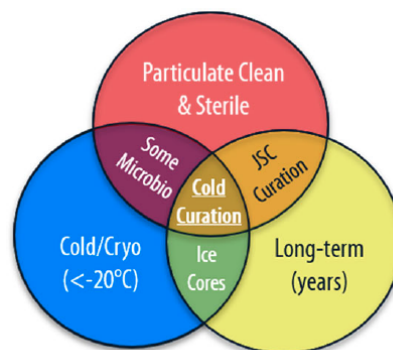

Figure III-11. Left: From Allen et al. (2011). Apollo astronaut collecting a soil sample (SESC; NASA photo AS12-49-7278). Right: From McCubbin et al. (2019), indicating the joint challenges related to cold curation and biological containment faced by astromaterials storage when collecting ice cores, as well as how capabilities need to connect.

IV. Ice core drill engineering on Earth and drilling concepts for Mars

Drilling an ice core tens of meters deep in a glacier or ice sheet on Earth is easily accomplished using either a hand auger or a light weight cable suspended electromechanical drill. Ice coring programs in many nations have various versions of these drills; in the U.S. Ice Drilling Program, the Badger-Eclipse drill is a workhorse successfully used both in the Arctic and Antarctic. It is an easily transportable cable suspended electromechanical drill that retrieves 81 mm (3.2”) diameter ice cores to depths up to 300 m. Drills of this type, which core the ice and do not involve percussive impact, reliably produce high-quality, uniform cores in clean ice, or ice with a minimal amount of enclosed dust.

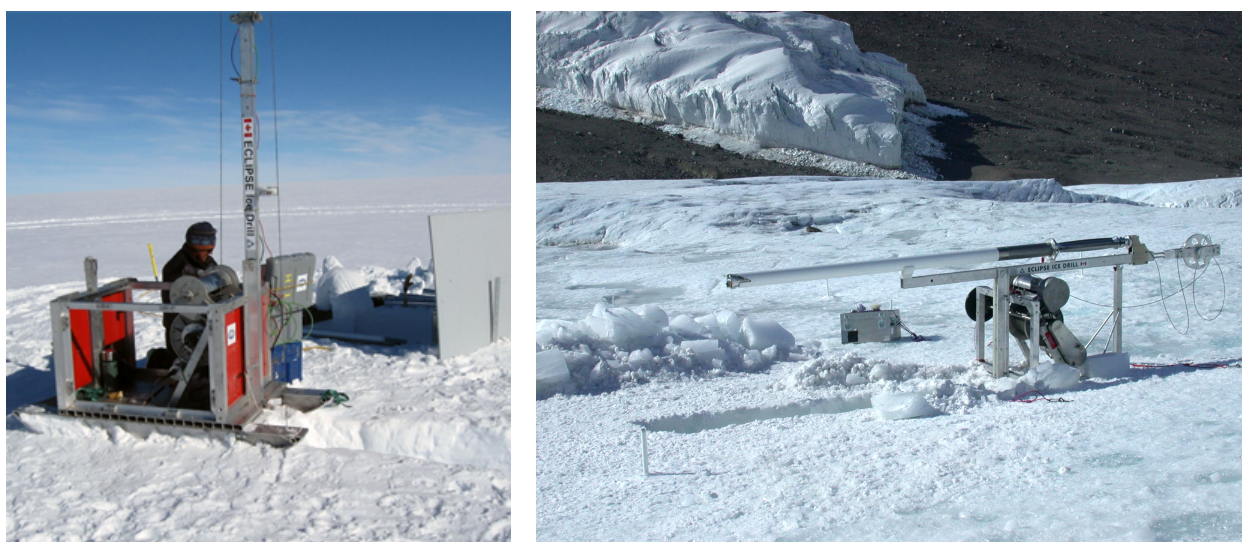

Figure IV-1. Left: IDP driller Lou Albershardt operates the Badger-Eclipse Drill at Thwaites Glacier, Antarctica, during the 2010-2011 summer field season. (Photo: Howard Conway). Right: Eclipse drill deployed at Taylor Glacier, Antarctica in 2004-2005 season. (Photo: Michelle Koutnik).

However, cable-suspended drills are not capable of drilling through rock, thick hardened soil, or composite mixtures of ice and rock. At sites that may contain various bands of rock, debris, rock/ice mixtures, or where massive ice exists but it may include thick bands of stones, hardened soil, or rock/ice mixtures the drill string should be made of pipes. The pipes are capable of delivering sufficient torque and weight on bit to drill through solid rock and rock/ice composites; on Earth all drills of this type require use of a drilling fluid. The U.S. Ice Drilling Program (IDP) has adapted several commercial rock coring drills to drill rock/ice composites, as described in Albert and others (2021). Designed for recovery of meters of rock beneath hundreds of meters of ice, or recovery of mixed rock/ice cores, the Agile Sub-Ice Geological Drill (ASIG) (Kuhl and others, 2020) has been successfully used in Antarctica, as shown in Fig IV-2. The core retrieved from the ASIG drill has a diameter of 33.4 mm. Specification and additional photos can be seen at: <https://icedrill.org/equipment/agile-sub-ice-geological-drill>

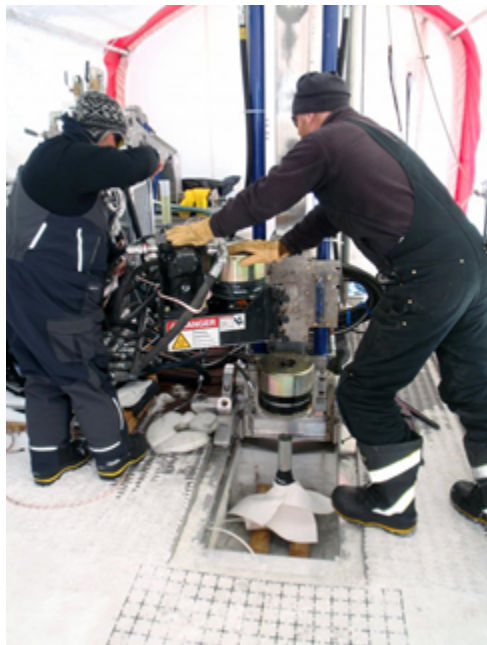

Figure IV-2. IDP drillers Clayton Armstrong (at left) and Mike Jayred (at right) operating the ASIG Drill at Pirrit Hills, Antarctica, during the 2016-2017 summer field season (Photo: Tanner Kuhl).

A lighter weight drill that is useful for retrieving meters of rock core from beneath meters of ice, including retrieval of mixed rock/ice composite cores is the IDP ice-enabled Winkie Drill (Boeckmann and others, 2020) shown in Figure IV-3. The diameter of the retrieved rock, ice, or rock/ice composite core is 39 mm. This drill has retrieved high quality rock/ice composite cores from Ong Valley, Antarctica; a composite core is shown in Figure IV-4. Further description and photos are available at <https://icedrill.org/equipment/winkie-drill>.

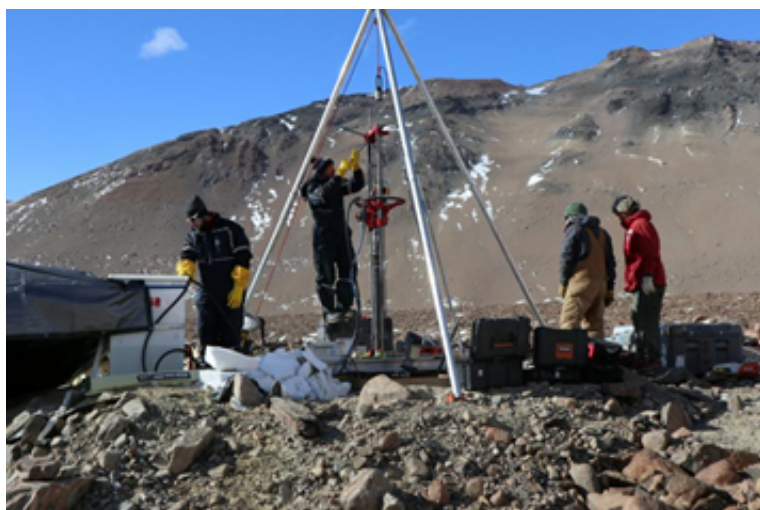

Figure IV-3. The Winkie Drill in Ong Valley, Antarctica, during the 2017-2018 Antarctic field season (Photo: Dan Morgan).

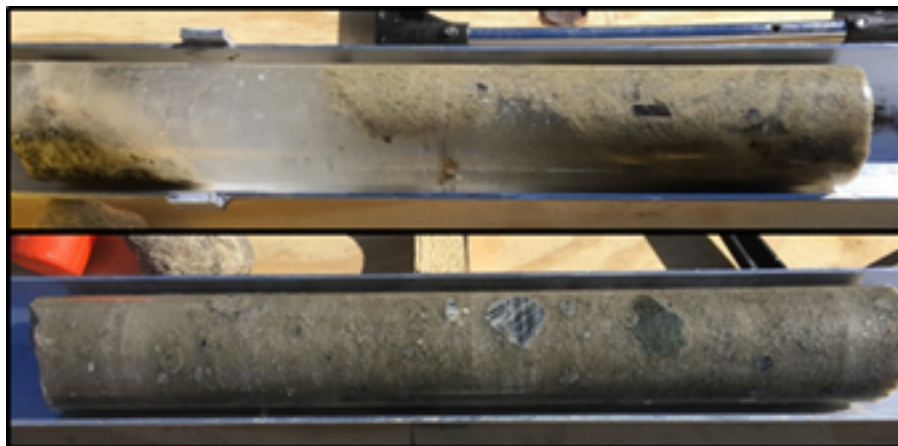

Fig IV-4. Composite ice/rock core drilled with the ice-enabled Winkie drill in Ong Valley.

WATSON (Wireline Analysis Tool for Subsurface Observation of Northern-ice sheets)

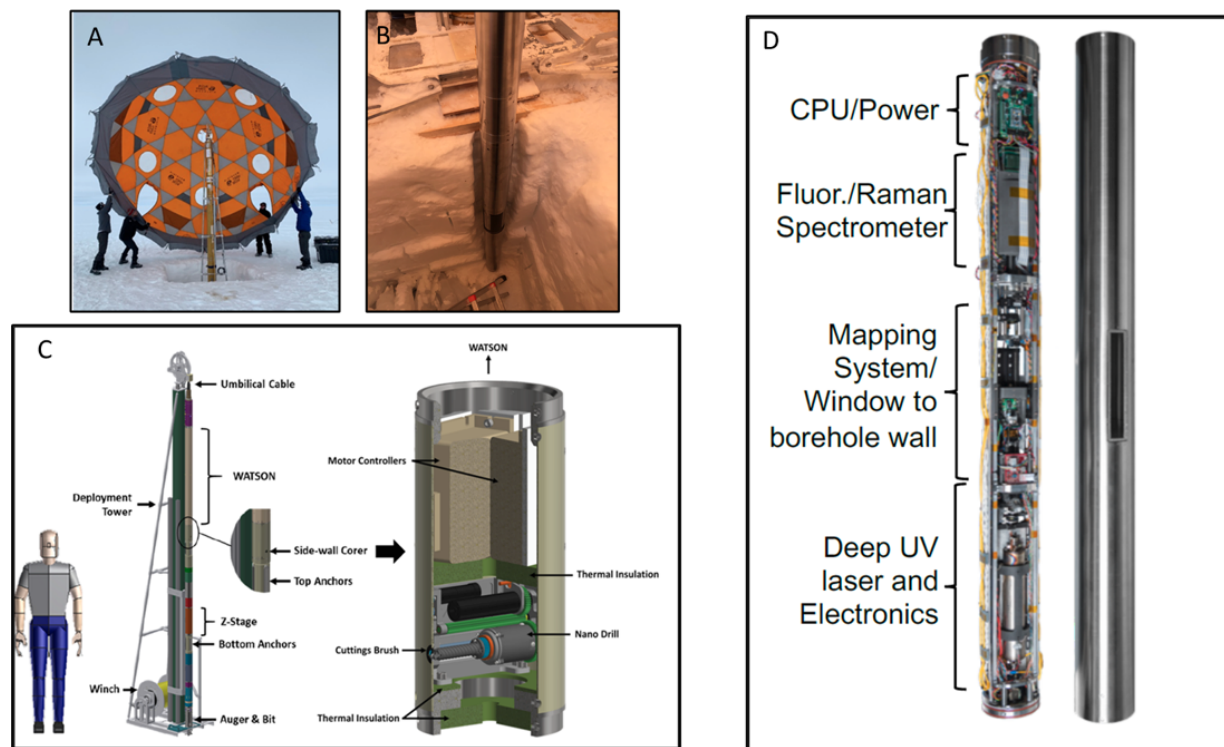

Figure IV-5. A) WATSON and drill being deployed at Summit, Greenland. B) WATSON entering the borehole. C) Schematic showing WATSON mounted to the drill. The inset shows a small nano drill that can be deployed to take targeted samples of the borehole sidewall. D) Expanded view of the deep UV system.

WATSON is an autonomous ice drill coupled to a targeted deep-UV fluorescence/Raman mapping spectrometer. The drill has been used to successfully core and identify organic matter within the borehole sidewalls (Eschelman et al. 2019, Malaska et al. 2020). The WATSON wireline deep drill is the most advanced planetary drilling system developed to date. The WATSON drill is based on traditional wireline architectures used yearly in Antarctica for recovering ice cores. However, as opposed to the Antarctic drills which are human-operated, the WATSON drilling system is fully robotic, except for a winch system. The drill system consists of three major parts: a surface subsystem which includes a deployment tower with a drum for a tether, the tether, and a probe also referred to as a drill that is attached to one end of the tether (Figure IV-5). Plans are underway to incorporate a Nano Drill for targeted sidewall drilling.

Concepts for drilling ice cores on Mars

Masses of ice that are meters or greater in thickness are thought to exist beneath surface debris in some areas, and within the ground in lesser thicknesses within permafrost areas. Based on observations of other ice on Mars and theoretical studies of ice accumulation and sublimation, it is likely that even within the meters-thick ice buried under surface debris, the ice may embed thick layers of dust or debris that had been deposited earlier.

The requirement for the drilling system includes the ability to penetrate several different types of layers: loose regolith, rocks, ice cemented ground, and ice with various fractions of particles and rocks. Nominally, there are three drilling options: the cable-suspended drill, wireline drill, and coiled tubing drill as shown in Table IV-1. All these options are being used on Earth every day, and in turn there is a significant body of published knowledge related to their limitations and benefits (Bar-Cohen and Zacny, 2009; Bar-Cohen and Zacny, 2020).

Cable-suspended drills are used traditionally in terrestrial ice coring tasks. The drill with all the required motors and sensors is housed inside a tube, which is suspended by a cable. To drill, the system is lowered into the borehole to drill a section of the hole (nominally a few meter core), upon which the drill is retracted using the cable to the surface. The core is removed and the drill is lowered back into the same hole. This approach is ideal if the borehole is stable, which is true in Antarctic and Greenland ice, for example. However, if the borehole is unstable (e.g. it has loose regolith, rocks etc.) there is a significant chance the drill would get stuck by debris falling on top of it. A potential solution is using a casing with bi-center bit, to cut a larger diameter hole that would accommodate the casing and the drill.

The wireline drill uses a traditional jointed pipe (as used in the oil and gas industry) approach to drilling. It has pipes that are screwed together to advance the drill down. To capture a core sample, the hollow pipe has a coring section that can be lowered down and pulled out using a wire. As such, the pipes stay inside a hole (and prevent borehole collapse), while a separate wire with a coring section is used to remove the cores.

Table IV-1. *Three types of drilling approaches that can be considered for core capture.*

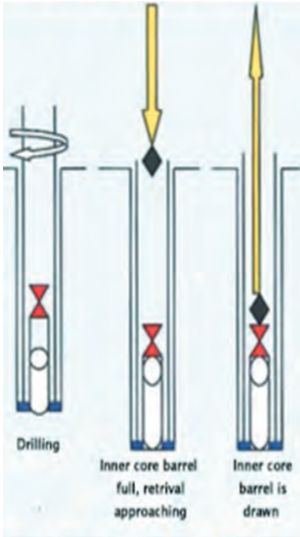
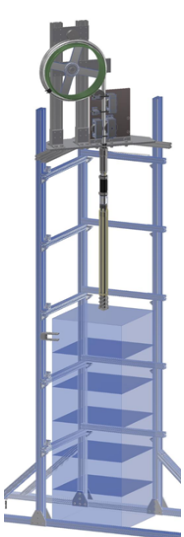
	Cable Suspended	Wireline	Coiled Tubing
			
Complexity	Low	High	Medium
Mass	Low	High	Medium
Drilling fluid	No	Yes (Gas)	Yes (Gas)
Terrestrial use	Ice coring	Oil and gas	Oil and gas
Formations it can penetrate	Ice	Any	Any
Borehole stability	Needs casing which would drive complexity	Not a problem	Not a problem
Downhole instruments?	Yes	No	Yes
Example of planetary system	WATSON: 111 m in Greenland AutoGopher2: 7 m in gypsum Planetary Deep Drill: 14 m in gypsum	MARTE: 8 m in rock quarry SCAD: 10 m in rock quarry	RedWater: 1 m in ice - limited by height of freezer. Designed for 25 m.
TRL	5	4	4
Reference	Mellerowicz et al., (2018); Badescu et al., (2018); Zacny et al., (2013; 2016)	Bar-Cohen and Zacny (2009) Paulsen et al. (2006)	Bar-Cohen and Zacny (2020) Zacny et al. (2018)

Coiled Tubing drilling is nominally used to drill a hole, and not a core, but could be adapted to drill a core. Unlike in the Jointed Pipe approach where each pipe is straight, Coiled Tubing has a continuous ‘pipe’ that’s wrapped around a drum (this is similar to how a tape measure works, except that it is a tube and not a strip). To advance the drill forward, a set of rollers is used to pull the tube down while making it straight. The drilling system, motors and the drill bit, are mounted at the end of the ‘pipe’. To capture the core, a coring bit is lowered into the borehole and once the core is captured, the drum is spun in reverse to coil the tubing back. Coiled Tubing prevents borehole collapse because the tubing is always in the hole while the drill operation occurs.

Over the past two decades, several planetary prototypes have been developed and tested in the laboratory and/or in the field. In particular, Cable Suspended drills such as AutoGopher (Badescu et al., 2018) and Planetary Deep Drill (Zacny et al., 2016) have been tested in gypsum quarry to 7 m and 14 m depth, respectively. WATSON, with an integrated deep-UV / Raman spectrometer was tested to 111 m depth in Greenland’s Summit (Mellerowicz et al., 2018, Malaska et al. 2020). Figure IV-6 shows WATSON drill tests in Greenland and possible implementation on a Mars Curiosity-size rover. WATSON incorporates borehole instrumentation enabling in-situ detection of biological material and associated organics distributed in the ice. Such measurements will provide an immediate understanding of the geochemical and physical features that drive the distribution of organic matter. In situ borehole measurements provide spatial information that can be used to target sampling in returned ice cores minimizing contamination and loss of native material from effects of dilution from bulk analysis. In situ borehole measurements will also provide a means to handle/process smaller cores; enabling spectral and single-cell resolution chemical imaging analyses previously unavailable.

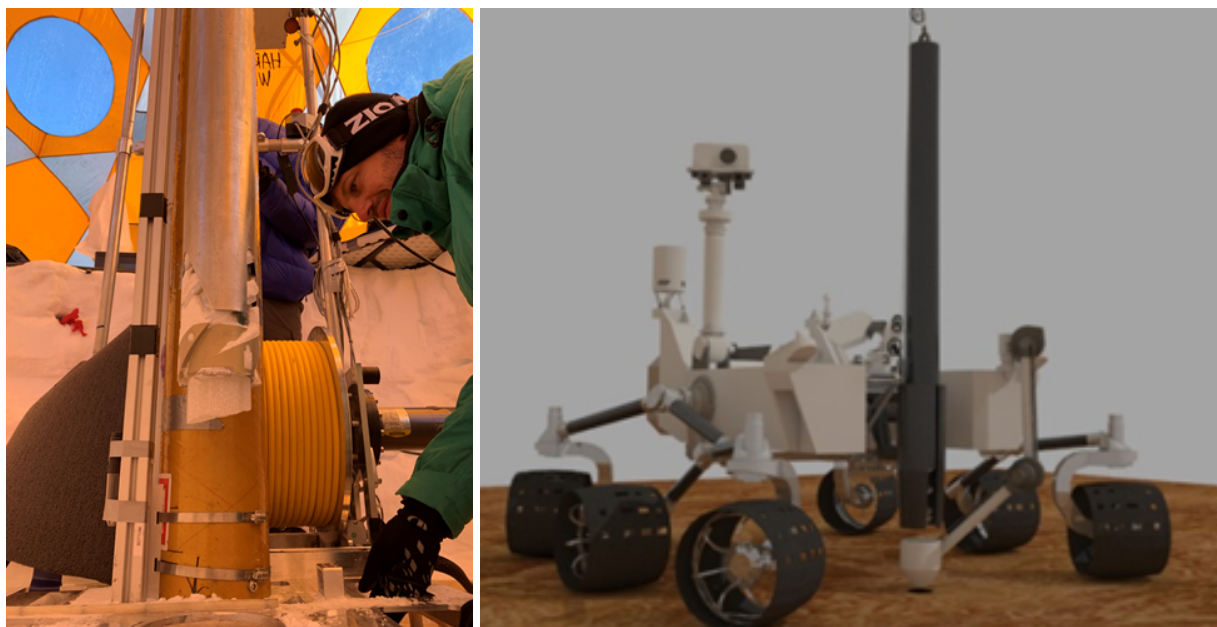

Figure IV-6. *Left: Wireline drill, WATSON, being tested in Greenland. Right: WATSON implementation on Curiosity size rover.*

A wireline system called SCAD, was laboratory tested to over 2 m depth in rock (Bar-Cohen and Zacny, 2009). The MARTE coring drill was tested to 8 m in limestone quarry (Paulsen et al., 2006). Figure IV-7 shows MARTE and SCAD systems.

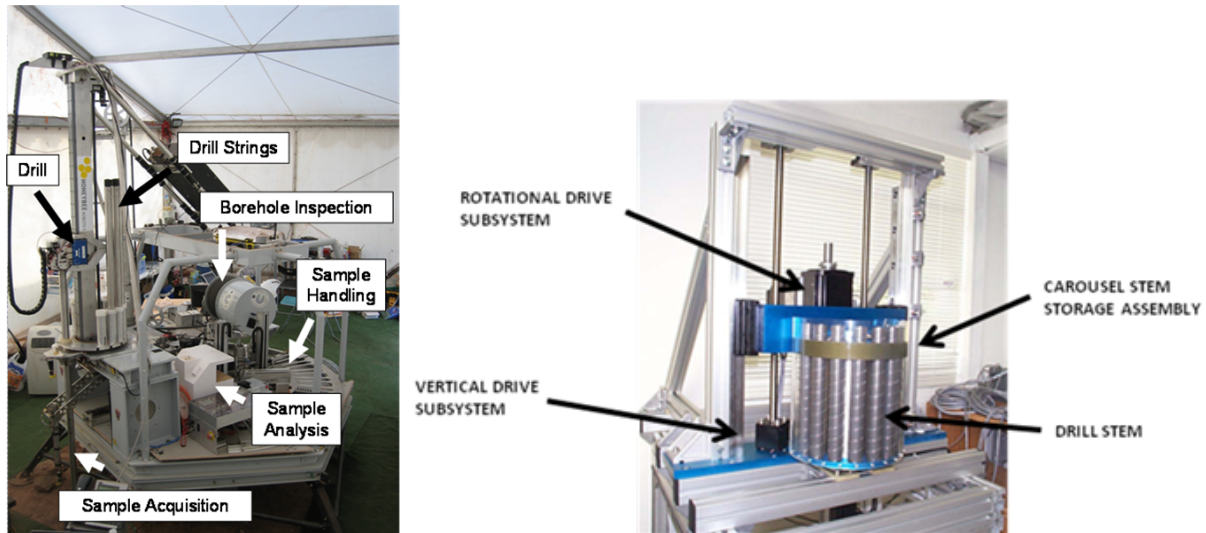

Figure IV-7. Left: MARTE coring drill with sample analysis system. Right: SCAD coring system.



Figure IV-8. Left: Coiled Tubing drill, RedWater, being tested in a freezer. Right: RedWater implementation on NASA All-Terrain Hex-Limbed Extra-Terrestrial Explorer (ATHLETE) rover.

A Coiled Tubing drill such as RedWater (Zacny et al., 2018) is currently being tested in a freezer - it has successfully drilled in ice to 1 m depth; the depth being limited by the height of the freezer. RedWater is being developed for water extraction on Mars, with a goal to drill through 20 m of overburden followed by 5 m in ice. Once in ice, the drill would melt and pump water to the surface. Figure IV-8 shows RedWater tests in a freezer and implementation on the NASA All-Terrain Hex-Limbed Extra-Terrestrial Explorer (ATHLETE) rover.

V. Requirements from science for engineering an ice coring drill for Mars

1. Tradeoffs between optimal cores/science and drilling & logistical constraints

There are important tradeoffs between the scientific needs of amount and quality of core and the logistical feasibility of drilling and retrieving the core on Mars. The very high quality cores (free from gouges or cracks) resulting from deep ice core drilling on Earth, such as in the South Pole ice core, have core diameters of 98 mm. These cores have good core strength (outside of the brittle zone) and can survive drilling and handling, and they also yield enough ice to support a robust set of scientific measurements. A mission to Mars would not have logistics capability to return multiple meters of 98 mm core. Thus smaller-diameter cores will be considered in this section.

2. Characteristics of Martian ice cores and their potential to yield scientific results

A 76 mm diameter core can be drilled with excellent core quality, and the core diameter is sufficiently strong to maintain its integrity through the drilling/packing/shipping process. A 76 mm core also can support a meaningful set of scientific measurements, for example cryobiology, stratigraphy, density, chemistry, and isotopes.

Ice core with 50 mm diameter would be valuable for investigating cryobiology, along with water isotopes and chemistry, even if the core was not entirely intact but had significant contiguous pieces. Full cores would not likely result from the drilling process, rather core pieces of varying lengths between approximately 6 to 15 mm would result that may challenge stratigraphic analysis and lead to lower resolution in most measurements.

If the drilling does not provide core, but instead results in only chips with a maximum diameter approximately 6 mm, cryobiology measurements would be possible only at low resolution and decontamination procedures would be very challenging, but very low-resolution measurements of water isotopes and chemistry would be possible. A drill that produces chips could be augmented with a sidewall corer to capture smaller cores (e.g. 2 cm in diameter and 5 cm long) at target locations. These locations could be selected using co-located instruments, such as Raman / deep UV. See Table V-2 for a summary of how measurements relate to core/sample characteristics.

If the drill produces water that is refrozen for the return trip to earth, some aspects of cryobiology may be observable, but evidence of the habitability near the biological samples would be lost.

Engineering challenges associated with core diameter for drilling on Mars

In consideration of engineering aspects of a drill for use on Mars, Table V-1 below indicates the level of engineering and logistics difficulty for 3” core (similar to the Badger-Eclipse ice coring drill), 2” core (similar to the core from a rock core drill), or only chips (chips have a max diameter of approximately 6 mm).

Table V-1. *Challenges for drill engineering as a function of core diameter.*

Metric	Core retrieval: Good quality	Core retrieval: Poor quality	Chips retrieval
Core diameter	Needs to be >100 mm	Needs to be > 50 mm	N/A
Borehole diameter	>100 mm	>76 mm	~50 mm
Drill mass / volume / power	Very high	High	Low
Drill complexity	Very high - Need different bits for regolith / rock and ice - Need complex bottom hole assembly or different rigs for drilling through regolith / rock and then ice	High - May use same bits for regolith / rock and ice but core quality will be compromised - Need complex bottom hole assembly or different rigs for drilling through regolith/rock and then ice	Low
Sample handling	- Need individual core tubes - Cores remain in sampling tubes – manipulate tubes	- Need individual core tubes - Cores remain in sampling tubes – manipulate tubes	Chips packaged and sealed in individual containers (e.g., every 20cm)
Planetary Protection/Containment Control	Very complex	Very complex	Easier

A drill that produces only chips has the least complexity and easier sample handling than a drill that produces core, however retrieving only chips severely limits the scientific value of the material. A drill that retrieves 3” cores will require a very high amount of power, a lot of drilling complexity, more steps in core handling, and very complex Planetary Protection/Containment Control (PP/CC), yet the core from such a drill could include a scientifically-rich return. A drill that retrieves broken 2” cores requires a high amount of

power and is complex. Because of the smaller diameter, the core could be broken. If rock/regolith bits are used, the core quality would be lower, as well. The science value of a broken 2" core is not as high as a 3" core, but it is significantly better than retrieving only chips. Note that in this case automation of the placement of the core or core pieces into a hermetically sealed tube should be considered to maintain biological integrity of the samples.

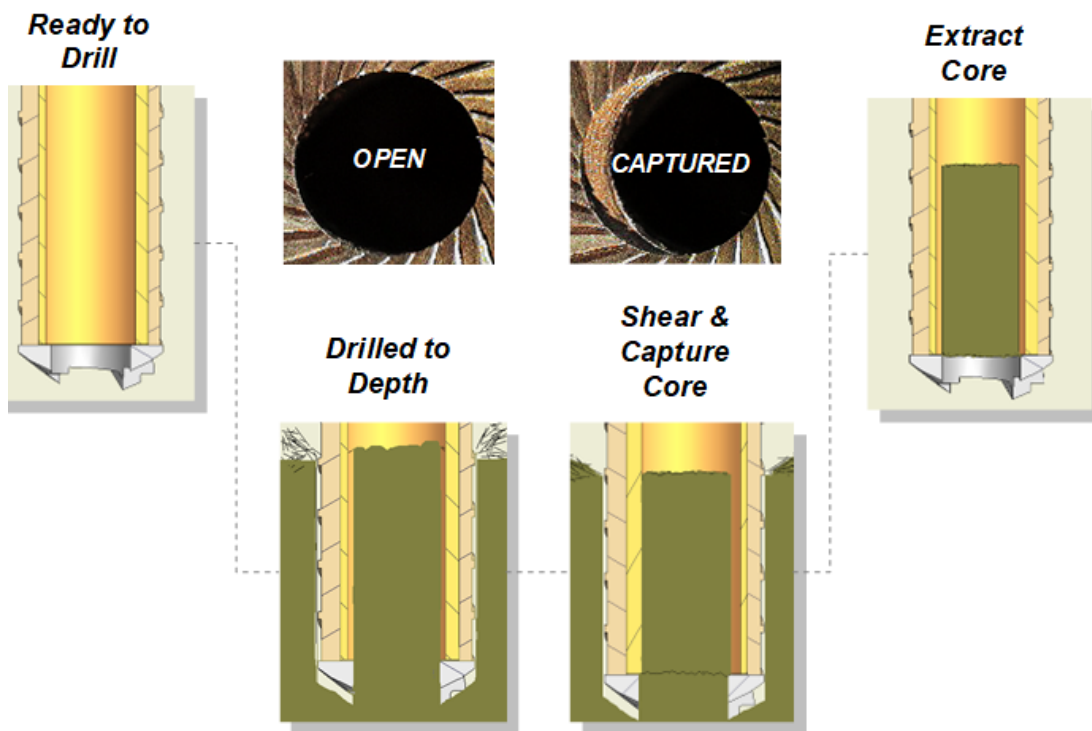

Figure V-1. Eccentric tube core breakoff approach is a robust method of breaking and retaining a core.

A critical aspect of coring is core break-off and retention. This is a non-trivial operation and it has to work with good quality and poor quality (broken up) cores. Traditional ice coring systems use so-called 'dogs' - a set of three blades that pinch the core, create a small notch, and break the core in tension as the core drill is being retracted. Dogs do not always work - if ice is too hard, they may slide; if ice is broken up, ice chips will fall down to the hole bottom.

A more robust (but also more complex) approach is to use an eccentric core breakoff system (Myrick 2003; Zacny et al., 2011). In this approach, the bit and the breakoff tube each have bores which are slightly offset from center by the same distance (Figure V-1). The breakoff tube is installed within the offset bore inside of the bit. During the drilling process, the two tubes are aligned such that the thru bore of the breakoff tube is aligned with the drilling axis. When core breakoff is desired, the breakoff tube is rotated relative to

the bit, which gradually shifts the central axis of the breakoff tube. This pushes the entire portion of the core within the bit to one side, shearing it at the base. This technology results in the narrowest possible kerf (annular groove cut by the bit or the width of a cut), which enables low weight on bit (WOB), power, drilling time and energy compared to other core breakoff mechanisms. This core break off approach is also robust to broken up cores and a small step at the bit, helps to retain the core. This technology has been implemented on the Mars Perseverance rover mission.

Figure V-2 illustrates what measurements are possible to address high-priority science questions as a function of core quality, where some measurements require continuous ice core (ice core is in five or fewer pieces per meter with relatively few cracks) and other measurements can be made on fractures (ice core is in six or more pieces with frequent cracks) or pieces of core (fractured core and stratigraphic order is uncertain at the cm scale and shorter), as well as on chips (6 mm in diameter maximum). The resolution of the measurements and the utility of the measurements to address science questions increases with the quality of the core. While obtaining pieces of ice core or only chips is easier for drill engineering and logistics, decontamination procedures become increasingly more difficult as the core quality goes down.

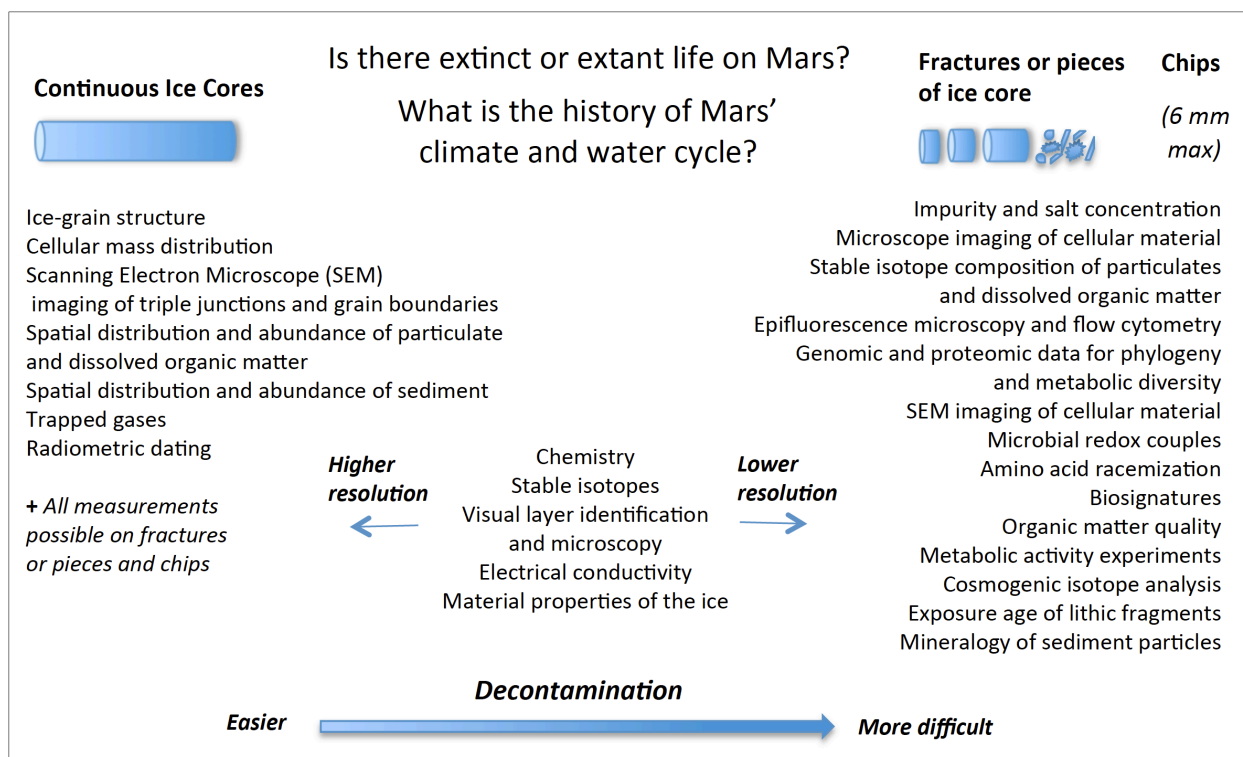

Figure V-2. Measurements that could be conducted on continuous ice cores or on fractures or pieces of ice core, as well as on chips, in order to address high-priority science. Some measurements are only possible on continuous ice cores, and the measurements possible on fractures or pieces of ice core and chips will be lower resolution.

Scientific requirements related to drilling on Mars

The choice of drill and characteristics of the recovered cores determines what measurements can be made. Figure V-2 groups all of the measurements identified by the Working Group that could be used to address the high-priority science questions. All measurements can be conducted on continuous ice core samples, but only certain measurements can be collected on fractures or pieces of core, or only core chips. The resolution decreases as the core quality decreases, and the challenge of decontamination increases as the core quality decreases.

Sample quantity is also a consideration with respect to the number and quality of measurements that are possible. Table V-2 includes estimates of the amount of core/sample required based on contemporary technology. If there is sufficient core continuity and quality, some measurements may be combined as part of a Continuous Flow Analysis (CFA) system in order to maximize the number of measurements that can be made on the same sample (see Section II.7).

Table V-2. *There are at least 34 measurements that may be made on the first ice cores from Mars. Amount of the ice sample for each measurement is estimated to the best of our knowledge based on contemporary measurement technology.*

Measurement on the returned core/sample	Amount of core/sample	Condition of the ice core	Possible to measure on chips without a core?
	<i>(Estimate based on contemporary technology)</i>	<i>(Continuous, Fractures, or Pieces)</i>	<i>(chips are 6mm maximum)</i>
Detection and spatial distribution of organic matter	~ 0.5 g	Continuous	No
Cellular mass and distribution	~10 ml melted	Continuous	No
Sediment mass and distribution	--	Continuous	No
Gases	1000g	Continuous	No
Radiometric dating (gas)	500g (U); 5000g (Kr)	Continuous	No
Grain structure	~ 0.5 g	Continuous; Fractures	No
Scanning Electron Microscope imaging of triple junctions and grain boundaries with ice and different T	~ 0.5 g	Continuous; Fractures	No
Electrical conductivity	Non-destructive, but smooth surface may be needed requiring polishing	Continuous; Fractures*	No

Visual layer identification and microscopy	Non-destructive, but smooth surface may be needed requiring polishing	Continuous; Fractures*	No
Material properties of the ice (density, crystal/grain structure, bubble distribution)	Requires thin sections	Continuous; Fractures*	No
Frequency and thickness of debris/dust layers	non-destructive, but smooth surface may be needed requiring polishing	Continuous; Fractures*	No
Core impurity and salt concentrations	<i>Variable</i>	Continuous**; Fractures; Pieces*	At low resolution
Chemistry of the ice	3g	Continuous**; Fractures; Pieces*	At low resolution
Water (ice) Stable isotopes	0.1g D/H and O ¹⁸ /O ¹⁶ ; 1g O ¹⁷ /O ¹⁶	Continuous**; Fractures; Pieces*	At low resolution
Microbial redox couples	5 ml melted	Continuous**; Fractures; Pieces*	At low resolution
Amino acid racemization	~10 ml melted	Continuous**; Fractures; Pieces*	At low resolution
Stable isotope composition of particulates and dissolved organic matter	<i>Variable</i>	Continuous**; Fractures; Pieces*	At low resolution
Scanning Electron Microscope imaging of cellular material	~10 ml melted	Continuous**; Fractures; Pieces*	At low resolution
Epifluorescence microscopy and flow cytometry using select metabolic stains (DNA, Redox, live/dead)	~10 ml melted	Continuous**; Fractures; Pieces*	At low resolution
Genomic and proteomic data for phylogeny and metabolic diversity	Depends on how many cells are observed (10 ⁶ -10 ⁸ DNA containing cells)	Continuous**; Fractures; Pieces*	At low resolution
Metabolic activity using tritiated and 14C-labeled (radiolabeled) substrates (amino acids, sugars, metabolic intermediates)	50 ml melted	Continuous**; Fractures; Pieces*	At low resolution
Respiration of radiolabeled 14C substrates	Can be incorporated into the metabolic activity expts	Continuous**; Fractures; Pieces*	At low resolution
Selected aerobic and anaerobic culturing of heterotrophs and chemoautotrophs, methanogens, methanotrophs, etc.	~10 ml melted	Continuous**; Fractures; Pieces*	At low resolution
Biosignatures (gases, lipids, polysaccharides, PAHs aliphatic and aromatic compounds)	<i>Variable</i>	Continuous**; Fractures; Pieces*	At low resolution

Organic matter quality	~20 ml	Continuous**; Fractures; Pieces*	At low resolution
Determination of metabolic free energy based on geochemical measurements	~20 ml	Continuous**; Fractures; Pieces*	At low resolution
Metabolic potential of cells to repair damage induced by the oxidation potential of the habitat	Can combine with metabolic rate experiments	Continuous**; Fractures; Pieces*	At low resolution
Major ion concentration	<i>Variable</i>	Continuous**; Fractures; Pieces*	At low resolution
Cosmogenic nuclides	One example: 5 g for ¹⁰ Be	Continuous; Fractures; Pieces*	At low resolution
Exposure age of lithic fragments	10 g quartz for ¹⁰ Be, 30g quartz for ²⁶ Al	All	Yes
Physical properties of dust/tephra	1mg	All	Yes
Composition	1mg	All	Yes
Minerology of sediment particles	1mg	All	Yes
Physical and chemical properties of the regolith surface	<i>Variable</i>	--	At low resolution

* *Utility of records increases with core quality*

** *Measurement on a continuous core can be combined in a Continuous Flow Analysis (CFA) system to maximize the number of measurements on the ice samples*

A drill that incorporates borehole instrumentation will enable in-situ detection of biological material and associated organics distributed in the ice. Such measurements will provide an immediate understanding of the geochemical and physical features that drive the distribution of organic matter. In addition, borehole measurements will provide spatial information that can be used to target sampling in returned ice cores minimizing contamination and loss of native material from effects of dilution from bulk analysis. It will also provide a means to handle/process smaller cores; enabling spectral and single-cell resolution chemical imaging analyses previously unavailable.

3. Requirements of engineering to optimize the scientific return from ice coring in the mid-latitude of Mars

The following requirements assume that the ice core will be retrieved from the mid-latitudes beneath a debris overburden, and that the core returned is up to 10 meters long. This ten meters of material may include bands of ice and dust/debris/rock/cemented ground, and it also should be assumed that the drill will encounter mixtures of ice, rocks and debris.

The requirements of engineering to optimize the scientific return from ice cores include:

1. We have assumed that prior to the mission to drill the ice core, a mission will return the highest resolution possible radar images of the top 20 meters of potential ice core sites; these will inform site selection as well as aid interpretation of eventual measurements from the core.
2. Ground-based imaging of the subsurface will occur at the site to characterize the site and select an optimal location before drilling commences.
3. A key requirement for the drilling system on Mars is the ability of the drill to penetrate several different types of layers: loose regolith, rocks, ice cemented ground, and ice with various fractions of particles and rocks.
4. If a drilling fluid (e.g. compressed gas) is used, its chemical composition must not contaminate the samples for biological investigations.
5. Retrieval of continuous core will optimize the scientific return.
6. Analysis of potential scientific findings from ice that has not been retrieved from coring but instead from chipping the ice (a chip has maximum length 6 mm) should be carefully considered before designing a drill for retrieving chips of ice from Mars.
7. Robotic drilling and core handling should be used to the greatest extent possible.
8. If possible, replicate coring should be included with drill design to retrieve additional ice from depths where ice probes have detected signs of life or significant events.
9. The core should be maintained at its original temperature and pressure at all times through the handling on Mars, transport to Earth, and storage in a facility on Earth.
10. Borehole logging and on site measurements from melt probes should be used to replicate or augment data from the core. Borehole instrumentation such as that included in the WATSON drill (described above) could target organic matter “hot spots” which can then be sites of horizontal drilling. Small targeted sidewall cores would reduce the size of core necessary for detection of analytes of interest.
11. If possible, a robotic method for placing ice cores in hermetically sealed tubes according to the Mars 2020 protocol immediately upon removal from the drill should be designed and built in connection with drill development.
12. Appropriate storage and protection units should be designed and tested to ensure that they maintain the integrity of the ice samples after drilling, during the return flight, and when storing in an archival facility on Earth.
13. Improve methods of core measurement and analysis to reduce the required quantity and quality sample beyond current capabilities that were identified in Table V-2 above.
14. Include plans for borehole instrumentation into drill design planning.

VI. Other enabling technologies for in-situ measurements on Mars

Targeted side-wall cores

Borehole instrumentation such as that included in the WATSON drill (described above) could target organic matter “hot spots” which can then be sites of horizontal drilling. Small targeted sidewall cores would reduce the size of core necessary for detection of analytes of interest.

Thermal melt probe

Melt probes descend vertically through nearly pure ice using electrical power supplied from the surface, conducted along wires that pay out from within the probe as the melt hole above refreezes. They could also be deployed into a low-impurity ice mass from a borehole that was drilled through debris. Advances in the probe technology have now made high-voltage operation reliable, specifically with recent developments of the Ice Diver thermal probe led by Dale Winebrenner (University of Washington - Applied Physics Laboratory). The University of Washington Ice Diver is 170 cm long with a diameter of 6.5 cm, uses pendulum steering to maintain vertical travel, and carries 1100 m of spooled wire. Two field tests (July 2013 and July 2014) were conducted at an ablation-zone site in southwest Greenland (1000 m elevation, near-surface ice temperature -15°C) and demonstrated its potential. Using higher power the probe was capable of descending 6.6 m/hr. The Ice Diver includes thermistors, but the Ice Diver technology could be adapted to host other instruments. A desirable configuration is to integrate a dust logger (Bay et al., 2001), which shines light into the ice surrounding a borehole. The reflected signal precisely tracks impurity layers through absorption and scattering and is a sensitive tracer of continental mineral dust and volcanic ash. Additional configurations could include that the Ice Diver hosts a laser spectrometer for measuring water isotopes and gases. In a different application of the probe, Ice Diver could also be modified to return water and gas samples to the surface. Thermal melt probes work well in low impurity ice but drilling efficiency is hampered greatly in sediment laden ice. Additional information can be found at:

https://apl.uw.edu/project/project.php?id=ice_diver

VII. Select relevant resources and organizations that may have related experience and technologies

The Terms of Reference for this report requested that the Mars Ice Core Working Group identify other organizations and resources that may have insights or specialized capabilities that could be useful in planning or instrument testing for engineering drills capable of ice coring on Mars. Highly specialized and relevant scientific expertise exists at many universities across the U.S. and beyond; we do not attempt to list those here. A list of select relevant resources and organizations that may have related experience and technologies includes:

- 1) U.S. Ice Drilling Program: <https://icedrill.org/>
- 2) Ice Drilling Program Ice Core Working Group: <https://icedrill.org/about/science-advisory-board/working-groups#icwg>
- 3) National Science Foundation Ice Core Facility: <https://icecores.org/>
- 4) Juneau Icefield Research Program (test site): <https://juneauicefield.org/>
- 5) Honeybee Robotics: www.honeybeerobotics.com
- 6) Mars Exploration Program Analysis Group (MEPAG): <https://mepag.jpl.nasa.gov/>
- 7) Astromaterials Acquisition & Curation Office: <https://curator.jsc.nasa.gov/>
- 8) Astromaterials Research & Exploration Science: <https://ares.jsc.nasa.gov/>
- 9) NASA Jet Propulsion Laboratory

VIII. Recommendations

Research prior to the Mars ice core mission

We assume that a satellite radar mission capable of imaging the upper 20 meters of the subsurface will have occurred prior to the ice coring mission. High-resolution imagery is also valuable.

- All available data should be analyzed to characterize and understand processes in the upper 20 m of several potential drill sites. Based on these analyses, targeting a site to drill in ground ice or in glacial ice, or both, must be determined.

Key characteristics of Martian ice cores crucial to NASA's research objectives

NASA will need to evaluate the tradeoffs between 1) collecting a high quality ice core with diameter between 50 to 76 mm that is optimized for scientific return but at the expense of requiring a relatively complex and logistically difficult drill, versus 2) collecting 6 mm diameter ice chips that support less of the high-priority science objectives but can be achieved with a non-coring drill that is logistically easy by needing to only grind through ice to produce chips.

Minimum attributes of a mission that minimizes logistics through deployment of a chip drill:

- *Sample acquisition:* Deploy a drill that collects only chips (defined as <6mm).
- *Ice chips processing:* Retain stratigraphic order of the chips and seal immediately to avoid sublimation and contamination. Follow sample handling procedures established for Mars 2020 to minimize contamination.
- *Sample allocation:* TBD by scientists chosen by NASA.
- *Archiving practices:* Follow Mars 2020 protocol.

Range of attributes of a mission that maximizes scientific return through deployment of an ice-coring drill:

- *Sample acquisition:* Deploy an ice coring drill that collects a 76 mm diameter ice core (preferable) or 50 mm diameter fragmented ice core. If a drilling fluid is used, it must preserve the integrity of biological samples in the ice.
- *Ice core processing:* Immediately upon removal from the drill, place cores in hermetically sealed bags in 1-m increments, and store according to the Mars 2020 protocol.
- *Sample allocation:* TBD by scientists chosen by NASA.
- *Archiving practices:* TBD by scientists chosen by NASA.

Number of ice cores and quantity of ice core collected

For a core-collection mission:

- A continuous ice core (in five or fewer pieces per meter with relatively few cracks) collected and/or stored in meter-long increments is ideal.

- Collect at least 50 cm of debris/dust/regolith or permafrost from the overburden layer as a core sample; if the overburden layer is multiple meters thick then additional samples may be warranted.
- Collect 10 meters of core that is predominantly ice but may contain thick bands of ice mixed with rocks, regolith and other debris.
- Borehole instrumentation can be used to target locations for horizontal drilling to collect small, targeted sidewall cores (for example, using the WATSON drill).
- Collect multiple cores from the same local site for at least two reasons:
 - As control cores for all measurements in order to rigorously examine contamination, as well as for corroboration. Controls are equally important samples, and for these reasons were incorporated as part of Mars 2020.
 - To maximize the number and type of measurements that can be made on the limited ice recovered.
- If possible, replicate coring should be designed with the drill so that borehole instrumentation, such as that included in the WATSON drill, for example, could target organic matter “hot spots” which can then be sites of horizontal drilling. Small targeted sidewall cores would reduce the size of core necessary for detection of analytes of interest.

For a chip-collection mission:

- Depending on the site characteristics, collect multiple surface samples.
- Collect multiple chip cores, ideally from both ground ice and glacial ice.
- Design a measurement plan that integrates chip coring and borehole instrumentation, as well as possibly sidewall (horizontal) drilling, in order to maximize scientific return.

Ice core site selection and in-situ measurements

- Soon after the Mars ice core mission lands, a high-resolution ground-penetrating survey around the chosen ice core drill site should be conducted to provide context for ice core interpretation.
- Ambient air temperature and chemical composition measured over site occupancy time.
- Borehole temperature profile after drilling is finished.
- Consider melt probe autonomous measurements of ice temperature and water isotope profile if thick undisturbed ice exists at a location within 5 m of the ice core borehole.

Additional data collection to support drill-site selection and sample interpretation

- Surface samples through the overburden layer and at the interface between the overburden and the ice-rich deposit should be collected.
- Additional samples of permafrost, regolith, debris, rock, and dust from the region near the drill site should be collected, with a plan determined based on characteristics of the target site.

Ice core archive

- In addition to storing samples according to protocols for cold curation and biological containment, including storage of contamination references, some samples should remain archived for future use. Archiving material is a valuable practice for terrestrial ice cores and lunar samples, and allows new technologies to be applied in future investigations.

Technology development

- As determined by NASA after science-logistics tradeoffs, create either a chip drill, or a 2" (or 3") coiled tubing or jointed pipe ice coring drill.
- Development of lateral coring capability off of the main borehole, for retrieval of material at depths that probes have indicated are scientifically very significant.
- Development of an autonomous ice probe that measures temperature and water isotopes as it melts down through the ice.
- Measurement techniques should try to use the least amount of ice possible, including scientific measurement capabilities on ice chips, which may require new measurement technologies.
- Temperature probes and deep-UV spectroscopy should be developed in association with the drill development to optimize scientific return.

References

- Aciego, S., Bourdon, B., Schwander, J., Baur, H., & Forieri, A. (2011). Toward a radiometric ice clock: uranium ages of the Dome C ice core. *Quaternary Science Reviews*, 30(19), 2389–2397. <https://doi.org/10.1016/j.quascirev.2011.06.008>
- Albert, M. R., Slawny, K. K., Boeckmann, G., Gibson, C. J., Johnson, J. A., Makinson, K., & Rix, J. (2021). Recent Innovations in Drilling in Ice. *Chapter 6 of Advances in Terrestrial Drilling: Ground, Ice and Underwater*, Bar-Cohen and Zacny, eds., 157-220. CRC Press/Taylor; Francis Group, LLC. LCCN 202037780, ISBN 978-0-367-65346-0. <https://icedrill.org/library/recent-innovations-drilling-ice>
- Allen, C., Allton, J., Lofgren, G., Righter, K., & Zolensky, M. (2011). Curating NASA's extraterrestrial samples—Past, present, and future. *Geochemistry*, 71(1), 1–20. <https://doi.org/10.1016/j.chemer.2010.12.003>
- Alley, R. B., Meese, D. A., Shuman, C. A., Gow, A. J., Taylor, K. C., Grootes, P. M., et al. (1993). Abrupt increase in Greenland snow accumulation at the end of the Younger Dryas event. *Nature*, 362(6420), 527–529. <https://doi.org/10.1038/362527a0>
- Alsaeed, N. R., & Jakosky, B. M. (2019). Mars Water and D/H Evolution From 3.3 Ga to Present. *Journal of Geophysical Research: Planets*, 124(12), 3344–3353. <https://doi.org/10.1029/2019JE006066>
- Badescu, M., Bar-Cohen, Y., Sherrit, S., Bao, X., Jackson, S., Metz, B., et al. (2018). Auto-Gopher-II: a wireline rotary-hammer ultrasonic drill that operates autonomously. In *Sensors and Smart Structures Technologies for Civil, Mechanical, and Aerospace Systems 2018* (Vol. 10598, p. 105982W). International Society for Optics and Photonics. <https://doi.org/10.1117/12.2294560>
- Bar-Cohen, Y., & Zacny, K. (2009). *Drilling in Extreme Environments: Penetration and Sampling on Earth and other Planets*. Wiley. <https://www.wiley.com/en-us/Drilling+in+Extreme+Environments%3A+Penetration+and+Sampling+on+Earth+and+other+Planets-p-9783527626632>
- Bar-Cohen, Y., & Zacny, K. (2020). *Advances in Terrestrial and Extraterrestrial Drilling: Ground, Ice, and Underwater*. CRC Press/Taylor & Francis Group LLC. Boca Raton, FL. <https://www.routledge.com/Advances-in-Terrestrial-and-Extraterrestrial-Drilling-Ground-Ice-and-Bar-Cohen-Zacny/p/book/9781138341500>
- Barletta, R. E., Priscu, J. C., Mader, H. M., Jones, W. L., & Roe, C. H. (2012). Chemical analysis of ice vein microenvironments: II. Analysis of glacial samples from Greenland and Antarctica. *Journal of Glaciology*, 58(212), 1109–1118. <https://doi.org/10.3189/2012JoG12J112>
- Becerra, P., Sori, M. M., Thomas, N., Pommerol, A., Simioni, E., Sutton, S. S., et al. (2019). Timescales of the Climate Record in the South Polar Ice Cap of Mars. *Geophysical Research Letters*, 46(13), 7268–7277. <https://doi.org/10.1029/2019GL083588>

- Bidle, K. D., Lee, S., Marchant, D. R., & Falkowski, P. G. (2007). Fossil genes and microbes in the oldest ice on Earth. *Proceedings of the National Academy of Sciences*, *104*(33), 13455–13460. <https://doi.org/10.1073/pnas.0702196104>
- Boeckmann, G. V., Gibson, C. J., Kuhl, T. W., Moravec, E., Johnson, J. A., Meulemans, Z., & Slawny, K. (2020). Adaptation of the Winkie Drill for subglacial bedrock sampling. *Annals of Glaciology*, 1–9. <https://doi.org/10.1017/aog.2020.73>
- Boetius, A., Anesio, A. M., Deming, J. W., Mikucki, J. A., & Rapp, J. Z. (2015). Microbial ecology of the cryosphere: sea ice and glacial habitats. *Nature Reviews Microbiology*, *13*(11), 677–690. <https://doi.org/10.1038/nrmicro3522>
- Boynton, W. V., Feldman, W. C., Squyres, S. W., Prettyman, T. H., Brückner, J., Evans, L. G., et al. (2002). Distribution of Hydrogen in the Near Surface of Mars: Evidence for Subsurface Ice Deposits. *Science*, *297*(5578), 81–85. <https://doi.org/10.1126/science.1073722>
- Bramson, A. M., Byrne, S., Putzig, N. E., Sutton, S., Plaut, J. J., Brothers, T. C., & Holt, J. W. (2015). Widespread excess ice in Arcadia Planitia, Mars. *Geophysical Research Letters*, *42*(16), 6566–6574. <https://doi.org/10.1002/2015GL064844>
- Bramson, A. M., Byrne, S., & Bapst, J. (2017). Preservation of Midlatitude Ice Sheets on Mars. *Journal of Geophysical Research: Planets*, *122*(11), 2250–2266. <https://doi.org/10.1002/2017JE005357>
- Brook, E. J. (2013). Overview of ice core research. In *Encyclopedia of Quaternary Science*. <https://www.elsevier.com/books/encyclopedia-of-quaternary-science/elias/978-0-444-53643-3>
- Brook, E. J., & Buizert, C. (2018). Antarctic and global climate history viewed from ice cores. *Nature*, *558*(7709), 200–208. <https://doi.org/10.1038/s41586-018-0172-5>
- Buhler, P. B., Ingersoll, A. P., Piqueux, S., Ehlmann, B. L., & Hayne, P. O. (2020). Coevolution of Mars's atmosphere and massive south polar CO₂ ice deposit. *Nature Astronomy*, *4*(4), 364–371. <https://doi.org/10.1038/s41550-019-0976-8>
- Buizert, C., Baggenstos, D., Jiang, W., Purtschert, R., Petrenko, V. V., Lu, Z.-T., et al. (2014). Radiometric ⁸¹Kr dating identifies 120,000-year-old ice at Taylor Glacier, Antarctica. *Proceedings of the National Academy of Sciences*, *111*(19), 6876–6881.
- Byrne, S. (2009). The Polar Deposits of Mars. *Annual Review of Earth and Planetary Sciences*, *37*(1), 535–560. <https://doi.org/10.1146/annurev.earth.031208.100101>
- Byrne, S., Dundas, C. M., Kennedy, M. R., Mellon, M. T., McEwen, A. S., Cull, S. C., et al. (2009). Distribution of Mid-Latitude Ground Ice on Mars from New Impact Craters. *Science*, *325*(5948), 1674–1676. <https://doi.org/10.1126/science.1175307>
- Campbell, S., Kreutz, K., Osterberg, E., Arcone, S., Wake, C., Introne, D., et al. (2012). Melt regimes, stratigraphy, flow dynamics and glaciochemistry of three glaciers in the Alaska Range. *Journal of Glaciology*, *58*(207), 99–109. <https://doi.org/10.3189/2012JG10J238>
- Campbell, S., Balco, G., Todd, C., Conway, H., Huybers, K., Simmons, C., & Vermeulen, M. (2013a). Radar-detected englacial stratigraphy in the Pensacola Mountains, Antarctica: implications for

recent changes in ice flow and accumulation. *Annals of Glaciology*, 54(63), 91–100.
<https://doi.org/10.3189/2013AoG63A371>

Campbell, S., Roy, S., Kreutz, K., Arcone, S. A., Osterberg, E. C., & Koons, P. (2013b). Strain-rate estimates for crevasse formation at an alpine ice divide: Mount Hunter, Alaska. *Annals of Glaciology*, 54(63), 200–208. <https://doi.org/10.3189/2013AoG63A266>

Campbell, S., Affleck, R. T., & Sinclair, S. (2018). Ground-penetrating radar studies of permafrost, periglacial, and near-surface geology at McMurdo Station, Antarctica. *Cold Regions Science and Technology*, 148, 38–49. <https://doi.org/10.1016/j.coldregions.2017.12.008>

Campbell, S. W., Briggs, M., Roy, S. G., Douglas, T. A., & Saari, S. (2021). Ground-penetrating radar, electromagnetic induction, terrain, and vegetation observations coupled with machine learning to map permafrost distribution at Twelvemile Lake, Alaska. *Permafrost and Periglacial Processes*, 1–20. <https://doi.org/10.1002/ppp.2100>

Chappellaz, J., Blunier, T., Raynaud, D., Barnola, J. M., Schwander, J., & Stauffert, B. (1993). Synchronous changes in atmospheric CH₄ and Greenland climate between 40 and 8 kyr BP. *Nature*, 366(6454), 443–445. <https://doi.org/10.1038/366443a0>

Chellman, N. J., Pederson, G. T., Lee, C. M., McWethy, D. B., Puseman, K., Stone, J. R., et al. (2021). High elevation ice patch documents Holocene climate variability in the northern Rocky Mountains. *Quaternary Science Advances*, 3, 100021. <https://doi.org/10.1016/j.qsa.2020.100021>

Chittenden, J. D., Chevrier, V., Roe, L. A., Bryson, K., Pilgrim, R., & Sears, D. W. G. (2008). Experimental study of the effect of wind on the stability of water ice on Mars. *Icarus*, 196(2), 477–487. <https://doi.org/10.1016/j.icarus.2008.01.016>

Christner, B. C., Mikucki, J. A., Foreman, C. M., Denson, J., & Priscu, J. C. (2005). Glacial ice cores: A model system for developing extraterrestrial decontamination protocols. *Icarus*, 174(2), 572–584. <https://doi.org/10.1016/j.icarus.2004.10.027>

Christner, B. C., Priscu, J. C., Achberger, A. M., Barbante, C., Carter, S. P., Christianson, K., et al. (2014). A microbial ecosystem beneath the West Antarctic ice sheet. *Nature*, 512(7514), 310–313. <https://doi.org/10.1038/nature13667>

Chyba, C. et al. (2005). Preventing the Forward Contamination of Mars. The National Academies Press, Washington D.C. 167p. <https://doi.org/10.17226/11381>

Cutts, J. A., & Lewis, B. H. (1982). Models of climate cycles recorded in Martian polar layered deposits. *Icarus*, 50(2), 216–244. [https://doi.org/10.1016/0019-1035\(82\)90124-5](https://doi.org/10.1016/0019-1035(82)90124-5)

D’Andrilli, J., Foreman, C. M., Sigl, M., Priscu, J. C., & McConnell, J. R. (2017). A 21 000-year record of fluorescent organic matter markers in the WAIS Divide ice core. *Climate of the Past*, 13(5), 533–544. <https://doi.org/10.5194/cp-13-533-2017>

Diez, B., Feldman, W. C., Maurice, S., Gasnault, O., Prettyman, T. H., Mellon, M. T., et al. (2008). H layering in the top meter of Mars. *Icarus*, 196(2), 409–421. <https://doi.org/10.1016/j.icarus.2008.02.006>

Duderstadt, K. A., Dibb, J. E., Schwadron, N. A., Spence, H. E., Solomon, S. C., Yudin, V. A., et al. (2016). Nitrate ion spikes in ice cores not suitable as proxies for solar proton events. *Journal of Geophysical Research: Atmospheres*, 121(6), 2994–3016. <https://doi.org/10.1002/2015JD023805>

Dundas, C. M., Byrne, S., McEwen, A. S., Mellon, M. T., Kennedy, M. R., Daubar, I. J., & Saper, L. (2014). HiRISE observations of new impact craters exposing Martian ground ice. *Journal of Geophysical Research: Planets*, 119(1), 109–127. <https://doi.org/10.1002/2013JE004482>

Dundas, C. M., Bramson, A. M., Ojha, L., Wray, J. J., Mellon, M. T., Byrne, S., et al. (2018). Exposed subsurface ice sheets in the Martian mid-latitudes. *Science*, 359(6372), 199–201. <https://doi.org/10.1126/science.aao1619>

Dundas, C. M., Mellon, M. T., Conway, S. J., Daubar, I. J., Williams, K. E., Ojha, L., et al. (2021). Widespread Exposures of Extensive Clean Shallow Ice in the Mid-Latitudes of Mars. *Journal of Geophysical Research: Planets*, <https://doi.org/10.1029/2020JE006617>

Eshelman, E., Daly, M. G., Slater, G., & Cloutis, E. (2015). Time-resolved detection of aromatic compounds on planetary surfaces by ultraviolet laser induced fluorescence and Raman spectroscopy. *Planetary and Space Science*, 119, 200–207. <https://doi.org/10.1016/j.pss.2015.09.021>

Eshelman, E. J., Malaska, M. J., Manatt, K. S., Doloboff, I. J., Wanger, G., Willis, M. C., et al. (2019). WATSON: In Situ Organic Detection in Subsurface Ice Using Deep-UV Fluorescence Spectroscopy. *Astrobiology*, 19(6), 771–784. <https://doi.org/10.1089/ast.2018.1925>

Fischer, H., Severinghaus, J., Brook, E., Wolff, E., Albert, M., Alemany, O., et al. (2013). Where to find 1.5 million yr old ice for the IPICS “Oldest-Ice” ice core. *Climate of the Past*, 9(6), 2489–2505. <https://doi.org/10.5194/cp-9-2489-2013>

Foreman, C. M., Sattler, B., Mikucki, J. A., Porazinska, D. L., & Priscu, J. C. (2007). Metabolic activity and diversity of cryoconites in the Taylor Valley, Antarctica. *Journal of Geophysical Research: Biogeosciences*, 112(G4). <https://doi.org/10.1029/2006JG000358>

Glassmeier, K.-H. (2020). Solar system exploration via comparative planetology. *Nature Communications*, 11(1), 1–4. <https://doi.org/10.1038/s41467-020-18126-z>

Hawkings, J. R., Skidmore, M. L., Wadham, J. L., Priscu, J. C., Morton, P. L., Hatton, J. E., et al. (2020). Enhanced trace element mobilization by Earth’s ice sheets. *Proceedings of the National Academy of Sciences*, 117(50), 31648–31659. <https://doi.org/10.1073/pnas.2014378117>

Hays, J. D., Imbrie, J., & Shackleton, N. J. (1976). Variations in the Earth’s Orbit: Pacemaker of the Ice Ages. *Science*, 194(4270), 1121–1132. <https://doi.org/10.1126/science.194.4270.1121>

Head, J. W., Mustard, J. F., Kreslavsky, M. A., Milliken, R. E., & Marchant, D. R. (2003). Recent ice ages on Mars. *Nature*, 426(6968), 797–802. <https://doi.org/10.1038/nature02114>

Hindmarsh, R. C. A., Vieli, G. J.-M. C. L., Raymond, M. J., & Gudmundsson, G. H. (2006). Draping or overriding: The effect of horizontal stress gradients on internal layer architecture in ice sheets. *Journal of Geophysical Research: Earth Surface*, 111(F2). <https://doi.org/10.1029/2005JF000309>

Holt, J. W., Safaeinili, A., Plaut, J. J., Head, J. W., Phillips, R. J., Seu, R., et al. (2008). Radar Sounding Evidence for Buried Glaciers in the Southern Mid-Latitudes of Mars. *Science*, 322(5905), 1235–1238. <https://doi.org/10.1126/science.1164246>

ICE-SAG Final Report (2019), Report from the Ice and Climate Evolution Science Analysis group (ICE-SAG), Chaired by S. Diniega and N. E. Putzig, 157 pages posted 08 July 2019, by the Mars Exploration Program Analysis Group (MEPAG) at <http://mepag.nasa.gov/reports.cfm>.

Kehrl, L., Conway, H., Holschuh, N., Campbell, S., Kurbatov, A. V., & Spaulding, N. E. (2018). Evaluating the Duration and Continuity of Potential Climate Records From the Allan Hills Blue Ice Area, East Antarctica. *Geophysical Research Letters*, 45(9), 4096–4104. <https://doi.org/10.1029/2018GL077511>

Kingslake, J., Martín, C., Arthern, R. J., Corr, H. F. J., & King, E. C. (2016). Ice-flow reorganization in West Antarctica 2.5 kyr ago dated using radar-derived englacial flow velocities. *Geophysical Research Letters*, 43(17), 9103–9112. <https://doi.org/10.1002/2016GL070278>

Koutnik, M. R., Fudge, T. J., Conway, H., Waddington, E. D., Neumann, T. A., Cuffey, K. M., et al. (2016). Holocene accumulation and ice flow near the West Antarctic Ice Sheet Divide ice core site. *Journal of Geophysical Research: Earth Surface*, 121(5), 907–924. <https://doi.org/10.1002/2015JF003668>

Kuhl, T., Gibson, C., Johnson, J., Boeckmann, G., Moravec, E., & Slawny, K. (2020). Agile Sub-Ice Geological (ASIG) Drill development and Pirrit Hills field project. *Annals of Glaciology*, 1–14. <https://doi.org/10.1017/aog.2020.59>

Laskar, J., Levrard, B., & Mustard, J. F. (2002). Orbital forcing of the martian polar layered deposits. *Nature*, 419(6905), 375–377. <https://doi.org/10.1038/nature01066>

Levy, J. S., Fassett, C. I., Head, J. W., Schwartz, C., & Watters, J. L. (2014). Sequestered glacial ice contribution to the global Martian water budget: Geometric constraints on the volume of remnant, midlatitude debris-covered glaciers. *Journal of Geophysical Research: Planets*, 119(10), 2188–2196. <https://doi.org/10.1002/2014JE004685>

Levy, J. S., Fassett, C. I., Holt, J. W., Parsons, R., Cipolli, W., Goudge, T. A., et al. (2021). Surface boulder banding indicates Martian debris-covered glaciers formed over multiple glaciations. *Proceedings of the National Academy of Sciences*, 118(4). <https://doi.org/10.1073/pnas.2015971118>

Licciulli, C., Bohleber, P., Lier, J., Gagliardini, O., Hoelzle, M., & Eisen, O. (2020). A full Stokes ice-flow model to assist the interpretation of millennial-scale ice cores at the high-Alpine drilling site Colle Gnifetti, Swiss/Italian Alps. *Journal of Glaciology*, 66(255), 35–48. <https://doi.org/10.1017/jog.2019.82>

Madeleine, J.-B., Forget, F., Head, J. W., Levrard, B., Montmessin, F., & Millour, E. (2009). Amazonian northern mid-latitude glaciation on Mars: A proposed climate scenario. *Icarus*, 203(2), 390–405. <https://doi.org/10.1016/j.icarus.2009.04.037>

Malaska, M. J., Bhartia, R., Manatt, K. S., Priscu, J. C., Abbey, W. J., Mellerowicz, B., et al. (2020). Subsurface In Situ Detection of Microbes and Diverse Organic Matter Hotspots in the Greenland Ice Sheet. *Astrobiology*, 20(10), 1185–1211. <https://doi.org/10.1089/ast.2020.2241>

Mayewski, P. A., Meeker, L. D., Whitlow, S., Twickler, M. S., Morrison, M. C., Bloomfield, P., et al. (1994). Changes in Atmospheric Circulation and Ocean Ice Cover over the North Atlantic During the Last 41,000 Years. *Science*, 263(5154), 1747–1751. <https://doi.org/10.1126/science.263.5154.1747>

McConnell, J. R., Lamorey, G. W., Lambert, S. W., & Taylor, K. C. (2002). Continuous Ice-Core Chemical Analyses Using Inductively Coupled Plasma Mass Spectrometry. *Environmental Science & Technology*, 36(1), 7–11. <https://doi.org/10.1021/es011088z>

McConnell, J. R., Burke, A., Dunbar, N. W., Köhler, P., Thomas, J. L., Arienzo, M. M., et al. (2017). Synchronous volcanic eruptions and abrupt climate change ~17.7 ka plausibly linked by stratospheric ozone depletion. *Proceedings of the National Academy of Sciences*, 114(38), 10035–10040. <https://doi.org/10.1073/pnas.1705595114>

McCubbin, F. M., Herd, C. D. K., Yada, T., Hutzler, A., Calaway, M. J., Allton, J. H., et al. (2019). Advanced Curation of Astromaterials for Planetary Science. *Space Science Reviews*, 215(8), 48. <https://doi.org/10.1007/s11214-019-0615-9>

Mekhaldi, F., Muscheler, R., Adolphi, F., Aldahan, A., Beer, J., McConnell, J. R., et al. (2015). Multiradionuclide evidence for the solar origin of the cosmic-ray events of AD 774/5 and 993/4. *Nature Communications*, 6(1), 1–8. <https://doi.org/10.1038/ncomms9611>

Mekhaldi, F., McConnell, J. R., Adolphi, F., Arienzo, M. M., Chellman, N. J., Maselli, O. J., et al. (2017). No Coincident Nitrate Enhancement Events in Polar Ice Cores Following the Largest Known Solar Storms. *Journal of Geophysical Research: Atmospheres*, 122(21), 11,900–11,913. <https://doi.org/10.1002/2017JD027325>

MEPAG (2020), Mars Scientific Goals, Objectives, Investigations, and Priorities: 2020. D. Banfield, ed., 89 p. white paper posted March, 2020 by the Mars Exploration Program Analysis Group (MEPAG) at <https://mepag.jpl.nasa.gov/reports.cfm>.

Mellerowicz, B. L., Zacny, K., Eshelman, E., Bhartia, R., Willis, M., Priscu, J., et al. (2018). Development of a Deep Drill System with Integrated Deep UV/Raman Spectrometer for Mars and Europa. In *2018 AIAA SPACE and Astronautics Forum and Exposition* (Vols. 1–0). American Institute of Aeronautics and Astronautics. <https://doi.org/10.2514/6.2018-5290>

Mellon, M. T., Arvidson, R. E., Sizemore, H. G., Searls, M. L., Blaney, D. L., Cull, S., et al. (2009). Ground ice at the Phoenix Landing Site: Stability state and origin. *Journal of Geophysical Research: Planets*, 114(E1). <https://doi.org/10.1029/2009JE003417>

Milkovich, S. M., & Head, J. W. (2005). North polar cap of Mars: Polar layered deposit characterization and identification of a fundamental climate signal. *Journal of Geophysical Research: Planets*, 110(E1). <https://doi.org/10.1029/2004JE002349>

Miteva, V., Teacher, C., Sowers, T., & Brenchley, J. (2009). Comparison of the microbial diversity at different depths of the GISP2 Greenland ice core in relationship to deposition climates. *Environmental Microbiology*, 11(3), 640–656. <https://doi.org/10.1111/j.1462-2920.2008.01835.x>

Moore, J. M., & Spencer, J. R. (1990). Koyaani muuyaw: The Hypothesis of a Perennially Dichotomous Triton. *Geophysical Research Letters*, 17(10), 1757–1760. <https://doi.org/10.1029/GL017i010p01757>

Morgan, G. A., Putzig, N. E., Perry, M. R., Sizemore, H. G., Bramson, A. M., Petersen, E. I., et al. (2021). Availability of subsurface water-ice resources in the northern mid-latitudes of Mars. *Nature Astronomy*, 1–7. <https://doi.org/10.1038/s41550-020-01290-z>

Murray, B. C., Ward, W. R., & Yeung, S. C. (1973). Periodic Insolation Variations on Mars. *Science*, 180(4086), 638–640. <https://doi.org/10.1126/science.180.4086.638>

Neff, P. D., Steig, E. J., Clark, D. H., McConnell, J. R., Pettit, E. C., & Menounos, B. (2012). Ice-core net snow accumulation and seasonal snow chemistry at a temperate-glacier site: Mount Waddington, southwest British Columbia, Canada. *Journal of Glaciology*, 58(212), 1165–1175. <https://doi.org/10.3189/2012JoG12J078>

Nicholls, K. W., Corr, H. F. J., Stewart, C. L., Lok, L. B., Brennan, P. V., & Vaughan, D. G. (2015). A ground-based radar for measuring vertical strain rates and time-varying basal melt rates in ice sheets and shelves. *Journal of Glaciology*, 61(230), 1079–1087. <https://doi.org/10.3189/2015JoG15J073>

NRC (2013). Vision and Voyages for Planetary Science in the Decade 2013-2022. Steering Group Chair: Squyres, *National Academies Press*, Washington, D.C., ISBN: 0-309-20955-2 <https://doi.org/10.17226/13117>

Paerl, H. W., & Priscu, J. C. (1998). Microbial Phototrophic, Heterotrophic, and Diazotrophic Activities Associated with Aggregates in the Permanent Ice Cover of Lake Bonney, Antarctica. *Microbial Ecology*, 36(3), 221–230. <https://doi.org/10.1007/s002489900109>

Parrenin, F., Barnola, J.-M., Beer, J., Blunier, T., Castellano, E., Chappellaz, J., et al. (2007). The EDC3 chronology for the EPICA Dome C ice core. *Climate of the Past*, 3(3), 485–497. <https://doi.org/https://doi.org/10.5194/cp-3-485-2007>

Pathare, A. V., Feldman, W. C., Prettyman, T. H., & Maurice, S. (2018). Driven by excess? Climatic implications of new global mapping of near-surface water-equivalent hydrogen on Mars. *Icarus*, 301, 97–116. <https://doi.org/10.1016/j.icarus.2017.09.031>

Paulsen, G., Zacny, K., Chu, P., Mumm, E., Davis, K., Frader-Thompson, S., et al. (2006). Robotic Drill Systems for Planetary Exploration. In *Space 2006* (Vols. 1–0). American Institute of Aeronautics and Astronautics. <https://doi.org/10.2514/6.2006-7512>

Perron, J. T., & Huybers, P. (2009). Is there an orbital signal in the polar layered deposits on Mars? *Geology*, 37(2), 155–158. <https://doi.org/10.1130/G25143A.1>

Petersen, E. I., Holt, J. W., & Levy, J. S. (2018). High Ice Purity of Martian Lobate Debris Aprons at the Regional Scale: Evidence From an Orbital Radar Sounding Survey in Deuteronilus and Protonilus Mensae. *Geophysical Research Letters*, 45(21), 11,595–11,604. <https://doi.org/10.1029/2018GL079759>

Petit, J. R., Jouzel, J., Raynaud, D., Barkov, N. I., Barnola, J.-M., Basile, I., et al. (1999). Climate and atmospheric history of the past 420,000 years from the Vostok ice core, Antarctica. *Nature*, 399(6735), 429–436. <https://doi.org/10.1038/20859>

Petrenko, V. V., Severinghaus, J. P., Brook, E. J., Reeh, N., & Schaefer, H. (2006). Gas records from the West Greenland ice margin covering the Last Glacial Termination: a horizontal ice core. *Quaternary Science Reviews*, 25(9), 865–875. <https://doi.org/10.1016/j.quascirev.2005.09.005>

Priscu, J. C., Fritsen, C. H., Adams, E. E., Giovannoni, S. J., Paerl, H. W., McKay, C. P., et al. (1998). Perennial Antarctic Lake Ice: An Oasis for Life in a Polar Desert. *Science*, 280(5372), 2095–2098. <https://doi.org/10.1126/science.280.5372.2095>

Priscu, J. C., Adams, E. E., Lyons, W. B., Voytek, M. A., Mogk, D. W., Brown, R. L., et al. (1999). Geomicrobiology of Subglacial Ice Above Lake Vostok, Antarctica. *Science*, 286(5447), 2141–2144. <https://doi.org/10.1126/science.286.5447.2141>

Priscu, J.C. and B. Christner (2004). Earth's Icy Biosphere. p. 130-145, In: A.T. Bull (Ed.) "Microbial Diversity and Prospecting". ASM Press, Washington, D.C.

Priscu, J.C., B.C. Christner, C.M. Foreman and G. Royston-Bishop (2007). Biological Material in Ice Cores. *Encyclopedia of Quaternary Sciences*. Volume 2. (Editor in Chief, S.A. Elias). p. 1156-1166. Elsevier B.V., UK.

Priscu, J.C., S. Tulaczyk, M. Studinger, M. C. Kennicutt II, B.C. Christner, and C.M. Foreman. (2008). Antarctic Subglacial Water: Origin, Evolution and Ecology. In: W. Vincent and J. Laybourn-Parry (eds.), *Polar Lakes and Rivers*. Oxford University Press. Pp. 119-135. <https://oxford.universitypressscholarship.com/view/10.1093/acprof:oso/9780199213887.001.001/acprof-9780199213887-chapter-7>

Santibáñez, P. A., McConnell, J. R., & Priscu, J. C. (2016). A flow cytometric method to measure prokaryotic records in ice cores: an example from the West Antarctic Ice Sheet Divide drilling site. *Journal of Glaciology*, 62(234), 655–673. <https://doi.org/10.1017/jog.2016.50>

Santibáñez, P. A., Maselli, O. J., Greenwood, M. C., Grieman, M. M., Saltzman, E. S., McConnell, J. R., & Priscu, J. C. (2018). Prokaryotes in the WAIS Divide ice core reflect source and transport changes between Last Glacial Maximum and the early Holocene. *Global Change Biology*, 24(5), 2182–2197. <https://doi.org/https://doi.org/10.1111/gcb.14042>

Schirrmeister, L., Grosse, G., Wetterich, S., Overduin, P. P., Strauss, J., Schuur, E. A. G., & Hubberten, H.-W. (2011). Fossil organic matter characteristics in permafrost deposits of the northeast Siberian Arctic. *Journal of Geophysical Research: Biogeosciences*, 116(G2). <https://doi.org/https://doi.org/10.1029/2011JG001647>

Schroeder, D. M., Bingham, R. G., Blankenship, D. D., Christianson, K., Eisen, O., Flowers, G. E., et al. (2020). Five decades of radioglaciology. *Annals of Glaciology*, 61(81), 1–13. <https://doi.org/10.1017/aog.2020.11>

Sinha, P. and B. Horgan (2021), The mineralogy of lithic sediments within the south polar layered deposits of Mars, *Lunar and Planet. Sci. Conf.* 52nd, 2070.

Smith, H. J., Schmit, A., Foster, R., Littman, S., Kuypers, M. M., & Foreman, C. M. (2016). Biofilms on glacial surfaces: hotspots for biological activity. *Npj Biofilms and Microbiomes*, 2(1), 1–4. <https://doi.org/10.1038/npjbiofilms.2016.8>

- Sori, M. M., Perron, J. T., Huybers, P., & Aharonson, O. (2014). A procedure for testing the significance of orbital tuning of the martian polar layered deposits. *Icarus*, 235, 136–146. <https://doi.org/10.1016/j.icarus.2014.03.009>
- Souney, J. M., Twickler, M. S., Hargreaves, G. M., Bencivengo, B. M., Kippenhan, M. J., Johnson, J. A., et al. (2014). Core handling and processing for the WAIS Divide ice-core project. *Annals of Glaciology*, 55(68), 15–26. <https://doi.org/10.3189/2014AoG68A008>
- Spaulding, N. E., Higgins, J. A., Kurbatov, A. V., Bender, M. L., Arcone, S. A., Campbell, S., et al. (2013). Climate archives from 90 to 250ka in horizontal and vertical ice cores from the Allan Hills Blue Ice Area, Antarctica. *Quaternary Research*, 80(3), 562–574. <https://doi.org/10.1016/j.yqres.2013.07.004>
- Spector, P., Stone, J., Pollard, D., Hillebrand, T., Lewis, C., & Gombiner, J. (2018). West Antarctic sites for subglacial drilling to test for past ice-sheet collapse. *The Cryosphere*, 12(8), 2741–2757. <https://doi.org/10.5194/tc-12-2741-2018>
- Steig, E. J., & Neff, P. D. (2018). The prescience of paleoclimatology and the future of the Antarctic ice sheet. *Nature Communications*, 9(1), 1–3. <https://doi.org/10.1038/s41467-018-05001-1>
- Stern, S. A., Bagenal, F., Ennico, K., Gladstone, G. R., Grundy, W. M., McKinnon, W. B., et al. (2015). The Pluto system: Initial results from its exploration by New Horizons. *Science*, 350(6258). <https://doi.org/10.1126/science.aad1815>
- Stern, S. A., Bagenal, F., Ennico, K., Gladstone, G. R., Grundy, W. M., McKinnon, W. B., et al. (2015). The Pluto system: Initial results from its exploration by New Horizons. *Science*, 350(6258). <https://doi.org/10.1126/science.aad1815>
- Stuurman, C. M., Osinski, G. R., Holt, J. W., Levy, J. S., Brothers, T. C., Kerrigan, M., & Campbell, B. A. (2016). SHARAD detection and characterization of subsurface water ice deposits in Utopia Planitia, Mars. *Geophysical Research Letters*, 43(18), 9484–9491. <https://doi.org/10.1002/2016GL070138>
- Svensson, A., Andersen, K. K., Bigler, M., Clausen, H. B., Dahl-Jensen, D., Davies, S. M., et al. (2008). A 60 000 year Greenland stratigraphic ice core chronology. *Climate of the Past*, 4(1), 47–57. <https://doi.org/10.5194/cp-4-47-2008>
- Tamppari, L. K., & Lemmon, M. T. (2020). Near-surface atmospheric water vapor enhancement at the Mars Phoenix lander site. *Icarus*, 343, 113624. <https://doi.org/10.1016/j.icarus.2020.113624>
- U.S. Geological Survey (2002), Satellite Image Atlas of Glaciers of the World, Fact Sheet 130-02, Richard S. Williams Jr. and Jane G. Ferrigno, <https://doi.org/10.3133/fs13002>.
- van Huissteden, K., Vandenberghe, J., & Pollard, D. (2003). Palaeotemperature reconstructions of the European permafrost zone during marine oxygen isotope Stage 3 compared with climate model results. *Journal of Quaternary Science*, 18(5), 453–464. <https://doi.org/https://doi.org/10.1002/jqs.766>
- Vick-Majors, T., Achberger, A., Michaud, A., & Prisco, J. (2020). Metabolic and taxonomic diversity in antarctic subglacial environments. In G. Di Prisco, H. Edwards, J. Elster, & A. Huiskes (Eds.), *Life in Extreme Environments: Insights in Biological Capability* (Ecological Reviews, pp. 279–296). Cambridge: Cambridge University Press. doi:10.1017/9781108683319.016

Viola, D., McEwen, A. S., Dundas, C. M., & Byrne, S. (2015). Expanded secondary craters in the Arcadia Planitia region, Mars: Evidence for tens of Myr-old shallow subsurface ice. *Icarus*, 248, 190–204. <https://doi.org/10.1016/j.icarus.2014.10.032>

Vos, E., Aharonson, O., & Schorghofer, N. (2019). Dynamic and isotopic evolution of ice reservoirs on Mars. *Icarus*, 324, 1–7. <https://doi.org/10.1016/j.icarus.2019.01.018>

Waddington, E. D., Neumann, T. A., Koutnik, M. R., Marshall, H.-P., & Morse, D. L. (2007). Inference of accumulation-rate patterns from deep layers in glaciers and ice sheets. *Journal of Glaciology*, 53(183), 694–712. <https://doi.org/10.3189/002214307784409351>

Yan, Y., Bender, M. L., Brook, E. J., Clifford, H. M., Kemeny, P. C., Kurbatov, A. V., et al. (2019). Two-million-year-old snapshots of atmospheric gases from Antarctic ice. *Nature*, 574(7780), 663–666. <https://doi.org/10.1038/s41586-019-1692-3>

Young, D. A., Roberts, J. L., Ritz, C., Frezzotti, M., Quartini, E., Cavitte, M. G. P., et al. (2017). High-resolution boundary conditions of an old ice target near Dome C, Antarctica. *The Cryosphere*, 11(4), 1897–1911. <https://doi.org/10.5194/tc-11-1897-2017>

Zacny, K., Chu P., Wilson J., Davis K., and Craft J. (2011), Honeybee Approach to the Sample Acquisition and Caching Architecture for the 2018 Mars Sample Return Mission, Paper #1573, *IEEE Aerospace conference*, Big Sky, Montana.

Zacny, K., Paulsen G., Mellerowicz B., Bar-Cohen Y., Beegle L., Sherrit S., Badescu M., et al. (2013). Wireline Deep Drill for Exploration of Mars, Europa, and Enceladus, 2013 *IEEE Aerospace Conference*, Big Sky, Montana.

Zacny, K., Shara M., Paulsen G., Mellerowicz B., Spring J., Ridilla A., et al. (2016), Development of a Planetary Deep Drill, *ASCE Earth and Space Conference*, Orlando, FL.

Zacny K., van Susante P., Putzig T., Hecht M., Sabahi D. (2018), RedWater: Extraction of Water from Mars Ice Deposits, *Space Resources Roundtable*, Colorado School of Mines, Golden, CO, June 12-14, 2018.