

**SPS-ALPHA: The First Practical Solar Power Satellite via
Arbitrarily Large Phased Array
(A 2011-2012 NASA NIAC Phase 1 Project)**

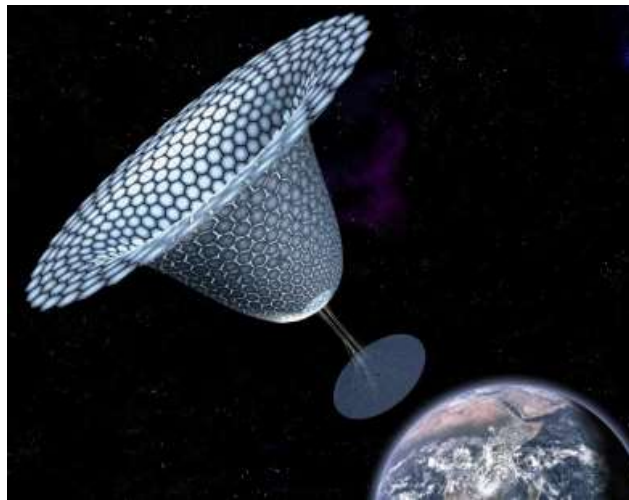

FINAL REPORT

to



15 September 2012

by

Mr. John C. Mankins, Principal Investigator



Artemis Innovation Management Solutions LLC
P.O. Box 6660
Santa Maria, California 93456
email: john.c.mankins@artemisinnovation.com
phone: (+1) 805-929-3121

**SPS-ALPHA: The First Practical Solar Power Satellite via Arbitrarily Large Phased
Array**

(A 2011-2012 NASA NIAC Phase 1 Project)

ABSTRACT

The vision of delivering solar power to Earth from platforms in space has been known for decades. However, early architectures to accomplish this vision were technically complex and unlikely to prove economically viable. Some of the issues with these earlier solar power satellite (SPS) concepts – particularly involving technical feasibility – were addressed by NASA’s space solar power (SSP) studies and technology research in the mid-to-late 1990s. Despite that progress, ten years ago a number of key technical and economic uncertainties remained. A new SPS concept has been proposed that resolves many, if not all, of those uncertainties: “SPS-ALPHA” (Solar Power Satellite by means of Arbitrarily Large Phased Array).

During 2011-2012 the NASA Innovative Advanced Concepts (NIAC) Program supported a Phase 1 “SPS-ALPHA” project, the goal of which was to establish the technical and economic viability of the SPS-ALPHA concept to an early TRL 3 – analytical proof-of-concept – and provide a framework for further study and technology development. The objectives of this project were to: (1) conduct an initial end-to-end systems analysis of the SPS-ALPHA concept in order to determine its technical feasibility; (2) identify and assess in greater detail the key technology challenges inherent in the architecture (including figures of merit for each critical technology area); (3) conduct an initial evaluation of the economic viability of the concept (as a function of key performance parameters); and, (4) define a preliminary roadmap for the further development of the SPS-ALPHA concept.

This report presents the results of that study.

This work was performed under NASA Grant NNX11AR34G.

TABLE OF CONTENTS

SECTION	TITLE	PAGE
1	Executive Summary	p. 5
2	Introduction	p. 11
3	Description of the SPS-ALPHA Concept	p. 15
4	Systems Analysis Methodology	p. 37
5	SPS-ALPHA Market Forecast	p. 43
6	Prospective Non-SPS Applications	p. 53
7	SPS-ALPHA Systems Analysis Results	p. 67
8	Technology Readiness and Risk Assessment	p. 87
9	Path Forward: A Roadmap For SPS-ALPHA	p. 97
10	Summary and Conclusions	p. 105
APPENDIX	TITLE	PAGE
A	Glossary of Acronyms	p. 107
B	References	p. 113

ACKNOWLEDGEMENTS

I would like to acknowledge the important contributions of the project's two co-investigators, Prof. Nobuyuki Kaya of Kobe University (Kobe, JAPAN) and Dr. Massimiliano Vasile of the University of Strathclyde (Glasgow, Scotland, UK), as well as those of critical team member Dr. Harvey Feingold (who was responsible for re-engineering the Space Segment Model from NASA's 1995-1997 Space Solar Power Fresh Look Study), and Mr. Mark Elwood (of Spaceworks Engineering, who was responsible for most of the excellent concept visualization graphics included in the report). I would also like to acknowledge the work of the Engineering Clinic student project team at Harvey Mudd College (which developed a working prototype of a wireless power transmission system in about six months, with invaluable guidance from Prof. Kaya).

Finally, I would like to acknowledge and thank the several participants in the project's two subject matter expert (SME) workshops.

SECTION 1

EXECUTIVE SUMMARY

During 2011-2012, NASA’s Innovative Advanced Concepts (NIAC) program supported a preliminary Phase 1 project to investigate a transformational new approach to the concept of space solar power: SPS-ALPHA (Solar Power Satellite by means of Arbitrarily Large Phased Array). To deliver energy to Earth, SPS-ALPHA would typically be based in a geostationary Earth orbit (GEO), where it would intercept sunlight using a collection of individually pointed thin-film mirrors, convert that sunlight across a large radio frequency (RF) aperture into a coherent microwave beam and transmit the power to markets on Earth or in space. Figure 1-1 presents two alternative conceptual visualizations of the SPS-ALPHA, as well as several earlier SPS concepts for comparison.

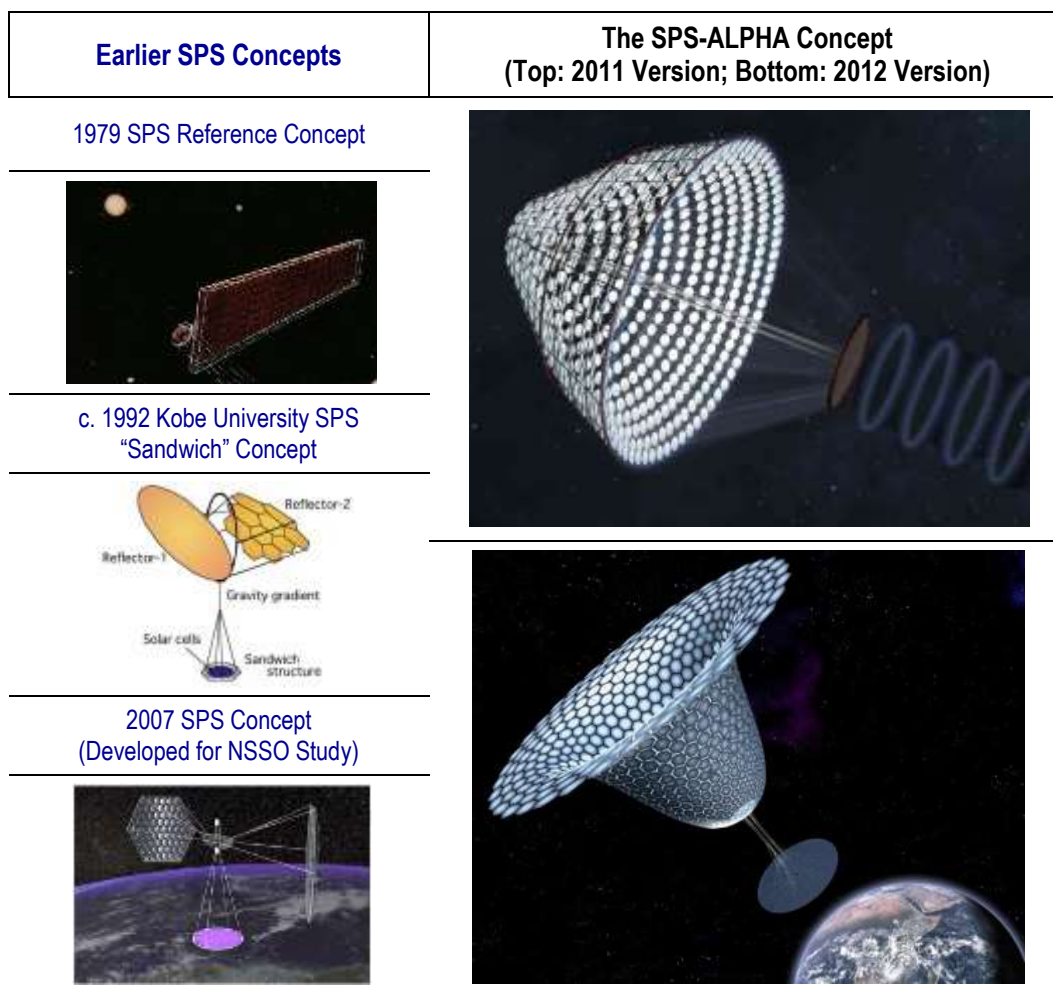

Figure 1-1 Selected Past Solar Power Satellite Concepts and 2 Versions of the New SPS-ALPHA Concept

SPS-ALPHA incorporates a number of critical new technologies, including: (1) WPT using a retro-directive RF phased array with high-efficiency solid-state amplifiers; (2) high-efficiency multi-bandgap PV solar cells, employed in a concentrator PV (CPV) architecture with integrated thermal management; (3) lightweight structural components, applied in various systems / subsystems; (4) autonomous robotics in a highly structured

environment; and, (5) a high-degree of autonomy among individual modules. However, no “breakthroughs” are required, and the key innovation is at the architecture level.

The goals of the project were to establish the technical and economic viability of the SPS-ALPHA concept to an early TRL 3 – analytical proof-of-concept – and to provide a framework for further study and technology development. The objectives of the innovative advanced concept project were to: (1) Conduct an initial end-to-end systems analysis of the SPS-ALPHA concept in order to determine its technical feasibility; (2) Identify and assess in greater detail the key technology challenges inherent in the architecture (including figures of merit for each critical technology area); (3) Test in supporting parallel experiments some of the key figures of merit for SSP, and use the results to inform systems modeling efforts; (4) Conduct an initial evaluation of the economic viability of the concept (as a function of key performance parameters); and, (5) Define a preliminary roadmap for the further research and development of the SPS-ALPHA concept.

The result of the project was to advance the current technology readiness level (TRL) of this novel conceptual approach from TRL 1 / TRL 2 (physical principles established, and basic concept formulated) to early TRL 3 (experimental and/or analytical proof of key functionality in the laboratory). As planned, this project was largely analytical, with selected supporting experiments.

The following paragraphs are summaries of the results of each of the eleven tasks that comprised the SPS-ALPHA NIAC Phase 1 project.

1.1 Task 1: Project Integration and Reporting

This activity accomplished overall integration and reporting for the project; it included: (1) tracking progress; (2) providing bi-monthly status reports to NASA; (3) development of preliminary roadmap for future concept development (See Section 7 for additional details); (4) producing the final report (this document); and (5) participation in the NIAC Fellows conference (which occurred in late March 2012).¹

This final report is the principal result of Task 1.

1.2 Task 2: Integrated Framework for Analysis & Modeling

This project task comprised: (1) assessment and leveraging of models developed for previous studies, in particular the Space Segment Model from the NASA Fresh Look Study (1995-1997); (2) development of an architecture-level sensitivity analyses around point-of-departure values for key figures of merit (e.g., WPT specific mass in kg/kW, PV efficiencies, etc.); (3) preliminary cost estimation and economic analyses for selected markets and space applications; and, (4) analysis of the sensitivity of results to assumptions.

Details of the results of this task are presented in Section 4, “Systems Definition and Analysis Methodology,” and Section 7, “SPS-ALPHA Systems Analysis Results.”

1.3 Task 3: Business Case Development: Terrestrial Markets and Space Applications

The business case development task comprised: (1) identifying candidate terrestrial energy markets for power delivered from SPS-ALPHA; (2) identifying additional space markets and mission applications (e.g., for space exploration, space industrialization, etc.) for the SPS-ALPHA concept; this included creating several notional “design reference missions” (DRMs) for the concept; (3) selection of a handful of target market and applications that were addressed by Task 2; (4) development of a formal business case for SPS-ALPHA, focused on the selected markets / mission applications; and, (5) identification of potential partners and stakeholders for further development.

¹ The SPS-ALPHA presentation from the March 2012 NIAC meeting is at www.nasa.gov/pdf/636903main_Mankins_Presentation.pdf

The project found a wide variety of prospective applications of the SPS-ALPHA architecture, systems and technologies, and supporting infrastructure, including the areas summarized in Figure 1-2.



Figure 1-2 SPS-ALPHA Business Case Overview

Details concerning the results of this task are presented in Section 4, “Systems Analysis Methodology”, Section 5, “SPS ALPHA Market Forecast,” and Section 6, “Prospective non-SPS Applications.”

1.4 Task 4: SPS-ALPHA System Concept Definition and Visualization

This task comprised definition of the baseline SPS-ALPHA concept, including sizing, the overall configuration, and specific system requirements. (This definition was based on one or more SPS-ALPHA design reference missions (DRMs) that reflect selected markets and/or mission applications; see Task 3.) It also involved focused concept visualization activities resulting in a family of computer-rendered still visualizations, supported by a key consultant. Details of the results of this task are presented in Section 3, “Description of the SPS-ALPHA Concept.”

1.5 Task 5: Systems-Technology Trade Space Definition

The focus of Task 5 in the project was on (1) definition of a detailed systems-technology trade space for SPS-ALPHA, including identification and selection of technology options for key platform systems, definition of figures of merit (FOMs), and their interrelationships, and definition of goal and threshold FOM values (aka, “key performance parameters” (KPPs)); (2) population of FOMS and associated KPPs into the IFAM database (see Task 2); and, (3) review of selected FOMS at SSP SME workshop discussions (see Task 6). The focus of Task 5 was on the SPS-ALPHA platform; other supporting infrastructure elements (e.g., launch systems, in-space transportation, etc.) were treated only at a high-level, sufficient to allow preliminary systems analysis (under Task 2).

Details of the results of Task 5 are presented in Section 3, Description of the SPS-ALPHA Concept, and Section 7, “Systems Analysis Results.”

1.6 Task 6: Space Solar Power Subject Matter Expert Workshop(s)

The objective of this task was to conduct an SSP subject matter expert (SME) workshop, involving both US and International participants, and including support for travel funds for selected US workshop participants. In the actual project, this task supported two workshops, including the originally planned SME workshop, and a second workshop focusing on participation by international participants. Details of the results of this task are presented in Section 3, “Description of the SPS-ALPHA Concept”, Section 7, “Systems Analysis Results”, Section 8, “Technology Readiness and Risk Assessment”, and Section 9, “Path Forward: A Roadmap for SPS-ALPHA.”

1.7 Task 7: Integrated Technology Readiness and Risk Assessment

This task comprised: (1) evaluation of technology readiness level (TRL) for key SPS functions / systems; (2) identification of the “riskiness” of those technologies; and, (3) development of integrated technology readiness/risk matrices for key functions / systems.

Details of the results from implementation of this task are presented in Section 8 of this report, “Technology Readiness and Risk Assessment.”

1.8 Task 8: Critical SPS System / Subsystem Mass Estimation

This task accomplished estimation of baseline masses for critical systems / subsystems of the SPS-ALPHA platform, which were incorporated in the Systems Analysis Modeling (See Task 2). Selected details of the results of this task are discussed in Section 7, “Systems Analysis Results.”

1.9 Task 9: Public Dissemination of Results

This Task supported broad dissemination of results of project results through two major conferences: (1) the International Space Development Conference (ISDC) of the National Space Society (NSS), at which a paper was presented, and a formal track on SSP organized; (2) the American Institute of Aeronautics and Astronautics (AIAA) International Energy Conversion Engineering Conference (IECEC), at which a paper was presented; and, (3) the 2012 International Astronautical Congress (IAC) at which a paper will be presented in early October 2012. This task also supported the production of several high quality graphics in support of public dissemination of results, including a poster that was presented at the NAIC 2012 Spring Symposium. Details of the results of Task 9 are presented in Section 2 of this report, “Introduction.”

1.10 Task 10: Supporting US Experiments

This task was composed entirely of a student Engineering Clinic project to develop a breadboard wireless power transmission (WPT) experiment for SPS-ALPHA (including a microwave transmitter and rectifying antenna receiver. (This was accomplished as a part of 2011-2012 Engineering Clinic Program at Harvey Mudd College in Claremont, California.) The results of this task informed Tasks 4, 5 and 8, described above.

1.11 Task 11: International SSP Concept Studies and Experiments

This work package was composed of two international efforts including: (1) Kobe University, which conducted coordinated space solar power concept studies / experiments in parallel with activities in the US, and reporting of these at the SSP SME Workshop (Task 6); and (2) the University of Strathclyde, which conducted space solar power concept studies / experiments in parallel with activities in the US, and report these at the SSP SME Workshop (Task 6). The effort at Kobe University included technical topics such as microwave power transmission; space structural systems (e.g., tethers and inflatable structures); and in-space construction. The parallel effort at the University of Strathclyde focused on technical topics including orbital design and control, structural deployment sizing and control; system optimization; and, uncertainty quantification

The results of Task 11 were presented at the two SME workshops (Task 6, described above) and provided valuable information for Tasks 5 and 8, described above.

1.12 Summary of Results

The study concluded that the SPS-ALPHA concept could – with needed technological advances – make possible the economically viable deliver of solar energy to markets on Earth. In particular, it appears that a full-scale SPS-ALPHA, when incorporating selected advances in key component technologies should be capable of delivering power at a levelized cost of electricity (LCOE) of approximately 9¢/kilowatt-hour. As noted previously, at this point this result has been validated only to an early TRL 3 level of maturity.² Although no breakthroughs in technology appear to be needed to realize SPS-ALPHA, transformational changes in how space systems are designed are needed. Additional research and development (R&D) will be required for confirmation of this very promising finding.

² “TRL 3” is defined as an experimental or analytical proof of feasibility for a new concept.

THIS PAGE LEFT BLANK.

SECTION 2

INTRODUCTION

The vision of harvesting solar power in space and delivering it to markets from large platforms in Earth orbit has been known for decades. However, early solar power satellite (SPS) architectures were technically complex and unlikely to prove economically viable. There were several reasons; low technology maturity; excessive mass, due in part to the need for huge, high-voltage power management and distribution (PMAD); the cost of developing a monolithic SPS much larger than the International Space Station (ISS); the need for 100s of astronauts and 1000s of robots for SPS construction in space factories at various orbits, and others. Some of these early issues – particularly regarding technical feasibility – were addressed by NASA’s space solar power (SSP) studies and technology research in the mid-to-late 1990s. However, ten years ago a number of key technical and economic uncertainties remained.

The innovative advanced concept described here is a new approach to enable a technically feasible, economically viable and programmatically executable Solar Power Satellite (SPS): “SPS-ALPHA”, a hyper modular SPS by means of an Arbitrarily Large PHased (ALPHA). SPS-ALPHA is different from both current satellites and past SPS concepts in several ways. The most important of these is that SPS-ALPHA is a biologically inspired concept: in a manner analogous to a hive of bees, a large number of smaller modules (each individually “intelligent”) will physically assemble to form a large satellite.

This report presents the results from the 2011-2012 NASA Institute for Advanced Concepts (NIAC) Phase 1 “SPS-ALPHA” project, the goal of which was to establish the technical and economic viability of the SPS-ALPHA concept to an early TRL 3 – analytical proof-of-concept – and provide a framework for further study and technology development. This section provides some background on the topic of space solar power (SSP), as well as an overview of the SPS-ALPHA NIAC Phase 1 project.

2.1 Background

The concept of the “solar power satellite” was invented by Dr. Peter Glaser in the late 1960s.[1] The SPS concept is an elegant solution to the challenge of providing large-scale energy for humanity: a large platform, positioned in space in a high Earth orbit continuously collects and converts solar energy into electricity. This power is then used to drive a wireless power transmission (WPT) system that transmits the solar energy to receivers on Earth. Because its immunity to nighttime, weather or the changing seasons, the SPS concept has the potential to achieve much greater energy-efficiency than ground based solar power systems.

Since its invention, there have been numerous studies and technology projects conducted by various government agencies, companies and universities that have been focused on the goal of the Solar Power Satellite.

Early interest in the SPS concept resulted in the mid-to-late 1970s in intensive studies conducted by U.S. industry and government organizations, with joint support from the then recently created Department of Energy (DOE) and NASA. However, early SPS architectures were technically complex and unlikely to be economically viable; see Figure 2-1.

These initial SPS approaches suffered from a number of significant technical and programmatic challenges, including:

- (1) Low technology maturity;
- (2) Excessive weight, due in part to huge, high-voltage power management and distribution (PMAD) (up to 7,000 MW at > 10kV across a gimbaled interface);

- (3) Projected development costs for a monolithic platform more than 20 times larger than the International Space Station;
- (4) The up-front expense of the required fleet of heavy-lift reusable launch vehicles (RLVs); for example two-stage-orbit (TSTO) vehicles with payload requirements of up to 250 mT, See Figure 2-1; and,
- (5) The need for 100s of astronauts and 1000s of robots for SPS construction, and space factories at various orbits, and potentially of enormous scale, see Figure 2-1.[2, 3]

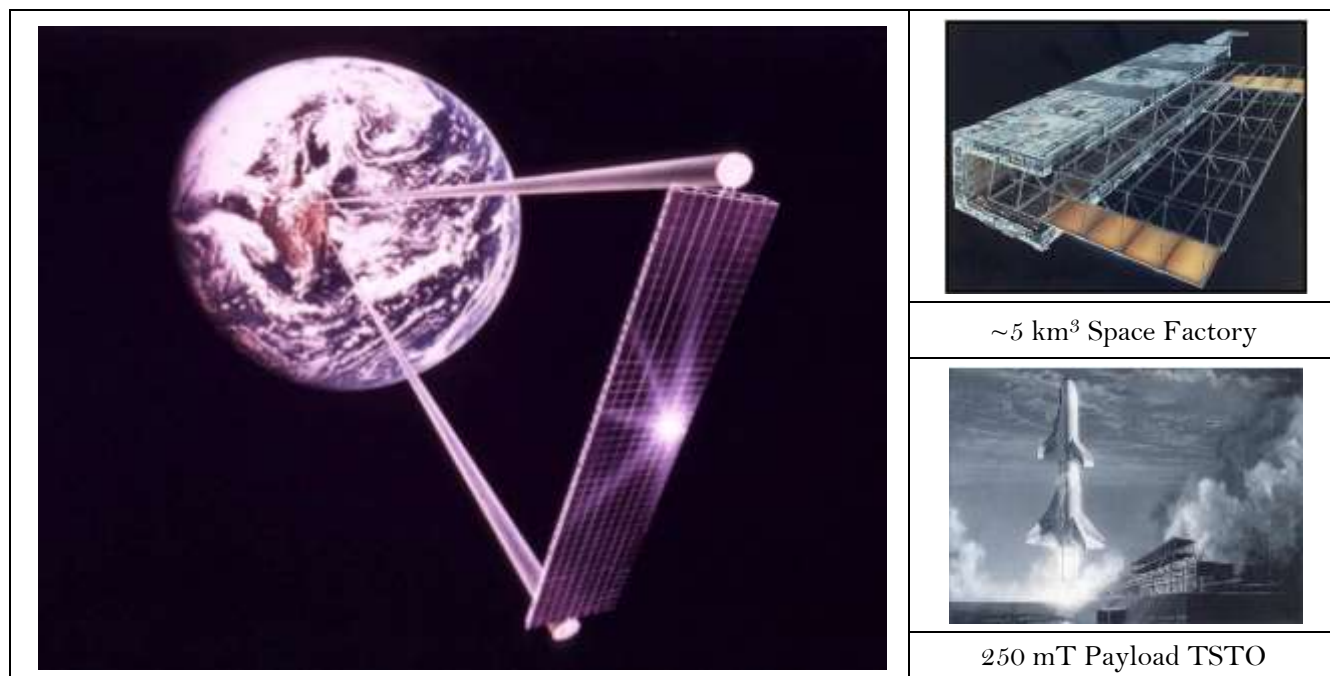

Figure 2-1 Illustration of the 1979 SPS Reference System Concept (and Supporting Infrastructure)³

Some of these early issues – particularly regarding technical feasibility – were addressed by NASA’s SSP studies and research and development (R&D) from 1995-2001, including the “Fresh Look Study” (1995-1997) and the SSP Exploratory Research and Technology (SERT) Program (1998-2001). [4,5,6,7] However, ten years ago key economic uncertainties remained, including:

- (1) Poor efficiency of key devices (e.g., amplifiers, photovoltaic (PV) cells, etc.);
- (2) The need for large-scale integration of key systems (e.g., PMAD, thermal management, etc.);
- (3) Inadequate capabilities in space robotics and autonomy;
- (4) The continuing need for RLVs prior to launching an initial SPS; and
- (5) The lengthy R&D program required for an initial SPS pilot plant (estimated at 20-25 years or more).

2.2 SPS-ALPHA NIAC Phase 1 Project Plan Summary

2.2.1 Project Goals and Objectives

The goal of the SPS-ALPHA NIAC Phase 1 project was to establish the technical and economic viability of the SPS-ALPHA concept to an early TRL 3 – analytical proof-of-concept – and provide a framework for further study and technology development. The objectives of the NIAC Phase 1 project were to:

³ NASA Graphics; c. 1980.

- (1) Conduct an initial end-to-end systems analysis of the SPS-ALPHA concept in order to determine its technical feasibility;
- (2) Identify and assess in greater detail the key technology challenges inherent in the architecture (including figures of merit for each critical technology area);
- (3) Conduct an initial evaluation of the economic viability of the concept (as a function of key performance parameters); and,
- (4) Define a preliminary roadmap for the further research and development of the SPS-ALPHA concept.

2.2.2 Project Approach

The NIAC Phase 1 project was implemented in two principal stages, with several specific work packages and appropriate crosscutting activities, as described in the following paragraphs (see Figure 2-2). This project extensively leveraged the results of the recently completed 3-year study of SSP/SPS conducted by the International Academy of Astronautics (IAA), which was co-chaired by John C. Mankins and Prof. Nobuyuki Kaya. [8]

Phase 1.A: Concept Definition and Analysis. Phase 1.A focused on initial definition, analysis and visualization of the SPS-ALPHA concept. It involved the formal development of a framework (including a spreadsheet-based tool) for systems analysis and modeling.

This framework comprised key functional elements of the architecture, which were elaborated and revised throughout the project. Also, it included identification, assessment, and selection of terrestrial markets and space applications for the SPS-ALPHA concept.

An initial detailed definition of the SPS-ALPHA system concept was formulated, including preliminary design choices for all major functional elements, and development of revised system concept visualizations. The systems model was updated as needed. Starting from the baseline concept definition, a trade space of technology and system alternatives was identified and values for key figures of merit (FOMs) determined. Using the updated systems modeling and analysis framework, baseline values for the FOMs, including end-to-end “specific energy” conversion efficiencies were defined. Phase 1.A concluded with a technical interchange workshop in February 2012, to which space solar power subject matter experts (SMEs) were invited, including both U.S. and international SMEs. A follow-on meeting was held in March 2012. At these meetings, progress on the international SSP concept studies and experiments was reviewed.

Phase 1.B: Concept Refinement, Evaluation, and Reporting. Phase 1.B integrated the results of Phase 1.A, producing an assessment of the technologies involved, and synthesizing recommendations for future efforts. This stage began with an initial integrated technology readiness and risk assessment (TRRA) of the SPS-ALPHA concept using the results of the SME workshop and supporting literature research. Based on these results, end-to-end efficiency estimates were updated, and critical system/subsystem masses estimated to first order. The results of the above efforts, supported by U.S. and International experiments, were used to update systems models, and perform sensitivity analyses around critical figures of merit.

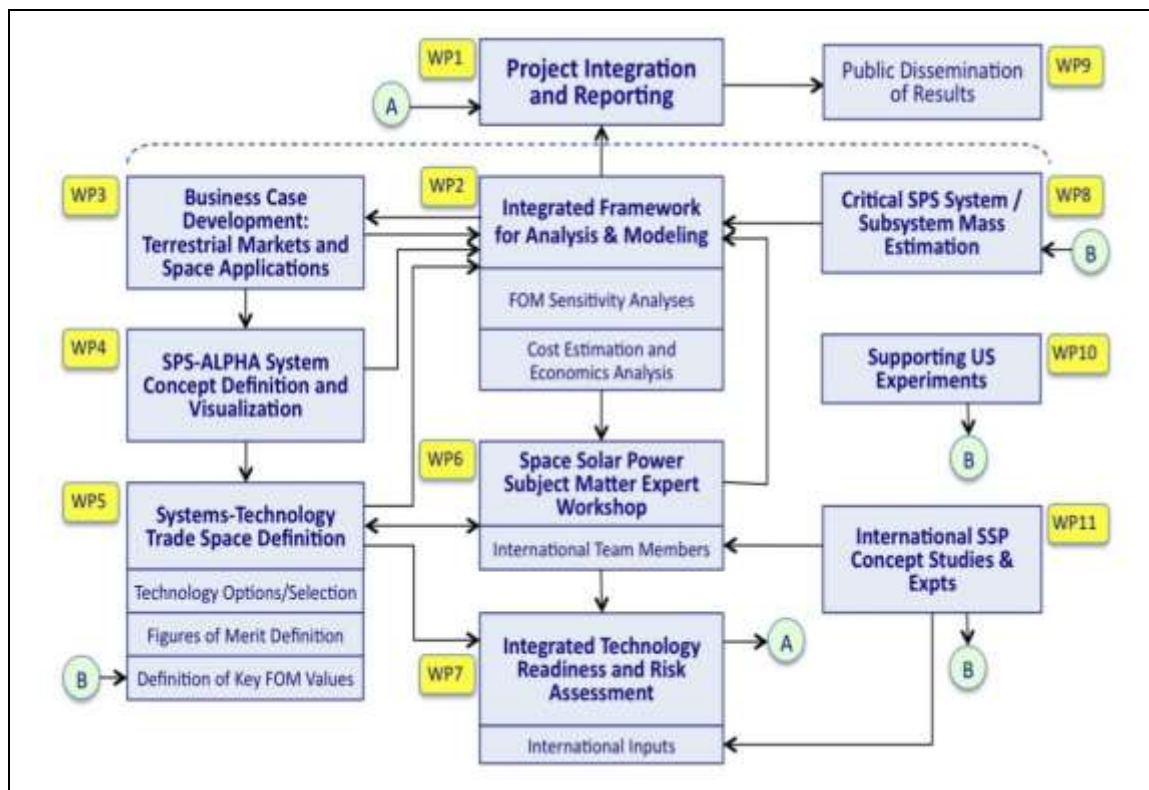

Figure 2-2 SPS-ALPHA NIAC Phase 1 Project Approach

In addition, preliminary economics of the SPS-ALPHA concept were evaluated (e.g., life cycle cost, economics for key markets, etc.). During this stage, the previously selected target markets and space applications were revisited and a formal business case formulated for the further development of SPS-ALPHA, including the identification of potential partners and stakeholders.⁴

Cross Cutting Activities. In addition to the major project stages described above, the project also supported regular progress integration and reporting tasks, participation in the NIAC Fellows' conference (date to be determined), and broad dissemination of results (Task 9) through two major US conferences: the National Space Society's (NSS) International Space Development Conference (ISDC), and the AIAA IECEC 2012 Conference and at the 2012 International Astronautical Congress.

⁴ The original project proposal included a sub-task to develop a short video of the new concept; however, this was dropped in the final implementation in favor of developing detailed figures of each of the several modular systems elements that comprise SPS-ALPHA (shown in Section 3).

SECTION 3

DESCRIPTION OF THE SPS-ALPHA CONCEPT

3.1 Introduction

Traditional space systems typically reflect an architectural approach that may be described as integrated or “monolithic”; in other words, the mission objectives (whether they are scientific, military or commercial) are accomplished by a single system or system of systems in which there are no more than one or a small number of identical parts. Examples range from launch vehicles, to various Earth-orbiting satellites, to deep space robotic missions and human space exploration systems; these include systems starting with the first satellites in the earliest days of the space program in the 1950s, and continuing with the systems of the Apollo Program in the 1960s, the Space Shuttle in the 1970s (which had several identical main engines (SSMEs), but represented a single system), the Cassini spacecraft to Saturn in the 1980s-1990s (with its Huygens probe to Titan), and the International Space Station (ISS). The ISS was constructed during multiple missions, but represents a single large system albeit with a number of identical elements, such as the solar arrays.

There are a number of space programs that require multiple space systems to accomplish overall program goals and objectives. For example, the Global Positioning Satellite (GPS) system requires multiple satellites operating in orbit simultaneously to accomplish the goal of assured position, location and navigation services to civil, commercial and military operations on Earth. Similarly, the Iridium Constellation requires multiple satellites operating (and communicating satellite-to-satellite) in low Earth orbit (LEO) to provide global coverage to government and private sector customers on Earth. However, the individual satellites that comprise these constellations are integrated or “monolithic” architecture systems.

Solar power satellite (SPS) concepts of the 1960s and 1970s followed the same architectural approach (See Figure 1). As proposed, these SPS would have been assembled in space (like the ISS), but would have been huge, monolithic systems. The classic 1979 SPS Reference System was, in fact, conceived as a colossal 3-axis stabilized integrated space system with a single sun-pointed solar array, some 5 km by 10 km (or larger), a rotary gimbal system that transferred power to a large number of electron tube based microwave generating systems (e.g., via gyrotrons), that fed RF energy into a mechanically rigid 1,000 meter diameter Earth-pointing microwave waveguide antenna system. Truly stupendous in concept, the 1979 SPS architecture would have been a single, monolithic 50,000 mT-100,000 mT space system.

The SPS-ALPHA concept represents a radically different approach. SPS-ALPHA is a biologically inspired architecture, analogous to a hive of bees, or a colony of ants; here, a very large number of modules will be assembled to form a single enormous satellite.

3.2 Solar Power Satellite Generic Architecture

3.2.1 Generic Solar Power Satellite Functional Architecture

In order to evaluate and compare various SPS approaches, it was necessary to identify the common functional elements that characterize most SPS concepts. Figure 3-1 presents a high-level / generic solar power satellite (SPS) functional architecture may be used to characterize different types of SPS system concepts.

Figure 3-1 Generic SPS Functional Architecture

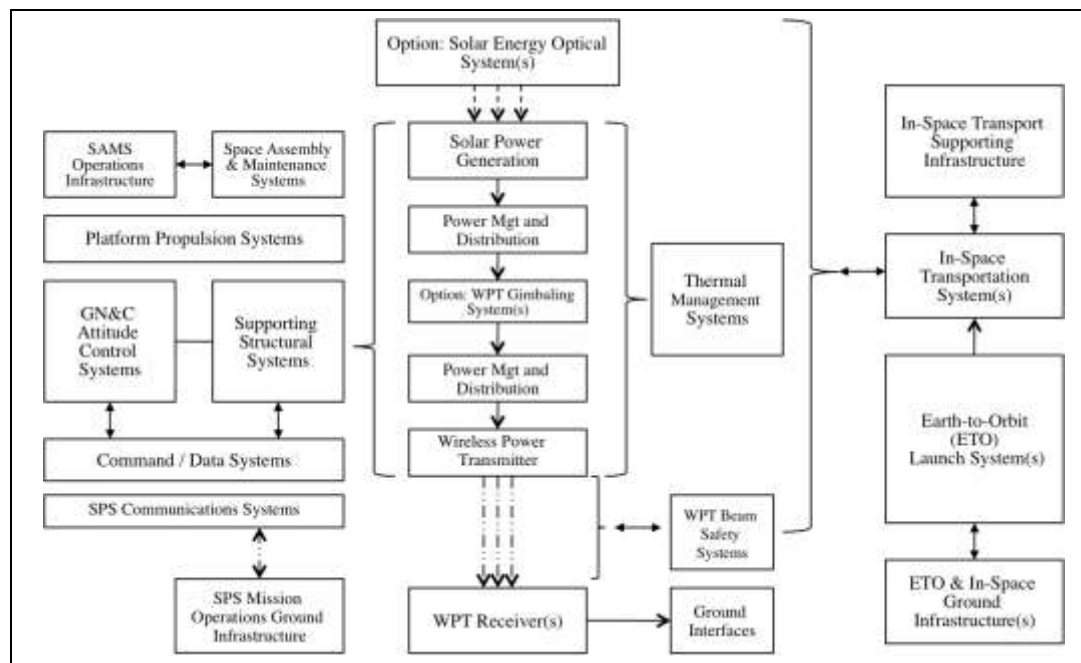

The major categories of operations / systems within this generic SPS functional architecture are:

- Primary SPS Platform Systems
- Secondary SPS Platform Systems
- Ground Systems
- Supporting Systems / Infrastructure

Most of the elements listed are common to all types of SPS. However, a number of them are “options” that appear in some SPS concepts, but not in others. For the discussion that follows, the generic cases have been tailored to include only those options that are germane to the SPS-ALPHA concept (i.e., microwave power transmission, including solar energy distribution using optics rather than PMAD, etc.).

Primary SPS Platform Systems. The following are the major elements that comprise the primary functional systems of the SPS-ALPHA platform (including the end-to-end wireless power transmission system).

- Solar Power Generation (SPG)
 - Ancillary SPG functions include: SPG - Power Management and Distribution (PMAD), and SPG - Thermal Management Systems (TMS). There may also be SPG Solar Energy Optical Systems, depending on the configuration of the SPS SPG system.
- Platform PMAD System
 - Ancillary SPG functions will include: Platform PMAD - Thermal Management Systems (TMS).
- Wireless Power Transmission System (WPT) – On-Board Transmitter
 - Ancillary WPT On-Board functions will include: WPT – PMAD, and the WPT – TMS
- WPT System – Ground Receiver
 - Ancillary WPT Ground functions include: WPT Beam Safety Systems

Secondary SPS Platform Systems. The following are the most significant elements that constitute the secondary in-space systems of the SPS-ALPHA platform.

- Platform Structural Systems
- Guidance, Navigation and Control (GN&C) / Attitude Control Systems (ACS)

- Platform Propulsion Systems
- Command & Data Systems (CDS)
- SPS Communications Systems
 - Including On-Board Communications, Space-to-Space Communications and Space-to-Ground Communications
- Space Assembly, Maintenance and Servicing Systems (SAMS) – Platform based

Ground Systems. The following are the major elements that comprise the primary ground systems that support a typical SPS platform.

- WPT Ground Energy Distribution Interfaces
 - Including to different approaches: Power Grid Interface Option: Power Grid Interface(s), and Synthetic Fuel Production Interface(s)

- SPS Mission Operations Ground Infrastructure

Supporting Systems / Infrastructure. The following are the most important systems that comprise the common supporting infrastructure for a generic SPS platform.

- Earth-to-Orbit (ETO) Transportation
 - Including the following functional capabilities: ETO Launch Vehicles, ETO Launch Infrastructure, and ETO Mission Operations Ground Infrastructure.
- Affordable In-Space Transportation (AIST)
 - Including the following functional capabilities: AIST Vehicles, AIST Ground Support Infrastructure, and AIST Mission Operations Infrastructure.
 - Option: For Reusable AIST, this may also include In-Space Supporting Infrastructure, with functional capabilities such as AIST In-Space Refueling Platform(s), and AIST SAMS Systems(s)
- In-Space Infrastructure
 - Including functional capabilities such as an SPS In-Space Refueling Systems(s), and SPS SAMS Systems(s).

The sub-section that follows presents a detailed description of the SPS-ALPHA architectural concept, with traceability to the generic functional architecture summarized above.

3.3 SPS-ALPHA Concept Description

3.3.1 Concept Overview

The basic concept of SPS-ALPHA is to form an exceptionally large space platform from an extremely large number of small, high modular elements, where only a small number of types of modules are used. Figure 3-2 presents an example of such cooperative behavior: a team of skydivers who have cooperated to form quickly a large, complex structure during a jump. In the case of SPS-ALPHA, the modular elements (of which there are eight basic types) are in combined in various ways to comprise a number of functional assemblies.



Figure 3-2 An Example of Cooperative Behavior: Sky Divers

3.3.2 Detailed Concept Description

As shown in Figure 3-3, the SPS-ALPHA concept involves three major functional elements: (1) a large primary array that is nadir pointing (toward Earth). (2) a very large sunlight-intercepting reflector system (involving a large number of reflectors that act as individually pointing “heliostats”, mounted on a non-moving structure; and (3) a truss structure that connects those two. As conceived, SPS-ALPHA is not a traditional 3-axis stabilized satellite with one or more solar arrays (i.e., “solar paddles” as described in Japan). Rather, SPS-ALPHA entails body-mounted (non-moving solar power generation (SPG) on a gravity-gradient stabilized satellite, with an axisymmetric physical configuration.

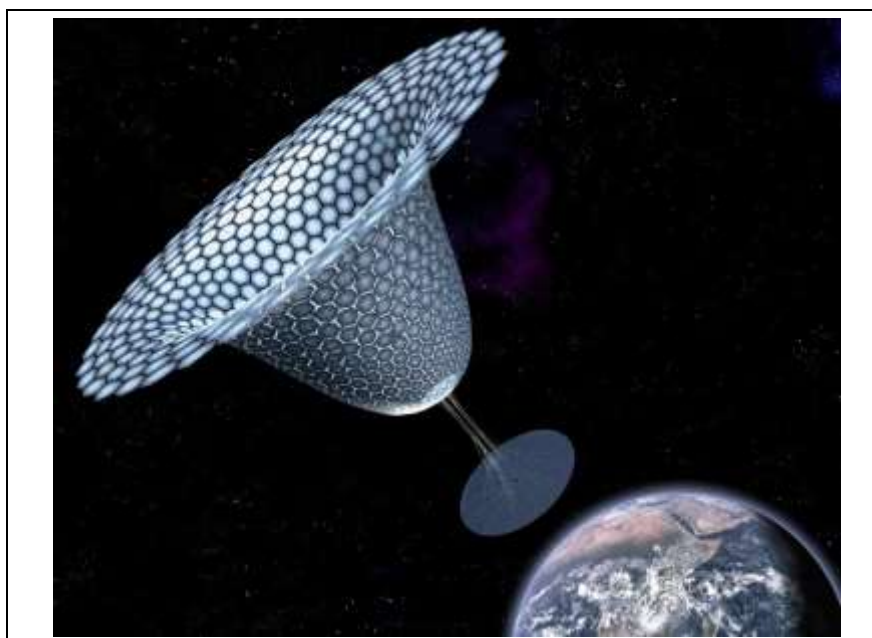



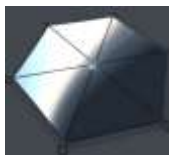

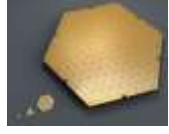



Figure 3-3 Illustration of One Version of the SPS-ALPHA Concept

Table 3-1 provides a very high-level generic summary of the currently identified SPS-ALPHA system elements. The major components are individually small and “intelligent”. (The initial goal for the project was that none would be more massive than 100-300 kg.) In the baseline version of the SPS-ALPHA concept, the only

interfaces between the modules are mechanical connections and wireless communications. Unlike earlier SPS concepts, in this case there is no large or high-voltage PMAD system; there are no cooling loops or radiators.

Table 3-1 SPS-ALPHA Generic System Elements Summary

System Modular Element	Description	Element Image	Approx. Number*	Est. Mass (kg)
HexBus	The "HexBus" is a specially configured "smallsat" (diameter 4m) capable of wirelessly communicating with neighboring systems.		>200,000	~ 25 kg
Interconnects	The "Interconnects" are nanosats that mechanically link essentially all other SPS-ALPHA modules to one another.		>900,000	~1 kg
HexFrame Structural Module	The "HexFrame Structural Modules" (HSM) are simple deployable beams (specific type to be determined) that provide the base structure for the reflectors, and connect the reflector array to the power/transmitter array.		~ 5,000	~50 kg
Reflectors & Deployment Module	The "Reflectors and Deployment Module" (RDM) are large, thin-film reflectors (e.g., aluminum on Kapton) that redirect incoming sunlight to the SPG, along with a central deployment plate.		4,000– 5,000	~75-100 kg
Solar Power Generation (SPG) Modules	The solar power generation (SPG) modules generate the power for the WPT transmitter; there are six per HexBus.		200,000 – 300,000	~15-20 kg
Wireless Power Transmission (WPT) Module	The WPT modules convert the electricity on the platform into a coherent RF (microwave) transmission to the receiver on Earth; there are numerous units per HexBus.		200,000 – 300,000	~50 kg
Modular Push-Me / Pull-You Robotics (MPPR) Arms	The Modular Push-Me / Pull-You Robotics (MPPR) arms provide all sorts of In-Space Assembly and Construction (ISAAC) and actuation onboard the SPS-ALPHA Platform.		< 5,000	~ 10 kg
Propulsion / Attitude Control Module	The Propulsion / Attitude Control (PAC) Modules provide the required propulsion for guidance, navigation and control (GN&C) and station keeping for the Platform. Mass depends on time between refueling.		50-200	50-500 kg**

* Number of elements based on approximately 1,000 meter-1,200 meter diameter power generation/transmitter array
 ** The PAC Mass depends on the propellant load requirements, and the time between refuelings

The unique reflector configuration (see Figure 3-3) is capable of providing constant solar energy to the transmitter modules (described below), but there is no single-point-of-failure gimbaled system, as there are in many other SPS concepts. No breakthroughs in physics are required for SPS-ALPHA; however, the concept incorporates several emerging technologies, as well as existing technologies used in new ways.

The technical foundations of the concept are the following.

The Retro-Directive Phased Array (RDPA). SPS-ALPHA incorporates the concept of the retro-directive phased array, which allows a large number of individual RF elements to be controlled and their transmissions made coherent through the use of a “pilot signal” transmitted from the site of the planned receiver. This technology (co-invented by Prof. Nobuyuki Kaya of Kobe University) allows the large microwave transmitter required for the concept to be assembled from modular elements via an RF version of adaptive optics. This technology has already been proven at low TRL in several field tests, including in Hawaii (2008), and at a conference in Canada (2009). [9,10,11,12]

Large/Individually-Pointed Thin-Film Reflectors on a Non-Rotating Structure. SPS-ALPHA uses large, thin-film reflectors to redirect and concentrate sunlight. Significant advances have been made in this field in the past decade, most recently the successful launch and deployment of JAXA’s IKARAS solar sail demo. [13] SPS-ALPHA uses such structures as pointed mirrors – analogous to ground-based solar thermal power systems (e.g., Spain’s Solucar PS10).

Mass Production (at Low Cost) of All Platform Elements. The potential economic viability of SPS-ALPHA depends on mass-producing all elements of the system. The highly modular architecture will allow the use of manufacturing analogous to that currently used for satellites in large constellations (such as the Iridium), or in the manufacture of Remotely Piloted Vehicles (RPVs) rather than typical spacecraft. (With hardware costs of less than \$500-\$1,000 per kg.)

Robotic Assembly in Highly Structured Space Environments. SPS-ALPHA depends on the use of in-space robotic assembly at a scale unprecedented previously. However, the requirement is for robotic assembly in a highly structured environment – not an unstructured environment such as that found in planetary surface exploration. The type of technology needed is currently in use in terrestrial applications such as automated mining operations and large commercial farming.

Additional characteristics of the concept include:

Orbital Location. To deliver energy to Earth, SPS-ALPHA would be based in a geosynchronous Earth orbit, where it would intercept sunlight using a collection of individual thin-film mirrors, convert that sunlight across a large RF aperture into a coherent microwave beam and transmit it to targets on Earth. SPS-ALPHA might also be based in alternative Earth orbits, or elsewhere, such as at Earth-Moon Libration points, lunar orbit, Sun-Earth Libration points, Mars orbit, and would deliver abundant and affordable solar power to Earth or to enable ambitious future space exploration and development.

Fault Tolerance. The SPS-ALPHA concept involves no single points of failure, and is highly scalable from small prototypes to larger sizes and higher power levels. Each of the intelligent modular elements that comprise the large aperture would incorporate:

- (1) Local solar power generation (SPG);
- (2) Local power management and distribution (PMAD);
- (3) A wireless power transmission (WPT) based on the retro-directive phased array approach;
- (4) A local thermal management system; and,
- (5) A small “flat” spacecraft bus (e.g., in the form of a hexagonal panel) that hosts the above, and interconnects with others in the array.

3.4 Detailed Element Descriptions

The current state of the SPS-ALPHA concept incorporates a total of some 8 elements – achieving an overall project goal. These elements include the following principal parts, each of which may be integrated in various implementations to realize the overall SPS-ALPHA SPS platform:

- HexBus Module
- Interconnects
- HexFrame Structural Module
- Reflectors & Deployment Module
- Solar Power Generation Module
- Wireless Power Transmission (WPT) Module
- Modular Robotics / ISAAC Module
- Propulsion / Attitude Control Module

These eight modular elements are used to accomplish all of the basic functions of the Solar Power Satellite, as depicted in the SPS Generic Architecture (described above).

The following paragraphs provide more detailed descriptions of each of these modular elements of the SPS-ALPHA concept.

3.4.1 HexBus Description

The “HexBus” is a specially configured smallsat capable of mechanically connecting to, and wirelessly communicating with neighboring systems. The HexBus is conceived of as a “ring structure”, with finite height and thickness, in which the center of the structure is open. A single Hexbus could be hexagonal when viewed from the top, or could be of different shapes (e.g., triangle, square, or parallelogram) or combinations of shapes (e.g., square and octagon), so long as the combination allows the “tiling” of a plane to create a large aperture system in space. Figure 3-4 presents a conceptual illustration of this module.



Figure 3-4 Illustrations of the “HexBus” Modular Spacecraft Concept

A nominal physical configuration for the HexBus would be one in which the overall “ring” is some 4 meters in diameter (corner to corner), the thickness of the ring is some 15 cm, and the height of the bus is 20 cm. The ring is hollow, with the interior being reserved (just as is the interior of a CubeSat) for various subsystems. However, these dimensions could be adjusted as needed (for example a demonstration system could be smaller in scale without affecting the principal functionality of the HexBus concept. As shown in the figure, it is anticipated that the HexBus could be fabricated from a number of materials, including aluminum, carbon composites or more exotic materials, such as composites that include a proportion of Carbon Nanotubes (CNTs).

The Interconnects and the MPPR Arms connect to the Hexbus through one or more of a series of recessed grapple fixtures in the top, bottom and sides of the bus (these appear as “holes” in Figure 3-4). The following subsystem / functions are expected to be incorporated into each HexBus:

- Mechanical and Structures, including unique identifiers such RFID tags, Bar Codes at specific locations on the frame, etc., which are note shown.
- Command and Data Handling
- Power, including a small battery, and a small body-mounted solar array on the surface of the HexBus⁵
- Power Management and Distribution (PMAD), including power wire, switches, control chips, etc.
- Telecommunications (including a wireless router)
- Data Harness
- Guidance Navigation and Control (GN&C) Sensors
- Thermal
- Propulsion System Controls & Interfaces (only in the version for the Propulsion / Attitude Control Assembly (PACA), see below)

The mass for a given HexBus has been estimated based on its function, as have preliminary masses for all of the modules within the SPS-ALPHA “system of systems”; these mass estimates vary somewhat depending on the specific scale and concept of operations (CONOPS) for the platform. Examples are provided in Section 7, “Systems Analysis Results.”

Future Study. The diameter of the HexBus structure, as well as the height and thickness of the ring are all variables to be analyzed in greater detail, as are the choice of materials and positioning of key subsystems inside the ring. Prototyping should play a key role in the resolution of these factors. The potential incorporation of larger-scale power distribution (from HexBus to HexBus) and similar waste heat distribution are also topics for future analysis and R&D.

3.4.2 Interconnects Description

The “Interconnects” are nanosats that mechanically link almost all other SPS-ALPHA modules to one another. (The exception being the MPPR Arms, which can connect directly to the HexBus modules.) Figure 3-5 presents several conceptual illustrations of this nano-sat scale connecting module, along with a close-up view of an inset option for the grappling fixture to which the Interconnects would attach when deployed.

At a minimum, the Interconnects must connect various modules to the Hexbus modules (or release them when necessary). The may also provide additional functionality, such as vibration isolation (passive or active) when required.



⁵ External features, such as a body-mounted solar array,



Figure 3-5 Illustrations of the “Interconnects” Concept

The specifics of the Interconnects structure and mechanical actuators, including the width and length of an Interconnect are all variables to be analyzed in greater detail, as are the choice of materials and details of interfaces with each of the other SPS-ALPHA modules. Prototyping should play a key role in the resolution of these and other issues.

3.4.3 HexFrame Structural Module Description

Each “HexFrame Structural Module” (HSM) is a deployable beam that can also be assembled with other HSMs and Hexbuses to provide the basic structure element of the SPS-ALPHA concept, including the structure for the Solar Reflector Assembly (SRA) and for the Connecting Truss Assembly (CTA), both described below, to connect the Solar Reflector Assembly to the Primary Power/Transmitter Array. Figure 3-6 presents a conceptual illustration of this module, including a number of alternative optional approaches.

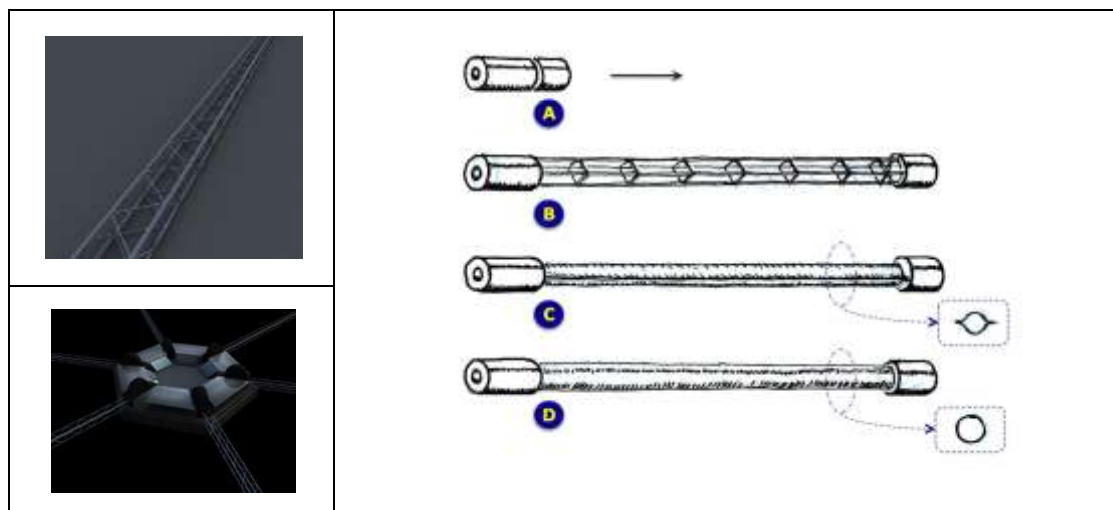

Figure 3-6 Options for the “HexFrame” Structure Deployable / Assembly Beam Concept

In the figure, the A tag indicates a not-yet deployed HSM canister; specific dimensions (including the aspect ratio – length to diameter – of the deployed structure are yet to be determined. At present, there are three HSM options, as shown: a deployable truss structure (Tab B), a pre-stressed structure (Tab C), and an inflatable / rigidizable structure (Tab D). In all three of these cases, the HSM integrates with other SPS-ALPHA elements as discussed in Paragraph 3.5, which follows. In addition, the structure is used as a key component in the Thin-Film Reflectors & Pod (TFRP) modules, discussed further below.

The HSM structures are used in combination with other modules to deploy a variety of key structural parts of the SPS-ALPHA platform. Details of these applications are described below (see Primary Structure Assembly, and Connecting Truss Structure Assembly). These include three basic functional purposes in the SPS-ALPHA concept; these are: (1) to provide (in combination with HexBuses, and Interconnects) the framework upon which the individually pointed “heliostat” reflectors are mounted (i.e, the “Reflector HexFrame”); (2) to provide (in combination with Hexbuses and Connectors) the structure that connects the Reflector HexFrame and the Primary Array; and (3) to create in combination with Hexbuses, Interconnects, Modular Robotic Arms, and the HexFrame Harvest Reflectors the individually pointed “heliostats”.

The specifics of the type of structure to use for the HexFrame, including the width and length of a single boom, as well as the choice of materials and details of interfaces with each of the other SPS-ALPHA modules, are all variables to be analyzed further. Prototyping should play a key role in the resolution of these questions.

3.4.4 Thin-Film Reflectors & Pod (TFRP) Description

The “Thin-Film Reflectors & Pod” (TFRP) is a specially configured canister in which a number of large, thin-film reflectors (e.g., aluminum on Kapton) are folded and ready for deployment when appropriate. The TFRPs are used, when integrated into the Solar Reflector Assembly (SRA), to redirect incoming sunlight to the SPG. In the baseline case shown illustrated in this report, the configuration of the basic building block is a hexagon, and so each TFRP would have six sides and would deploy some six triangular thin-film reflectors. Figure 3-7 presents a conceptual illustration of this module, including several stages of deployment. (See the discussion of the Solar Reflector Assembly (SRA) below for additional information and images.)

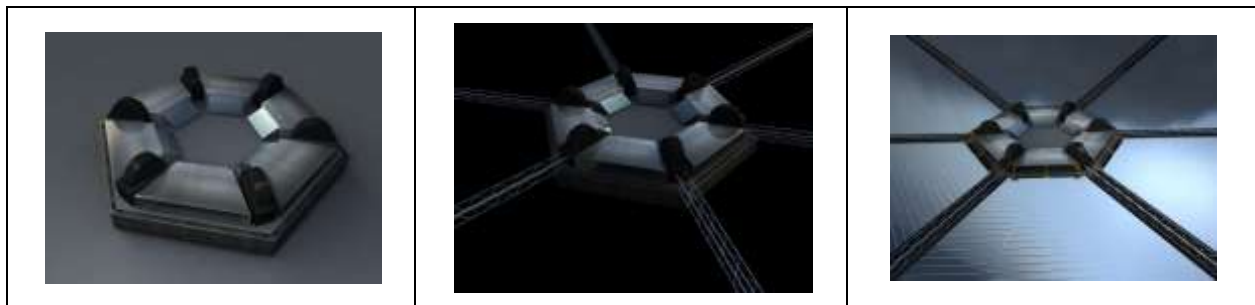

Figure 3-7 Illustrations of the Thin-Film Reflectors & Pod (TFRP) Concept

The TFRP is pre-integrated (prior to launch) with six deployable HexFrame Booms that extend with the thin-film reflectors already attached at the ends of each boom. There is considerable heritage for the TFRP concept. (A prototype was tested in the laboratory by DLR in the early 2000s of a four-sided boom-based solar sail concept that is quite similar to the six-sided concept presented here.)

The specifics of the structure and mechanical actuators, including the width and length of an Interconnect are all variables to be analyzed in greater detail, as are the choice of materials and details of interfaces with each of the other SPS-ALPHA modules. Prototyping should play a key role in the resolution of these and other issues.

3.4.5 Solar Power Generation (SPG) Module Description

The solar power generation (SPG) modules generate the power for either the WPT module or for the PAC module. Nominally, there are six (6) SPG modules per HexBus in either the Primary Array Assembly of the PAC Assembly (described below). Figure 3-8 presents a conceptual illustration of this module. The reference approach for the SPG module in a full-scale SPS-ALPHA is to incorporate high efficiency multi-bandgap PV cells. In addition to the specific mass (kg per kW) of the SPG modules, the energy conversion efficiency (photons-to-DC) is also extremely important; the higher the efficiency, the lower the production of waste heat and the lower the temperature of the module for a given level of power production.

Early demonstrations of the SPS-ALPHA concept will not require high efficiency and low mass in the SPG; however these characteristics will be crucial in the full-scale SPS. Further study, and prototyping are needed, including technology flight experiments.

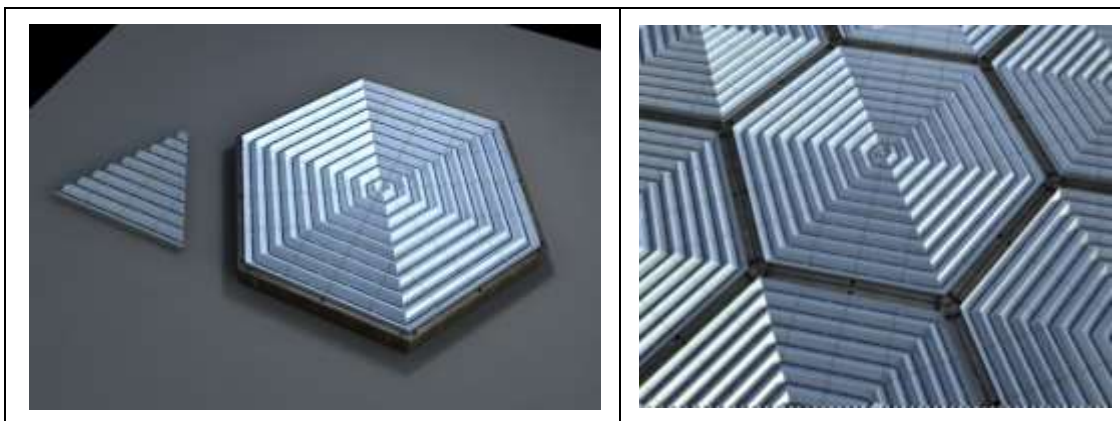
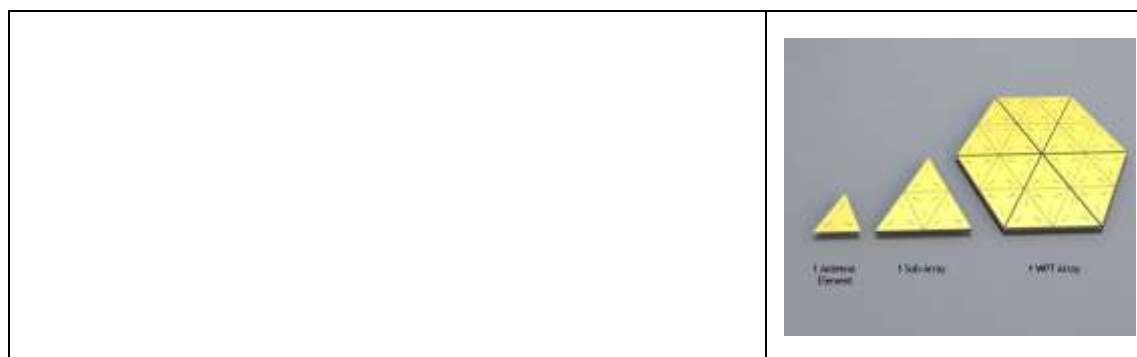

Figure 3-8 Illustrations of the “Solar Power Generation” (SPG) Concept

3.4.6 Wireless Power Transmission (WPT) Module Description

The WPT modules convert the electricity on the platform into a coherent RF (microwave) transmission to the receiver on Earth; there are numerous units per HexBus. Figure 3-9 presents a conceptual illustration of this module.⁶ The key technology that enables wireless power transmission from a somewhat flexible large aperture (as in SPS-ALPHA) is the retrodirective phased array (RPA), in which a pilot signal from the planned receiver delivers a phase reference to each WPT sub-array (see upper right corner, Figure 3-9). The phase reference signal enables the total system (incorporating some thousands of Primary Array Assemblies; see Section 3.5.1) to transmit RF energy coherently to the target.

The photograph in the lower right corner of Figure 3-9 is an actual microwave WPT transmitter, developed by Prof. N. Kaya and his team at Kobe University.^[14]



⁶ The specific antenna concept illustrated in Figure 3-9 is only one option; there are a number of alternatives, most of which are rectangular in configuration, as shown in the photograph in the lower right-hand corner of the figure.

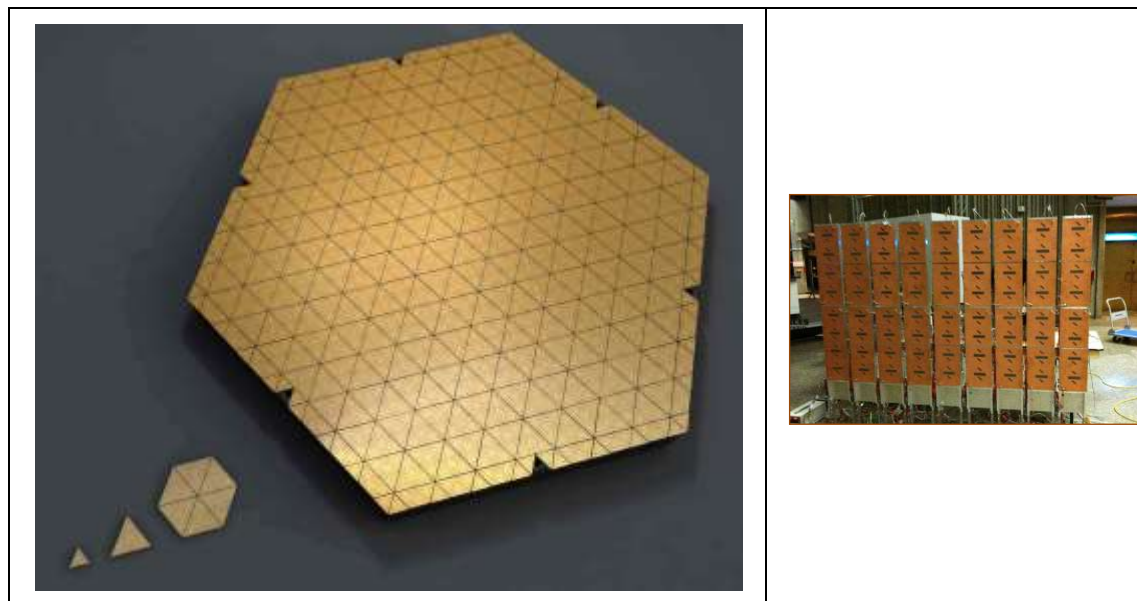

Figure 3-9 Illustration of the “Wireless Power Transmission” (WPT) Module Concept

The SPS-ALPHA reference approach for the WPT module in a full-scale SPS-ALPHA is to employ high power and high efficiency solid-state power amplifiers (SSPAs). In addition to the specific mass (kg per kW) of the WPT modules, the energy conversion efficiency (DC-to-RF) is extremely important; the higher the efficiency, the lower the production of waste heat and the lower the temperature of the module for a given level of power transmission. Additional R&D is needed, addressing SPG components (e.g., PV cells) and modules, as well as systems studies and prototyping.

3.4.7 Modular “Push-Me/Pull-You” Robotic (MPPR) Arms Description

The central concept for assembly and servicing of the SPS-ALPHA platform is to utilize a small number of types of Modular “Push-Me/Pull-You” Robotic (MPPR) Arms that can be reconfigured in a wide variety of ways. In principal only one or two types of MPPR systems will be required. These robotic arms will operate independently, or connect to each other and operate cooperatively, or to HexBus modules to implement various key functions, including In-Space Assembly and Construction (ISAAC) and Space Assembly, Maintenance and Servicing (SAMS) for the platform. Figure 3-10 presents a conceptual illustration of two views of one configuration for the MPPR module.

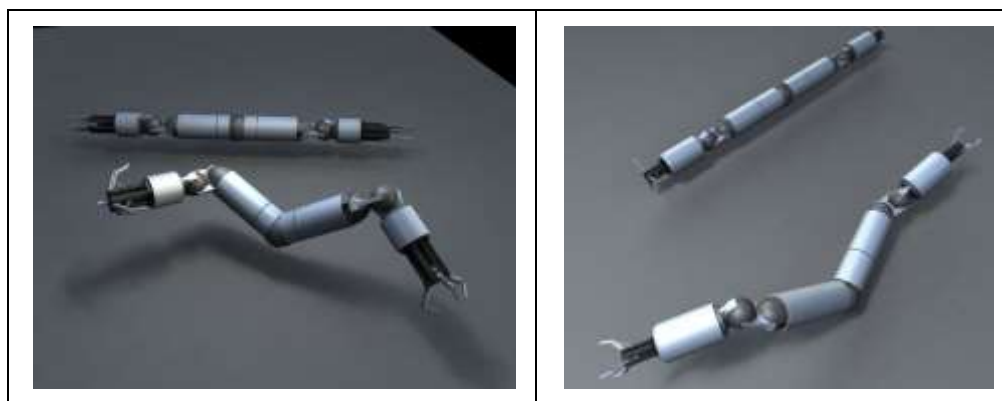

Figure 3-10 The Modular “Push-Me/Pull-You” Robot (MPPR) Arms Concept

In general, the MPPR arms represent strong heritage to the Remote Manipulator System (RMS) developed by the Canadian Space Agency (CSA) and used on the Space Shuttle and the International Space Station

(ISS). In this case, the MPPR arms are un-tethered, with interface fixtures on both ends; they would include minimal on-board power, and would instead draw power from the HexBus modules through which the arms connect with the platform. (See Paragraph 3.5.6 below.) As above, additional R&D, studies and demonstrations are needed.

3.4.8 Propulsion / Attitude Control (PAC) Module Description

The Attitude Control (AC) / Propulsion Modules provide the required propulsion for guidance, navigation and control (GN&C) and station keeping for the Platform. The total mass of the PAC module system will be driven by tankage requirements, and depends upon the planned duration of time between refueling. (In other words, if the CONOPS calls for refueling once every five (5) years, the tank size and mass on the PAC modules will be significantly larger than if the specification is for once every two (2) years.) Figure 3-11 presents a conceptual illustration of this module.

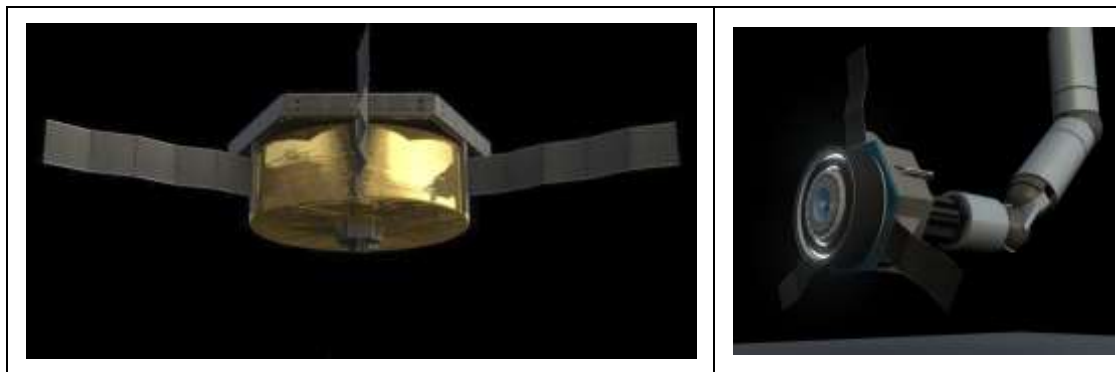

Figure 3-11 Illustrations of the “Propulsion / Attitude Control” (PAC) Concept

Important topics for future studies and R&D include electric thrusters (performance, cost, lifetime), choice of propellants, refueling, GN&C, platform integration, etc.

3.5 Key SPS-ALPHA Assemblies

From the eight required modular elements described above, all of needed SPS-ALPHA concept “System Assemblies” are to be constructed, and from these in turn the entire SPS-ALPHA platform. Figure 3-12 provides a high level illustration of this concept.

The principal “Assemblies” that comprise the SPS-ALPHA spacecraft architecture are the following:

- Primary Power/Transmitter Array (PPTA)
- Primary Array Assembly (PAA), from which the PPTA is assembled
- Solar Reflector Assembly (SRA)
- Primary Structure Assembly (PSA)
- Connecting Truss Structure Assembly (CTSA)
- Propulsion / Attitude Control Assembly (PACA)
- Modular HexBot Assembly (MHA)

Table 3-2 presents a matrix that summarizes the crosswalk between the eight (8) modular elements and the six (6) primary assemblies that will comprise SPS-ALPHA. Details are presented in the paragraphs that follow.

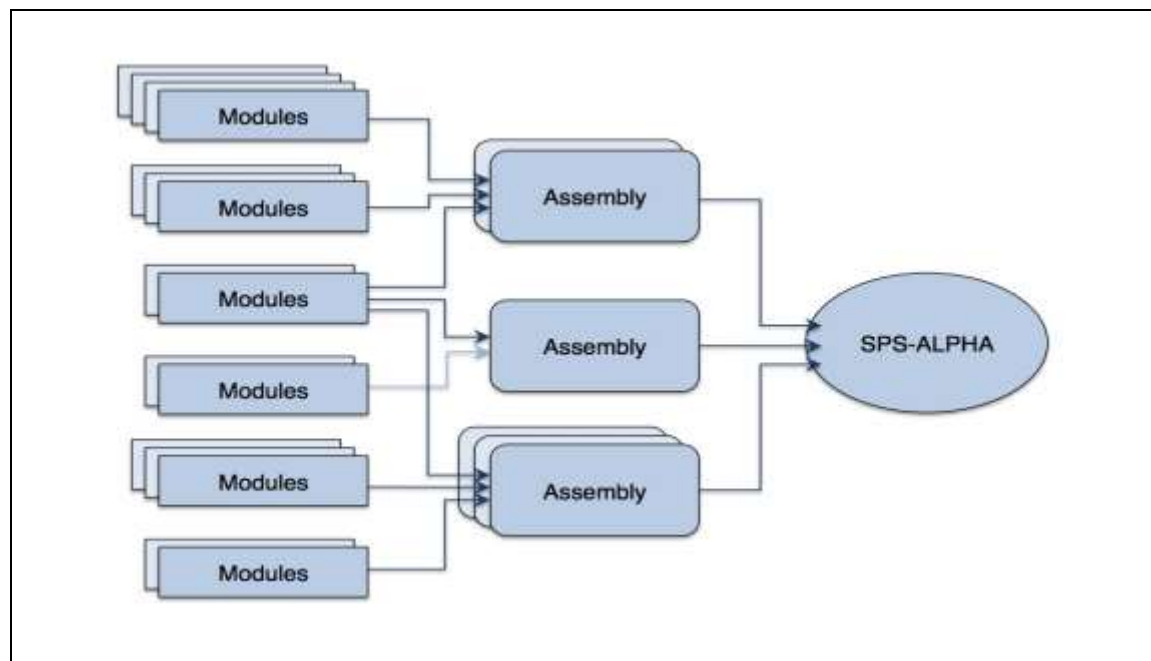

Figure 3-12 SPS-ALPHA Module-Assembly-System Architecture

Table 3-2 Crosswalk from Modular Elements to Key Assemblies

Modular Elements	Key Assemblies*					
	Primary Array Assembly	Solar Reflector Assembly	Primary Structure Assembly	Connecting Truss Assembly	Propulsion/Attitude Control Assembly	Modular HexBot Assembly
HexBus	X	X	X	X	X	X
Interconnect	X	X	X**	X	X	
HexFrame		X	X	X		
TFRP Module		X				
SPG Module	X				X	
WPT Module	X					
PAC Module					X	
MPPR Arms		X**			X**	X

** As noted, the Primary Power/Transmitter Array comprises multiple copies of the Primary Array Assembly, and is not listed separately
 * This Module / Assembly combination may / will require tailoring of the Module involved

3.5.1 Primary Array Assembly (PAA)

The Primary Power/Transmitter Array (PPTA) of the SPS-ALPHA (i.e., the disk at the base of the illustration in Figure 3-3) comprises many thousands of Primary Array Assembly (PAA) units. The PAA is

assembled from four of the modular elements: the HexBus, Interconnects, an SPG Module and a WPT Module. The PAA comprises the greatest number of modules as well as the majority of the mass (and cost) of the SPS-ALPHA concept. A conceptual illustration of the PAA is shown in Figure 3-12.

The image to the left is a diagram of the “stack” formed by a single HexBus, an SPG module, and a WPT Module; Interconnects are not shown. The image in the upper right is an illustration of how the HexBuses in the PAA would be linked by the Interconnects, and the image in the lower right is an illustration of how a number of assembled PAAs would appear on the backside of the PPTA, facing the Solar Reflector Assembly (SRA) described in the following section).

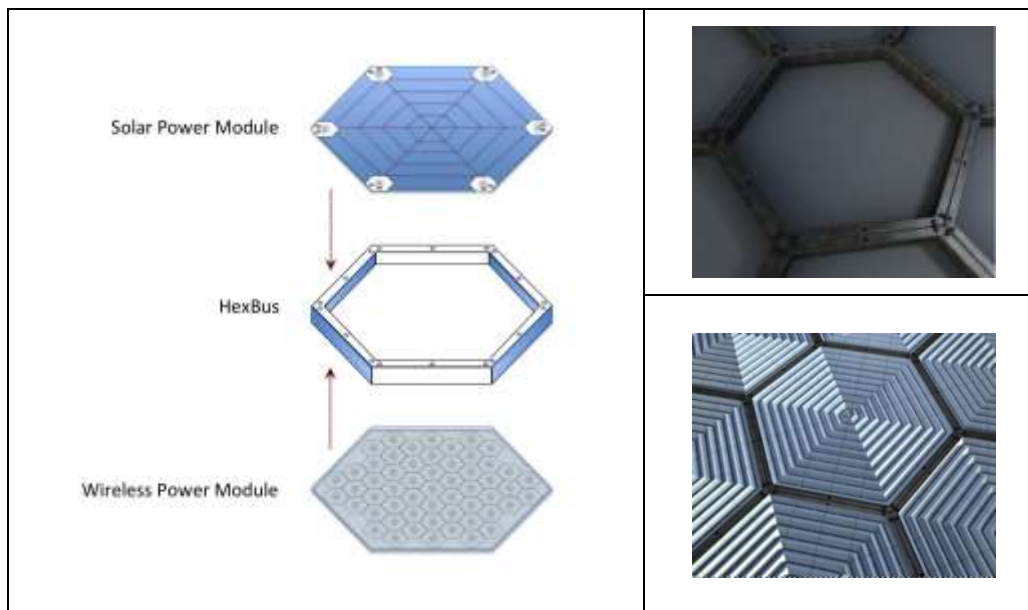

Figure 3-12 Illustrations of the SPS-ALPHA Primary Array Assembly (PAA)

There are several architectural options to still be examined for the PPA. The most important of these is the classic “Sandwich Module” approach in which all of the subsystems of the PPA shown in Figure 3-12 are fabricated as a single unit, rather than involving three functional modules.

3.5.2 Solar Reflector Assembly (SRA)

The SRA is assembled from five of the modular elements: HexBuses, Interconnects, HexFrames, TFRP modules, and MPPR Arms. A conceptual illustration of the SRA is shown in Figure 3-13. Note that the HexFrame structures shown around the edge of the reflector in the figure are part of the PSA, not part of the SRA.

Figure 3-17 illustrates how several hundreds of SRAs are joined together in the PSA. Detailed analysis is required to determine whether the assumption that a modified MPPR Arm can provide the required pointing for the SRA’s (in their role as Heliostats) is valid; if this is not the case, then a dedicated pointing system will be needed, and must be added to the list of fundamental modules for the SPS-ALPHA.

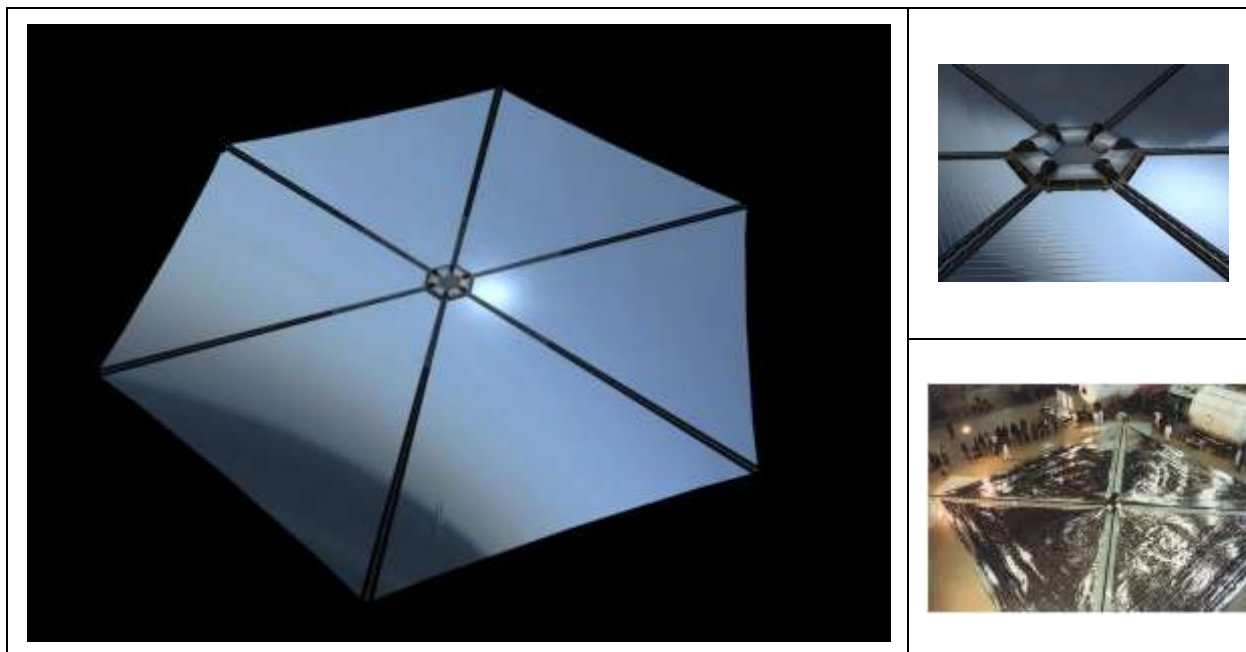

Figure 3-13 Illustrations of the SPS-ALPHA Solar Reflector Array
 (SPS ALPHA Illustrations are on the Left and Upper Right; Lower Right is a Photo (Credit DLR) of an Solar Sail Test Article)

3.5.3 Primary Structure Assembly (PSA)

The Primary Structure Assembly (PSA) is the unmoving scaffold on which the individually pointed SRA heliostats are mounted. The PSA is assembled from three of the modular elements: the HexBus, Interconnects and HexFrame Modules. There are a variety of different approaches that might be used to implement the PSA, with the selection of the “best” option depending upon both the scale of the platform and the mission to be accomplished. An illustration of some of the wide variety of PAA configurations is shown in Figure 3-14. The primary alternatives appear to include the following options:

- **A** Options: A half-ellipsoid shape facing toward the PPTA
 - Option A.1: a deep half-ellipsoid shape facing toward the PPTA
 - Option A.2: a shallow half-ellipsoid shape facing toward the PPTA
- **B** Options: A half-ellipsoid shape facing away from the PPTA
 - Option B.1: a deep half-ellipsoid shape facing away from the PPTA
 - Option B.2: a shallow half-ellipsoid shape facing away from the PPTA
- **C** Options: A sigmoid curve-based shape facing toward the PPTA
 - Option C.1: a sigmoid curve-based shape facing away from the PPTA
- **D** Options: A sigmoid curve-based shape facing away from the PPTA
 - Option D.1: a sigmoid curve-based shape facing away from the PPTA
 - Option D.2: a sigmoid curve-based shape facing away from the PPTA, with a secondary PPT structure positioned “above” the primary PPTA (forming a Cassegrain-type optical configuration)

Optimization of the specific PSA configurations will also depend upon the details of the market(s) to be served, including the total power to be delivered as a function of the time of day at any given receiving site. The sizing of the thin-film reflectors used to form the heliostats (minimum, maximum, etc.) will also influence system

optimization. Figure 3-15 presents computer renderings of SPS-ALPHA PSA configuration Options A.1 and D.1.⁷

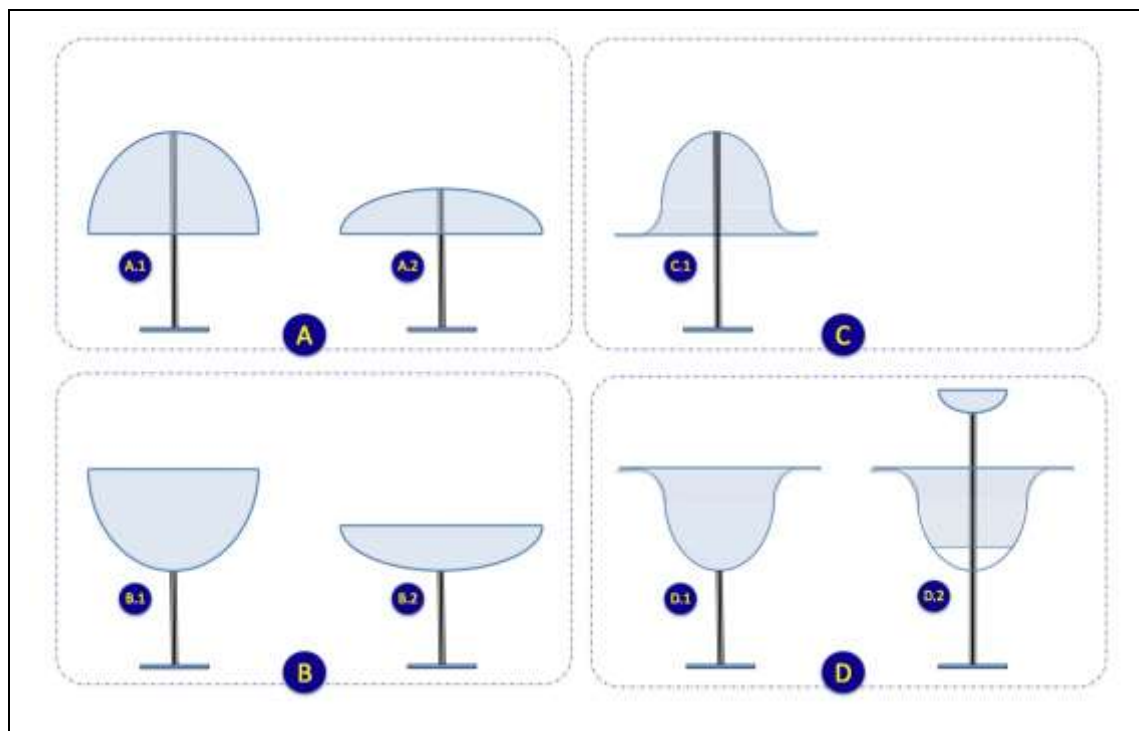

Figure 3-14 Some High-level SPS-ALPHA and the Primary Structure Assembly Options

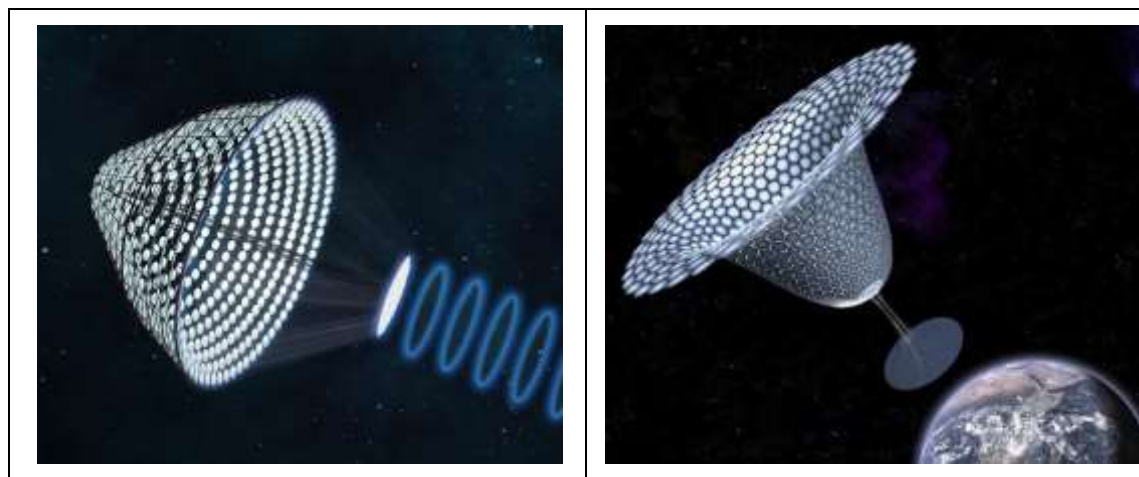

Figure 3-15 Computer Renderings of two SPS-ALPHA PSA Options (A.1 & D.1)

Figure 3-16 presents an illustration of an SRA. Installed within a single hexagonal “cell” of the overall SPS-ALPHA PSA. Figure 3-17 presents in turn a view of the several components of the PSA; beginning on the left with renderings of a single HexBus and a single HexFrame structure, in the middle with an sketch of a portion

⁷ The computer renderings above, as well as the numerous renderings of individual system modules, etc., in Section 3 of this report were done for this project by Mark Elwood of SpaceWorks Engineering, Inc..

of the PSA (at a scale such that the HexBus modules at the corners of each cell are “dots”, and finally on the far right with a close-up view of the PSA, with SRA installed (and lying in the plane of the structure.)

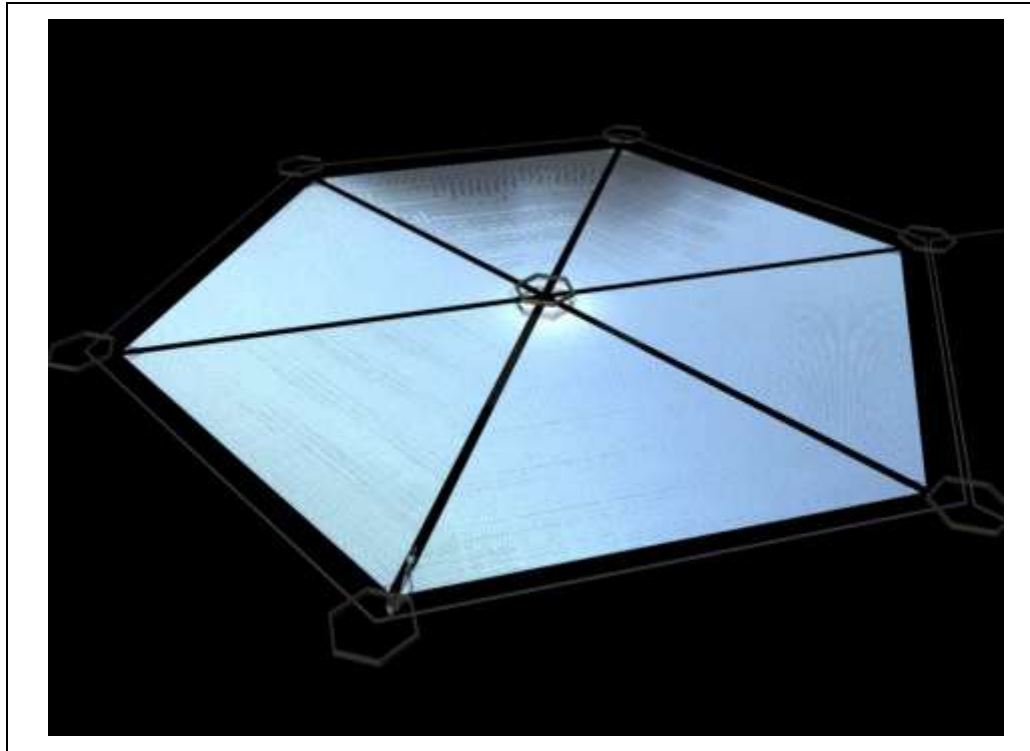

Figure 3-16 A single SPS-ALPHA SRA, Integrated into a single Hexagonal “Cell” of the PSA

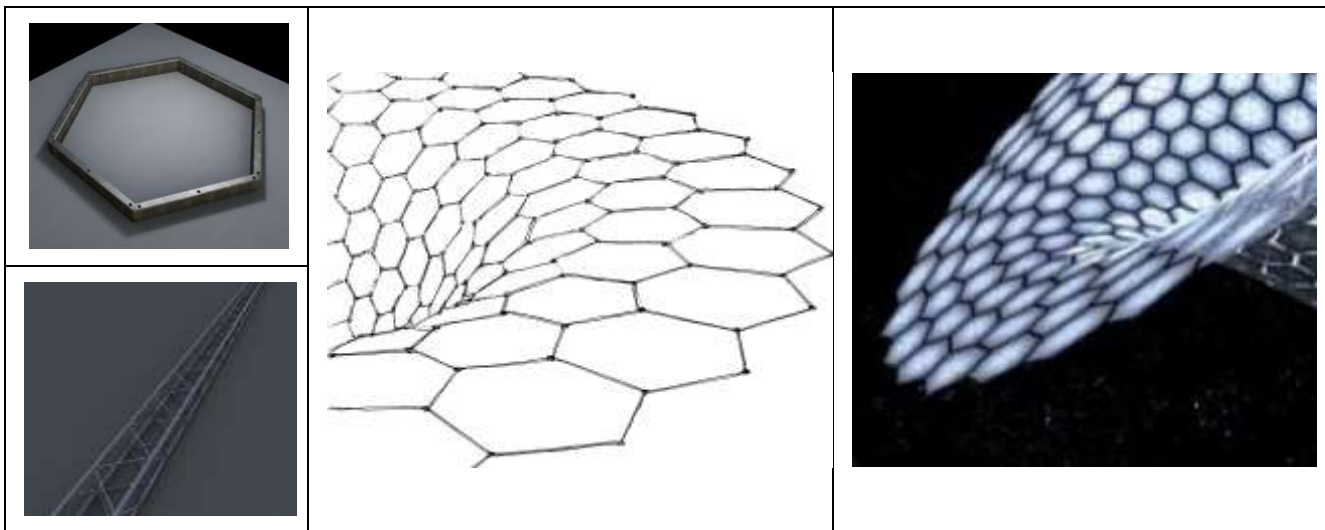

Figure 3-17 Composition / Sequence of the Primary Structure Assembly

3.5.4 Connecting Truss Assembly

The CTA is assembled from three of the modular elements: the HexBus, Interconnects and HexFrames. A conceptual illustration of the CTSA is shown in Figure 3-18. In the upper left images, a single HexBus module,

and a single HexFrame Structural Module are shown, In the lower left, a rendering of the overall CTA, see from a distance, is presented. On the right side of the figure, a detailed sketch of the CTA is presented, including a conceptual configuration for the HexBus modules and the HexFrame Structural Modules in the CTA.

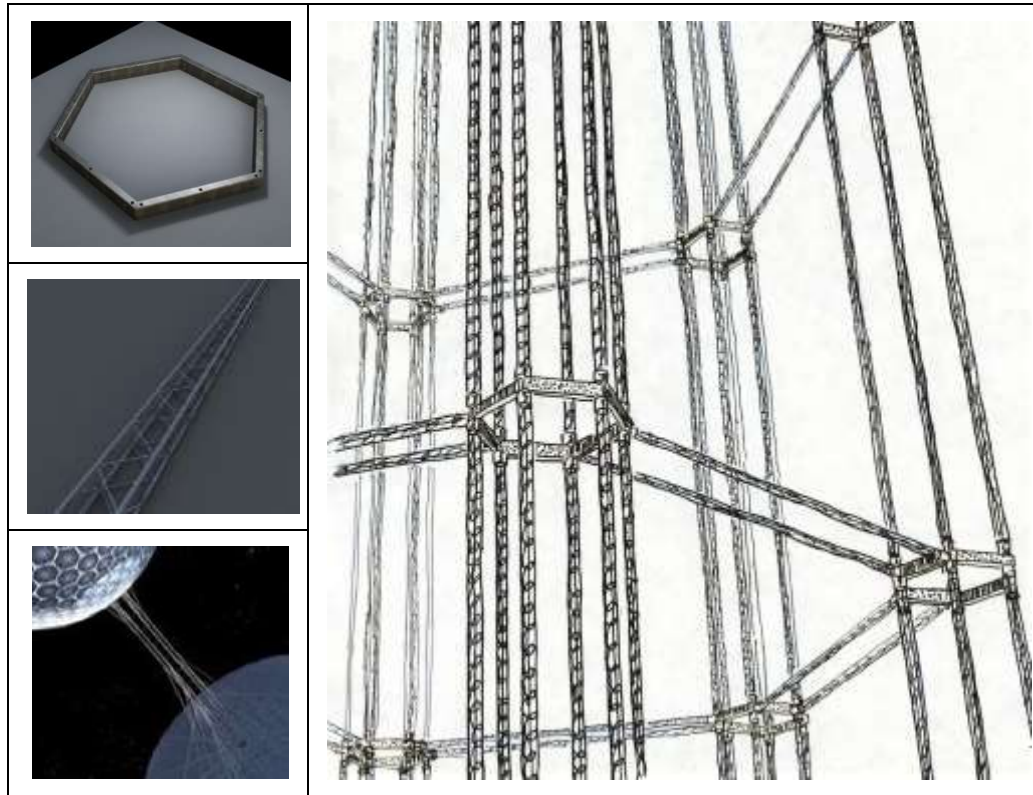

Figure 3-18 Illustrations of an Option for the Connecting Truss Assembly

Not surprisingly, the length, diameter and detailed interfaces of the CTA with the remainder of the SPS-ALPHA platform will depend upon the scale and configuration of the platform.

An additional topic for further study is that of the specific interfaces of the CTA with the Primary Array of the platform; options include: (1) direct integration with Hexbus units that comprise the Primary Array; (2) integration through a dedicated interface structure across the back surface of the Primary Array; and (3) a combination of either options 1 or 2 along with stabilizing tethers, connected at various points on the CTA and the back surface of the Primary array.

3.5.5 Propulsion / Attitude Control Assembly (PACA)

The PACA is assembled from five of the modular elements that comprise SPS-ALPHA: a HexBus, Interconnects, SPG Modules, a modified MPPR Arm, and a PAC Module. A conceptual illustration of the PACA is shown in Figure 3-19. As shown, all of the parts of the PACA would be designed as ORUs (orbital replacement units). As a baseline, the tankage system, along with thruster and MPPR interface would be replaced when the propellant in a given tank was exhausted. However, refueling in place would be an option for further study.

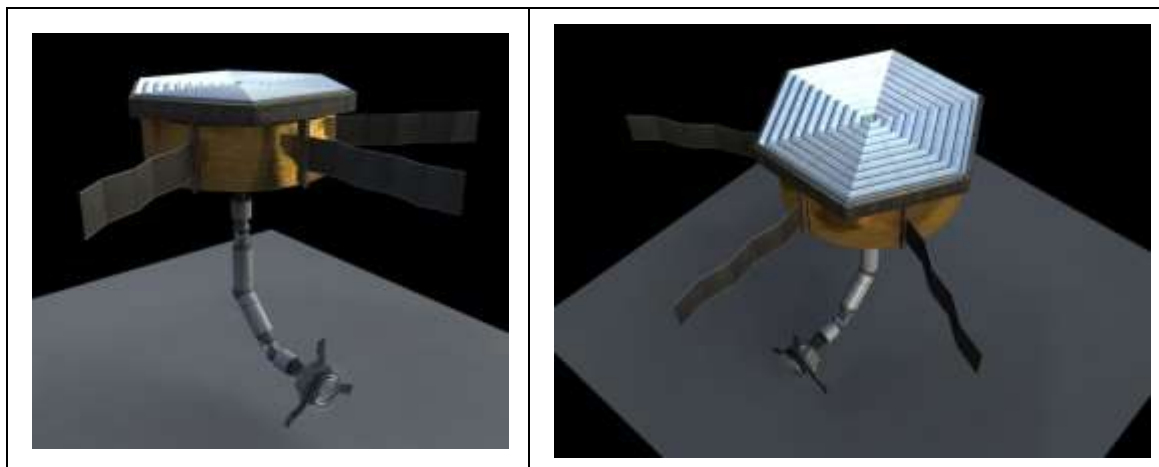

Figure 3-19 Illustrations of the SPS-ALPHA Propulsion / Attitude Control Assembly (PACA)

A rough estimate suggests that approximately 200 PACA's would be required for the full-sized commercially competitive SPS-ALPHA for terrestrial markets. These units would be attached around the edges of the Primary Array, the Solar Reflector Assembly, and potentially at key locations (such as the base of the SRA at the CTA). This preliminary sizing and placement requires additional study.

3.5.6 Modular HexBot Assembly (MHA)

The basic MHA is assembled from two of the SPS-ALPHA modular elements: a HexBus, and an MPPR Arm. Conceptual illustrations of the MHA are shown in Figure 3-20. The image on the left illustrates an MHA comprising one Hexbus Module and six integrated MPPR arms. The image on the right is of an MHA carrying a stack of Hexbuses. Operating in this mode, each MPPR arm would cooperate under the direction of the HexBus; all of the MPPR's interacting and cooperating through the use of the wireless router within the HexBus (noted previously).



Figure 3-20 Illustrations of the SPS-ALPHA Modular HexBot Assembly (MHA) Concept

There is significant heritage for this type of robotic system through various R&D projects and prototypes including those developed at NASA's Jet Propulsion Laboratory (up to and including the "ATHLETE" wheeled rover that has participated in various human exploration concept of operations testing (under the auspices of the program known as "Desert Rats"). For example, Figure 3-21, below, presents several generations of six-legged robots developed by NASA at the Jet Propulsion Laboratory (JPL).



Figure 3-21 Several Generations of Hexapod Robots from the mid-1990s (Credit: NASA/JPL)

3.6 Recommendations for Future Study

There are a number of technical areas that will require additional study in order to refine and better characterize the details of the SPS-ALPHA concept. These include the following:

- Formal and detailed ray-tracing analyses are needed to allow better understanding of the solar flux delivered to the SPG modules on the Primary Array as a function of the location of the satellite in its orbit, and the relative position of the sun at these points.
- Structural modeling (e.g., finite element modeling) is needed to determine CSI (controls-structures interactions) behavior and requires for the SPS-ALPHA for each of the several DRMs (defined in Section 5).
- Simulation of robotic assembly sequences and maintenance operations are needed – along with prototyping of systems – to finalize the design of the MPRR and MHA concepts.
- A formal concept of operations (CONOPS), spanning launch, assembly, operations and maintenance is needed for each DRM, including detailed scenarios and requirements for each module and assembly.

Future systems studies, design and modeling activities should be informed by the results of focused technology R&D, including regular prototyping and systems-level demonstrations. Additional recommendations are stated in each of the several sub-sections above.

THIS PAGE LEFT BLANK.

SECTION 4

SYSTEMS ANALYSIS METHODOLOGY

4.1 Systems Analysis Approach

The SPS-ALPHA Phase 1 NIAC project used a systems analysis approach described as “ACES” (Advanced Concepts Evaluation System (Mark-1)). ACES is a methodology for analysis, supported by a suite of Microsoft Excel-based analysis tools – some of which have been newly re-developed for the NIAC SPS-ALPHA Phase 1 Project. ACS requires the use of a modular, multi-workbook environment to perform quantitative analysis of alternatives (AoA) for various SPS-ALPHA system design choices, and to evaluate how technology choices and/or investment decisions impact their performance, mass and cost. In order to provide a consistent basis of existing and projected technology data for use in these evaluations, ACES incorporates the idea of a comprehensive “Future Technology Toolbox” (FTT) that can be updated regularly by supporting technologists. The ACES approach enables integrated Technology Readiness and Risk Assessments (TRRAs) across and among systems options and “technology clusters”. (See Section 8 for further information).

ACES depended upon the construction of an SPS design reference mission (DRM) through selection of modeled system elements from various architecture segments within the SPS-ALPHA platform. In addition, very high-level “models” were defined of key supporting infrastructures such as Earth to orbit (ETO) transportation, in-space transport, etc. See Figures 4-1.1, 4-1.2, and 4-1.3 for a graphical overview of the ACES systems analysis approach.

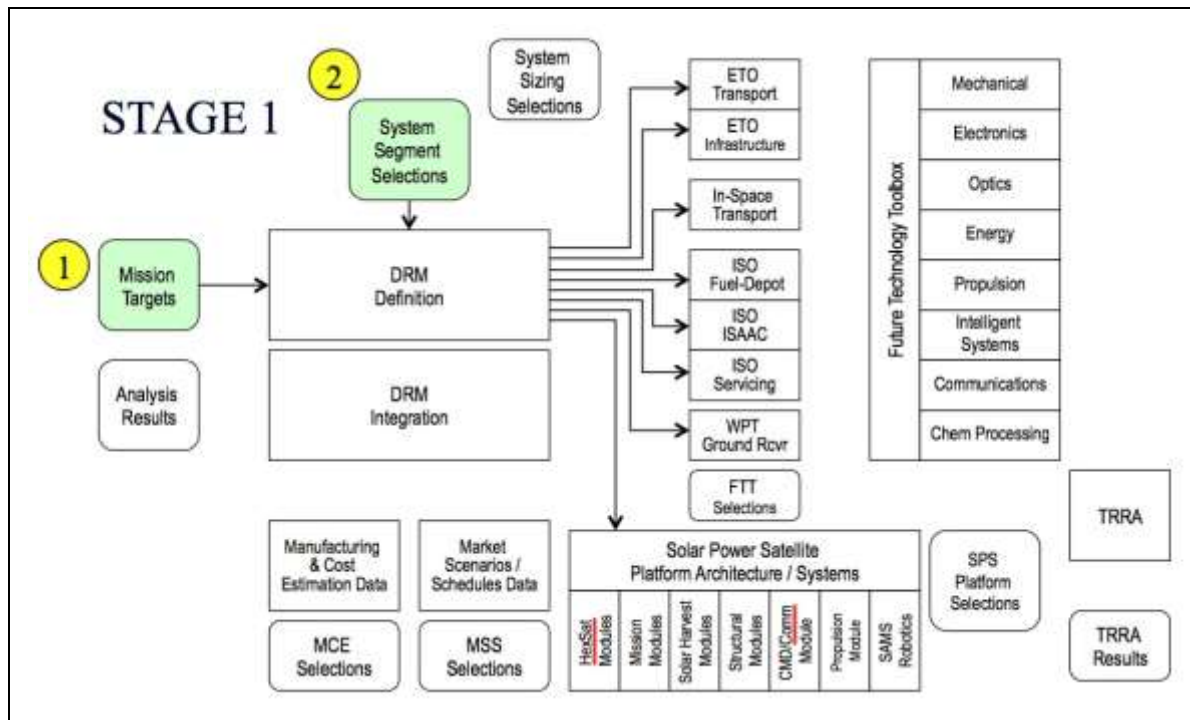

Figure 4-1.1 SPS-ALPHA Phase 1 Systems Analysis Stage 1

The methodology also depends upon the construction of integrated DRM timelines including key missions//markets, within which life cycle costs and economics can be evaluated. Although ACES was formulated specifically to accommodate SPS-ALPHA analyses, with additional appropriate system models, similar AOAs could be conducted for a wide range of other advanced concepts for various space missions and markets. As illustrated in Figure 4-1.1, Stage 1 of the ACES methodology includes two steps:

- Step 1: Select SPS Mission Targets (e.g., GEO-based SPS to deliver Energy to Markets on Earth, etc.); these selections were made as part of the market definition study; and
- Step 2: Select System Segments to be used in the Case Study (e.g., what type of ETO, In-Space Transportation, etc.); these selections were made in the Space Segment Model (SSM), described below.

Stage 2 of the ACES methodology includes three additional steps:

- Step 3: Select System Sizing Option (e.g., ETO Transportation Payload Sizes, In-Space Transportation Payload Sizes, etc.); these selections were made in the individual supporting infrastructure “models”;
- Step 4: Select Sizing Options for the SPS-ALPHA Platform (e.g., Diameter of Main Array, size of HexSat Modules in Main Array, etc.); these selections were made in the SSM; and,
- Step 5: Selection of Technologies from FTT for use in System Modules (e.g., choice of PV for use in SPG, choice of timeframe for Initial Use of Technology, etc.); these selections were made in the SSM.

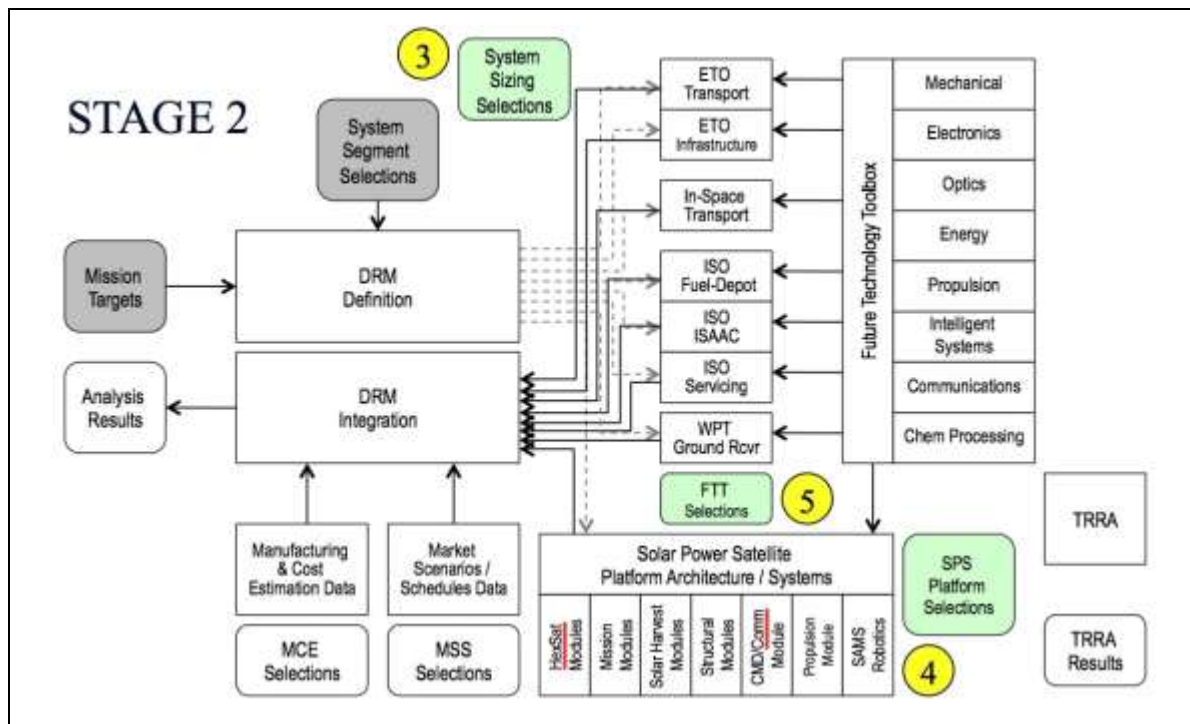

Figure 4-1.2 SPS-ALPHA Phase 1 Systems Analysis Stage 2

Stage 3 comprises five additional steps:

- Step 6A: Select an Alternative Market Scenario and associated schedules; these choices were made in the macroeconomics modeling spreadsheet;
- Step 6B: Select a Manufacturing Scenario and associated schedules (based on schedule choice in 6A); this choice is made in the macroeconomics modeling workbook;
- Step 7: Given the above selections / linkages, “RUN” DRM Integration;
- Step 8: Develop the Integrated Technology Readiness and Risk Assessment (TRRA), and review results produced (given technology selections and schedule choices); and
- Step 9: Review the Various Parametric Results produced based on running DRM Integration, and the System Segments in the context of the Schedule, Manufacturing and Market Scenarios.

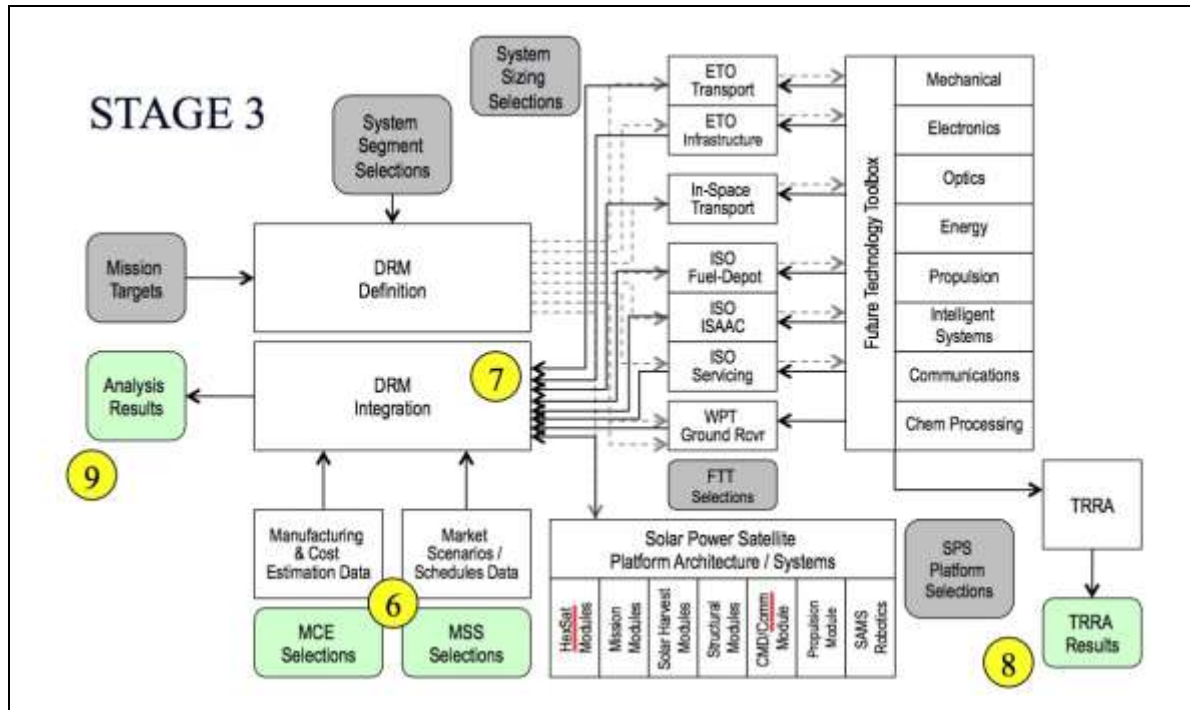

Figure 4.1-3 SPS-ALPHA Phase 1 Systems Analysis Stage 3

In addition to the above stages/steps, a final pseudo “Stage D” comprises:

- Iteration of the above to accomplish the required Analysis of Alternatives (AoA) as needed.

4.2 NIAC Phase 1 Project Systems Analysis Tools

Although the ACES methodology was used in this Phase 1 NIAC project, the brevity of the schedule and the limitations of available resources necessitated the use of a combination of existing and new software tools to perform the required systems analysis studies. An existing spreadsheet-based software tool — the SSM (Space Segment Model) developed under NASA’s SSP Fresh Look Study in 1995-1997) — was reviewed and updated to incorporate the SPS-ALPHA concept.⁸ The updated SSM is a physics-based modeling tool that incorporates automated re-sizing of various systems design features to satisfy high-level architecture and systems requirements given specific technology parameters. (The input high-level figures of merit (FOMs), as well as selected output FOMs are described in Section 5, which follows.)

In addition to the refreshed SSM tool, a new macroeconomic model (also spreadsheet based) was developed for the project. This tool performs cost estimation and incorporates quantified external market considerations (e.g., energy prices, policy incentives, etc.) to enable analyses of the overall economic performance for the several SPS-ALPHA DRMs. Finally stand-alone spreadsheet tools were developed to model non-platform systems (e.g., robotics, space transportation, etc.) to allow sizing (e.g., numbers of vehicles, launches, robotic systems, etc.) driven by the results of SSM modeling.

4.3 Cost Estimation and Macroeconomics

⁸ Dr. Harvey Feingold, formerly of SAIC and the developer of the SSM for the 1990s NASA SSP Fresh Look Study, was the lead for this activity within this NIAC Phase I project.

One of the principal objectives of the SPS-ALPHA NIAC Phase 1 project was to “conduct an initial evaluation of the economic viability of the concept (as a function of key performance parameters).” The project’s economic analysis comprised several aspects (as illustrated above), including development of an integrated market model (described in detail in Section 5, which follows), and identification of prospective space mission applications (described in Section 6).

A crucial aspect of the evaluation of economic viability is appropriate and consistent estimation of the cost of the system under consideration. The heart of the SPS-ALPHA concept is the idea that a hyper-modular architecture will result in dramatic reductions in the cost per kilogram for platform systems through mass production. As noted in Section 3, SPS-ALPHA de-constructs into a number of “Assemblies”, which in turn are composed of a number of “Modules”. This architecture is reflected in the cost estimation approach that has been used in the current study. As a result of the systems analysis effort, individual modules have been sized by mass, and cost estimates developed for each module.

At the level of analysis possible given the scope of the NIAC Phase 1 project and the level of maturity of the concept, cost estimates for each module have been based on a simple mass-based cost estimation relationship (CER). The CER for each module is defined based on the type of module (referenced to historical spacecraft cost data) and adjusted down with increasing module production.⁹ This effect is typically characterized as a “learning curve” (LC) or “manufacturing curve” (MC) for the involved hardware.[15] The LC/MC is based on the historical observation that given a specific physical system, the number of units manufactured is related to the CER (i.e., cost per kilogram) of the units produced by three parameters: (1) the initial CER for the first unit developed and fabricated, (2) the expected cost of the second (identical to the first) unit produced, and (3) a projected percentage change in the CER for every doubling of the number of units produced. For example, if an initial unit as a CER of \$100,000 per kilogram, with a fabrication cost of the second identical unit of \$50,000 per kilogram, and the LC/MC is 50%, then the CER for the eighth (8th) unit manufactured will be \$12,500 per kilogram.

For this project, the initial CER is set for each module (see Section 6) based on the type of module, and the reduction in cost for the second unit is assumed to be 50%. The LC/MC is set by assumption, with reference to relevant historical aerospace systems cases. Clearly, the cost estimation assumptions used are essential drivers of the results of any evaluation of economic performance.

A key question is: how sensitive are those results to these assumptions?

Figure 4-4 illustrates the effects of the LC/MC for several different values, beginning with an initial CER of \$250,000 per kilogram and a cost reduction for the second unit of 50%. Figure 4-5 provides a close-up view of a portion of Figure 4-4, focusing on the portion of the overall curves below a CER of 10,000 per kilogram. The chart highlights the approximate threshold for SPS-ALPHA economic feasibility at about \$500/kg for system manufacturing cost. As shown, an LC/MC at 50% falls below the threshold at approximately 260 units manufactured; an LC/MC at 60% falls below the threshold at approximately 2000 units, etc.

⁹ The first observation of this phenomena is attributed to aeronautical engineer Thomas P. Wright whose 1936 paper presented data suggesting that the average direct labor hours required to manufacture a given model of Boeing aircraft dropped systematically with each unit produced. Wright described this phenomenon with an equation that represented what he called a “progress curve.” In Wright’s 1936 paper, he observed a “progress ratio” of 80% for the highly labor-intensive Boeing aircraft fabrication process of the 1930s.

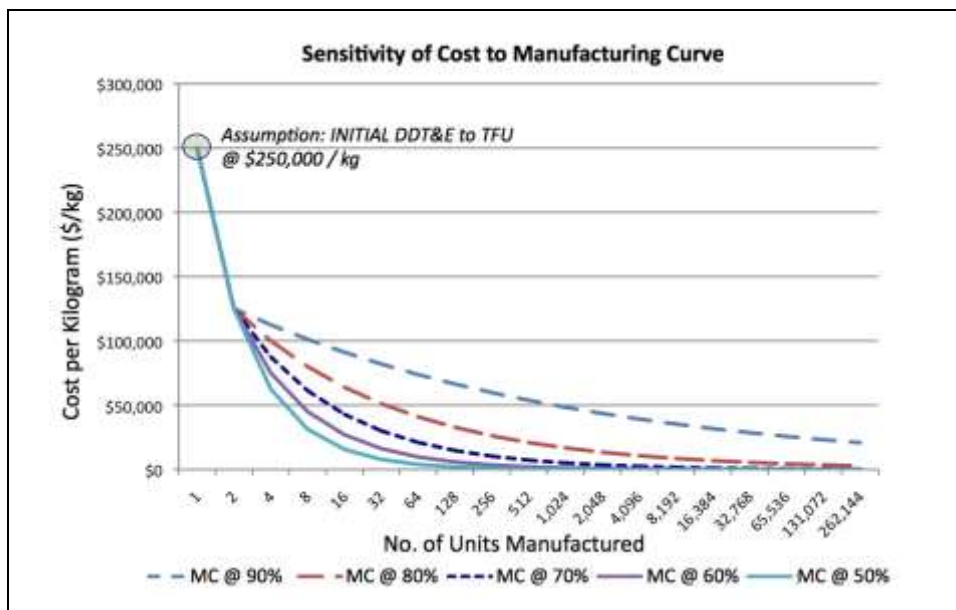

Figure 4-4 Analytical Examples of the Learning/Manufacturing Curve

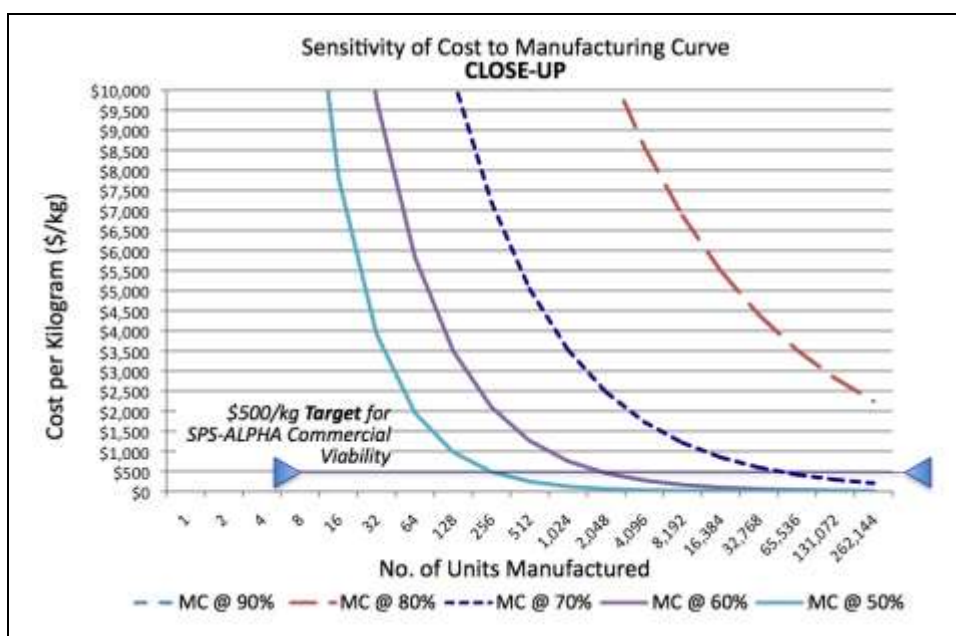

Figure 4-4 Close-Up View of a Portion of Figure 4-3

Since production runs for large solar power satellites (described for example in Paragraph 7.3.5) involve from many 1000s to millions of modules, extremely low costs should be realizable relatively quickly so long as the LC/MC is 70% or lower. Even with an LC/MC of 80%, very low costs may be achieved for production runs involving multiple SPS. The LC/MC used in the analysis (and the justification for this assumption) are described in Section 7.

SECTION 5

SPS-ALPHA MARKET FORECAST

5.1 Overview

The SPS-ALPHA architecture has the potential not only to make possible the vision of continuously delivering almost limitless solar energy to markets on Earth, but also to transform a range of future space mission applications. The following section discusses the results of the market assessment of the prospective business case for the SPS-ALPHA system, focusing on terrestrial energy markets. Potential space markets and mission applications are discussed in Section 6. This market assessment found that there are both primary markets and several key secondary markets that could support the future development and deployment of SPS-ALPHA.

The following discussion summarizes those market opportunities, including both the Primary Markets and several likely Secondary Markets. For each of these prospective market types, several specific market prospects are described, including (a) market characteristics (current), (b) market prices (current), and (c) a market forecast for the remainder of this century (characteristics and prices). The section concludes with an integrated forecast of SPS-ALPHA markets that will in turn be used in integrated systems analysis modeling.

5.2 Primary Markets

The primary markets for SPS-ALPHA are within the global commercial energy marketplace, including (1) baseload power sales, (2) premium niche power market sales, and (3) sales of power to enable local production of selected high-value chemical products (including fuels, fertilizers, and interim chemical feed-stocks (e.g., syngas). In addition, during the past 10-15 years a series of major global policy-driven markets have emerged due to concerns regarding greenhouse gas emissions and the risk of anthropogenic climate change. These sustainable energy technology markets represent potentially major new opportunities for SPS-ALPHA.

5.2.1 Commercial Baseload Power [16]

The Commercial Baseload Power (CBP) market is enormous, and growing; it is a fully global market that comprises all countries around the world, and a diverse array of market types, ranging from fully deregulated commercial markets (as in the US) to fully regulated and/or government owned national energy company markets.

Market Characteristics – Commercial Baseload Power. For conventional baseload power sources, power is usually acquired from large power plants (including primarily coal, hydroelectric or national gas turbine based plants) that typically deliver from 100 MW-1,000 MW of power. During 2008, global use of energy from baseload electrical power generation was approximately 2,000,000 GW-hours; while total energy use (including combustion of fuels for transportation, heating, power generation, etc., was many times greater, reaching approximately 13,000 Million TOE (tons of oil equivalent, or about 151,190,000 GW-hours).

But, however great the consumption of energy by the global economy, it remains only a tiny fraction of the energy that could be available. The global production of electricity in 2008 (20,261 TW-hrs) represented only 11% of the solar energy Earth's surface receives in one hour (174,000TWh).[17] In 2008, the sources of electricity were fossil fuels 67%, renewable energy 18%, and nuclear power 13%; see Table 5-1. The majority of fossil fuel combustion for electricity was of coal and gas, while oil (much more expensive) was only 5.5%, and used largely in special niche and/or isolated markets – such as the US State of Hawaii. Hydroelectric power represented 92% of renewable energy, followed by wind at 6% and geothermal at 1.8%, Solar photovoltaic was 0.06%, and solar thermal was 0.004%.

Table 5-1 Example Sources of Global Electricity (c. 2008)

Energy Sources of Global Electricity							
Energy Source	Coal	Oil	Natural Gas	Nuclear	Hydro	Other	Total
Electricity (TWh/yr)	8,263	1,111	4,301	2,731	3,288	568	20,261
Fraction	41%	5%	21%	13%	16%	3%	100%

The use of energy per capita varies widely from country to country, as well as from region to region, as does the efficiency with which energy is used to produce goods and services (i.e., the “energy per unit of Gross Domestic Product (GDP)” varies significantly). However, during the past 40 years, the consumption of electrical power per capital has risen steadily, while the global population has also increased – resulting in accelerating growth in the use of electrical power that is projected to continue for the remainder of this century.

Market Prices – Commercial Baseload Power. The wholesale and retail prices for commercial baseload power (CPP) generated by traditional power plants can vary widely depending on the location, access to specific resources (for example, water in a lake for a hydropower plant), and other market factors. Depending on the technology involved, a typical cost range in many markets (including most of the US) would be from 5¢ to 10¢ per kWh; however in special niche markets (discussed below) the cost of baseload power can be considerably greater, reaching 10¢ to 20¢ per kWh or more. (See the discussion below concerning the allowable wholesale energy price during the introduction of a novel renewable energy technology.)

Market Forecast – CBP. During the remainder of this century the use of CBP is forecast to grow dramatically in all regions of the globe, with the exception of the developed, or “OECD” countries, such as the US, Japan, France, and others.¹⁰ In the latter area, use of electrical power is forecast to increase, but much more slowly, due to ongoing improvements in the efficiency of energy use per unit GDP. Table 5-2 presents an integrated view of various electricity related forecasts developed for a recent study conducted by the International Academy of Astronautics (IAA), including projections of global population growth (including three alternative scenarios) through the year 2100, and annual global energy use through 2100.

The key aspect of this forecast is that the global demand for electricity is projected to approximately quadruple from 2010 to 2100. Hence, there is a vast potential market for space solar power if the prices for SSP are competitive with terrestrial sources in relevant markets.

Table 5-2 Forecasts of Future Population and Energy Factors¹¹

		2010	2030-40	2060-70	2090-2100
Global Population	High	~ 6.9 billion	~ 9 billion	~ 11.5+ billion	~ 12.5+ billion
	Medium	~ 6.9 billion	~ 8.5 billion	~ 9+ billion	~ 8.5+ billion
	Low	~ 6.9 billion	~ 7.5 billion	~ 7+ billion	~ 5.5+ billion
Projected Annual Energy Consumption ¹²		~ 120,000 Billion kWh	~220,000 Billion kWh	~ 400,000 Billion kWh	~ 480,000 Billion kWh

¹⁰ “OECD” stands for the “Organization for Economic Co-operation and Development” an international economic organization comprising 34 developed countries that was founded in 1961 for the purpose of stimulating economic progress and world trade, and democratic government. For additional information, including a list of the member countries, see: http://en.wikipedia.org/wiki/Organisation_for_Economic_Co-operation_and_Development

¹¹ Sources include the International Energy Agency (IEA) 2010 Forecast, the U.S. Department of Energy, Energy Information Agency Report of 2011, and others; these are noted in Ref_16 in Appendix B.

¹² The energy consumption projections shown are rough estimates only; they were developed for use by the IAA; they reflect a range of estimates from various organizations, and considerable uncertainties – including various projections of “high, medium and low” economic growth scenarios, variations in the economic efficiency of the energy (i.e., kW-hours per unit of Gross Domestic Product (GDP), etc.).

5.2.2 Commercial Intermediate & Peaking Power

Commercial Intermediate & Peaking Power (CIPP) is a global market that matches closely the commercial baseload power market, comprising the same countries, and array of market types, ranging from fully deregulated commercial markets (as in the US) to fully regulated and/or national energy company markets.

Market Characteristics – Commercial Intermediate Power & Peak Power. Unlike the market for baseload power, the demand for commercial intermediate power and peak power varies on an hourly basis during each day (as well as incorporating day to day variations, based on the weather, and longer term variations based on the season of the year). Figure 5-1 presents a typical urban market diurnal (day-night) cycle for CIPP demand on an hourly basis. (This figure does not reflect a specific locality, but follows the general demand curve that might be expected in the middle state of the US in summer.) The figure illustrates (a) the baseload power level below which demand does not drop during a 24-hour period, and (b) the variable load power level, which is shown to peak in the later part of the afternoon during a typical summer day.

As shown in Figure 5-1, the peak power demand occurs during a relatively small fraction of each day, and can be difficult to anticipate in detail more than 5-10 days in advance (corresponding to the timeframe for accurate weather forecasting). Intermediate Power demand occurs during a longer period of time than Peak Power, and typically during daylight power when commercial power use increases (particularly for air conditioning during the summer months)

Market Prices – Commercial Intermediate Power & Peak Power. The wholesale and retail prices for commercial intermediate power and peak power (CIPP) generated from whatever source can vary widely depending on the location, immediate access to power generating capacity, seasonal considerations and other market factors. In North America, peak power costs have been estimated to be as high as \$1.00 - \$1.30 per kWh for a period of as much as six hours.[18]

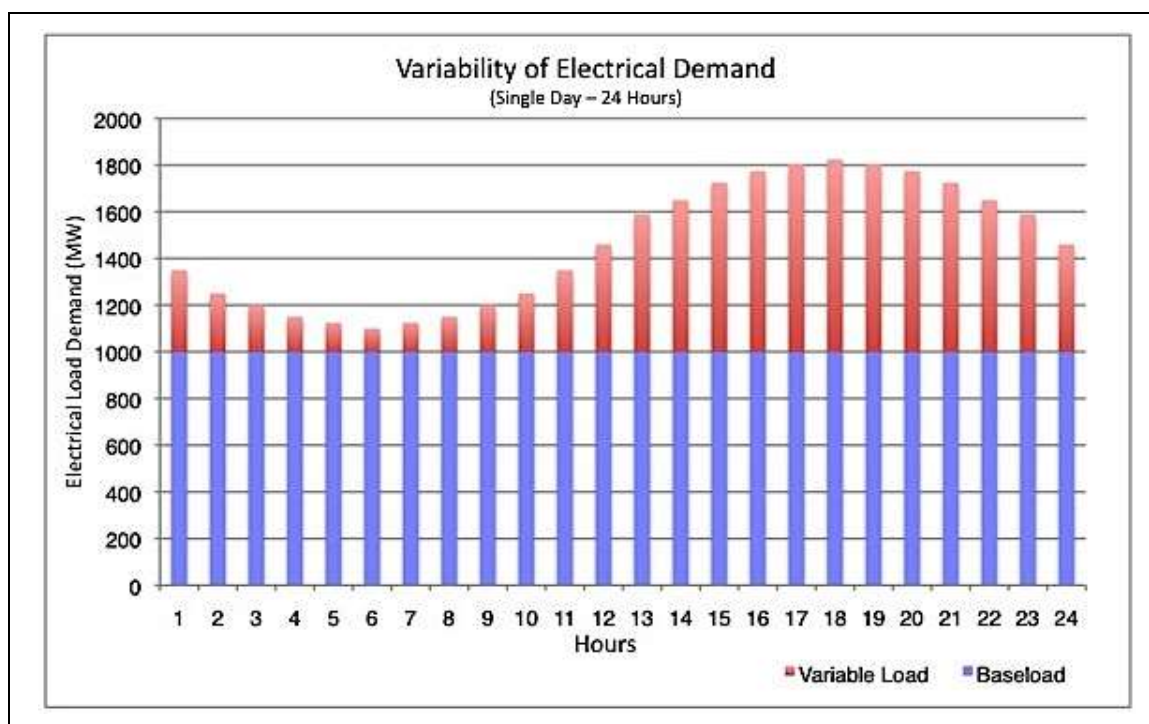

Figure 5-1 Typical Variation in Diurnal DIPP Demand

Market Forecast – CIPP. On an individual market basis, the forecast demand CIPP may be forecast to scale (albeit locally) with increasing CBP demand, and to fall globally with the scope of total energy utilization.

5.2.3 Sustainable Energy Sources

Based on numerous “green energy” technology cases during the past 20 years, the Sustainable Energy Sources (SES) market sector for SPS-ALPHA anticipates several policy-driven key government investments or other supports (e.g., tax breaks) to encourage the development, deployment and commercialization of new, low-carbon energy systems.¹³

Market Characteristics – Sustainable Energy Sources (SES). Traditional sustainable energy projects have been characterized (with the exception of hydroelectric power) by the intermittent character of the energy source (e.g., solar or wind), and the requirement for both grid upgrades (e.g., to so-called “smart grids”), and limits on the percentage of renewable energy allowed in the power mix.

A key feature during the past 20 years for numerous international sustainable energy projects has been the use of a market incentive known as the “feed-in tariff” (FIT).^[19, 20] Feed-In Tariffs (FIT) have been associated with the recent large growth in solar power in Spain and Germany, and in wind power for Denmark.

Market Prices – SES. Market Incentives for the Introduction of a New “Sustainable” Energy Technology: In general, government policy-driven market incentives for the introduction of new sustainable energy sources involve (a) guaranteed access to markets; (b) above conventional source prices (e.g., up to 50¢/kWh) and (c) long-term contracts (e.g., for up to 10, 15 or 20 years). The total targeted percentage contribution to the energy mix from sustainable energy sources may be as great 20% or more.^[21]

Market Forecast – SES. For purposes of this NIAC study, sustainable energy sources (SES) are forecast to continue as a stable and growing portion of the total global energy mix, with continuing policy incentives in various regions and countries similar to those that have been in place in specific locations during the past 10-15 years.

5.3 Secondary Markets: Energy

In addition to the primary market sector (i.e., global commercial energy, discussed above), there are several secondary energy markets that SPS-ALPHA may also serve; chief among these are (1) premium niche power commercial markets; (2) national security power markets; and, (3) markets for power to be used to drive production of high-value chemical products.

5.3.1 Commercial Premium Niche Power Markets

Commercial Premium Niche Power (C-PNP) markets are entirely dependent on the specifics of the location and situation; however, they can occur in a wide variety of locations around the globe. The wholesale and retail prices for PNP power generated from whatever source can vary widely depending on the location, local power generating capacity, seasonal considerations and other market factors. Examples include power for geographically remote locations and islands, as well as power during emergency situations. In North America, in the northern portions of Canada, for example, energy costs have been estimated to be as high as 50¢ per kWh due to the requirement to generate power using expensive imported diesel fuel and generators.^[22] In such cases, the power is typically required for a modest-size community (e.g., about 1,000 inhabitants), with a total power requirement of up to approximately 10-20 MW. It is projected that such C-PNPs will continue to exist, and perhaps increase in number and in size during the remainder of the coming century.

¹³ Another type of government financial support for sustainable energy projects in recent years has been the “loan guarantee”, in which funds borrowed commercially by a for-profit firm for purposes of expansion of plant and equipment, etc., is guaranteed by the government – hence allowing the company to obtain a much lower interest rate than would be otherwise possible. This type of financial support is explicitly not assumed for the SPS-ALPHA market case due to the numerous issues that have arisen around this mechanism during 2011.

5.3.2 National Security Premium Niche Power Markets

National Security Premium Niche Power (NS-PNP) markets were first identified during the 2007 study of space solar power for defense applications that was conducted for the US National Security Space Office (NSSO).^[23] NS-PNP markets may emerge due to military operations, or because of a requirement for short-term emergency operations (e.g., to support relief operations in the aftermath of a major national disaster, such as an earthquake, a tsunami, etc.). These markets may be difficult to predict with precision, and the duration of power demand will typically be of finite duration (from a few months to a year as a minimum, or up to 3-10 years as a maximum).

NS-PNP demand has been identified as typically ranging from 1 MW to 10 MW at various forward operating bases at remote, typically hostile or otherwise difficult environments. Prices paid for energy to meet the needs of NS-PNP markets can range as high as \$2.00 to \$3.00 per kilowatt-hour.

During the remainder of this century, it is anticipated that NS-PNP markets will continue to emerge, require power for some period of time (e.g., up to 2-10 years) and then vanish as the focus of operations moves from location to location.

5.3.3 Policy-Driven Market Premiums and/or Incentives

During the past 20 years, the increasing international scientific consensus that greenhouse gas emissions are resulting in global climate change has been compounded by increasing concerns regarding energy security in the context of surging demand for energy in the developing world (discussed previously). As a key part of the SPS-ALPHA market model, it is assumed – just as has been the case for other new sustainable energy technologies during the past 20 years – that Feed-In Tariff (FIT) financial incentives will be available to support the initial introduction of SPS-ALPHA power, particular for the Commercial Baseload Market. In particular, the projection for the SPS-ALPHA market assessment is modeled on the German government's 2000-2010 FIT for solar power, which included three stages: (1) Years 0-8 FIT @ ~ 40¢-50¢ per kWh; (2) Years 9-13; FIT @ ~ 20¢-25¢ per kWh; and, (3) Years 14-20 FIT @ ~ 15¢-20¢ per kWh. Beyond 20 years, the expectation is that the new sustainable energy technology would complete commercially.

5.3.4 Energy for Production of High-Value Chemical Products

In future, one such high-value chemical product (HVCP) may increasingly be fuels (e.g., synthetic petroleum), as well as fertilizers. The use of space solar power to drive such thermal-chemical processing could prove to be a highly valuable undertaking, particularly while the price of feedstocks such as natural gas remains low and the price of liquid fuels, such as gasoline or aviation fuel, remains high. This is a good topic for future study, but a detailed consideration of this opportunity is beyond the scope of the current study.

5.4 Secondary Markets: Space Mission Applications

Another major set of secondary markets for SPS-ALPHA is that of space mission applications (SMA). These are discussed in some detail, with examples in Section 6 of this report.

5.5 Secondary Markets: Government Sponsored R&D

A final set of secondary markets for SPS-ALPHA is that of Government Sponsored R&D (GS-R&D). These markets are of particular interest and importance for the nearer term (e.g., the coming ten years). For purposes of the NIAC Phase 1 SPS-ALPHA project, the following GS-R&D will be considered as candidate secondary markets: (1) Advanced Concepts and Technology Research; (2) Technology Maturation and Demonstrations; and, (3) System Demonstrations & Prototypes.

5.5.1 Advanced Concepts and Technology Research (ACTR)

During the past 10-20 years, there have been a number of space systems and missions oriented advanced concepts studies and related, low-TRL technology research sponsored by various government agencies, including

in the US DARPA, NASA, the USAF, the NSF and other organizations. Internationally, the European Space Agency (ESA), the Japanese Aerospace Exploration Agency (JAXA), and other organizations have also sponsored such activities. These ACTR activities typically have durations of 1-2 years, and range in scale from about \$100K (e.g., this NIAC Phase 1 project), up to roughly \$1M. It is expected that this type of low-TRL studies and research programs will continue during the coming years and that these will represent prospective sources of funding for an integrated SPS-ALPHA program.

5.5.2 Technology Maturation and Demonstration (TMD)

In addition to ACTR activities, the same agencies also sponsor technology maturation and demonstration projects, typically resulting in validation of new technologies and systems at a mid level of technology readiness. These TMD activities vary widely in duration and scale, but are projected for purposes of this market assessment as being on the order of \$1M to \$5M, with durations on the order of 1-3 years. It is projected that such TMD projects will continue during the coming years and that these also will represent prospective sources of funding.

A different, but related programmatic approach to space systems and technology maturation activities is that of providing access to space infrastructures that enable new, high-risk capabilities to be validated. This type of support includes use of the International Space Station (ISS) for research and development, as well as occasional space launch support services, such as those provided under the USAF Space Test Program (STP). It is projected that this type of support will also continue during the coming years and represent a prospective source of support.

5.2.3 System Demonstrations & Prototypes (SDP)

From time to time, both government agencies and commercial ventures support the implementation of focused systems demonstrations and/or prototyping. Such projects may or may not be part of large demonstration programs, but they are typically selected through a strategic program planning process rather than through a competitive acquisition process. Various examples of this type of project can be identified from the past 10-20 years, including Deep Space One, a part of the NASA New Millennium program in the 1990s, Experimental Test Satellite VIII, a part of the JAXA ETS program in the 1990s-2000s, and others. This type of demonstration project will typically (but not always) involve a prospective government mission application, but the systems and technologies involved may also have considerable commercial value. SDP projects related to space typically have durations of 3-5 years and a scope of from \$100 M up to \$1B (and very rarely more).

This type of demonstration is also well known in the renewable energy sector. For example, in the case of a single program/technology, the US DOE Solar Energy Technology Program (SETP), this is approximately \$100M per year. Other OECD countries make similar investments; such that the total global annual investment in advanced technology R&D for ground-based solar, wind, biomass, etc., is approximately \$300M - \$500M per year. Further, these R&D programs are assumed to include selected demonstration projects. In one case, the solar-thermal concentrator-based *Nevada Solar One* project, located in Boulder City, Nevada with a 64 MW generating capacity was built by a US government-industry partnership comprising the U.S. Department of Energy (DOE), National Renewable Energy Laboratory (NREL), and Acciona Solar. The cost of *Nevada Solar One* was in the range of \$220M-\$250M.^[24]

For the purposes of this market forecast and assessment, it is projected that such SDP projects will continue to be defined during the coming years and that one or more such projects could represent a major source of funding for an integrated SPS-ALPHA program.

5.2.4 Forerunner Operational Systems (FOS)

Finally, depending on specific policies, the US and various international governments have from time to time invested in early market deployments of “forerunner operational systems” (FOS) with the goal of obtaining specific services as well as developing a nascent capability or market that will be of strategic value to the country involved. For example, the solar PV-based *Nellis Solar Power Plant* project, located at the Nellis Air Force Base in Clark County, Nevada with a 14 MW generating capacity was purchased by the US government Department of Defense (DOD). The cost of *Nellis Solar Power Plant* (which was completed in 2007) has been estimated to have been in the range of \$100M-\$150M.^[25]

The roadmap presented in Section 7 of this report is based (very loosely) on the historical precedent of a scenario in which an initial USAF B-47 jet bomber (government), is followed by a follow-on Dash-80 prototype (commercial), and the subsequent parallel KC-135 tanker aircraft (government) and Boeing 707 commercial jet (commercial).¹⁴

In this market assessment, it is assumed that government programs will co-fund the development of selected early SPS-ALPHA systems to deliver power for specific projects and/or applications.

5.6 Terrestrial Applications

There are a number of potential terrestrial point-to-point applications of WPT based on SPS-ALPHA (and LS-ALPHA, described above). The viability of these applications of WPT will depend upon the existence of external constraints that preclude the use of what would otherwise be lower cost solutions (such as High Voltage DC (HVDC) power lines).

Typically, electrical power can be transferred over distances from fractions of a meter to some thousands of kilometers using conventional power lines. However, there are also a number of instances in which power needs to be conveyed efficiently across distances that cannot be spanned by power lines; these include power transmission from the ground to aircraft, power transmission from point-to-point on Earth or in space, and in the longer-term power transmission from space to Earth. In the latter cases, a novel approach – wireless power transmission (or WPT) – may be used. The technology of long-distance WPT has been developed for a range of applications, including power transmission to aircraft, transmission among systems in space, or transmission from a platform in space to a receiver on Earth.

There are a number of challenging power transmission requirements in various locations globally where WPT may be the best solution possible. For example, a specific power transmission challenge has been examined for a number of years in Canada involving transmission at the Straits of Belle Isle. It is understood that the Straits present a difficult challenge for conventional power transmission in that they are subject to the presence of strong tidal currents, sea ice and icebergs and the underlying bedrock is Canadian Shield granite. With respect to wireless power transmission, the distance across varies from 60 km to as little as 15 km, with an average of 18 km. The area is however subject to severe weather conditions and frequent high winds.

Another Canadian power transmission challenge is that of providing power to remote settlements, mining or other commercial operations at locations that are inaccessible from the primary power grid. In such cases, the power requirements can be substantial (ranging from 1 MW to 10s of MWs, and the distance over which power might be transmitted can range from 10s of km to a few 100s of km. (The maximum distance achievable using a line-of-sight system will be limited by the curvature of the Earth's surface, obstacles in the path, etc.)

Although these potential terrestrial applications exist, they are not included in the business case / economic analysis for SPS-ALPHA at this time due to their uncertainty.

5.7 Integrated SPS-ALPHA Market Model

Based on the above business opportunities for SPS-ALPHA, an integrated market model may be constructed. The resulting model, summarized below in Table 5-3, is divided into three major market groupings (listed in approximate time-sequence as to when they could emerge): (1) terrestrial energy (including both primary and secondary markets described above); (2) government-sponsored R&D and systems acquisition; and, (3) space mission applications (government and commercial).

¹⁴ There several well-known historical instances of the second case, which include the development of the B-47 jet bomber aircraft by the USAF in the late 1940s, which became the technical foundation for the Boeing's "Dash-80" system prototype passenger jet in the early 1980s. The Dash-80 in turn provided the systems-level foundation for both the USAF KC-135 tanker aircraft, and the Boeing 707 commercial jet passenger jet. Government funding for Boeing's version of the KC-135 provided important financial support for manufacturing early in the life cycle of the aircraft. [26, 27, 28, 29]

These data were incorporated into the overall SPS-ALPHA macroeconomic (spreadsheet-based) modeling tool and used to develop the overall economic assessment of the architectural concept.

Table 5-3 Integrated SPS-ALPHA Markets Timeline

Market Type / Segment	Market Opportunity	Location(s)	Time Frame	Potential Revenues
PRIMARY	CBP	Global; Major Cities (OECD and non-OECD)	Far-Term (and continuing)	1-2 GW @ $\leq 10\text{¢}$ / kW-hr Up to 100s of GW
	CIPP	Global; Major Cities (OECD and non-OECD)	Mid- to Far-Term (and continuing)	< 100sMW @ $\leq \$1$ / kW-hr Intermittent
	SES	Global; OECD Countries and Others	Mid- to Far-Term (and continuing)	< GW @ $\leq 50\text{¢}$ / kW-hr (up to 6-8 Years)
SECONDARY (Power)	C-PNP	Global; OECD Countries, Selected Locations	Mid- to Far-Term (and continuing)	< 10sMW @ $\leq 50\text{¢}$ /kW-hr (up to 6-8 Years)
	NS-PNP	Global; non-OECD Countries, Selected Locations, Changing Location Periodically	Mid- to Far-Term (and continuing)	< 10sMW @ $\leq \$2$ - $\$3$ kW-hr (up to 6-8 Years)
SECONDARY (Govt R&D and Systems)	ACTR	Major Space Agencies (Civilian & Other)	Immediate (and continuing)	\$100K-\$2M (up to 1-3 Years)
	TMD	Major Space Agencies (Civilian & Other)	Immediate (and continuing)	\$1M-\$5M (up to 3-5 Years)
	SDP	Major Agencies (Civilian & Other)	Immediate (and continuing)	\$10M-\$1B (up to 6-8 Years)
	FOS	Major Agencies (Civilian & Other)	Immediate (and continuing)	\$100M-\$1B (up to 6-8 Years)
SECONDARY (Space Appls)	SA	See Section 6	Immediate (and continuing)	Case by Case

THIS PAGE LEFT BLANK.

SECTION 6

PROSPECTIVE NON-SPS APPLICATIONS

6.1 Overview

Historically, space missions have always been “power paupers” – constrained in design choices due to limited power availability and the high cost of that power. As a result, there are a wide variety of potential benefits that space solar power technology and systems – and the R&D efforts leading to such – could establish for prospective future space applications. (See Figure 1-2 in the Executive Summary.) The range of these potential non-SPS applications includes:

- Solar Electric Power and Propulsion Systems for Exploration, such as
 - High Energy Solar Electric Propulsion based Orbital Transfer Vehicles (OTVs) for Earth orbit operations;
 - Multi-megawatt (MMW) Solar Electric Propulsion Systems (SEPS) for Interplanetary Human Exploration Missions (such as Human Mars Missions, HMM); and,
 - Advanced Solar Electric Propulsion Systems for robotic science and human exploration precursor missions.
- Solar Electric Power for Lunar and Planetary surface operations, such as
 - Power delivered from space to surface systems;
 - Power delivered from one point on the surface to another (e.g., into permanently shadowed regions); and,
 - Power generated locally at locations, and for systems used at surface access and/or operations.
- Solar Electric Power for Large Earth-orbiting Platforms, such as
 - Very large satellite applications in GEO, and/or high-power platform applications in LEO).
- Propulsion and/or Power for Outer Planet / Deep Space Missions, such as
 - SEP systems for missions traveling to the outer planets;
 - Solar Power for deep space missions in the Inner Solar System, through the Main Belt Asteroids; and,
 - Solar Sails for deep space / outer planet robotic missions.

In addition, for the SPS-ALPHA system concept there are special applications of the technologies and/or systems involved. For example, in the case of RF phased array WPT systems, there may be useful applications of the large aperture systems technologies.

The following paragraphs present the results of a high-level assessment of potential non-SPS applications of SPS-ALPHA systems, technologies and supporting infrastructure conducted as part of this Phase 1 NIAC project. The concluding paragraphs summarize all of the potential applications of the SPS-ALPHA architectural approach (including SPS and non-SPS applications), and present recommendations for future studies and technology developments.

6.2 Civil & Commercial Space Mission Applications

In most locations across the Inner Solar System, continuous solar energy is almost always available. SPS-ALPHA would establish the capability to deliver power (at roughly \$1/kW-hour) to civil or commercial space missions in space, on the Moon, Mars, or small bodies. The availability of reliable, inexpensive and continuous

power at levels of 100s kW to 10s MW or higher would forever change the character of space systems, missions, and goals. Also, ancillary SSP technologies – in areas such as space transportation, space communications, in-space construction, robotics, lightweight structures, and others – would be of immense value to a wide range of civil / commercial space missions. [7,19,21]

The following paragraphs sketch several prospective space applications of SPS-ALPHA and its major system elements.

6.2.1 Earth Orbiting Applications

A wide variety of current and prospective Earth-orbiting space mission applications (both commercial and civil government missions) would benefit from the potential to realize high-power and/or large aperture spacecraft for significantly lower costs. These mission opportunities fall into three broad categories: (1) communications satellites (either in GEO or other orbits), (2) radar satellites (particularly Earth-observing satellites and air traffic control satellites), and (3) optical communications terminal spacecraft (either in Earth orbit or in an orbit such as an Earth-Moon Libration Point). The following are brief descriptions of these potential applications.

Communications Satellites. Increasing the power and the aperture size for communications satellites in order to increase the number of channels, to improve the bandwidth available, and the utilization of spectrum is an ongoing goal of communications satellite (Commsat) research and development. However, accomplishing these goals by means of conventional spacecraft architectures requires significant increases in projected costs. Moreover, given the constraints of existing launch vehicles, increases in spacecraft aperture beyond a certain size involves extraordinary technical challenges in terms of deployable aperture systems. And, in any case, there are firm limits on the total spacecraft mass that can be realized in GEO given existing launchers and in-space transportation systems.

There are two classes of applications that would result from advancing the SPS-ALPHA concept: (1) applications of SPS-ALPHA platform systems and technologies; and (2) utilization for commercial Commsat missions of SPS-ALPHA supporting infrastructures. The second of these is straightforward: the deployment of SPS-ALPHA (even in a pilot plant scale) would result in significant reductions in launch and in-space transportation costs for all Earth-orbiting missions. In addition, Affordable In-Space Transportation (AIST) systems, such as SEPS orbital transfer vehicles (OTVs) would greatly increase the payload delivered to GEO for even conventional spacecraft architectures.

The use of SPS-ALPHA platform systems and technologies to accomplish government and commercial mission Commsat goals is also promising in several different ways. First, the baseline technology SPS-ALPHA architecture scales (consistent modeling of an early prototype system) to deliver apertures of various sizes at costs considerably lower than conventional architecture spacecraft. Second, the hyper-modular approach, with in-space assembly, allows the construction of apertures sizes that are unreachable for commercial space systems now, or in the foreseeable future. And finally, the introduction of new in-space transportation systems (such as SEP OTV) will make it possible to stage even larger spacecraft to GEO.

Figure 6-1 presents a first-order case study of the GEO Commsat market, comparing (1) the development and launch of the first of a notional new series of CommSats using a conventional spacecraft architecture, and (2) development and launch of a series of three alternate modular GEO CommSats based on the SPS-ALPHA architecture (“GEO CommSat-ALPHA”). The four cases examined were:

Conventional In-Space Transportation Cases

- Case 1: Conventional Large CommSat; power @ 8 kW, mass @ 3,000 kg; aperture @ 2 x 300 m²
- Case 2: CommSat-ALPHA; power @ 8 kW, mass @ 3,000 kg¹⁵; aperture @ 180 m²

¹⁵ Note: Case 2, the smallest GEO “CommSat-ALPHA” includes mass for launch of the robotic in-space assembly and construction systems, as well as the required space structures and reflectors, etc.

Advanced In-Space Transportation Cases

- Case 3: CommSat-ALPHA; power @ 16 kW, mass @ 6,000; aperture @ 600 m²
- Case 4: CommSat-ALPHA; power @ 32 kW, mass @ 12,000; aperture @ 1,200 m²

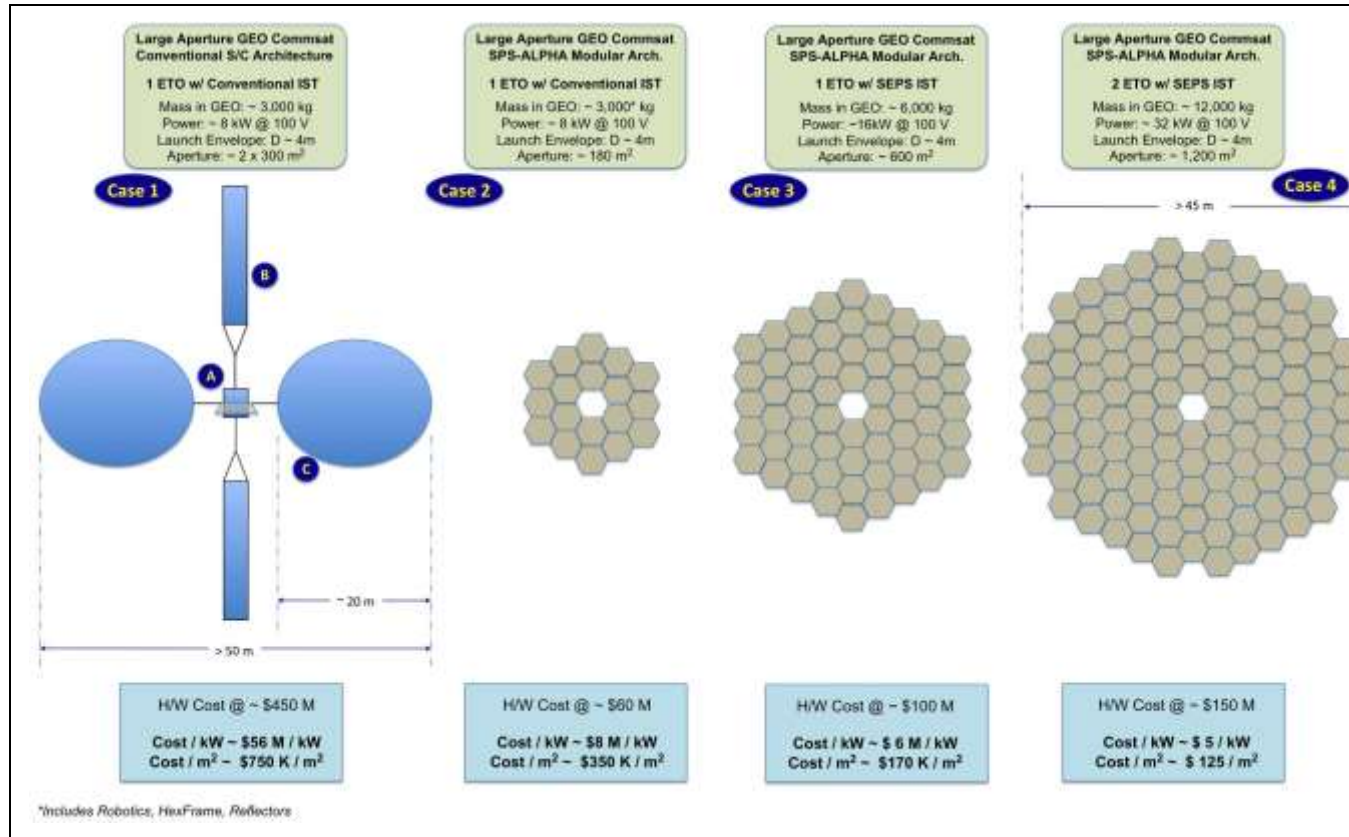

Figure 6-1 Mini-Case Study of a Conventional GEO CommSat as compared to a “CommSat-ALPHA”

As can be seen in the figure, for equivalent launched mass “CommSat-ALPHA” (with advanced space transportation) case results in an improvement of as much as 9:1 in the cost per kW, and of better than 4:1 in the cost per m² of aperture. If SPS-ALPHA can be developed successfully, then an early sub-scale demonstration (see the preliminary technology roadmap in Section 9) would be consistent with a better than 10-fold improvement in communications satellites: 4 times more power and twice the aperture, for less than 1/3rd the cost.

Some important notes: in all cases above, launch costs are not included. The level of technology is assumed to be roughly equivalent, but the cost of technology R&D is not included. Also, in all cases the initial development Cost Estimation Relationship (CER) is assumed to be \$150,000 / kg.¹⁶ However, in the case of the modular architecture, a learning curve of approximately 70% is applied (see Section 5 for additional discussion on selection of this factor, and sensitivity of results to the choice of CER). The most significant difference is in the architecture, and the potential for mass production of the system elements in the “CommSat-ALPHA” spacecraft case.

Future studies should examine this case in much greater detail, including more detailed evaluation of the costs for ancillary systems (such as robotics ISAAC), the potential impact of frequency re-use for the larger aperture cases, and the potential impact on revenues and overall economics for each of the cases examined.

¹⁶ Although the conventional architecture spacecraft considered here is entirely notional (and does not reflect any specific spacecraft), the scaling and other data are not inconsistent with the recent JAXA ETS-VIII spacecraft. [G]

Radar Satellites. In the case of future radar satellites, the analysis should be quite similar to the above case, with the cost per unit of area and the cost per unit of power for a conventional architecture radarsat versus a “RadarSat-ALPHA” architecture resulting in significant advantage to those cases where a significant improvement in cost due to mass production of spacecraft elements can be realized. Future studies should examine this case in detail, including the impact of frequency requirements for the larger aperture cases, scanning angle requirements and the potential impact on structural flexibility on systems performance.

Optical Communications Terminal Satellites. For decades, a principal objective of NASA investments in the Deep Space Network (DSN) and in on-board communications systems has been to increase the data rates that can be realized with spacecraft in deep space. Increasing the diameter of on-board communications dishes, increasing the size of ground stations, and arraying multiple independent ground stations together to form a large synthetic apertures are all techniques that have been engineered into new space systems over the years.

One visionary option to dramatically improve these data rates is that of transitioning from RF communications links to optical (laser) communications links. This concept has been under study and development for the past 30 years or so, and considerable progress has been made in the development of relatively compact optical transceivers with reasonably sized apertures (capable of providing good onboard link performance) that can be placed on board deep space spacecraft in the future.[30]

Due to the cost of large space telescopes and space-based laser systems, deep space optical communications concepts usually assume that the Earth-side of the link will be located on Earth’s surface, for example an optical telescope with a laser transceiver located at the DSN station in Goldstone, California. However, optical telescopes located above the Earth’s atmosphere might offer significant advantages over telescopes on Earth’s surface. For example, with a space-based system, link degradation due to cloud cover or atmospheric attenuation would be eliminated. Also, signal degradation resulting from stray light interference (e.g., during daytime) could be reduced. However, the cost of such a terminal, combined with the relatively infrequent need for this capability, represent significant barrier to introducing a space-based optical communications terminal (SbOCT).

Figure 6-2 presents a first-order case study of an Earth-Orbiting SbOCT, comparing (1) two cases involving the development and launch of the first of a notional new SbOCT spacecraft using a conventional spacecraft architecture, and (2) development and launch of an alternate modular Earth-Orbiting SbOCT based on the SPS-ALPHA architecture (“SbOCT-ALPHA”).

The three cases examined were:

Conventional Spacecraft Architecture Cases

- Case 1: Conventional Satellite, Single Large Aperture 5 m²; power @ ~ 1 kW, mass @ 3,000 kg; (with 2,000 kg for S/C Mass, and 1,000 kg for P/L Mass)
- Case 2: Conventional Satellite, Six (6) Modular Apertures with a total Aperture Area of 5 m²; power @ ~ 1 kW, mass @ 3,000 kg; (with 2,000 kg for S/C Mass, and 1,200 kg for Total P/L Mass)

Modular Spacecraft Architecture Case

- Case 3: Modular Architecture Satellite, Six (6) 2-Meter Diameter HexBuses, plus structure and reflectors, and Six (6) Modular Apertures with a total Aperture Area of 5 m²; power @ ~ 1 kW, mass @ 3,000 kg; (with 2,000 kg for S/C Mass, and 1,200 kg for Total P/L Mass)

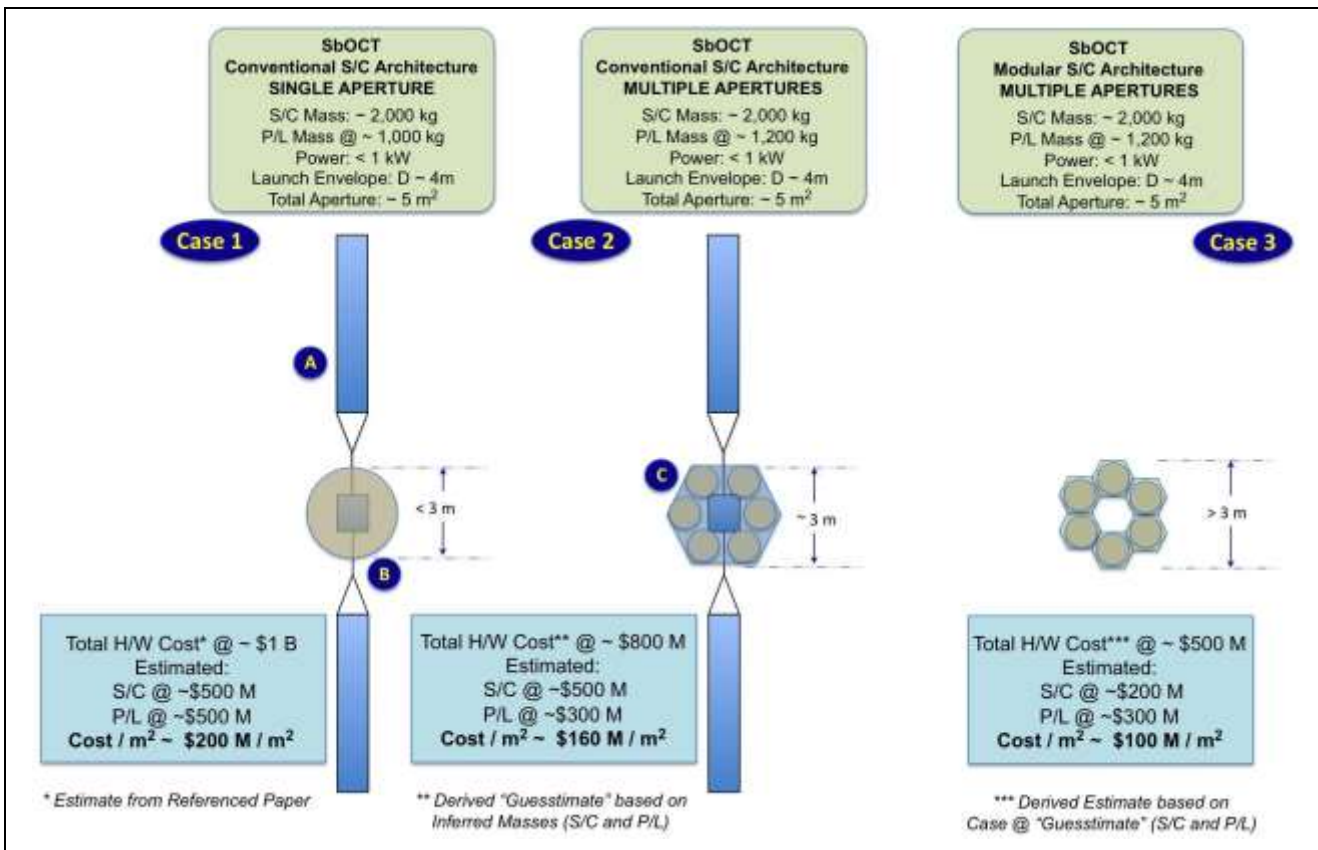

Figure 6-2 Mini-Case Study of a Conventional Satellite SbOCT vs. a Modular "SbOCT-ALPHA"

In the literature, two alternative cases for a conventional spacecraft architecture Earth-orbit optical communications terminal have been examined: (1) involving a single large telescope, and (2) involving a modular set of telescopes that work in tandem. For purposes of this mini-case study, these two options have been fleshed out (with mass estimates for the spacecraft and payload), and compared to a modular spacecraft architecture based approach. As can be seen in the figure, for equivalent launched mass, the "SbOCT-ALPHA" case may have the potential to improve overall cost by as much as a factor of two (2) compared to the fully monolithic case, and by about 1/3rd for the case of a modular optics approach.

Some important notes: in all cases, the launch costs are not included. The level of technology is assumed to be roughly equivalent, but the cost of technology R&D is not included. Also, in all cases the initial development Cost Estimation Relationship (CER) is assumed to be \$250,000 / kg for the precision-pointing host spacecraft, and \$500,000 / kg for the optical communications payload.¹⁷ In the case of the modular optical architecture (Case 2), and the fully modular architecture (Case 3), a learning curve of approximately 70% is applied (see Section 5 for additional discussion on selection of this factor, and sensitivity of results to the choice of CER). As is found elsewhere, the most significant differences among the three cases lies in the modularity of the architecture, and the potential for mass production of the system elements. Future studies should examine this and related cases in much greater detail, including more detailed evaluation of the costs for modular systems capable of hosting optical payloads.

6.2.2 Power and Propulsion Applications for Exploration Missions

¹⁷ Although the conventional architecture spacecraft considered here is entirely notional (and does not reflect any specific spacecraft), the scaling and other data are not inconsistent with the recent JAXA ETS-VIII spacecraft. [G]

Solar Electric Propulsion Systems (SEPS) are one of the most significant potential space applications of the systems and technologies that are needed to enable SPS, and of the actual systems that would be needed to deploy and operate SPS in GEO. These include applications that range from SEPS for orbital transfer vehicles (OTVs) for Earth orbit operations, to multi-megawatt (MMW) SEPS for interplanetary missions.

As illustrated in Figure 6-3, there are a variety of possibilities and energy requirements for transportation in the Earth-Moon system and the inner Solar System. There are several general observations that may be made regarding this highly generalized “energetics map”.

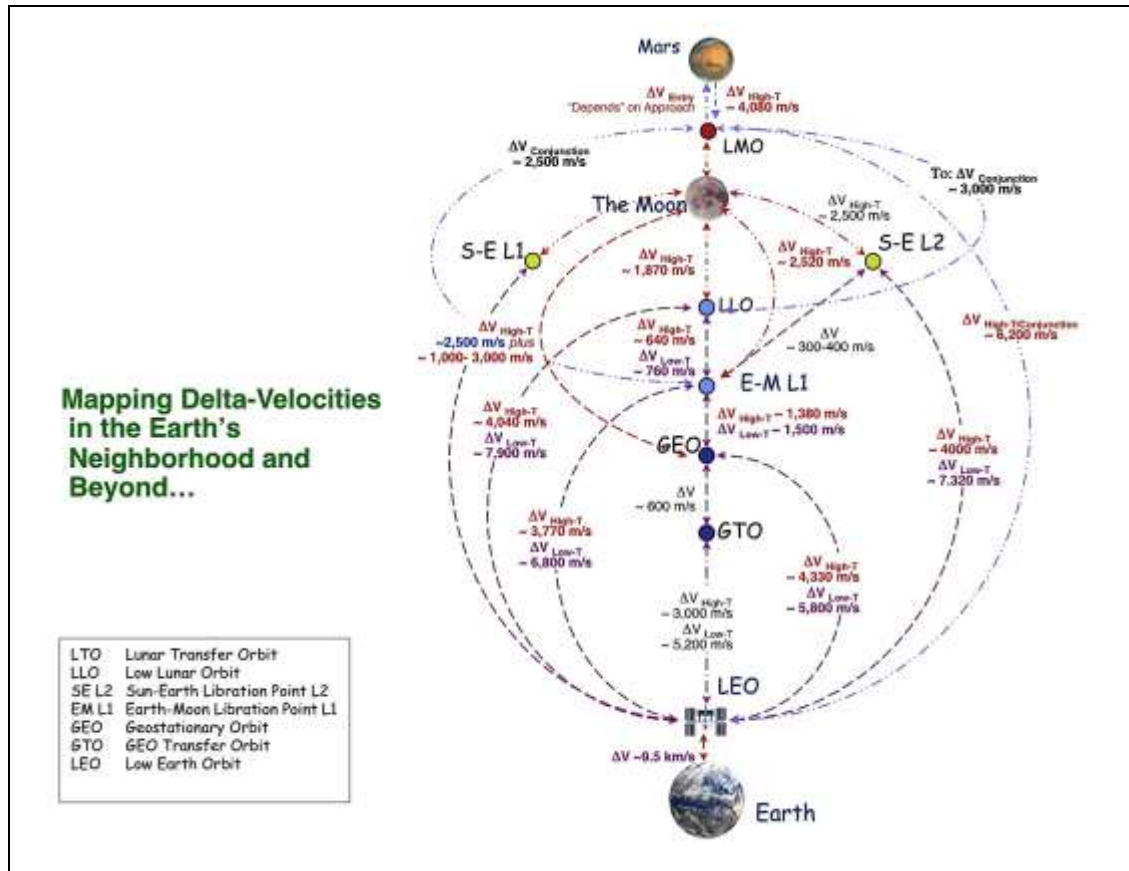

Figure 6-3 Space Transport Energy Requirements Diagram
 (Credit: NASA / J. Mankins, c. 1999)

First, the energy requirements (measured in units of “meters per second” in the figure) change significantly depending on the technology: increased by roughly 70%-90% when the propulsion concept shifts from a high-thrust / short duration firing options (such as high-energy cryogenic propulsion) to low-thrust / long-firing options (such as SEPS). This is due to the increase in the gravity losses when a vehicle must take longer to move from one orbit to another in a gravity well.

Second, it is interesting to observe that there is a close similarity among several of the propulsion cases illustrated in Figure 6-3. In particular, the energy requirements for low thrust transportation for several cases of interest are as follows:

- SEPS Transport from LEO to GEO Change in Velocity:
 - ~ 4,300 meters/second; this is the primary in-space transportation mission requirement for a GEO-based solar power satellite, such as SPS-ALPHA.
- SEPS Transport from LEO to Low Lunar Orbit (LLO) Change in Velocity:
 - ~ 4,000 meters/second.

- SEPS Transport from LEO to the Earth-Moon Libration Point L1 (E-M L1) Change in Velocity:
 - ~ 3,800 meters/second.
- SEPS Transport from LLO to Low Mars Orbit (LMO) Change in Velocity:
 - ~ 3,000 meters/second
- SEPS Transport from E-M L1 to LMO Change in Velocity:
 - ~ 2,500 meters/second.

The central conclusion that may be drawn from these data is that the change in energy required for an SPS transportation system capable of moving equipment and logistics from LEO to GEO (at about 4,300 m/s) is also more than capable of achieving all of the other missions listed. As a result, the transportation infrastructure for SPS-ALPHA would also represent a significant advance in future space capabilities of general value for human exploration beyond LEO. Some additional aspects of these options are discussed in paragraphs that follow.

Human Mars Mission (HMM) Applications. Human Mars Mission (HMM) applications of advanced solar electric propulsion can be conceptualized at three scales: (a) relatively low power (e.g., 50-100 kW) SEPS for application in precursor Mars Sample Return (MSR) missions as early precursors to HMM, (b) mid-power (e.g., 500 kW – 1,000 kW class) SEP freighters the pre-position logistics and systems for an HMM at Mars prior to the human crew being launched, or (c) high-power SEP (e.g., 5,000 kW – 10,000 kW class) SEP crew-carrying interplanetary vehicles.

There are a number of different systems concepts for high-power solar electric propulsion (SEP) systems that could support both SSP transportation (LEO to GEO) and HMM applications (e.g., E-M L1 to LMO). (Both of the concepts illustrated are highly modular SEP vehicles that incorporate the design approaches discussed elsewhere in this report. More monolithic vehicle architectures are typically considered and have been examined extensively. However, if feasible, then modular approaches should be capable of realizing much more affordable solutions.)

Power for Outer Planet / Deep Space Robotic Missions. For outer planet operations, the solar intensity is too faint to conveniently allow solar energy to be used for spacecraft beyond the orbit of Jupiter. However, at Earth orbit and throughout the inner Solar System, SSP technologies might very effectively be used to deliver high capacity, high power SEP transportation to the outer planets and other deep space robotic missions. As indicated above, advanced SSP technology SEP stages will be more than capable of sending robots at high speeds to deep space. In such cases, power at the destination would likely be provided by RTGs, DIPS, or small space reactor power systems.

Future studies should examine this case in much greater detail, including evaluation of the costs and technology challenges for ancillary systems (such as robotics ISAAC), particularly when operating at remote locations. In addition, the potential for re-use of SPS-ALPHA systems (e.g., the PACA) in future space transportation applications should be examined.

Solar Sails / Spacecraft for Outer Planet / Deep Space Robotic Missions. As illustrated in Figure 6-4, in addition to the types of robotic mission described above, the SRA (including HexBus) may be able to be used as a solar sail for outer planet or other deep space missions. A good example of this type of configuration (with additional functionality, such as thin-film PV integrated into the solar sail) is the 2011 JAXA IKAROS mission.[13]

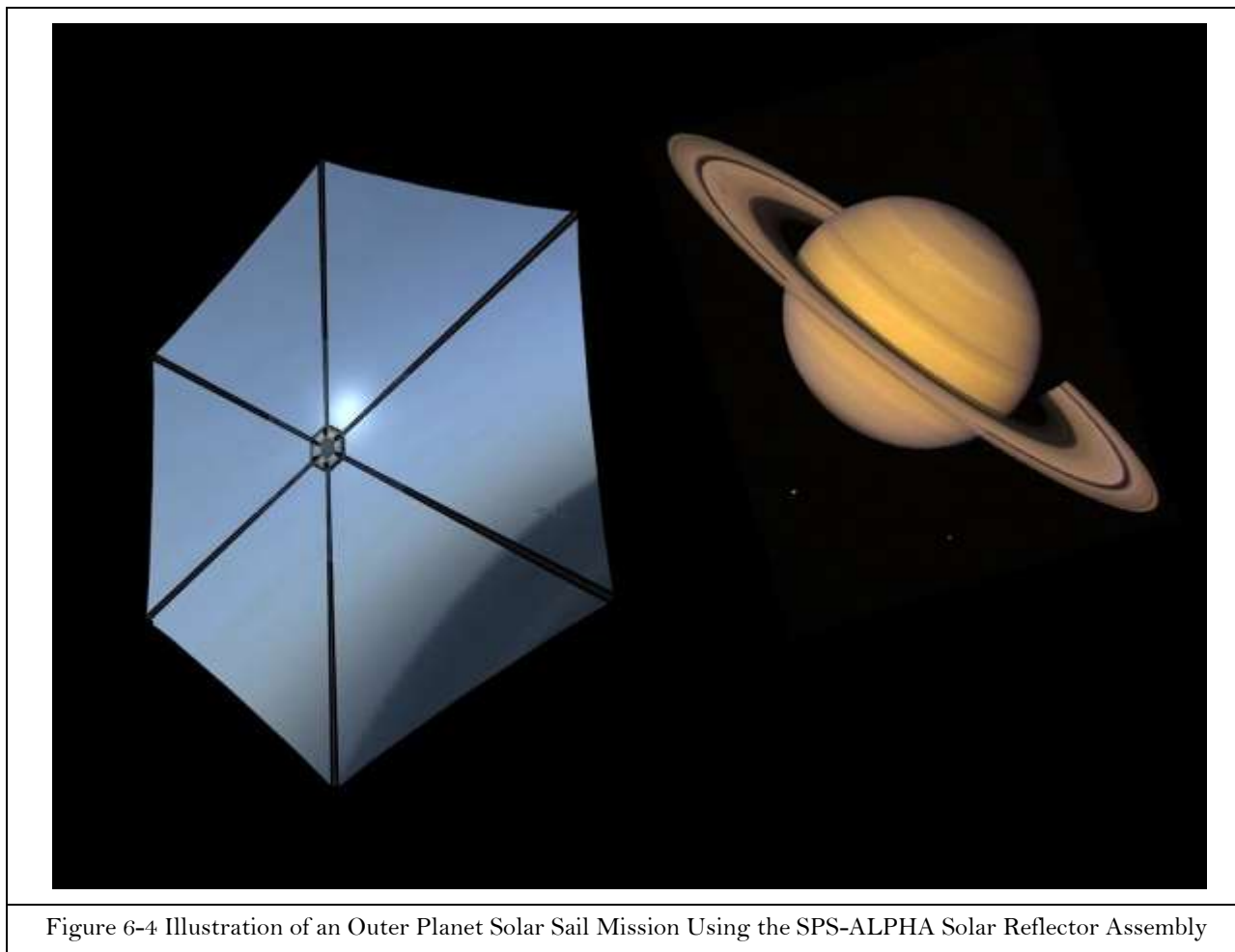

Figure 6-4 Illustration of an Outer Planet Solar Sail Mission Using the SPS-ALPHA Solar Reflector Assembly

6.2.3 Lunar Surface Power

One interesting potential option for space applications is that of delivery of low-cost solar energy to the Moon during its 14-day night, or to regions of the moon that are permanently shadowed at the lunar poles. Such operations would typically require from multiple tens of kilowatts up to hundreds of kilowatts or more power, such as to power in situ resource utilization (ISRU) operations. The economics of lunar power will depend greatly on the details involved; however, three potential cases have been identified; including:

- Case 1: Lunar Surface-based SPS-ALPHA elements (LS-ALPHA), involving point-to-point WPT for systems on the lunar surface, but in shadow
 - In this case, WPT transmission ranges would typically be from 10-30 km
- Case 2: Lunar Orbit Based SPS-ALPHA (LO-ALPHA), involving power from an elliptical orbiting or pole-sitting small-scale SPS for systems on the surface, in shadowed locations, or during the lunar night
 - In this case, WPT transmission ranges would typically be on order 5,000-10,000 km
- Case 3: EM L1 SPS-ALPHA, involving power from a SPS at the Earth-Moon L1 Libration Point to systems on the lunar surface during lunar night.
 - In this case, WPT transmission would be over a distance of roughly 61,000 km

Of these three options, Case 1 (“LS-ALPHA”) appears to be nearer-term, and has been examined in greater detail as a part of the current NIAC study project.

LS-ALPHA Case Study. In this case, one or more small-scale versions of the SPS-ALPHA primary array would be deployed at locations that are almost always illuminated. These small-scale space solar power systems would be set up in an array perpendicular to the surface, and facing an area of interest that is permanently in shadow. As a “mini-Case Study” within this NIAC project, Shackleton Crater was chosen as a potential location for a surface version of SPS-ALPHA (aka, Lunar Surface ALPHA or “LS-ALPHA”). As shown in Figure 6-5 (from NASA Lunar Reconnaissance Orbiter, LRO data), Shackleton is an impact crater that is located almost exactly at the south pole of the Moon. [31]

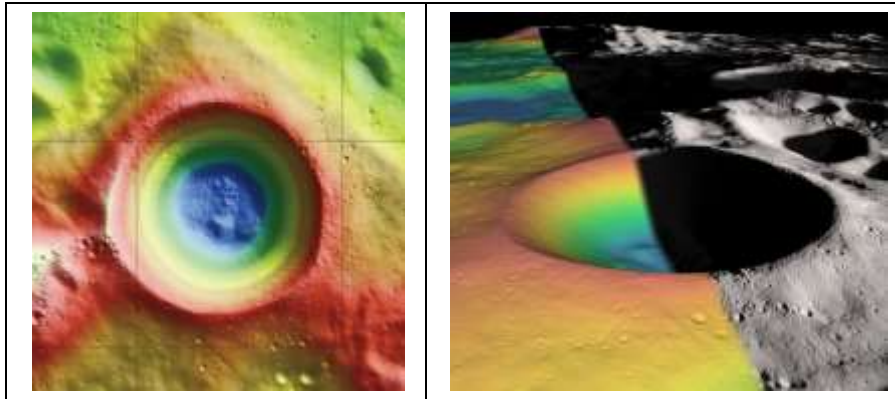

Figure 6-5 Images of Shackleton Crater at the Moon’s South Pole
Credit for the Image on the Left: NASA/Zuber, M.T. et al., Nature, 2012

The rim of the crater is exposed to sunlight almost continuously, while the interior of the crater, particularly at the center, is perpetually in shadow. During recent years, it has been shown that the very low temperatures inside the crater operates as a cold trap that captures by freezing volatiles delivered by comet impacts on the Moon.

Figure 6-6 below illustrates a potential approach to an LS-ALPHA that could deliver power to systems operating on the shadowed floor of the crater. The concept involves the following elements:

- Point A provides a notional view of a surface based version of the SPS-ALPHA primary array, sized (assuming 4 m diameter HexBus segments) with a total diameter of approximately 50 meters. As in the case of the space-based SPS-ALPHA concept, the elements of this array would comprise: (1) HexBus units, (2) SPG modules, (3) WPT Modules, and (4) Interconnects. The overall array would require robotic assembly (assumed here to be by modified versions of the robotics used for the GEO version of the concept).

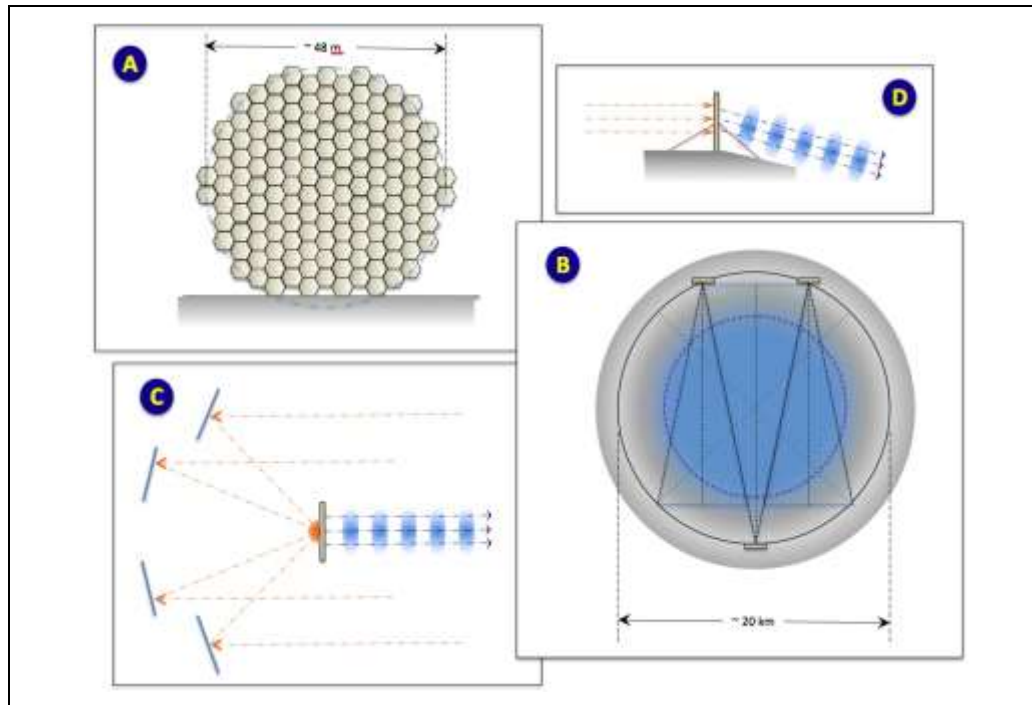

Figure 6-6 Concept for a Lunar Surface Version of SPS-ALPHA (“LS-ALPHA”)

- Point B provides an overview of the concept, illustrating how several relatively small diameter SPS-ALPHA type primary arrays could deliver power to almost all of the permanently shadowed region at the base of the crater. The illustration shows three arrays, each with a scanning angle of $\pm 15^\circ$ from the centerline of the primary array. In this approach, no moving parts would be required at the array.¹⁸
- Point C illustrates the idea of using steerable reflectors (heliostats) to assure that the back plane of the primary array is illuminated constantly. An alternative approach would be to emplace additional arrays so that one of the arrays would be always be illuminated during the 28-day lunar day-night cycle.
- Point D provides a side view of the concept, illustrating how the phased array would direct microwave energy into the crater to be received by systems in the permanently shadowed region.

A system of this type was demonstrated by Kobe University (Prof. N. Kaya) in 2009 at the SPS 2009 conference at the Ontario Science Center (OSC) in Toronto, Canada with sponsorship from SPACE Canada. See Figure 6-7 for a photograph of this system, which beamed power at 2.45 GHz to a moving robotic vehicle using a retrodirective phased array with a scanning angle of approximately $\pm 15^\circ$. [8] Although small in scale, the Kobe University test proved all of the basic technologies required for a system of this type.

¹⁸ Another approach could involve using tracking heliostats directly to reflect sunlight to systems at the base of the crater. However, this would involve active tracking of roving vehicles and could be affected by dust arising from ISRU operations. This option should be examined in a future study.



Figure 6-7 Photograph of a Kobe University Demo of WPT at the SPS 2009 Conference in Toronto, Canada

In the case examined, a system similar to the proposed SPS-ALPHA Pilot Plant (see Section 7), generating approximately 500 watts of microwave power per square meter of array, would have an output power of roughly 900 kW for a single array from some 180 panels (each with a mass of approximately 100 kg). For a three transmitter case (such as is shown in Figure 6-7, Point B, the total RF power generated would be almost 3 MW, using some 540 panels). Such a system could deliver (very roughly) about 15-30 W/m² to receiver systems at the center of the crater, with the total power received depending on the size and efficiency of the receiver. For example, a moving robotic system with receiver of 10 m² in area and an efficiency of 80% would have in on-board power of 120-240 W. Note that this power could be received simultaneously by any number of independent systems within an area of roughly 100,000 m² or periodically by any system within the scanning range of the three (3) unit transmitter array.

For LS-ALPHA panels consistent with the SPS-ALPHA Pilot Plant (which would involve approximately 3,500-7,000 primary array panels), a rough estimate of the cost of an additional 540 panels would be approximately \$50,000 per panel, for a total hardware cost of roughly \$30M (including only the primary array panels). It may be projected that the cost for a radioisotope power unit (i.e., an RTG) for a single rover requiring several 100 Watts would have a cost in a similar range or greater.[32]

In the case of the LS-ALPHA application, the cost of electricity will of course depend on how much of the energy delivered by WPT is utilized. For example, in the case of 50 rovers, each using 240 W, and a single central ISRU processor (e.g., producing LOX and LH₂ for fuel) utilizing 50 kW, the total power utilized would be roughly 60 kW and the cost of electricity (over a ten year lifetime) would be roughly \$6 per kW-hr. Although high compared to terrestrial energy costs, this would be a significant improvement over conventional space power approaches. (By way of comparison, an RTG costing \$30 M and producing 200 W would deliver for a single rover a cost of electricity over the same period at a hardware cost of approximately \$1,600-\$1,800 per kW-hr.)

Of course, the cost of landing LS-ALPHA components on the lunar surface are not included above, and the assumption that assembly on the lunar surface can be implemented using robotics similar to, or the same as those used for in-space SPS assembly is unproven. Additional study is needed to conduct a rigorous AoA to compare this concept and others for delivering power to lunar polar operations. The objective of the above “mini-case study” was to illustrate how the system elements of the SPS-ALPHA architecture might be use for diverse non-SPS applications, including lunar surface power.

6.3 Security-Related Applications

High power large apertures would be of great value for U.S. security space missions.[33] And, recent studies (e.g., for DOD NSSO) concluded that development of SSP systems and technologies, including SPS, would significantly benefit the security of the U.S. and its allies. Not only would space systems benefit, but benefits would also result from delivery of assured, affordable power to forward bases, military operations, markets, and allies. [34]

6.5 Summary of Potential Applications of SPS-ALPHA Systems and Technologies

There are a wide range of potential applications of the SPS-ALPHA concept systems and technologies, supporting infrastructure and related technology and systems. In addition to solar power satellites delivering solar energy to terrestrial markets, these span a variety of civil space, commercial space, security and non-space applications. Table 6-1 summarizes some of these potential applications of the SPS-ALPHA concept and related systems (including SPS for terrestrial markets).

6.6 Recommendations for Future Studies

There are two basic scenarios for the development of SPS-ALPHA and potential non-SPS space and terrestrial applications of the space solar power systems and technologies involved: (1) SPS-ALPHA is developed first, and other applications follow, and (2) the technologies and systems for space solar power are developed first, and SPS-ALPHA development follows. Future studies should examine in greater detail and in tandem both SPS-ALPHA and prospective non-SPS applications of the systems, technologies and infrastructure required. It seems that an overall optimization should be possible, in which early demonstrations of SPS-ALPHA concepts are designed to lead directly to non-SPS civil space, commercial and other mission applications.

Table 6-1 Summary of Potential Applications of SPS-ALPHA Systems and Technologies

Time Frame	Venue for Application	Type of Application	Application
Nearer-Term (5-10 years)	Terrestrial	Technologies	Point-to-Point Wireless Power Transmission
	Low Earth Orbit	Systems	LEO Communications Satellites Constellations (Large Aperture, High Power, Multiple Spot)
			Robotic Servicing or Debris Mitigation in LEO
	Geostationary Earth Orbit	Systems	GEO Communications Satellites (Large Aperture, High Power)
			GEO Earth Remote Sensing Satellites (Large Aperture, High Power)
		Supporting Infrastructure	LEO-GEO Transport for GEO Satellites
Robotic Servicing for Satellites in GEO			
Mid-Term* (10-20 yrs)	LEO (or other orbits)	Systems	Large Aperture Optical Communications Terminal
	Geostationary Earth Orbit	Systems	SPS-ALPHA Pilot Plant (Power for "Premium Niche Markets" @ 1-20 MW)**
	Earth-Moon System and Vicinity	Systems	Lunar Surface Power Systems / Wireless Power Transmission (Point-to-Point)
		Supporting Infrastructure	LEO-LLO Transport for Lunar Missions (Cargo missions for human exploration, surface operations, etc.)
			LEO-Target Transport for Near-Earth Asteroid and Libration Point Missions (Cargo missions for human exploration, surface operations, etc.)
Beyond the Earth-Moon System	Supporting Infrastructure	Transportation for robotic exploration missions (inner solar system and beyond)	
Far-Term (20-30 yrs)	Geostationary Earth Orbit	Systems	SPS-ALPHA Initial Full-Scale SPS (Power for "Premium Commercial Markets" @ ≤ 1 GW)
	Earth-Moon System and Vicinity	Systems	Orbital Systems (Lunar or Libration Point) SPS for Lunar Surface Power
Very Far-Term (>30 years)	Geostationary Earth Orbit	Systems	SPS-ALPHA Mature Full-Scale SPS (Power for Commercial Markets @ > 2 GW)
	Mars and Vicinity	Systems	Mars Orbit SPS for Surface Power
		Supporting Infrastructure	Transport for Human Mars Mission (Cargo missions for human exploration, surface operations, etc.)

* Note: In this table potential applications are indicated on in the first timeframe when they might occur; for the sake of clarity they are not repeated in later timeframes during which they might also be possible.
 ** Note: Markets are defined elsewhere in this report; see Section 5.

THIS PAGE LEFT BLANK.

SECTION 7

SPS-ALPHA SYSTEMS ANALYSIS RESULTS

7.1 Overview

The SPS-ALPHA Phase 1 project systems analysis has produced preliminary results comprising (1) a detailed definition of the SPS-ALPHA systems concept (focusing on the SPS platform) for several distinct Design Reference Missions (DRMs); (2) initial macroeconomic results (including cost estimates, economic performance results, etc.); and, (3) initial AoA sensitivity studies centered around critical FOMS at the architecture level, the systems level and the concerning specific technologies. Table 7-1 highlights some of the important parameters that can be varied in the Phase 1 systems analysis.

Table 7-1 SPS-ALPHA System Analysis FOMS

Architecture-Level Figures of Merit (FOMS)	Selected System-Level FOMS	Selected Technology-Level FOMS	Selected Modeling / ACES Outputs
Power Delivered at Earth (MW)	Time Between Refueling Operations (yr)	Material Density, by Material (kg/m ³)	Number of Modules, by Type (No.)
Orbital Altitude (km)	Reflector Type (Shape)	Solar Power Generation Specific Power (kW/kg)	Mass of Modules, by Type (kg)
WPT Transmission Frequency (GHz)	Primary Structure Assembly Diameter (m)	Selected Module Specific Mass (e.g., kg / m ² , kg / m, etc.)	Station-Keeping Propellant Mass Required (kg)
Fractional Expendability (HW % Expended per Year)	Primary Array Assembly Diameter (m)	Average DC-RF Device Power (W-output/Device)	Specific Cost of Hardware, by Module Type (\$/kg)
Discount Rate (%/year)	Receiver Diameter (m)	WPT-Transmitter DC-RF Conversion Efficiency (%)	Specific Power per Device
Manufacturing/Learning Curve (%/Doubling)	Technology Selections (e.g., SPG, WPT, etc.)	WPT-Receiver RF-DC Conversion Efficiency (%)	Concentration Ratio
Price of Electricity, by Market (\$/kW-hr)	Structural Systems Approach(es)	Various Detailed FOMS	Levelized Cost of Electricity (LCOE; \$/kW-hr)

Five specific Design Reference Missions (DRMs) were examined by the study. These DRMs are discussed in the sub-section that follows.

7.2 SPS-ALPHA Design Reference Missions

The DRMs defined and analyzed as part of this study project included: (1) DRM_1, an initial low-power low Earth orbit (LEO) technology flight demonstration (TFD); (2) DRM_2, an integrated, moderate power LEO technology demonstration; (3) DRM_3 a geostationary Earth orbit (GEO) based SPS pilot plant (at sub-scale); (4) DRM_4, an initial full-scale GEO-based SPS (first system); and, (5) DRM_5, representing large-scale GEO-based recurring SPS platforms (i.e., the second and later SPS).

7.2.1 DRM_1: Initial Small-Scale TFD in LEO

The objective of DRM_1, a small-scale demonstration in LEO, would be to validate both “off-the-shelf” and “off-the-workbench” technologies in an initial version of the SPS-ALPHA architecture, including testing of

all major platform systems (e.g., modules and assemblies) and technologies (including electric propulsion and robotics). DRM_1 would need to be large enough to transmit an effective amount of power to Earth-based receivers. However, this TFD could (with a space-based receiver) test point-to-point power transmission.

DRM_1 Baseline. Using the ACES methodology (and supporting software tools, such as the SSM, etc.), a baseline case for DRM_1 was defined by the Phase 1 study: DRM_1 Case_1 (D1/C1). The SPS-ALPHA platform in the D1/C1 case was modeled as involving an ellipsoid version of the Primary Structure Assembly (PSA), as described in Section 3, Sub-Section 3.5.3 and shown in Figure 3-14 as option A1. The baseline case involves a total power delivery capacity of 30 kW. Table 7-2 immediately below presents the detailed mass statement for the D1/C1 system.¹⁹

Table 7-2 Summary of Preliminary Mass Statement of SPS-ALPHA DRM_1 / Case_1

Mass Statement by Module				Mass Statement by Assembly	
Module	Number of Modules	Ave. Unit Mass (kg)	Total Mass (kg)	Assembly	Assy Mass (kg)
HexBus Modules	280	13.9	3,886	Primary Array	7,812
Interconnects	1,674	1.0	1,674	Solar Reflector	1,566
HexFrame Structures	159	13.6	2,165	Primary Structure	1,997
TFRP Module	29	4.0	116	Connecting Truss	300
SPG Module	223	5.1	1,133	Propulsion & Att. Cntrl	354
WPT Module	217	12.0	2,604	Modular HexaBot	79
Propulsion & Attitude Control	6	10.0	60		
MPPR Arms	41	10.0	410		
Initial Propellant Load	6	10.0	60		
				Total Platform Hardware Mass (kg)	12,108

Prior to DRM_1, it may be useful to conduct in LEO smaller-scale precursor technology flight experiments and demonstrations (TFEs, and TFDs, respectively). For example, a very small-scale orbiter could be staged on a small expendable launch vehicle (ELV), piggybacked with another payload on a larger ELV, or staged from the International Space Station (ISS). Such precursor missions could be used to demonstrate the key functions of the PAA (Primary Array Assembly), such as the wireless power transmission from space to ground and solar power generation (SPG) module, as well as higher-risk platform capabilities, such as deployment of multiple HexFrame Structural Modules.

7.2.2 DRM_2: Moderate-Scale Integrated TFD in LEO

DRM_2, a moderate-scale demonstration in LEO, is envisioned as a “dress rehearsal” for the automated and tele-supervised deployment of large-scale solar power satellites in GEO. DRM_2 is defined to deliver 200 kW to receivers on Earth from a LEO operational orbit. It is not expected that DRM_2 will deliver commercially viable amounts of power; however, the space systems platform may have significant space applications (see Section 6).

DRM_2 Baseline. A baseline case for DRM_2 was defined by the study: DRM_2 Case 1 (D2/C1). The SPS-ALPHA platform in the D1/C1 case was modeled as involving an ellipsoid version of the Primary Structure Assembly (PSA), as described in Section 3, Sub-Section 3.5.3 and shown in Figure 7-3 as option A1. The baseline case involves a set of specific technology selections, including various technologies that are currently in use for

¹⁹ See Section 3 for the definition of the relationships among the modules and the Assemblies that comprise the SPS-ALPHA architecture.

other space applications. DRM_2 would also accommodate several TFEs addressing more advanced technologies (such as those that might be incorporated in the DRM_3 system). Table 7-3 immediately below presents the detailed mass statement for the D2/C1 system.²⁰

Table 7-3 Summary of Preliminary Mass Statement of SPS-ALPHA DRM_2 / Case_1

Mass Statement by Module				Mass Statement by Assembly	
Module	Number of Modules	Ave. Unit Mass (kg)	Total Mass (kg)	Assembly	Assy Mass (kg)
HexBus Modules	445	13.9	6,177	Primary Array	7,812
Interconnects	2,658	1.0	2,658	Solar Reflector	1,566
HexFrame Structures	214	7.0	1,498	Primary Structure	1,997
TFRP Module	35	2.0	70	Connecting Truss	300
SPG Module	337	5.1	1,703	Propulsion & Att. Cntrl	354
WPT Module	331	12.0	3,972	Modular HexaBot	79
Propulsion & Attitude Control	6	10.0	60		
MPPR Arms	57	10.0	570		
Initial Propellant Load	6	10.0	60		
				Total Platform Hardware Mass (kg)	16,768

7.2.3 DRM_3: Initial GEO TFD: a Sub-Scale Pilot Plant

The objective of DRM_3 would be to deploy and operate the first large, but still sub-scale integrated demonstration of SPS-ALPHA in GEO, with the capability to deliver solar power from space to premium and/or isolated markets on Earth. Two alternative cases for DRM_3 were defined, one (D3/C1 below) to deliver 2 MW, and the second (D3/C2 below) to deliver 18 MW to terrestrial markets from a GEO operational orbit.

DRM_3 Baseline. Two baseline options for DRM_3 were defined: (a) DRM_3 Case 1 (D3/C1), a smaller DRM_3 with a total delivered power of approximately 2 MW to Earth, and (b) DRM_3 Case 2 (D3/C2), a larger design reference mission with a total delivered power of approximately 18 MW to Earth. The SPS-ALPHA platform in the D3/C1 and D3/C2 cases were modeled as involving a Sigmoid-type version of the Primary Structure Assembly (PSA), as described in Section 3, Sub-Section 3.5.3 and shown in Figure 3-14 as option D1.

The two baseline cases involve the same set of specific technology selections; a subset of these is summarized in Section 8. Table 7-4 below presents the detailed mass statement for the D3/C1 system; a summary of the D3/C2 system mass statement is presented in Table 7-5 following.

Table 7-4 Summary of Preliminary Mass Statement of SPS-ALPHA DRM_3 / Case_1

Mass Statement by Module				Mass Statement by Assembly	
Module	Number of Modules	Ave. Unit Mass (kg)	Total Mass (kg)	Assembly	Assy Mass (kg)
HexBus Modules	2,365	24	57,062	Primary Array	222,362
Interconnects	14,178	1	14,178	Solar Reflector	1,001
HexFrame Structures	214	7	1,498	Primary Structure	2,047

²⁰ See Section 3 for the definition of the relationships among the modules and the Assemblies that comprise the SPS-ALPHA architecture.

TFRP Module	35	2	70	Connecting Truss	168
SPG Module	2,319	21	48,699	Propulsion & Att. Cntrl	6,850
WPT Module	2,269	47	106,643	Modular HexaBot	182
Propulsion & Attitude Control	50	16	800		
MPPR Arms	76	10	760		
Initial Propellant Load	50	58	2,900		
Total Platform Hardware Mass (kg)					232,610

Table 7-5 Summary of Preliminary Mass Statement of SPS-ALPHA DRM_3 / Case_2

Mass Statement by Module				Mass Statement by Assembly	
Module	Number of Modules	Ave. Unit Mass (kg)	Total Mass (kg)	Assembly	Assy Mass (kg)
HexBus Modules	10,301	24	248,738	Primary Array	972,062
Interconnects	61,782	1	61,782	Solar Reflector	20,679
HexFrame Structures	552	55	30,130	Primary Structure	26,559
TFRP Module	113	80	9,040	Connecting Truss	2,688
SPG Module	10,019	21	210,399	Propulsion & Att. Cntrl	22,900
WPT Module	9,919	47	466,193	Modular HexaBot	364
Propulsion & Attitude Control	100	36	3,600		
MPPR Arms	237	10	2,370		
Initial Propellant Load	100	130	13,000		
Total Platform Hardware Mass (kg)					1,045,252

As presented in Tables 7-4 and 7-5, DMR_3 would be roughly the same mass as the ISS, but would be based in GEO rather than LEO, and (see below) should be dramatically lower in cost. Also, because the transmitter in GEO for both cases (at 2.45 GHz) is relatively small compared to the standard 1,000 m diameter, the area on Earth over which the RF beam will be spread must be quite large. Determination of the actual power received will require additional, more detailed analysis.

7.2.4 DRM_4: First Solar Power Satellite in GEO

DRM_4 would be the first “full-scale” SPS in GEO. DRM_4 was defined to deliver 500 MW to terrestrial markets from a GEO operational orbit with the expectation that the cost per kilowatt-hour will be considerably higher than the target for commercial baseload power.

DRM_4 Baseline. A single baseline case for DRM_4 was defined by the study: DRM_4 Case 1 (D4/C1). Figure 7-1 presents a summary graphic of the mass breakdown for D4/C1 according to the various assemblies that would comprise the systems. See Table 7-6 for a summary of the detailed mass statement of the D4/C1 case.

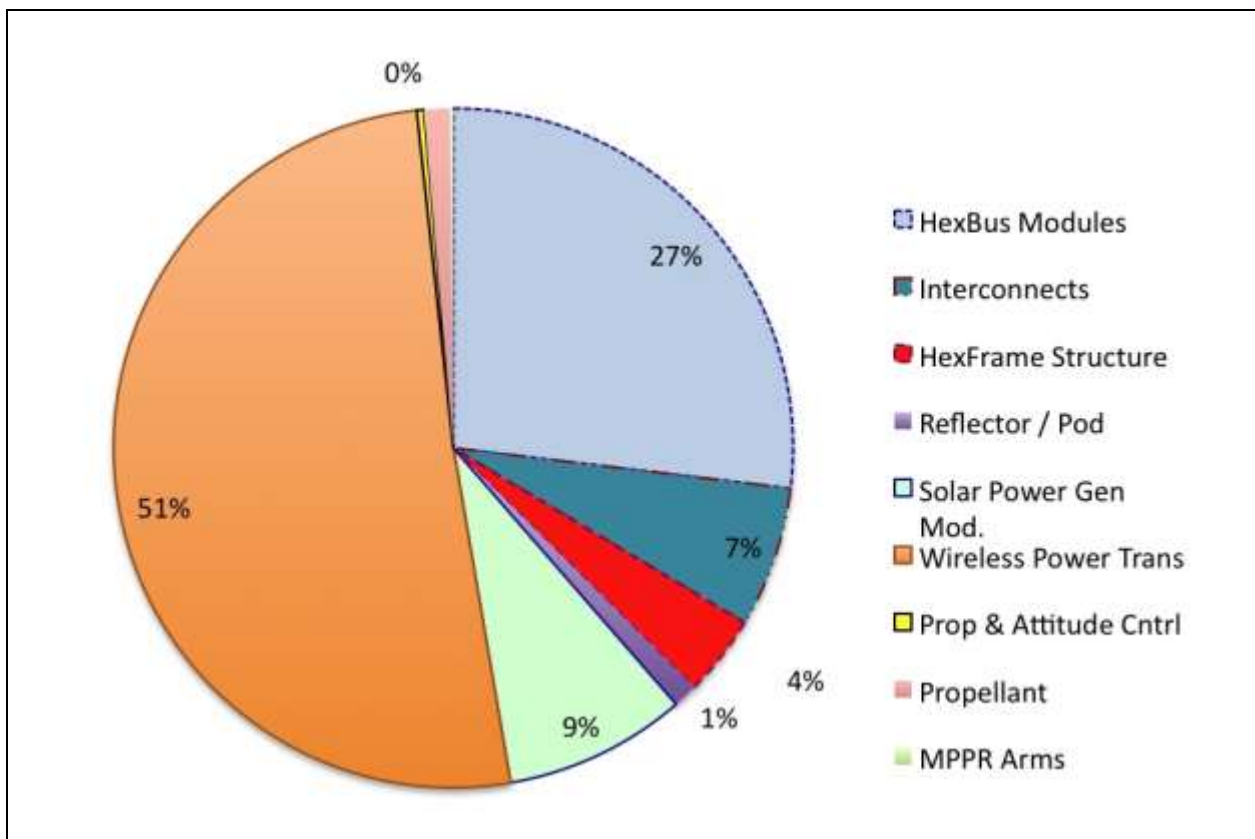

Figure 7-1 Pie Chart Graphic of the D4/C1 Baseline Mass Breakdown (by Module)

Table 7-6 Summary of Preliminary Mass Statement of SPS-ALPHA DRM_4 / Case_1

Mass Statement by Module				Mass Statement by Assembly	
Module	Number of Modules	Ave. Unit Mass (kg)	Total Mass (kg)	Assembly	Assy Mass (kg)
HexBus Modules	131,808	24	3,172,795	Primary Array	10,873,795
Interconnects	790,722	1	790,722	Solar Reflector	313,250
HexFrame Structures	8,360	54	452,540	Primary Structure	351,350
TFRP Module	1,750	79	138,250	Connecting Truss	62,400
SPG Module	128,127	8	1,025,016	Propulsion & Att. Cntrl	192,600
WPT Module	127,927	47	6,012,569	Modular HexaBot	1,876
Propulsion & Attitude Control	200	195	39,000		
MPPR Arms	2,078	10	143,600		
Initial Propellant Load	200	718	20,779		
Total Platform Hardware Mass (kg)					11,795,271

The SPS-ALPHA platform in the D4/C1 case was modeled with a Sigmoid-type version of the PSA, as described in Section 3, Sub-Section 3.5.3 and shown in Figure 3-14 as option D1. The baseline case involves the set of specific technology selections discussed in Section 8.

7.2.5 DRM_5: Recurring Integrated GEO SPS-ALPHA for Commercial Markets

Following the first full-scale SPS and incorporating a range of technology innovations validated as TFEs during DRM_4, recurring SPS-ALPHA platforms – designated as “DRM_5” – would be deployed. These would involve larger platforms, and the delivery of greater power levels than those involved in DRM_4. DRM_5 was defined to deliver 2,000 MW (2 GW) to terrestrial markets from a GEO operational orbit. The objective of DRM_5 is to deliver power to commercial baseload markets at a competitive price.

DRM_5 Baseline. A baseline case for DRM_5 was defined by the study: DRM_5 Case 1 (D5/C1). Figure 7-2 presents a summary breakdown of this DRM by Module type. See Table 7-6 for the detailed characteristics of the D5/C1 case. The SPS-ALPHA platform in the D5C1 case was modeled with a Sigmoid-type version of the PSA, as described in Section 3, Sub-Section 3.5.3 and shown in Figure 7-2 as option D1. The D5/C1 baseline case involves the set of specific technology selections summarized in Section 8.

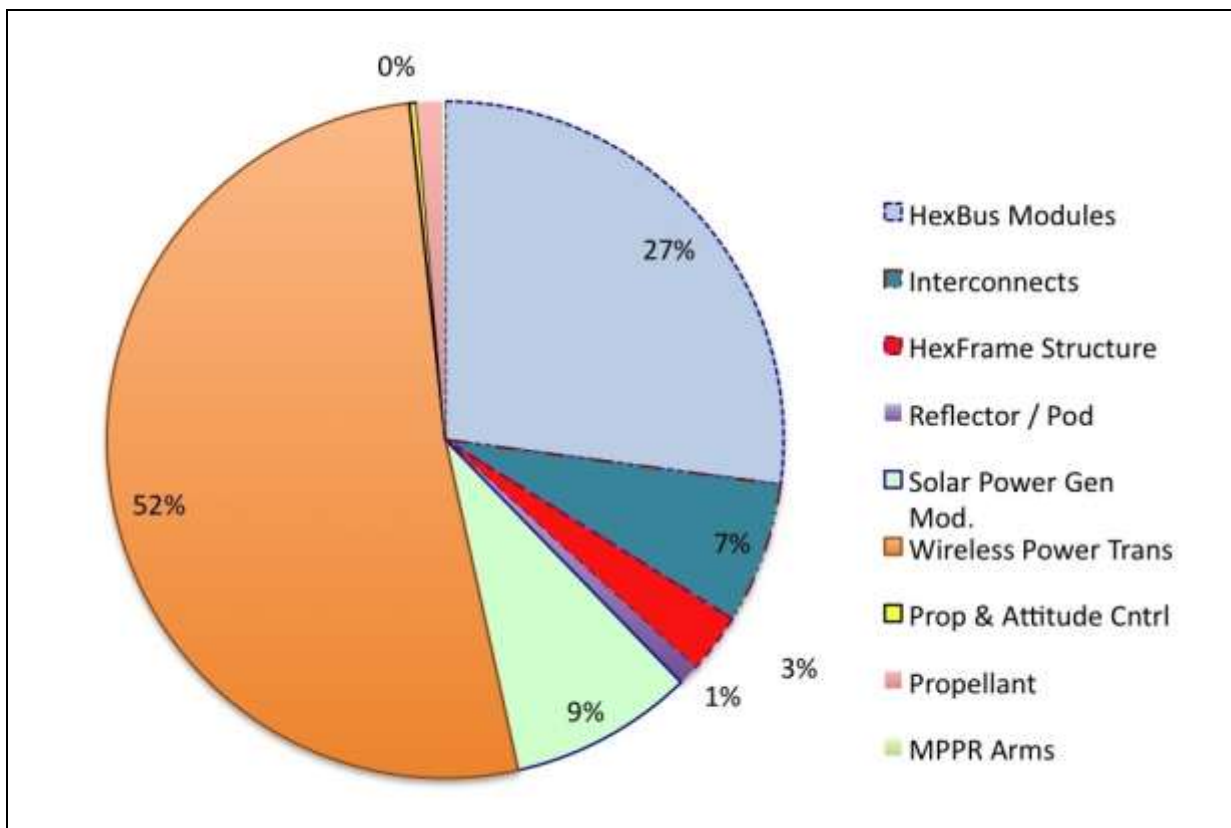

Figure 7-2 Pie Chart Graphic of the D5/C1 Baseline Mass Breakdown (By Module Type)

In addition, a variety of detailed sensitivity studies were performed as part of the project’s systems analysis work package. The starting point for these sensitivity studies was DRM_5 / Case_4 which involved the incorporation of several technology improvements over the baseline case described here. These involved modest reductions in specific mass (i.e., improving on the baseline use of Aluminum for HexBus structural materials), improvements in the conversion efficiency for the SPG module, etc. The sensitivity studies are discussed in sub-Section 5.3.

Table 7-7 Summary of Preliminary Mass Statement of SPS-ALPHA DRM_5 / Case_1

Mass Statement by Module				Mass Statement by Assembly	
Module	Number of Modules	Ave. Unit Mass (kg)	Total Mass (kg)	Assembly	Assy Mass (kg)
HexBus Modules	392,341	24	9,438,210	Primary Array	32,590,615

Interconnects	2,353,662	1	2,353,662	Solar Reflector	770,595
HexFrame Structures	18,444	54	1,002,186	Primary Structure	833,649
TFRP Module	4,305	79	340,095	Connecting Truss	62,400
SPG Module	383,619	8	3,068,952	Propulsion & Att. Cntrl	551,000
WPT Module	383,419	47	18,020,693	Modular HexaBot	5,623
Propulsion & Attitude Control	200	578	115,600		
MPPR Arms	4,888	10	48,884		
Initial Propellant Load	200	2,128	425,600		
				Total Platform Hardware Mass (kg)	34,813,882

7.3 SPS-ALPHA Sensitivity Study Results

There are an almost infinite variety of different sensitivity studies that might be conducted concerning the various FOMs for the different technologies for the various SPS-ALPHA design reference missions. Given the constraints of time and resources, only a handful have been included in the current project. The majority of the sensitivity studies have been performed using DRM_5's baseline case (D5/C1) as the starting point – i.e., the fully commercial, recurring SPS-ALPHA case @ 2 GW power delivered to terrestrial markets.

The sensitivity studies have been chosen for the purpose of illuminating the importance (or lack of importance) of various technology / functional areas in the SPS-ALPHA system; the areas that have been explored involve: (1) structural mass and materials; (2) DC-RF conversion efficiency in the WPT system; (3) WPT mass per unit area; and (4) variations in the concentration ratio for the system that would be enabled by changes in device materials choices that might enable the higher operating temperatures that would result from higher concentration.

7.3.1 DRM_5 / Sensitivity Study 1: Variation of Structural Materials Density & Mass

The first sensitivity study that was performed examined the variations in overall DRM_5 platform mass for variations in the density of selected structural materials, assuming fixed structural performance (e.g., bending moments, vibration propagation, etc.). The materials chosen for variation were those involved in the structure of the HexBus Modules (kg/m³), and those for the HexFrame Structural Modules (kg/m). Figure 7-3 below presents the results of a series of five cases that were examined in which the FOMs were varied from a baseline (in the case of the HexBus structure this was Aluminum) by a given percentage difference.

Generally speaking, because the structural systems examined are a relatively small fraction of the total mass and cost of the SPS-ALPHA platform, even relatively deep reductions (e.g., by 50%) in the assumed density of those materials results in a relatively modest (15%) reduction in the overall mass of the platform. However, even this modest percentage reduction represents a savings of some 5,000 tons in platform mass and roughly 10,000 tons in launched mass (when in space propellant requirements are taken into account). This is a huge savings; and as a result advances in space structures and materials is a prior for future R&D efforts.

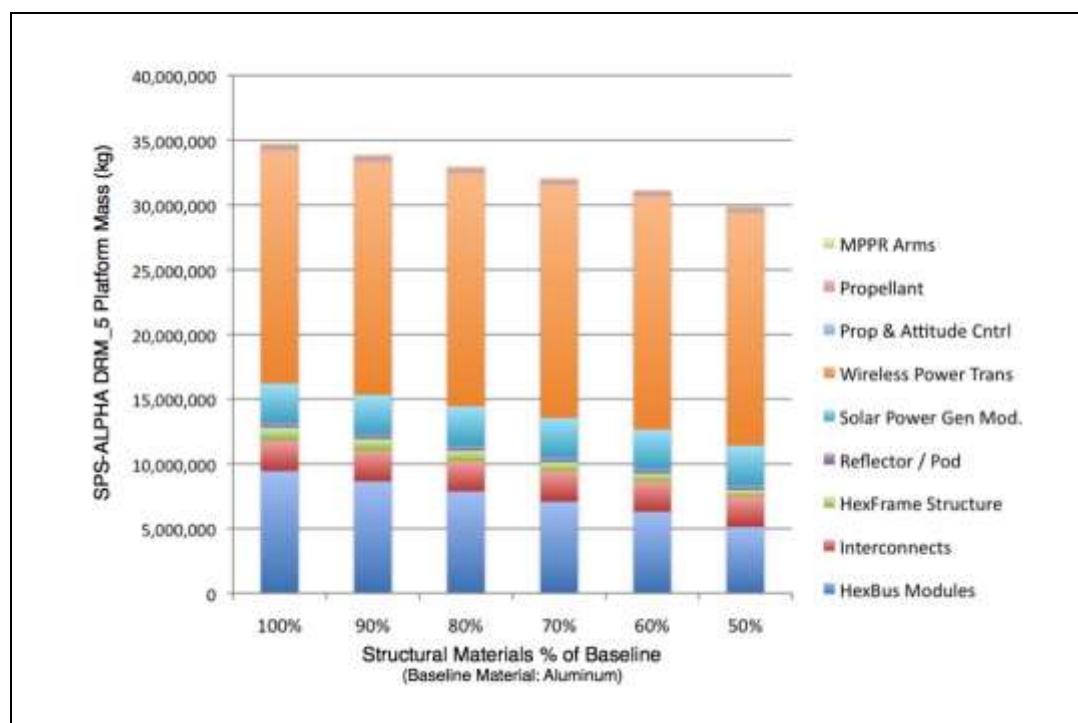

Figure 7-3 Impact of Variations in the Mass of Structural Materials (D5/S1)

7.3.2 DRM_5 / Sensitivity Study 2: Variation of WPT DC-RF Conversion Efficiency

This sensitivity study examined the consequences of varying the efficiency with which the WPT system converted DC power input into RF power output. This variation was performed while holding fixed the power delivered to Earth and the concentration ratio for the platform (reflectors to PAA), hence resulting in decreasing power required for the same amount of RF power output – in turn leading to reduced mass for the platform.

Please note that for all of the DRM case studies the estimates of the number of MHA assemblies required are quite preliminary. Future studies must address this topic in greater detail and will require more in-depth formulation of a CONOPS and implementation of operational simulations to refine those estimates. However, as shown in Figure 7-4, even if the estimated number of MHA units were increased significantly, this Assembly would remain a small fraction of the total mass. (And, owing to the strategy of building assembly and maintenance robots from modules – such as the Hexbus – that are used elsewhere in the SPS-ALPHA platform, the MHA’s should remain a small contributor to overall cost.)

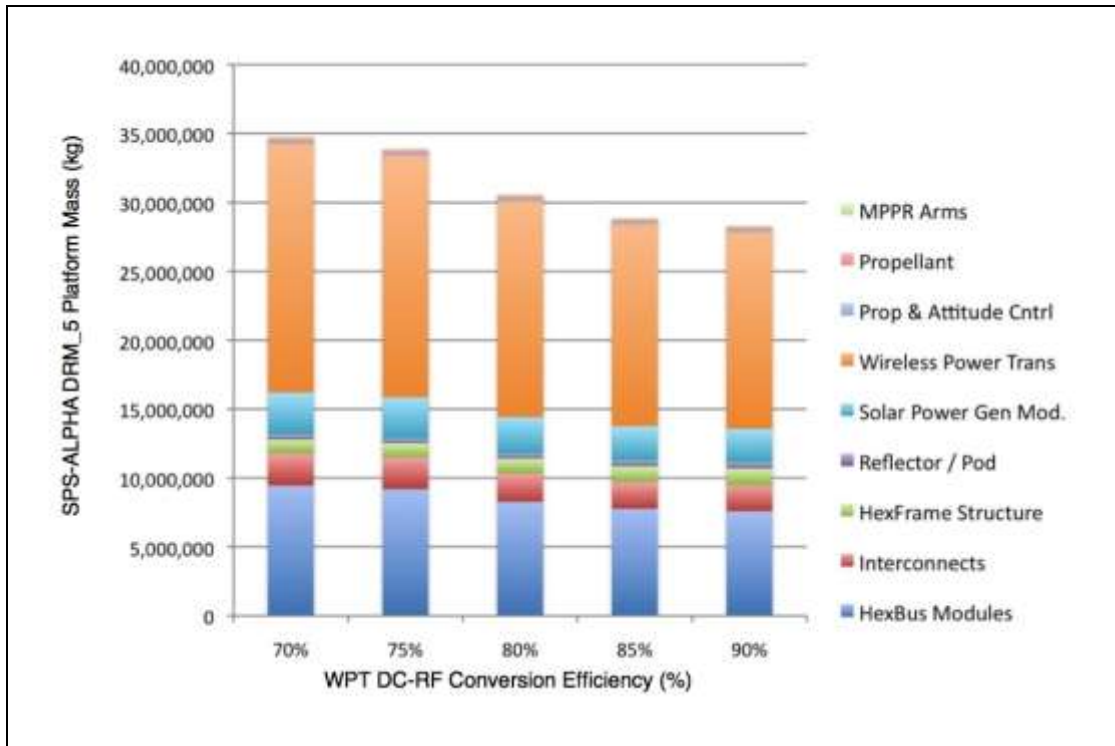

Figure 7-4 Impact of Variations in the DC-RF Conversion Efficiency (D5/S2)

7.3.3 DRM_5 / Sensitivity Study 3: Variation of WPT Areal Mass

As can be seen from Figure 7-5, the PAA is by far the most massive Assembly within the SPS-ALPHA platform, and the WPT module the most massive element of the PAA. DRM_5 Sensitivity Study 3 (D5/S3) examined the effect of variations in the mass per unit area of the WPT modules within the PAA, holding all other parameters constant. As before, the concentration ratio was held fixed, as was the total power delivered to the receiver on Earth.

7.3.4 DRM_5 / Sensitivity Study 4: Variation of Concentration Ratio

DRM_5 Sensitivity Study 4 (D5/S4) examines the potential benefit (at the architecture level) of introducing novel materials and devices that can operate with performance degradation at significant higher temperatures than can devices (and the materials of which they are fabricated) available at this time. This question was examined by means of architecture level changes that would result from allowing the concentration ratio to increase (which would increase the temperature at the PAA. These results are highly preliminary, but very suggestive for the prioritization of future technology R&D. See Figure 7-6 for a summary of these initial results.

For example, they show that increasing the concentration ratio from 3-to-1 to 5-to-1 would reduce the SPS-ALPHA platform mass by almost 15,000 tons – a remarkable result.

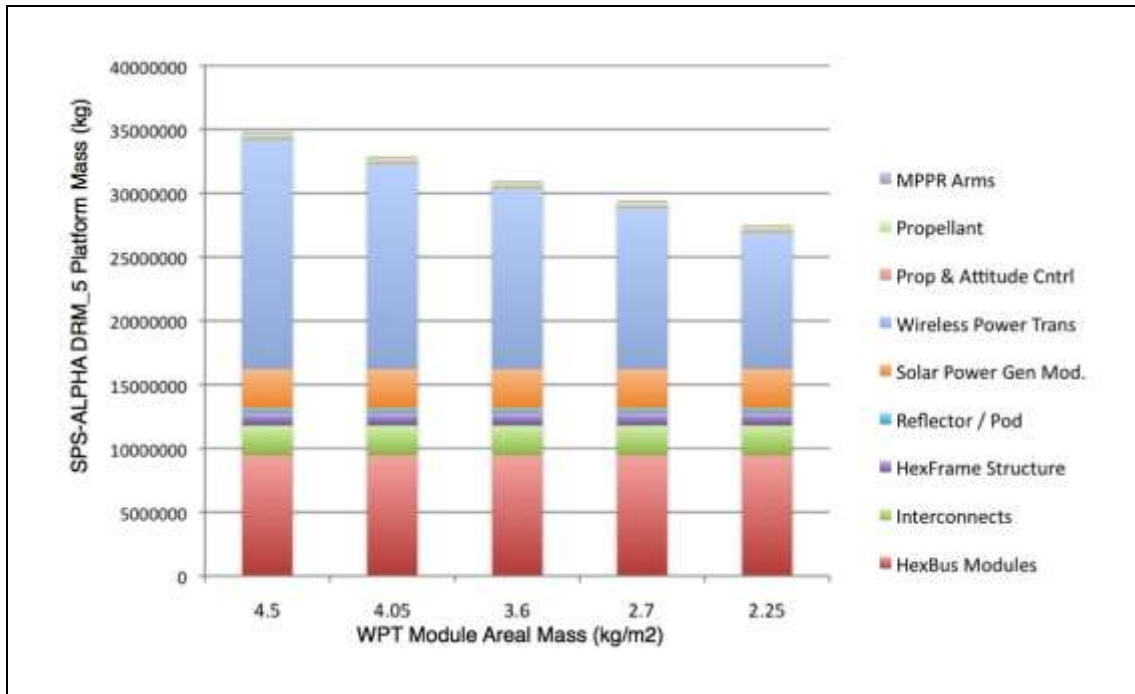

Figure 7-5 Impact of Variations in the Areal Mass of the WPT Modules (D5/S3)

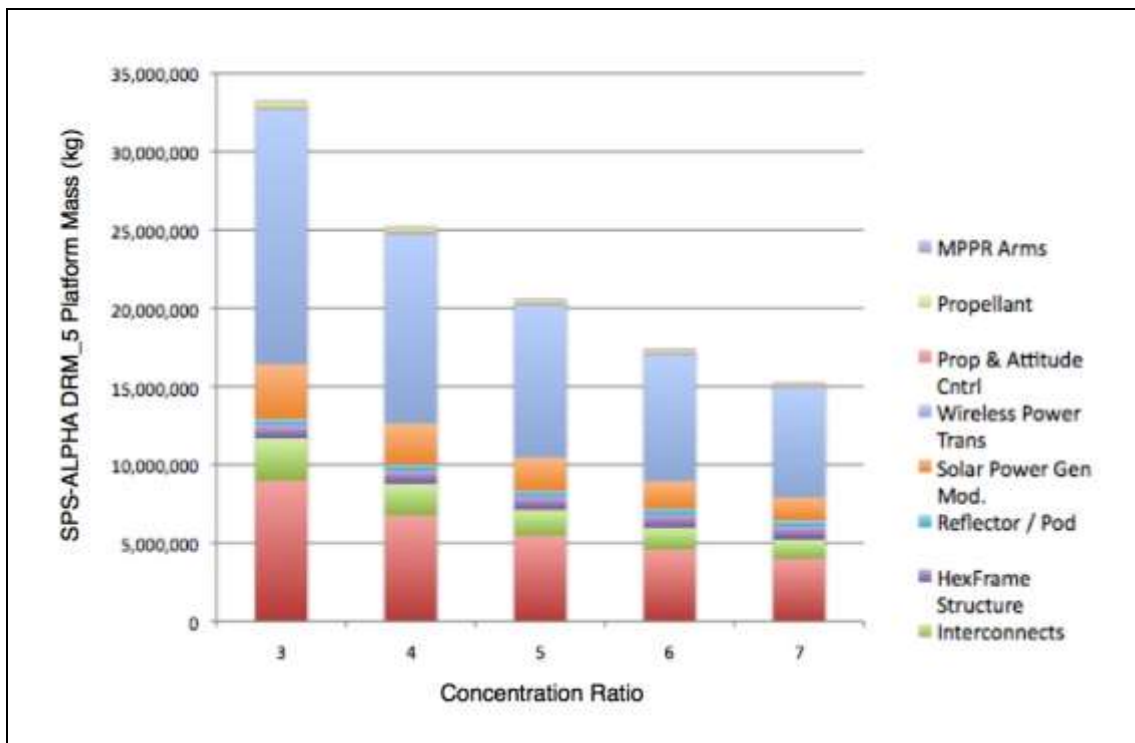

Figure 7-6 Impact of Variations in the Concentration Ratio (D5/S4)

7.3.5 DRM_3 / Sensitivity Study 1: Variation of SPG Efficiency and Specific Mass

The final sensitivity study performed involved varying solar power generation efficiency and specific mass. The SPS-ALPHA platform that was used as the baseline was DRM_3/Case_2 (the larger DRM_3). As before, the concentration ratio was held fixed, as was the total power delivered to Earth. As can be seen from Figure 7-7, varying the SPG technology has a significant impact on overall platform mass. This is due to the change in PAA mass per unit area, as well as changes in the required reflector systems to provide sunlight to the SPG.

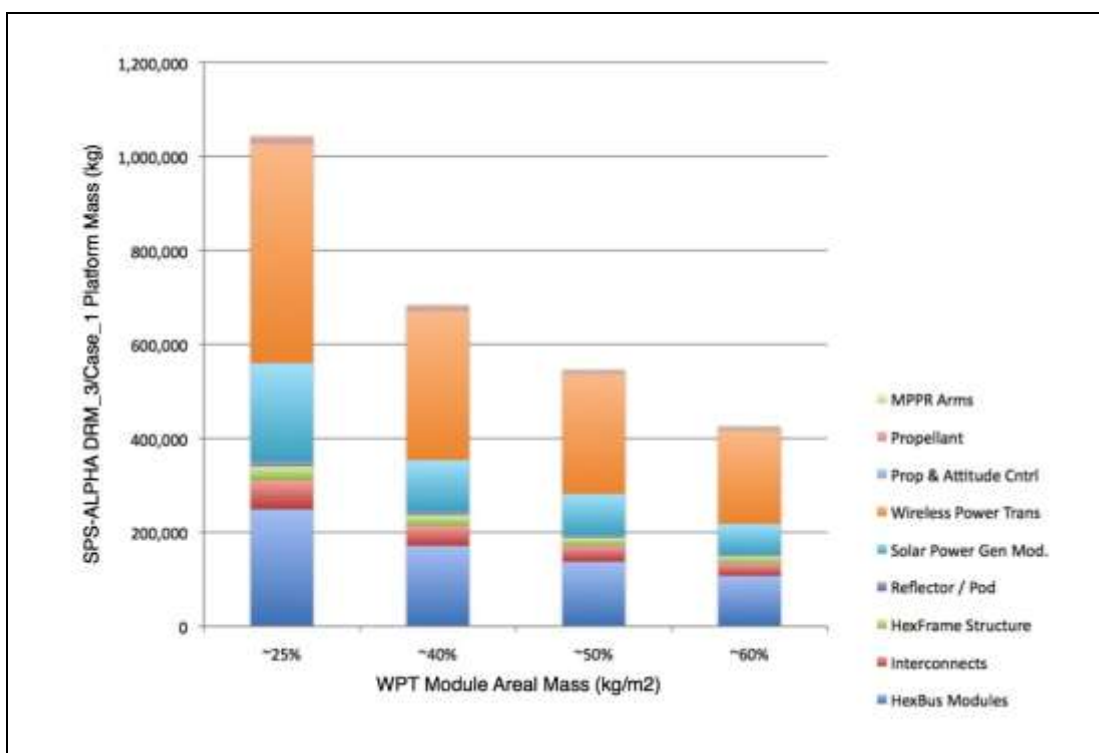

Figure 7-7 Impact of Variations in the Solar Power Generation Technology Ratio ($D3/S1$)

7.4 SPS-ALPHA Macroeconomics Results

7.4.1 Market Forecast and Analysis

An preliminary market forecast was developed and analyzed as a part of the SPS-ALPHA NIAC Phase 1 project, focusing on commercial terrestrial base load energy markets for the SPS-ALPHA based solar power satellite, but including ancillary markets including secondary terrestrial power markets, as well as prospective space applications of the SPS-ALPHA architecture, systems and technologies. These results are presented in Sections 5 and 6.

The integrated results of this forecast form the framework for the macroeconomic assessment that was developed, and which is presented in the paragraphs that follow.

7.4.2 Analysis & Cost Estimation Approach

Five major SPS-ALPHA system cost components have been identified; these included (1) hardware manufactured cost (including both initial hardware and spares / replacements over the life of the platform), (2) space transportation cost – Earth-to-Orbit; (3) space transportation cost – in-space transportation; (4) ground receiver cost; and (5) operations and maintenance (O&M) costs.

Hardware Manufactured Cost Estimation. As described previously, SPS-ALPHA hardware cost estimation has been performed using a mass-based CER approach at the module level, with the application of a learning curve or manufacturing curve (LC/MC). Figure 7-8 illustrates several aerospace systems examples, plotting historical data for the unit production quantity and the cost per kilogram. Figure 7-9 presents the same data, plotted on a partial log scale.

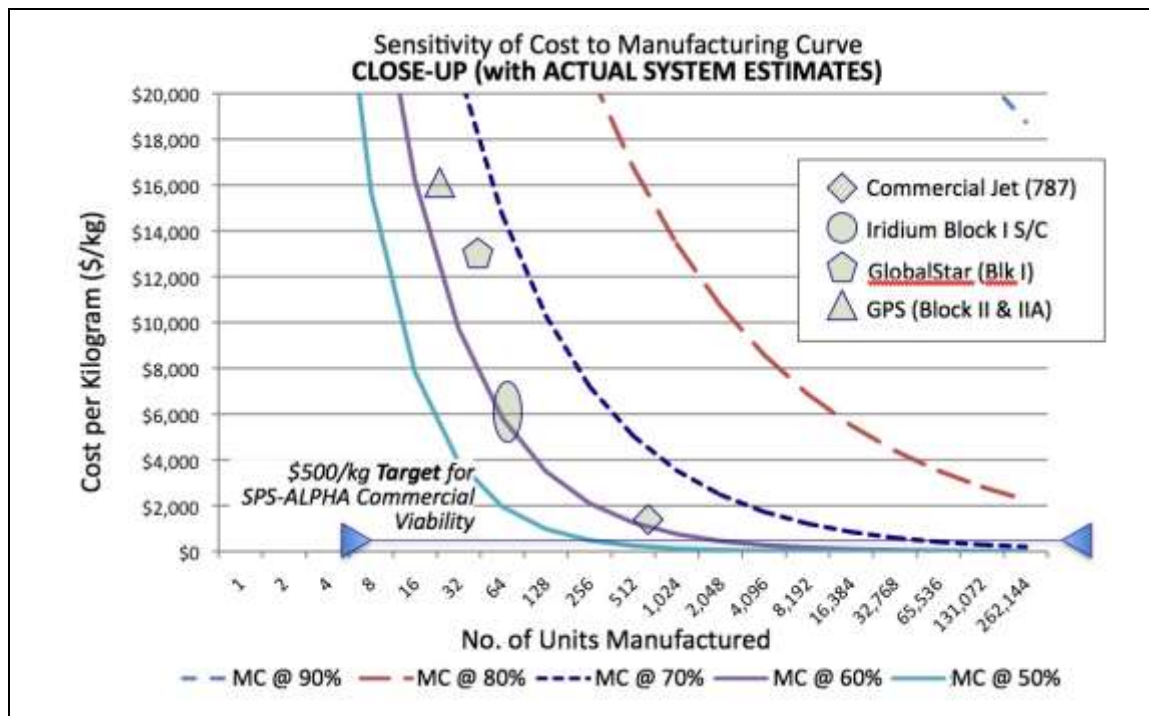

Figure 7-8 Placement of Selected Aerospace Examples in the Context of Generic Learning Curves

For the cases shown (ranging from Global Position Satellites (GPS) to a Boeing 787 commercial jet aircraft), the experience curve (LC/MC) falls roughly between the values of 60% and 70%. On this basis, the project assumed an LC/MC of about 66% for SPS-ALPHA module cost estimation.

The assumption in inferring the LC/MC values in Figure 7-8 is that the initial CER is \$250,000 per kilogram. If the initial CER is much greater, then the true LC/MC must be even greater than about 60%, for the cost per kilogram observed; alternatively if the initial CER is much lower, then the LC/MC may be somewhat greater than 60%. Also, It is interesting to note that the observed LC/MC value for the Boeing 787 aircraft case is a bit greater than 60%, as compared to the first documented case of the LC/MC in the literature (Wright’s 1936 paper, previously cited), which documented a “progress curve” of some 80%.

The detailed hardware cost estimation results are presented in the tables on the pages that follow. The primary emphasis of detailed cost estimation has been on the manufactured hardware costs, as described above. The other cost components, described below, were treated only at a very high level.

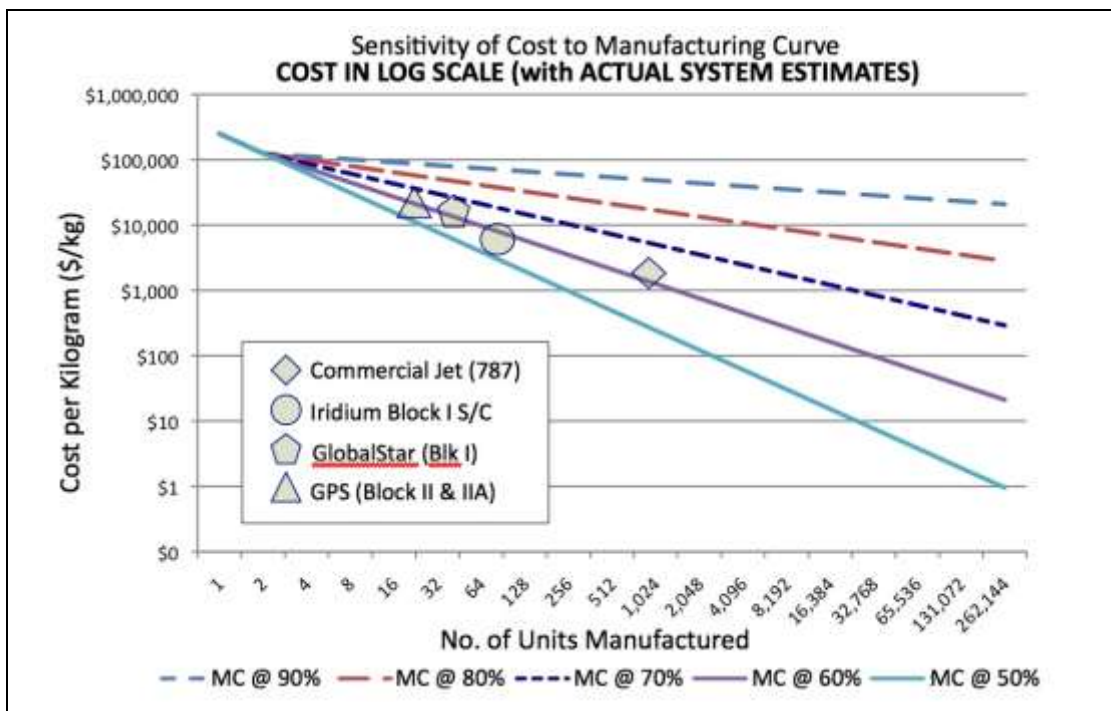

Figure 7-8 Placement of Selected Aerospace Examples in the Context of Generic Learning Curves (Log Scale)

Space Transportation Cost Estimates. The two major components of the space transportation costs, ETO transport and in-space transport are in themselves topics requiring detailed study. In line with the resources available for the NIAC Phase 1 study, only a very superficial set of CERs for cost estimation was assumed for space transportation, based for the nearer-term case on recent publicly announced launch prices. These are summarized in Table 7-9, below.

Note that the underlying assumption for the in-space transportation CERs is that the transportation system is reusable, and highly fuel-efficient (e.g., such as solar electric propulsion), such that the ETO cost of the fuel sets the price cost of the in-space transportation.

Table 7-9 Space Transportation CERs

	ETO Transportation (\$/kg)	In-Space Transportation (\$/kg)
SPS-ALPHA Technology Demos in LEO	\$3,500 / kg	N/A
SPS-ALPHA Pilot Plant Demos in GEO	\$1,500 / kg	\$1,500 / kg
Full-Scale SPS-ALPHA in GEO	\$ 500 / kg	\$ 500 / kg

Ground Receiver Cost Estimates. The costs of the ground rectenna receiver for the SPS cases were estimated based on a simple CER of \$10 per m².

Operations & Maintenance Cost Estimates. O&M comprises two major cost components, the cost of labor and the cost of hardware required for unexpected spares and pre-planned maintenance replacements. The cost of hardware for spares and replacements on the SPS platform were accounted for as part of the hardware cost estimation, described above, with an estimated annual repair and maintenance requirement of 3% of the overall mass of the platform per year. The costs of ground operations were estimated (very roughly) as 1% /year of the

total value of the IOC SPS-ALPHA platform hardware. Finally, in addition to the above, a fixed annual program / operations cost of \$5M per year was assumed.

All of the above are topic areas that require additional definition and more detailed assessment in the context of space solar power business case analyses.

7.4.3 Cost Estimation Results - Examples

The following tables present a series of specific hardware manufacturing cost estimation example results for the five (5) different SPS-ALPHA design reference missions (DRMs).

Table 7-10 DRM_1 / Case_1 Hardware Cost Estimation Results (30 kW @ Earth)

Sensitivity Outputs	Initial CER (\$/kg)	Unit Mass (kg)	Number of Modules	Total Mass (MT)	Final CER (\$/kg)
HexBus Modules	\$250,000	14	280	3.9	\$4K-\$6K
Interconnects	\$250,000	1	1,674	1.7	\$2K-\$3K
HexFrame Structure	\$50,000	14	159	2.2	\$1K-\$2K
Reflector / Pod	\$100,000	4	29	0.1	~\$9K
Solar Power Gen Mod.	\$250,000	5	223	1.1	~\$6K
Wireless Power Trans	\$250,000	12	217	2.6	~\$6K
Prop & Attitude Cntrl	\$250,000	10	6	0.1	\$50K-\$80K
MPPR Arms	\$250,000	10	41	0.4	\$15K-\$22K
0.5-Year Propellant Load	\$10,000	10	6	0.1	~\$2K
Totals	N/A	N/A	~ 2,500	12.1	N/A

Table 7-11 DRM_2 / Case_1 Hardware Cost Estimation Results (200 kW @ Earth)

Sensitivity Outputs	Initial CER (\$/kg)	Unit Mass (kg)	Number of Modules	Total Mass (MT)	Final CER (\$/kg) ²¹
HexBus Modules	\$250,000	14	445	6.2	\$4K-\$6K
Interconnects	\$250,000	1	2,658	2.7	\$1K-\$2K
HexFrame Structure	\$50,000	7	214	1.5	\$1K-\$2K
Reflector / Pod	\$100,000	2	35	0.1	~\$9K
Solar Power Gen Mod.	\$250,000	5	337	1.7	\$4K-\$6K
Wireless Power Trans	\$250,000	12	331	4.0	\$4K-\$6K
Prop & Attitude Cntrl	\$250,000	10	6	0.1	\$30K-\$50K
MPPR Arms	\$250,000	10	57	0.6	\$9K-\$14K
0.5-Year Propellant Load	\$10,000	10	6	0.1	\$1K-\$2K
Totals	N/A	N/A	~ 4,000	16.8	N/A

Table 7-12 DRM_3 / Case_1 Hardware Cost Estimation Results (18 MW @ Earth)

Sensitivity Outputs	Initial CER (\$/kg)	Unit Mass (kg)	Number of Modules	Total Mass (MT)	Final CER (\$/kg)
HexBus Modules	\$250,000	24	10,301	248.7	~\$500-\$700
Interconnects	\$250,000	1	61,782	61.8	\$200 ²²
HexFrame Structure	\$50,000	55	552	30.1	~\$800
Reflector / Pod	\$100,000	80	113	9.0	~\$4K
Solar Power Gen Mod.	\$250,000	21	10,019	210.4	~\$500-\$700
Wireless Power Trans	\$250,000	47	9,919	466.2	~\$500-\$700
Prop & Attitude Cntrl	\$250,000	36	100	3.6	~\$9K
MPPR Arms	\$250,000	10	237	2.4	~\$6K
0.5-Year Propellant Load	\$10,000	130	100	13.0	\$400
Totals	N/A	N/A	~ 110,000	1,045.3	N/A

Table 7-14 DRM_4 / Case_1 Hardware Cost Estimation Results (500 MW @ Earth)

²¹ Note that in the integrated macroeconomic scenarios that are examined later, DRM_5 follows DRM_4, which follows DRM_3 and so on. In these scenarios, the total number of units manufactured is used as the basis for the CER (not just the number of units in a single DRM). This “total number of units” approach is reflected in the tables above.

²² No CER below \$200/kg for hardware was allowed, despite the calculation based on the LC/MC, with the assumption that basic component/materials cost “floors” will apply. This CER is approximately consistent with other high technology consumer products (e.g., PCs, tablet computers), mass-produced, but computing intensive machinery (e.g., automobiles), etc.

Sensitivity Outputs	Initial CER (\$/kg)	Unit Mass (kg)	Number of Modules	Total Mass (MT)	Final CER (\$/kg)
HexBus Modules	\$250,000	24	131,808	3,172.8	~\$200
Interconnects	\$250,000	1	790,722	790.7	~\$200
HexFrame Structure	\$50,000	54	8,360	452.5	~\$300
Reflector / Pod	\$100,000	79	1,750	138.3	\$2K
Solar Power Gen Mod.	\$250,000	8	128,127	1,025.0	~\$200
Wireless Power Trans	\$250,000	47	127,927	6,012.6	~\$200
Prop & Attitude Cntrl	\$250,000	195	200	39.0	~\$6K
MPPR Arms	\$250,000	10	2,078	20.8	~\$1K-\$2K
0.5-Year Propellant Load	\$10,000	718	200	143.6	~\$250
Totals	N/A	N/A	~ 1,200,000	11,795.3	N/A

Table 7-15 DRM_5B / Case_4B Hardware Cost Estimation Results (2 GW @ Earth)

Sensitivity Outputs	Initial CER (\$/kg)	Unit Mass (kg)	Number of Modules	Total Mass (MT)	Final CER (\$/kg)
HexBus Modules	\$250,000	20	337,330	6,770.6	~\$200
Interconnects	\$250,000	1	2,023,650	2,023.7	~\$200
HexFrame Structure	\$50,000	43	19,878	856.9	~\$200
Reflector / Pod	\$100,000	79	4,662	368.3	\$400
Solar Power Gen Mod.	\$250,000	8	327,891	2,623.1	~\$200
Wireless Power Trans	\$250,000	37	327,691	12,124.6	~\$200
Prop & Attitude Cntrl	\$250,000	472	200	94.4	~\$6K
MPPR Arms	\$250,000	10	5,190	51.9	~\$700-\$1K
0.5-Year Propellant Load	\$10,000	1,737	200	347.4	~\$250
Totals	N/A	N/A	~ 3,000,000	25,260.8	N/A

7.4.4 Macroeconomic Analysis Results

Overall, the evaluation of the potential economic feasibility of the SPS-ALPHA concept has resulted in a positive result: it appears that a mature, large-scale solar power satellite based on the SPS-ALPHA architecture can deliver power to the terrestrial energy markets for prices of less than 10¢/kW-hr.

Table 7-16 presents some selected detailed modeling results for three of the larger of the five DRMs that have been examined by the study: DRM_3 (the Pilot Plant), DRM_4, (the first full-scale SPS), and DRM_5 / Case_4B (the recurring full-scale SPS for commercial markets with advanced technology).

Table 7-16 SPS-ALPHA System Analysis Selected Preliminary Results

Parameters	DRM 3 / Case 1 (SPS-ALPHA Pilot Plant, with Minimal Tech Advances)	DRM 4 / Case 1 (First Full-size SPS, with Minimal Tech Advances)	DRM 5 / Case 4B (Recurring SPS, with Aggressive Tech Advances)
Power Delivered to Earth	18 MW	500 MW	2,000 MW
WPT Transmission Freq.	2.45 GHz	2.45 GHz	2.45 GHz
Solar Power Gen. Efficiency	25% BOL	48% BOL	60% BOL
WPT Efficiency	70% (DC-to-RF)	70% (DC-to-RF)	80% (DC-to-RF)
ETO Cost (\$/kg)	\$1,500/kg	\$500/kg	\$500/kg
Cost to First Power (estimated at Earth)	~\$ 4.5 B (~\$250 per Watt)	~\$ 12.2 B (~\$24 per Watt)	~\$ 31 B (~\$16 per Watt)
Lifetime	10 years	Indefinite; > 30 years (with Maintenance and Spares)	Indefinite; > > 30 years (with Maintenance and Spares)
Levelized Cost of Electricity (LCOE; \$/kW-hour)	~ \$3.26 per kW-hr	~ 15¢ per kW-hr	~ 9¢ per kW-hr

Note that DRM_3 to DRM_5 are GEO based SPS (at ~35,800 km altitude), whereas DRM_1 and DRM_2 are LEO based (~900 km, sun synchronous orbit). Each of the cases described in Table 7-16 assumes a lifetime per module of approximately 20 years, and a time between refueling of 5 years. The overall period of economic interest of the ongoing SPS platform described as DRM_5 (including annual refurbishments) is 45 years. In addition, for purposes of this preliminary analysis, transportation costs have been roughly estimated at \$500/kg for Earth-to-orbit transport and \$500/kg for in-space transport from LEO to GEO.

On the following page, Figure 7-10 presents the integrated economic results for DRM_1, DRM_2 and DRM_3, in terms of the net finances (cost versus income) for each of these three missions. Note that in these economics, no ancillary sales are shown of the DRM_2 version of the SPS-ALPHA platform for space applications.

Figure 7-11 presents a long-term view of all five (5) SPS-ALPHA study DRMs, including the advanced technology version of DRM_5 / Case_4B. Of course, the strategic financial benefits of development solar power satellites will not be realized by deploying only one or two full-scale platforms. Figure 7-12 presents a “grand-scale” macro-economic view of the SPS-ALPHA with a total capacity of 100 GW of employed terrestrial power, implemented over the next 100 years with a LCOE of less than 9¢/kW-hr. Note that in this figure, no additional technology improvements are included for the platform beyond the D5/C4B case, or for supporting space infrastructures.

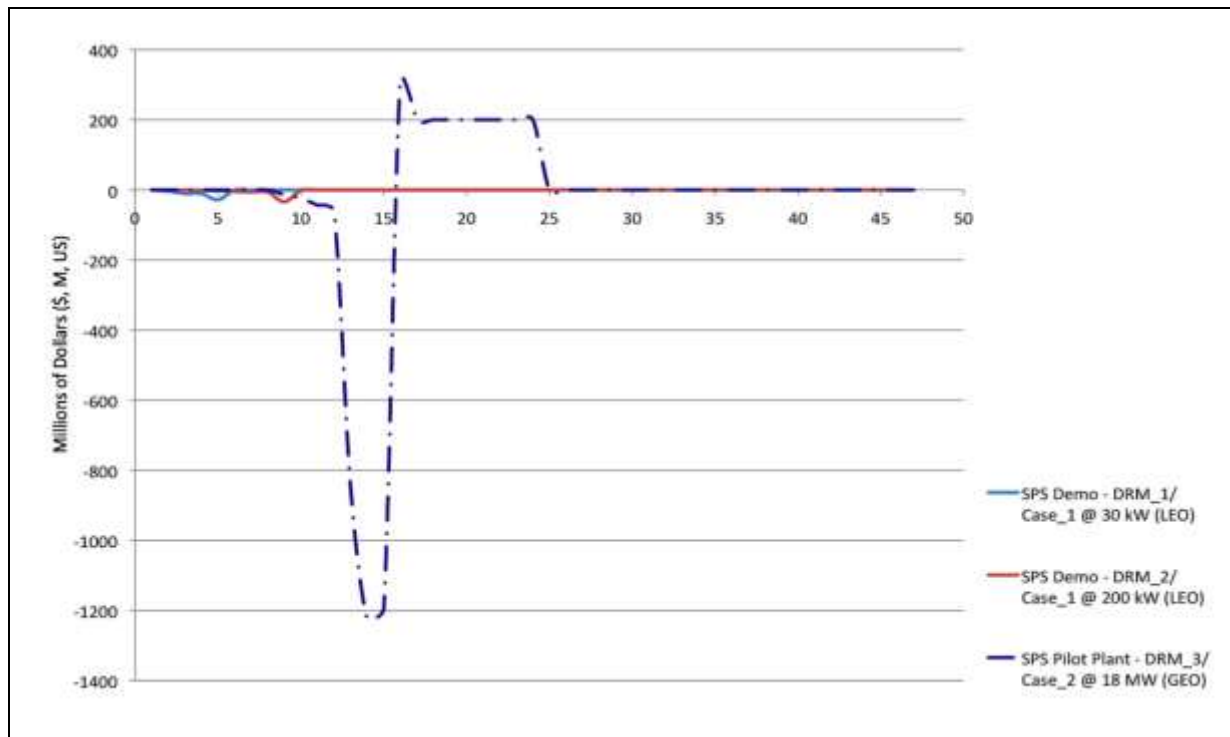

Figure 7-10 Integrated Macroeconomic Results for DRM 1, 2 and 3

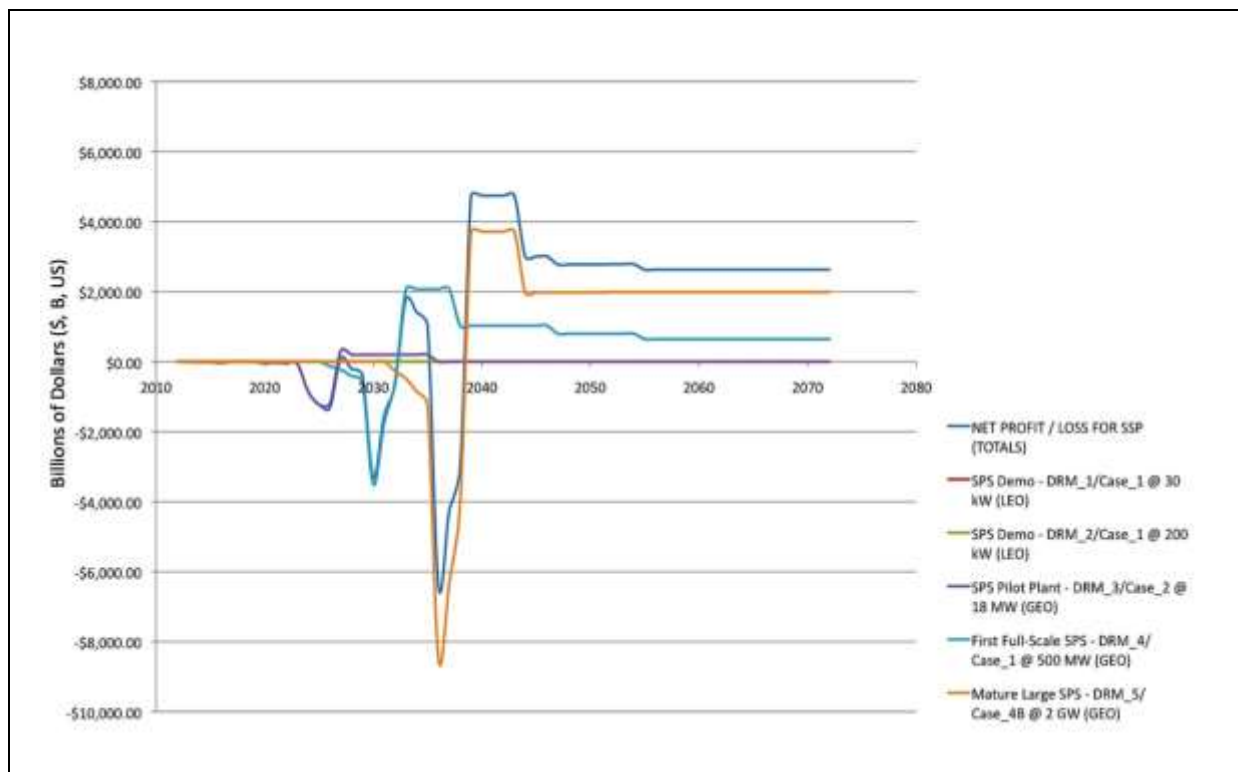

Figure 7-11 Integrated 100-Year Macroeconomic Results for DRM 1-5

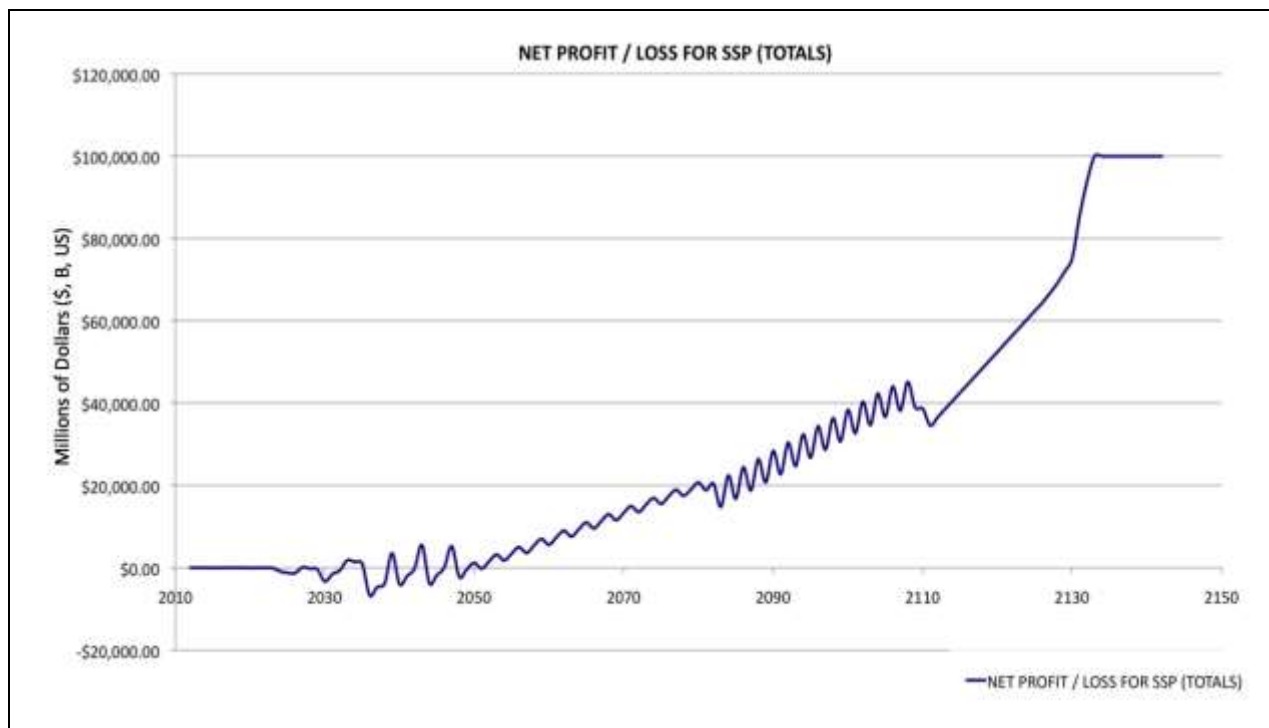

Figure 7-12 Integrated 100-Year Macroeconomic Results for Total Capacity of 100 GW

The “ripples” in the financial curve in Figure 7-12 are caused by successive deployments of SPS platforms – first one every several years, then one every two years, then one each year. Ultimately, the net revenues from this hypothetical SPS industry at a power delivery capacity of 100 GW, reaches roughly \$100B / year. Even at this scale, space solar power would still represent only a small fraction of the total power capacity required for global markets today, much less in 2100. However, this scenario indicates that SPS-ALPHA could readily be economically viable with modest technology advances beyond the state-of-the-art in the laboratory today.

7.5 Recommendations for Future Work

The following are a number of recommendations for future systems studies concerning the SPS-ALPHA concept.

Due to the limitations of resources in the Phase 1 project not all of the analyses that might be implemented have been. Additional sensitivity studies are needed, including both new topics for studies (e.g., varying FOMS for different technologies), and conducting the studies already undertaken for all of the DRMs identified.

Key topics requiring additional modeling and analysis include (1) integrated component performance and thermal management studies with the objective of analytically connecting device efficiency and expected operating temperatures; (2) formal structural modeling and analysis for all systems; and, (3) updated and refined wireless power transmission modeling to the device level.

THIS PAGE LEFT BLANK.

SECTION 8

TECHNOLOGY READINESS AND RISK ASSESSMENT

8.1 TRRA Methodology

8.1.1 Overview

The following section provides detailed information concerning the technology readiness and risk assessment (TRRA) that was performed for the SPS-ALPHA NIAC Phase 1 project. The TRRA required the decomposition of the SPS-ALPHA concept into functional areas corresponding to key technologies requirements, and for each of these the determination of three key research and development (R&D) metrics:

- (1) The technology readiness level (TRL) for key systems functions;
- (2) Technology need values (TNV) for each of the technologies assumed in the proposed approach to accomplish those functions; and,
- (3) The projected R&D degree of difficulty (R&D3) for the technology development program that is expected to be required to mature those technologies to TRL 6 by the timeframe at which system development for each stage in the roadmap is projected to be initiated.

8.1.2 Technology Readiness Levels

The Technology Readiness Level (TRL) scale, developed by NASA is the standard method of evaluating and communicating the status of technology maturation for a particular systems application. The following are the standard definitions of the TRL scale (see Table 8-1), as used in the assessment of SPS-ALPHA technologies.

Table 8-1 Standard TRL Definitions

READINESS LEVEL	DEFINITION	EXPLANATION
TRL 1	Basic principles observed and reported	Lowest level of technology readiness. Scientific research begins to be translated into applied research and development.
TRL 2	Technology concept and/or application formulated	Once basic principles are observed, practical applications can be invented and R&D started. Applications are speculative and may be unproven.
TRL 3	Analytical and experimental critical function and/or characteristic proof-of-concept	Active research and development is initiated, including analytical / laboratory studies to validate predictions regarding the technology.
TRL 4	Component and/or breadboard validation in laboratory environment	Basic technological components are integrated to establish that they will work together.
TRL 5	Component and/or breadboard validation in relevant environment	The basic technological components are integrated with reasonably realistic supporting elements so it can be tested in a simulated environment.
TRL 6	System/subsystem model or prototype demonstration in a relevant environment (ground or space)	A representative model or prototype system is tested in a relevant environment.

READINESS LEVEL	DEFINITION	EXPLANATION
TRL 7	System prototype demonstration in a space environment	A prototype system that is near, or at, the planned operational system.
TRL 8	Actual system completed and “flight qualified” through test and demonstration (ground or space)	In an actual system, the technology has been proven to work in its final form and under expected conditions.
TRL 9	Actual system “flight proven” through successful mission operations	The system incorporating the new technology in its final form has been used under actual mission conditions.

Δ TRL. The Delta-TRL (Δ TRL) is a derived measure of the level of maturity relative to a particular goal in a planned R&D program. Δ TRL is simply the difference in TRL’s between the current level of maturity of a particular technology and the TRL desired by a particular point in time in the future. For example, if the desired TRL is TRL-6 and the current TRL is TRL-3, the Delta-TRL is Δ TRL=3. In this example, Δ TRL=3 corresponds the challenge of technology that is currently in the laboratory, proof-of-concept level (TRL=3) and which must advance to a system-level prototype demonstration in a operationally-relevant environment (TRL=6). Each step represents another level of developmental maturity – hence, more steps is equivalent to greater R&D uncertainty over a given length of time.

8.1.3 Research and Development Degree of Difficulty

A measure of how much difficulty can be expected in the maturation of a particular technology can be very useful as a complement to the standard TRL scale. TRL’s are a systematic, non-discipline specific metric/measurement system that supports assessments of the maturity of a particular technology and the consistent comparison of maturity between different types of technology. Another measure — the “Research and Development Degree of Difficulty” (R&D³) — is a measure of the riskiness (probability of success and/or failure) of the planned technology development effort. See Figure 8-1. The following paragraphs provide the definitions of each of the levels in the R&D³ scale.

$R\&D^3 = 1$. An R&D³ of “1” corresponds to an expected degree of difficulty in achieving research and development objectives that is low; in other words, the probability of success is high enough to assure that with only one or two alternative technological approaches a given program can realize a high probability of achieving a given set of R&D objectives. Generally speaking, an R&D³ of 1 would correspond with moderate to high level of TRL; however, there may be cases in which a low TRL technology could have an R&D³ of “1” because the R&D path requires no obvious technical hurdles, special facilities, or unusual testing environments.

$R\&D^3 = 2$. An R&D³ of “2” reflects a no more than a moderate expectation of difficulty in achieving research and development objectives. Not less than two or three alternative technological approaches should be pursued, if a given program wishes to have a high probability of achieving a given set of R&D objectives. Generally speaking, an R&D³ of 2 would correspond with a moderate to higher level of TRL, although there may be cases in which lower TRL technologies reflect an R&D³ of “2” due to details of expected R&D.

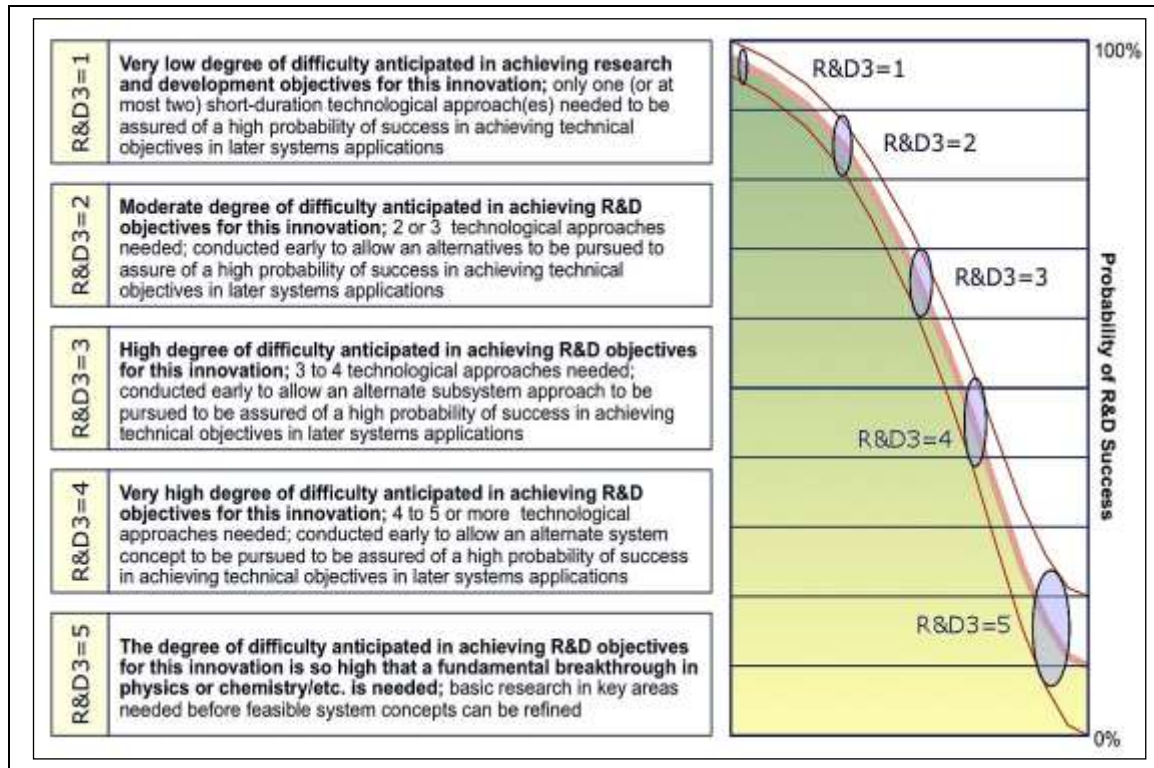

Figure 8-1 Research and Development (R&D) Degree of Difficulty (R&D³)

R&D³ = 3. An R&D³ of “3” corresponds to an expected degree of difficulty in achieving research and development objectives that is high enough that substantial R&D is needed. As a result, if a given program wishes to have a high probability of achieving a given set of R&D objectives, then not less than three or four technological approaches need to be pursued. In this case, applied research may be needed before detailed designs for technically feasibility system concepts can be developed. Generally speaking, an R&D³ of 5 corresponds with a low to moderate value of TRL.

R&D³ = 4. An R&D³ of “4” represents the expectation that there will be a very high degree of difficult in achieving research and development objectives. As a result, if a given program wishes to have a high probability of achieving a given set of R&D objectives, then not less than four or five technological approaches need to be pursued. Also, in this case R&D should be conducted early enough to allow for significantly different alternative system concepts to be pursued based on the results of the R&D effort. Generally speaking, an R&D³ of 4 would correspond with a low value to moderate value of TRL.

R&D³ = 5. An R&D³ of “5” corresponds to an expected degree of difficulty in achieving research and development objectives that is so extremely high that a fundamental breakthrough in physics, chemistry, etc., is required. In this case, basic research is clearly needed before technically feasibility system concepts can be defined in detail. Generally speaking, an R&D³ of 5 corresponds with a very low value of TRL.

8.1.4 Technology Need Value

The Technology Need Value (TNV) is a measure of the importance of a particular technology (including a specific set of figures of merits) to one or more specific system concepts in a targeted application.

Some of the technologies applied in a specific concept are critical to the functional characteristics of the concept; these are “enabling”. Other technologies are simply “enhancing” to varying degrees and might be replaced with other technologies with only modest changes to the performance, cost, etc., of the system to be

developed. The Technology Need Value (TNV) is a qualitative measure of this factor. The three TNV values used in the ITAM include the following.

TNV-1. In the case of a TNV of “1”, the technology R&D effort *is not critical at this time* to the success of the program—the advances to be achieved are useful for some cost improvements; however, the information to be provided is not needed for management decisions until the far-term.

TNV-2. A TNV of “2” represents a technology effort that is *useful* to the success of the program—the advances to be achieved would meaningfully improve cost and/or performance; however, the information to be provided is not needed for management decisions until the mid- to far-term.

TNV-3. For a TNV of “3”, the technology effort is important to the success of the program—the advances to be achieved are important for performance and/or cost objectives and the information to be provided is needed for management in the near- to mid-term.

TNV-4. A TNV of “4” corresponds to a case in which the technology effort is very important to the success of the program; the advances to be achieved are enabling for cost goals and/or important for performance objectives and the information to be provided would be highly valuable for near-term management decisions.

TNV-5. The technology effort is critically important to the success of the program at present—the performance advances to be achieved are enabling and the information to be provided is essential for near-term decisions.

8.1.5 Integrated Technology Risk Matrix

Finally, the SPS-ALPHA project also constructed an integrated TRRA risk matrix for each of the several stages in the planned systems technology development roadmap. See Figure 8-2 for an example of the synthesized TRRA risk matrix developed for the SPS-ALPHA NIAC Phase 1 study project.

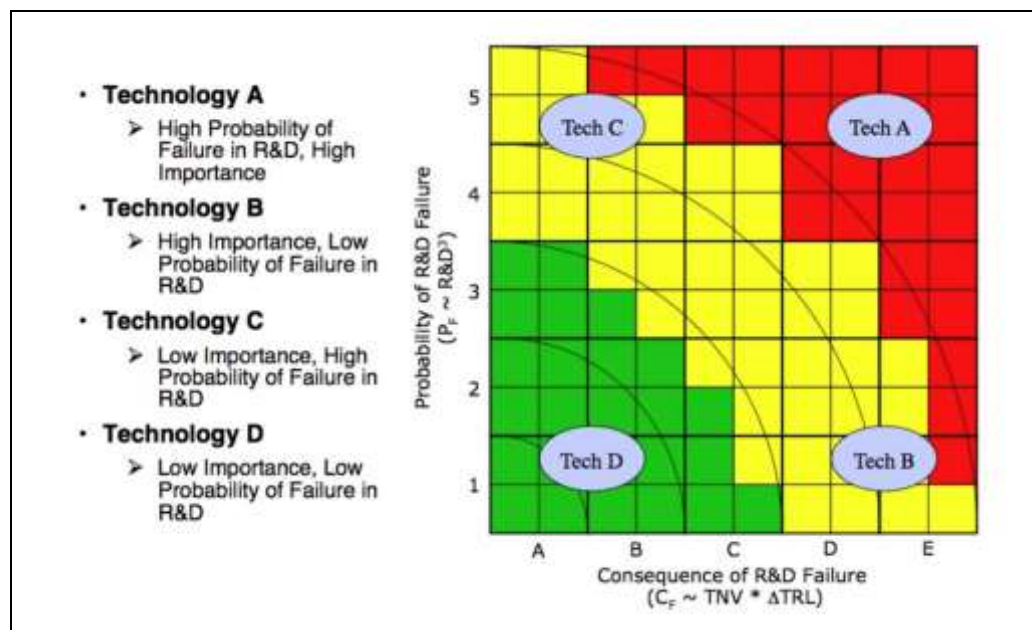

Figure 8-2 TRRA Risk Matrix Example

8.2 SPS-ALPHA Phase 1 TRRA Results

8.2.1 SPS-ALPHA Technology Requirements Overview

Although no breakthroughs are required, a diverse array of technologies is needed to accomplish the SPS-ALPHA architecture. Table 8-2 provides an overview of the generic technology requirements for each of the several modules that comprise SPS-ALPHA.

Table 8-2 Crosswalk of Technology Requirements to SPS-ALPHA Modules

	HexBus	Interconnects	HexFrame Structural Module	TFRP Module	SPG Module	WPT Module	PAC Module	MPPR
Low-Mass / High-Strength Structural Materials / Systems	X	X	X	X	X	X		
Low-Mass / High-Reflectivity Thin-Film Reflectors			X	X				
Robust / Highly-Reliable Mechanisms / Actuators (& related Tribology)	X	X	X	X			X	X
High-Aspect Ratio / High-Strength / Low-Mass Deployable Beams			X	X				
Radiation / SEU /Latch-Up Tolerant Electronic Devices	X	X	X	X	X	X	X	X
High-Temperature / High-Efficiency Electronic Materials	X	X			X	X	X	
Space-Based WiFi / Wireless Communications Networks	X	X						X
High-Efficiency / Low Mass Solar Cells / Arrays	X				X			
High-Efficiency / Low-Mass Retro-directive WPT w/ High-Eff. Amplifiers						X		
Low-Mass / Moderate Temperature Thermal Management	X	X		X	X	X	X	X
Modular Reconfigurable Power Management & Distribution	X	X			X	X	X	X
High-Efficiency / Moderate-Thrust Electric Propulsion							X	
Highly-Autonomous Systems / Reconfigurable Avionics	X	X				X	X	X
Autonomous Robotics / Manipulators (Structured Environ.)		X	X	X				X

In turn, accomplishing the objectives of each DRM will demand the same functionality (e.g., solar power generation), but with increasingly capable specific technologies. Each Module/Technology intersection identified above should be assessed for each of the five (5) DRMs, and each specific Case examined by the study. In other words, DRM_1 / Case_1 can be accomplished with commercially available space-qualified solar arrays. However, accomplishing the macroeconomic objectives of DRM_5 / Case 4B will only be possible with significant improvements beyond commercial off-the-shelf (COTS) subsystems and technologies.

Developing a detailed TRRA for all of the technology requirements identified in Table 8-2, and for all of the DRMs and Cases, is far beyond the scope of this Phase 1 NIAC project. For each of the five design reference missions, and the sensitivity studies that have been performed, a host of highly specific technology choices have

been made within the software tool(s) that were used to perform the project’s systems analysis studies. Table 8-3 provides a high-level summary of some of the more important technology requirements for each of the five baseline DRM cases.

As a starting point, the following two sub-sections provide preliminary technology readiness and risk assessments for a handful of the most important technologies, for two of the primary DRMs: DRM_2 / Case_1, the initial integrated LEO orbital demonstration, and DRM_5 / Case_4B the moderately advanced technology GEO full-scale solar power satellite.

8.2.2 TRRA for DRM_2 / Case_1

At a power level of about 200 kW and with deployment in LEO, DRM_2 is a major spacecraft; however in the context of SPS-ALPHA DRM_3 (to be deployed in GEO), it is only a major systems-level technology flight demonstration (TFD). Paragraph 7.2.2 provides a summary description of SPS-ALPHA DRM_2/Case_1 (D2/C1). Figure 8-3 presents the integrated Risk Matrix for D2/C1, developed using the methodology described above. Table 8-4 presents the results of a high-level summary of the initial TRRA for D2/C1, including only key technology areas / functional requirements.

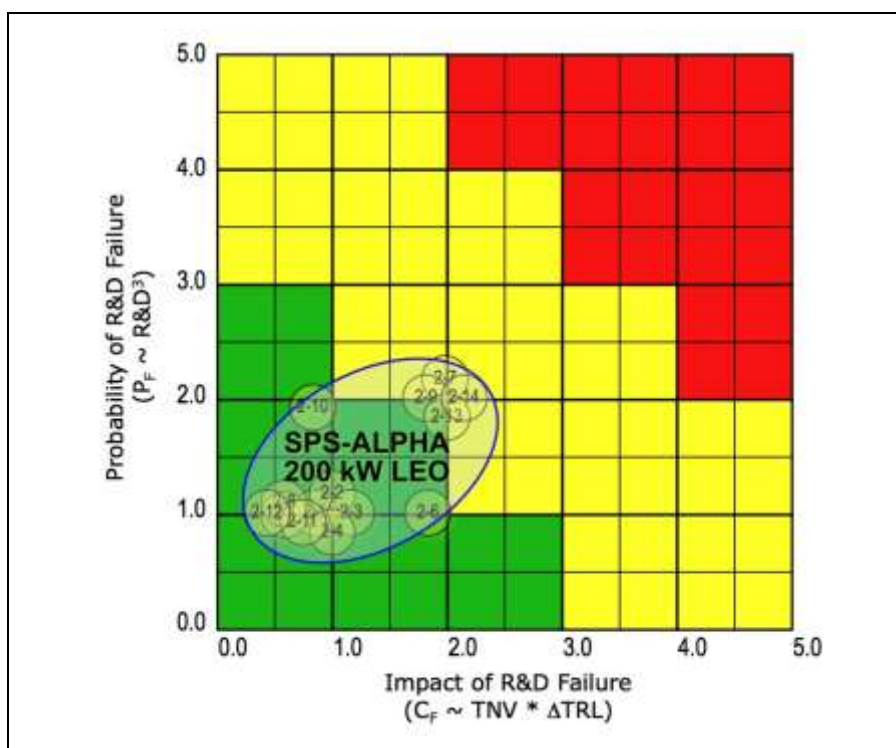

Figure 8-3 Integrated Risk Matrix for DRM_2 / Case_1

Table 8-4 Preliminary Technology Readiness and Risk Assessment for D2/C1

Index	Technology Area	Goal TRL	Current TRL	ΔTRL	TNV	R&D3	Notes**
2-1	Low-Mass / High-Strength Structural Materials / Systems	6	5	1	5	1	Conventional Materials acceptable (e.g., Aluminum)
2-2	Low-Mass / High-Reflectivity Thin-Film Reflectors	6	5	1	5	1	Current SOA Acceptable (e.g., DLR solar sail)

Table 8-4 Preliminary Technology Readiness and Risk Assessment for D2/C1

Index	Technology Area	Goal TRL	Current TRL	ΔTRL	TNV	R&D3	Notes**
2-3	Robust / Highly-Reliable Mechanisms / Actuators (& related Tribology)	6	5	1	5	1	ISS-type mechanisms acceptable
2-4	High-Aspect Ratio / High-Strength / Low-Mass Deployable Beams	6	5	1	5	1	Astromast-type structural systems acceptable
2-5	Radiation / SEU /Latch-Up Tolerant Electronic Devices	6	5	1	3	1	LEO operations only; no strong requirement
2-6	High-Temperature / High-Efficiency Electronic Devices / Materials	6	3	3	3	1	Low-power operations only; no strong requirement
2-7	Space-Based WiFi / Wireless Communications Networks	6	4	2	5	2	Adaptation of ground-systems as a starting point
2-8	High-Efficiency / Low Mass PV Cells and Solar Arrays	6	5	1	3	1	Conventional space-qualified solar arrays acceptable
2-9	High-Efficiency / Low-Mass Retro-directive WPT w/ High-Eff. Amplifiers	6	4	2	5	2	Off-the-shelf devices acceptable; low power array
2-10	Low-Mass / Moderate Temperature Thermal Management	6	4	2	2	2	Minimal Thermal Management requirements
2-11	Modular Reconfigurable Power Management & Distribution	6	4	2	2	1	Minimal PMAD requirements; no transfer among modules
2-12	High-Efficiency / Moderate-Thrust Electric Propulsion	6	4	2	1	1	Operational / Demo Systems
2-13	Highly-Autonomous Systems / Reconfigurable Avionics	6	4	2	5	2	Operational / Demo Systems
2-14	Autonomous Robotics / Manipulators (Structured Environ.)	6	4	2	5	2	Operational / Demo Systems
<p>*Note: The timing for achieving TRL 6 at the end of Phase B for a DRM_2 / Case_1 Flight project would be approximately 7 years from 01 October 2012.</p> <p>**Note: Major functional areas for DRM_2 (e.g., structural systems & materials) would include both more mature operational technologies, and more advanced technology options for preliminary testing.</p>							

As expected, the technologies for this case – although not yet tailored or matured for this architecture – are nonetheless available in the laboratory and in use for other applications; as a result, they were judged to be relatively low risk.

8.2.2 TRRA for DRM_5 / Case_4B

DRM_5 / Case_4B represents a mature, recurring version of the SPS-ALPHA concept, capable of delivering 2 GW to terrestrial markets and requiring the maturation of a number of new technologies to succeed. Paragraph 7.2.5 provides a summary description of the SPS-ALPHA DRM_5/Case_4B case. Figure 8-4 presents the integrated Risk Matrix for D5/C4B, developed using the methodology described above. Table 8-5 below

presents the results a high-level summary of the initial TRRA for D5/C4B, including only key technology areas / functional topics.

Table 8-5 Preliminary Technology Readiness and Risk Assessment for D5/C4B

Index	Technology Area	Goal TRL	Current TRL	ΔTRL	TNV	R&D3	Notes
5-1	Low-Mass / High-Strength Structural Materials / Systems	6	3	3	5	2	Must have advanced Materials (e.g., Composites)
5-2	Low-Mass / High-Reflectivity Thin-Film Reflectors	6	3	3	5	2	Need large/flat reflectors
5-3	Robust / Highly-Reliable Mechanisms / Actuators (& related Tribology)	6	4	2	5	2	Need mass-producible mechanisms / long-lived ops
5-4	High-Aspect Ratio / High-Strength / Low-Mass Deployable Beams	6	3	3	5	2	Need low-mass / reliable structural systems
5-5	Radiation / SEU / Latch-Up Tolerant Electronic Devices	6	4	2	4	2	Robust / GEO operations req'd; repair option
5-6	High-Temperature / High-Efficiency Electronic Materials	6	3	3	5	3	High-temperature device environment required
5-7	Space-Based WiFi / Wireless Communications Networks	6	4	2	5	2	Need reliable / secure large space-based networks
5-8	High-Efficiency / Low Mass Solar Cells / Arrays	6	3	3	4	4	Need high-efficiency / low mass arrays
5-9	High-Efficiency / Low-Mass Retro-directive WPT w/ High-Eff. Amplifiers	6	4	2	5	2	Low mass by unit area, mass-producible transmitter array
5-10	Low-Mass / Moderate Temperature Thermal Management	6	3	3	2	2	Must have low-mass / moderate temp thermal
5-11	Modular Reconfigurable Power Management & Distribution	6	3	3	3	3	Local PMAD requires low mass; inter-module option
5-12	High-Efficiency / Moderate-Thrust Electric Propulsion	6	4	2	3	2	Long-lived / fine-pointing thruster
5-13	Highly-Autonomous Systems / Reconfigurable Avionics	6	3	3	5	2	Critical requirement
5-14	Autonomous Robotics / Manipulators (Structured Environ.)	6	3	3	5	2	Critical requirement
<p>*Note: The timing for achieving TRL 6 at the end of Phase B for the DRM_5 / Case_4B Flight project would be approximately 25 years from 01 October 2012.</p>							

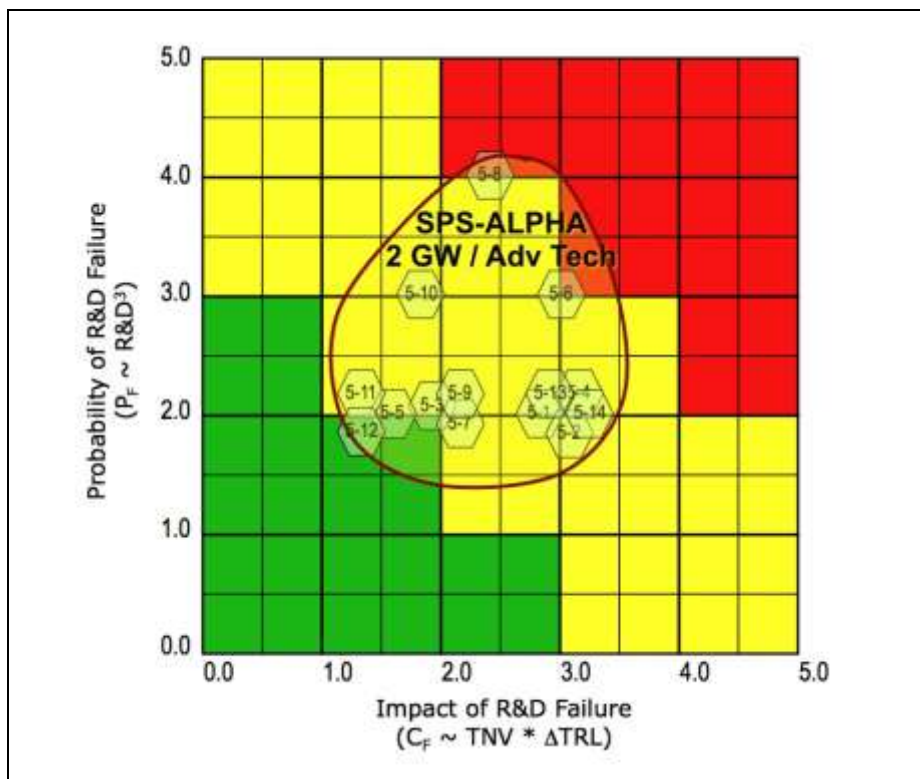

Figure 8-3 Integrated Risk Matrix for DRM_5 / Case_4B

8.3 SPS-ALPHA TRRA Observations

The SPS-ALPHA concept does not require any technology breakthroughs. Still, the concept involves the application of diverse existing technologies in novel systems with new and distinct requirements. As a result, the TRLs tend to be poor, but the expected R&D is relatively good. The two DRM cases chosen for detailed assessment span the SPS-ALPHA roadmap, ranging from an early (but substantial) demonstration to a mature commercially SPS with advanced technologies.

As shown in Figure 8-3, the technology requirements for DRM_2 / Case_1 are more mature and lower risk than those needed for DRM_5 / Case_4B. However, the planned approach depicted in the SPS-ALPHA roadmap (See Section 9) mitigates the issues. The roadmap involves several rounds of innovation and demonstration over more than a decade, the mid-range technology risks associated with DRM_5 / Case_4B appear tractable.

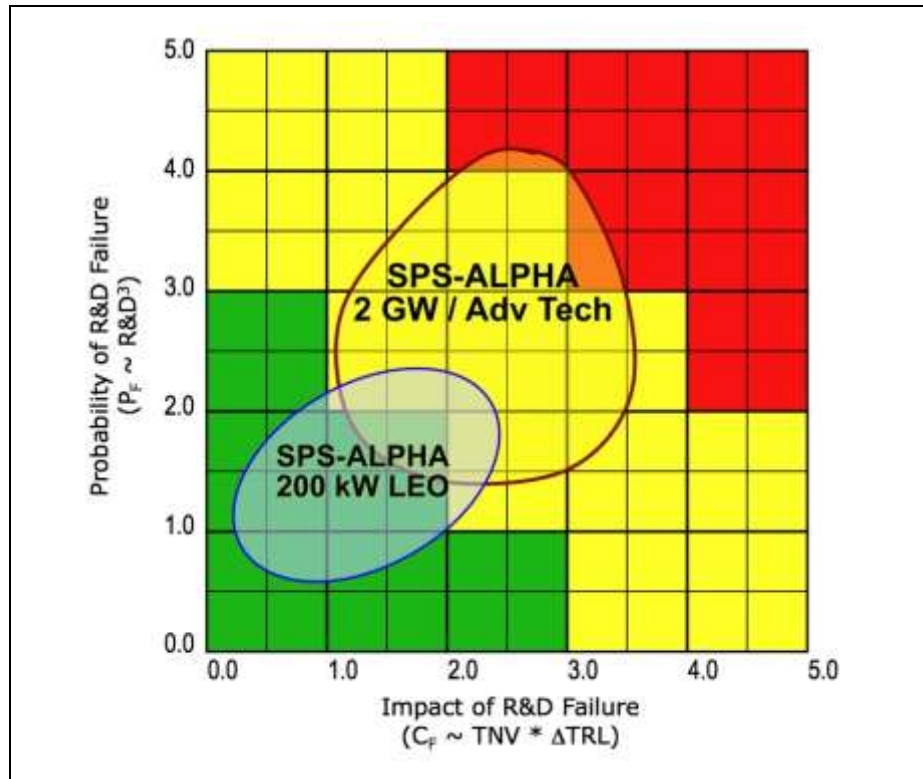

Figure 8-3 Integrated Risk Matrix for DRM_2 / Case_1

SECTION 9

PATH FORWARD: A ROADMAP FOR SPS-ALPHA

9.1 Overview

The hyper-modular architectural approach to space systems embodied by the SPS-ALPHA concept appears to be technically feasible and may be broadly important for future space missions (see Section 8). One deliverable from the 2011-2012 NIAC Phase 1 project is a roadmap that presents a credible path forward for SPS-ALPHA and the hyper-modular architectural approach. Figure 9-1 presents this preliminary systems and technology roadmap for the further development of the SPS-ALPHA concept.

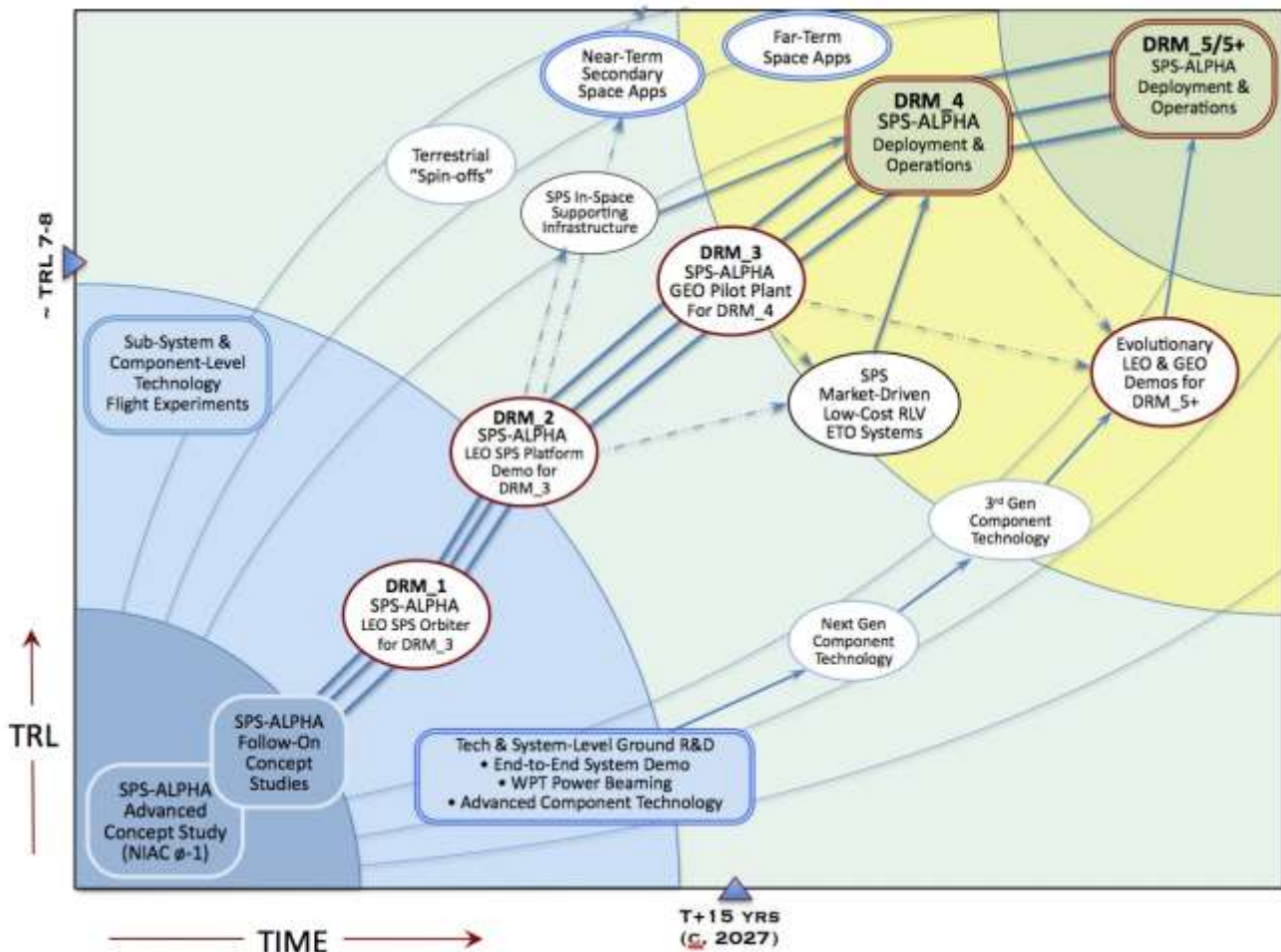

Figure 9-1 SPS-ALPHA Systems-Technology Development Roadmap (Preliminary)

Key elements of this roadmap include:

- Early advanced concepts study projects (including this NIAC Phase 1 project);
- Continuing SPS-ALPHA and supporting infrastructure concept studies, and related advanced technology research projects;

- Ongoing focused technology research and development to realize continued improvements in the efficiency, operating temperature and mass of key devices (and thereby enable evolutionary commercial viability for large-scale space solar power in terrestrial markets);
- A regular series of systems-level technology flight demonstrations, targeting DRMs with strong nearer-term space applications and culminating in a large-scale pilot plant SPS-ALPHA demonstration in GEO; and,
- Orchestrated development of supporting infrastructures and derived space applications.

The individual Design Reference Missions (DRMs) described in Section 7 have been chosen to represent candidate milestones in the strategic roadmap for SPS-ALPHA presented here. These include:

- DRM 1: an initial SPS-APHA technology flight experiment (TFE) / technology flight demonstration (TFD) in low Earth orbit (LEO) at a small scale (see below).
- DRM 2: a second SPS-APHA demonstration in LEO at a moderate scale, and incorporating operational technologies such as ISAAC (see below). Both DRM_1 and DRM_2 will test technologies intended for incorporation into DRM_3.
- DRM 3: the first major SPS-APHA demonstration in geostationary Earth orbit (GEO) at a large scale, but not yet full-scale (see below). DRM_3 will demonstrate technologies for incorporation into DRM_4.
- DRM 4: an initial operational SPS-APHA in GEO at up to 1 GW scale (see below). DRM_4 (and later versions) will provide opportunities to test new technologies intended for incorporation into later versions of SPS-ALPHA.
- DRM 5: an initial SPS-APHA demonstration in low Earth orbit (LEO) at up to 2 GW scale (see below).

A central tenet of this roadmap is that because the SPS-ALPHA architecture represents a radical systems level departure from past space systems practices, a series of major technology flight demonstrations will be essential to establish confidence in this novel approach. Although this study has made preliminary estimates (see Section 7), the ultimate costs and prices of energy delivered from SSP systems have not yet been established. However, the economics of SPS-ALPHA will clearly depend on both the engineering of the SPS platform and its supporting systems, and the markets that such systems seek to serve. As a result, this roadmap for SPS-ALPHA provides for self-evident technical accomplishments and for periodic and timely progress in the development of energy markets and commercially viable applications of key SSP technologies and systems.

The following paragraphs describe the groundrules that were adhered to in preparing the strategic roadmap presented here.

9.2 Roadmap Ground Rules

Several ground rules were imposed in framing the NIAC Phase 1 SPS-ALPHA Roadmap.²³ First, the detailed milestones included in the roadmap do not depend on the specific budgets invested by government or commercial organizations. Second, the roadmap produced cannot be schedule- and/or calendar-specific (since both of these are dependent on budgets). Rather, this roadmap is strategic in character – providing a coherent and flexible framework for a wide range of prospective government, industry and academic institution activities to advance space solar power. However, the roadmap does indicate roughly what could be accomplished in terms of schedule and technology maturity – depending on budgets and programs.

Moreover, the roadmap recognizes that the business model by which SPS-ALPHA may be developed is by no means fixed. Development options include: (1) a major government project (including both national and international components); (2) public / private partnerships (potentially involving multiple governments); and,

²³ The road mapping approach used by this NIAC study builds upon the approach used in the 2011 International Academy of Astronautics (IAA) “First International Assessment of Space Solar Power”. [25]

(3) privately-funded ventures. Novel approaches, such as “Prize Challenges” might also play a role. The roadmap is entirely flexible in terms of which of these development mechanisms might ultimately be employed – or even (which is most likely) different aspects of the roadmap follow different development organizational approaches. (For example, the SPS might be developed through a public / private partnership, while the launch system(s) used might be either private or government provided.)

The following paragraphs discuss the major components of this preliminary roadmap in greater detail, including additional details concerning the five (5) DRMs listed above.

9.3 Major Roadmap Component Descriptions

9.3.1 Early & Continuing Technology R&D

Although no fundamental advances are required (i.e., no “breakthroughs” in science) to realize SPS-ALPHA, given the broad scope of systems and infrastructure that SPS-ALPHA represents, a similarly wide range of studies and basic technology research involving diverse areas are needed. Moreover, in order to realize the longer-term potential of the SPS-ALPHA architecture to deliver power to terrestrial markets at commercially competitive prices, significant improvements will be required over component technologies available in space systems now (in 2012). In addition, considerable research, prototyping and broadly-based coordination will be needed in order to finalize the full range of system architecture details involved, including module-to-module interfaces and interactions. As a result, there is a need for early and continuing technology research and development activities as a part of the roadmap for SPS-ALPHA; these include:

Systems Concept Studies. Beginning with this NASA-supported NIAC Phase 1 study project, a program of increasing fidelity modeling, simulation and analysis of the SPS-ALPHA design reference missions and supporting systems is needed. The ideal result from near-term system studies would be to reach general agreement regarding one or two basic architectures and systems design concepts for space solar power into which ongoing component-level improvements were to be later incorporated. The identification of such a higher-level framework for R&D should be a key goal for SPS/SSP systems analysis and design studies.

Technology & System-Level R&D. This R&D should address development and prototyping of key components and subsystems. Such relevant areas for component technology R&D include: (1) FET amplifiers (for sandwich type concepts); (2) thermal management systems; (3) modular PMAD systems, and others. For example, experiments have been performed in recent years that have validated several of the novel technologies (e.g., retro-directive phase control) that are needed to enable the hyper-modular sandwich SPS architectural approach. One such test was performed over a distance of 148 km in the U.S. state of Hawaii in Spring 2008.

Figure 9-2 presents photographs taken of the solar-powered microwave power transmission test equipment on location on the crest of Haleakala on the island of Maui in May 2008. The photo on the left is of the WPT equipment being tested in an anechoic chamber by Prof. N. Kaya of Kobe University; the photo on right is of the integrated experiment (including solar power) being tested in Hawaii.²⁴

²⁴ This test was sponsored by Discovery Communications, Inc., and was performed by an international team comprising from Japan, Kobe University (led by Prof. N. Kaya); and from the US, including Dr. F. Little and others of Texas A&M University, and Dr. N. Marzwell (formerly of the NASA Jet Propulsion Laboratory). J. Mankins was the team leader for the project.



Figure 9-2 Solar Powered WPT Equipment Demonstration in Hawaii – May 2008[8]

Sub-System and Component Level Technology Flight Experiments. In a number of cases, only the space environment can allow the necessary experiments and tests to be conducted to mature a particular technology. In the case of space solar power R&D, there are a number of possible technology flight experiments (TFEs) that may be needed to verify component and system performance, and to validate systems integration design choices. (Systems level technology flight demonstrations are discussed below.) Some of the most important prospective TFEs include:

- Wireless Power Transmission Experiments;
- Large Space Structures and In-Space Assembly Experiments; and,
- SPS Platform Component Experiments.

A topic of particular importance for TFE is that of Wireless Power Transmission. Although many of the fundamental aspects of the engineering of WPT can be developed and demonstrated through ground-based and airborne technology experiments (see the example described above), there are a range of specific TFE options that will require the use of the space environment. Tests of wireless power transmission in space could include:

- Ground-to-Space WPT Tests
- Space-to-space WPT Tests
- Space-to-Ground WPT Tests / LEO
- Space-to-Ground WPT tests / GEO

Such TFEs result in validation of technology readiness levels in the range of TRL 4 to 5. (See Section 8.) In addition, these experiments can contribute to better understanding of the interactions between the WPT transmission and the environment – in space and in the atmosphere. Tests of microwave power transmission at various power levels from LEO to the ground, for example, appear very useful in further evaluating the interactions of the WPT beam with the ionosphere.

During the past 40 years, a variety of lower TRL SPS-relevant technology flight experiments and ground technology demonstrations have been performed – particularly in the field of wireless power transmission. The earliest of these involved specific component technologies that may no longer be fully relevant to eventual SPS realization, while other components (particularly involving rectennas) have been successfully demonstrated repeatedly over the years. A variety of additional technology developments / demonstrations are also ongoing in 2012. These include development of microwave and laser WPT ground tests by USEF / JAXA in Japan, and development of a sandwich panel test article by the U.S. Naval Research Laboratory (NRL); and laser power transmission studies at EADS Astrium in Europe.

Another important area for technology development, leading to TFEs is that of large space structures and in-space assembly and construction (ISAAC). The deployment and/or assembly of very large space structures

in a zero gravity space environment is one of the most obvious areas in which future technology flight experiments could prove invaluable. In recent years, one concept that has been discussed is that of using a large lightweight mesh as a scaffold for the in-space assembly of the transmitter/PV array of an SPS of the Sandwich type. Initial flight experiments have been conducted using a sounding rocket to launch a test system (using a simple rotational mesh deployment scheme).²⁵ Other deployment approaches, such as inflatable structures to which the mesh might be attached also appear promising. A key requirement in this case will be to assure that structural concepts and in-space assembly technologies (e.g., robotics) are researched and tested in concert. Large space structures and/or in-space assembly TFEs would result in validation of technology readiness levels in the range of TRL 4 to 5. (See Section 6.)

Next Generation & Third Generation Component Technology. There is a range of potential SPS platform component technologies that will be needed to implement DRM_4 (the first full-scale GEO SPS). These would be good candidates for technology flight experiments (TFEs). The objectives of such tests would include (a) verifying the performance of key components (e.g., solar cells, PMAD system elements, electronics, communications systems elements) in the space environment; (b) verification of key mechanisms, actuators and related tribology for key SPS components; and, (c) lifetime testing and related servicing and maintenance demonstrations for the full range of prospective SPS components and subsystems. Such TFEs would result in validation of technology readiness levels in the range of TRL 4 to 5. (See Section 6.)

9.3.2 DRM_1: Initial SPS-ALPHA LEO TFE/TFD

During the next 4-6 years (and with funding), an initial SPS-ALPHA technology flight demonstration (TFD) could be staged in a low Earth orbit (LEO), incorporating technology flight experiments (TFEs) involving various new space applications of technologies now in the laboratory. This mission, labeled here as “DRM_1”, would almost certainly involve a single launch and a free-flying mission. Staging this mission from the ISS, perhaps with astronaut assistance in the assembly of the primary array and HexFrame structures is a option. Another programmatic option would be to stage this DRM as an attached payload on the ISS.

9.3.3 DRM_2: Moderate-scale SPS-ALPHA LEO TFD

Following DRM_1, within the next 6-9 years, a fully functional SPS-ALPHA TFD could be staged in LEO. This mission, labeled here as “DRM_2” could incorporate as baseline systems the technologies tested in DRM_1, as well as accommodating TFEs of more advanced component technologies. DRM_2 would involve more than a single launch, and would demonstrate in-space assembly and construction operations using prototype (TRL 7) versions of the MPPR arms and related technologies.

9.3.4 DRM_3: SPS-ALPHA Pilot Plant in GEO

In cases where the overall R&D and conceptual “riskiness” of a new space system is judged to be low, full-scale system development may proceed once individual technologies are validated at TRL 5 (or TRL 6 at most). However, in the case of a novel and ambitious new system – such as SPS-ALPHA– a higher level of technology demonstration will almost certainly be required. There are two interrelated, but distinct aspects of the next-but-last stage in the proposed roadmap for SSP: (1) development, deployment and operation of both SPS pilot plants (perhaps at sub-scale, but capable of being scaled up), and (2) development of space applications of SSP technologies and systems at the subscale.

In order to qualify as a true “pilot plant” – rather than a technology experiment or demonstration – it is crucial for the system being demonstrated to be at a sufficient scale so as to allow testing and validation of essentially all aspects of the end-to-end challenges of building, launching, deploying, assembling and operating a solar power satellite. A typical rule of thumb might be that an SPS Pilot Plant should be capable of generating a wireless power transmission approximately 10% of the power level of a full-scale SPS using the same suite of technologies, but certainly not less than 1% of that power level. If an SPS pilot plant is developed, it should also

²⁵ The PI for this test was SPS-ALPHA project co-investigator Dr. Massimiliano Vasile.

be capable of being used to deliver power operationally to large-scale receivers on Earth positioned in locations that are relevant to, if not the same as anticipated subsequent market locations.

The design and development of DRM_3, an SPS pilot plant would itself be a tremendous undertaking. The purpose of which would be to validate system designs and key technologies before committing to full SPS development. In fact, the SPS concept is sufficiently transformational and entails enough technical uncertainties at the systems level such that major in-space demonstrations will be necessary to establish technical feasibility, engineering characteristics and economical viability before any organization is likely to proceed with full-scale development.

9.3.5 DRM_4: First Operational SPS-ALPHA in GEO

The penultimate stage in the SPS-ALPHA roadmap is the development, deployment and operation of the first full-scale SPS to deliver substantial energy to commercial markets, including baseload power markets. The strategic backbone of the roadmap presented here is a clear progression from studies to designs to development of an operational SPS according to the standard aerospace systems engineering process: from Pre-Phase A, to Phase A to Phase B, and then to Phase C/D for both the SPS platform, and for key SPS supporting systems and infrastructure.

9.3.6 DRM_5: Subsequent Operational SPS-ALPHA in GEO

The ultimate “destination” in the SPS-ALPHA strategic roadmap toward which all other components are directed is that of operational, large-scale solar power satellites delivering commercially competitive energy to markets on Earth. DRM_5 is the designation for such SPS in the roadmap presented in Figure 9-1. Various details regarding this design reference mission are presented in the preceding sections. The key parameters are: (1) power delivered is roughly 2 GW from a large platform based in GEO; (2) the system involves continuous annual repair and maintenance (at a rate of about 3% per year of hardware being replaced), hence providing an ongoing opportunity to introduce new technologies and systems improvements. The critical objective of DRM_5 is to deliver power at prices that are competitive in baseload markets. (Based on the systems analysis studies performed under this study, it appears that several technology enhancements will be critical to achieving this objective. The roadmap presented here provides the needed strategy of repeating cycles of innovation to accomplish this end.)

9.3.7 SPS In-Space Supporting Infrastructure

The earliest TFE’s and TFDs in the roadmap will note require any new in-space infrastructure. However, accomplishing later, more major demonstrations beyond LEO and on large scale will demand new in-space capabilities. Detailed requirements for such future systems remain to be defined, but will almost certainly include infrastructure such as in-space refueling capabilities (for both the SPS-ALPHA platform and affordable in-space transportation systems), vehicle assembly and maintenance systems, and others.

9.3.8 Terrestrial “Spin-Offs”

Early and continuing terrestrial mark applications of SPS-ALPHA technologies will be essential to the overall economic viability of the SPS-ALPHA concept. It is, of course, unclear at present how many of the “spin-offs” that could emerge from SPS-ALPHA related R&D will in fact prove to be “spin-ins”.

9.3.9 Secondary Space Applications

An important aspect of SSP technology development – and eventual economic viability of SPS – is that of finding interim milestones and applications for the technologies, components, and systems to be developed. This concept is in-line with the phrase of “pay as you go” – i.e., the idea that SSP development should entail meaningful, and hopefully profitable applications long before solar power satellites begin delivering power to terrestrial markets. As noted in Section 5, there are a variety of prospective space systems applications for (1) SPS platform subsystems / systems; (2) in-space transportation systems; (3) in-space infrastructures; (4) ETO vehicles; and, others. In particular, there are a variety of potential space applications of SPS-ALPHA technology that are consistent with the power levels that would typically characterize a “pilot plant” for a full scale operational SPS.

Near-Term Space Applications. These include applications in novel Earth-orbiting spacecraft, such as larger aperture telecommunications satellites. These are described in some detail in Section 6, above.

Far-Term Space Applications. These include potential applications in ambitious future space missions and markets, such as lunar resources development, human Mars missions, and others. These applications are discussed in greater detail in Section 5. (See Section 6.)

9.3.10 SPS Market-Driven Space Transportation Systems

A critical question for space solar power is always that of space transportation, including both Earth-to-orbit (ETO) transportation (vehicles and infrastructure), and in-space transportation. An important and relatively idea in SSP planning²⁶ is that the development of fundamentally new, reusable launch vehicles (RLVs) can and should be deferred until after the successful completion of an SPS pilot plant in GEO.

The likely investment in technology maturation, hardware development and system deployment for a very low-cost, highly reusable space transportation (HRST) system will require some 10s of billions of dollars (\$, US). If the SPS concept is the sole – or even a significant – market justification for such a development, then it is likely that a large-scale, pilot plant type demonstration of the SPS to be launched will be required prior to a government and/or commercial commitment to fielding HRST systems or supporting infrastructure.

In-space systems and infrastructures that will support SPS deployment, assembly, servicing, etc. will be intimately related to the detailed designs and characteristics of the SPS platform, and to the design of support ETO systems. Such in-space systems will likely need to be developed and demonstrated in tandem with, if not prior to, the implementation of an SPS pilot plant demonstration. Such systems level in-space demonstrations would result in validation of technology readiness levels in the range of TRL 7 and higher.

9.3.11 Evolutionary LEO & GEO Demonstrations

Even after the successful completion of DRM_3 (the SPS-ALPHA pilot plant), there will be a need for continuing TFEs and TFDs involving evolutionary new technologies intended for future generations of the SPS-ALPHA system concept.

9.3.12 Scope of the Roadmap

The overall estimated economic scope (e.g., cost for development, etc.) presented (based on integrating the cost estimates from Section 7) suggests that the total scope of the roadmap described here would be on the order of \$30B, over a period of time of about 25 years or more. This is substantial, but compares well to circa 1980 estimates of roughly \$1,000B to accomplish the first SPS.

9.5 Recommendations for Future Efforts

A broad range of technical challenges must be addressed in order to establish the economic feasibility of SPS-ALPHA, and – if appropriate – to subsequently proceed with development. It is possible that a single government or major company might surmount these challenges. However, timely success seems more likely to result from cooperation in accomplishing R&D objectives among governments, among industry players and among a broad range of government, corporate and academic organizations.

A variety of tests and demonstrations of one key technology – wireless power transmission – have been performed since the 1960s. However, many of these tests have involved component technologies that are not directly relevant to validating the economic viability of SSP. Moreover, selected early demonstrations have been performed by various organizations almost as a means of “getting their feet wet” – i.e., in learning the basics of WPT and/or SPS. Unfortunately, the next steps in moving higher in the TRL scale require considerably greater funding (i.e., from the lower left to the upper right in the roadmap); these key steps have not yet been taken.

²⁶ This was articulated in some detail in the 2011 IAA “First International Assessment of Space Solar Power”, referenced previously in this Section.

Timely communication of plans and results from SPS technology R&D activities is crucial to coordinated progress. The ongoing Space Power Symposium, organized annually under the auspices of the International Astronautical Federation (IAF), has served a highly useful role in this regard. Similarly, periodic conferences dedicated to SPS and WPT have been held over the past 20+ years in various countries (e.g., WPT 1995, SPS 2004, etc.); these have been highly useful in promoting international dialog and coordination of SSP efforts.

This section has presented a preliminary roadmap for SPS-ALPHA, framed in strategic terms, for the potential exploration of this innovative concept. This roadmap is not highly specific – it does not prescribe a specific budget, nor does it involve a specific schedule. However, it provides a possible framework for future SPS related activities by indicating a logical sequence for various steps, and the conceptual relationships among those steps. Moreover, it is the consensus of the IAA that significant progress could be made during the next 10-15 years – leading to a large, but sub-scale SPS pilot plant.

SECTION 10

SUMMARY AND CONCLUSIONS

The SPS-ALPHA concept represents a very different architecture for space solar power, involving a hyper-modular approach in which all platform elements can be mass produced, and none are larger than a “small sat”. If proven feasible, SPS-ALPHA could enable significantly lower development time and cost, much greater ease of manufacturing at lower cost, and significantly higher reliability.

During the past 40 years, space solar power for Earth has remained little more than a vision. Power for space missions has remained both scarce and expensive: most satellites operate on less power than that needed to run a typical home in the U.S., many on considerably less. If SPS-ALPHA can be developed, solar power in the range of 100s MW to 100s GW could be harvested in space and delivered efficiently to markets on Earth, and to enable energy-rich operations throughout the inner solar system – transforming all aspects of government and commercial space.

Systems analysis results from the 2011-2012 NIAC Phase 1 study project suggest that SPS-ALPHA may be able to achieve economic viability. Following technology maturation and systems-level demonstrations, the SPS-ALPHA concept delivered close to commercial results (e.g., less than 20¢ per kW-hr) with technologies currently in the laboratory, and competitive commercial energy (e.g., less than 10¢ per kW-hr) with selected improvements in key technologies.

Solar power satellites based on SPS-ALPHA could deliver power on demand to more than 90% of Earth’s population at locations across the globe. It would have a near zero “carbon footprint” and facilitate reaching greenhouse gas (GHG) emission reduction goals. Affordable and continuous solar energy delivered on large scale affordably from SPS to the U.S. and other markets would transform terrestrial power since no other “green energy” technology has similar potential to provide sustainable and “dispatchable” baseload power that is essentially immune to diurnal variations or to weather. [36,37] SPS-ALPHA could enable a more rapid, effective and affordable response to natural disasters and calamities (e.g., the 11 March 2011 disaster in Japan).

As has been found in past studies and for other SPS concepts going back to the 1970s, ETO transportation remains a critical factor in realizing economically viable SPS for terrestrial markets. In-space transportation costs are also important, but appear closely tied to ETO cost; in other words, low-cost in-space transportation (from LEO to GEO) cannot be realized without low-cost ETO transportation.

In addition, there are a number of prospective civil, commercial and security related applications of the SPS-ALPHA space systems architecture. These range from power for permanently shadowed regions at the lunar poles, to near-term applications in various Earth-orbiting satellites where a large, low-cost aperture is required.

In most locations across the Inner Solar System solar energy is available, sometimes continuously. This project would advance the capability to deliver power (at less than \$1/kW-hour) to civil or commercial space missions in space, on the Moon, Mars, or small bodies. The availability of reliable, inexpensive and continuous power at levels of 100s kW to 10s MW or higher would forever change the character of space systems, missions, and goals. Moreover, high power large apertures would be of great value for U.S. security space missions.^[22] And, recent studies (e.g., for DOD NSSO) concluded that development of SSP systems and technologies, including SPS, would significantly benefit the security of the U.S. and its allies. Not only would space systems benefit, but benefits would also result from delivery of assured, affordable power to forward bases, military operations, markets, and allies. ^[34]

Finally, ancillary SSP technologies – in areas such as space transportation, space communications, in-space construction, robotics, lightweight structures, etc. – would be of immense value to a wide range of civil / commercial space missions. ^[7, 30, 36]

The roadmap for SPS-ALPHA appears quite tractable programmatically: the hyper-modular architecture should enable fast-paced, relatively inexpensive steps forward, with a total cost for a scalable solar power satellite pilot plant of about \$5B and the first full-scale SPS of roughly \$20B. These numbers are substantial, but compare well to the reported \$100B cost of the ISS or the earlier 1980s era estimates of roughly \$1,000B to reach the first SPS.²⁷

In summary: the SPS-ALPHA advanced concept is extremely promising and warrants future consideration.

²⁷ This figure has been adjusted for inflation from c. 1980 to c. 2012.

APPENDIX A
GLOSSARY OF ACRONYMS

Acronym	Definition
ACTR	Advanced Concepts & Technology Research
AIAA	American Institute of Aeronautics and Astronautics
AIST	Affordable In-Space Transportation
ACES	Advanced Concepts Evaluation System
ACS	Attitude Control System
AFRL	Air Force Research Laboratory
AIAA	American Institute of Aeronautics and Astronautics
AIST	Affordable In-Space Transportation
AoA	Analysis of Alternatives
ASEB	(U.S. / HRC) Aeronautics and Space Engineering Board
ATLAS	Advanced Technology Life Cycle Analysis System
CBP	Commercial Baseload Power
CDS	Command and Data System
CER	Cost Estimation Relationship
CIPP	Commercial Intermediate & Peaking Power
CNT	Carbon Nanotube
CONOPS	Concept of Operations
C-PNP	Commercial PNP
CSI	Controls-Structures Interactions
CSP	Concentrator Solar Power
CTA	Connecting Truss Assembly
DC	Direct Current
DIPS	Dynamic Isotope Power Systems
DOD	Department of Defense
DOE	Department of Energy
\$	Dollars, US
DRM	Design Reference Mission
DSN	Deep Space Network
EADS	European Aeronautics Defense and Space Company

Acronym	Definition
ELV	Expendable Launch Vehicle
EM L1	Earth-Moon Libration Point L1 (and so on for EM L2, etc.)
ERDA	(US) Energy Research and Development Agency
ESA	European Space Agency
ESTEC	European Space Research and Technology Center
ETO	Earth-to-Orbit (Transportation)
ETS	(JAXA) Engineering Test Satellite
FET	Field Effect Transistor (Amplifier)
FIT	Feed-In Tariff
FOM	Figure of Merit
FOS	Forerunner Operational Systems
FTT	Future Technology Toolbox
GEO	Geostationary Earth Orbit
GHG	Green House Gas
GHz	Gigahertz
GLOW	Gross Lift-Off Weight
GN&C	Guidance, Navigation and Control
GW	Gigawatts
HexBus	Hexagonal Ring Satellite Bus
HLLV	Heavy Lift Launch Vehicle
HMM	Human Mars Mission
HRST	Highly Reusable Space Transportation
HTS	High-Temperature Superconductor
H/W	Hardware
HVDC	High-Voltage Direct Current (Power Line)
IAA	International Academy of Astronautics
IAC	International Astronautical Congress
IAF	International Astronautical Federation
IECEC	International Energy Conference and Engineering Conference
ISAAC	In-Space Assembly and Construction
ISAS	(JAXA) Institute of Space and Astronautical Science
ISC	Integrated Symmetrical Concentrator
Isp	Specific Impulse

Acronym	Definition
ISRU	<i>In Situ</i> Resource Utilization
ISS	International Space Station
ITU	International Telecommunications Union
JAXA	Japan Aerospace Exploration Agency
JPL	Jet Propulsion Laboratory
kg	Kilogram(s)
km	Kilometer(s)
KPP	Key Performance Parameter
kW	Kilowatt(s)
LCC	Life Cycle Cost
LCOE	Levelized Cost of Electricity
LEO	Low Earth Orbit
LH₂	Liquid Hydrogen
LLC	Limited Liability Company
LMO	Low Mars Orbit
LOX	Liquid Oxygen
LS-ALPHA	Lunar Surface Power by means of Arbitrarily Large Phased Array
LSP	Lunar Solar Power
m	Meter
MEO	Middle Earth Orbit
MHz	Megahertz
MPPR	Modular Push-me/Pull-you Robotic (Arm)
m/s	Meters per Second
mT	Metric Tons
MW	Megawatts
NASA	National Aeronautics and Space Administration
NIAC	NASA Innovative Advanced Concepts (Program)
NPV	Net Present Value
NRC	National Research Council
NRL	Naval Research Laboratory
NS-PNP	National Security PNP
NSSO	(DOD) National Security Space Office
O&M	Operations and Maintenance

Acronym	Definition
OECD	Organization for Economic Co-operation and Development
ORU	Orbital Replacement Unit
OTV	Orbital Transfer Vehicle
PAA	Primary Array Assembly
PMAD	Power Management and Distribution
PNP	Premium Niche Power
PNV	Premium Niche Market
PV	Photovoltaics
R&D	Research and Development
R&D3	R&D Degree of Difficulty
Rectenna	Rectifying Antenna
RDPA	Retro-Directive Phased Array
RF	Radio Frequency
RFID	RF Identification Device
RLV	Reusable Launch Vehicle
RMS	Remote Manipulator System
RTG	Radioisotope Thermoelectric Generator
s	Second(s)
SAIC	Science Applications International Corporation
SAMS	Space Assembly, Maintenance and Servicing
SbOCT	Space-Based Optical Communications Terminal
SbSP	Space-based Solar Power
SDP	Space Demonstrations & Prototypes
SE L1	Sun-Earth L1 Libration Point (etc. for SE L2)
SEPS	Solar Electric Propulsion System
SERT	(NASA) SSP Exploratory Research and Technology (Program)
SES	Sustainable Energy Sources
SME	Subject Matter Expert
SPACE Canada	Solar Power Alternative for Clean Energy - Canada
SPG	Solar Power Generation
SPS	Solar Power Satellite
SPS-ALPHA	SPS by means of Arbitrarily Large Phased Array
SRA	Solar Reflector Assembly

Acronym	Definition
SSM	Space Segment Model
SSP	Space Solar Power
SSPA	Solid State Power Amplifier
SSTO	Single-Stage-to-Orbit (RLV)
S/W	Software
TBD	To Be Determined
TFD	Technology Flight Demonstration
TFE	Technology Flight Experiment
TFRP	Thin-Film Reflectors & Pod
TMD	Technology Maturation and Demonstration
TMS	Thermal Management System
TNV	Technology Need Value
TRA	Technology Readiness Assessment
TRL	Technology Readiness Level
TRRA	Technology Readiness and Risk Assessment
T/W	Thrust-to-Weight Ratio
TW	Terawatt
TW-hr	Terawatt-hour
TWT	Traveling Wave Tube
USA	United States of America
USAF	United States Air Force
WPT	Wireless Power Transmission

APPENDIX B REFERENCES

- Ref_1 Glaser, Peter, Ph.D.; "Method and Apparatus for Converting Solar Radiation to Electrical Power," (US Patent No. 3,781,647; U.S. Patent and Trademark Office; Washington, D.C.). 25 December 1973.
- Ref_2 Davis, Hubert P.; "Power from Space," (Reprint of a Paper Given at the 71st Annual Meeting of the American Institute of Chemical Engineers). 1978.
- Ref_3 OTA Staff; "Solar Power Satellites," from the Office of Technology Assessment, U.S. Congress (Washington, D.C.). 1981.
- Ref_4 Mankins, John C.; "Space Solar Power: A Fresh Look," AIAA 95-3653 (Presented at the 1995 AIAA Space Program and Technologies Conference, Huntsville, Alabama). September 1995.
- Ref_5 Feingold, Harvey, Ph.D. et al; "Space Solar Power – A Fresh Look at the Feasibility of Generating Solar Power in Space for Use on Earth," (SAIC; Schaumburg, Illinois, USA), 02 April 1997.
- Ref_6 Mankins, John C.; "A Technical Overview of the 'SunTower' Solar Power Satellite Concept," (IAF-97-R.2.08; 38th International Astronautical Federation, Turin, Italy). 6-10 October 1997.
- Ref_7 NRC/ASEB; "Laying the Foundation for Space Solar Power: An Assessment of NASA's Space Solar Power Investment Strategy," from the NRC ASEB Committee for the Assessment of NASA's Space Solar Power Investment Strategy, Aeronautics and Space Engineering Board, (National Academies Press; Washington, D. C., USA). 2001.
- Ref_8 Mankins, John C. (editor); "Space Solar Power – Results of the First International Assessment," (Cosmic Study Report from the International Academy of Astronautics). September 2011.
- Ref_9 Kaya, Nobuyuki, Ph.D., et al; "Hawaii Demonstration of Microwave Beam Control, supported by the Discovery Channel," (International Symposium on Solar Energy from Space / SPS 2009 at the Ontario Science Center; Toronto, Canada). 8-10 September 2009.
- Ref_10 Little, Frank, Ph.D. et al; "Development of Retrodirective Control Transmitter for Wireless Power Transmission," (World Space Congress; Houston, Texas). 2002.
- Ref_11 McSpadden, James, Ph.D.; "Advances in RF Wireless Power Transmission," (International Symposium on Solar Energy from Space / SPS 2009 at the Ontario Science Center, Toronto, Canada). 8-10 September 2009.
- Ref_12 Shoichiro, Mihara, et al; "WPT Technology Demonstration Options at USEF," (International Symposium on Solar Energy from Space / SPS 2009 at the Ontario Science Center, Toronto, Canada). 8-10 September 2009.
- Ref_13; see: <http://www.jspec.jaxa.jp/e/activity/ikaros.html> and http://www.jaxa.jp/projects/sat/ikaros/index_e.html
- Ref_14; N. Kaya, personal communication, concerning the results of SPS 2009 WPT Demo.
- Ref_15; http://en.wikipedia.org/wiki/Experience_curve_effects
- Ref_16; see International Energy Agency, "World Energy Outlook," 2007, 2008; and other references including:
- <http://geography.about.com/od/obtainpopulationdata/a/worldpopulation.htm>,
 - <http://www.iiasa.ac.at/Research/POP/proj07/>,
 - <http://www.prb.org/Publications/PopulationBulletins/2001/WorldPopulationFuturesPDF338KB.aspx>,
 - <http://www.bp.com/sectiongenericarticle.do?categoryId=9035979&contentId=7066648>,

- <http://www.eia.doe.gov/oiaf/ieo/>, US DOE International Energy Outlook (DOE/EIA-0484) 2010,
- http://www.worldenergy.org/publications/survey_of_energy_resources_2007/solar/719.asp,
- <http://www.iea.org/>,
- <http://www.worldenergyoutlook.org/>

Ref_17; see See: http://en.wikipedia.org/wiki/Electricity_generation; Source Data from International Energy Agency (IEA) and OECD; c. 2008.

Ref_18; see: See: <http://www.canrea.ca/site/2011/03/true-cost-of-peak-power-in-ontario-much-higher-than-solar-feed-in-tariff/>

Ref_19; see: http://en.wikipedia.org/wiki/Feed-in_tariffs

Ref_20; see: California Public Utilities Commission; Release Docket #: Res E-4137; February 14, 2008.

Ref_21; see: <http://www.canrea.ca/site/2011/03/true-cost-of-peak-power-in-ontario-much-higher-than-solar-feed-in-tariff/>

Ref_22; see: http://www.retscreen.net/ang/case_studies_multiple_buildings_canada.php

Ref_23; see: <http://www.nss.org/settlement/ssp/library/nssso.htm>; Released 10 October 2007.

Ref_24; see “Nevada Solar One,” http://en.wikipedia.org/wiki/Solar_power_plants_in_the_Mojave_Desert

Ref_25; see “Nellis Solar Power Plant”,
http://en.wikipedia.org/wiki/Solar_power_plants_in_the_Mojave_Desert

Ref_26; see: http://en.wikipedia.org/wiki/Boeing_B-47_Stratojet.

Ref_27; see http://en.wikipedia.org/wiki/Boeing_367-80.

Ref_28; see: http://en.wikipedia.org/wiki/Boeing_707.

Ref_29; see: http://en.wikipedia.org/wiki/Boeing_KC-135_Stratotanker.

Ref_30 Brandhorst, Henry, Ph.D.; “Megawatt SEPS and Mars Exploration,” (International Symposium on Solar Energy from Space / SPS 2009 at the Ontario Science Center, Toronto, Canada). 8-10 September 2009.

Ref_H; see: Hurd, William J., et al, “Exo-atmospheric telescopes for Deep Space Optical Communications,” (2006 IEEE Aerospace Conference, Big Sky, MT) March 4-11, 2006.

Ref_30; see: <https://directory.eoportal.org/web/eoportal/satellite-missions/e/ets-viii>, and
http://space.skyrocket.de/doc_sdat/ets-8.htm

Ref_31; see: http://en.wikipedia.org/wiki/Shackleton_crater and <http://lunarscience.nasa.gov/articles/nasa-spacecraft-reveals-ice-content-in-moon-crater/>

Ref_32; see: <http://en.wikipedia.org/wiki/User:Xession/spacecraftcompare>

Ref_33 Henderson, B. Kyle, Ph.D.; “Air Force Deployable Structures Challenges”, a presentation (Spacecraft Component Technology Branch Space Vehicles Directorate, at the Spring 2010 AFRL Space Structures Workshop, Albuquerque, NM). 25 May 2010.

Ref_34 DOD / NSSO; “Space-Based Solar Power As an Opportunity for Strategic Security – Phase 0 Architecture Feasibility Study,” (A Report to the Director, DOD NSSO). 10 October 2007. Web Reference: www.acq.osd.mil/nssso/solar/SBSInterimAssessment0.1.pdf

Ref_35 Mankins, John C.; “Technology Readiness Levels – Definitions,” (A White Paper – NASA Headquarters; Washington, D.C., USA). 1995.

Ref_36 Grimard, Max, et al; “Space-Applications in Climate Change and Green Systems: the Need for International Cooperation”, a Final Report from the IAA. 2010.

Ref_37 Hoffert, Martin I., Prof. et al; “Advanced Technology Paths to Global Climate Stability: Energy for a Greenhouse Planet,” (SCIENCE Magazine, Vol. 298). 1 November 2002.

