

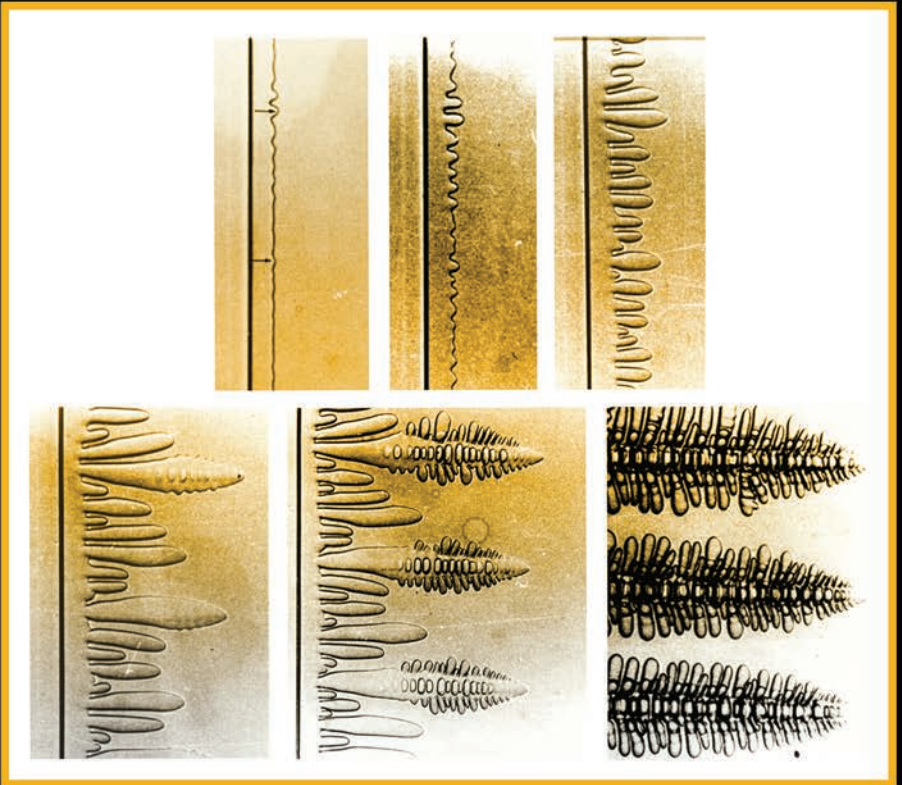

A Researcher's Guide to:

INTERNATIONAL SPACE STATION

Microgravity Materials Research



This International Space Station (ISS) Researcher's Guide is published by the NASA ISS Program Science Office.

Authors:

James Patton Downey

Executive Editor: Amelia Rai

Technical Editor: Neesha Hosein

Designer: Cory Duke

Cover and back cover:

- a. *Directional solidification of a transparent organic material in a narrow, pseudo two-dimensional cell at increasing solidification rates. An initially flat solidification front develops fingerlike cells which become increasingly deep and eventually develop dendritic, tree-like structures as the solidification rate increases. Similar fully three dimensional experiments are carried out in microgravity to understand gravitational effects on the formation of bulk materials and their resultant properties. (Image credit: K. Somboonsuk., Ph.D. thesis, Iowa State Univ, Ames, IA (1984))*
- b. *A sample of a metal alloy being levitated and heated by the Electro-Static Levitator at NASA's Marshall Space Flight Center. Lasers are used to charge and melt the initially solid samples. Electric fields are used to levitate and manipulate the samples. Alloy properties such as heat capacity, viscosity, surface density, density, and solidification nucleation rates, which would ordinarily be impossible to obtain due to the reactivity of the hot metal with container walls may be obtained from levitated samples. ISS levitation experiments allow for a much wider range of manipulation of the samples due to the absence of gravity. (Image credit: NASA's Marshall Space Flight Center)*

The Lab is Open

Flying 250 miles above the Earth, the ISS provides a platform for research to improve life on Earth, enable space exploration, and understand the universe. This researcher's guide is intended to help potential ISS materials science researchers plan experiments utilizing the microgravity environment in order to understand how heat and mass transfer affects materials processing. It covers the nature of the acceleration environment on ISS, available facilities for conducting materials research, examples of previous microgravity materials research, and current materials science projects being developed for execution on the ISS.



Astronaut Clay Anderson at the Microgravity Science Glovebox on the International Space Station.





Unique Features of the ISS Research Environment

- 1. Microgravity**, or weightlessness, alters many observable phenomena within the physical and life sciences. Systems and processes affected by microgravity include surface wetting and interfacial tension, multiphase flow and heat transfer, multiphase system dynamics, solidification, and fire phenomena and combustion. Microgravity induces a vast array of changes in organisms ranging from bacteria to humans, including global alterations in gene expression and 3-D aggregation of cells into tissue-like architecture.
- 2. Extreme conditions** in the ISS environment include exposure to extreme heat and cold cycling, ultra-vacuum, atomic oxygen, and high-energy radiation. Testing and qualification of materials exposed to these extreme conditions have provided data to enable the manufacturing of long-life, reliable components used on Earth as well as in the world's most sophisticated satellite and spacecraft components.
- 3. Low-Earth orbit** at 51 degrees inclination and at a 90-minute orbit affords ISS a unique vantage point with an altitude of approximately 240 miles (400 kilometers) and an orbital path over 90 percent of the Earth's population. This can provide improved spatial resolution and variable lighting conditions compared to the sun-synchronous orbits of typical Earth remote-sensing satellites.

Table of Contents ---

The Lab is Open	3
Unique Features of the ISS Research Environment	5
Why Use ISS as a Laboratory for Materials Research	8
Microgravity Acceleration Environment	9
Quasi-Steady Accelerations	9
Periodic Acceleration	10
Transient Accelerations	11
Acceleration Examples	11
Facilities For Materials Research	14
Logistics, Operations, and Accommodations of Flight Experiments	14
Materials Science Research Rack (MSRR)	14
Materials Science Laboratory Capabilities	15
Low Gradient Furnace	16
Solidification and Quenching Furnace	16
Microgravity Science Glovebox Hardware	18
Coarsening of Solid-Liquid Mixtures Hardware	19
Pore Formation and Mobility Investigation (PFMI) MSG Hardware	21
Solidification Using a Baffle in Sealed Ampoules Hardware	23
Expedite the Processing of Experiments to Space Station (EXPRESS) Racks	24
Examples Of Previous Microgravity Materials Research	26
Coarsening in Solid-Liquid Mixtures (CSLM)	26
Solidification Using a Baffle in Sealed Ampoules (SUBSA)	27
Toward Understanding Pore Formation and Mobility During Controlled Directional Solidification in a Microgravity Environment Investigation	28
In-Space Soldering Investigation (ISSI)	29
Comparison of Structure and Segregation (CSS) in Alloys Directionally Solidified in Terrestrial and Microgravity Environments	31
Dynamic Selection of 3-D Interface Patterns in Directional Solidification	32
Future ISS Materials Science Research	34
Introduction	34
Directional Solidification Experiments of Semiconductor Materials	34
Reduction of Defects in Germanium-Silicon	34
Crystal Growth of Ternary Semiconductors	35
Modeling of Particle Transport in the Melt and its Interaction with the Solid-Liquid Interface	35

Directionally Solidified Alloys	35
Dynamical Selection of Three-Dimensional Interfacial Patterns in Directional Solidification	36
Effect of Convection on Columnar-to-Equiaxed Transition in Alloy Solidification	36
3-D Structures and Interface Dynamics Univariant and Invariant Eutectic Solidification in a Ternary Alloy	37
Effect of Varying Cross-Section on Dendrite Morphology and Macrosegregation	37
Integrated Computational and Experimental Studies of Complex Dendritic Microstructure Development during Directional Solidification of Metallic Alloys	38
Modeling Peritectic Microstructure Formation during Directional Solidification in Space and on Earth	38
Isothermally Processed Alloys	38
Gravitational Effects in Distortion in Sintering	39
Effect of Varying Convection on Dendrite Morphology and Macrosegregation	39
Thermophysical Property Measurement via Electro-Magnetic Levitation Experiments	40
Quasi-Crystalline Undercooled Alloys for Space Investigation (QUASI)	41
Thermophysical Properties and Solidification Behavior of Undercooled Ti-Zr-Ni Liquids Showing an Icosahedral Short-Range Order (ICOPROSOL)	41
Thermolab	41
Peritectic Alloy Rapid Solidification with Electro-Magnetic Convection (PARSEC)	42
Levitation Observation of Dendrite Evolution in Steel Ternary Alloy Rapid Solidification	42
Citations	44
Acronyms	45

Why Use ISS as a _____ Laboratory for Materials Research

Most materials are formed from a partially or totally fluid sample and the transport of heat and mass from the fluid and into the solid inherently influences the formation of the material and its resultant properties. The International Space Station (ISS) provides a long-duration spaceflight environment for conducting microgravity experiments whose purpose is to examine the effect of heat and mass transport on materials processes. The microgravity environment greatly reduces buoyancy-driven convection, pressure head and sedimentation in fluids. The reduction in these gravity-related sources of heat and mass transport may be used to determine how the material processes are affected by gravitational-driven and gravitationally independent sources of heat and mass transfer.

Microgravity Acceleration Environment

The ISS is in orbit, also called free fall, around Earth. The force of Earth's gravity on the ISS is not much less than the force ISS would experience if it were on Earth's surface. Intuitively, it would seem that the orbital experimental environment would not be much different than on Earth's surface either.

However, there is an important experimental difference. On the ground, the experiment containers are fixed to the surface of the Earth and do not move even though they are experiencing one g of force. However, the fluids in the containers are free to move within their containers and deform based on the force of gravity with the more dense material sinking to the bottom and displacing the less dense material to the top. In contrast, the entire space station including the experiment containers and the fluids within are all moving because of gravity. The differences between the acceleration of the ISS, its experiment containers, and the samples within are quite small. As a result, there is very little sedimentation or buoyancy-driven convection occurring within fluid bodies during ISS experiments. The small difference in acceleration between the orbiting sample and the ISS equipment holding the sample typically averages on the order of one millionth of a g, one microgravity of acceleration. This is the origin of the term "microgravity environment." It is critical for investigators to remember that the effective ISS environment on experiment samples is not zero g. Most useful microgravity materials investigations require that any sedimentation velocity or density-driven fluid velocity be much smaller than diffusive transport within a length scale of interest. The following sections provide a short description of the accelerations experienced relative to the laboratory frame of reference, i.e., the space station.

Quasi-Steady Accelerations

One source of acceleration is drag from the upper atmosphere, and this drag is typically on the order of less than 10⁻⁷g's. The drag decelerates ISS and anything firmly attached to it. The fluid samples are not firmly attached and therefore begin to deform as they would on the ground, though to a much less degree, with the less dense material moving towards the direction of the drag acceleration on ISS relative to the more dense material. Another, larger source of acceleration affecting ISS experiment samples is the so-called gravity gradient. The acceleration of gravity vector, g, on an Earth-orbiting object varies according to:

$$\mathbf{g} = (GM/R^3)\mathbf{R}$$



This is where G is the gravitational constant, M is the mass of the Earth, and R is the vector between the object and the center of the Earth. From the equation, it is clear that g varies with orbital position, and it is from this equation that the term gravity gradient, dg/dR , is derived. At the ISS orbit, the value of g varies about 0.3 micro-gs/meter along the direction of R . It also varies by about 0.1 microg/meter along the axis perpendicular to both R and the orbital path of ISS. The direction of the movement of ISS along this path is known as the velocity vector. The effect of gravity gradient can be imagined easily. If an experiment is above the ISS center of mass, i.e., the experiment location has a larger R than ISS, then it is farther from Earth and is not accelerated as much by Earth's gravity as ISS. Since the experiment container is firmly attached to ISS, this implies ISS must exert an additional small acceleration on the container so that it travels with ISS. The fluid sample in the container feels Earth's acceleration just like the container, but since the fluid is not rigidly attached to ISS, it deforms because of the slightly different acceleration between itself and the ISS/container. Similarly, if an experiment container is located to the side of the orbital plane of the ISS orbit, then the experiment container would tend to drift across the plane of the orbit of ISS if the ISS did not exert acceleration on the experiment container to keep it fixed in place relative to ISS. The above accelerations can typically be considered as steady for the purposes of most experiments. Other accelerations occurring on ISS have more time-dependent aspects.

Periodic Acceleration

ISS has a number of sources of vibrations such as flexing of the structures of ISS, movements of astronauts particularly during exercise, the motions of equipment, etc. The acceleration that is due to oscillations is somewhat more complex for an investigator to analyze. At low-frequency oscillations, a fluid may behave as if it is subjected to a quasi-static force. Alternatively, high-frequency oscillations would exert little influence on fluid motions since viscosity prevents the fluid from developing significant motion during the short duration of time between the application of acceleration in one direction and the subsequent reversal that is due to the periodic nature of an oscillatory acceleration. The transition between the behavior observed at low- and high-frequency accelerations is gradual and depends on the properties of the fluid and the length scale of interest. This transition occurs when the value of a diffusive property of the fluid is about equal to the angular frequency of the vibration, ω , times the relevant length scale squared, i.e., $D = \omega L^2$.

Periodic oscillations have the effect of adding to the apparent dissipation of momentum, heat and species. The additional effect of a periodic oscillation on the apparent value of these quantities can be approximated by the following:

$$v_{\text{eff}} = [v^2 + (\omega L)^2]^{1/2}$$

$$\alpha_{\text{eff}} = [\alpha^2 + (\omega L)^2]^{1/2}$$

$$D_{\text{eff}} = [D^2 + (\omega L)^2]^{1/2}$$

In these equations, v , α , and D are the kinematic viscosity, thermal diffusivity, and molecular diffusivity respectively. A good review of this subject is Chapter 17 of Fluid Sciences and Material Science in Space, editor H.U. Walter, published by Springer Berlin (1987).

Transient Accelerations

Other vehicles visit the ISS and in these docking or berthing events, the ISS velocity is altered. An even larger change in velocity occurs when the orbit of the ISS is adjusted. Unlike the vibrational accelerations discussed above, there is no periodicity to these acceleration events. The resultant disturbance on a fluid body attached to ISS is typically analyzed on the product of acceleration times the duration, i.e., the change in velocity. During these events, the less dense regions of fluid will accelerate in the direction of the change in velocity relative to the more dense regions of fluid. Microgravity investigations are not typically run during these events to avoid the impacts associated with them.

Acceleration Examples

The ISS has accelerometers, which record the acceleration environment and models to predict the accelerations experienced based on the various motors, machinery and activities occurring on ISS. The accelerations can be displayed in any of a number of manners depending on the details of greatest interest. One common format is to use a Fourier transform to show the accelerations as a function of frequency rather than time. The following are some plots showing examples of the ISS environment in some of the formats used most frequently.

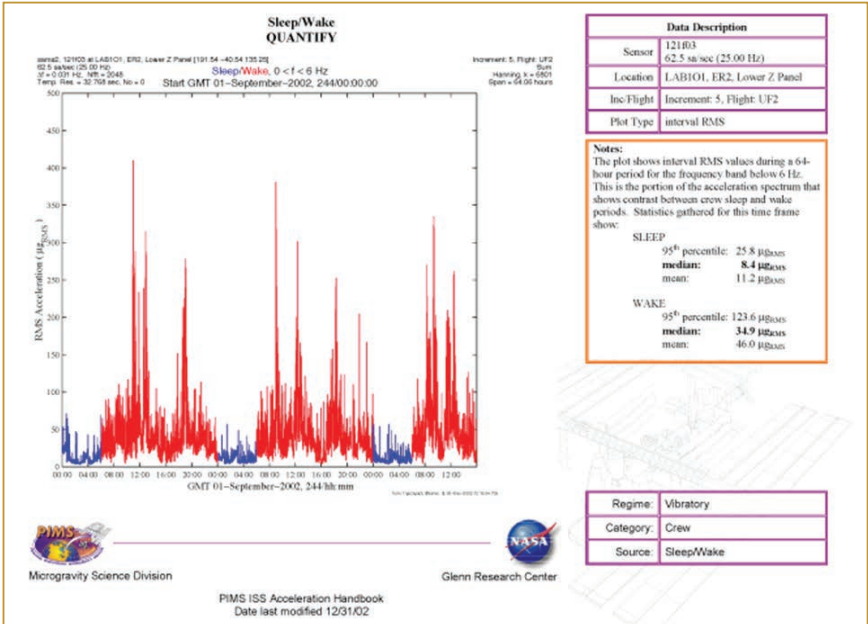

Figure 1. Root Mean Square depiction of the ISS laboratory environment as a function of time. Acceleration units are in micro-g's. The lowest accelerations occur during the crew sleep periods colored in blue in the figure.

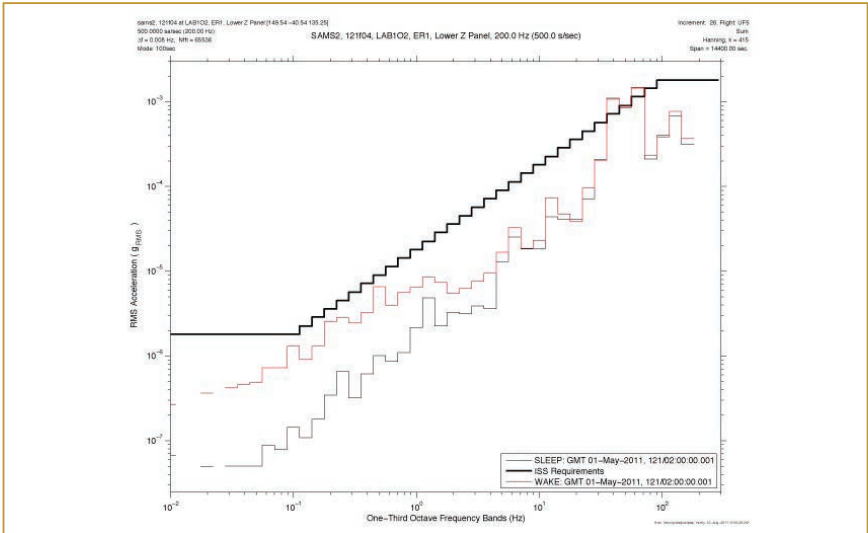

Figure 2. Root Mean Square plot of the accelerations as a function of frequency during crew sleep (thin black line) and during the crew active time frame (red line). Acceleration units are unit gravity. The thick black line is the ISS maximum microgravity requirement. Note that this requirement only applies to experiment racks equipped with an Active Rack Isolation System (ARIS) during specially scheduled periods and does not apply to the frequent time periods when the floating part of an ARIS equipped rack is recentered.

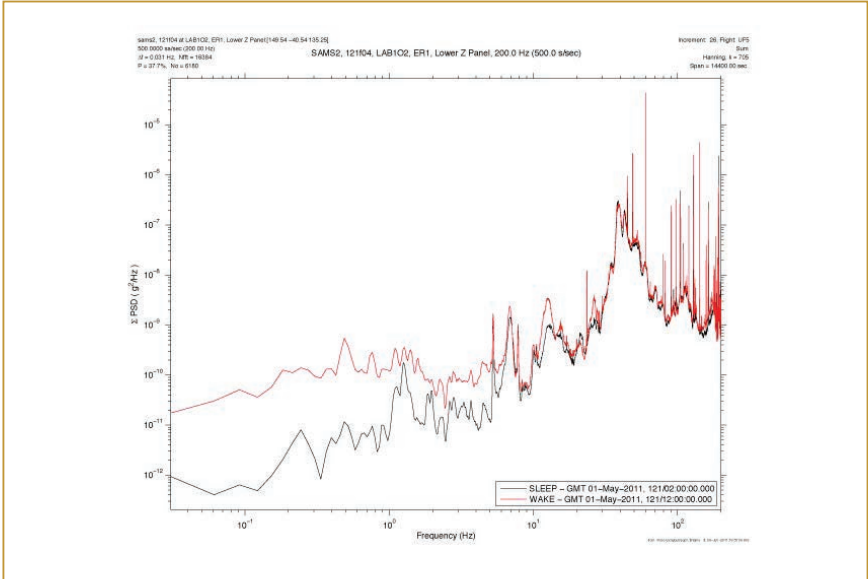

Figure 3. The Power Spectral Density of the accelerations as a function of frequency as a function of crew wake (red line) and sleep (black line) periods.

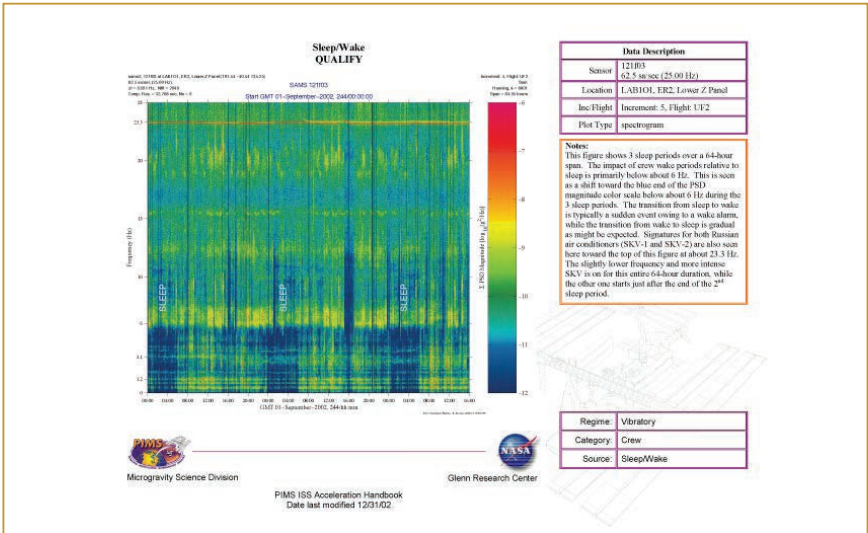

Figure 4. Power spectral density (color with the scale shown on the right) plotted as a function of time (horizontal axis) and frequency (vertical axis). Acceleration units are unit gravity. The less intense disturbances are seen during the crew sleep periods.

Facilities For Materials Research

The following sections cover facilities and accommodations used to support microgravity materials experiments on the ISS.

Logistics, Operations, and Accommodations of Flight Experiments

Logistics vehicles deliver the experiments to ISS. These experiments are performed on ISS using some combination of crew control, autonomous pre-programmed operations, or ground commanding of the hardware. Most of the payloads carried by the logistics vehicles are in an ambient environment, but refrigerators and freezers are available for some temperature-sensitive payloads.

Materials Science Research Rack (MSRR)

The Materials Science Research Rack (MSRR) is a research facility developed under a cooperative research agreement between NASA and European Space Agency (ESA) for materials science investigations on the ISS.

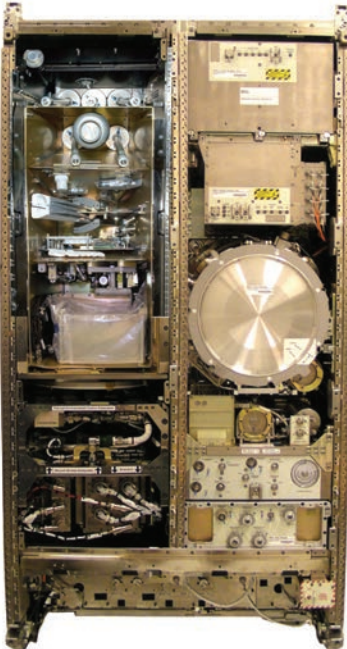

Figure 5. Materials Science Research Rack on-orbit configuration.

The MSRR accommodates advanced investigations in the microgravity environment of the ISS for basic materials science research in areas such as solidification of metals and alloys. The purpose is to advance the scientific understanding of materials processing as affected by microgravity and to gain insight into the physical behavior of materials processing. MSRR allows for the study of a variety of materials including metals, ceramics, semiconductor crystals and glasses.

MSRR is a highly automated facility with a modular design capable of supporting multiple types of investigations. Currently, the NASA-provided Rack Support Subsystem provides services (power, thermal control, vacuum access, and command and data handling) to the ESA-developed Materials Science Laboratory (MSL), which accommodates interchangeable Furnace Inserts (FI). Prior to the flight to ISS, the samples to be processed in the FIs are loaded

into ampoules or crucibles and then into cartridges, which are utilized to assure chemical containment. These Sample Cartridge Assemblies (SCAs) are then loaded into the FI, processed, and returned to earth for analysis. Two ESA-developed FIs are presently available on the ISS and can be changed out in orbit: the Low Gradient Furnace (LGF) and the Solidification and Quenching Furnace (SQF). Both of these FIs are Bridgman furnaces capable of operating between 500 and 1200C.

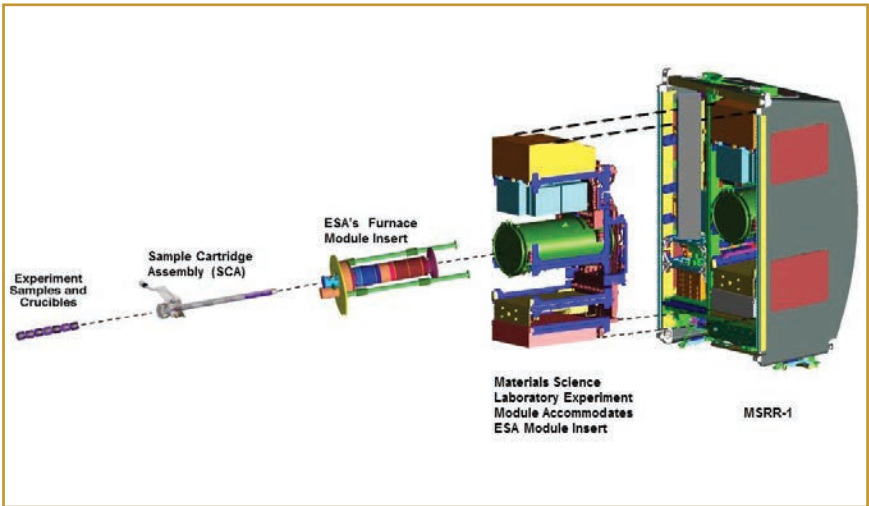

Figure 6. Exploded view of the nested Sample, Sample Cartridge Assembly, Furnace Insert, and Materials Science Laboratory integration into the Materials Science Research Rack.

Materials Science Laboratory Capabilities

The MSL provides the following:

Translation – FIs may be translated relative to the SCAs at speeds ranging from 10-5 to 0.2 mm/sec and translation of about 100 mm/sec for quench operations, and FI translation of up to 15 cm.

Furnace environment – MSL provides a furnace environment of vacuum or Argon environment up to 300 mbar.

Sample temperature measurements – Temperature measurements within Sample Cartridge Assemblies may be made at frequencies up to 10 Hz by up to 12 thermocouples with 16-bit resolution over 45 mV range and with an accuracy of 30 μvolts. The cold junction is monitored by a Platinum 100 resistance thermometer. These measurements can be followed on the ground in real time.

Current Pulses – Current pulses can be delivered into the sample in order to create a transient disturbance/heating at the liquid solid interface. Pulses can have a maximum voltage of 80 V at 50 Amps or with a maximum current of 100 Amps at 40 V.

Rotating Magnetic Field – A rotating magnetic field may be applied to the sample in order to stir the liquid volume. The frequency range is 5-400 Hz. Field strength at 100 Hz is 4.1 mT and is 1.5 mT at 400 Hz. Frequencies are controllable to approximately +/-10 Hz at and above 100 Hz. A constant field may also be applied to the sample if desired.

Programming – Commands can be sent from the ground through the MSRR to the MSL to pause or reprogram operations during SCA processing.

Low Gradient Furnace

The LGF is designed to achieve a well-controlled low or medium thermal gradient inside the volume of the sample located in an adiabatic zone found between the high-temperature and the low-temperature heater zones of the LGF. Sample crucibles or ampoules of up to 24 mm outside diameter may be processed in this furnace. The furnace has seven heated zones and an adiabatic zone. The zones and their respective lengths are in order the hot zone guard heater/24 mm, two hot zone plateau heaters 74.5 mm each, the hot zone booster heater/27 mm, the adiabatic zone/51 mm, the cold zone booster heater/25 mm, the cold zone plateau heater 77 mm, and the cold zone booster heater 27 mm. The LGF can achieve thermal gradients of approximately 30 C/cm or less for samples such as Aluminum.

Solidification and Quenching Furnace

The SQF is a furnace with four heated zones, an adiabatic zone, and zone with a quench ring. Sample crucibles or ampoules of up to 16 mm outside diameter may be processed in this furnace. The furnace zones and their respective lengths are in order: the hot zone guard heater/24 mm, two hot zone plateau heaters/96.5



mm each, the hot zone guard heater/24 mm, the adiabatic zone 50 mm, and the cold zone (zone with the quench ring)/166 mm. The quench ring contains a low-temperature melting alloy and interfaces to a water loop. The ring makes direct contact with the outer wall of the SCA in order to remove heat from the sample rapidly or to achieve high gradients. The ring is fastened to a SCA prior to flight and is attached to the MSL water loop interface when the SCA is installed in the SQF. The ring translates with the MSL relative to the SCA during processing. Sample thermal gradients above 100 C/cm may be achieved using the ring. If the ring is not utilized then thermal gradients of metallic samples as high as 20 C/cm may be achieved by radiative cooling of the sample. Cooling rates on the order of 100 C/sec may be achieved by rapid translation of the SCA past the cooling ring.

Microgravity Science Glovebox Hardware

The Microgravity Science Glovebox (MSG) enables scientists from multiple disciplines to participate actively in the assembly and operation of experiments in space with much the same degree of involvement they have in their own research laboratories. Developed by ESA and managed by NASA's Marshall Space Flight Center (MSFC), the MSG was launched on the Space Shuttle *Endeavor*, STS-111, ISS Flight UF2, in June 2002. The MSG facility offers an enclosed 255-liter (9-cubic-foot) work area accessible to the crew through glove ports and to ground-based scientists through real-time data links and video. Because the work area is sealed and held at a negative pressure relative to the lab, the crew can manipulate experiment hardware and samples without the danger of small parts, particulates, fluids, gasses, or biological material escaping into the open laboratory module.

An airlock under the Work Volume (WV) can be accessed to bring objects in safely while other activities are going on inside MSG. The MSG has 40-cm diameter side ports equipped with rugged gloves that are sealed to prevent leaks for setting up and manipulating equipment in the WV. A coldplate provides cooling for experiment hardware, and the air is continuously circulated and filtered. Experiments are provided with as much as one kilowatt of power and heat dissipation.

Vacuum, venting, nitrogen gas input (that can keep the oxygen volume at 10 percent or less), power and data interfaces are also provided within MSG. A video system consists of a self-standing subsystem of four color cameras, two monitors, two analog recorders and two digital recorders integrated into an International Subrack Interface Standard drawer. The command and monitoring panel



system consists of a self-standing subsystem of four color cameras, two monitors, two analog recorders and two digital recorders integrated into an International Subrack Interface Standard drawer. The command and monitoring panel



Figure 7. Left: The Microgravity Science Glovebox Rack on ISS. Right: A view of the working volume of the MSG.

monitors the facility status and performance and provides for manual operation of MSG by the crew.

In order to support life science research, MSG provides disposable exam gloves and specialized filters for handling typical life science materials. MSG also has an ultraviolet LED decontamination system. The MSG accommodates small and medium-sized investigations from any disciplines including biotechnology, combustion science, life sciences, fluid physics, fundamental physics and materials science. Many of these experiments use chemicals, burning or molten materials or other hazards that must be contained.

Coarsening of Solid-Liquid Mixtures Hardware

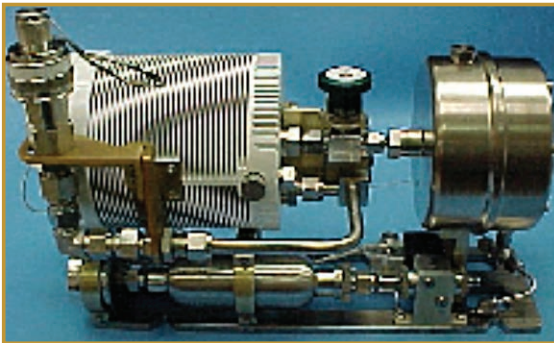

Figure 8. Left: The Coarsening of Solid-Liquid Mixtures Sample Processing Unit. Right: The Electronics Control Unit.

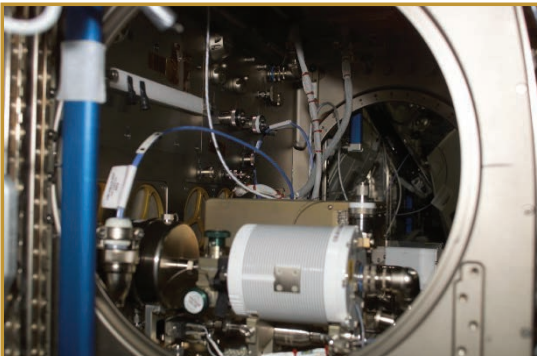

Figure 9. Images of the Coarsening of Solid-Liquid Mixtures's Sample Processing Unit and Electronics Control Unit mounted inside the Microgravity Science Glovebox on ISS Expedition 7.

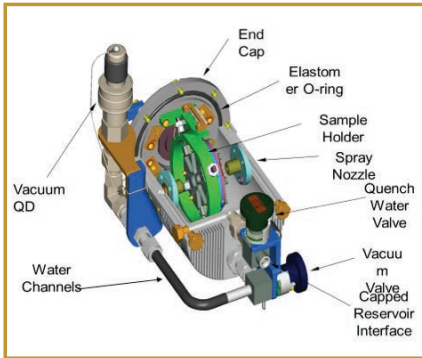

Figure 10. Coarsening of Solid-Liquid Mixture's Sample Processing Unit sample chamber interior.

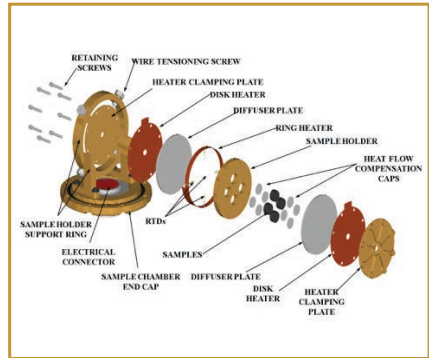

Figure 11. Coarsening of Solid-Liquid Mixture's Sample Processing Unit sample holder.

The Coarsening of Solid-Liquid Mixtures (CSLM) is an example of hardware flown in the MSG. CSLM has been successfully operated on ISS since 2003 with five separate launches of Sample Processing Units. CSLM consists of an Electronics Control Unit (ECU), which functions as the Data Acquisition & Controller and the Sample Processing Units (SPUs) that house the samples to be processed. Briefly, the function of the ECU is to control the heaters in the SPU and maintain the required temperature up to 185°C for a specific period of time at which point the ECU commands the SPU to quench cool the samples using ambient temperature water. During the entire time, the ECU is recording the temperature data from the four resistance temperature devices embedded in the SPU. Data is transferred to the MSG laptop and downlinked to the ground.

The SPU houses the four samples that are to be processed. In order to reduce the convective heat transfer, the SPU can be evacuated to approximately 1×10^{-6} Torr on the ground prior to launch as well as drawing down the pressure just before processing using the ISS Vacuum Exhaust System. The SPU consists of resistive heaters and RTDs to monitor the temperature and provide closed-loop control signals back to the ECU. Each location is exactly measured to provide the investigator with the information required to size their samples such that when heated to maximum temperature, they encompass no more than the available volume.

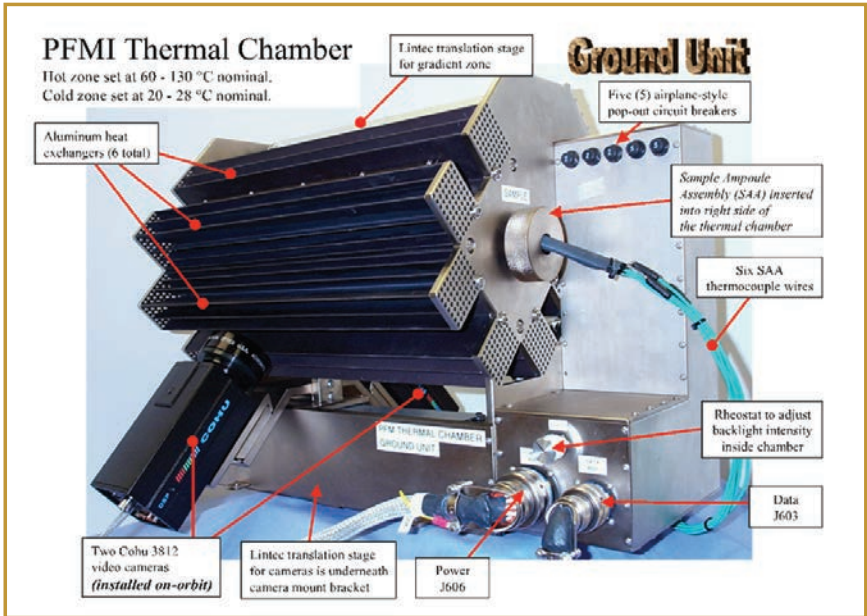

Figure 12. Labeled photograph of the PFMI Hardware.

Pore Formation and Mobility Investigation (PFMI) MSG Hardware

The Pore Formation and Mobility Investigation (PFMI) apparatus has also been developed for operation in the ISS MSG. PFMI hardware allows the observation of directional solidification of transparent samples. The hardware also allows the injection of bubbles into the melt. Examples of solidification physics which may be studied include bubble dynamics, tracer particle movement induced by gravity independent thermocapillary forces, and planar front to dendrite transitions.

The solid/liquid interface, or some other region of interest, is observed and recorded by two solid state cameras offset by ninety degrees. Camera magnifications, camera positions, samples temperatures, and translation rates may be monitored and can be changed in real time via ground control.

The temperature range of the hardware is approximately 5 to 120 degrees Celcius.

PFMI Furnace Capabilities & Critical Performance Parameters	
Type of Processing	Bridgman
*Max Thermal Gradient	Up to 50° C/cm
Transparent Gradient Zone Length	2.5 cm to 0.5 cm, selectable
Max. Sample Outside Diameter	10 mm
Max. Sample Length	23 cm
*Max Sample Processing Length	12 cm
Max. Heater Temperature	130° C
Cold Zone Min. Temperature	5° C
Heater Stability	+/- 1° C
Translation Velocity	0.5 micrometers/sec to 100 micrometers/sec
Translation Stability	+/- 5%
Sample Ampoule Dimensions	OD 12.75 mm, Length 28 cm
Sample Instrumentation	Up to 6 Type K Thermocouples on the inside of the ampoule
Temperature Data Recording Rate	Up to 1/sec
Video	S video record rate 30fps, zoom22:1, two camera view
Commanding	Remote commanding of heater/cold zone temp. & camera zoom/focus
* Depends on sample material & configuration	

Table 1. A summary of the PFMI furnace chamber capabilities.

Gradient freeze and isothermal experiments are also possible. A summary of the operating parameters is given in the table below.

The sample ampoule is constructed of Dow Corning 7052 borosilicate glass. A stainless steel spring with a kovar piston allows for thermal expansion and contraction of the sample material. Six stainless steel sheathed type k thermocouples inside the sample provide temperature data during processing. The PFMI investigation utilizes an innovative approach for heating the sample. A thin, transparent layer of Indium Tin Oxide (ITO) is deposited on the exterior surface of the Sample Ampoule Assemblies (SAA). The ITO coating is electrically conductive and acts as a resistance heater when current is applied. Forward and aft electrode

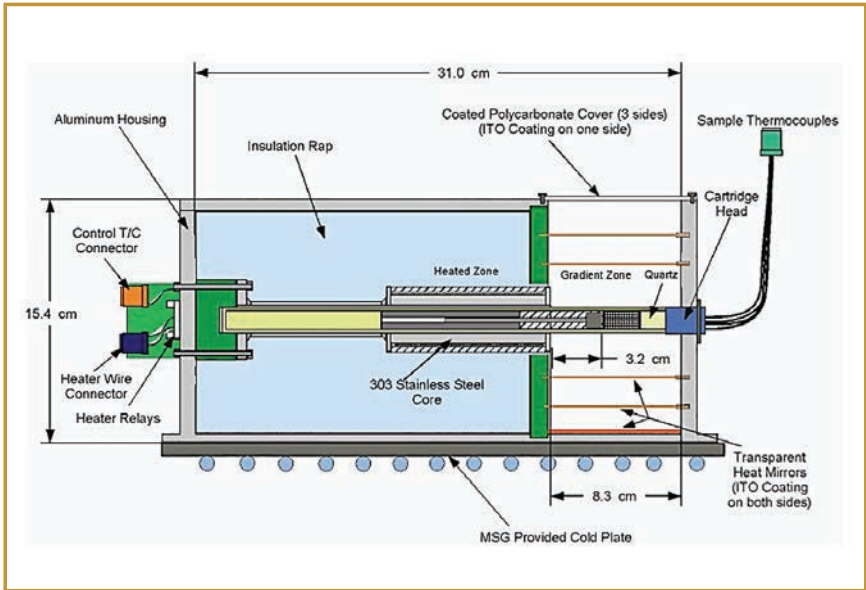

Figure 13. Cross-section of the SUBSA furnace. The sample is immediately to the left of the quartz plug. The baffle assembly is left of the sample.

rings that provide electrical contact with the sample. To process the sample, a cold zone utilizing four Thermal Electric Devices (TEDs) is translated along the sample along with the forward electrode ring. As the cold zone and electrode ring are translated, the hot zone shortens and heat is removed from the sample to the radiators by the cold zone. Additional thermal capabilities are possible by using an independently heated zone melting ring that is placed near the cold end.

Solidification Using a Baffle in Sealed Ampoules Hardware

The Solidification Using a Baffle in Sealed Ampoules (SUBSA) furnace has been developed for operation in the ISS MSG. The furnace provides for solidification of samples via the gradient freeze technique. A schematic view of the furnace is shown on next page.

SUBSA furnace capabilities are summed up in the Table below.

SUBSA Furnace Capabilities & Critical Performance Parameters	
Type of Processing	Gradient Freeze
Min. Cooldown Rate	0.5° C/min
*Max Thermal Gradient	Up to 110° C/cm
Transparent Gradient Zone Length	8 cm
Max. Sample Outside Diameter	12 mm
Max. Sample Length	30 cm
*Max Sample Processing Length	13 cm
Max. Heater Temperature	850° C
Heater Stability Control	+/- 0.15° C
Sample Ampoule Dimensions	OD 16 mm, Length 30 cm
Sample Instrumentation	Up to 4 Type K Thermocouples on the outside of the ampoule
Temperature Data Recording Rate	Up to 1/sec
Video	S video record rate 30fps, zoom22:1, one camera view
Commanding	Remote commanding of heater temp. & camera zoom/focus
* Depends on sample material & configuration	

Table 2. A listing of SUBSA Capabilities.

Expedite the Processing of Experiments to Space Station (EXPRESS) Racks

Eight EXPRESS Rack facilities within the ISS laboratories provide standard resources and interfaces for the simultaneous and independent operation of multiple experiments within each rack. Currently, five EXPRESS Racks are located in the U.S. Laboratory, two in the Japanese Experiment Module, and one in the ESA Laboratory.

Each EXPRESS Rack provides eight locker locations and two drawer locations for powered experiment equipment (payloads). Payload developers may use NASA-provided lockers or provide their own structure to occupy the equivalent volume of one, two or four lockers as a single unit. Interior locker dimensions are 17.34 x 9.97 x 20.32 inches with beveled edges.

Resources provided for each locker or drawer location include:

- Power (28 Vdc, 0-500 W).
- Command and data handling (Ethernet, RS-422, 5 Vdc discrete, +/- 5 Vdc analog).
- Video (NTSC/RS 170A).
- Rear air cooling (0-200 W).

The Ethernet bandwidth is 100 Mbps. This upgrade is now imminent. Each rack also provides water cooling (coldplates) from the ISS moderate temperature loop for two payload locations (500 W each), one vacuum exhaust interface and one gaseous nitrogen interface. Standard interfacing cables and hoses are provided in orbit. One Windows-based laptop computer is provided with each EXPRESS Rack to control the rack and to accommodate payload application software. Four of the racks can be equipped with the Active Rack Isolation System to reduce vibration between the ISS and the rack.

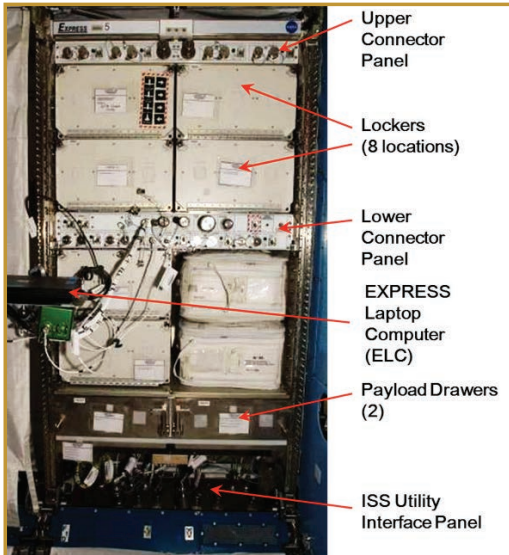

NASA provides EXPRESS Rack simulator software for payload developers to develop and checkout payload command and data handling at the developer's site before integrating the payload with the EXPRESS Functional Checkout Unit at MSFC for an end-to-end test before flight.

EXPRESS Racks began supporting investigations aboard ISS on April 24, 2001, and will continue to be available for science experiments through the life of ISS.

Figure 14. Expedite the Processing of Experiments to Space Station Rack configuration.

Examples Of Previous Microgravity Materials Research

Microgravity materials science research began during the Apollo Program with directional solidification experiments involving semiconductor materials. In Apollo 14, a small, low-temperature furnace was used to cast or directionally solidify a number of two- and three-phase systems. It was found that the dispersion of the phases was much more uniform because of the lack of sedimentation. More sophisticated experiments were conducted on Skylab involving directional solidification of semi-conductors crystals and eutectic materials, brazing, containerless processing to form spheres, etc.

This research continued during the Space Shuttle Program. One notable experiment from the early shuttle flights involved the creation of the first commercial material formed in space. Spherical standards were created from an emulsion of styrene monomers. This emulsion was unstable under normal 1-g conditions because of sedimentation but was quite stable in microgravity. The emulsified styrene monomers were polymerized in orbit to form highly uniform spheres. See Vanderhoff, et al. *J. Dispersion Sci. Technology* (1984), 5, 231-246.

Microgravity materials research has now moved into the ISS era. Some initial experiments have been performed already and are briefly described below.

Coarsening in Solid-Liquid Mixtures (CSLM)

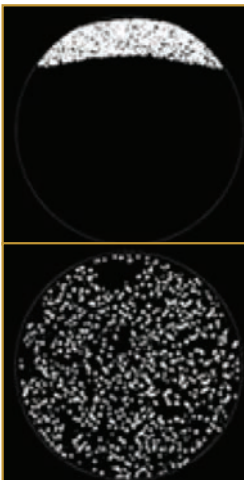

This experiment was a follow-on from space shuttle experiments. The ISS experiments were conducted within the sealed Microgravity Sciences Glovebox work volume during Increment 16 in December 2007 and Increment 17 in April 2008. The CSLM experiment was a materials science spaceflight investigation whose purpose was to investigate the kinetics of competitive growth (coarsening) between solid particles essentially suspended within a liquid matrix. CSLM-2 utilized solid particles predominately of tin within a lead-tin liquid. By conducting this experiment

Figure 15. Top: An Earth-based experiment, shows an agglomeration of tin particles (white) that rose to the surface because they are lighter than the host lead-tin liquid. Bottom: With buoyancy forces minimized in a microgravity environment, a reasonably uniform dispersion of tin particles in the liquid was maintained. Image courtesy of J. Alkemper, V. Snyder and P.W. Voorhees, Northwestern University.

in a microgravity environment, detrimental buoyancy and convection effects that arise on Earth were minimized as illustrated in Figure 15.

The CSLM-2 samples were contained within the SPU, which has a large, cylindrical chamber. After processing for a given time and temperature, the sample was rapidly cooled to preserve the coarsened structure for later examination on Earth. Six high-volume fraction (tin) samples were successfully processed and returned to Earth and are being evaluated by the principle investigator. Initial results unambiguously showed that coarsening occurred by transient Ostwald ripening and the absence of gravitationally induced buoyancy allowed measurements of steady-state coarsening kinetics with unprecedented accuracy. An example of the results was provided in the publication by D.J. Rowenhorst, J.P. Kuang, K. Thornton and P.W. Voorhees, “Three-dimensional analysis of particle coarsening in high volume fraction solid-liquid mixtures,” *Acta Mater.* 54, 2027-2039 (2006). Studies of dendrite coarsening have also been conducted in the CSML.

Solidification Using a Baffle in Sealed Ampoules (SUBSA)

The SUBSA investigation was conducted in the MSG aboard the ISS. SUBSA was launched aboard the space shuttle on STS-111/UF-2 on June 5, 2002. Operations were conducted during the Expedition 5 Increment ISS mission. Sample processing occurred between July 10, 2002, and Sept. 11, 2002. The SUBSA samples were

returned to Earth by the space shuttle on STS-113, which landed at NASA’s Kennedy Space Center (KSC) on Dec. 7, 2002. The primary science objectives were to visualize the melt/encapsulant behavior in microgravity and to grow improved indium antimonide (InSb) crystals.

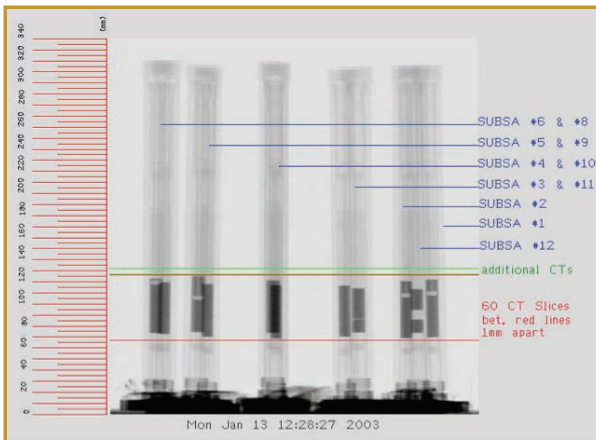



Figure 16. Postflight x-ray images of 11 SUBSA flight ampoules taken at the Computed Tomography Facility at NASA/KSC.

Data obtained from the microgravity SUBSA experiments will advance the field of solidification and the technology of crystal growth and thus facilitate growth of more homogeneous and perfect semiconductor crystals on Earth and in space. Specifically, SUBSA data yield values of diffusion coefficients of dopants, which are indispensable for calculations and modeling needed to optimize production of InSb and the data demonstrate the advantages of growing ternary crystals with segregation coefficients of greater than one in space. This research was presented in a publication by Alexei Churilov and Aleksander Ostrogorsky, “Solidification of Te and Zn doped InSb in space”, AIAA 2004-1309, 42nd AIAA Aerospace Sciences Meeting & Exhibit, January 2004/Reno, Nevada. Future experiments using other semiconductor material are planned with the SUBSA hardware.

Toward Understanding Pore Formation and Mobility During Controlled Directional Solidification in a Microgravity Environment Investigation



Figure 17. Astronaut Jeff Williams changes out tapes during a Pore Formation and Mobility Investigation experiment aboard the International Space Station at the Microgravity Science Glovebox.



The Pore Formation and Mobility Investigation (PFMI) was conducted in the MSG aboard the ISS. It was selected by the NASA Glovebox Investigation Panel and assigned to the Glovebox Program Office at MSFC on Dec. 3, 1997. PFMI was launched aboard the space shuttle on STS-111/UF-2 on June 5, 2002. The first PFMI experiment was initiated on Sept. 19, 2002. Operations were conducted during the Increment 5, 7 and 8 ISS missions. The PFMI study aimed at understanding porosity formation, the mobility of pores, and the relation between material structure and solidification rate during controlled directional solidification in a microgravity environment. The PFMI research utilized a transparent material, succinonitrile.

Seventeen successful PFMI experiments were conducted within the Materials Science Glovebox on the International Space Station. A number of results based on PFMI experiments have been obtained, which include agreement with theory on vapor bubble velocity arising from thermocapillary convection, the first qualitative/quantitative evaluation of aligned gas-solid “eutectic” growth, quantitative assessment of planar interface breakdown in a diffusive environment, and observation of convection in the bulk liquid induced by large bubbles at the interface. The results have advanced the Materials Science field by supplying fundamental data, free of convective effects, for models and theory and by promoting knowledge of bubble behavior in low-gravity environments and their influence on microstructural development. An example of this research was provided by R. N. Grugel, A.V. Anilkumar, and C.P. Lee: “Direct Observation of Pore Formation and bubble mobility during controlled melting and re-solidification in microgravity”, *Solidification Processes and Microstructures: A Symposium in Honor of Wilfried Kurz*, eds. M. Rappaz, C. Beckermann, and R. Trivedi, The Metallurgical Society, Warrendale, PA, 2004, pp. 111-116.

In-Space Soldering Investigation (ISSI)

A proposal entitled the ISSI was submitted in April 2003 and added to the Increment 7 schedule on May 1, 2003. The ISSI research took place over four increments aboard the ISS in the Maintenance Work Area. Ed Lu (Increment 7) prepared the test coupons from the wire stock and Mike Foale (Increment 8) wrapped the wire pieces with solder. Mike Fincke (Increment 9) conducted the first three sets of soldering experiments, the initial one on July 10, 2004. Leroy Chiao (Increment 10) conducted the remaining two sets, the last on Dec. 22,

2004. The samples were returned on Sept. 23, 2005. The investigation took place as “Saturday Science” with the intent of the experiments to look at joining techniques, shape equilibrium, wetting phenomena, and microstructural development in a microgravity environment. Altogether 28 sets comprising 84 simple and repeatable soldering experiments were conducted aboard the ISS. Basically, the experiments entailed conductively melting either five or ten centimeter lengths of stock coiled solder onto a test wire that was heated by a soldering iron. The lengths of solder were either initially wrapped around the test wire or fed onto the heated wire.

Results from the ISSI study include demonstrating that soldering experiments performed aboard the International Space Station were considerably different than their ground-based counterparts. This was due to several factors. One was

the reduction of natural convective flow and buoyancy effects. Another was the presence of gravity-independent thermocapillary flow induced by internal temperature gradients within the molten solder ball. Finally, in microgravity the internally trapped flux is concentrated at a repair joint which is detrimental to the desired strength and thermal/electrical conductivity. The results were published by R.N. Grugel, L.J. Cotton, P.N. Segrè, J.A. Ogle, G. Funkhouser, F. Parris, L. Murphy, D. Gillies, F. Hua,

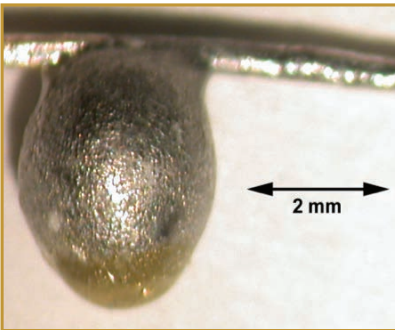
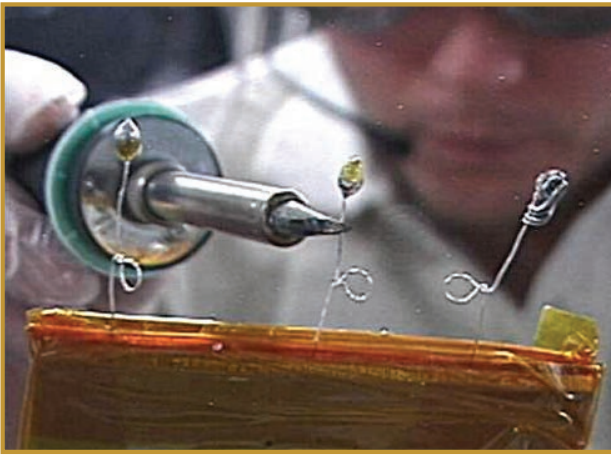

Figure 18. Top ISS Science Officer Mike Fincke conducts a set of melting experiments within the Maintenance Work Area. Bottom: The molten solder forms an equilibrium “football” shape around the wire while the ground-based equivalent barely hangs on the wire.

and A.V. Anilkumar: “The In-Space Soldering Investigation (ISSI): Melting and Solidification Experiments Aboard the International Space Station,” 44th AIAA Aerospace Sciences Meeting and Exhibit, AIAA 2006-521.

Comparison of Structure and Segregation (CSS) in Alloys Directionally Solidified in Terrestrial and Microgravity Environments

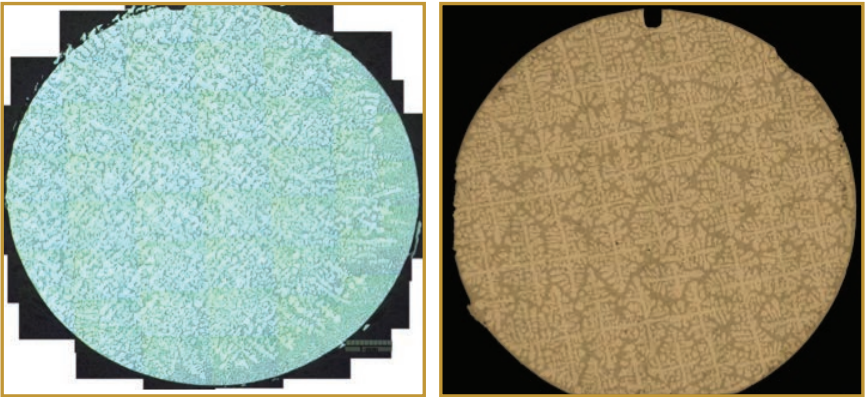

Figure 19. Left: The Aluminum-7 weight percent Silicon sample solidified on Earth exhibits dendrite clustering because of gravity-induced convection. Right: The sample grown in the quiescent microgravity environment of space exhibits a uniformly spaced dendritic network.

The CSS investigation is a collaborative effort with the European “Microstructure Formation in Castings of Technical Alloys under Diffusive and Magnetically Controlled Convective Conditions” Investigation. The CSS experiment is performed in the Materials Science Research Rack. The purpose is to determine microstructural development and provide insight regarding defect generation in directionally solidified dendritic metal alloys. The first U.S. sample was processed aboard the ISS in the LGF on the MSRR/MSL in February 2010; the second sample was processed in January 2011, this time in the SQF module. Both samples have been returned and are currently being evaluated. These samples are characterized by an internal, forest-like, network of metallic branches that directly influence desired material properties. The presence of Earth’s gravity induces buoyancy and convective effects during solidification, which disrupt the developing

structure and compromises material properties. Solidification experiments in microgravity are largely diffusion controlled, which promotes a uniform microstructure and leads to improved material properties. The science to be gained is relevant to the technology of directional solidification castings that are used in gas turbine “jet” engines. Evaluation of the microgravity results is currently taking place.

Dynamic Selection of 3-D Interface Patterns in Directional Solidification

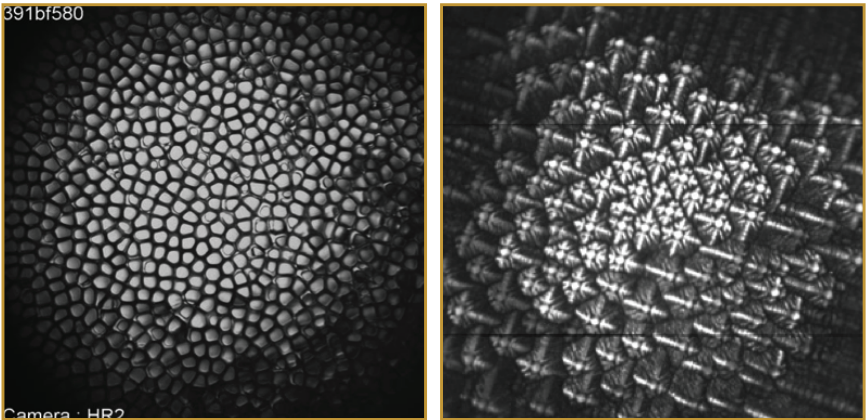



Figure 20. Left: The micrograph shows the cellular structure that develops in a succinonitrile-camphor alloy solidified at $1\mu\text{m/s}$ through a temperature gradient of 28°C/cm . Right: A branched dendritic structure results when the growth velocity is increased. Cellular and dendritic growth and their transitions have been observed and recorded during experiments aboard the ISS. Initial evaluation studies have revealed oscillatory behavior in the diameters of cellular structures under certain conditions. Photos courtesy of R. Trivedi, Iowa State University.

This directional solidification investigation is a joint effort between the U.S. and the French Space Agency (CNES). The solidification experiments take place in the Directional Solidification Insert of the Dispositif pour l'Etude de la Croissance et des Liquide Critiques (DECLIC) facility aboard the International Space Station and were conducted between April 2010 and May 2011. The objective is to obtain benchmark data required for establishing the detailed dynamics of interface pattern selection during the solidification of alloys.



This research is relevant as understanding of the relationship between processing conditions and resultant microstructure would allow the tailoring of materials to obtain desired properties such as strength and toughness. To achieve these goals, a transparent alloy of succinonitrile is melted and solidified multiple times at different solidification rates through different temperature gradients. Optical observations via microscopy and interferometry are used to record the resultant microstructure. Step changes in velocity are used to establish the role of solidification dynamics on the selection of patterns. Evaluation of the microgravity results is currently taking place.

Future ISS Materials Science Research

Introduction

The NASA materials science program currently has 13 flight investigations that will rely on a variety of ISS research facilities. There are additional investigators who provide numerical modeling to flight experiment teams. The materials flight investigations rely on ISS facilities provided by foreign partners, and a number of these investigations are being performed as part of larger research efforts by international science teams. These ISS materials science investigations are to be performed between 2016 and 2018. Additional investigations will be selected via a peer review process as these initial investigations are completed. Brief descriptions of the currently planned investigations are provided below.

Directional Solidification Experiments of Semiconductor Materials

Two flight experiments and one modeling effort are being supported by NASA in the field of semiconductor research. The experiments involve directional solidification of a molten sample at slow growth rates, allowing a single crystal to be formed. These flight experiments will be performed in the MSRR.

Reduction of Defects in Germanium-Silicon

This experiment will investigate the quality of germanium-silicon alloy semiconductors solidified from a molten liquid by a process called detached growth. In detached growth, the liquid-solid boundary is detached or not in contact with the wall of the sample container. This condition is difficult to achieve on Earth

since gravity tends to press the liquid against the container walls. The method is believed to be capable of

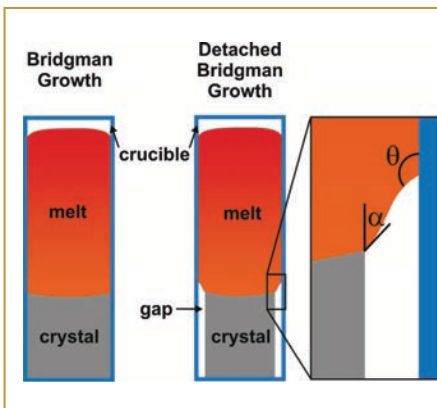

Figure 21. In standard Bridgman growth, a crucible is translated with respect to a furnace temperature profile, directionally solidifying a crystal from the melt. In detached Bridgman growth, a narrow gap exists between the solidifying crystal and the crucible wall. This gap reduces thermal and mechanical stresses, greatly increasing the quality of the crystal. Attainment of detached growth depends on several parameters: the surface tension of the melt, the gas pressure in the gap, the growth angle α between the melt and crystal, and the angle θ with which the melt contacts the crucible wall.

producing high-quality semiconductor crystals since defects often form when the liquid solidifies in contact with the surface of the container wall; but relatively little research has been conducted to date.

Crystal Growth of Ternary Semiconductors

The flight experiment will grow (1) crystals of ZnSe-related ternary semiconductors, such as ZnSeTe, ZnSeS, and ZnCdSe, from the vapor phase, and (2) crystals of CdZnTe semiconductor from the liquid phase. The process of crystal growth from a fluid phase on Earth usually introduces density-gradient driven convection in the fluid. Reduction in such convection in low gravity is expected to yield a nearly diffusion-limited growth condition, which results in more uniform growth rates on the microscopic scale and hence greater crystalline perfection and compositional homogeneity. This reduction of convective contamination in a reduced gravity environment will simplify the coupled mass transport and growth kinetics problem. As a result, an improved comparison between the experimental results and theoretical simulations is expected and will be beneficial to any growth process on Earth involving mass transport in fluid or fluid-crystal interface growth kinetics.

Modeling of Particle Transport in the Melt and its Interaction with the Solid-Liquid Interface

This project provides modeling support to an international team studying the capture and incorporation of impurities into silicon during solidification. For most semiconductor applications, silicon must be exceptionally pure. Manufacturing costs could be greatly reduced if less pure silicon could be used. This study attempts to understand under what circumstances unwanted impurities in the molten silicon are captured in the solid as it forms causing defects. Spaceflight experiments will provide tests for the models of the process without the complications of buoyancy effects and fluid flows.

Directionally Solidified Alloys

Six flight investigations involve the directional solidification of metal alloy samples. An additional two investigations involve modeling of directional solidification of metallic alloys in support of flight experiment teams. One directional solidification flight experiment is conducted in the CNES DECLIC facility. The other flight experiments utilize the MSRR.

Dynamical Selection of Three-Dimensional Interfacial Patterns in Directional Solidification

This series of directional solidification experiments continues the research performed in the CNES built DECLIC facility's Directional Solidification Insert (DSI). The facility utilizes transparent materials to model metallic alloy systems, allowing investigators to observe the evolution of patterns at the solid-liquid interface as they develop. Observations of cellular and dendritic growth and transitions between these growth patterns are to be observed. Initial ISS observations using this facility have already been conducted and interesting oscillatory behavior in the diameters of adjacent cellular structures was observed.

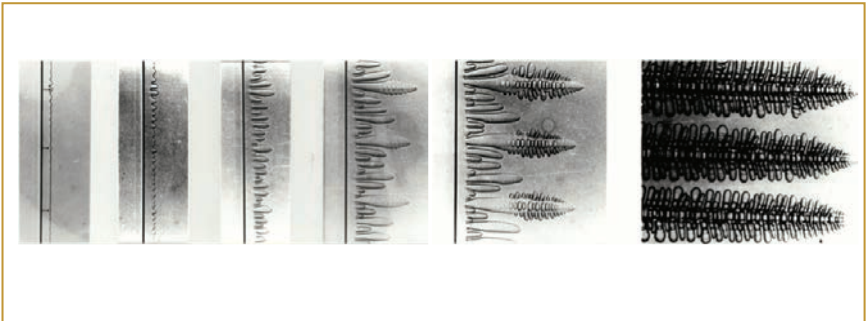

Figure 22. Using a transparent material, it can be observed that as the rate of solidification is increased, the initially smooth liquid to solid interface develops short cells, which lengthen to longer columns, and then transition to increasingly branched dendrites. This is a typical behavior seen in many alloys. Images courtesy of R. Trivedi, Iowa State University.

A fundamental understanding of cellular pattern formation under diffusive growth conditions is to be developed by comparison of model simulations with benchmark data obtained from the DSI investigation.

Effect of Convection on Columnar-to-Equiaxed Transition in Alloy Solidification

The objective of the research is to develop computational models of the columnar-to-equiaxed transition (CET) in alloy solidification. This transition occurs as the structure of the solidifying material shifts from finger-like columns to branched, multi-armed structures as the rate of solidification is increased. The resultant properties of the material are largely dependent on whether it forms columnar or equiaxed structures during casting. Gaining a more complete understanding of the

complex physical phenomena accompanying the CET is important for predicting the grain structure of castings. Open scientific questions include the role played by melt convection, fragmentation of dendrite arms, and the transport of fragments and equiaxed crystals in the melt. The microgravity experiments provide benchmark data for the case where melt convection and solid transport are absent.

3-D Structures and Interface Dynamics Univariant and Invariant Eutectic Solidification in a Ternary Alloy

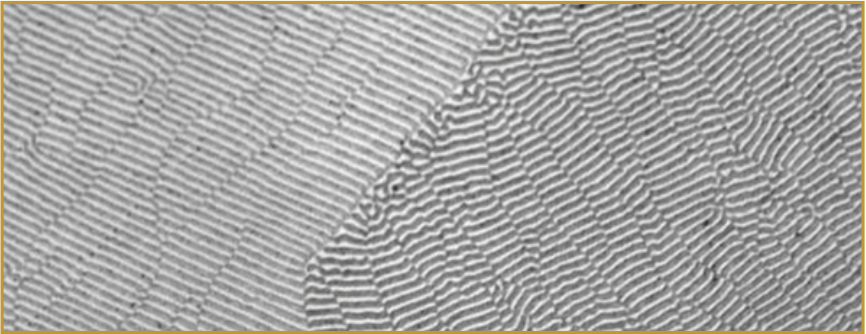

Figure 23. Microscopic image of a grain boundary between a relatively disordered grain on the right and an ordered grain on the left. During the solidification process, the ordered grain grows at the expense of the adjacent, disordered grain. Image courtesy of R. Napolitano, Iowa State University.

This work is to develop a 3-D quantitative model of the multiphase alloy microstructures, involving geometric and crystallographic parameters for phase boundaries, domain boundaries (faults), grain boundaries, and the solid-liquid interface itself, and to employ the model to investigate the dynamics of pattern formation during solidification of ternary alloys, i.e., alloys with three types of atoms. Gradient zone directional solidification experiments with no off-axis thermal gradient, off-axis gradient bias, switching gradients, and rotation will be performed on the ground. Univariant, where the ratio of two of the three components to each other remains constant during solidification, and invariant compositions will be studied. Spaceflight experiments will assist in validation of the model.

Effect of Varying Cross-Section on Dendrite Morphology and Macrosegregation

In commercial metal castings, geometries invariably have changes in cross-sections. Yet convection at a cross-sectional change and its relationship to the formation of

defects in castings has not been studied adequately. This research comprises the following: 1) directional solidification experiments involving an alloy that is more dense as a liquid than solid, an alloy more dense as a solid than a liquid, and an alloy in which the solute is almost density neutral; 2) crucible designs with variable cross-sections; 3) sophisticated analytical characterizations of the solidified microstructures, including both micro- and macro-segregation; and 4) supporting computer simulations.

Integrated Computational and Experimental Studies of Complex Dendritic Microstructure Development during Directional Solidification of Metallic Alloys

This project supports a team performing studies of the formation of columnar and dendritic structures. The aim of the project is to model the formation of dendritic structures in polycrystalline materials where interactions between dendrites in the same grain and grains of different crystal orientation are relevant. The model will incorporate long-range diffusive interactions between primary, secondary, and higher order dendrite branches through a new, coarse-grained “dendritic network” approach. The model will be validated using ground and ISS experiments.

Modeling Peritectic Microstructure Formation during Directional Solidification in Space and on Earth

A peritectic material is one that is formed when a uniform molten liquid is cooled such that initially a solid of one composition forms with a liquid of different composition and then on further cooling the solid and liquid combine to form a solid alloy of uniform composition. Formation of a uniform peritectic alloy is difficult since the liquid composition changes during solidification. This causes density gradients, fluid flows, and non-uniformities in the final composition. This project provides modeling support to an investigation team performing ISS experiments on the formation of a peritectic alloy. The resulting samples should have novel properties for study and provide a test of models of peritectic processes.

Isothermally Processed Alloys

Two current materials investigations process multi-phase, liquid-solid samples at isothermal conditions. The structures evolve as material from the liquid phase is exchanged with material in the solid phase. This exchange of material occurs through diffusion at the boundary between the phases.

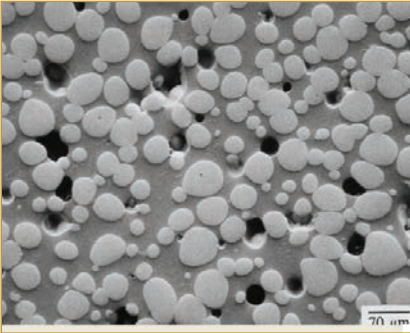
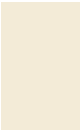

Figure 24. The distribution of phases in a sintered material, a W-Ni alloy sintered at 1550 degrees Celsius on Spacelab J. The dark areas are pores (voids), the light are the high-temperature melting material, and the intermediate areas are the low-temperature melting material. Image courtesy of R. German, San Diego State University.

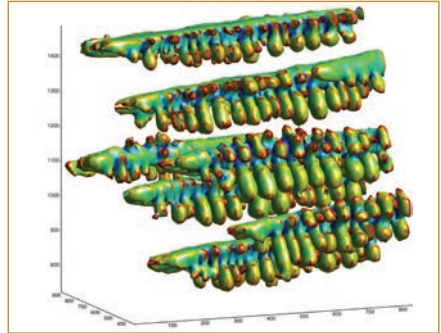

Figure 25. Sn dendrites that have been coarsened at 185C in a Pb-Sn liquid for 10 minutes on the ISS. The interfaces are colored by the local mean curvature. Positive mean curvature is red, and negative mean curvature is black. The 3-D reconstruction was obtained from serial sections through the sample that was solidified after coarsening for 10 minutes. The image is courtesy of T. Cool and P.W. Voorhees.

Gravitational Effects in Distortion in Sintering

This experiment involves the sintering process. In the sintering process, cinder-like material that melts only at high temperatures is dispersed in a powder consisting of a lower-melting temperature alloy. During processing, the mix is heated until the low-melting temperature material is liquefied. The liquid wets the solid, and material is exchanged between the two phases. The microgravity experiment will allow sintered material to be formed without the complications of fluid flows or sedimentation of the solid particles in the liquid. A number of samples with different compositions and sintering times will be created in order to develop theoretical models that relate the sintering conditions to the final product.

Effect of Varying Convection on Dendrite Morphology and Macrosegregation

The investigation concerns the coarsening behavior of a solid dendritic matrix immersed in a liquid metal phase. It is conducted in the ISS Micro-Gravity Science Glovebox using the CSLM hardware. The material in the liquid and solid phases will exchange over time, altering the shape and structure of the dendrites. The flight experiment will involve a low-volume fraction of solid, conditions that usually lead to significant fluids flows and sedimentation of dendrites in the liquid. Samples of different volume fraction are coarsened for varying times and quickly solidified to

freeze the dendritic morphology in place at pre-planned times in the coarsening process. A series of cross sections are cut through the samples, and analytical techniques are then used to characterize the dendritic structures. The resultant data are used to improve models of the coarsening process. Initial experiments have been performed, and more are planned.

Thermophysical Property Measurement via Electro-Magnetic Levitation Experiments

Several NASA materials science investigations are planned in the Electro-Magnetic Levitation (EML) facility between 2014 and 2019. The EML experiments are conducted by international research teams which include investigators sponsored by NASA. Complementary experiments will be conducted using an Electro-Static levitator at NASA's Marshall Space Flight Center. In addition, the Japanese Space Agency is planning an Electro-Static Levitator for ISS to fly in upcoming years. The first delivery of EML samples to ISS occurred in late 2014 with experiments on the initial samples occurring over the subsequent months. A new set of EML samples is to be delivered to ISS each year through 2019. EML investigations study the properties and behavior of molten alloys and solidification of the alloys. A combination of the microgravity environment and electromagnetic fields produced by the facility allows investigators to study the liquid state of the samples and the transition from the liquid to the solid state in conditions where the fluid flows are precisely controlled. Levitated specimens are free from contact with a container,

which permits studies of deeply undercooled melts, and high temperature, highly reactive materials. This is sometimes called containerless processing, and it is useful for studies of thermophysical properties, phase equilibria, metastable state formation, microstructure

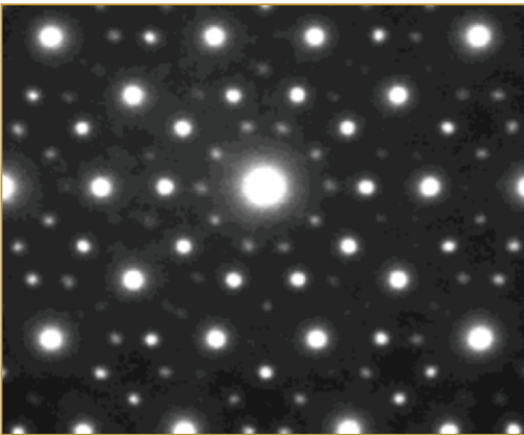

Figure 26. An X-ray diffraction pattern of a $Ti_{37}Zr_{42}Ni_{21}$ sample shows five-fold pattern indicative of many quasi-crystals. Image courtesy of K. F. Kelton, Washington University, St. Louis, Mo.

formation, undercooling, and nucleation. Undercooling is the process of lowering the temperature of a liquid below its freezing point without it becoming a solid. This occurs because in the absence of a sample container, the liquid has no solid surface to use as a nucleation point for solidification. The levitation of samples allows research on pure materials that would normally corrode, dissolve, or react with container walls when molten. EML researchers will measure properties of molten and solidifying alloys such as the viscosity, surface tension, rates of solid nucleation, heat capacities, etc. The NASA-supported researchers are involved in the following experiment teams.

Quasi-Crystalline Undercooled Alloys for Space Investigation (QUASI)

An icosahedral quasi-crystal is an ordered phase not capable of forming a true periodic 3-D structure. It is thought to play a critical role in the formation of metallic glasses, which have exceptional strength and toughness and do not have a regular 3-D order. QUASI seeks to determine the influence of short-range order on the nucleation barrier; correlate local structure in the liquid with nucleation kinetics and with thermophysical properties; and to develop, evaluate, and refine a model for nucleation kinetics. Quasi-crystals have received a great deal of attention in recent years. Dan Shechtman, an Israeli scientist was awarded the 2011 Nobel Prize in chemistry for his work in discovering quasi-crystals.

Thermophysical Properties and Solidification Behavior of Undercooled Ti-Zr-Ni Liquids Showing an Icosahedral Short-Range Order (ICOPROSOL)

ICOPROSOL investigates the nucleation and growth of quasi-crystals and the effect of atomic-scale order on the macroscopic properties of these alloys. One goal of the proposed research is to study the influence of the short-range order in the liquid phase on the nucleation behavior of ordered solid phases of Titanium Zirconium Nickel. The investigations performed under ICOPROSOL may improve our ability to tailor the microstructure of metals for commercial applications.

Thermolab

Thermolab investigates the thermophysical properties of high-temperature materials, many of which are used commercially. A better understanding of the physical properties will allow more efficient and more reliable production of metallic parts using these alloys. Alloy compositions are chosen based on the scientific interest in their properties. The data obtained from EML may expand the

fundamental understanding regarding the formation of high temperature alloys, bulk metallic glasses (disordered, non-crystalline metals) and quasi-crystals.

Peritectic Alloy Rapid Solidification with Electro-Magnetic Convection (PARSEC)

PARSEC investigates the effect of fluid flow on the solidification path of peritectic structural alloys. These materials initially nucleate to form a metastable phase consisting of a liquid and solid followed by transition to a second solid phase. The final product can exhibit properties very dependent on the convection associated with processing conditions. Understanding this relationship would enable control of the solidification path so that the microstructure and properties of peritectic materials may be tailored for specific applications.

Levitation Observation of Dendrite Evolution in Steel Ternary Alloy Rapid Solidification

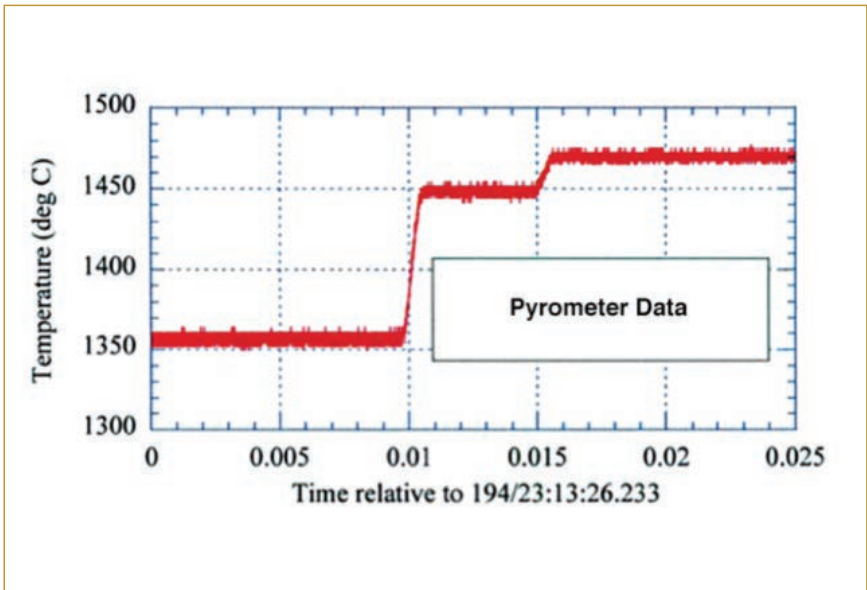
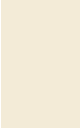

Figure 27. Temperature data taken by an optical pyrometer indicates that the sample undergoes two solidification events. Heat is released thereby increasing the sample temperature as the metastable and then stable solid phases form from the undercooled liquid.



The focus of this effort is to study metastable solidification in steel alloys. Many steel alloys consist of two phases, one phase that is thermodynamically stable and another that is metastable. Both may appear in an alloy because even though the metastable phase may not be thermodynamically favored it can be quicker to nucleate and grow. Undercooling in containerless processing has produced metastable phases and materials that exhibit improved chemical homogeneity and ultra-fine grain sizes. By observing changes in the mechanism for nucleation of the stable phase following nucleation of the metastable phase from undercooled melts, the role of convection in phase selection may be evaluated. The results have application to the design of industrial welding, spray forming and strip-casting operations for steels.

Citations

Alexei Churilov and Aleksander Ostrogorsky, “Solidification of Te and Zn doped InSb in space”, AIAA 2004-1309, 42nd AIAA Aerospace Sciences Meeting & Exhibit, January 2004/Reno, Nevada.

D.J. Rowenhorst, J.P. Kuang, K. Thornton and P.W. Voorhees, “Three-dimensional analysis of particle coarsening in high volume fraction solid-liquid mixtures,” *Acta Mater.* 54, 2027-2039 (2006).

H.U. Walter (editor), *Fluid Sciences and Material Science in Space*, published by Springer Berlin (1987).

R. N. Grugel, A.V. Anilkumar, and C.P. Lee: “Direct Observation of Pore Formation and bubble mobility during controlled melting and re-solidification in microgravity”, *Solidification Processes and Microstructures: A Symposium in Honor of Wilfried Kurz*, eds. M. Rappaz, C. Beckermann, and R. Trivedi, The Metallurgical Society, Warrendale, PA, 2004, pp. 111-116.

R.N. Grugel, L.J. Cotton, P.N. Segrè, J.A. Ogle, G. Funkhouser, F. Parris, L. Murphy, D. Gillies, F. Hua, and A.V. Anilkumar: “The In-Space Soldering Investigation (ISSI): Melting and Solidification Experiments Aboard the International Space Station,” 44th AIAA Aerospace Sciences Meeting and Exhibit, AIAA 2006-521.

Vanderhoff, et al. *J. Dispersion Sci. Technology* (1984), 5, 231-246.

Acronyms

BMG	Bulk Metallic Glass
BMGMC	Bulk Metallic Glass Matrix Composites
CET	Columnar-to-Equiaxed Transition
CLSM	Coarsening of Solid-Liquid Mixtures
CNES	French Space Agency
CSS	Comparison of Structure and Segregation
DECLIC	Dispositif pour l'Etude de la Croissance et des Liquide Critiques
DSI	Directional Solidification Insert
ECU	Electronics Control Unit
EML	Electro-Magnetic Levitation
ESA	European Space Agency
EXPRESS	Expedite the Processing of Experiments to Space Station
FI	Furnace Inserts
ICOPROSQL	Icosahedral Short-Range Order
ISS	International Space Station
ISSI	In-Space Soldering Investigation
KSC	NASA's Kennedy Space Center
LGF	Low Gradient Furnace
MSFC	NASA's Marshall Space Flight Center
MSG	Microgravity Science Glovebox
MSL	Materials Science Laboratory
MSRR	Materials Science Research Rack
PARSEC	Peritectic Alloy Rapid Solidification with Electro-Magnetic Convection
PFMI	Pore Formation and Mobility Investigation
PI	Principle Investigator
QUASI	Quasi-Crystalline Undercooled Alloys for Space Investigation
RMS	Root Mean Square
SCA	Sample-Cartridge Assemblies
SPU	Sample Processing Unit
SQF	Solidification and Quenching Furnace
SUBSA	Solidification Using a Baffle in Sealed Ampoules
WV	Work Volume

The Complete ISS Researcher's Guide Series

1. Acceleration Environment
2. Cellular Biology
3. Combustion Science
4. Earth Observations
5. Fluid Physics
6. Fruit Fly Research
7. Fundamental Physics
8. Human Research
9. Macromolecular Crystal Growth
10. Microbial Research
11. Microgravity Materials Research
12. Plant Science
13. Rodent Research
14. Space Environmental Effects
15. Technology Demonstration

For more information...

Space Station Science

<http://www.nasa.gov/iss-science>

Facilities

http://www.nasa.gov/mission_pages/station/research/facilities_category.html

ISS Interactive Reference Guide:

<http://www.nasa.gov/externalflash/ISSRG/index.htm>

Researchers/Opportunities

http://www.nasa.gov/mission_pages/station/research/ops/research_information.html

ISS Research Customer Helpline

JSC-ISS-research-helpline@mail.nasa.gov

281-244-6187

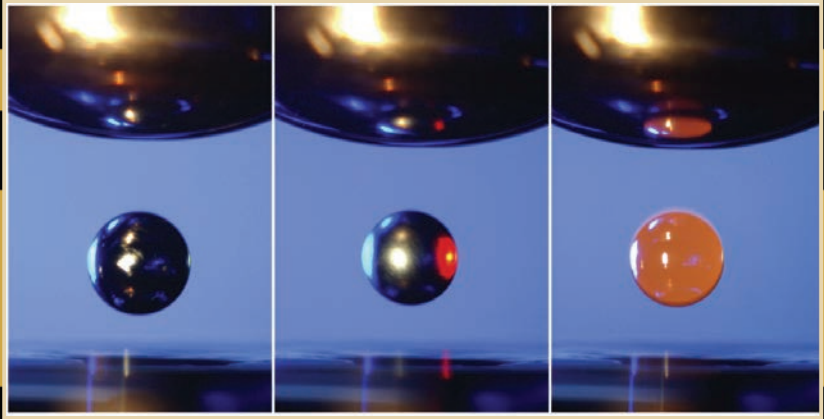

National Aeronautics and Space Administration

Johnson Space Center

<http://www.nasa.gov/centers/johnson>

www.nasa.gov

