



A Researcher's Guide to:

INTERNATIONAL SPACE STATION

Rodent Research



This International Space Station (ISS) Researcher's Guide is published by the NASA ISS Program Science Office.

Authors:

Richard Mains, Sharon Reynolds, Mains Associates, Berkeley, Calif
Patricia Larenas, Intrinsyx, NASA's Ames Research Park, Moffett Field, Calif
Michelle Hing, Intrinsyx, NASA's Ames Research Park, Moffett Field, Calif

Executive Editor: Amelia Rai
Technical Editor: Neesha Hosein
Designer: Cory Duke

Cover and back cover:

- a. A laboratory mouse in which a gene affecting hair growth has been knocked out (left) is shown next to a normal lab mouse. (Image credit: National Institutes of Health)*
- b. Back cover: View of the habitat unit of the Rodent Research experimental platform for the ISS. (Image credit: NASA/Dominic Hart.)*
- c. Back cover: Photo of a developing mouse embryo. (Image credit: National Institutes of Health)*

The Lab is Open

Soaring 250 miles above Earth, the ISS is a modern wonder of the world, combining the efforts of 15 countries and thousands of scientists, engineers and technicians. The ISS is a magnificent platform for all kinds of research to improve life on Earth, enable future space exploration and understand the universe. This researcher's guide is intended to help potential researchers plan experiments that would be exposed to the space environment within the ISS. It covers all the pertinent aspects of that space environment and how to best translate ground research to flight results and lessons learned from previous experiments.



An astronaut performs ISS operations in support of the Rodent Research-1 validation flight in late 2014. The Microgravity Science Glovebox is utilized to receive mice removed from the Animal Access Unit (blue unit in background) after being humanely euthanized. Tissues are harvested, frozen, and transported to Earth for analysis. (Image credit: NASA)





Unique Features of the ISS Research Environment

- 1. Microgravity**, or weightlessness, alters many observable phenomena within the physical and life sciences. Systems and processes affected by microgravity include surface wetting and interfacial tension, multiphase flow and heat transfer, multiphase system dynamics, solidification, and fire phenomena and combustion. Microgravity induces a vast array of changes in organisms ranging from bacteria to humans, including global alterations in gene expression and 3-D aggregation of cells into tissue-like architecture.
- 2. Extreme conditions** in the ISS space environment include exposure to extreme heat and cold cycling, ultra-vacuum, atomic oxygen, and high-energy radiation. Testing and qualification of materials exposed to these extreme conditions have provided data to enable the manufacturing of long-life reliable components used on Earth as well as in the world's most sophisticated satellite and spacecraft components.
- 3. Low-Earth orbit** at 51 degrees inclination and at a 90-minute orbit affords ISS a unique vantage point with an altitude of approximately 240 miles (400 kilometers) and an orbital path over 90 percent of the Earth's population. This can provide improved spatial resolution and variable lighting conditions compared to the sun-synchronous orbits of typical Earth remote-sensing satellites.

Table of Contents

Microgravity as a Research Tool: Using the ISS as a Laboratory	7
Rodents in Space	9
Opportunities on the ISS National Laboratory for Rodent Research	9
Results from Rodent Microgravity Research on the Space Shuttle and ISS	11
Lessons Learned	14
Rodent Habitat Facilities: How to Choose and Use Them	16
The Rodent Habitat: Housing on the ISS	16
Rodent Transporter - Delivery to ISS	18
Animal Access Unit (AAU) - Rodent Access/Transfers on ISS	19
Experiment Support Facilities: Capabilities Aboard ISS	20
Sample Preservation and Sample Return	22
Experiment Unique Equipment	23
Rodent Research ISS Operations Scenario	24
Developing and Flying Research on the ISS	26
Conducting Space Research: The ISS Environmental Conditions	26
Microgravity	26
Radiation Exposure	26
Ambient Gas Concentrations and Pressure	27
Experiment Accommodation on the ISS	27
Developing Your Spaceflight Experiment	28
Principal Investigator Role and Responsibilities	28
Implementation Team Role and Responsibilities	28
Definition, Documentation & Testing of a Spaceflight Experiment	29
Development of Spaceflight Experiment Requirements	29
Science Ground Testing	29
Ground Controls	30
Hardware Biocompatibility Tests	30
Project Integrated Tests	30
Conducting a Spaceflight Experiment: Payload Flight Operations	31
NASA's Safety Policy	32
Flight Safety	32
Ground Safety	32
Animal Welfare	33
Funding Opportunities/Points of Contact	33
Citations	34
Appendix	37
Animal Enclosure Module (AEM): A Brief History	37
Recent Rodent Flight Experiments	37
Acronyms	41

Microgravity as a _____ Research Tool: Using the ISS as a Laboratory

The International Space Station provides a unique environment in which to study the effects of microgravity and the space environment on various organisms. Rodents (rats and mice) are the animal models most commonly used to study fundamental biological processes in space: predominately rats, followed by mice. The National Research Council's (NRC) 2011 Decadal Survey Report titled "Recapturing a Future for Space Exploration: Life and Physical Sciences Research for a New Era" (<http://www.nap.edu/catalog/13048.html>) addressed the importance of rodent research models. The Report states "It is now recognized that habitation of the microgravity environment poses potential deleterious consequences for essentially all the organ systems of the body." Given that human astronauts and cosmonauts routinely spend 180 days or longer on the ISS, that amount of time represents a significant portion of the lifespan of a rodent. Studies with rodents in space have been useful and important for extrapolating the implications for humans living in space and more work remains to be done (National Research Council [U.S.], 2011).

One example is the leveraging of current technology such as using genetically engineered mice in flight experiments to investigate the molecular mechanisms of bone loss that occurs during exposure to microgravity for possible pharmacological intervention. NASA is particularly interested in studies that enable a better understanding of how mechanisms governing homeostasis at the genetic, molecular and cellular levels are integrated to regulate adaptation to spaceflight at the physiological system or whole-animal level.



Figure 1. Mission Specialist Dan Barry checks the status of the Physiological and Anatomical Rodent Experiment/National Institutes of Health-Rodents experiment on Space Transportation System (STS)-72 conducted in the middeck with the Animal Enclosure Module.



The NRC Decadal Survey Report serves as guidance for research goals and a map to chart the path forward. The following is an excerpt from a recent NASA Research Announcement (NRA; NASA, 2013) referencing this path:

Representative research areas identified in the Decadal Survey aligned with Rodent Research include:

- Specific mechanisms of bone mass regulation.
- Basic mechanisms regulating skeletal muscle protein balance during changes in gravity.
- Fracture repair and wound healing.
- Long-term studies addressing the preservation and reversibility of bone loss including the evaluation of new osteoporosis drugs under clinical development.
- Sensorimotor and neural mechanisms.
- Long-term studies of the combined environmental factors of spaceflight on mammalian physiology (i.e., microgravity, radiation, closed systems).
- Recovery after long-term exposure to unloading or other factors of the space environment.
- Effects of long-term exposure to unloading or other factors of the space environment on processes of development, reproduction and aging.
- Effects of microgravity on the cardiovascular system and fluid balance.

Selection of the rodent species and strain to be used for proposed studies should be optimized to test specific hypotheses. Consideration should also be given to the ease with which results can contribute to broader, systems-level understanding of physiological changes that are due to causes other than gravitational unloading and microgravity, e.g., stress, injury, and disease. Proposers should, where possible, consider the use of standardized microgravity analogs and hyper-gravity models to address proposed hypotheses, such as hind-limb unloading, other disuse models and centrifugation (Morey-Holton and Globus, 2002).

Rodents in Space

Opportunities on the ISS National Laboratory for Rodent Research

NASA NRAs are managed through the NASA Solicitation and Proposal Integrated Review and Evaluation System (NSPIRES). This Web-based system supports NASA research from the release of solicitation announcements through the peer review and selection processes (<http://nspires.nasaprs.com/external/index.do>). NASA's selection of research projects is guided by recommendations of the National Research Council's 2011 Decadal Survey Report titled "Recapturing a Future for Space Exploration: Life and Physical Sciences Research for a New Era" (<http://www.nap.edu/catalog/13048.html>). The NASA-developed "Fundamental Space Biology Science Plan" provides an implementation strategy and roadmap based on NRC recommendations and available flight and fiscal resources (http://www.nasa.gov/exploration/library/esmd_documents.html).

Additional research opportunities are available at the Center for the Advancement of Science in Space (CASIS, <http://www.iss-casis.org/Home.aspx>), which manages researcher access to the ISS U.S. National Laboratory (NL). In addition to formal Requests for Proposal that identify targeted areas of research and technology development, CASIS also facilitates and accepts unsolicited proposals from any U.S.-based academic or commercial investigators and investigators from other U.S. government agencies at any time. The selection of research projects by CASIS is guided by the CASIS mission to enable and increase utilization of the ISS National Lab as a unique platform for scientific discovery, technology development, and education for the benefit of life on Earth.

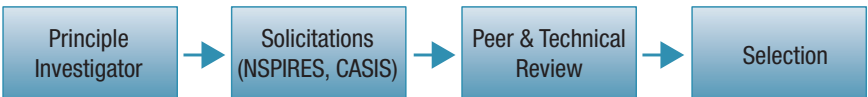



Figure 2: Proposals submitted for NASA's research opportunities undergo scientific and technical review.

Some resources are identified below that are especially useful to researchers who plan to propose experiments to NASA and/or CASIS on the ISS with animal models, including rodent research. Reference sources are provided in the Citations section. In addition, investigators may contact CASIS for additional information on flight research opportunities and flight resources for support of rodent research on the ISS National Lab at info@iss-casis.org.



A detailed catalog of previous, current, and proposed experiments, facilities, and results, including investigator information, research summaries, operations, hardware information, and related publications is available at www.nasa.gov/iss-science through the NASA ISS Program Office. Additionally, details pertaining to research previously supported by the Space Life and Physical Sciences Research and Applications Division of NASA's Human Exploration and Operations Mission Directorate can be located in their Division "Task Book" in a searchable online database format at: <https://taskbook.nasaprs.com/Publication/welcome.cfm>.

The online *NASA Research Announcement Guidebook for Proposers* (NASA, 2013).

Information about spaceflight experiments with rodents can be found in the following publications:

Fundamentals of Space Biology: Research on Cells, Animals, and Plants in Space (Clément and Slenzka, 2006). The authors provide a comprehensive overview of space biology with explanations and background regarding different organisms and research questions. The book also includes descriptions of experiment hardware, facilities, and different spaceflight vehicles and platforms, as well as a chapter on radiation biology.

Experimentation with Animal Models in Space, Volume 10 of the series Advances in Space Biology and Medicine (Sonnenfeld, 2005). This collection of review articles covers a variety of animals, including rodents. Importantly, the ground-based rodent hind-limb unloading model is discussed. Mouse infection models for immunology studies and rodents as models to study the skeletal effects of spaceflight are also mentioned.

Neurolab: Final Report for the NASA Ames Research Center Payload (Maese and Ostrach, 2002). The Neurolab Spacelab Mission flew on Space Shuttle *Columbia* (STS-90) in 1998 as the last Spacelab mission and included human and animal experiments focused on neurosciences. This report focuses mostly on the science but also includes profiles of the hardware and flight operations and includes lessons learned (problems and recommended solutions) throughout, including some recommendations for the ISS era. Neurolab accommodated 12 rodent studies with three done in the Animal Enclosure Module (AEM), the precursor to the Rodent Habitat profiled below (also see Appendix). The rodent research focus on this mission was neuronal plasticity and mammalian development. It was the first STS mission on which mice flew, and the first experience with mice in an AEM. It was also the first mission where a portable glovebox (the Access and Transfer Unit) was attached to an

AEM and rodents were moved into the STS General Purpose Work Station (see Fig. 11 below for ISS version) for conduct of specific experiment procedures.

Results from Rodent Microgravity Research on the Space Shuttle and ISS

Rodent spaceflight experiments have provided a broad range of results pertinent to biomedicine applications including the neurology, muscle physiology, bone physiology, cardiovascular and developmental biology disciplines. Historically, the platforms and vehicles used to transport these payloads to the space environment have been varied, from the Russian Bion/Cosmos spacecraft launched with Soyuz rockets, to NASA's space shuttle. Most often used currently is the SpaceX Dragon capsule that provides transport to the ISS, the first international essentially continuous orbiting science laboratory (Fig. 3). The ISS offers a platform for longer-term experiments in microgravity with enhanced capabilities for carrying out investigations in space.

To date, rodent spaceflight experiments have contributed significantly to our understanding of the effects of microgravity on biological processes that are directly relevant to humans in space. The following highlights show a range of results from rodent spaceflight experiments (Table 1) are discussed in more detail in NASA's Fundamental Space Biology Science Plan (http://www.nasa.gov/exploration/library/esmd_documents.html): For example, a rodent experiment on Cosmos 782/Bion3 investigating hematopoietic mechanisms in microgravity resulted in the first observation of programmed death (apoptosis) of newly formed red blood cells. Importantly, this finding was subsequently validated in human subjects. Experiments on STS-40/Space Life Sciences (SLS)-1 and STS-58/SLS-2 revealed that in rodent subjects, the nerve connections between hair cells of the inner ear and the brain increased dramatically in microgravity and decreased shortly after return to Earth, demonstrating the neuroplasticity of peripheral nerves.

Findings from many experiments in space and in ground-based microgravity analog models have clarified the impact of exposure to microgravity on bones and muscles including the following examples:

- In growing animals, certain muscles and bones stop growing at their normal rate while others actually lose mass.
- Several specific changes found in the ground-based rodent unloading model are similar to those noted during spaceflight.

Mission	P.I.	Experiment Title (and Citation)	Species
STS-108	Ted A. Bateman, Louis S. Stodieck, Paul Kostenuik	Effects of Osteoprotegerin on Bone Maintenance in Microgravity (NASA, 2014a)	Mus musculus
STS-118	Virginia L. Ferguson, Louis S. Stodieck, HQ Han, Daila S. Gridley, Michael J. Pecaut	Examination of Myostatin Inhibition for Treatment of Spaceflight-Induced Muscle Loss in Mice (NASA, 2014b)	Mus musculus
STS-135	Ronald J. Midura	Space Flight's Affects on Vascular Atrophy in the Hind Limbs of Mice (NASA, 2014c)	Mus musculus
STS-135	Virginia L. Ferguson, Louis S. Stodieck Mary L. Bouxsein, Chris Paszty	Assessment of Anti-Sclerostin Antibody as a Novel Anabolic Therapy for Prevention of Spaceflight-induced Skeletal Fragility in Mice (NASA, 2014d)	Mus musculus
STS-135	Roberto Garofalo	Effect of Space Flight on Lung Gene and Protein Expression Profiles	Mus musculus
STS-131/135	Millie Hughes-Fulford	Evaluation of Changes in Thymus and Spleenocytes After Spaceflight	Mus musculus
STS-131 / BSP	David Fitzgerald	The Response of Articular Cartilage to Microgravity (Fitzgerald and Moscibrocki, 2012)	Mus musculus
STS-90 / Neurolab	Charles A. Fuller	CNS Control of Rhythms and Homeostasis During Space Flight (Campbell et al., 2005)	Rattus norvegicus
STS-90/ Neurolab	Kenneth M. Baldwin	Neural Thyroid Interaction on Skeletal Isomyosin Expression in Zero-G (Adams et al., 2000)	Rattus norvegicus
STS-77/ Immune.3	Robert Zimmerman	Confirmation of Ability of Sustained-Release Insulin-like Growth Factor I (IGF-I) to Counteract the Effect of Space Flight on the Rat Immune and Skeletal Systems (Bateman et al., 1998)	Rattus norvegicus
STS-70/ NIH.R2	Jeffrey R. Alberts	Spaceflight Effects on Mammalian Development (Alberts and Ronca, 1997)	Rattus norvegicus
STS-66/ NIH.R1	Gerald Sonnenfeld	Effect of Spaceflight on Development of Immune Responses (Ronca, 2003; Sonnenfeld et al., 1998)	Rattus norvegicus
STS-58/ SLS-2	Albert T. Ichicki	Regulation of Erythropoiesis During Spaceflight (Allebban et al., 1996)	Rattus norvegicus
STS-54/ PARE.02	Edwin Miller	Influence of spaceflight on the production of interleukin-3 and interleukin-6 by rat spleen and thymus cells (Miller et al., 1995)	Rattus norvegicus
STS-40/ SLS-1	Danny Riley	Contractile Properties of Skeletal Muscles (Riley et al., 1996)	Rattus norvegicus

Table 1: Selected NASA experiments with rodents flown on the space shuttle. See associated references (when available) in Citations section.

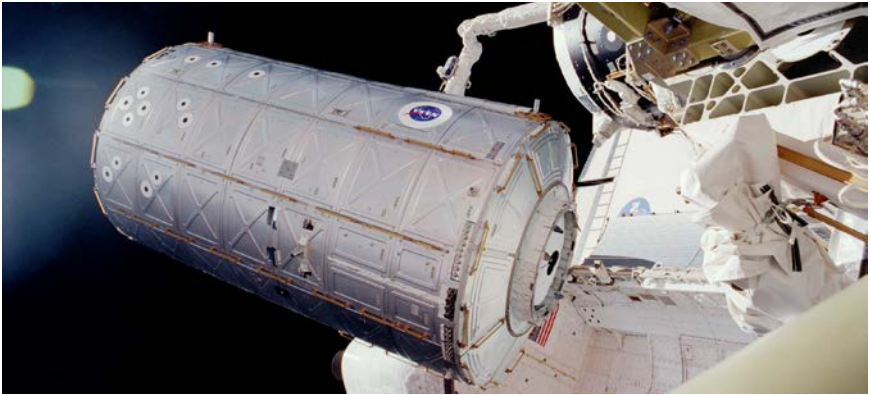

Figure 3. NASA's Destiny Laboratory delivered to the ISS by the space shuttle in 2001. (Credit: NASA.)

A list of rodent experiments from the recent STS-131, 133 and 135 missions, including those conducted under NASA's Biospecimen Sharing Program, is provided in the Appendix.

NASA's Life Sciences Data Archive provides additional information on spaceflight experiments at <http://lsda.jsc.nasa.gov/>. NASA's Biospecimen Sharing Program provides access to available tissue samples from spaceflight experiments. These can be requested via the User's Guide for Requesting NASA data at <http://lsda.jsc.nasa.gov/common/dataRequestFAQ.aspx>, by selecting the Animal Tissues sub-section.

Lessons Learned

Experiments conducted in space require specialized hardware, or habitats, for animals exposed to the microgravity spacecraft environment. Animal husbandry in space poses unique challenges that space experiment hardware is designed to address. Examples of this are the ability to successfully access food and water without normal gravity and the control of animal waste and odors, at a minimum. Some effects are difficult to predict or manage. For example, researchers have observed that rodents respond with individual behaviors in the microgravity environment; some are more active or passive than their cage mates. The potential impact of the extraordinary environmental conditions of space on experimental results must be considered.

Examples of lessons learned from animal experiments in spaceflight:

- Stresses such as launch, landing, and microgravity and changes in housing, food delivery, waste removal, and others can exert strong influences on animals that often vary significantly between animals (as with humans).
- Conduct of ground controls is critical to experiment designs, including under standard vivaria conditions (lab-type housing/food/water, etc.) and with animals under flight-matched conditions including the habitat, food/water, waste collection, lighting, airflow, temperature and mission duration.
- Female rodents produce less odor from urine (Dalton et al., 2003).
- Rodents undergo a period of habituation at the beginning of spaceflight as they adapt to the stress of a new environment (as do humans).
 - Video collected of mice flown on STS-108, 118 and 135 show that they habituate well to microgravity and continue to groom, ambulate easily (and were observed to run “laps” within their AEM), and readily obtain access to food and water.
 - Upon return to Earth following STS-108, 118 and 135 missions, mice visibly demonstrated effects of returning to Earth’s gravity that suggested vestibular dysfunction.
 - As on Earth, group housing of rodents reduces stress and may improve scientific outcome measures.
- Researchers demonstrated that in-flight sampling can be critical for interpreting spaceflight effects. For example, experiment results indicated that the ability of natural killer cells to effectively target pathogens varied depending on whether the animals were euthanized after the flight or during flight (Lesnyak et al., 1996).

- 
- Another important insight gained from in-flight sampling was that muscle damage observed postflight was actually a post-microgravity landing effect.
 - The amount of time that astronauts can devote to experiment activities is limited so experiment procedures must be highly streamlined or automated, as possible.
 - Fine motor skills of the flight crew are compromised in the spacecraft environment, hence complex manipulations while handling rodents and hardware and conduct of lab operations are more time consuming.

Rodent Habitat Facilities: _____

How to Choose and Use Them

Selection of a habitat facility to house animals during a spaceflight experiment will primarily be dictated by the hardware available at the time of experiment development. Points to consider in planning an experiment are the species and gender to be flown and the number of animals the habitat will comfortably house at one time; the duration of the experiment; the data the habitat can provide (video, temperature, etc.); and any requirements for crew manipulation of the research subjects.

NASA's Rodent Habitat, profiled below, will be available to support rodent research on the ISS beginning in 2014. This system leverages the experience gained from the many space shuttle experiments with rodents that used the AEM (see Appendix). Other facilities have also been designed and will be available eventually for use on the ISS but are not included here. Currently, NASA and CASIS are supporting development of spaceflight experiments that will use Rodent Habitats.

Rodents are typically shared among multiple principal investigators (PIs) and others as the compatibility across research studies permits. Therefore, it is very important for investigators to minimize the total number of animals required for a study without compromising the statistical power of the results. NASA anticipates flying 20 to 40 mice or 10 to 20 rats at a time in a payload, or mission. A payload could have a single, dedicated investigator, but to maximize science return from each payload, NASA may choose to execute multiple experiments in a single payload, including sharing tissues (Biospecimen Sharing Program) among multiple investigators. Investigators may also promote tissue sharing among their colleagues. When NASA executes multiple investigations in a single payload, care is taken to ensure that each experiment is independent and that there are minimal interactive effects between experiments.

Rodent Habitat: Housing on the ISS

To conduct experiments using the Rodent Habitat Hardware System (Fig. 4) aboard the ISS, animals first will be transported to orbit in the Transporter. Once aboard the ISS, the animals will then be transferred to the Rodent Habitat using the Animal Access Unit (AAU), as described in the sections below.

The Rodent Habitat is shown in Fig. 5 with both access doors opened. A functional diagram of the Rodent Habitat is shown in Figure 6.



Figure 4. The Rodent Habitat Hardware System. From left: The Rodent Habitat; the Rodent Transporter; and the Animal Access Unit.

Rodent Habitat capabilities include:

- Single habitats accommodate 10 mice or 5 to 6 rats in either group or dual-partitioned housing.
- Temperature and relative humidity monitoring, but no active thermal control.
- Visual monitoring of group food and water consumption by hand-held video during daily crew health checks.
- Video cameras (4), LED lighting (day), and infrared lighting (night) to capture animal behavior and activity.
- Animals may be transferred to a clean Rodent Habitat after 30 days or more to achieve longer-duration missions.
- The Transporter is utilized to bring animals to orbit on the ISS.
- Powered by batteries during launch and when being moved, and from ISS when rack-mounted.



Figure 5. Rodent Habitat. Shown with both access doors open.

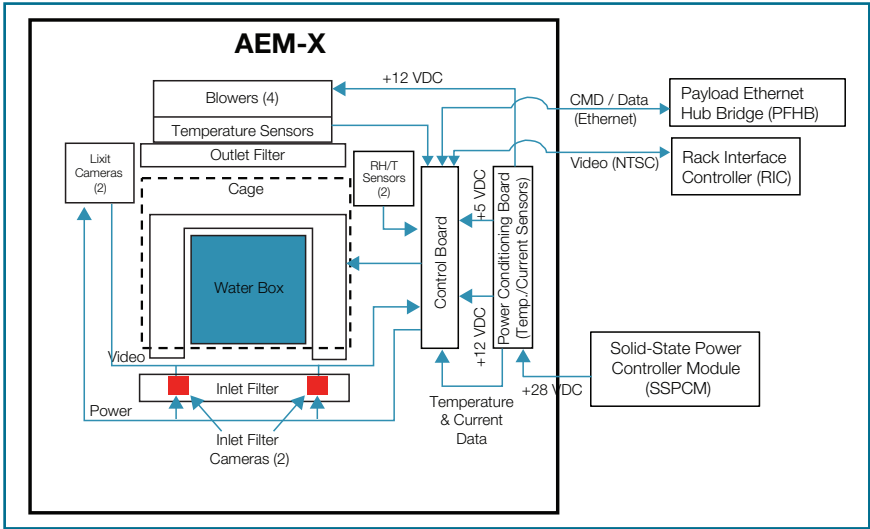

Figure 6. Functional diagram of Rodent Habitat life support systems, sensors, cameras, and power supplies with connections to key ISS interfaces. The Lixit Cameras shown together (point at the rodent drinking valves) are located on each side at the back of the cage similar to the two Inlet Filter Cameras in front.

Rodent Transporter - Delivery to ISS

Rodents will be delivered to the ISS via the Transporter (Fig 4) aboard the SpaceX Dragon and transferred to the Rodent Habitat, once aboard the ISS, by crew members trained in animal handling.

Transporter capabilities include:

- Single-unit supports up to 12 rats or 20 mice (double density for transport) in group housing (depending on animal size/age).
- No active thermal control.
- Visual observation of food and water only before/after transport.
- Use of a Mouse Transfer Box for transfers between Rodent Habitat System elements (Fig.9).
- No return of live animals for first flights.

Animal Access Unit (AAU) - Rodent Access/Transfers on ISS

The AAU (Fig. 7) will be used to transfer animals from the Transporter to the Rodent Habitat and, as warranted, from there to the Microgravity Science Glovebox (MSG; Fig. 11) on the ISS.

AAU capabilities include:

- Provides for animal access, as needed, during spaceflight.
- Attaches to either the Transporter or the Rodent Habitat on the ISS for transfer activities.
- Used for transfer of animals to the MSG for in-orbit experiment operations (Fig 11) by internal transfer to the small Mouse Transfer Box (Fig. 9) that fits inside the AAU.



Figure 7. The AAU provides containment during animal access and transfer between the Transporter, Rodent Habitat, and the Microgravity Science Glovebox. The bottom of the unit is open to provide access to doors in the Transporter and Habitat hardware that are opened after the Animal Access Unit is attached.



Figure 8. The Animal Access Unit (AAU) is attached during fit check to the top of the Rodent Habitat. The white fabric gloves and gauntlets on the AAU openings are used for animal handling to maintain containment during animal transfers.



Figure 9. The Mouse Transfer Box (MTB) fits inside the Animal Access Unit for transfer of rodents into/from the Rodent Habitat and is also placed in the Microgravity Science Glovebox for the same purpose. The MTB on the right is shown with the dual lid opened, but it can also be opened half at a time to help sequester animals inside. The MTB on the left is shown with a removable fabric cover in place to provide a more secure environment for animals after they are loaded.

A small, ventilated Mouse Transfer Box (MTB, Fig. 9) is placed inside the AAU so when animals are removed from the Rodent Habitat (4-5 at a time) during the attachment phase, they can be inserted in the MTB and then transferred to the MSG (Fig. 11) for conduct of experiment procedures. The AAU and MSG have panel openings appropriate to allow the MTB to function in this way as a contained rodent transfer device. In addition to gloves and gauntlets on the AAU that cover the hands and arms, there is an attached “sock” device (fabric bag open only to the inside of the AAU) that temporarily can hold mice during these transfer procedures, as warranted.

Experiment Support Facilities: Capabilities Aboard ISS

Several additional facilities will eventually be available for use with experiments supported by the Rodent Habitat Hardware System on the ISS. Some of the currently available items are described below.

Handheld video (Fig. 10) is also a capability for use with the Rodent Research Hardware and associated operations on the ISS, if needed. However, the four video cameras built in to the Rodent Habitat (Fig.6) will routinely capture video of animals in light and dark conditions.

The MSG will support rodent experiment procedures requiring containment (Fig. 11). There is a limited working environment within the MSG, and there are practical constraints to performing complex procedures in a microgravity environment while wearing gloves.

Blood draws and other simple experimental procedures with rodents will be possible within the MSG. However, for any experimental procedures performed on live animals, PIs must take into consideration that crew time is limited and procedures in microgravity take longer to perform. Rodent euthanasia, anesthesia, general dissection, chemical fixation, and tissue preservation capabilities will be possible aboard the ISS.

A collection of equipment and supplies designated as Operations Support Hardware (OSU) will be provided aboard ISS to support rodent experiment procedures. OSU items will include a general dissection kit, an injection kit (with anesthetics for

non-terminal procedures and materials to euthanize animals), and an animal health kit to monitor animal health status.

A Bone Densitometer suitable for making whole-body rodent scans (and associated body mass measurements) is available aboard the ISS provided by the developer, TechShot, Inc. (<http://techshot.com>).



Figure 10. Mission Specialist Nicole Stott uses a video camera attached to a fabric shroud to record data from an Animal Enclosure Module (partially removed from its middeck locker) during conduct of procedures for the STS-133 Mouse Immunology-2 investigation. (Credit: NASA).



Figure 11. The Microgravity Science Glovebox is a sealed workspace with built-in gloves (not shown) that safely contains fluids, flames, particulates, and fumes, and allows handling of small equipment.

Sample Preservation and Sample Return

The guidelines below will be followed during the initial Rodent Research ISS missions:

- No live animals will be available for return to Earth from early ISS/Dragon flight experiments. Live animal return capability will be available on later flights, perhaps as early as 2016.
- Animal tissues will be returned in frozen or fixed form.
- Animal tissues will nominally be available to the PI as early as two days after Dragon capsule landing.
- Currently, rodent experiments can be planned for approximately 30-day periods covering the ascent, docking, and return of the Dragon spacecraft with the projected frequency of rodent flights to the ISS being every 4 to 6 months.

Cold-storage resources for frozen tissues will be available (Table 4) aboard the ISS:

Cold Storage Resources for ISS Experiments

	Active		Passive		
Unit Name	MELFI	GLACIER	Double Cold-bag	Ice Pack Assemblies	Ice Brick Assembly
Temp. Ranges	-95°C-+2°C	-160°C-+4°C		-32°C, -21°C, -16°C, 0°C, +4°C	-32°C, -26°C,+4°C
Main Use	ISS in-orbit cooling, low-temperature science storage facility, continuously powered when supporting science	ISS in-orbit cooling, low-temperature science storage facility, cold stowage transportation to/ from ISS	Passive, low-temperature science storage for transportation to/from ISS	Provides cold conditioning for Coldbag, designed to be refreezable on ISS in MELFI and GLACIER (brick shape)	Provides cold conditioning for Coldbag, designed to be refreezable on ISS in MELFI and GLACIER (cylinder shape)

Table 2. Cold storage capabilities in support of spaceflight experiments, to/from and in orbit.

- Minus Eighty Laboratory Freezer for ISS (MELFI) - has four identical Dewars, each of which can be controlled independently at certain set points (as long as Dewar 1 is at minus 95 degrees Celsius). The three set points for Dewar

temperatures are minus 95 degrees Celsius, minus 35 degrees Celsius, and 2 degrees Celsius; the capacity is 175 liters.

- General Laboratory Active Cryogenic ISS Experiment Refrigerator (GLACIER) - serves as an in-orbit, low-temperature science storage facility as well as cold-storage transportation to and from orbit; it supports a selectable temperature range of 4 degrees Celsius to minus 160 degrees Celsius; capacity is roughly 23 x 16 x 7 cm (2.84 liters).
- Passive cold systems are used in transport to the ISS such as a cold bag and cold pack.

Experiment Unique Equipment

Experiment Unique Equipment (EUE), equipment that is unique to a particular experiment, may be developed if there is sufficient budget available and should be included in the proposal. Examples of EUE are implanted pumps for reagent delivery or sensors for monitoring physiological parameters.

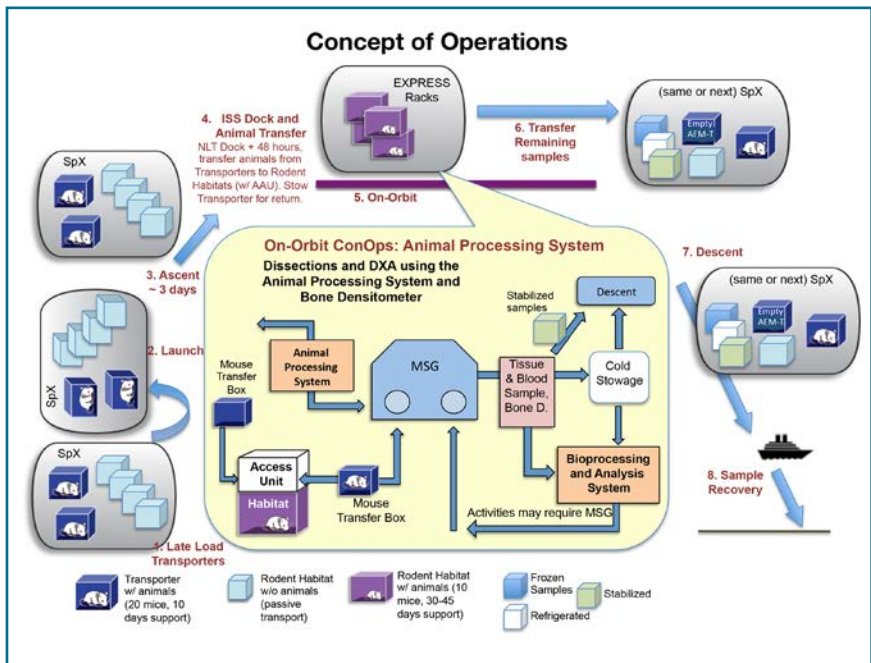
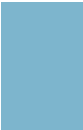

Figure 12: Concept of Operations for Rodent Research on the ISS (NASA image).

Rodent Research ISS Operations Scenario

RR-1 Mission: The first ISS mission of the Rodent Research (RR) Hardware System, or Rodent Research-1 (RR-1) for short, will be about 30 days long and use only female mice (Roberts, 2014). The RR-1 mission will include both CASIS- and NASA-sponsored investigations, but the research aims are secondary to testing and demonstrating the hardware and software's ability to support rodent experiments in microgravity. The key objectives are to validate all interfaces and the engineering command and controls and verify all processes and crew and hardware operations during flight. The primary RR-1 operations are diagrammed in Fig. 12, and they will be tested and further defined as they are conducted and adjusted to the realities of microgravity and crew-assisted ISS procedures. Lessons from the RR-1 mission may lead to some modifications, as possible, to hardware, software, related operations, and procedures prior to subsequent mission launches. Some generic concepts for future operations during early (2014-2015) and later missions (2016 and beyond) are profiled below.

RR Preparation and Transportation: The launch site for the SpaceX Dragon capsule at NASA's Kennedy Space Center (KSC) has laboratories and facilities for receiving, housing, and preparing animals; however, the PI team will need to supply any special equipment, procedures, and other experiment-specific considerations. Each RR mission accommodates 40 mice that will be loaded into one of two Transporters for integration into the Dragon capsule approximately 12 hours before launch. Transportation to the ISS in the SpaceX Dragon capsule should take about three to four days, but could take as many as seven. During ascent and berthing to the ISS, no video or real-time environmental data downlink is available from the hardware, but the environmental data (Total Pressure, Humidity, Temperature, pO₂, pCO₂) from the Dragon cabin where the Transporter is housed is transmitted via telemetry to the ground. Data sets from the preflight recordings of temperature and humidity, as well as telemetry from the Dragon capsule during launch and flight, will be used to program an environmental chamber at KSC for ground control studies. This chamber provides Temperature, Humidity and pCO₂ levels that match the ISS environment of the flight animals. Also, a set of environmental data recorded from the Transporter itself will be available after the Transporter is returned to Earth postflight. After the animals reach the ISS, the crew will remove them from the Transporter units and transfer them via the AAU into the Rodent Habitat units in the ISS U.S. National Lab.



Habitat Data Monitoring: Scientists can monitor conditions in each Habitat, such as temperature and relative humidity that will reflect corresponding conditions in the ISS cabin. The crew will visually assess group animal food and water consumption at regular intervals and can transfer animals to another habitat if required, depending on availability. The PI team will make limited real-time video monitoring for health and status available for downlink and analysis. Also, ground personnel can schedule video observations during light-dark cycles.

Live Animal Return: Although early ISS flight experiments will not be able to return live animals to Earth, live animal return may be available as early as 2016.

RR Ground Controls: NASA will support synchronous ground-based, control-group experiments (housed in flight hardware with a controlled environment chamber) and in normal vivaria cage conditions. As needed, ground-control experiments may be performed on an asynchronous time delay to allow control of temperature and other parameters to follow closely actual flight conditions. Specific Pathogen Free (SPF) animals will be used for all flight and ground control studies (see “Ground Controls” in next major section below).

Future RR Mission Concepts: RR-1 is scheduled for launch in the Dragon capsule on the SpaceX Commercial Resupply Services (CRS)-4 ISS resupply mission in 2014. A CASIS-sponsored investigation will explore use of the new in-orbit Bone Densitometry capability provided by TechShot, Inc. based on dual-energy X-ray absorptiometry. RR-2 is scheduled for launch on the SpaceX CRS-6 mission. These early missions will include both CASIS- and NASA-sponsored investigations, but they will be secondary to demonstrating the hardware’s ability to support rodent experiments in microgravity and all associated crew operations. RR missions to the ISS U.S. National Lab sponsored by CASIS and NASA are expected to occur up to two times per year. Ultimately, the RR facility will be able to support rodent studies as long as six months in duration and the return of live animals. The NASA Biospecimen Sharing Program will offer the research community the ability to maximize science return by utilizing biosamples returned to Earth from animals exposed to prolonged periods of microgravity on the ISS. Researchers can request specimens to conduct secondary studies that complement the original experiment goals.

Developing and Flying Research on the ISS

Conducting Space Research: The ISS Environmental Conditions

Understanding the key aspects of the ISS research environment is important for developing appropriate experiment designs. Three aspects of the internal environment are profiled below.

Microgravity

Objects on the ISS are in free fall and typically experience about one millionth of Earth's gravity. This condition of microgravity is effectively an environment of near weightlessness. Gravitational force is not, however, the only force relevant to biological experiments in space (DeLombard et al., 2004). Disturbances on the ISS may be caused by persistent vibrational forces (e.g., pumps, fans, exercise systems) and/or transient operational forces (e.g., valve operation, vehicle berthing or docking operations). The magnitude of these impacts on the gravitational environment can range from 0.01 g (briefly for a thruster jet) to below one millionth of 1 g (prolonged for atmospheric drag in orbit).

For biological experiments, it is important to understand the differences between the direct effects of microgravity in which the system perceives changes in the gravitational force directly. This includes indirect effects in which the system responds not to the lack of gravitational force itself but to changes in the local environment induced by the conditions of microgravity. The reduction in gravitational forces on biological systems results in decreased buoyancy-driven flows, rates of sedimentation, and hydrostatic pressure. In general, fluid dynamics are also altered, and there is a near absence of convection in microgravity (National Research Council [U.S.]; 2011).

Radiation Exposure

NASA's current life sciences goals are focused predominantly on understanding the effects of space radiation on humans in space and developing strategies to mitigate adverse effects. While there is a large body of existing literature on the effects of low-linear energy transfer (LET) radiation such as gamma rays and x-rays on biological samples, including data from long-term animal studies, clinical studies, and others, the information on radiation of the kind encountered in space (e.g., protons and high-LET radiation such as heavy charged ions) is less well-defined (National Research Council [U.S.]; 2011).

Crews aboard the space station receive an average of 80 mSv for a six-month stay at solar maximum (the time period with the maximum number of sunspots and a maximum solar magnetic field to deflect the particles) and an average of 160 mSv for a six-month stay at solar minimum (the opposite condition). Although the type of radiation is different, and therefore biological effects may vary depending on the biological parameter, one mSv of space radiation is approximately equivalent to receiving three chest x-rays. On Earth, we receive an average of two mSv every year from background radiation alone.

Ambient Gas Concentrations and Pressure

The air within the ISS is dynamically controlled to be close to the gas concentrations and total pressure to our atmosphere on Earth. Nitrogen and oxygen are stored in tanks and released automatically based on sensor readings, and carbon dioxide is chemically absorbed.

Experiment Accommodation on the ISS

Experiment payloads are all held within International Standard Payload Racks (ISPRs) within the ISS. Each ISPR consists of an outer shell that provides a set of standard interfaces, a support structure, and modular equipment for supporting research hardware. Each can accommodate one or several experiments.

Through the ISPRs, the ISS payload experiments can be provided with the following ISS resources available on the U.S. Destiny Laboratory:

- Electrical power
- Thermal control
- Command/data/video
- Vacuum exhaust/waste gas
- Gaseous nitrogen

The Expedite the Processing of Experiments to the Space Station (EXPRESS) Rack System is available to support small, sub-rack payloads with power, data, and cooling within an ISPR. EXPRESS racks were designed to accommodate payloads originally fitted to shuttle middeck lockers and International Sub-rack Interface Standard drawers, allowing previously flown payloads to transition easily to flight on the ISS (National Research Council [U.S.]; 2011).

Developing Your Spaceflight Experiment

Several milestones along your experiment development path are described below as a NASA-supported process that applies to PIs who are NASA-funded grantees (see Section 4 - Opportunities for Research on the ISS, above). However, a similar, streamlined process is required for PIs who are not NASA-funded, including CASIS grantees, other government grantees, or self-funded commercial entities. In this non-NASA-funded case, PIs are considered participants on the CASIS-managed ISS NL, and CASIS and one or more Implementation Partners provide support (<http://www.iss-casis.org/CASISBasics/ForResearchers/DirectoryofImplementationPartners.aspx>).

After undergoing scientific and technical review, when a proposal is accepted as a spaceflight candidate, a flight experiment team is formed and the development cycle is initiated and proceeds in phases. The PI will be supported by an assigned project scientist who functions as the advocate and liaison for the PI and assists with the experiment development process.

For optimal use of the limited in-orbit resources, experiments may be combined where feasible—for example, those requiring similar biospecimens and hardware. Such teams will work together to achieve individual objectives within the bounds of constrained resources. These teams may be assigned to a flight and their experiments implemented as a group.

Principal Investigator (PI) Role and Responsibilities

The fundamental role and responsibilities of the experiment PI are:

- Defining the basic scientific and operational requirements for the experiment.
- Working with the project team to ensure that research objectives are maintained during design, development and flight.
- Completing and submitting the analyzed data and a final report to NASA and publishing the results, as appropriate.
- Complying with all safety training, policies and procedures as required by NASA.

Implementation Team Role and Responsibilities

A NASA-provided payload or project manager will lead the spaceflight implementation team. The team will work together to manage and implement the

phases of the experiment development cycle. The NASA-provided project scientist will work directly with the PI throughout this process.

Definition, Documentation and Testing of a Spaceflight Experiment

The following is representative of the documentation, testing and information that will be required.

To complete a successful experiment in microgravity, a detailed analysis and definition of the proposed experiment must be done. All requirements for the execution of the experiment must be identified and described and a feasibility analysis conducted.

Additionally, the required hardware and resource requirements must be identified in detail for all phases: preflight, flight, and postflight, including assessment of the maturity of the experiment's development and the adequacy of financial resources required for its conduct. If needed, and resources are available, the design, development and manufacture of experiment-unique hardware will be conducted, and experiment-hardware interfaces and operations will be verified through testing.

The PI will work with the assigned project scientist to complete all of the required phases for development and flight readiness. A series of reviews of the experiment will be conducted, including reviews for safety requirements. As per NASA life sciences flight experiment management policy, if satisfactory results are not obtained during testing, a flight experiment may be deselected and perhaps considered for ground research based on peer review or may need to be cancelled altogether.

Development of Spaceflight Experiment Requirements

The foundation of the spaceflight experiment is the clear definition and identification of all aspects of the proposed experiment. It is critical that the PI work with the project team in a series of activities that are necessary for developing the spaceflight experiment.

Science Ground Testing

The project scientist and the flight experiment team will support the PI in defining the types of testing that will be required before flight in order to mitigate risks and increase the chance of a successful experiment. These tests would include such



things as validation of new hardware and practice runs to optimize and streamline in-orbit operations. The test results will define requirements, procedures, hardware settings and configurations.

Ground Controls

Proper ground-control experiments are essential for conducting successful and scientifically sound spaceflight experiments (see Lessons Learned section, above). Rodents, equipment, facilities and staff to support these will be provided, as warranted, by NASA. Rodents for both flight and ground-control studies will meet the NASA Institutional Review Board guidelines for SPF animals (<http://irb.nasa.gov/docs/nasaCPHS-SpecificPathogenFree.pdf>).

- Synchronous ground-control animal experiments (housed in flight-type hardware on the ground) can be supported at NASA.
- Ground controls with animals may be performed on a time delay (delayed synchronous) to allow provision of ambient temperature and other biologically significant parameters that closely track actual flight conditions. Appropriate flight data will be recorded and made available as a basis for programming an environmental test chamber at KSC for this purpose.
- Vivarium controls can be conducted with animals kept under standard laboratory conditions (housing, temperature, light/dark, food/water, etc.) to provide a baseline to compare with the synchronous control and the flight-experiment data.

Hardware Biocompatibility Tests

Hardware biocompatibility testing is warranted in some cases to ensure that rodents of different sizes, strains, age or gender than previously flown do not encounter unexpected difficulties while housed in payload system hardware under the prescribed experimental conditions.

Project Integrated Tests

Integrated testing of expected hardware operations and procedures on the ground may be warranted. The experiment team will identify appropriate testing in collaboration with the PI.



Conducting a Spaceflight Experiment: Payload Flight Operations

Launching and delivering a life sciences experiment to the ISS requires extensive preparation in support of the logistics activities. NASA provides laboratories for preflight preparation and postflight experiment activities. All of the laboratory equipment that is needed for preflight- and postflight-experiment processing must be identified, and specialized equipment may have to be provided by the PI. The assigned NASA project scientist will assist and work directly with the PI to provide the necessary information and documentation for flight logistics and operations. Contingency planning for launch delays is also part of logistics planning.

Typical preflight activities include launch-site facility trial runs for preflight-experiment preparation and processing, astronaut training for in-flight experiment operations, and activities supporting transfer of experiment payload elements to the launch area. Additionally, trial runs for postflight-experiment activities to be conducted in laboratories on the ground upon return of the experiment to Earth must be considered.

NASA's Safety Policy

Safety is NASA's highest priority. Safety is the freedom from those conditions that can cause death, injury, occupational illness, damage to or loss of equipment or property, or damage to the environment. NASA's safety priority is to protect: (1) the public, (2) astronauts and pilots, (3) the NASA workforce (including employees working under NASA instruments), and (4) high-value equipment and property. All research conducted under NASA auspices shall conform to this philosophy (Source: NASA NRA).

Flight Safety

Compliance with all safety requirements per NASA policy must be met.

Biosafety considerations: pathogenic organisms are restricted aboard the ISS; proper containment considerations for all live specimens must be met. Mammalian research subjects destined for spaceflight must be tested for microbial organisms and pathogens before they are approved for flight in order to protect the crew members. They are also housed isolated from the crew during spaceflight in order to ensure that odors (Dalton et al., 2003) or contaminants do not threaten crew members' health, performance, or comfort. Compliance with chemical and toxicological safety considerations must also be satisfied. Certain chemical reagents are restricted aboard the ISS; proper levels of containment for all chemicals proposed for experiments must be met.

Examples of experiment procedures performed during spaceflight in microgravity are STS-58, with the SLS-2 mission where crew members collected blood samples from rats, performed injections of labeled albumin into rats, and dissected rats during spaceflight. During STS-90, the Neurolab mission, crews successfully performed in-flight tissue dissection of rat brains including fixation in a paraformaldehyde solution, and minor surgery with anesthesia (administered with insulin syringes) on rats to apply a labeling agent to muscles. In each of these cases, extensive studies were done on the ground preflight to test all procedures and experiment operations (Bateman et al., 2000, 2001; Ross et al., 2001).

Ground Safety

Compliance with all safety requirements and training per NASA policy must be met at all ground facilities preflight and postflight.

Animal Welfare

All rodent research conducted on ISS must be reviewed and approved by the NASA Institutional Animal Care and Use Committee (IACUC). The IACUC assures that all animal research conducted in spaceflight meets the requirements of all applicable federal regulations and that a comprehensive review of benefits and risks has been completed. The flight IACUC documentation will be prepared by the PI with the advice of an assigned NASA project science staff member.

Animal use and care requirements are described in Title 14 of the Code of Federal Regulations (CFR) 1232 (<http://www.ecfr.gov/cgi-bin/retrieveECFR?gp=1&SID=851284de94579b03df32fdc5ce90ef60&ty=HTML&h=L&n=pt14.5.1232&r=PART>).

Funding Opportunities/ Points of Contact

NASA research announcements are managed through NSPIRES. This Web-based system supports NASA research by release of solicitation announcements and proposal peer review and selection processes (<http://nspires.nasaprs.com/external/index.do>).

Additional research announcements and flight opportunities can be found at the CASIS website: <http://www.iss-casis.org/Home.aspx>. CASIS also encourages submission of unsolicited proposals.

Citations

Adams, G.R., Haddad, F., McCue, S.A., Bodell, P.W., Zeng, M., Qin, L., Qin, A.X., and Baldwin, K.M. (2000). Effects of spaceflight and thyroid deficiency on rat hindlimb development. II. Expression of MHC isoforms. *J. Appl. Physiol.* Bethesda Md 1985 88, 904-916.

Alberts, J.R., and Ronca, A.E. (1997). Rat pregnancy and parturition survive spaceflight challenge: new considerations of developmental consequences. *J. Gravitational Physiol. J. Int. Soc. Gravitational Physiol.* 4, P55-58.

Allebban, Z., Gibson, L.A., Lange, R.D., Jago, T.L., Strickland, K.M., Johnson, D.L., and Ichiki, A.T. (1996). Effects of spaceflight on rat erythroid parameters. *J. Appl. Physiol.* Bethesda Md 1985 81, 117-122.

Bateman, T.A., Zimmerman, R.J., Ayers, R.A., Ferguson, V.L., Chapes, S.K., and Simske, S.J. (1998). Histomorphometric, physical, and mechanical effects of spaceflight and insulin-like growth factor-I on rat long bones. *Bone* 23, 527-535.

Bateman, T.A., Dunstan, C.R., Ferguson, V.L., Lacey, D.L., Ayers, R.A., and Simske, S.J. (2000). Osteoprotegerin mitigates tail suspension-induced osteopenia. *Bone* 26, 443-449.

Bateman, T.A., Dunstan, C.R., Lacey, D.L., Ferguson, V.L., Ayers, R.A., and Simske, S.J. (2001). Osteoprotegerin ameliorates sciatic nerve crush induced bone loss. *J. Orthop. Res. Off. Publ. Orthop. Res. Soc.* 19, 518-523.

Campbell, M.R., Williams, D.R., Buckley, J.C., and Kirkpatrick, A.W. (2005). Animal surgery during spaceflight on the Neurolab Shuttle mission. *Aviat. Space Environ. Med.* 76, 589-593.

Clément, G., and Slenzka, K. (2006). *Fundamentals of Space Biology: Research on Cells, Animals, and Plants in Space* (Space Technology Library). Microcosm Press; Springer, El Segundo, Calif.: New York, NY. 18.

Dalton, P., Gould, M., Girtten, B., Stodieck, L.S., and Bateman, T.A. (2003). Preventing annoyance from odors in spaceflight: a method for evaluating the sensory impact of rodent housing. *J. Appl. Physiol.* Bethesda Md 1985 95, 2113-2121.

DeLombard, R., Hrovat, K., Kelly, E., and McPherson, K. (2004). Microgravity environment on the International Space Station. NASA/TM-2004-213039; AIAA Paper 2004-0125; E-14473. Available at: <http://ntrs.nasa.gov/search.jsp?R=20040070758>.

Fitzgerald, J., and Moscirocki, C. (2012). Activation of Stress Response Networks in Cartilage and Skeletal Muscle During Spaceflight. 2012 Orthopaedic Research Society Annual Meeting, February 4-7, 2012. (San Francisco, CA).

Lesnyak, A., Sonnenfeld, G., Avery, L., Konstantinova, I., Rykova, M., Meshkov, D., and Orlova, T. (1996). Effect of SLS-2 spaceflight on immunologic parameters of rats. *J. Appl. Physiol.* Bethesda Md 1985 81, 178-182.

Maese, A., and Ostrach, L. (2002). Neurolab: Final Report for the Ames Research Center Payload (TM-2002-211841). Available at: <http://ntrs.nasa.gov/archive/nasa/casi.ntrs.nasa.gov/20020073543.pdf>.

Miller, E.S., Koebel, D.A., and Sonnenfeld, G. (1995). Influence of spaceflight on the production of interleukin-3 and interleukin-6 by rat spleen and thymus cells. *J. Appl. Physiol.* Bethesda Md 1985 78, 810-813.

Morey-Holton, E.R., and Globus, R.K. (2002). Hindlimb unloading rodent model: technical aspects. *J. Appl. Physiol.* Bethesda Md 1985 92, 1367-1377.

NASA (2013). NASA Research Announcement (NRA) NNH14ZTT001N: Spaceflight research opportunities in space biology. NRA Guidebook for Proposers available at: <http://www.hq.nasa.gov/office/procurement/nraguidebook/proposer2014.pdf> and <http://www.hq.nasa.gov/office/procurement/nraguidebook/proposer2014.docx>.

NASA (2014a). Commercial Biomedical Testing Module: Effects of Osteoprotegerin on Bone Maintenance in Microgravity (CBTM). http://www.nasa.gov/mission_pages/station/research/experiments/880.html.

NASA (2014b). Commercial Biomedical Test Module - 2 (CBTM-2). http://www.nasa.gov/mission_pages/station/research/experiments/201.html.

NASA (2014c). Commercial Biomedical Testing Module-3: STS-135 space flight's affects on vascular atrophy in the hind limbs of mice (CBTM-3-Vascular Atrophy). http://www.nasa.gov/mission_pages/station/research/experiments/1016.html.

NASA (2014d). Commercial Biomedical Testing Module-3: Assessment of sclerostin antibody as a novel bone forming agent for prevention of spaceflight-induced skeletal fragility in mice (CBTM-3-Sclerostin Antibody): http://www.nasa.gov/mission_pages/station/research/experiments/324.html.

National Research Council (U.S.) (2011). Recapturing a future for space exploration: life and physical sciences research for a new era (Washington, D.C: National Academies Press).

Riley, D.A., Ellis, S., Slocum, G.R., Sedlak, F.R., Bain, J.L., Krippendorf, B.B., Lehman, C.T., Macias, M.Y., Thompson, J.L., Vijayan, K., et al. (1996). In-flight and postflight changes in skeletal muscles of SLS-1 and SLS-2 spaceflown rats. *J. Appl. Physiol.* Bethesda Md 1985 81, 133-144.

Ronca, A. (2003). Mammalian development in space. In Marthy HJ, (Ed), *Advances in Space Biology and Medicine*, (Netherlands: Elsevier), pp. 217-251, 9.

Ross, A.B., Bateman, T.A., Kostenuik, P.J., Ferguson, V.L., Lacey, D.L., Dunstan, C.R., and Simske, S.J. (2001). The effects of osteoprotegerin on the mechanical properties of rat bone. *J. Mater. Sci. Mater. Med.* 12, 583-588.

Sonnenfeld, G. (Ed) (2005). *Advances in Space Biology and Medicine: Experimentation With Animal Models In Space.* (Amsterdam; Boston: Elsevier),10.

Sonnenfeld, G., Foster, M., Morton, D., Bailliard, F., Fowler, N.A., Hakenewerth, A.M., Bates, R., and Miller, E.S. (1998). Spaceflight and development of immune responses. *J. Appl. Physiol.* Bethesda Md 1985 85, 1429-1433.

Sung, M., Li, J., Spieker, A.J., Spatz, J., Ellman, R., Ferguson, V.L., Bateman, T.A., Rosen, G.D., Bouxsein, M., and Rutkove, S.B. (2013). Spaceflight and hind limb unloading induce similar changes in electrical impedance characteristics of mouse gastrocnemius muscle. *J. Musculoskelet. Neuronal Interact.* 13, 405-411.

Appendix

Animal Enclosure Module (AEM): A Brief History

- Original concept developed by students with funding support from a NASA contractor. Initial short-duration ground tests done with rats using potatoes for food and water.
- NASA's Ames Research Center (ARC) developed the concept into an AEM for integration with the middeck locker module for the STS with an advanced waste collection system, solid food bars, water system, laminar airflow, lighting system, and more.
- Evolved from a rat habitat to a dam/pup nesting chamber and then also a mouse habitat.
- An Animal Access Unit was developed for use with AEM to support ARC rat payloads on the STS-90 Neurolab mission (Maese and Ostrach, 2002).
- AEMs have flown on over 25 missions.
- The AEM is the basis for the upgraded NASA "Rodent Research Habitat" validation mission that launched to the ISS, September, 2014.

Recent Rodent Flight Experiments

The following are spaceflight experiments with mice that were conducted on the last three space shuttle flights, STS-131, 133, and 135. Each mission included a Biospecimen Sharing Program. Analysis of results from some experiments was still in progress at the time of publication of this report. Refer to the NASA Taskbook for status of experiment reports at <https://taskbook.nasaprs.com/Publication/welcome.cfm>.

STS-131/133/135 Biospecimen Sharing Program

STS-131/133/135 Missions				
<i>Rodent Flight Experiments, by Principal Investigator</i>				
Investigator	Science Discipline	Title of Study	Research Subject	Mission
Ronald J. Midura	Muscle Physiology and Vasculature	Space Flight's Affects on Vascular Atrophy in the Hind Limbs of Mice	Mus musculus	STS-135
Mary L. Bouxsein	Bone Physiology	Assessment of Anti-Sclerostin Antibody as a Novel Anabolic Therapy for Prevention of Spaceflight-Induced Skeletal Fragility in Mice	Mus musculus	STS-135
Roberto Garofalo	Cell and Molecular Biology	Effect of Space Flight on Lung Gene and Protein Expression Profiles	Mus musculus	STS-135
Millie Hughes-Fulford	Immunology	Evaluation of Changes in Thymus and Spleenocytes After Spaceflight	Mus musculus	STS-131/135
<i>Biospecimen Sharing Program Experiments, by Principal Investigator</i>				
Larry Hoffman	Developmental Biology; Neurophysiology	Synaptic Plasticity in Mammalian Utricle; Synaptic Plasticity mammalian vestibular maculae	Mus musculus	STS-131/133
Maja Mednieks	Cell and Molecular Biology	Protein Expression in Salivary Glands: Effects of Extended Space Flight	Mus musculus	STS-131/133/135
Alan Hargens	Bone Physiology	Rodent Spine Deconditioning After 30 Days of Microgravity; Rodent Tail and Brain Deconditioning After 10-15 Days of Microgravity	Mus musculus	STS-131/133/135
Eduardo Almeida	Cell and Molecular Biology	The Role of Artificial Gravity in Promoting Tissue-Regenerative Matrix-Integrin-Kinase Cell Signaling; The Role of the p21/p53 Pathway in Spaceflight-Induced Tissue Degeneration	Mus musculus	STS-131/133/135
Michael Delp	Cardiovascular Physiology	Regional Arterial Remodeling Induced by Microgravity	Mus musculus	STS-131/133/135
Joseph Tash	Cell and Molecular Biology	Long Term Space Flight Impacts on Female Reproductive Health; Long Term Space Flight Impacts on Male Reproductive Health	Mus musculus	STS-131/133

STS-131/133/135 Biospecimen Sharing Program *continued...*

Investigator	Science Discipline	Title of Study	Research Subject	Mission
Stavros Thomopoulos	Cell and Molecular Biology	The Effect of Weightlessness on the Tendon-to-Bone Insertion	Mus musculus	STS-131/133
David Fitzgerald	Cell and Molecular Biology	The Response of Articular Cartilage to Microgravity; Gene Expression Alterations in Articular Cartilage, Skeletal Muscle and Skin Exposed to Microgravity	Mus musculus	STS-131/133/135
Richard Boyle	Neurophysiology	Inner Ear Otoconia Response in Mice to Microgravity and Hypergravity	Mus musculus	STS-133/135
Susana Zanello	Cell and Molecular Biology	Spaceflight Effects on the Mouse Retina: Histological, Gene Expression and Epigenetic Changes After Flight	Mus musculus	STS-133
Elisabeth R. Barton	Cell and Molecular Biology	Skeletal Muscle Regeneration	Mus musculus	STS-135
Clarence Sams	Metabolism and Nutrition	Examination of Splenic and Thymic Immune Function in Mice	Mus musculus	STS-135
Scott M. Smith	Metabolism and Nutrition	Evaluation of the Effect of Short Duration Spaceflight on Hepatic Nutrition, Oxidative Damage, and Colon Microflora	Mus musculus	STS-135
V.E. Wotring	Cell and Molecular Biology	Effect of Spaceflight on Expression of Metabolic Enzyme Genes in Mice	Mus musculus	STS-135
Hiroki Yokota	Cell and Molecular Biology	Unloading-Driven Regulation of Eukaryotic Initiation Factor 2 (eIF2) and Genes Linked to Integrated Stress Response in Mouse Bone Tissues	Mus musculus	STS-135
Daila Gridley	Cell and molecular Biology	STS-135 Tissue Request for Loma Linda University - Thymus	Mus musculus	STS-135
Brooke Harrison	Muscle physiology	Myosins and myomiRs: The Effects of Spaceflight on Myosin Heavy Chain Gene and MicroRNA Expression in Heart and Skeletal Muscle	Mus musculus	STS-135

STS-131/133/135 Biospecimen Sharing Program *continued...*

Investigator	Science Discipline	Title of Study	Research Subject	Mission
Akihiko Ishihara	Muscle Physiology	Effect of Exposure to Microgravity on the Fast-Type Neuromuscular Unit	Mus musculus	STS-135
Karen Jonscher	Cell and Molecular Biology	Does Spaceflight Alter SIRT3 Activity and Mitochondrial Function in the Liver	Mus musculus	STS-135
Moshi Levi	Renal, Gluid and Electrolyte Physiology	Spaceflight Effects on Renal and Intestinal Transporters Associated with Osteopenia and Kidney Stone Formation and Regulation of Renal Glucose and Lipid Metabolism	Mus musculus	STS-135
Xiao Mao	Developmental Biology	STS-135 Tissue Request for Loma Linda University - Ocular Tissue; STS-135 Tissue Request for Loma Linda University - Skin Tissue; STS-135 Tissue Request for Loma Linda University - Brain	Mus musculus	STS-135
Gregory Nelson	Neurophysiology	Effect of Space Flight on Neurogenesis	Mus musculus	STS-135
Michael Pecaat	Immunology	Effects of Spaceflight Environment on Immune Parameters	Mus musculus	STS-135
Masahiro Terada	Cell and Molecular Biology	Biomedical Analyses of Mice Body Hair Exposed to the Space Flight	Mus musculus	STS-135
Jian Tian	Developmental Biology	STS-135 Tissue Request for Loma Linda University - Lungs	Mus musculus	STS-135
Shin-ichi Usami	Cell and Molecular Biology	The Effect of Microgravity on Gene Expression in the Vestibular Endorgans	Mus musculus	STS-135
Jeffrey Willey	Developmental Biology	STS-135 Tissue Request: Menisci	Mus musculus	STS-135
Seward Rutkove	Muscle Physiology	STS-135 Tissue Request: Gastrocnemius (Sung et al., 2013)	Mus musculus	STS-135

Acronyms

AAU	Animal Access Unit
AEM	Animal Enclosure Module
ARC	NASA's Ames Research Center
CASIS	Center for the Advancement of Science in Space
CRS	Commercial Resupply Services
EUE	Experiment Unique Equipment
EXPRESS	Expedite the Processing of Experiments to the Space Station
GLACIER	General Laboratory Active Cryogenic ISS Experiment Refrigerator
IACUC	Institutional Animal Care and Use Committee
ISPR	International Standard Payload Racks
KSC	NASA's Kennedy Space Center
LET	Low-Linear Energy Transfer
MELFI	Minus Eighty Laboratory Freezer for ISS
MSG	Microgravity Science Glovebox
MTB	Mouse Transfer Box
NL	National Laboratory
NRA	NASA Research Announcement
NRC	National Research Council
NSPIRES	NASA Solicitation and Proposal Integrated Review and Evaluation System
OSU	Operations Support Hardware
PI	Principal Investigator
RR	Rodent Research
RR-1	Rodent Research-1 (Rodent Research [RR] Hardware System for short)
SPF	Specific Pathogen Free
STS	Space Transportation System

The Complete ISS Researcher's Guide Series

1. Acceleration Environment
2. Cellular Biology
3. Combustion Science
4. Earth Observations
5. Fluid Physics
6. Fruit Fly Research
7. Fundamental Physics
8. Human Research
9. Macromolecular Crystal Growth
10. Microbial Research
11. Microgravity Materials Research
12. Plant Science
13. Rodent Research
14. Space Environmental Effects
15. Technology Demonstration

For more information...

Space Station Science

<http://www.nasa.gov/iss-science>

Facilities

http://www.nasa.gov/mission_pages/station/research/facilities_category.html

ISS Interactive Reference Guide

<http://www.nasa.gov/externalflash/ISSRG/index.htm>

Researchers/Opportunities

http://www.nasa.gov/mission_pages/station/research/ops/research_information.html

ISS Research Customer Helpline

JSC-ISS-research-helpline@mail.nasa.gov

281-244-6187



National Aeronautics and Space Administration

Johnson Space Center

<http://www.nasa.gov/centers/johnson>

www.nasa.gov

