



WITH YOU WHEN YOU FLY:

Aeronautics for Introductory Physics



A joint project of
NASA Aeronautics
and the
American Association of
Physics Teachers



Table of Contents

Overview	4
Physics Aeronautics: A Contextual Approach for Learning Physics	4
About NASA Aeronautics	5
About the AAPT	5
Standards and Best Practices	6
Standards	6
Next Generation Science Standards	6
Common Core State Standards	6
Theoretical Foundations	7
Building Conceptual Models of Flight Physics	7
Modeling Method of Instruction in Physics	8
Levels of Inquiry	9
Learning Cycle	10
Scientific Thinking	12
Inquiry Lesson/Lab: Scaling and Paper Airplanes	13
Literary/Data Analysis: Wings According to Size	20
Successful Flight Test of Shape-Changing Wing Surface	29
Constant Velocity	30
Real-World Applications: Flying Speed	31
A Day in the Life of Air Traffic Control	34
Problem Set: Comparative Velocities	37
Problem Set: Vectors in Relative Velocities Problems	39
Real-World Applications: Estimating the Speed and Distance of an Airplane	43
Real-World Applications: Noise Doppler-Shift Measurement of Airplane Speed	52
New Acoustics Techniques Clear Path for Quieter Aviation	53
Real-World Applications: Smart Skies	54
Fly by Math	54
Line Up With Math	55
Sector 33	55
Air Traffic Operations Lab Answering Big Questions About the Future of Air Travel	58
NASA Tool Helps Airlines Minimize Weather Delays	58
Interactive Demonstration: Pitot-Static Tube	59
Inquiry Lesson/Lab: Bernoulli Effect Lab	65
Problem Set: Bernoulli's Equation and Pitot-Static Tubes	73
Discovery Lab: Airplane Dynamics: Engine Thrust, Braking, and Lift	76
Uniform Acceleration	78
Literary/Data Analysis: Prepare for Landing	79
Shhhh! Keep it Down Please!	84
Application Lesson/Lab: Mobile Accelerometers	85
NASA-Pioneered Automatic Ground-Collision Avoidance System Operational	90
Terminal Velocity	91
Discovery Lab (Raw): Drag Stations Lab	92
Discovery Lab (Contextual): Drag and Aircraft Design	99
NASA Researchers to Flying Insects: "Bug Off!"	107
Inquiry Lesson/Lab: Viscosity Tubes	108
NASA Turns World Cup Into Lesson in Aerodynamics	116
Inquiry Lesson/Lab: The Physics of Soaring (and L/D ratios)	117
Problem Set: Glider Trajectory Problems	125

Literary/Data Analysis: Flying with Finesse	127
Model Building: Developing a Model for Drag	132
Force Particle – Inertia	137
Inquiry Lesson/Lab: Falling and Air Resistance (Qualitative)	138
Skyray 48 Takes Flight	143
Real-World Applications: Hanging an Airplane: A Case Study in Static Equilibrium	144
NASA Model Flies at Air and Space	150
Problem Set: Trimmed Aircraft Activity	151
Inquiry Lesson/Lab: Investigating Flight with a Toy Helicopter	157
Future Helicopters Get SMART	162
Interactive Demonstration: Lift Demonstrations	163
Inquiry Lesson/Lab: Measuring Lift with the Wright Airfoils	165
Glow With the Flow	175
Problem Set: Lift-Velocity Relationship Problems	176
Problem Set: Lift Equation Problems	178
Model Building: Developing a Model for Lift	180
Inquiry Lesson/Lab: Rubber-Band-Driven Airplane Contest	190
Recalling a Record: X-43A Scramjet Sets New Hypersonic Record a Decade Ago	194
Real-World Applications: Helicopter Toy and Lift Estimation	195
Constant Net Force	200
Real-World Applications: Parachute Lab	201
Inquiry Lesson/Lab: Falling and Air Resistance (Quantitative)	206
Hitchhiking Sensors Capture Curiosity’s Entry	212
Problem Set: Simplified Aircraft Motion	213
Problem Set: Forces in a Climb	216
Interactive Demonstration: Demonstration of Newton’s Third Law Using a Balloon Helicopter	219
2-D Combination	221
Real-World Applications: Measuring the Flight Speeds of Fire Bombers from Photos: An In-Class Exercise in Introductory Kinematics	222
NASA Tests Radio for Unmanned Aircraft Operations	224
Problem Set: Aircraft Motion Activity	225
Energy	227
Literary/Data Analysis: A Hard Day’s Flight	228
Literary/Data Analysis: In Wind and Weather	232
NASA Helicopter Drop Test a Smashing Success	235
Rotational Motion	236
Real-World Applications: Circular Motion Studies with a Toy Airplane/The Airplane Experiment	237
Real-World Applications: Measuring the Moment of Inertia of an Airplane	241
Video: Flight Testing Newton’s Laws – Weight and Balance	242
Additional Resources	243
Literary/Data Analysis Activity: The 747 and its Competitors	244
NASA Resources	247
AAPT Resources	248
American Association of Physics Teachers	248
<i>The Physics Teacher</i> magazine	248
Additional Resources	249
Literature Resources	249
Leybold Lessons (and Laboratory Equipment)	249
Other Aeronautics Education Resources	249

Overview

Physics Aeronautics: A Contextual Approach for Learning Physics

There are many right ways to teach physics. **Teaching by inquiry in context** is perhaps the most effective way to effectively teach physics so that it becomes both relevant and practical. This educators' guide addresses a growing need for higher-level inquiry in the physics classroom, provides a solid content base, and actively engages with topics necessary to the development of 21st century skills. Context is provided from student experiences with flight as well as ongoing aeronautics research.

This document is the result of a Space Act Agreement between NASA and the American Association of Physics Teachers. This project is founded on teaching ideas presented by seasoned high school and college physics teachers and articles that have appeared in the American Association of Physics Teachers' (AAPT) publication, *The Physics Teacher*. As such, all of these ideas are appropriate for high school or introductory university level physics courses, and have been reviewed by acting high school and college/university AAPT members. Although it is not necessary for lesson and lab implementation to read the published articles associated with the activities in this document, all of the articles are freely available to AAPT members through the [AAPT Publications website](#) and directly from each link at the top of each activity.

In addition, practical relevance is interwoven through the guide with applications from current, cutting-edge aeronautics research being undertaken by the National Aeronautics and Space Administration's Aeronautics Research Mission Directorate (NASA ARMD). Each of the activities in this document is aligned with at least one of NASA Aeronautics' research themes, including green aviation, reducing flight delays, revisiting supersonic flight, and designing future aircraft. Inquiry lessons presented in this document help students develop concepts, derive fundamental equations, practice reading and data analysis skills, and relate their laboratory work to real-world applications in NASA Aeronautics research.

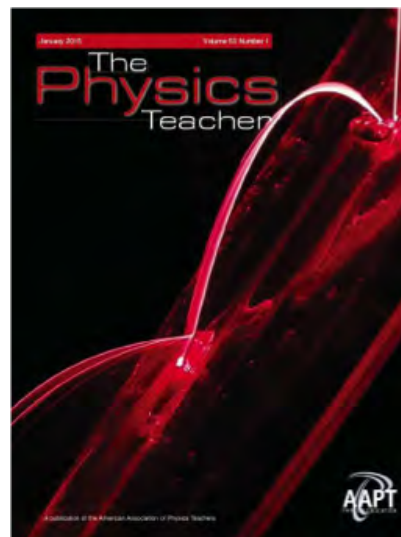

While this document presents itself as an educator's activity guide filled with resources for demonstrations, lessons, and labs, instructional approach is also very important. Many of these activities are structured as paradigm labs that could easily serve as a curricular supplement to the Modeling Method of Instruction approach. Many of these activities can also be easily applied or adapted to align with the Next Generation Science Standards (NGSS) and the Common Core State Standards (CCSS) for Reading and Writing in Technical Subjects. Each activity includes objectives and/or guiding questions related to the physics of flight, followed by a very detailed listing of the NGSS and CCSS addressed by students who successfully complete each activity.

About NASA Aeronautics



NASA Aeronautics works to solve the many challenges that still exist in our nation's air transportation system: air traffic congestion, safety, efficiency, and environmental impacts. Thanks to advancements in aeronautics developed by NASA, today's aviation industry is better equipped than ever to safely and efficiently transport passengers and cargo to their destinations. In fact, every U.S. aircraft flying today and every U.S. air traffic control tower uses NASA-developed technology in some way.

Streamlined aircraft bodies, quieter jet engines, techniques for preventing icing, drag-reducing winglets, lightweight composite structures, software tools to improve the flow of tens of thousands of aircraft through the sky, and so much more are an everyday part of flying thanks to NASA research that traces its origins back to the earliest days of aviation.

We are committed to transforming aviation by dramatically reducing its environmental impact, improving efficiency while maintaining safety in more crowded skies, and paving the way to revolutionary aircraft shapes and propulsion.

Inside cockpits, cabins and jet engines; atop traffic control towers; and from departure gate to arrival terminal at airports everywhere, the DNA of the entire aviation industry is infused with technology that has its roots in NASA research.

NASA is with you when you fly.

Learn more about NASA Aeronautics at:
<http://www.nasa.gov/aeronautics>

About the AAPT



The American Association of Physics Teachers was established in 1930 with the fundamental goal of ensuring the "dissemination of knowledge of physics, particularly by way of teaching." Today, that vision is supported by members around the world. The AAPT is a strong professional physics science society dedicated to the pursuit of excellence in physical science education.

National meetings are held each winter and summer, and are opportunities for members, colleagues, and future physicists from around the world to:

- Participate in physics workshops
- Meet and greet other physics educators
- Form networks nationally and locally
- Engage exhibitors and learn about the latest physics resources
- Discuss innovations in teaching methods
- Share the results of research about teaching and learning.

The AAPT also hosts or supports smaller [workshops and conferences](#) and [symposia](#) throughout the year to provide further opportunities for professional development and knowledge sharing. The AAPT also supports physics teachers through peer-reviewed journals, teacher resources, competitions and contests, and awards and grants.

Learn more about the AAPT at:
<http://www.aapt.org/>

Standards and Best Practices

Standards

Next Generation Science Standards

Many of the activities in this guide provide an opportunity to teach about standard physics Core Disciplinary Ideas (CDI) in mechanics and beyond. The specific referenced standards are listed below. Further, most Cross-Cutting Concepts (CCC) and many Science and Engineering Practices (SEP) can be explicitly addressed through these activities.

Core Disciplinary Ideas

HS.PS2 - Forces and Interactions: <http://goo.gl/Z8KDSG>

HS.PS3 - Energy: <http://goo.gl/TeiZH5>

Science and Engineering Practices

Appendix F: <http://goo.gl/ucX7iY>

1. Asking questions (for science) and defining problems (for engineering)
2. Developing and using models
3. Planning and carrying out investigations
4. Analyzing and interpreting data
5. Using mathematics and computational thinking
6. Constructing explanations (for science) and designing solutions (for engineering)
7. Engaging in argument from evidence
8. Obtaining, evaluating, and communicating information



*Registered trademark of Achieve. Neither Achieve nor the lead states and partners that developed the NGSS was involved in the product of, and does not endorse, this product.

Cross Cutting Concepts

Appendix G: <http://goo.gl/WhEEjr>

1. Patterns
2. Cause and effect
3. Scale, proportion, and quantity
4. Systems and system models
5. Energy and matter
6. Structure and function
7. Stability and change

Common Core State Standards

English Language Arts Reading in Science and Technical Subjects

This educators' guide provides a number of opportunities for reading technical work. Students are encouraged to use *The Simple Science of Flight*, by Tennekes, for the guided literary and data analysis passages. Further, most activities have a "NASA Connection" that is directly linked to a brief article about current NASA Aeronautics Research.

Grades 9-10: <http://goo.gl/n3KObX>

Grades 11-12: <http://goo.gl/gFceem>

English Language Arts Writing in Science and Technical Subjects

By extending a number of the laboratory activities, students can be asked to defend their results in writing through formal reports.

Grades 9-10: <http://goo.gl/SUqw8Y>

Grades 11-12: <http://goo.gl/PPg5rM>

Theoretical Foundations

Building Conceptual Models of Flight Physics

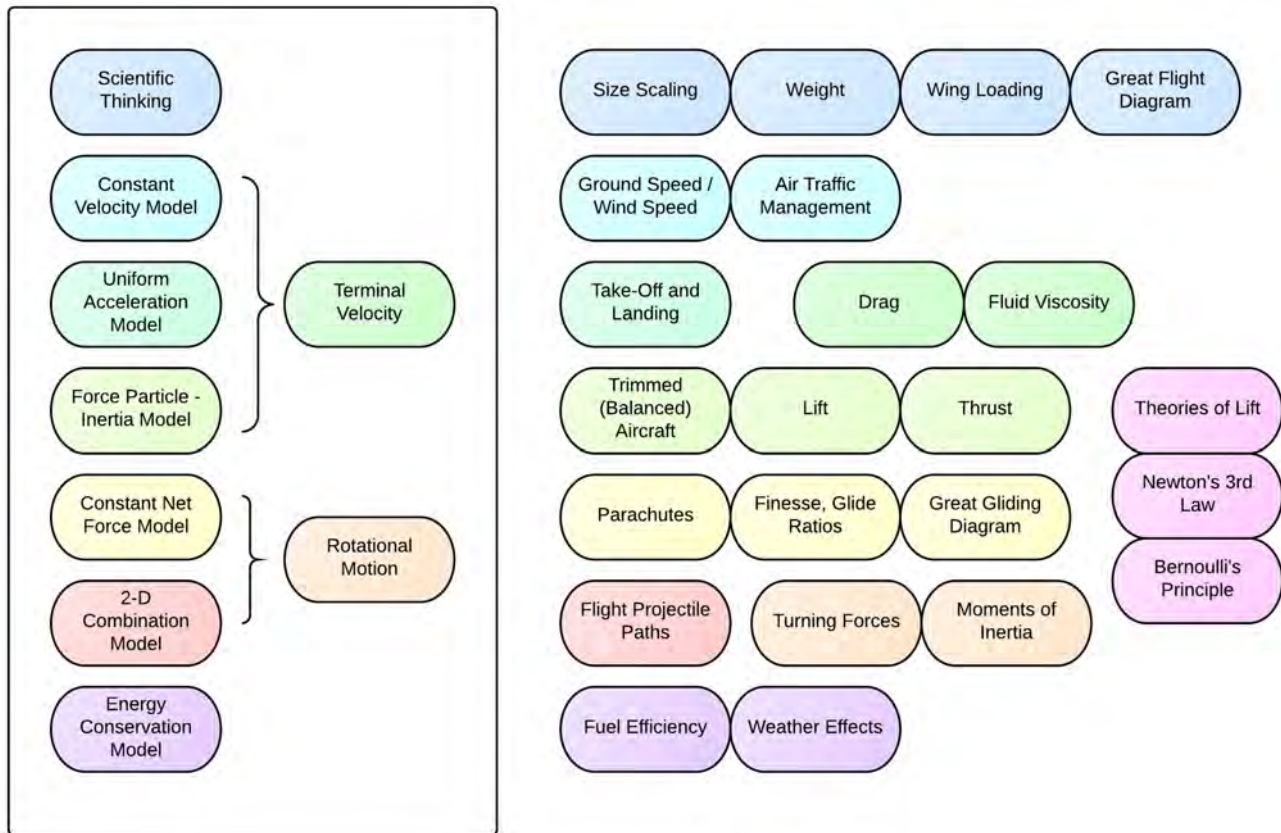

Aeronautics for Introductory Physics' approach to contextual physics teaching and learning does not rely upon building mental models that are unique to flight – rather, it is founded on the ideas of traditional physics instruction, paralleling the structures used in the **Modeling Method of Instruction** in Physics. For all of the inquiry labs in this document, students are expected to build graphical and mathematical models to describe relationships between variables in the system.

Within mechanics, there is ample room for students to build mental sub-models to describe flight because of the chaotic nature of microscopic fluid particles. Some of these mental models can be built around the following concepts.

Models of Drag (as opposed to simple surface friction) – [Teacher Resource](#)

Models of Lift – [Teacher Resource](#)

Although students without a solid background in chemistry might not be able to build these models on their own, teachers can offer supports. The following models are not discussed in depth within this document, but teachers and students can find very helpful supporting information at [NASA's Beginner's Guide to Aeronautics](#).

Both of the above models can be highly complex, and require some understanding of molecular kinetic theory (viscosity, intermolecular forces, chaos, etc.), as well as Newton's Third Law. In essence, students can work their way to understanding that no matter the dominating mental model (simple or complex), it is the mechanical conservation laws (mass, energy, momentum) that fully describe flight.

Additionally, aeronautics offers the opportunity for students to see that a single model produced for an object moving through a fluid might be very specific – unlike many of the “universal” mental models typically developed in the physics classroom.

Modeling Method of Instruction in Physics

For those familiar with the Modeling Method of Instruction...

Many of the labs presented in this document are an opportunity to have students model relationships mathematically and graphically, and to explain those relationships by building their own conceptual models for the interaction of objects flowing through a fluid. A number of the labs could be used as paradigm labs for initial development of conceptual models. Additionally, the nature of aerodynamics introduces students to the complexities of modeling associated with dimensionless constants. Further, this study of flight allows students to realize that models might not be universally applicable, and that relationships that cannot be easily represented by a single simple equation. For example, coefficients of lift and drag are often measured experimentally for a single aircraft in a very specific set of environmental conditions – modifications in the system might not result in a predictable change.

For those not familiar with the Modeling Method of Instruction...

The National Science Foundation funded Arizona State University (ASU) Modeling Instruction Program for 16 years, from 1990 to 2005. The American Modeling Teachers Association was founded at the expiration of NSF funding in 2005, and over the past 10 years has reached about 5000 more teachers with Modeling workshops. At present a little over 7500 teachers have attended one or more Modeling workshops since 1990. In 2015, about 1000 more teachers will attend workshops. AMTA coordinates 60 or more Modeling workshops each summer in physics, chemistry, biology and middle school science (in 2013 and 2014 there were ~80 workshops each summer). At current capacity, AMTA is on track to serve 1000 teachers every summer with Modeling workshops across the disciplines (physics, chemistry, biology, and physical science), and is working to build capacity as demand for Middle School Modeling workshops exceeds the capacity to provide trained workshop leaders.

From: <http://modeling.asu.edu/modeling/WhatModInstructionIs-2014.htm>

Modeling instruction was developed at ASU over two decades to integrate insights from physics education research with classroom experience of exceptional in-service teachers. In a series of intensive three-week workshops over two years, teachers improve their physics, chemistry, or physical science content knowledge and are equipped with a robust teaching methodology for developing student abilities to:

- Make sense of physical experience, Understand scientific claims,
- Articulate coherent opinions of their own and defend them with cogent arguments,
- Evaluate evidence in support of justified belief.

More specifically, teachers learn to:

- Ground their teaching in a well-defined pedagogical framework (Modeling Theory), rather than following rules of thumb;
- Organize course content around scientific models as coherent units of structured knowledge;
- Engage students collaboratively in making and using models to describe, to explain, to predict, to design and control physical phenomena;
- Involve students in using computers as scientific tools for collecting, organizing, analyzing, visualizing, and modeling real data;
- Assess student understanding in more meaningful ways and experiment with more authentic means of assessment;
- Continuously improve and update instruction with new software, curriculum materials and insights from educational research;
- Work collaboratively in action research teams to mutually improve their teaching practice.

For more information on the Modeling Method of Instruction, please see Modeling Instruction: An Effective Model of Science Education, by Drs. Jane Jackson, Larry Dukerich, and David Hestenes.

<http://www.nsela.org/images/stories/scienceeducator/17article7.pdf>

Learn more about the AMTA at:
<http://modelinginstruction.org>



Levels of Inquiry

Each activity in this document is also classified by its level of inquiry; the complexity of the skill expected of students in order to investigate the science. Historically, Herron’s levels of inquiry (0) Confirmation/Verification, (1) Structured, (2) Guided, and (3) Open focus exclusively on three parts of an inquiry process: problem, procedure, and solution. However, little attention is given in that model to understand the varying levels of complexity of the problem to be studied, the procedure to be undertaken, or the solution to be comprehended. The Levels of Inquiry Model by Dr. Carl J. Wenning of Illinois State University is used throughout this document. These levels are also supplemented by Literary/Data Analysis and Model Building, both which can occur during or external to inquiry activities.

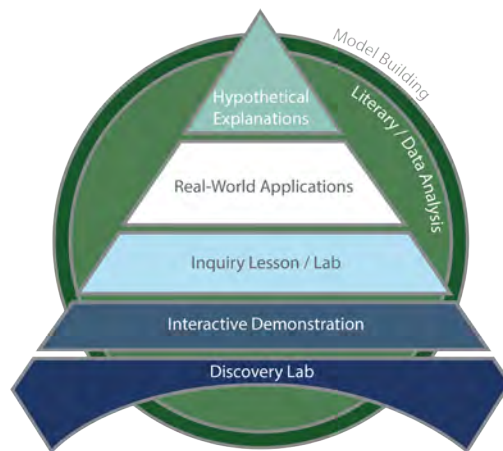

Discovery Learning	Interactive Demonstration	Inquiry Lesson	Inquiry Lab	Real-World Applications	Hypothetical Explanations
<i>Low</i>	Intellectual Sophistication				<i>High</i>
<i>Teacher</i>	Locus of Control				<i>Student</i>

Discovery Learning – Students experience a variety of phenomena, are asked to identify simple trends, relationships, or similarities/differences among them.

Interactive Demonstration – The teacher provides a guided demonstration to identify preconceptions, cause cognitive dissonance, or help students identify causation.

Inquiry Lesson/Lab – The teacher guides students in an inquiry-based discussion (lesson) or allows students to work on their own (lab) to determine a quantitative relationship between variables. Because an experience in the laboratory can be easily modified to be more teacher- or student-directed, these activities are grouped together in this document.

Real-World Application – Students use a known relationship to apply conceptual understanding to a new situation either through a paper-pencil or discussion lesson, or through a hands-on lab.

Hypothetical Explanations – Students generate, develop, and test hypotheses. The focus during these activities is on the cause and explanation behind phenomena – not on describing them. (Note: Although predictions are a key part in developing working explanations, hypotheses are the focus here. Hypotheses have explanatory power. Predictions are simply anticipatory statements about what will happen to something under a given set of circumstances.) Although some activities in this document can be used to create hypothetical explanations, no activities in this document bear this level of complexity.

Literary and/or Data Analysis Activities – These activities might not directly involve any scientific inquiry, but allow students to apply what they have learned to examine technical passages.

Model Building - Students and teachers work together to elicit, confront, and resolve misconceptions while building up an underlying conceptual foundation by organizing course content around coherent units of structure knowledge (see the Modeling Method of Instruction, above). In its full form, model building occurs at every stage of scientific inquiry, and is explicitly addressed when students are asked to synthesize what they have learned based upon evidence from their investigations.

For more information on the levels of inquiry, see: *Levels of Inquiry: Hierarchies of Pedagogical Practices and Inquiry Processes* by Dr. Carl J. Wenning. http://www.dlsu.edu.ph/offices/asist/documents/Levels_of_Inquiry.pdf

Learning Cycle

Within each of the levels of inquiry, teachers can effectively employ a self-regulated learning cycle to structure their individual lessons and support student interaction. There are many learning cycles that have been identified throughout educational history, including experiential learning cycles presented by John Dewey, Hans Aebli and Eric Mazur, among others. However, attention in the learning cycle often fails to take into consideration the collaborative nature of student learning, self-regulation in the classroom, and the importance of informed decision-making. In this document, each of the inquiry and application lessons and labs in this document are broken into key parts based upon the **Self-Regulated Learning Cycle / Cycle of Action** proposed by Dr. André Bresges of the University of Cologne, Germany.

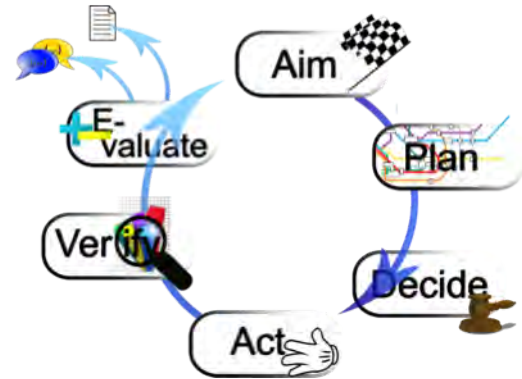

1. Aim:

In this phase all participants of the action should get a vision of what they want to reach. Criteria for a successful fulfillment of the task should be formulated to clarify the end goal.



2. Plan:

In this phase all necessary information is collected that helps to reach the →**aim**, including the search for already existing solutions. While structuring the gathered information, ideas for different solution paths should be gathered.



3. Decide:

Now a consensus should be reached among all participants of the action. One of the solution paths developed and gathered in →**planning** must be chosen. (Alternative solution paths may be kept in mind if a new decision may become necessary.) Important: Latest in this phase, quantitative/measurable criteria should be noted for measuring the success of the cycle of action (CoA).



4. Act:

All conscious actions should be performed according to the →**decision**. (If unplanned problems occur, another CoA can be started, but not before finishing and documenting the ongoing CoA).



5. Verify:

The Verification is performed with the criteria created during phase 1 and 3. (→**aim** and →**decision**). Important: A clear separation of →**verification** and →**evaluation** helps to promote scientific thinking. Otherwise, students often have great difficulties distinguishing between results and conclusions in their lab reports.



6. Evaluate:

The participants of the action estimate how successful the cycle of action was and may look for improvements for another CoA. This is the highlight of the learning process. With the results from the first CoA the →**aim** for further CoAs can be formulated much better.

For more information about the Self-Regulated Learning Cycle, please see:

<http://www.physikdidaktik.uni-koeln.de/11287.html?&L=1>

Aeronautical Dictionary

The following are a number of terms that, without explicit definition, tend to prove problematic to students. These terms are not necessarily meant to be learned by students at the outset, but this dictionary should serve as a reference point as their use becomes necessary. The following definitions have been drawn and modified from the *NASA Aeronautical Dictionary*, by Frank Davis Adams, (1959).

Aeronautics, *noun*: The science and art of design, construction, and operation of aircraft.

Angle of Attack, *noun*: (1) The angle between the direction of the flow and the airfoil's chord line (from the leading edge of the air foil to the tailing edge). (2) A zero degree angle of attack is defined as the angle at which a body generates zero lift in a flow. The angle of attack is the angle between the zero lift axis and the direction of the air flow.

Drag, *noun*: (1) A retarding force acting upon a body in opposite direction to the motion of the body. (2) A force acting upon a body in direction of a flowing fluid (gas or liquid).

*Although overall drag occurs opposite the direction of the total motion of the aircraft, the actual direction for a given surface will depend upon the movement of the various surfaces of the aircraft.

Lift, *noun*: The component of the total aerodynamic force acting on a body perpendicular to the direction of the undisturbed airflow relative to the body. This lift, sometimes called "aerodynamic lift," acts on any body or system of bodies such as an airfoil, a fuselage, an airplane, an airship, a rotor, etc., at a suitable angle of attack in the airflow.

*Lift is usually thought of as a force acting in an upward direction, giving sustentation to the aircraft. By definition, however, lift can, and does, act in any direction: downward, as with a horizontal tail when required for longitudinal trim; sideward, as with a vertical tail when an aircraft is turned. When lift in a direction other than upwards is under discussion, it may be specified in the expressions "negative (downward) lift," or "horizontal lift," although the latter expression is usually avoided.

This phenomenon of aerodynamic lift is typically explained by either or both of two laws or theorems: (1) By Newton's third law of motion, in which a body, causing air to flow in one direction, obtains a force upon itself acting in the other direction. (2) By Bernoulli's law, in which an increase of air velocity over the body gives a pressure decrease resulting in lift. *However, using Bernoulli's law as the sole explanation for lift is not fully true for an open system, and can lead to misconceptions. Lift can also be a result of buoyant force, although this is generally negligible for heavier-than-air aircraft.*

Thrust, *noun*: The forward-directed pushing or pulling force developed by an aircraft engine or a rocket engine.

*Although thrust generally pushes an aircraft forward, a more accurate definition is to say that it acts parallel to the direction of the engine. Some aircraft, such as vertical-lift aircraft, can apply a thrust in an upward direction. Other airplanes with variable-angle engines might apply thrust in such a way that only a component actually causes the airplane to move forward.

Weight, *noun*: The gravitational force acting on an object by the earth. An object with weight experiences a force that is directed downward toward the center of mass of the earth.

*In all cases with respect to weight, "downward" is in reference to the center of the earth.



Scientific Thinking



A joint project of
NASA Aeronautics
and the
American Association of
Physics Teachers





Objectives

Determine the relationship between the surface area and weight of scaled gliders.

Materials

Paper of various thicknesses
Scissors
Electronic balance (optional)

NGSS

SEP 2, 4, 7
CCC 1, 3

Inquiry Lesson/Lab: Scaling and Paper Airplanes

Robert H. Johns. *The Physics Teacher*, 9, 541 (1971).

Paper airplanes are a classic children's toy, easy to make, and easy to use for inquiry investigations. In this activity, students construct paper airplanes. Technically, paper airplanes are actually "gliders," as they do not provide themselves any thrust throughout their flight. Students are asked to compare the wing's top **surface area** with the **weight** of scaled gliders of various sizes.

This lesson can be an opportunity for students to perform a controlled experiment, and to begin learning about related variables that might influence flight, such as drag and shape. The end purpose of this activity is much less to derive a specific equation, but, rather, to learn to identify and describe meaningful relationships between variables. This activity also provides a broad overview for many foundational concepts associated with flight.

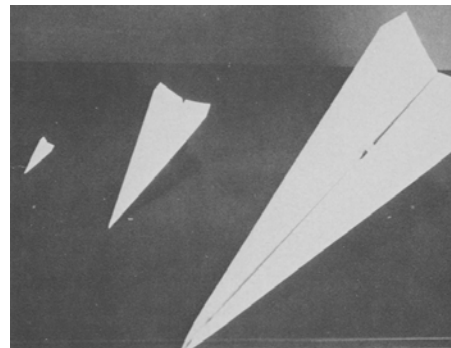

Objective: Determine the graphical and mathematical relationship between the *surface area* and the *weight* of scaled gliders ("paper airplanes").

Ask students to build a number of scaled, but otherwise identical, gliders. Using some simple geometry, students can determine the approximate surface area of the wings, and plot this against the measured or calculated weight of the gliders. (Hint: Most packaged paper lists the mass in g/m^2 . Students can determine weight from proportional reasoning and known starting surface areas of their papers before folding the airplanes). The graph to the right displays an example best-fit line representative of the data produced from this lab.

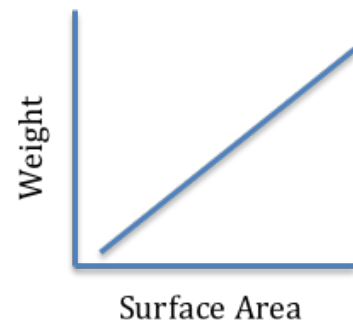

- *Encourage students to design an airplane for which the surface area of the wings can be easily estimated. Wings composed of right triangles and rectangles are best.*
- *Ensure that the students are only measuring the surface area for the “top” of the wings.*
- *Ensure that the airplane design actually results in flight that produces “lift.” It should be a good glider.*
- *Ensure that students use papers with the same starting ratios. A way to simplify this is to ask students to always begin with square – not rectangular – pieces of paper.*
- *Students should find that this relationship between weight and surface area is approximately linear. However, it is possible that the smaller airplanes do not quite fit on the straight line, as their relative size in comparison to the paper used to actually make the folds results in a smaller surface area.*

Comparing the gliding ability of gliders can be difficult to do in a consistent way, because students vary the amount of force with which they push the glider, and the release angle and height can change dramatically from throw to throw.



To launch gliders consistently, build a launcher from a piece of scrap wood, two nails, and a rubber band. A paperclip can be easily attached to any plan as a “hook,” and the glider can be launched consistently by pulling back to the same stretch point each time. Force can be varied by changing the type of rubber band or pulling back more or less before launch. Alternatively, commercial paper airplane launchers can be purchased from multiple science education companies.



Lastly, consider the implications that weight and surface area of gliders might have for the anatomy of birds and the design of airplanes. The next activity allows students to investigate these relationships in much more detail.



Teacher Answer Key: Scaling and Paper Airplanes



Aim

Objective: Determine the graphical and mathematical relationship between the *weight* and the *surface area* of scaled gliders (“paper airplanes”).

Early engineers found that building vehicles for powered flight was a difficult task. Before building propelled airplanes, they first attempted to make gliders that would remain in the air for a while after being launched. Leonardo da Vinci is well known for his visualizations of an “ornithopter.” Perhaps less well known, the Englishman George Cayley developed a variety of successful gliders in the 1800s, followed by the German Otto Lilienthal.

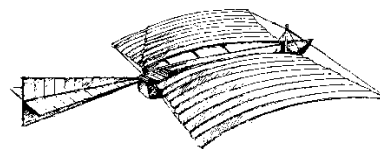

One of the great challenges of the times was to develop a glider that had a very small weight-to-surface area ratio. In fact, some of the best gliders actually have the same weight-to-surface area ratios as the best gliding birds. (Hence, the Wright brothers’ experience with lightweight materials for bicycle design naturally gave them some advantage in their design for gliders and early airplanes.)



Plan

In this lab activity, you will determine the relationship between weight and surface area of the wings of a glider. Plan how you will collect the data, and what kinds of materials you will use that are available to you. Begin by folding a piece of paper into a successful glider.



Decide

Once you have found a glider that glides well, decide what data you need to collect. Before you fold your gliders, ensure that the pieces of paper you use have proportional dimensions:

Dimension Ratios	Glider #1	Glider #2	Glider #3	Glider #4	Glider #5	Glider #6
Length						
Width						

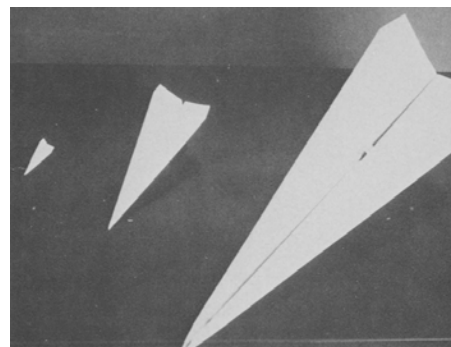



Estimate the surface area of the wings by identifying the simple geometric shapes that make up the wings. Draw a top-view of your paper airplane, identifying the shapes. Describe – in words – how you calculate the total surface area of the tops of the wings each time.

Description of calculation area:

Drawing:



Collect data for total weight and surface area for each of your gliders. Record your data on your own.

Plot your data on a graph, as shown to the lower right, and answer the following questions:

1. What is the general equation that describes this graph?

The standard equation for a linear graph is $y = mx + b$. Substituting the variable names, and slope and intercept (with units), this results in a general equation of “Weight = (____ N/m²) Surface Area + ____ N.”

2. What are the meanings of the slope(s) and intercepts on this graph?

The slope is the ratio of force per unit area. For every increase of unit area, the weight increases by a certain amount.

The intercept should be zero, because a glider with no surface area has no weight! If there is a non-zero value, this is likely the result of error (lack of precision or accuracy in measurements), or is because the relationship is not entirely linear.

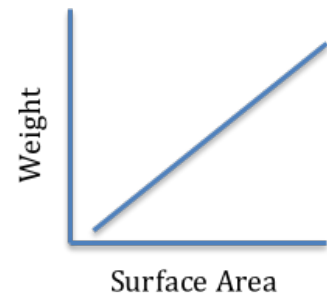

3. Conduct multiple experiments to compare the surface area/weight ratios for various materials

More dense materials should have a greater slope value. The y-intercept should still be zero.

4. Conduct multiple experiments to compare the surface area/weight ratios for various glider styles.

If the same material is used, the slopes should be greater for glider styles that have smaller wings.

5. Compare the surface area/weight ratio to qualitative gliding ability (i.e. the speed required for the glider to maintain lift, and/or how far the gliders go when launched in a consistent way).

Generally, gliders with small wings will have to have a higher speed in order to launch and glide properly.



Look at your group’s data – how reliable is it? Share the data you collected with your classmates. Do your results compare in a similar way to your classmates? If not, why not?

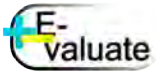

Develop a visual, verbal, or physical model to explain why you think that surface area affects the gliding ability of a glider.

Considering only Newton's laws, a greater surface area results in more collisions with air particles and a greater deflection of both air particles that hit the wings of the glider, as well as the nearby air particles that also get pushed downward by other particles surrounding them. As the air particles hit the wing, they reflect off the wing. The air particles, that initially had a horizontal momentum, are now pushed forward (with respect to the direction of the glider) and downward. As a result, the airplane is pushed backward (drag), but also provided with an upward push (lift). More collisions from a greater surface area result in more total force applied to the wings (and a greater change in momentum on the airplane). However, greater wing surface area typically results in greater mass of the glider overall, which means that the glider is actually less likely to accelerate. Overall, this relationship can be very difficult for students to observe. The key is to help students to think about air particles and collisions.

Hypothesize why some gliders fly better than others.

Many factors come into play here: center of gravity (which impacts the angle of attack), glide speed (the speed of the air over/under the wings in order for the glider to glide most efficiently), mass, angle of wings (with respect to the horizontal plane of the wings from side-to-side), etc.

Student Worksheet: Scaling and Paper Airplanes

Aim



Objective: Determine the graphical and mathematical relationship between the weight and the surface area of scaled gliders (“paper airplanes”).

Early engineers found that building vehicles for powered flight was a difficult task. Before building propelled airplanes, they first attempted to make gliders that would remain in the air for a while after being launched. Leonardo da Vinci is well known for his visualizations of an “ornithopter.” Perhaps less well known, the Englishman George Cayley developed a variety of successful gliders in the 1800s, followed by the German Otto Lillenthal.

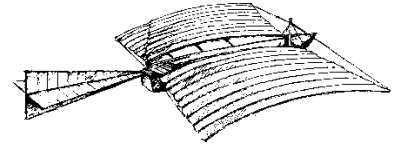

One of the great challenges of the times was to develop a glider that had a very small weight-to-surface area ratio. In fact, some of the best gliders actually have the same weight-to-surface area ratios as the best gliding birds. (Hence, the Wright brothers’ experience with lightweight materials for bicycle design naturally gave them some advantage in their design for gliders and early airplanes.)



Plan



In this lab activity, you will determine the relationship between weight and surface area of the wings of a glider. Plan how you will collect the data, and what kinds of materials you will use that are available to you. Begin by folding a piece of paper into a successful glider.

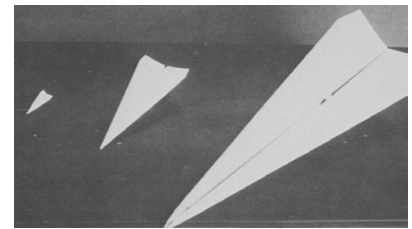

Decide



Once you have found a glider that glides well, decide what data you need to collect. Before you fold your gliders, ensure that the pieces of paper you use have proportional dimensions:

Dimension Ratios	Glider #1	Glider #2	Glider #3	Glider #4	Glider #5	Glider #6
Length						
Width						

Act



Estimate the surface area of the wings by identifying the simple geometric shapes that make up the wings.

Draw a top-view of your paper airplane, identifying the shapes. Describe – in words – how you calculate the total surface area of the tops of the wings each time.

Description of calculation of area:

Drawing:

Collect data for total weight and surface area for each of your gliders. Record your data on your own.

Plot your data on a graph, as shown to the lower right, and answer the following questions:

1. What is the general equation that describes this graph?

2. What are the meanings of the slope(s) and intercepts on this graph?

3. Conduct multiple experiments to compare the surface area/weight ratios for various materials. How do the graphs of the data compare?

4. Conduct multiple experiments to compare the surface area/weight ratios for various glider styles. How do the graphs of the data compare?

5. Compare the surface area/weight ratio to qualitative gliding ability (i.e. the speed required for the glider to maintain lift, and/or how far the gliders go when launched in a consistent way).

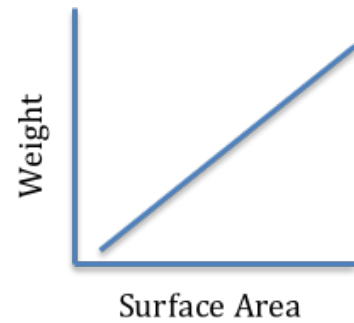

6. Look at your group's data – how reliable is it? Share the data you collected with your classmates. Do your results compare in a similar way to your classmates? If not, why not?



7. Develop a visual, verbal, or physical model to explain why you think that surface area affects the gliding ability of a glider.

8. Hypothesize why some gliders fly better than others.



Objectives

Compare and relate variables that influence the flight of birds and planes.

Materials

The Simple Science of Flight,
Ch. 1

NGSS

CCC 1, 2, 3, 6

CCSS

Reading in Science
Writing in Science

Literary/Data Analysis: Wings According to Size

Henk Tennekes. *The Simple Science of Flight*.

The MIT Press: Cambridge, Massachusetts. Ch. 1 Free Sample:

http://mitpress.mit.edu/sites/default/files/titles/content/9780262513135_sch_0001.pdf

The relationship between paper gliders, birds, and airplanes is surprisingly similar. Yet, when air speed around the wings necessary to sustain level flight is considered, these relationships can become quite complex. A quantitative analysis of bird anatomy and their comparison to airplanes can be found by reading Henk Tennekes' *The Simple Science of Flight*. Chapter 1, used for this activity, is available as a free sample from MIT Press at:

http://mitpress.mit.edu/sites/default/files/titles/content/9780262513135_sch_0001.pdf.

This activity allows students to investigate data tables and graphs that display non-linear relationships and their corresponding equations. The purpose of this activity is primarily to introduce students to variables that influence lift, and to recognize that airplanes follow many of the same rules of proportion as do birds.

* Cover image and graphics from *The Simple Science of Flight* are reproduced here with permissions from The MIT Press.



Teacher Answer Key: Wings According to Size

Read *The Simple Science of Flight*, chapter 1: *Wings According to Size*. (A free copy of this chapter can be viewed and downloaded from <http://goo.gl/7dIYB0>). As you read through the passage, focus on the relationships of variables that influence flight.

- Based on the first two pages of the chapter, how is “carrying capacity” of an airplane (or any other object) calculated?

Carrying capacity = weight / surface area that carries the weight

- Performance can also be measured by fuel consumption. What variables do you think influence fuel consumption of any moving object?

Weight of the aircraft / animal, metabolism / fuel efficiency, presence of drag (resulting from the aerodynamics as well as the weather conditions), etc.

Lift, Weight, and Speed

- The author identifies four factors that influence the lift of an airplane or flying bird. Complete the chart below. (Note: You will need to choose a symbol for the angle of wings.)

Factor	Symbol	Unit	Rationale (Why does it influence lift?)
Wing size	S	m^2	More surface area increases carrying capacity, more change in momentum
Air speed	V	m/s	More wind results in more collisions with air particles more often.
Air density	D	kg/m^3	Air particles can transfer a greater amount of momentum to the flying object.
Angle of wings	α (inferred)	Degree	With more tilt of the wings, the air particles are influenced more greatly.

- How must lift (L) compare to weight (W) in order for an object to cruise at a constant altitude? Why?

They must be equal, otherwise the object will accelerate upward or downward if there is a net (uneven) force. This is a result of Newton's second law of motion.

Table 1 Weight, wing area, wing loading, and airspeeds for various seabirds, with W given in newtons (10 newtons = 1 kilogram, roughly), S in square meters, and V in meters per second and miles per hour. The values of W and S are based on measurements; those for V were calculated from equation 2. In general, larger birds have to fly faster.

	W	S	W/S	V	
				m/sec	mph
Common tern	1.15	0.050	23	7.8	18
Dove prion	1.70	0.046	37	9.9	22
Black-headed gull	2.30	0.075	31	9.0	20
Black skimmer	3.00	0.089	34	9.4	21
Common gull	3.67	0.115	32	9.2	21
Kittiwake	3.90	0.101	39	10.1	23
Royal tern	4.70	0.108	44	10.7	24
Fulmar	8.20	0.124	66	13.2	30
Herring gull	9.40	0.181	52	11.7	26
Great skua	13.5	0.214	63	12.9	29
Great black-billed gull	19.2	0.272	71	13.6	31
Sooty albatross	28.0	0.340	82	14.7	33
Black-browed albatross	38.0	0.360	106	16.7	38
Wandering albatross	87.0	0.620	140	19.2	43

Wing Loading

Look at Table 1, reproduced here to the right, to answer the following questions:

- What is the specific trend between a bird's weight and the speed it needs to be able to cruise? (Is this a direct, linear relationship?) Explain.

In general, larger birds have to fly faster. However, the relationship does not appear to be linear. A doubling in weight typically only requires a small increase in velocity.

6. This table shows data for various seabirds. How would you expect the data in each column to change if this table showed, instead, non-migrating backyard songbirds? Why?

Non-migrating backyard songbirds do not need to soar like sea birds. As a result, it is reasonable to expect that non-migrating backyard songbirds are not as efficient as their sea bird counterparts, and likely have to sustain much higher velocities per unit weight in order to “soar” simply because they do not have to do it that often.

7. How would the data from your lab experience with the paper planes compare?

It is unlikely to be very similar. Paper gliders tend to demonstrate a very linear relationship between W and S , while birds do not. Hence, the required velocities for gliding are also likely to also be different.

Look at Figure 1, reproduced on the next page, to answer the following questions:

8. Describe the relationship between weight and wing loading for these seabirds. (Careful – this is not a standard linear graph!) If necessary, re-plot the data on a linearly-scaled graph. Why do you think this trend is present?

When the weight increases by 100 times, the W/S (carrying capacity) only increases by five times. This difference might have something to do with the fact that the increase in weight is not in muscle mass only, but also includes bones and fat, which do not contribute to the ability to carry.

9. What is the general meaning of equation (3)? Compare equations (1), (2) and (3) below.

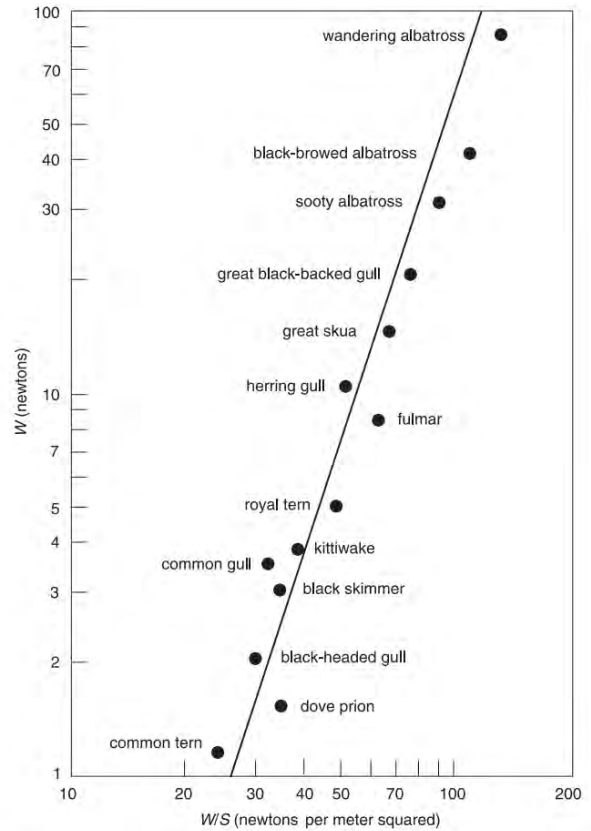

Figure 1 The relation between weight and wing loading represented in a proportional diagram. When the weight increases by a factor of 100, the value of W/S increases by a factor of 5 and the airspeed by a factor of more than 2.

Equation	What does it mean?	How is it different from the others?
$W = 0.3dV^2S$	Weight is lifted by a flying object is dependent upon angle of attack, density, air speed, and surface area.	Raw equation. 0.3 comes from average angle of attack of 6 degrees.
$W/S = 0.38V^2$	Carrying capacity is dependent upon a constant and air speed.	d has been substituted with value at sea level.
$W/S = c W^{0.33}$	Wing loading is proportional to the cube root of weight.	Quantifies Figure 1.

Great Flight Diagram

Look at Figure 2, reproduced to the right, to answer the following questions:

10. What is the meaning of the vertical line on the graph? What can you infer about birds/planes to the left or to the right of the vertical line?

The line represents 22 miles per hour (mi/hr) winds. Birds to the left of the line are slow flyers, and might not be able to overcome strong winds if they go out over the ocean.

11. Where is Equation (3) visibly represented on the graph?

The vertical and top horizontal axis represent the variables found in equation 3.

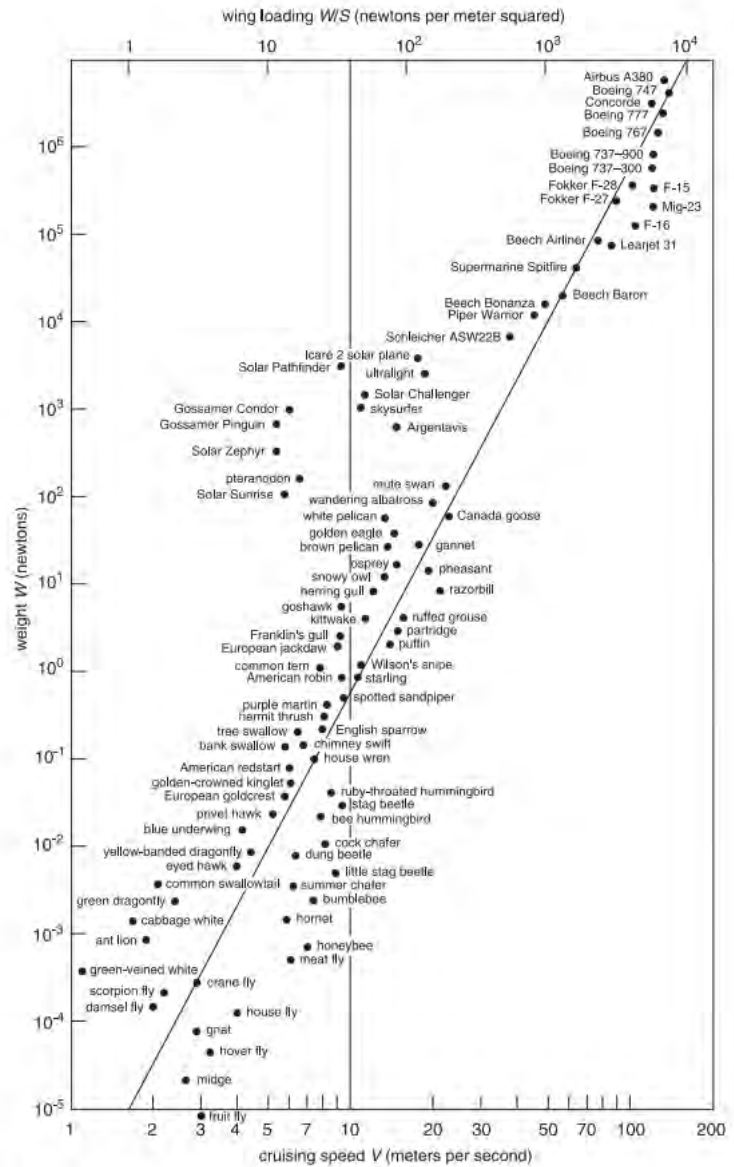

Figure 2 The Great Flight Diagram. The scale for cruising speed (horizontal axis) is based on equation 2. The vertical line represents 10 meters per second (22 miles per hour).

12. Given what you know about the vertical line and the angled line on the graph, compare the following flying objects' capabilities. How are they different?

Boeing 747	<i>Highest weight, wing loading, and cruising speed.</i>
Pteradon	<i>Heavy, slow flyer.</i>
Human-powered Airplane	<i>Heavier than pteradon, but nearly same wing loading and cruising speed.</i>

13. Likewise, compare a crane fly, spotted sandpiper, and Beech King airplane. How are they different? (Compare weight, wing loading, and cruising speed). How are they similar?

All three of these fall on the same trend line. A crane fly is small and slow, a spotted sandpiper is heavier and faster, and a Beech King airplane is even heavier and faster than the sandpiper.

14. Based upon the graph and the information presented in the text, explain one of the reasons why the Concorde is now out of commission.

*Unlike all of the aircraft in the "group," the Concorde fell slightly to the left of the trend line. This means, that for its group, it tended to be a little bit heavier for its ideal cruising speed, and had a slightly lower wing loading value, than the rest of its counterparts. Most importantly, the Concorde **did not fly at its ideal cruising speed**. As the fastest commercial jet then in service in the world, it flew much faster than the ideal speed listed on the diagram. Its ideal speed was much lower because the Concorde's wings had to be big enough for it to take off and land at lower speeds. As a result, the Concorde had to "drag along" the larger wings during its high-speed flight.*

Use Figure 3 (below to the right) and Figure 4 to answer the following questions.

15. What do birds do to modify their wings for various stages of flight? (Takeoff, cruising, landing). Why is this so important?

As birds take off, their wings are fully expanded. A larger surface area is needed in order to attain lift at a slow speed. As birds go faster and faster as they cruise, they can decrease the surface area of their wings. This is important in order to reduce drag and increase efficiency.

16. Standard passenger airplanes DO modify their wings during takeoff and landing. Watch the following video of an airplane wing release its extender flaps here: <http://goo.gl/pd1bDM>

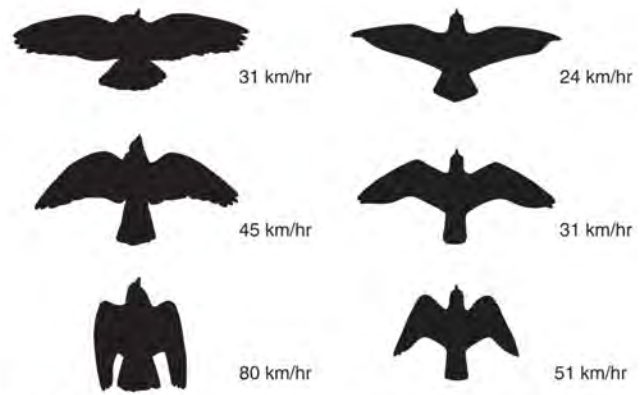

3 Birds progressively fold their wings as their speed increases. On the left is a pigeon, on the right a falcon. At high speeds, fully spread wings generate unnecessary drag. This can be avoided by reducing the wing area.



Student Worksheet: Wings According to Size

Read *The Simple Science of Flight*, chapter 1: *Wings According to Size*. As you read through the passage, focus on the relationships of variables that influence flight.

- Based on the first two pages of the chapter, how is “carrying capacity” of an airplane (or any other object) calculated?
- Performance can also be measured by fuel consumption. What variables do you think influence fuel consumption of any moving object?

Lift, Weight, and Speed

- The author identifies four factors that influence the lift of an airplane or flying bird. Complete the chart below. (Note: You will need to choose a symbol for the angle of wings.)

Factor	Symbol	Unit	MY Rationale Why does it influence lift?	OTHER's Rationale Interview Your Partner

- How must lift (L) compare to weight (W) in order for an object to cruise at a constant altitude? Why?

Wing Loading

Look at Table 1, reproduced here to the right, to answer the following questions:

- What is the general trend between a bird's weight and the speed it needs to be able to cruise?
- This table shows data for various seabirds. How would you expect the data in each column to change if this table showed, instead, non-migrating backyard songbirds? Why?
- How would the data from your lab experience with the paper planes compare?

Table 1 Weight, wing area, wing loading, and airspeeds for various seabirds, with W given in newtons (10 newtons = 1 kilogram, roughly), S in square meters, and V in meters per second and miles per hour. The values of W and S are based on measurements; those for V were calculated from equation 2. In general, larger birds have to fly faster.

	W	S	W/S	V	
				m/sec	mph
Common tern	1.15	0.050	23	7.8	18
Dove prion	1.70	0.046	37	9.9	22
Black-headed gull	2.30	0.075	31	9.0	20
Black skimmer	3.00	0.089	34	9.4	21
Common gull	3.67	0.115	32	9.2	21
Kittiwake	3.90	0.101	39	10.1	23
Royal tern	4.70	0.108	44	10.7	24
Fulmar	8.20	0.124	66	13.2	30
Herring gull	9.40	0.181	52	11.7	26
Great skua	13.5	0.214	63	12.9	29
Great black-billed gull	19.2	0.272	71	13.6	31
Sooty albatross	28.0	0.340	82	14.7	33
Black-browed albatross	38.0	0.360	106	16.7	38
Wandering albatross	87.0	0.620	140	19.2	43

Look at Figure 1 to answer the following questions:

8. Describe the relationship between weight and wing loading for these seabirds. (Careful – this is not a standard linear graph!) If necessary, re-plot the data on a linearly-scaled graph. Why do you think this trend is present?

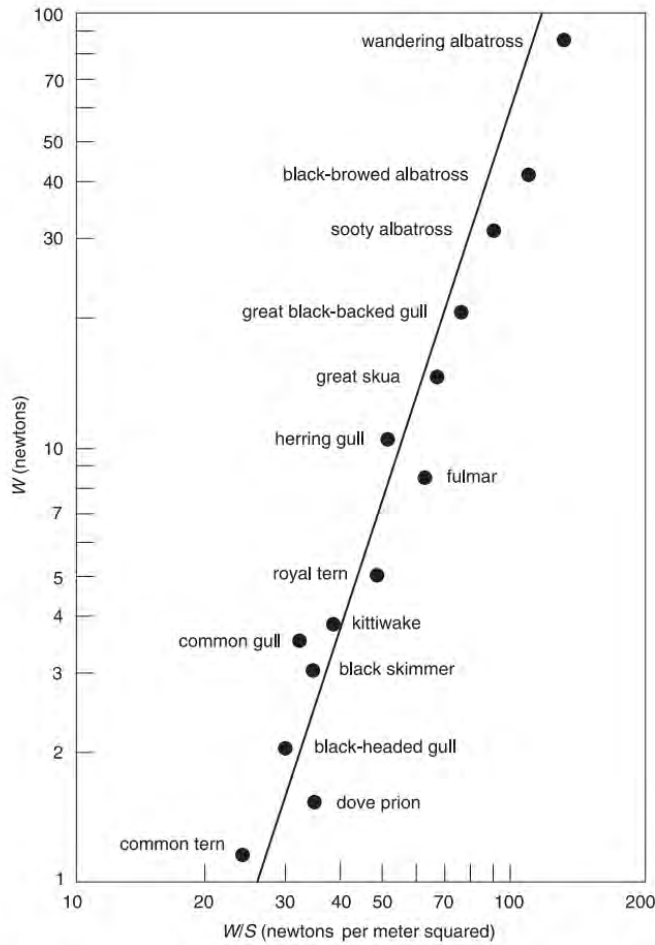

Figure 1 The relation between weight and wing loading represented in a proportional diagram. When the weight increases by a factor of 100, the value of W/S increases by a factor of 5 and the airspeed by a factor of more than 2.

9. What is the general meaning of equation (3)? Compare equations (1), (2) and (3) below.

Equation	What does it mean?	How is it different from the others?

Great Flight Diagram

This *Great Flight Diagram* displays the OPTIMAL cruising speeds for a variety of flying things. Look at Figure 2, reproduced to the right, to answer the following questions:

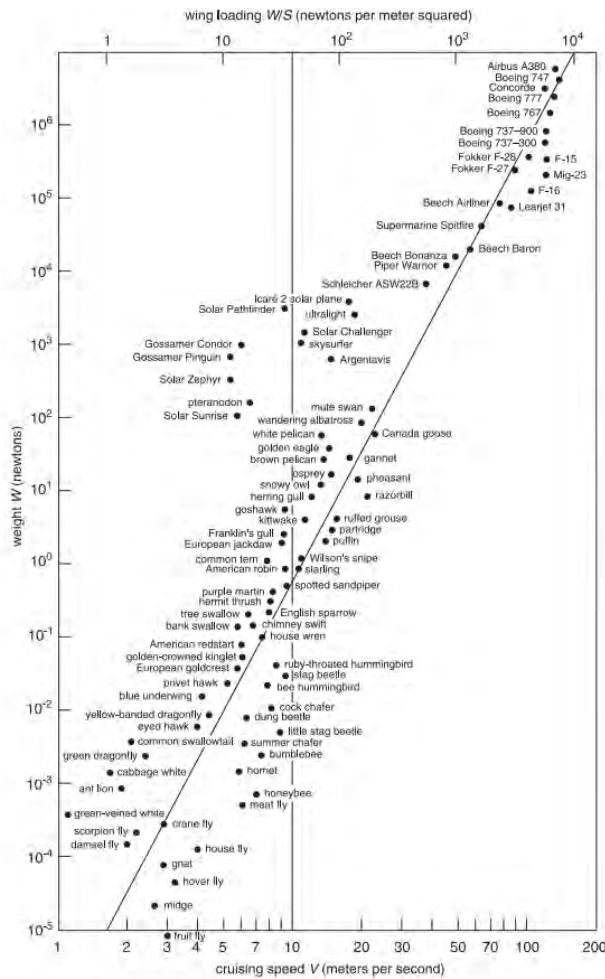

Figure 2 The Great Flight Diagram. The scale for cruising speed (horizontal axis) is based on equation 2. The vertical line represents 10 meters per second (22 miles per hour).

10. What is the meaning of the vertical line on the graph? What can you infer about birds/planes to the left or to the right of the vertical line?
11. Where is Equation (3) visibly represented on the graph?
12. Given what you know about the vertical line and the angled line on the graph, compare the following flying objects' capabilities. How are they different?

Boeing 747	
Pteradon	
Human-powered Airplane	

13. Likewise, compare a crane fly, spotted sandpiper, and Beech King airplane. How are they different? (Compare weight, wing loading, and cruising speed). How are they similar?
14. Based upon the graph and the information presented in the text, explain one of the reasons why the Concorde is now out of commission.

Use Figure 3 (below to the right) and Figure 4 to answer the following questions.

15. What do birds do to modify their wings for various stages of flight? (Takeoff, cruising, landing). Why is this so important?

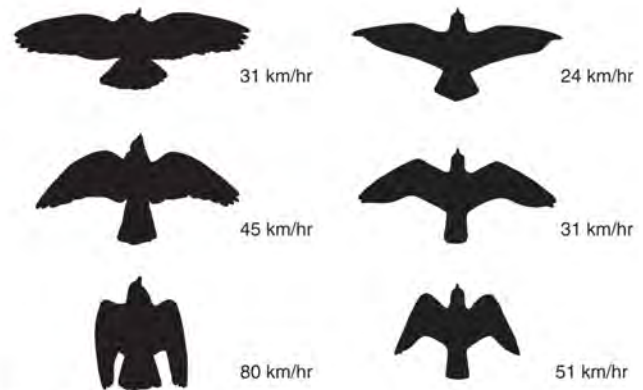

3 Birds progressively fold their wings as their speed increases. On the left is a pigeon, on the right a falcon. At high speeds, fully spread wings generate unnecessary drag. This can be avoided by reducing the wing area.

16. Standard passenger airplanes DO modify their wings during takeoff and landing. Watch the following video of an airplane wing release its extender flaps here: <http://goo.gl/pd1bDM>





Successful Flight Test of Shape-Changing Wing Surface

<http://www.nasa.gov/content/successful-flight-test-of-shape-changing-wing-surface/#.VHOino29-Rh>

Analysis Questions

Explain two ways that shape-changing surfaces are different from typical airplane wings.

Explain two potential benefits of shape-changing surfaces over typical airplane wings.

Click on the “More” link immediately below the text to see an image of the “corrugated” trailing edge of a wing. Why do you think this is beneficial? (Hint: Perform an Internet search to find out how owls can fly so silently).

What do you think potential designs of the future might look like? Consider what you know about birds as you consider possible designs.



Constant Velocity



A joint project of
NASA Aeronautics
and the
American Association of
Physics Teachers





Objectives

Estimate the average speed of an airplane as it travels between two points.

Materials

Internet access
Timer
Planefinder.net
Google.com/maps

NGSS

CDI HS-PS2
SEP 2,7
CCC 1

Real-World Applications: Flying Speed

In this activity, students use an equation that they can previously derive through inquiry ($Distance = Speed * Time$). They use a real-time plane finder to watch a plane as it travels from one recognizable point to another while at cruising speed (far away from its departure or arrival airport) in order to estimate its speed.

Direct students to go to the following website:
<http://planefinder.net/>

Ask students to browse the page and to note the greatest concentration of air flights around the world. Students may be provided a map, and asked to mark the countries and areas where there is the most flight activity.

Discuss potential reasons for air flight concentrations being where they are. Consider:

- Economics
- Population density
- Geography (deserts, mountain ranges, “remote” areas)
- Weather (locations of storm systems, hurricanes)
- Time of day (consider time zones)
- Cultural holidays

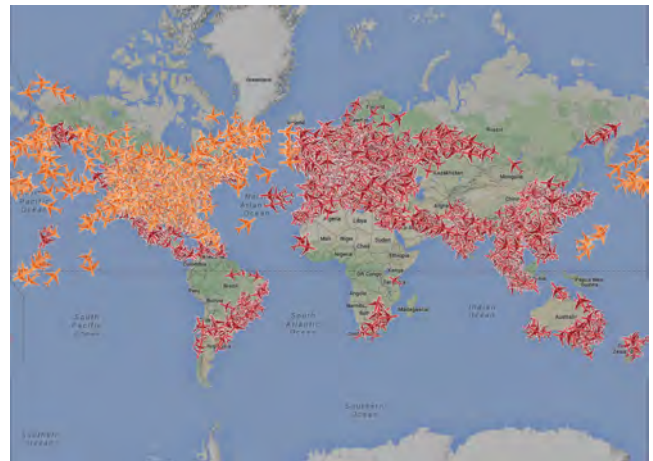

Ask students to zoom in to a particular area where there is a regular amount of air traffic. The goal at this point is to identify an aircraft that is moving from one notable location to another (such as a city, interstate intersection, lake, etc.), so that speed may be determined. (Note: If students zoom in very close to an aircraft and select **Settings** → **Plane**, they can get the airline, flight number, origin and destination airports, as well as the speed, in knots (KTS). However, most students will not recognize KTS. This value can be used to evaluate the calculated speed, but should not be used directly for this activity).

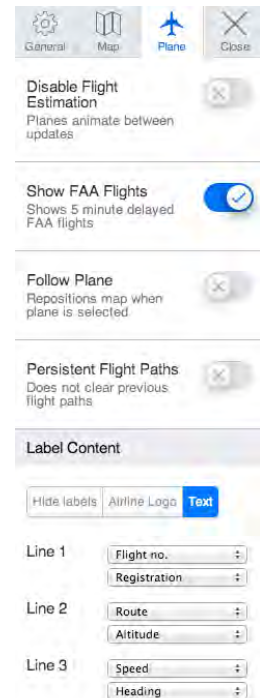
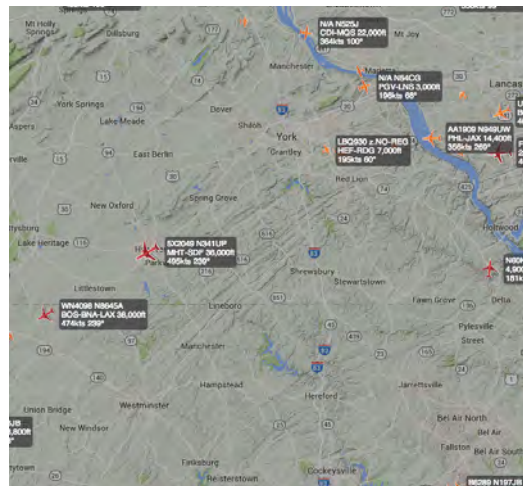

Choose one aircraft, and time it as it goes from one point of interest to the other. Students should choose a range of time somewhere between one and five minutes to ensure that enough time is collected for accurate calculations. (Caution: If the goal is for students to determine the cruising speed of aircraft, they should look at an aircraft once it is well along its flight path. Students should not choose planes travelling in significantly curved paths, or near airports, where speeds change. However, looking at speeds near takeoff and landing is a great extension activity).

Make sure that students choose recognizable points of interest, because students will next need to determine the distance crossed by re-locating and measuring the distance between the two points using Google Maps.

To measure the distance between the points, follow the example procedure below:

- Go to www.google.com/maps to get to Google Maps
- As an example, a student might have observed a plane go from Holtwood, Pa. to Whitehall, Md. in a period of 2.387 seconds.
- Students should find, on Google Maps, the initial point of the plane's timing.
- Right-click on the initial location to get a menu. Choose "Measure distance." The second point of interest can be clicked, and an estimate given for the distance between the two points. In this example, the distance is 22.58 miles.
- To make speeds more relevant, it is suggested that students convert time in seconds to hours. Using a simple conversion, student can find that 2.387 s is equivalent to 0.03978 hr.
- Using the equation $Distance = (Speed) Time$, and re-arranging for speed, students can get $Speed = Distance/Time$. In this example, $Speed = 22.58 \text{ mi} / 0.03978 \text{ hr}$, which is equal to 567.6 mi/hr. This is a very reasonable estimate! Most commercial airplanes cruise at about 550 mi/hr.

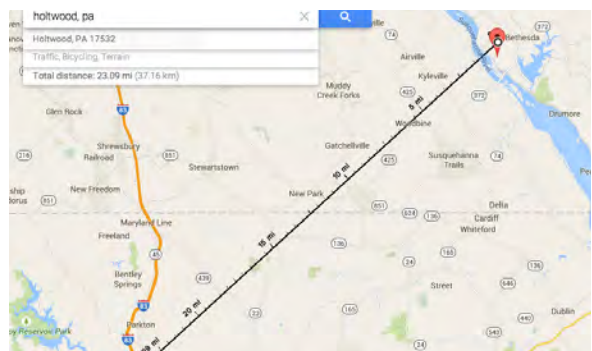
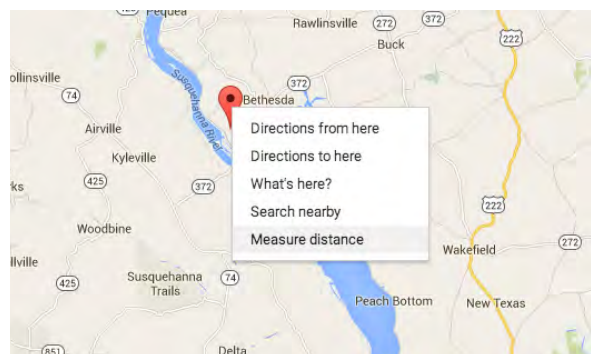
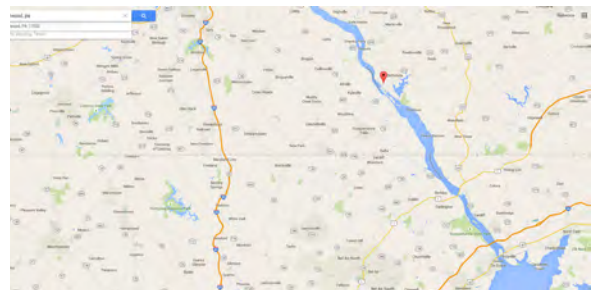

Take a broader look at the flight paths across the United States.

- Do you notice any patterns for eastward or westward flights?
- How do flight paths change upon entering or leaving airports?

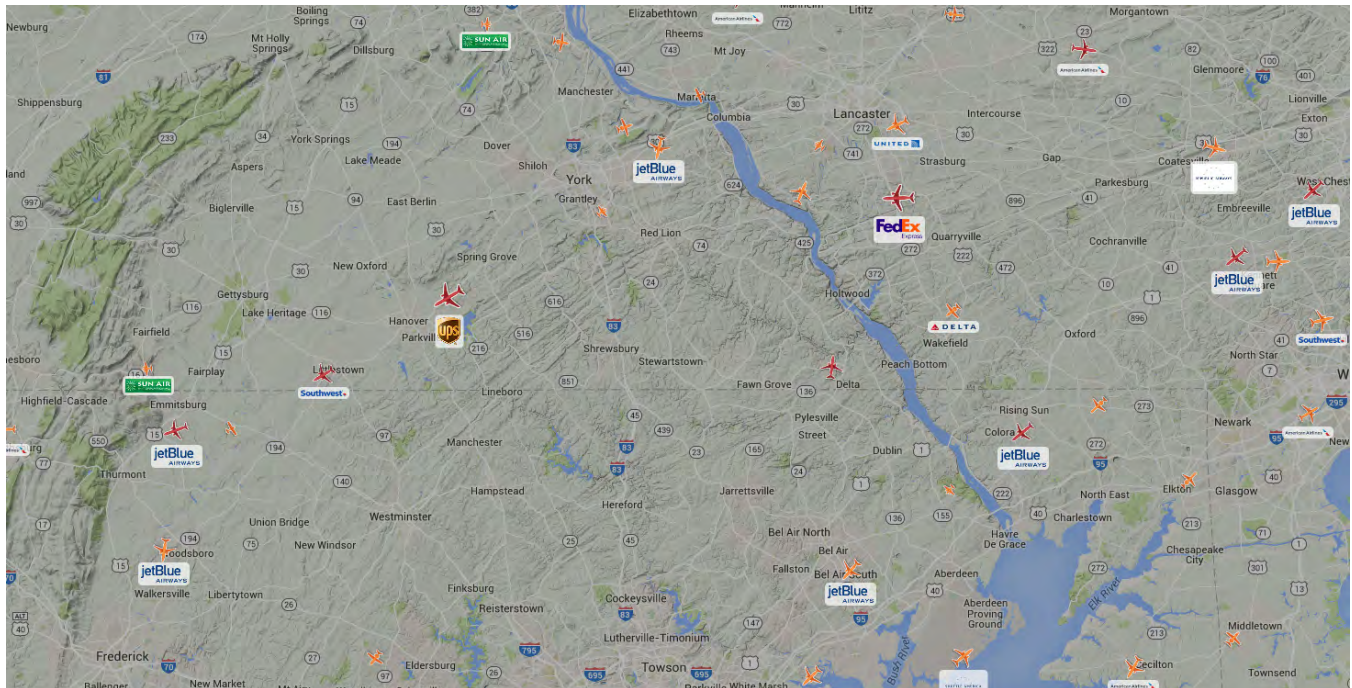



A Day in the Life of Air Traffic Control

With the massive increase in passenger and air cargo planes, the skies have become a very busy place. NASA Aeronautics works hard to solve the problem of air traffic congestion. Modeling air traffic over a span of time to determine problem points is integral to managing the network of highways in the sky. Help students to see how busy the airspace over the US really is by watching the video, “A Day in the Life of Air Traffic Control over the US.”

1. Have students to to: <http://www.aviationsystemsdivision.arc.nasa.gov/research/modeling/facet.shtml>
2. Ask students to read the article about NASA’s work with FACET to manage air traffic across the nation.
 - a. What is FACET?
 - b. How does it benefit the environment, economy, and education?
3. Ask students to play the linked video (click view Facet Animation) showing 24 hours of air traffic over the United States. <http://www.aeronautics.nasa.gov/videos/facet24.mov> and answer the following questions:
 - a. From which direction do most of the flights leave / arrive? (SE, NE, NW) Why don’t they go directly N, S, E, and W?
 - b. The simulation begins at 0 UTC (Coordinated Universal Time), which corresponds to 7 p.m. Eastern Standard Time. Describe in words, what happens to the density of flight traffic, on average during a 24 hour period?
 - c. Draw a simple graph showing the average flight density versus time.
 - d. What are the three or four busiest airports in the US?
4. What are two or three practical solutions to decreasing traffic congestion in the US?

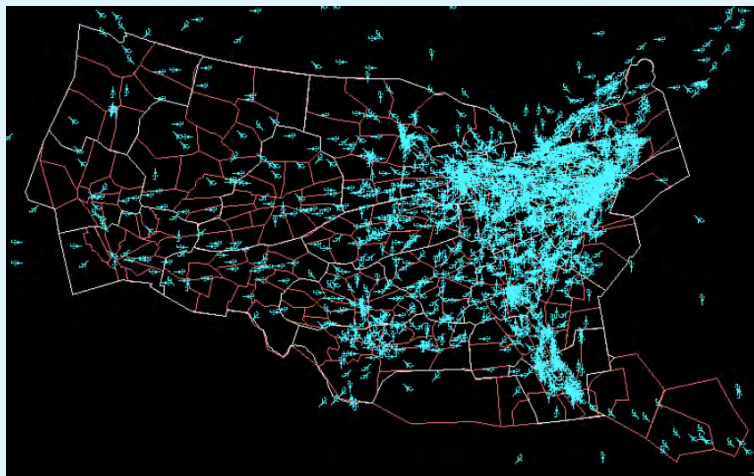

Student Worksheet: Flying Speed



Objective: Estimate the average speed of an airplane as it travels between two points.

There is a significant amount of aircraft in the skies every day of the year. Because these aircraft must be monitored to help pilots get to their destination efficiently, and to avoid in-air collisions, it is possible to track any commercial aircraft around the globe. There are many websites and apps available to help people track specific flights or to browse flights around the world. For this activity, go to <http://planefinder.net/>

1. Which parts of the world experience the least air traffic?
2. Choose one country or region surrounded by little air traffic, and explain why you think it does not have a busy airspace. (Consider the economics of these countries, population density, geography, weather, time of day, and the observance of any cultural holidays).
3. Which parts of the world experience the *most* air traffic?
4. Choose one country or region surrounded by lots of air traffic, and explain why you think it has a very busy airspace. (Consider the economics of these countries, population density, geography, weather, time of day, and the observance of any cultural holidays).
5. How do you anticipate that the airspace of the future will change? Do you think the skies will get busier or less busy? Why?



6. The goal of this activity is for you to determine the *average speed* of an aircraft during its cruise portion of its flight. Explain what information you will need to determine average speed.
7. Zoom in to a particular area where there is a regular amount of air traffic. The goal at this point is to identify an aircraft that is moving from one notable location to another (such as a city, interstate intersection, lake, etc.), so that speed may be determined. **Avoid starting or ending at an airport, as aircraft speed changes significantly at those points.**

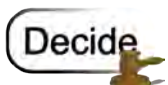
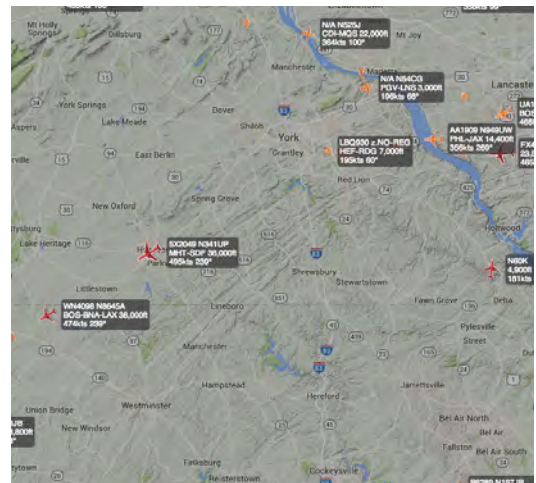

8. Choose one aircraft, and record the time it as it flies from one point of interest to the other in a straight line. Choose a range of time somewhere between one and five minutes to ensure that enough time is collected for accurate calculations. If your airplane significantly changes direction or follows an indiscernible path, consider choosing a different aircraft. Record the **time** here: _____



9. Measure the distance between the two points of interest by following the example procedure below:

- Go to www.google.com/maps to get to Google Maps
- On Google Maps, find the initial point of the plane's timing.
- Right-click on the initial location to get a menu. Choose "Measure distance." The second point of interest can be clicked, and an estimate given for the distance between the two points.

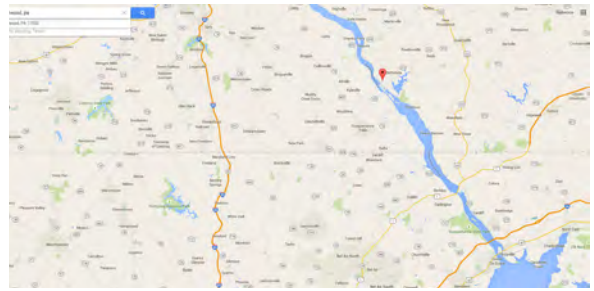

10. Show your work, and, if appropriate, explain how you can calculate the average velocity of the airplane.

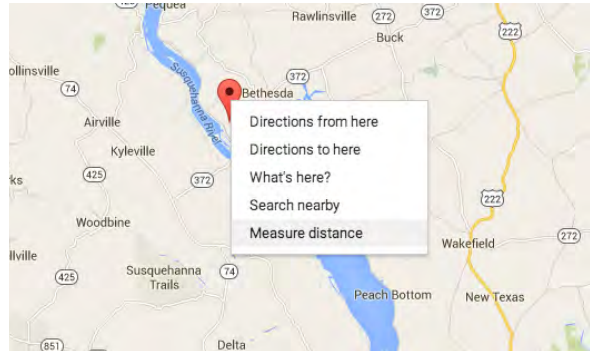

11. For a typical passenger jet, the airplane will cruise at around 500-550 miles per hour. How does your answer compare? You might need to convert your velocity units to make a fair comparison.

12. What aspects of this activity might lead to error in your measurements and calculations? Provide three specific examples, and explain if this would increase or decrease your calculated value.



13. Compare your results to that of your peers. Why might your peers have calculated different values?

14. Take a broader look at the flight paths across the United States.

- What patterns do you notice for eastward or westward flights?
- How do flight paths change upon entering or leaving airports? Why do you think this is the case?



Problem Set: Comparative Velocities

Background





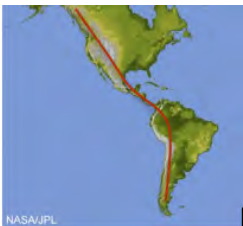

Airplanes were developed with a primary goal: to take their occupants across the skies at speeds never before imagined. For thousands of years, before the invention of the wheel, humans were limited by the speed of their legs. Using a mathematical model (equation) you developed in your regular class activities to represent the relationship between position and time for an object moving at a constant velocity, perform these very simple calculations to get a sense for how fast and far we can now easily travel because of aircraft.

Problem Set

- Determine *your* average walking speed. Explain how you accomplished this:
- Convert your speed in meters per second (m/s) to kilometers per hour (km/hr), then use that speed to solve the following problems. How much time would it take **you** to walk the following routes, assuming you never stopped along the way?

Land Routes	Distance to Walk	Time to Walk (Show work)	Time to Fly Non-Stop on Commercial Aircraft
Oregon Trail (MO to OR) 	3,219 km (2,000 miles) Immigration route used from 1830s to 1860s for settlers heading west for new land.		3 hours
Silk Road (Western China to Constantinople) 	6,437 km (4,000 miles) Cultural and commercial trade route used from 200 BCE to 1450s CE to connect culture and trade between the East and West.		8 hours
Early Land Migration (Northern Russia to Tierra del Fuego) 	17,703 km (11,000 miles) Possible route taken by early civilizations from the Asian continent, beginning about 30,000 years ago to their arrival at the southernmost tip of South America about 15,000 years ago.		19 hours

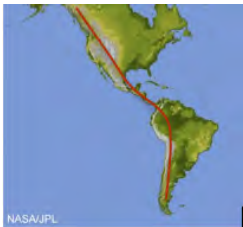
3. How long would it take each of the following **NASA planes** to travel the exact same routes above, assuming they were at their maximum speed for the entire duration of the flight?

Land Routes	Distance to Walk	NASA Aircraft Speed	Time to Flight (show work)
<p>Oregon Trail (MO to OR)</p> 	<p>3,219 km (2,000 miles)</p> <p>Immigration route used from 1830s to 1860s for settlers heading west for new land.</p>	<p>X-1: 1,127 km/hr</p> <p>Chuck Yeager was the first person to break the speed of sound in 1947 using rockets in conjunction with traditional jet engines.</p>	
<p>Silk Road (Western China to Constantinople)</p> 	<p>6,437 km (4,000 miles)</p> <p>Cultural and commercial trade route used from 200 BCE to 1450s CE to connect culture and trade between the East and West.</p>	<p>D-558: 2,124 km/hr</p> <p>Scott Crossfield was the first person to fly more than twice the speed of sound (Mach 2) in 1953.</p>	
<p>Early Land Migration (Northern Russia to Tierra del Fuego)</p> 	<p>17,703 km (11,000 miles)</p> <p>Possible route taken by early civilizations from the Asian continent, beginning about 30,000 years ago to their arrival at the southernmost tip of South America about 15,000 years ago.</p>	<p>X-15: 7,274 km/hr</p> <p>William J. "Pete" Knight broke the record for the fastest piloted airplane flight speed ever recorded, at 6.7 times the speed of sound (Mach 6.7) in 1967.</p>	

Problem Set: Vectors in Relative Velocities Problems

from [Beginner's Guide to Aeronautics](#)

BACKGROUND: (Note: This background is most appropriate *after* students have been introduced to these concepts through constructivist and/or inquiry activities.)

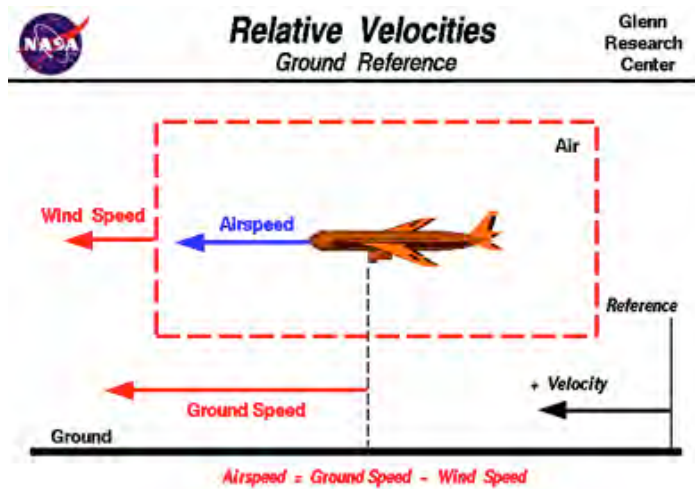

One of the most confusing concepts for young scientists is the **relative velocity** between objects. [Aerodynamic forces](#) are generated by an object moving through a fluid (liquid or gas). A fixed object in a static fluid does not generate aerodynamic forces. Hot air balloons “lift” because of buoyancy forces and some aircraft - like Harrier jets - use thrust to enable the vehicle to hover, but these are not examples of aerodynamic lift. To [generate lift](#), an object must move through the air, or air must move past the object. Aerodynamic lift depends on the square of the [velocity](#) between the object and the air. Now things get confusing because not only can the object be moved through the air, but the air itself can move. To properly define the relative velocity, it is necessary to pick a fixed reference point and measure velocities relative to the fixed point. In this slide, the

reference point is fixed to the ground, but it could just as easily be [fixed](#) to the aircraft itself. It is important to understand the relationships of wind speed to ground speed and airspeed.

Wind Speed

For a reference point picked on the ground, the **air moves** relative to the reference point at the **wind speed**. Notice that the wind speed is a [vector quantity](#) and has both a magnitude and a direction. Direction is important. A 20 mi/hr wind from the west is different from a 20 mi/hr wind from the east. The wind has [components](#) in all three primary directions (north-south, east-west, and up-down). In this figure, we are considering only velocities along the aircraft's flight path. A positive velocity is defined to be in the direction of the aircraft's motion. We are neglecting [cross winds](#), which occur perpendicular to the flight path but parallel to the ground, and [updrafts and downdrafts](#), which occur perpendicular to the ground.

Ground Speed

For a reference point picked on the ground, the **aircraft moves** relative to the reference point at the **ground speed**. Ground speed is also a [vector quantity](#) so a comparison of the ground speed to the wind speed must be done according to rules for [vector comparisons](#).

Airspeed

The important quantity in the generation of lift is the **relative velocity** between the object and the air, which is called the **airspeed**. Airspeed cannot be directly measured from a ground position, but must be computed from the ground speed and the wind speed. Airspeed is the [vector difference](#) between the ground speed and the wind speed.

$$\text{Airspeed} = \text{Ground Speed} - \text{Wind Speed}$$

On a perfectly still day, the airspeed is equal to the ground speed. But if the wind is blowing in the same direction that the aircraft is moving, the airspeed will be less than the ground speed.

Examples

Suppose we had an airplane that could take off on a windless day at 100 mi/hr (liftoff airspeed is 100 mi/hr). We are at an airport with an east-west runway that is one mile long. The wind is blowing 20 mi/hr towards the west and the airplane takes off going east. The wind is blowing towards the aircraft which we call a **headwind**. Since we have defined a positive velocity to be in the direction of the aircraft's motion, a headwind is a negative velocity. While the plane is sitting still on the runway, it has a ground speed of 0 and an airspeed of 20 mi/hr:

$$\text{Airspeed} = \text{Ground Speed (0)} - \text{Wind Speed (-20)} = 20 \text{ mi/hr}$$

The airplane starts its take off roll and has a constant acceleration **a**. From Newton's second law of [motion](#), the ground speed **v** at any time **t** is:

$$\Delta v = a t$$

and the distance Δx down the runway at any time is:

$$\Delta x = 1/2 a t^2 + v_i t$$

For a fixed length runway, this specifies the time to be used in the velocity equation. Let's assume that at 5000 feet down the runway, the velocity is 80 mi/hr. Then the airspeed is given by

$$\text{Airspeed} = \text{Ground Speed (80)} - \text{Wind Speed (-20)} = 100 \text{ mi/hr}$$

and the airplane begins to fly. Now another pilot, with exactly the same airplane decides to take off to the west. The wind is now in the same direction as the motion and this is called a **tailwind**. The sign on the wind speed is now positive, not negative as with the headwind. The acceleration along the ground is the same, so at 5000 feet down the runway, the ground speed is again 80 mi/hr. The airspeed is then given by:

$$\text{Airspeed} = \text{Ground Speed (80)} - \text{Wind Speed (20)} = 60 \text{ mi/hr}$$

This airplane doesn't have enough airspeed to fly. It runs off the end of the runway!

Significance of Understanding Relative Velocity

The importance of the relative velocity explains why airplanes take off and land on different runways on different days. Airplanes always try to take off and land into the wind. This requires a lower ground speed to become airborne, which means the plane can take off or land in the shortest distance traveled along the ground. Since runways have a fixed length, you want to get airborne as fast as possible on takeoff and stopped as soon as possible on landing. In the old days, a large conical tube known as a windsock was hung near the runway for pilots to see which way the wind was blowing to adjust their takeoff and landing directions. Now mechanical or electronic devices provide the information that is radioed to the cockpit.

The relationship between airspeed, wind speed, and ground speed explains why [wind tunnel](#) testing is possible and how [kites](#) fly.

- In the wind tunnel, the ground speed is zero because the model is fixed to the walls of the tunnel. The airspeed is then the negative of the wind speed that is generated in the tunnel. Whether the object moves through the air, or the air moves over the object, the forces are the same.
- A kite usually has no ground speed because a kite is held on the end of a [string](#). But the kite still has an airspeed that is equal to the wind speed. You can [fly](#) a kite only with the wind at your back.

Problem Set from Beginner's Guide to Aeronautics

[Student Worksheet](#)

[Teacher Key](#)

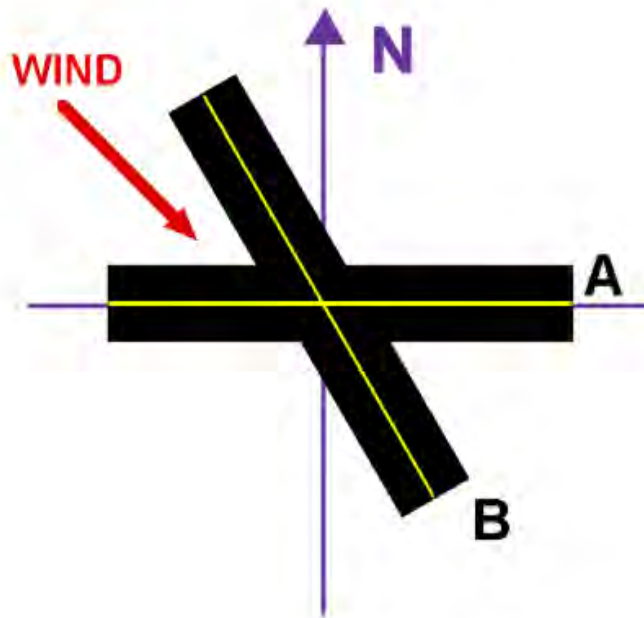

A pilot is about to take off from a Nashville airport that has two runways. Runway A runs east-west and Runway B runs 30 degrees west of north. There is a wind of 25 mi/hr out of the northwest (see figure above).

1. Which runway should the pilot choose?
2. What is the magnitude of the velocity vector of the wind along the desired runway?
3. If an airspeed of 100 mi/hr is required for takeoff, what is the ground speed required?
4. Before the pilot is able to take off, the wind shifts. The wind is now directly out of the north at 25 mi/hr.

Will the pilot choose the same runway?

What is the ground speed required now?

Problem Set from Beginner's Guide to Aeronautics

[Student Worksheet](#)
[Teacher Key](#)



In airport takeoff situations, the ground speed of the aircraft and the wind speed are the only factors in airspeed. The U.S. Navy has an additional variable. Its mobile airports - aircraft carriers - move on the ocean at speeds that can be in excess of 35 mi/hr. Airspeed in this unique situation is a sum of the ship's speed through the water, wind speed, and the speed of the aircraft over the deck of the ship provided by the ship's catapult.

A **catapult** is like a huge rubber band and is used to propel an aircraft to higher speeds over a short distance in a few seconds. For more information on aircraft carriers and catapults, click on [Aircraft Carriers](#). Assume that a typical catapult can propel an aircraft from zero to 150 mi/hr in two seconds. The aircraft carrier problem is pictured graphically in the following illustration. (Note: See the airspeed equation at the bottom.)

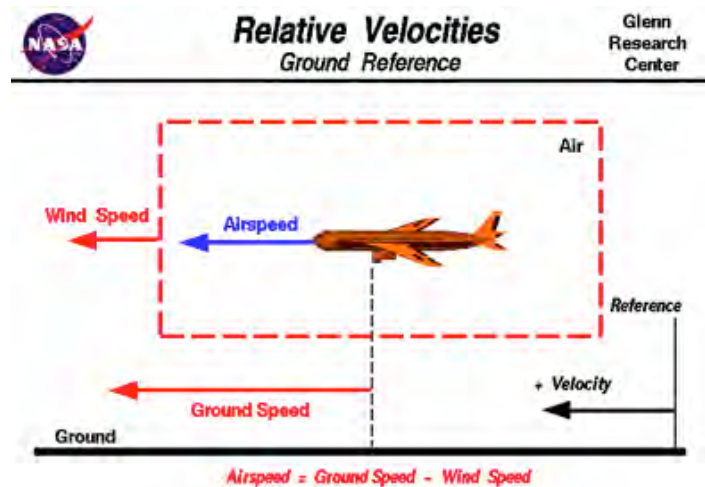

You are the captain of the Aircraft Carrier USS Enterprise (CVN-65). Assume that the required airspeed for takeoff of an F-14 is 170 mi/hr. Using the airspeed equation and information provided, complete the following table and answer the questions that follow. Assume that a positive wind velocity is in the direction of travel of the ship.

Catapult Speed (v_c) mi/hr	Ship Speed (v_s) mi/hr	Wind Speed (v_w) mi/hr	Airspeed	Go/No Go (>170 mi/hr)
150	20	-10		
150	20	10		
150	30	-30		
150	0	20		

$$\text{Airspeed} = \text{Ship Speed } (v_s) + \text{Catapult Speed } (v_c) - \text{Wind Speed } (v_w)$$

1. With no wind, what should the speed of the ship be to launch an F-14?
2. On launch, any aviator wants to maximize lift. What would you do as captain of the ship any time you launch aircraft?
3. Are wind direction and ship speed factors in landing as well? Explain.

ACTIVITY
Estimating the Speed
and Distance of an
Airplane



Objectives

Estimate the speed and distance of an airplane using the speed of sound.

Materials

Meter stick
Lap timer

NGSS

CDI HS-PS2
SEP 1-7
CCC 3,4

Real-World Applications: Estimating the Speed and Distance of an Airplane

Laurence I. Gould & Charles Waiveris. *The Physics Teacher*, 29, 108 (1991).

There are many ways to estimate the distance and speed of an airplane, and one of the simplest ways is to compare the location of a plane by sight with the location of its sound, similar to the process of estimating the distance of a lightning bolt by using the time it takes for the thunder to arrive. In this activity, the speed of sound is assumed to be a standard 343 meters per second (m/s). The value of the speed of sound can be determined experimentally in advance using simple mechanics (with a long tube and two microphones to determine speed from transmission to reception of a sound pulse).

This activity best takes place at a location between two to six kilometers away from a regular plane flight path. It is advisable to find a public viewing location near an airport. Smaller distances result in less time delay for the sound, and greater distances make it difficult to accurately measure locations. Using simple trigonometry (law of cosines) and an estimate for the speed of sound (343 m/s, adjusted for climate conditions), reasonable values for airplane speed and distance can be obtained.

Two approaches are provided for this activity – as a more open-ended inquiry lab as well as through direct instruction.

***Inquiry Approach** – Simplified and Updated by Florian Genz, University of Cologne/ Germany*

The inquiry approach is ideal because of its more holistic, conceptual approach. This approach requires observers to be directly *underneath* the flight path of aircraft. This approach uses a sound intensity meter, and provides a good opportunity for data analysis through the GeoGebra interactive online worksheet. Students can also complete this activity using a readily available YouTube video.

Why? There are many ways to estimate the distance and speed of an airplane but few labs connect everyday technology, such as smartphone sensors, with motivating problems in physics.

Where? This activity best takes place at a location 2-6 km in front of the runway and under a regular plane approach path. Alternative: Watch youtu.be/i0bd9UQKLG0

Setup:

1. Position the camera exactly facing up (the internal G-Sensors or a plumb-bob may help).
2. Fix a long ruler in front of the video camera.
3. Determine the distance between the ruler and the camera.
4. Film an airplane at approach from below.

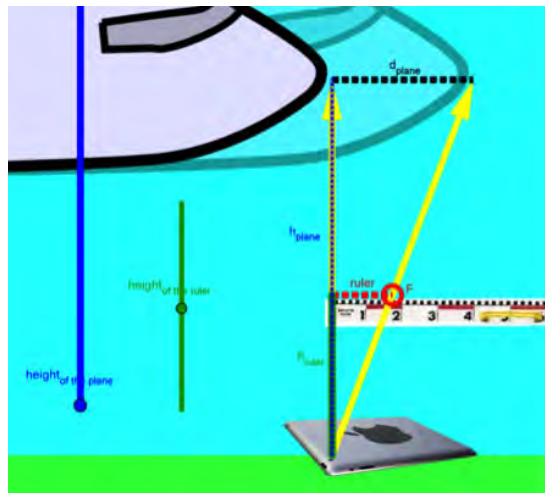

Determining the plane’s height

A plane is usually loudest when directly above an observer. Observe the video and note the time when the plane passed exactly overhead. Then analyze the soundtrack of the video clip and determine at which timestamp the plane was loudest. By noting the time difference in seconds the height can be determined:

$$h_{plane} = \Delta t \cdot v_{sound}$$

In this activity, the speed of sound is assumed to be:

$$v_{sound} = 343 \frac{m}{s}$$

Determining the plane’s speed:

Using simple trigonometry (similar triangles) delivers:

$$\frac{h_{ruler}}{d_{ruler}} = \frac{h_{plane}}{d_{plane}}$$

Students may find these relations on their own or with little hints.

With the Geogebra interactive worksheet “*Application Lab: Estimating Height and Speed of Airplanes*” young learners can get a feeling for the scales. It visualizes their measurements and it allows students to vary and compare their results fast: <http://ggbtu.be/m646385>

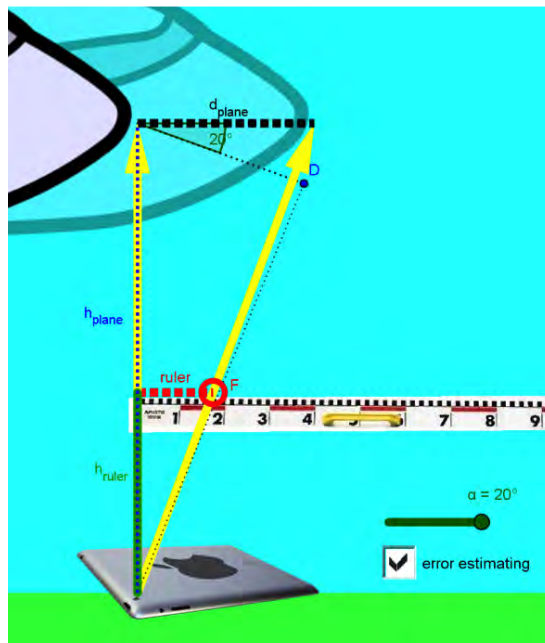

Assumptions

These calculations assume horizontal flight. Typical path angles are $\alpha=3^\circ$ at approach (NOT at takeoff!). Advanced students may click “*error estimation*” and find that small approach angles are negligible.

For estimating the height horizontal flight was assumed. Typical sink rates at approach are **700 ft/min** (= 3.6 m/s). This results in the loudest (=closest) position being not exactly above head. For $h > 1000$ m and $\Delta t < 3$ s students may find it negligible, too.

Further assumptions:

- No wind.
- Infinite speed of light.
- Constant speed of sound.
- No lens errors (e.g. barrel distortion).

Didactic plea: Students may come up with better solutions – or none. Keep in mind: Our aim is to promote scientific thinking, and not simply to produce a solution!

The following student worksheet is structured by the concept of Hacker, Volpert & Dörner’s “*Vollständige selbstregulierte Lernhandlung*” (“*Complete self-regulated learning action*”) modified by A. Bresges (2008).

Student Worksheet: Estimating the Speed and Distance of an Airplane

INQUIRY APPROACH

Objective: Estimate the speed and height of an airplane using the speed of sound.

Why? Approaching planes near airports can look very close and slow. Children living near airports sometimes have nightmares that a plane above them will “fall” from the sky into their bedroom. Can you help them by proving to them how fast and high the planes still really are?

To do this activity, you will need to find a location not far from an airport, where you can see airplanes fly overhead as they are just about to land. Try to find a location that is between 2 to 6 kilometers away from airplanes as they fly.



1912: People looking up to the sky, watching the first aircraft ever to fly over Townsville

(Image Credit: John Oxley Library, State Library of Queensland).

You may use:

- A long ruler (for challenge B)
- A tablet or smartphone with
- a movie cutting app
- a noise analysis app

Challenge A: Measuring a plane’s travelling height



1. You might already have found out that the speed of sound (v_{sound}) is somewhere around 343 m/s. Also you know that the speed of the sound multiplied with the time it travels is the travel height of the plane. Make a sketch or find a formula for this! _____



(alone)

2. Collect ideas how to measure or calculate the missing physical values. There is no right and wrong here! Which tools can you use? Which measuring points or positions are suitable? Which physical units are useful?

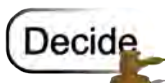

(small group/pair)

3. Now listen to the ideas of your partner(s) and present your ideas. Make a team decision on how to continue. Deciding to ask for help here is also a decision. Try to write down your problem before.



(small group/pair)

4. Do what you decided. If problems occur, go back to planning and try again.



(small group/pair)

- Estimate how reliable your measurements are. Can you repeat them exactly? What is your measuring tolerance?

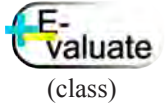

(class)

Finally discuss WHAT you actually measured and present your findings to the whole class.

Listen carefully to the findings of the other groups and try to find differences and similarities.

Now that you already have successfully completed circle of a self-regulated learning action try to do it again, but this time with an even harder challenge:



Aim

Challenge B: Measuring the plane's speed

You know the travelling height (hplane) of the plane now. Maybe this triangle sketch will give you ideas on how to first measure the plane's traveling distance (dplane).



(alone)

- My ideas are...



(small group/pair)

- We decided...



(small group/pair)

- This we had to change:
Because...

This worked as planned:



(small group/pair)

- Verification

Quantity →						
Unit →						
#1						
#2						
#3						
#4						
...						
Average:						

Our measuring results seem to...

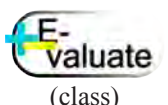

(class)

- What if the plane doesn't fly horizontally? Would it influence the measurements? Discuss with the class. Is it possible with your method to record the speed and height of a plane from other directions?

* Ultimate challenge: Can you persuade a much younger child of your findings with simple words?

Direct Instruction Approach

The direct instructional approach closely models the method referenced in *The Physics Teacher*, and might provide greater clarity to the teacher or student who needs more scaffolding or who appreciates mathematical puzzles. Additionally, the approach suggested does not require students to be directly underneath the flight path – only near it.

The more direct approach, outlined in *The Physics Teacher* article, uses the following method:

Once an airplane begins to pass overhead, hold out the meter stick perpendicular to the line of sight toward the airplane (A). Once the position is noted (a), simultaneously begin the lap timer (T0). A helper should also measure the distance of the sighter's eye to point a (x). When the sound of the airplane also appears to come from point A, record the sighted position (b) of the plane's current location (B), and again press the lap timer (T1). Again, wait for the sound to appear to come from point B, and record the sighted position (c) of the actual plane (C), and press the lap timer again (T2).

The change in time for the intervals can be defined as:

$$T_1 - T_0 = t_1$$

and

$$T_2 - T_1 = t_2$$

The actual speed and distance of the airplane can then be estimated using the law of cosines. The view of the flight path can be denoted by triangle AOB, with sides D1, D2, and D12. Most high school students will at least have some level of familiarity with the Pythagorean theorem's more general expression for any triangle:

$$c^2 = a^2 + b^2 - 2ab \cos \theta.$$

This can be substituted for actual values from the activity, to give

$$(D_{12})^2 = (D_1)^2 + (D_2)^2 - 2D_1D_2 \cos \theta.$$

Because distance, D, can be expressed as the product of speed and change in time (v t), this equation can be further defined as

$$(v_p t_1)^2 = (v_s t_1)^2 + (v_s t_2)^2 - 2(t_1 v_s)(t_2 v_s) \cos \theta,$$

and simplified to

$$v_p = \frac{v_s}{t_1} \sqrt{t_1^2 + t_2^2 - 2t_1 t_2 \cos \theta}.$$

The angle can be estimated with the simple form of the Pythagorean theorem, as:

$$\cos \theta = \frac{x}{\sqrt{x^2 + (b-a)^2}}.$$

If possible, students can also attempt to identify the type of plane, and to compare their resulting speeds to speeds typical of planes as they take off or land.

Sample data is reproduced here in Table 1.

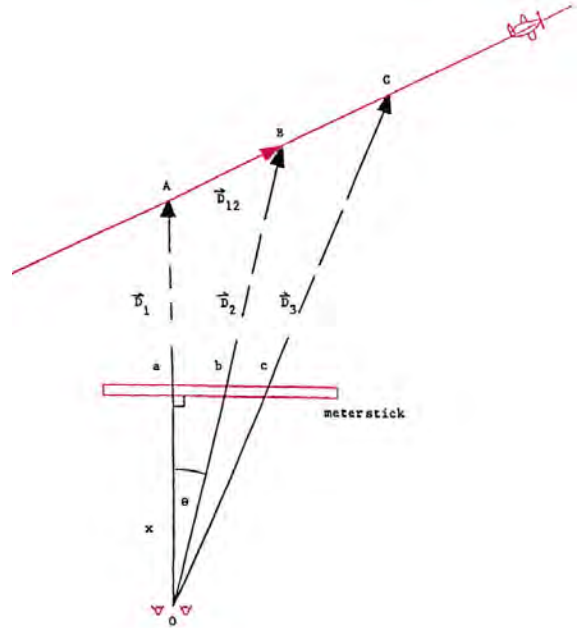

Table I.

x	$b-a$	t_1	t_2	D_1	v_p	dv_p/v_p
	15 cm	11.8 s	10.6 s	3.9 km	271 km/h	.078
	24	8.5	8.8	2.8	407	.066
	20	13.2	12.9	4.4	333	.077 ^a
67	18	13.7	13.0	4.6	313	.078 ^a
	16	12.6	11.3	4.2	285	.075 ^b
67	16	13.0	12.1	4.3	284	.082 ^b
	20	14.3	13.8	4.8	333	.076 ^c
67	20	14.7	14.5	4.9	346	.075 ^c
	24	19.3	20.0	6.4	407	.066 ^d
67	22	19.0	20.2	6.3	399	.067 ^d
63	22	19.5	19.6	6.5	403	.066 ^d

Student Worksheet: Estimating the Speed and Distance of an Airplane

DIRECT INSTRUCTION APPROACH

Objective: Estimate the speed and distance of an airplane using the speed of sound.

From your previous investigations, you might have found out that the speed of sound is somewhere around 343 m/s, and perhaps a bit higher or lower depending upon atmospheric conditions. In this activity, you will use trigonometry and the difference in time between the location of an airplane and the apparent location of its sound, in order to find out both the speed and distance of an airplane.

To complete this activity, you will need to find a location not far from an airport, where you can see airplanes fly overhead as they are just about to land or takeoff. Try to find a location that is between two and six kilometers away from airplanes as they fly.

1. What travels faster – sound or light? Explain how you know. (Consider lightning and thunder, or the sights and sounds of fireworks).

For this activity, you may assume that light travels instantaneously (although it actually doesn't), and that sounds travels at 343 m/s. Similar to the situations identified in #1 above, it is possible to look at a plane, and to hear the sound appearing to travel behind it. In this activity, you will use a timer to mark the time and location of an airplane at two points on a meter stick, and also time how long it takes for the sound to appear to catch up to the plane's previous positions.

This task will take some coordination, so be patient, and make sure you are in a location where multiple airplanes pass by every hour. Be sure to read the instructions first, as you will not have time to read them once you begin!

2. Hold out a meter stick parallel to your face. Have your partner record the distance between your eyes and the point on the meter stick, so that it makes a 90 degree angle (0 – a). Put a piece of tape at this position.

Record the distance from eyes to meter stick here: 0 – a: _____ m

Record the position of “a” here: a: _____ m

3. Watch for the first aircraft to pass by. When the aircraft is located at “a,” call TIME! Your partner should begin the stopwatch.

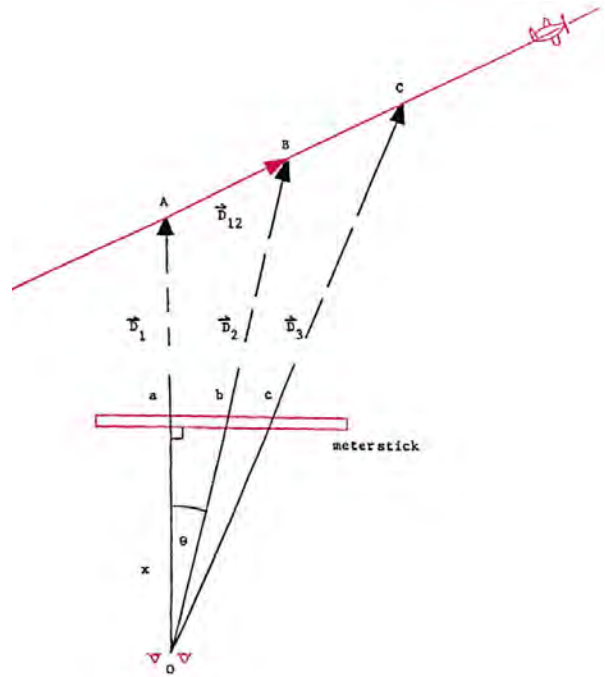

4. Listen carefully for the airplane's sound until it also appears to be located at "a." At that moment, quickly glance at the airplane's location and call out the position on the meter stick. At that moment, your partner should hit the "lap" button on the timer and record the position you called out. This position is now known as "b." *See the image below if you need help.*

Record the first lap time here: $T_1 - T_0 = t_1$: _____ s

Record the position of "b" here: b: _____ m

5. Listen carefully for the airplane's sound until it also appears to be located at "b." At that moment, quickly glance at the airplane's location and call out the position on the meter stick. At that moment, your partner should hit the "lap" button on the time and record the position you called out. This position is now known as "c."

Record the second lap time here: $T_2 - T_1 = t_2$: _____ s

Record the position of "c" here: c: _____ m

6. Now that you have all of your data, you can estimate the speed and distance of the airplane. For simplicity, focus only on the first triangle, AOB, with sides D_{12} , D_1 , and D_2 . Note that this is *not* a right triangle. However, the extended form of the Pythagorean theorem can be used,

$$c^2 = a^2 + b^2 - 2ab \cos \theta.$$

which can be substituted with the symbols for the sides.

$$(D_{12})^2 = (D_1)^2 + (D_2)^2 - 2D_1D_2 \cos \theta.$$

7. However, you don't have the value of any of the sides! Instead, how can you represent an expression for D ? (Hint: Use your equation for distance, speed, and time, and solve for D . Substitute this expression for D into the equation, ensuring that you are using the proper time).

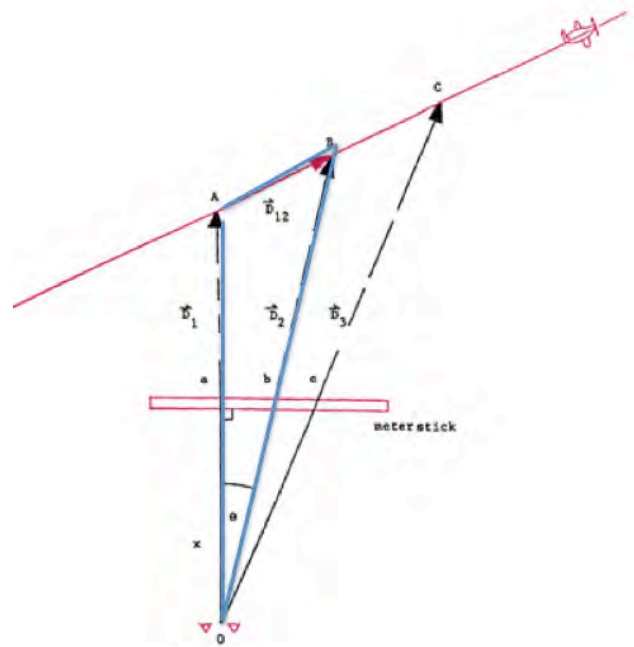

Because distance, D , can be expressed as the product of speed and change in time ($v t$), this equation can be further defined as

$$(v_p t_1)^2 = (v_s t_1)^2 + (v_s t_2)^2 - 2(t_1 v_s)(t_2 v_s) \cos \theta,$$

where v_s is the speed of sound and v_p is the speed of the plane.

8. Explain how the equation above can be simplified to: $v_p = \frac{v_s}{t_1} \sqrt{t_1^2 + t_2^2 - 2t_1 t_2 \cos \theta}$.

9. Now, all that remains is to solve for the angle near your eye. Use your markings on your meter stick for positions “a” and “b,” as well as the value of x , to solve for the angle. Show work.

10. Substitute all values into the equation from #8, and calculate the speed of the plane.

11. Perform the same analysis for triangle AOC. Calculate the speed of the plane using that data.

12. How does the data for your airplane speed compare with each other? How does it compare to sample data produced by other physics students in Table 1?

Table I.

x	$b-a$	t_1	t_2	D_1	v_p	dv_p/v_p
	15 cm	11.8 s	10.6 s	3.9 km	271 km/h	.078
	24	8.5	8.8	2.8	407	.066
	20	13.2	12.9	4.4	333	.077 ^a
67	18	13.7	13.0	4.6	313	.078 ^a
	16	12.6	11.3	4.2	285	.075 ^b
67	16	13.0	12.1	4.3	284	.082 ^b
	20	14.3	13.8	4.8	333	.076 ^c
67	20	14.7	14.5	4.9	346	.075 ^c
	24	19.3	20.0	6.4	407	.066 ^d
67	22	19.0	20.2	6.3	399	.067 ^d
63	22	19.5	19.6	6.5	403	.066 ^d

13. Would it be possible to perform the same analysis with triangle BOC? Why or why not?



Real-World Applications: Noise Doppler-Shift Measurement of Airplane Speed

Ivan F. Costa and Alexandra Mocellin. *The Physics Teacher*, 45, 356 (2007).

Objectives

Use linear relationships, graphs, and body movement to simulate air traffic control.

Materials

Internet access:
<http://smartskies.nasa.gov>
Paper (type rolls)
Paper placards
Timers

NGSS

CDI HS-PS4-1
SEP 1-7

While out measuring the distance and speed of airplanes using trigonometry and/or sound intensity, a further option is to measure the speed of airplanes using Doppler shift. (However, ensure that students develop a good conceptual understanding of the Doppler effect before pursuing this activity).

Simple fast Fourier transform (FFT) analyzers can be obtained freely through mobile device apps or probeware companies. Allow students to first hear the Doppler effect of aircraft as they pass by. Then, use an FFT analyzer to determine the average frequency of the plane as it comes toward the observer, is near the observer, and as it goes away from the observer.

Three primary frequencies should be identified in the FFT profile – frequency when coming toward, frequency when directly above/beside the observer, and frequency when leaving. Although this pattern can be observed in Figure 3 as a kind of stair step graph, different FFT analyzers will represent these values in different ways. (Additionally, students will note that there is a lot of background noise, originating from erratic vibration, turbulence, etc.) Using these frequencies, apply the Doppler shift equation to estimate the speed of the source.



Fig. 1. Photograph of measurement site neighboring the airport.

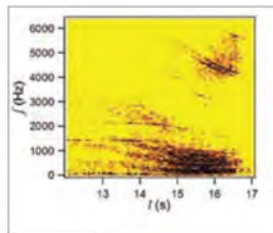

Fig. 2. The whole time-versus-sound's frequency spectrogram obtained after FFT of the noise recorded.

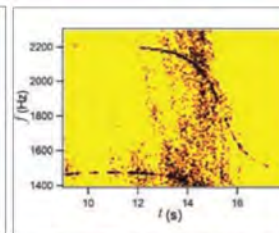

Fig. 3. The blow up of Fig. 2 at frequencies around 1800 Hz. The signal is well-visualized like a step shape beginning approximately at 2.2 kHz and finishing at 1.5 kHz.



New Acoustics Techniques Clear Path for Quieter Aviation

<http://www.nasa.gov/larc/new-acoustics-techniques-clear-path-for-quieter-aviation/#.VHS3oo29-Rh>

Analysis Questions

- What is “auralization”? Why is it important?
- What is “psychoacoustics”? Why is it important to use human test subjects, rather just than electronic sound analyzers?
- Click on the hyperlink near the end of the article to listen to a variety of Aircraft Flyover Simulation files. Listen to a number of different scenarios, then comment on at least five variables that you think researchers must take into account when doing “auralization” work. If you are uncertain, click on the research papers associated with the files to learn more.



Real-World Applications: Smart Skies

<http://smartskies.nasa.gov/>

The following activities are a synthesis of currently available Smart Skies and FlyBy Math modules produced by NASA. This handout provides an introduction to the tasks, but formal teacher guides and student worksheets and resources are located online at the links to the side.

Objectives

Use linear relationships, graphs, and body movement to simulate air traffic control.

Materials

Internet access:
<http://smartskies.nasa.gov>
Paper (type rolls)
Paper placards
Timers

NGSS

CDI HS-PS2
SEP 2, 4, 5, 7
CCC 3, 4, 7

Objective

Model the difficulties and problems associated with air traffic control using mathematics and simulations. NASA has developed two comprehensive curricular modules, titled *Fly By Math* and *Line Up With Math*, as well as a free app, Sector 33, which can be used independently.

Fly by Math

Fly By Math makes use of five different scenarios of airplanes approaching each other. Students are provided with each scenario, and asked to determine a variety of information about the airplanes, including the time it will take for each plane to merge onto the main route (problems 1-4) and the time when the trailing plane will catch up to the leading plane (problem 5).

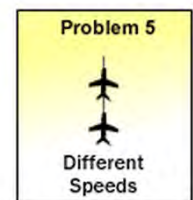
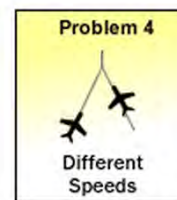
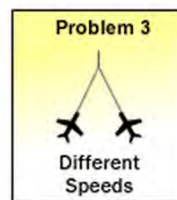
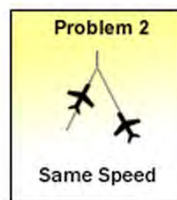
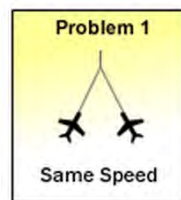

Students will solve each of the above problems using up to six different calculation methods:

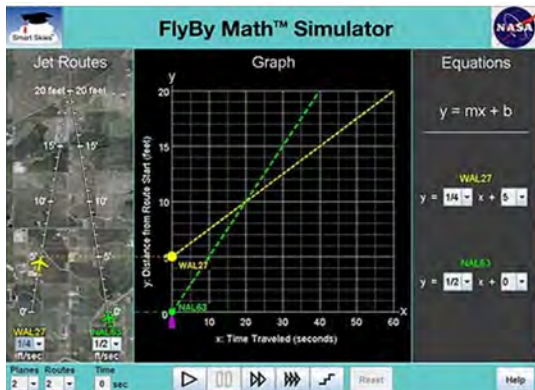

- Counting feet and seconds using a jet route diagram
- Drawing blocks to make a bar graph
- Plotting points on two vertical number lines
- Plotting points on a Cartesian coordinate system
- Deriving and using the distance-rate-time formula
- Graphing two linear equations

In addition, students can use the *Fly By Math Simulator* to plot airplane distance versus time, and see the effects of changing speed and starting distance from the origin by modifying variables in the linear equation.

Line Up With Math

Line Up with Math makes use of six different problems about airplanes. Airplanes must be carefully aligned to be within three nautical miles of each other upon approach into an air sector to ensure that plane distances are both safe as well as efficient. Students must find solutions to problems involving two-plane and three-plane conflicts resolved with route changes, two-plane and three-plane conflicts resolved with speed changes, and three-plane, four-plane, and five-plane conflicts resolved with speed changes or with speed and route changes. Students use an online air traffic control simulator, supported by student worksheets, to model the movements and placements of airplanes, and to change their speeds and/or routes.

Students and the wider community can access the benefits of *Line Up With Math* with the stand-alone *Sector 33* app for iOS and Android mobile devices.



Sector 33

Sector 33 is an app that allows users of all backgrounds to experience what it is like to manage air traffic control. Sector 33 is the actual airspace around the San Francisco Bay area.

Sector 33 can be downloaded, for free, from the Apple iTunes Store and the Google Play Store.

iOS iTunes Store: <https://itunes.apple.com/us/app/sector-33/id486953105?mt=8>

Android Google Play Store: <https://play.google.com/store/apps/details?id=gov.nasa.stem>



Sector 33 App Description

It's a stormy Friday evening in Northern California as the evening rush of air traffic fast approaches the San Francisco Bay Area. All flights going to San Francisco airport from the east pass through "Sector 33" – YOUR sector of the airspace.

As the lead air traffic controller for Sector 33, you must merge the arriving planes into a single traffic stream as they pass over Modesto, Calif. on the western edge of your sector. The planes must be properly spaced and arrive over Modesto as soon as possible. Every minute you delay a plane during the traffic rush, that delay is passed on to ALL the other planes flying behind it. Although time is of the essence, to assure safety, the planes must NEVER violate minimum spacing requirements.

Can you handle Sector 33?

Features

- Thirty-five problems
- Two to five airplanes
- Speed and route controls
- Thunderstorm obstacles
- Four levels of controller certification
- Locked levels
- Scoring for each problem
- Scoring for each certification level
- In-game introduction
- In-game hints
- Help section
- Extra videos
- Links to related websites
- Links to social websites

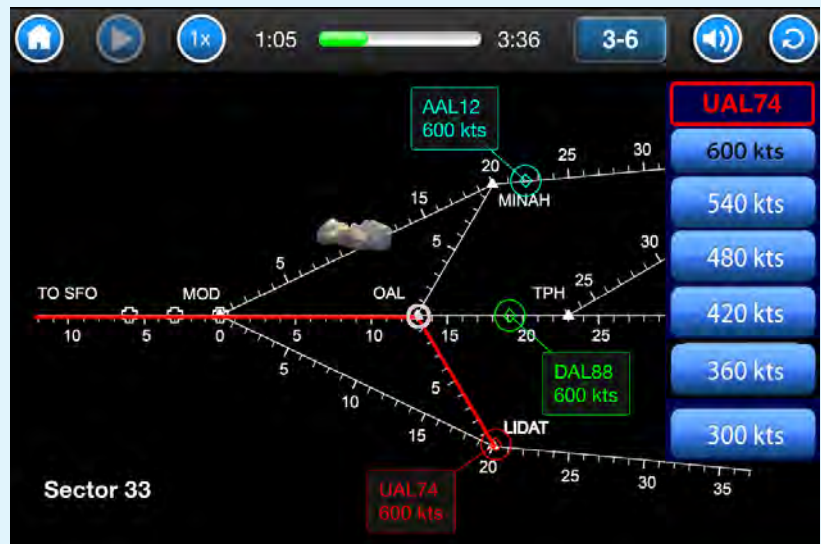

In the US Sector 33 airspace, three main air highways merge together over Modesto. In order to ensure that the planes are efficiently trafficked upon arrival at their destination airport – to save fuel and decrease the incidence of delays – all of the planes must be within three nautical miles of each other, but no less than two nautical miles, to ensure safety. In the scenario, the user must provide instructions to each of the airplanes on their speed and route. The game player must use mathematical strategy, ratios, and time sequencing by thinking ahead. Failing to do so results in a loss of points, and, in the real world, possible tragedy.

As an example, Level 3-g is displayed. Three airplanes, AAL12, DAL88, and UAL74 are approaching Modesto at the same speed of 600 knots. AAL12 is approximately 19 nautical miles from Modesto, while DAL88 is 21 nautical miles away, and UAL74 is 23 nautical miles away if it follows the southern-most path, or 26 miles away from Modesto if it directed to branch off toward position OAL. Because all airplanes must achieve a spacing of three nautical miles away from each other by the time the last plane reaches Modesto, there are a variety of possible solutions, as all of the planes' speeds are relative to one another. However, not all solutions are viable, given weather conditions that block certain pathways, and the inability to speed up planes (only decrease speed from a maximum of 600 knots).

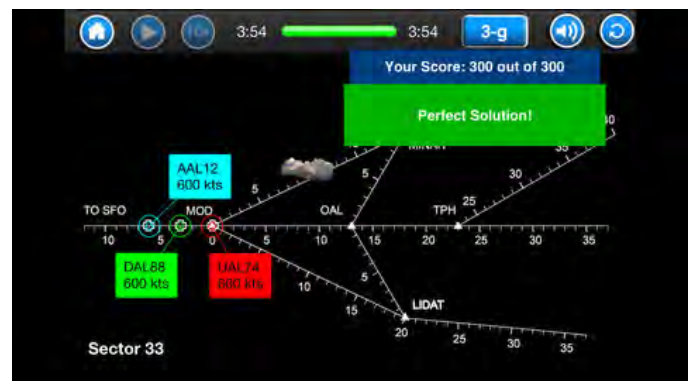

Although this might appear quite complex, students are built up from simple to more complex scenarios along the way, and are given a variety of helpful hints:

1. Sending a plane along an intermediary branch (i.e. from positions MINAH to OAL, or LIDAT to OAL) adds an additional three nautical miles to the total distance.
2. Speed options decrease by 60 knots each (i.e. from 600 knots to 540 knots). Because the definition of one knot is “one nautical mile per hour,” a decrease in speed by 60 knots decreases the distance covered in one hour by one-sixtieth of the distance covered per hour (i.e. the distance covered in one minute).

In reference to the example problem in level 3-g above, one possible solution would require the user to :

1. Decrease DAL88’s speed to 540 knots for one minute, in order to increase distance from AAL12 by one more nautical mile.
2. Send UAL74 from LIDAT to MOD, and decrease speed to 540 knots for two minutes, or 480 knots for one minute, in order to space UAL74 three nautical miles away from DAL88.

This engaging, educational game demonstrates to students not only the complexities of managing relative speeds and distances, but demonstrates, on a small scale, how difficult it can be to safely and efficiently manage systems of hundreds of planes that might pass through a single airspace sector each day.



Air Traffic Operations Lab Answering Big Questions About the Future of Air Travel

<http://www.nasa.gov/content/air-traffic-operations-lab-answering-big-questions-about-the-future-of-air-travel/#.VHSn5Y29-Rg>

Questions for Analysis

- The article references that “algorithms” are used to model air traffic. What is an algorithm?
- Why is computer modeling of air traffic insufficient? Why must human test subjects be used?

NASA Tool Helps Airlines Minimize Weather Delays

<http://www.nasa.gov/aero/nasa-tool-helps-airliners-minimize-weather-delays.html#.VHS1e429-Rg>

Questions for Analysis

- At the time the article was written, how much did jet fuel cost per gallon?
- By cutting 6.2 minutes of flight time from each of 538 American Airlines flights, how much money was saved per flight? How much money was saved in total?
- What values and interests do you think influence what kinds of research get done, in general?



Objectives

Build a model Prandtl pressure tube. Qualitatively determine “Bernoulli’s” principle. Measure static, dynamic, and total pressure using student-determined units.

Materials

- Translucent bendy straws
- Translucent cup
- Colored water
- Ruler
- Tape
- Wind source of variable speed (fan, hair dryer)
- Fluid barometer (optional)

NGSS

- CDI HS-PS2
- SEP 2, 3, 6
- CCC 2, 4, 5, 6

Interactive Demonstration: Pitot-Static Tube

Using visual clues or global positioning system (GPS) instrumentation, it can be very easy for observers to determine the speed of an aircraft with respect to the ground (groundspeed). However, as you have seen earlier, what is really more important to aircraft is its speed with respect to the surrounding air (airspeed).

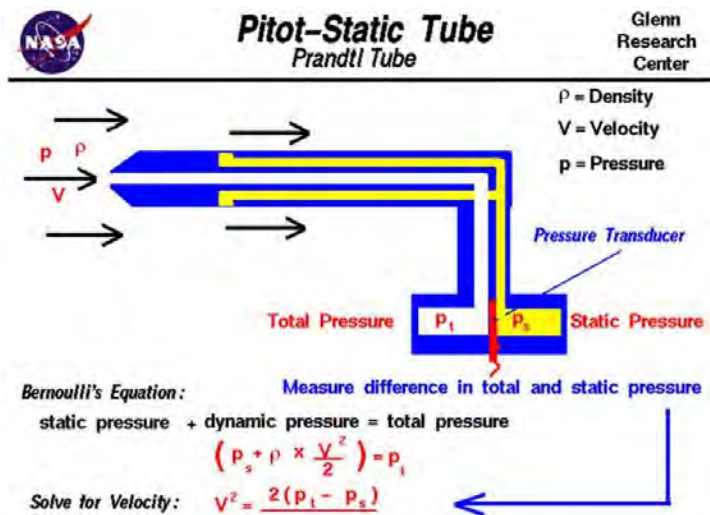

The way that aircraft determine their speed requires the use of small tubes (pitot tubes) that point toward the source of the airflow. This tube measures the total pressure (atmospheric pressure and pressure resulting from the airflow directed into the tube). Additionally, other tubes are open to the air 90 degrees to the airflow, which measures the static pressure (atmospheric pressure at the point of the opening, resulting from flow over the aircraft as well as other climatic conditions). The difference in these values (total pressure – static pressure) results in dynamic pressure. (Note: Dynamic pressure is actually the *difference* between the pressures at two points, and should be mathematically represented with a delta (Δ) when not written in its differential form.)

To demonstrate this, help students to construct a very simple static pressure probe. Place a single straw vertically in a cup of colored water. Take another straw (or portion of a straw), and use it to blow directly across the opening of the vertical straw. When the students blow, the fluid will rise to a particular level. At high air speeds, the fluid rises to a higher level. At very high speeds, students will observe the device behave as an atomizer and sprinkle fluid. (Caution: Food coloring might stain fabric).

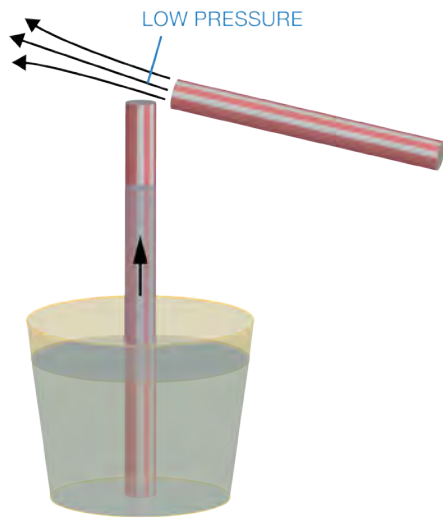

Ask students to **qualitatively determine the relationship between static pressure and wind speed above the opening**. Students will easily recognize that as wind velocity increases, static pressure decreases.

Pedagogically, however, there is a bit more complexity. To understand pitot tubes, it is important to understand pressure difference, a concept that is best emphasized through an understanding of reservoirs, barometers, and manometers. The fact that the fluid rises up in the straw when air is blown over it is not just a matter of the fact that pressure was decreased across the top of the straw. In fact, it is the air pressure pushing down on the fluid in the reservoir (the liquid in the cup) that is greater than the pressure inside of the straw. Hence, the fluid height is actually a result of a *difference in pressures* between the two. (Likewise, consider offering students the option to use a straw to drink up a soda – it is not the “sucking” action that causes the fluid to flow, but the pressure from the air on the surface of the soda that pushes it down and up into the vacuum of the mouth).

The fact that atmospheric pressure has an effect can be demonstrated with a **barometer**. Barometers are traditionally produced by filling a tube completely with a fluid (such as mercury, because of its high density), and then inverting the tube into a reservoir. A vacuum is created inside of the top of the tube, because the atmosphere can only push up a certain quantity of it in the tube. As atmospheric pressure changes, more or less fluid gets pushed into the tube. The reading of the relative height is then converted into units of atmospheric pressure.

Alternatively, a **manometer** can be used to measure pressure difference as well. Although, like barometers, manometers have one (or two) ends that are open to the surrounding atmosphere, they do not need to be. Manometers can be used to measure the pressure of a gas relative to another gas that does not need to be the atmosphere.

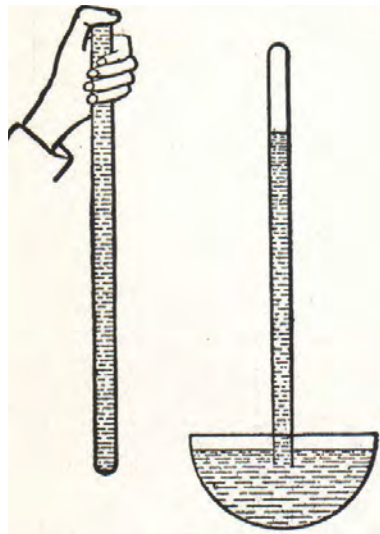

Pitot-static tubes work on the principle of difference of pressure to determine the relative airspeed. In the case of the straw demonstration, speed can be inferred based upon how high the water goes up the straw (which is a result of the difference between the pressure inside of the straw and around the straw on the surface of the water). In the case of pitot-static tubes, pressure is compared in a tube facing directly into the wind (**total pressure**), to the pressure at a tube that points 90 degrees to the wind (**static pressure**). If the static pressure is MUCH lower than the total pressure, then the airspeed is very high. If the static pressure is a LITTLE BIT lower than the total pressure, then the airspeed is very low. If the two pressure values are the same, then the airspeed is zero (and, hopefully, the aircraft is at rest on the ground!)

Next, allow students to fashion a model pitot-static tube using the following worksheet.

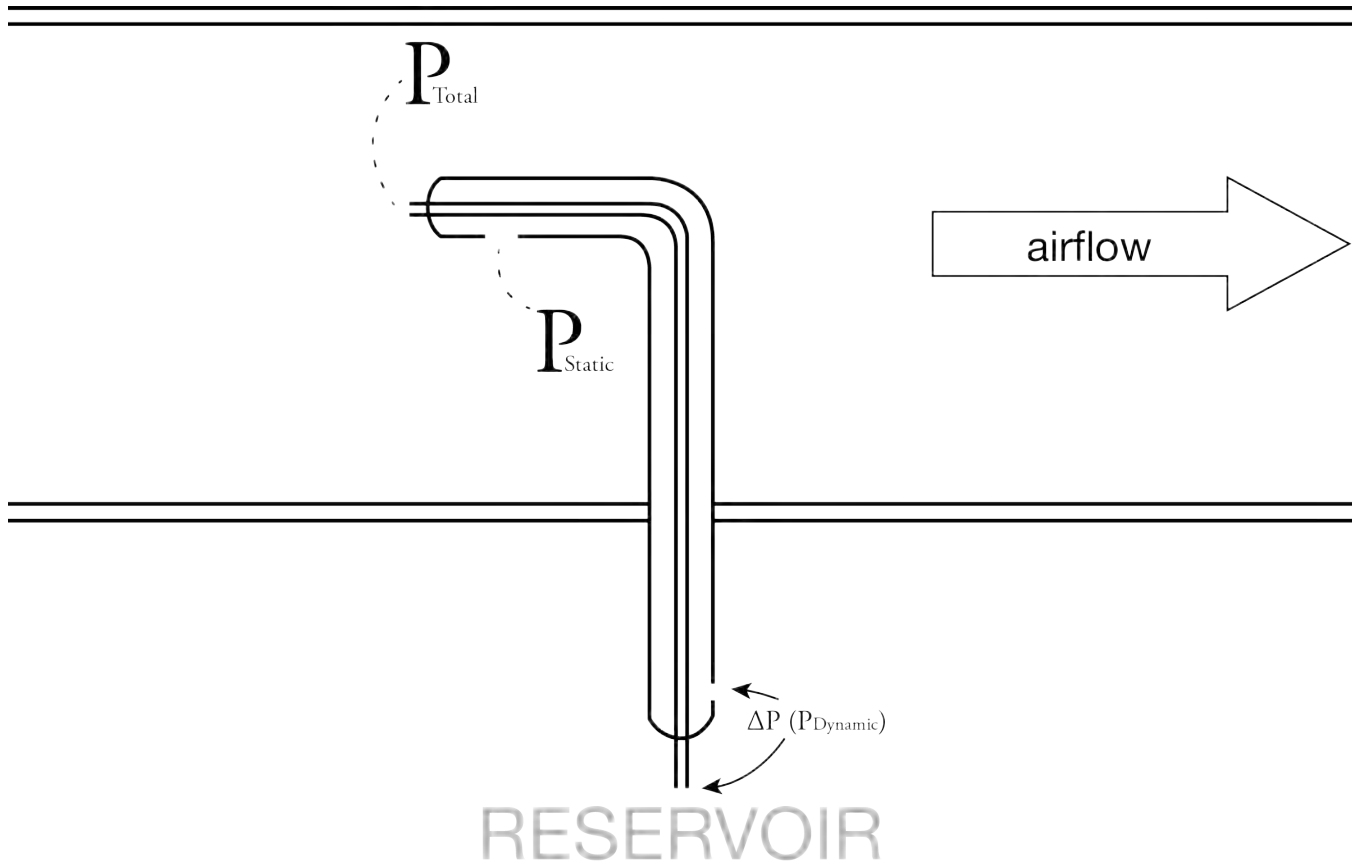

Teacher Answer Key: Pitot-Static Tube

Provide students with materials, and encourage them to make a model pitot tube and then pitot-static tube. The simplest pitot-static tube can be fashioned out of a cup, water, and some straws. Students might decide to make their pitot-static tubes similar to manometers (with a connected reservoir) or with an open reservoir, such as a cup open to the atmosphere. Encourage students to demonstrate their understanding by asking them to do the following:

1. Blow air directly over a static pressure tube (vertical tube inserted into water, but not resting against the bottom of the cup). What happens? Why do you think this happens?

As air is blown across the tube, the fluid level settles at a level higher than it was before. Sometimes, the fluid from the reservoir even leaves the top of the tube and sprays all over. This is because the pressure outside of the tube around the reservoir (atmospheric pressure) is greater than the pressure inside of the vertical tube. Hence, the pressure inside of the tube must decrease when the wind blows over it.

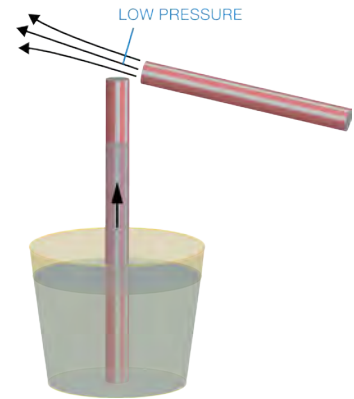

2. Demonstrate how relative speed of air blowing over the tube can be determined. Use a wind source with a high or low setting to show how the device works.

As wind blows over the Static tube, its fluid level will settle at a higher level than before (lower pressure than before). As wind blows into the pitot tube, its fluid level will settle at a level lower than before (higher pressure than before).

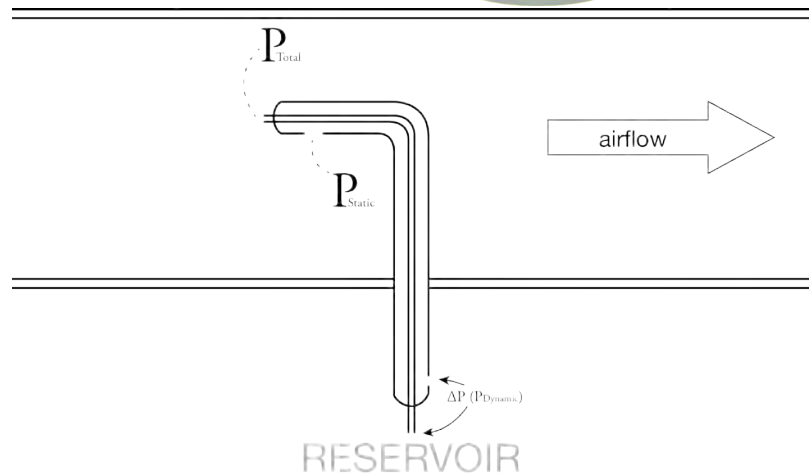

3. Identify the variables that influence the actual static pressure.

Atmospheric pressure and wind speed are the greatest contributors. Wind speed can also be influenced by regional factors, including turbulent flow that results from aircraft shape or climactic changes.

4. Build a model pitot-static tube with the available materials. Again, blow air directly across the Static tube and into the pitot tube. What happens? Why?

The fluid in the pitot tube settles lower than the reservoir level (because the pressure is higher inside of the tube), and the fluid in the Static tube settles higher than the reservoir level (because the pressure is lower inside of the tube). If this cannot be seen, either because the straws are opaque or it is difficult to see the fluid, then have students listen to the sound produced in the tubes. As students force faster air over the pitot tube, the pitch decreases. As they force faster air over the Static tube, the pitch increases. The change in pitch is a result of the resonance of tubes of different length, which depends upon the level of the fluid in the tube.

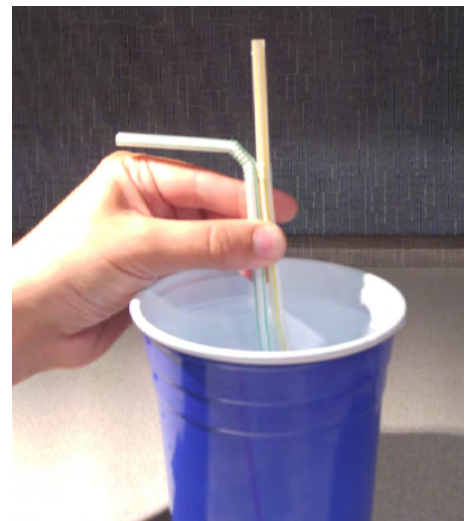

5. Identify the variables that influence the total pressure.

All of the above variables influence total pressure. However, wind speed has a much greater impact on the pitot tube because particles are actually being forced into the tube.

6. Explain how the changes in fluid levels could be quantified and interpreted to make meaning of dynamic pressure. (Note: Allow students to look at a glass barometer. They will notice that the pressure gradations are linear. Therefore, for an incompressible fluid, twice the pressure results in twice the change in height of the fluid).

Fluid levels could actually be measured with a small ruler. Large changes in fluid height mean that there has been a large change in pressure, and vice versa. Total pressure (at the pitot tube) could be subtracted from the static pressure (at the static tube) to determine a relative fluid height representing the dynamic pressure. While the actual value for dynamic pressure might not be easily calculated, it should be relatively easy to determine if the dynamic pressure is greater or less than the static pressure.

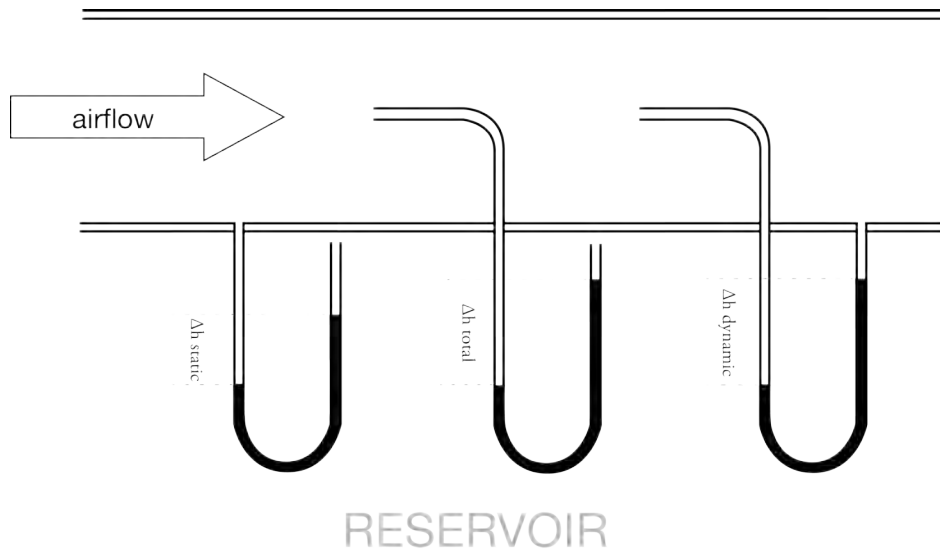

7. Describe the benefits/disadvantages to using a fluid reservoir that is open to the atmosphere, versus connecting the two tubes to make a manometer.

Opening the fluid reservoir to the atmosphere results in a third pressure value that is likely a known value (if an atmospheric barometer is available). When using a manometer that is closed to the atmosphere, it is possible to know relative pressure (how many times greater the pressure of one gas is compared to the other), but actual pressure cannot be known without knowing the actual pressure of at least one of the gasses.

8. Explain why it is vitally important to pilots to know their airspeed (and not just their groundspeed).

Airspeed is what provides the lift. If an airplane is traveling at exactly the same velocity as the air around it, its relative speed is zero, and no lift will be produced.

Student Worksheet: Pitot-Static Tube

Watch your teacher demonstrate a static pressure tube made from straws.

1. Blow air directly over a static pressure tube (vertical tube inserted into water, but not resting against the bottom of the cup). What happens? Why do you think this happens?
2. Demonstrate how the relative speed of air blowing over the tube can be determined. Use a wind source with a high or low setting to show how the device works.
3. Identify the variables that influence the actual static pressure.

4. Build a model pitot-static tube with the available materials. Include a sketch of your design. Again, blow air directly across the static tube and into the pitot tube. What happens? Why?

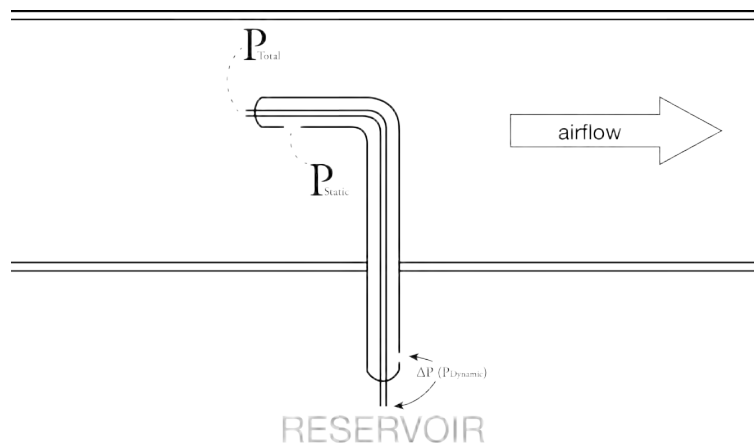

5. Identify the variables that influence the total pressure.

6. Explain how the changes in fluid levels could be quantified and interpreted to make meaning of dynamic pressure. (Note: Allow students to look at a glass barometer. They will notice that the pressure gradations are linear. Therefore, for an incompressible fluid, twice the pressure results in twice the change in height of the fluid).

7. Describe the benefits/disadvantages to using a fluid reservoir that is open to the atmosphere, versus connecting the two tubes to make a manometer.

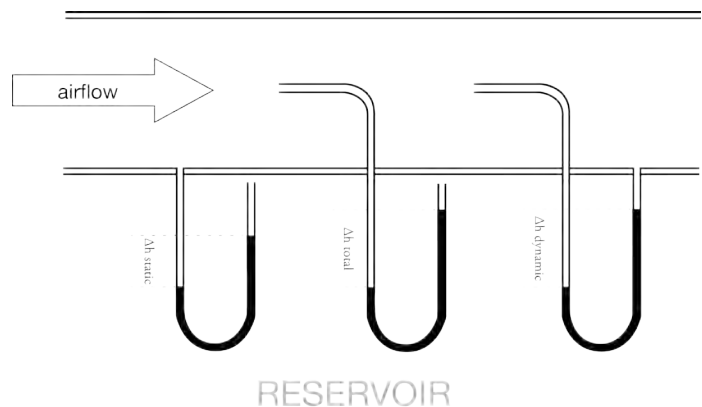

8. Explain why it is vitally important to pilots to know their airspeed (and not just their groundspeed).

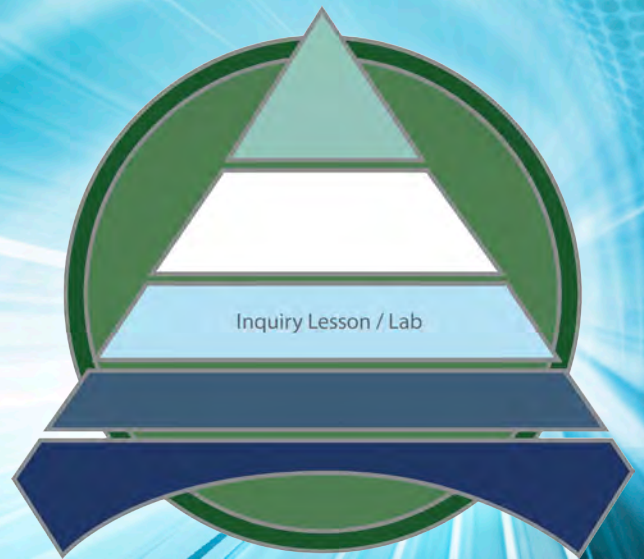

Objectives

Build a cambered airfoil.
Measure the airfoil's pressure
foil in varying situations.

Materials

Thin and transparent straws
Transparent container
Colored Water
Ruler
Clay
Tape
Cardboard
Cord wire
Suspension material
Large box fan
Sharp knife or blade

NGSS

CDI HS-PS2
SEP 2, 3, 4, 7
CCC 1, 2, 4, 5, 6

Inquiry Lesson/Lab: Bernoulli Effect Lab

Developed by Florian Genz, University of Cologne

Most textbooks (elementary through college) attribute a large part, if not all of, the force of lift directly to Bernoulli's principle. In the simplest terms, most books describe that an airplane's lift originates from the idea that *air must flow faster over a cambered airfoil rather than under it, resulting in a decrease of pressure on top of the airfoil*. While this statement is not entirely untrue, it is often based upon very faulty assumptions, and a disproportionate contribution to the total lift force. As student progress, they will learn more about these common misconceptions in the activity "Models of Lift."

In closed systems of incompressible fluid, Bernoulli's Principle states the relationship between differences in static pressure, p_s , and flow velocity, v :

$$\Delta p_s = \frac{1}{2} \rho v^2$$

In the previous activity, students will have determined that wind speed above a static pressure tube influences the pressure in the tube. Faster air currents result in a lower pressure than slower air currents.

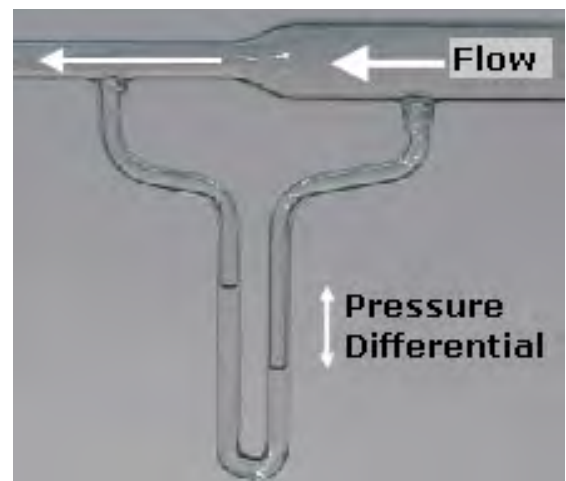
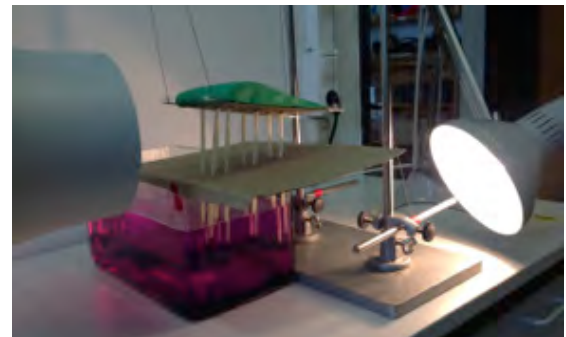

Again however, Bernoulli deals with incompressible fluids (such as most liquids), not gases. Additionally, a closed tube system is very different from an airplane's wing. For example, holding cardboard horizontally over or under the wing to simulate a "closed system" can change the pressure profile dramatically. Also winglets (cardboard on the side edges) make the pressure profile more Venturi-tube situation-like (<https://commons.wikimedia.org/wiki/File%3AVenturiFlow.png> By user: ComputerGeezer and Geof (Modified from :de:Bild:Venturirohr.jpg) [CC-BY-SA-3.0](https://creativecommons.org/licenses/by-sa/3.0/), via Wikimedia Commons).

Objective: Qualitatively or quantitatively determine the pressure profiles of a cambered airfoil.

The following instructions are for a low-tech, qualitative approach to this lab. Using precision laboratory equipment, however, it is possible to get a much deeper understanding of the relationship between pressure profiles due to Bernoulli effects, and the total impact on lift. Reference **Leybold Lesson P1.8.6.3** in the "Additional Resources" at the end of this document for an example high-tech version of a similar lab. By observing the force generated from the pressure profile of the airfoil, and comparing it to total lift observed on an electronic balance, it becomes possible to see that the Bernoulli-based path-length explanation has very little effect on total lift.

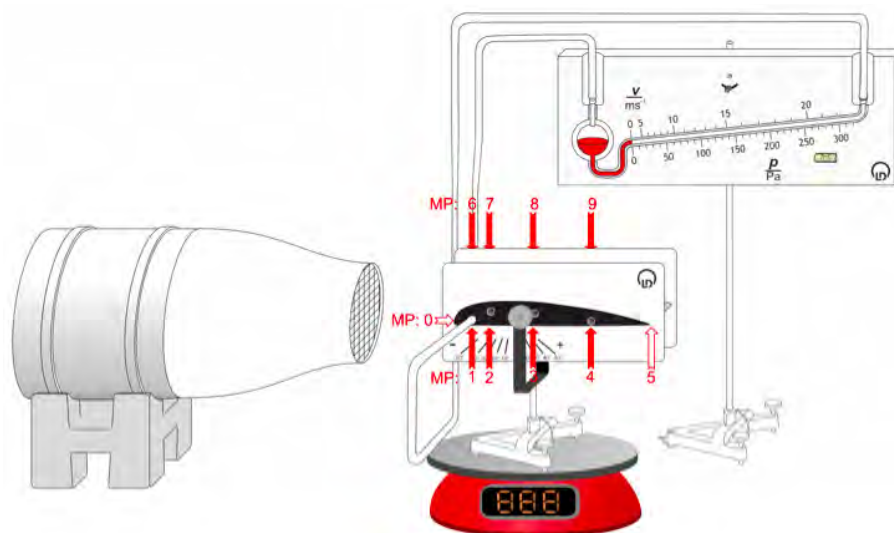

For the low-tech version:

To prepare a cambered airfoil, use a firm piece of cardboard and use a hole-puncher to make holes for the straws. To get a pressure profile for your cambered airfoil, pressure must be measured both above and below the airfoil at given chord thicknesses. (At least four straws should point "up," and four straws at the same chord thickness should be inserted and then inverted back down through the cardboard again. Clay can be used to form the airfoil to the desired shape. See the visual instructions below:

Prepare holes in the cardboard for the internal air fluid system. The images below show how the straws will look *inside* the clay airfoil.

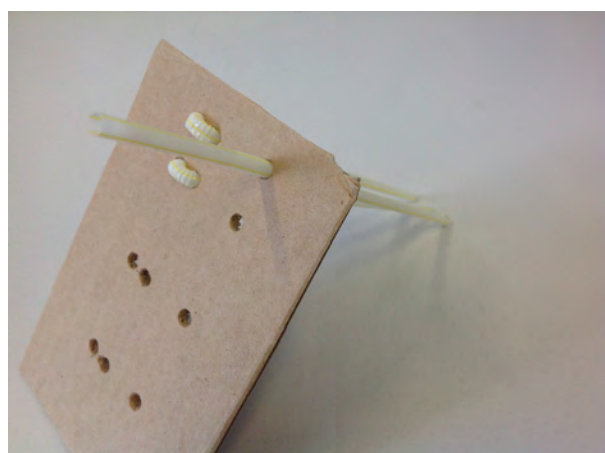

Form a cambered airfoil with clay. Remove the clay and insert the straws. Break the clay into pieces, as necessary, to form around the straws once they have been inserted.

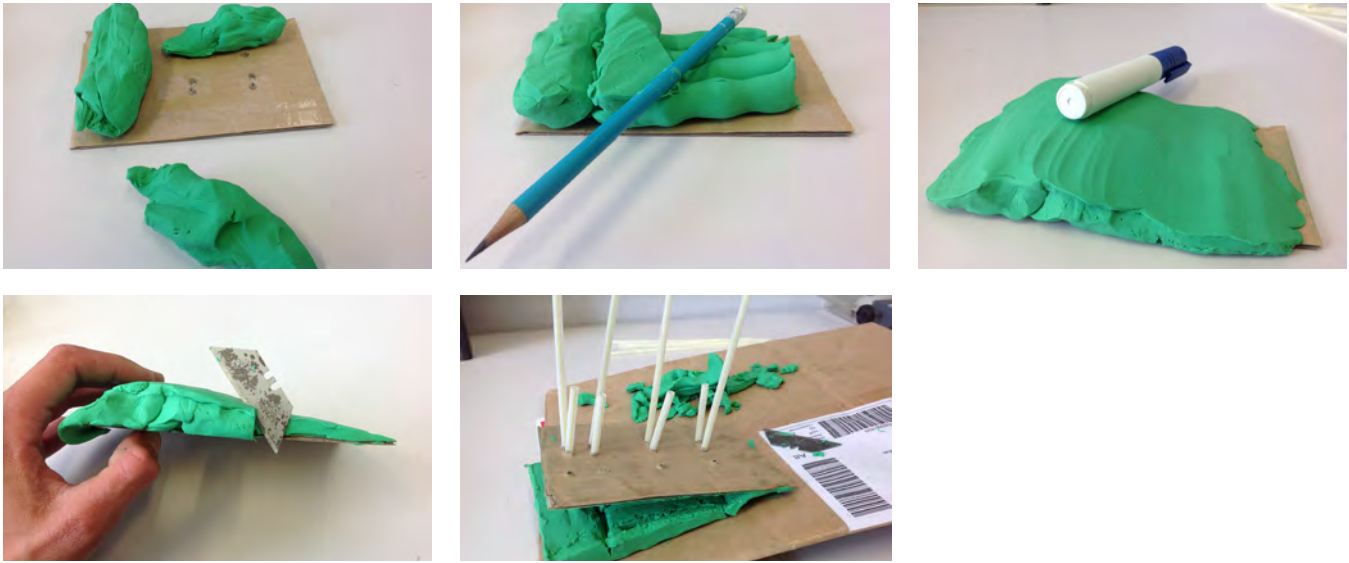

Top, Bottom, and Side Views:

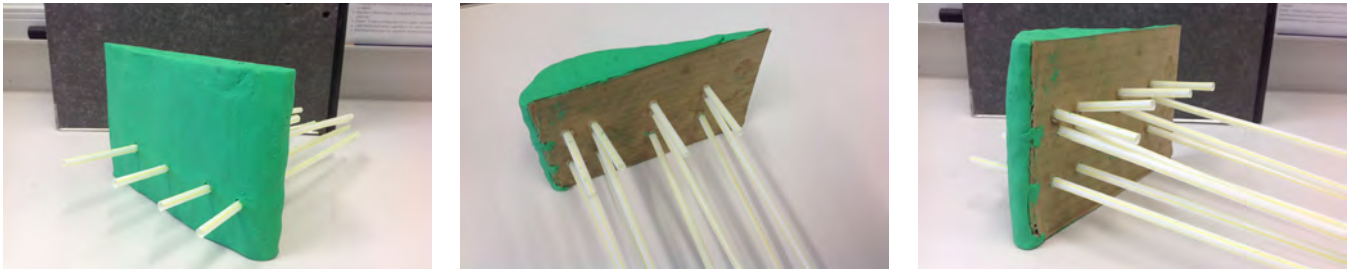

Insert at least two thin rods into the cardboard, and attach string to the front and back ends of the rods so that the airfoil can be supported from a ring stand. Cut off excess straws on the bottom and top of the airfoil.

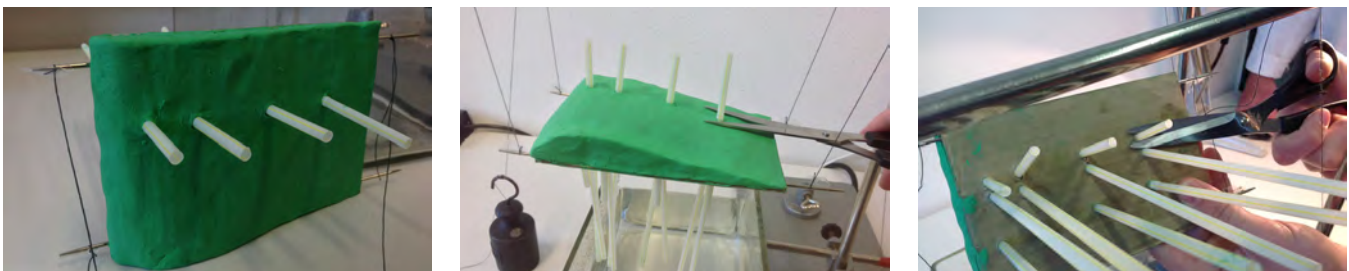

Prepare the reservoir filled with water and food coloring. Support the straws with an additional piece of cardboard just above the reservoir. Adjust the airfoil to the desired angle of attack.

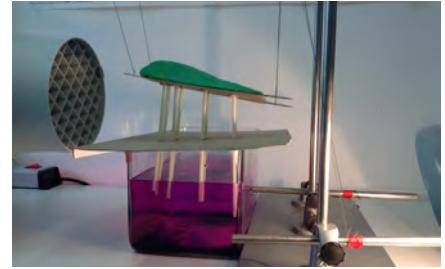
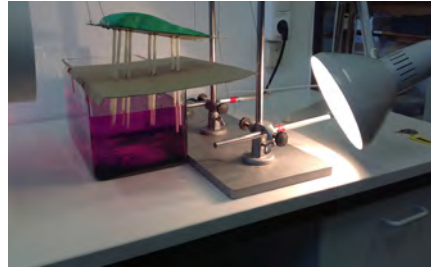

A more high-tech approach to this lab entails the use of an airfoil and precision manometer to measure actual pressures differences (in pascals, or Pa) and relative speed at individual points. Both lab materials and an accompanying lab manual (http://www.ld-didactic.de/documents/en-US/EXP/P/P1/P1863_e.pdf) can be acquired through Leybold.

Teacher Worksheet: Bernoulli Effect Lab



Objective: Qualitatively or quantitatively determine the pressure profiles of a cambered airfoil.

Observe differences in fluid height in each pressure tube when the wind source is provided at varying speeds.

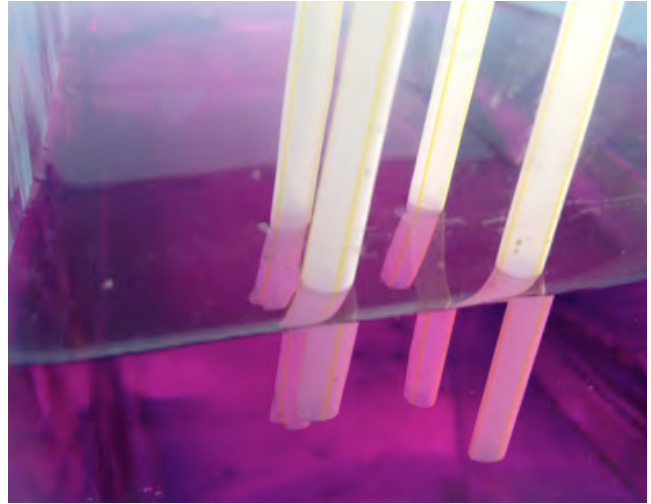

1. Choose one point along the airfoil's length. Compare the pressure above and below the airfoil. Which pressure is higher? Why do you think this is the case?

Pressures below the airfoil are typically much higher than the points directly above them at positive angles of attack. This is due to many reasons, but most

of them track back to the inertia of the air particles. However, the skipping stone analogy oversimplifies as much as the Venturi tube analogy. Most air particles are interacting with each other and very few hit the airfoil directly. Interfering effects might be:

- *Turbulence (especially for very small scaled models)*
- *The straws' holes might be so big that we CANNOT assume laminar flow around them.*



2. Prepare to collect data along all points of the airfoil, above and below. Feel free to investigate the effect of wind speed, water coloring, etc., on the visibility of pressure difference. Determine how you will collect data. Will it be qualitative or quantitative? Provide a rationale for how you will collect the most meaningful data.

Student responses will vary. Some differences in pressure could be measured with millimeters, although precision is likely to be low. Students might simply choose to rank pressure values, or use non-numeric symbols to represent relative pressures and pressure differences.



3. Decide what kind of set-up you will use to develop a pressure profile. Decide which three different variables you will change in the set-up to observe changes in the pressure profiles.



4. Using a single setting on your air source (large box fan, leaf blower, hair dryer, etc.), develop the pressure profiles for your airfoil. Be certain to record any constants.

Trial #1 Constants (list below):

Constants might include angle of attack, camber, air composition, and wind speed.

	Point 1	Point 2	Point 3	Point 4
Pressure Above				
Pressure Below				
Pressure Difference				

5. Choose to modify your setup in any way. (Consider camber thickness, angle of attack, wind speed, etc.). How does this change your pressure profile?

Trial #2 Constants (list below):

	Point 1	Point 2	Point 3	Point 4
Pressure Above				
Pressure Below				
Pressure Difference				

6. Again, choose to modify your setup in any way. (Consider camber thickness, angle of attack, wind speed, etc.). How does this change your pressure profile?

Trial #3 Constants (list below):

	Point 1	Point 2	Point 3	Point 4
Pressure Above				
Pressure Below				
Pressure Difference				



7. Share the results of your pressure profiles with your classmates. If appropriate, show your data as a chart or as a graph. Discuss how your results compare. If they are different, determine why.

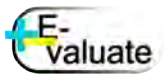
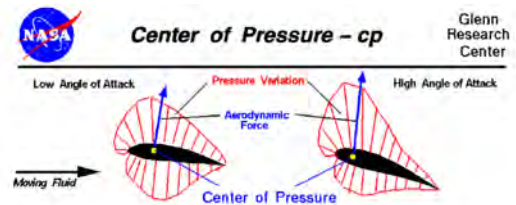

8. Share your results with your classmates. What conclusion(s) can you draw about the pressure differences above and below an airfoil? Provide a rationale for your conclusion.

*Typically, the pressure below a cambered airfoil is greater than above it. Data should support this. However, this is not true if the airfoil is pointed downward, or if the airfoil has an angle of attack of zero degrees **while** being symmetric.*

9. The image to the above right shows pressure profiles. Select ONE of your trials from above. Draw a sketch of your airfoil, and provide a qualitative sketch of the pressure profile above and below the airfoil at the four points you studied.

Student responses will vary.

10. Of your three trials, which airfoil or airfoil setup do you think would be most effective for achieving flight? Why?

Student responses will vary.

11. Look at a different kind of vertical pressure profile for the entire body of an aircraft. What direction is being measured as upward and downward pressure, and how do you know? Why do you think that some relative, static pressures are positive and why are some negative? Explain.

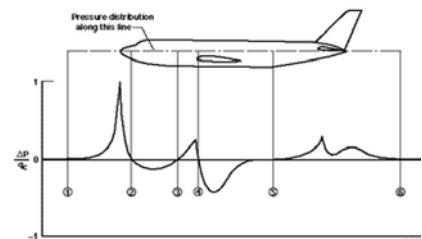

Pressure near the nose is very high because it is penetrating the air wall. Pressure must be high near the back of the plane as well to keep it balanced.

Student Worksheet: Bernoulli Effect Lab



Aim

Objective: Qualitatively or quantitatively determine the pressure profiles of a cambered airfoil.

Observe differences in fluid height in each pressure tube when the wind source is provided at varying speeds.

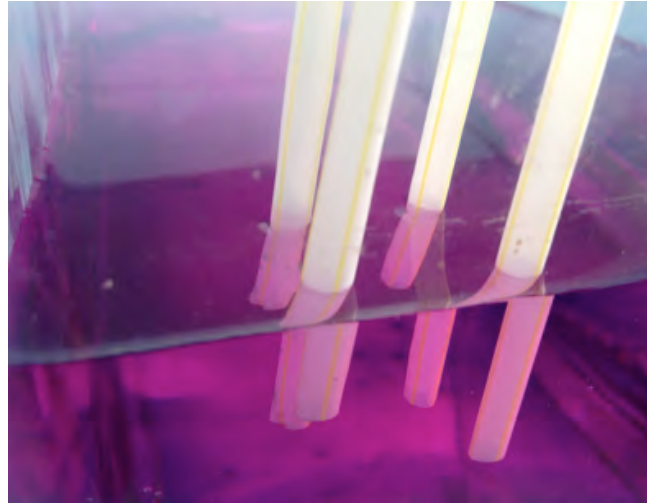

1. Choose one point along the airfoil's length. Compare the pressure above and below the airfoil. Which pressure is higher? Why do you think this is the case?



Plan

2. Prepare to collect data along all points of the airfoil, above and below. Feel free to investigate the effect of wind speed, water coloring, etc., on the visibility of pressure difference. Determine how you will collect data. Will it be qualitative or quantitative? Provide a rationale for how you will collect the most meaningful data.



Decide

3. Decide what kind of set-up you will use to develop a pressure profile. Decide which three variables you will modify in the set-up to observe changes in the pressure profiles.



Act

4. Using a single setting on your air source (large box fan, leaf blower, hair dryer, etc.), develop the pressure profiles for your airfoil. Be certain to record any constants.

Trial #1 Constants (list below):

	Point 1	Point 2	Point 3	Point 4
Pressure Above				
Pressure Below				
Pressure Difference				

5. Choose to modify your set-up in any way. (Consider camber thickness, angle of attack, wind speed, etc.). How does this change your pressure profile?

Trial #2 Constants (list below):

	Point 1	Point 2	Point 3	Point 4
Pressure Above				
Pressure Below				
Pressure Difference				

6. Again, choose to modify your set-up in any way. (Consider camber thickness, angle of attack, wind speed, etc.). How does this change your pressure profile?

Trial #2 Constants (list below):

	Point 1	Point 2	Point 3	Point 4
Pressure Above				
Pressure Below				
Pressure Difference				



7. Share the results of your pressure profiles with your classmates. If appropriate, show your data as a chart or as a graph. Discuss how your results compare. If they are different, determine why.

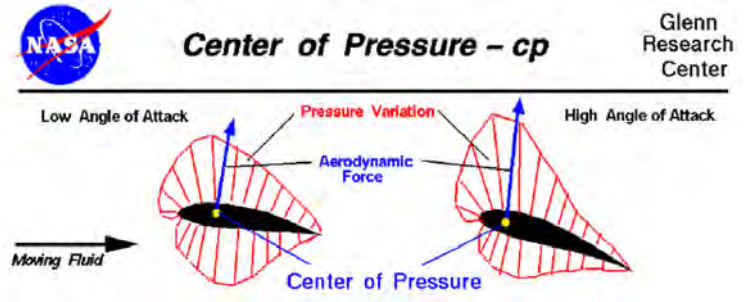

8. What conclusion(s) can you draw about the pressure differences above and below an airfoil? Provide a rationale for your conclusion.

9. The image to the above right shows pressure profiles. Select ONE of your trials from above. Draw a sketch of your airfoil, and provide a qualitative sketch of the pressure profile above and below the airfoil at the four points you studied.

10. Of your three trials, which airfoil or airfoil setup do you think would be most effective for achieving flight? Why?

11. Look at a different kind of vertical pressure profile for the entire body of an aircraft. What direction is being measured as upward and downward pressure, and how do you know? Why do you think that some relative, static pressures are positive and why are some negative? Explain.

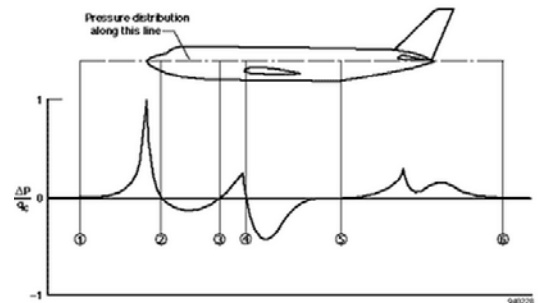

Problem Set: Bernoulli's Equation and Pitot-Static Tubes

from [Beginner's Guide to Aeronautics](#)

BACKGROUND

(Note: This background is most appropriate *after* students have been introduced to these concepts through constructivist and/or inquiry activities.)

In the 1700s, [Daniel Bernoulli](#) investigated the forces present in a moving [fluid](#). This slide shows one of many forms of **Bernoulli's equation**. The equation appears in many physics, fluid mechanics, and airplane textbooks. The equation states that the [static pressure](#) p_s in the flow plus the [dynamic pressure](#), one half of the density ρ times the velocity v squared, is equal to a constant throughout the flow. We call this constant the total pressure P_t of the flow.

As discussed on the [gas properties](#) page, there are two ways to look at a fluid; from the large, macroscale properties of the fluid that we can measure, and from the small, microscale of the molecular motion and interaction. On this page, we will consider Bernoulli's equation from both standpoints.

Macro Scale Derivation

[Thermodynamics](#) is the branch of science which describes the macro scale properties of a fluid. One of the principle results of the study of thermodynamics is the [conservation of energy](#); within a system, energy is neither created nor destroyed but may be converted from one form to another. We shall derive Bernoulli's equation by starting with the conservation of energy equation. The most general form for the conservation of energy is given on the [Navier-Stokes](#) equation page. This formula includes the effects of unsteady flows and [viscous](#) interactions. *Assuming a steady, inviscid flow* we have a simplified [conservation of energy](#) equation in terms of the [enthalpy](#) of the fluid:

$$h_{T2} = h_{T1} - q - W_{sh}$$

where h_T is the total enthalpy of the fluid (h_{T1} is the total enthalpy of the fluid **before**, and h_{T2} is the total enthalpy of the fluid **after**), q is the [heat transfer](#) into the fluid, and W_{sh} is the useful work done by the fluid.

Assuming no heat transfer into the fluid, and no work done by the fluid, we have:

$$h_{T2} = h_{T1}$$

From the definition of total enthalpy:

$$e_2 + (P * V)_2 + (\frac{1}{2} * v^2)_2 = e_1 + (P * V)_1 + (\frac{1}{2} * v^2)_1$$

where e is the [internal energy](#), P is the [pressure](#), V is the [specific volume](#), and v is the velocity of the fluid. From the [first law of thermodynamics](#) if there is no work and no heat transfer, the internal energy remains the same:

$$(P * V)_2 + (.5 * v^2)_2 = (P * V)_1 + (.5 * v^2)_1$$

The specific volume is the inverse of the fluid density ρ :

$$(P / \rho)_2 + (\frac{1}{2} * v^2)_2 = (P / \rho)_1 + (\frac{1}{2} * v^2)_1$$



Bernoulli's Equation

Glenn
Research
Center

Restrictions:

- Inviscid
- Steady
- Incompressible (low velocity)
- No heat addition.
- Negligible change in height.

Along a streamline:

static pressure + dynamic pressure = total pressure

$$p_s + \frac{\rho V^2}{2} = p_t$$

$$\left(p_s + \frac{\rho V^2}{2} \right)_1 = \left(p_s + \frac{\rho V^2}{2} \right)_2$$

p = Pressure
 V = Velocity
 ρ = Density

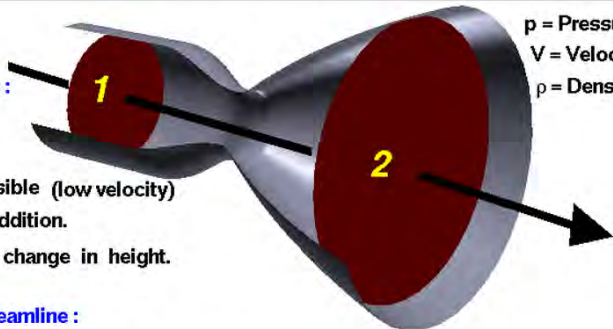

Assuming that the flow is incompressible, the density is a constant. Multiplying the energy equation by the constant density:

$$(P_{\text{static}})_2 + \left(\frac{1}{2} * v^2\right)_2 = (P_{\text{static}})_1 + \left(\frac{1}{2} * v^2\right)_1 = \text{a constant} = P_{\text{Total}}$$

This is the simplest form of Bernoulli's equation and the one most often quoted in textbooks. If we make different assumptions in the derivation, we can derive other forms of the equation.

It is important when applying any equation that you are aware of the restrictions on its use; the restrictions usually arise in the derivation of the equation when certain simplifying assumptions about the nature of the problem are made. If you ignore the restrictions, you may often get an incorrect answer from the equation. For instance, this form of the equation was derived while assuming that the flow was [incompressible](#), which means that the speed of the flow is much less than the speed of sound. If you use this form for a supersonic flow, the answer will be wrong.

Molecular Scale Derivation

We can make another interpretation of the equation by considering the [motion](#) of the gas molecules. The molecules within a fluid are in constant random motion, colliding with each other and with the walls of an object in the fluid. The motion of the molecules gives the molecules a linear momentum and the fluid [pressure](#) is a measure of this momentum. If a gas is at rest, all of the motion of the molecules is random and the pressure that we detect is the **total pressure** of the gas. If the gas is set in motion or flows, some of the random components of velocity are changed in favor of the directed motion. We call the directed motion "ordered," as opposed to the disordered random motion.

We can associate a pressure with the momentum of the ordered motion of the gas. We call this pressure the [dynamic pressure](#). The remaining random motion of the molecules still produces a pressure called the **static pressure**. At the molecular level, there is no distinction between random and ordered motion. Each molecule has a velocity in some direction until it collides with another molecule and the velocity is changed. But when you sum up all the velocities of all the molecules you will detect the ordered motion. From a conservation of energy and momentum standpoint, the static pressure plus the dynamic pressure is equal to the original total pressure in a flow (assuming we do not add or subtract energy in the flow). The form of the dynamic pressure is the density times the square of the velocity divided by two.

Applications of Bernoulli's Equation

The fluids problem shown on the image on the prior page is low speed flow through a tube with changing cross-sectional area. For a streamline along the center of the tube, the velocity decreases from station one to two. Bernoulli's equation describes the relation between velocity, density, and pressure for this flow problem. Since density is a constant for a low speed problem, the equation at the bottom of the slide relates the pressure and velocity at station two to the conditions at station one.

Along a low speed airfoil, the flow is incompressible and the density remains a constant. Bernoulli's equation then reduces to a simple relation between velocity and static pressure. The closest streamlines follow the surface of the airfoil. Since the velocity varies along the streamline, Bernoulli's equation can be used to compute the change in pressure. The static pressure integrated along the entire surface of the airfoil gives the total aerodynamic force on the foil. This force can be broken down into the lift and drag of the airfoil.

Bernoulli's equation is also used on aircraft to provide a speedometer called a pitot-static tube. A pressure is quite easy to measure with a mechanical device. In a pitot-static tube, we measure the static and total pressure and can then use Bernoulli's equation to compute the velocity.

Problem Set from Beginner's Guide to Aeronautics:

[Student Worksheet](#)

[Teacher Key](#)

Solve each problem. Make sure all units agree! (Note: For practical purposes, velocity is measured in KNOTS. One knot = 1.69 feet/second.)

1. Find the total air pressure detected by the pitot tube for a Cessna 182 airplane flying at a pressure altitude of 10,000 feet (static pressure of 1455.6 lb/ft²) and a speed of 120 knots if the air density is 0.00162 slugs/ft³.
2. Find the difference in pressure (pt-ps) for the same conditions described above if the airplane speeds up to 160 knots.
3. If the total air pressure for the same Cessna 182 is measured at 1478.7 lb/ft², what is the new velocity in knots of the airplane?



Discovery Lab: Airplane Dynamics: Engine Thrust, Braking, and Lift

Joe Pizzo. *The Physics Teacher* 26, 122 (1988).

Joe Pizzo describes the use of a modified two-dimension low-friction fan cart to demonstrate the effect of the Bernoulli principle on lift, as well as the effect of engine braking.

Objectives

Observe and model engine thrust, breaking, and lift.

Materials

Modified fan-cart
(moveable in three directions),
or water tray with floating
surfaces,
Dry ice
Balsa / foam airfoil
Aluminum flashing

NGSS

CDI HS-PS2-1
SEP 2, 3, 6
CCC 2, 5

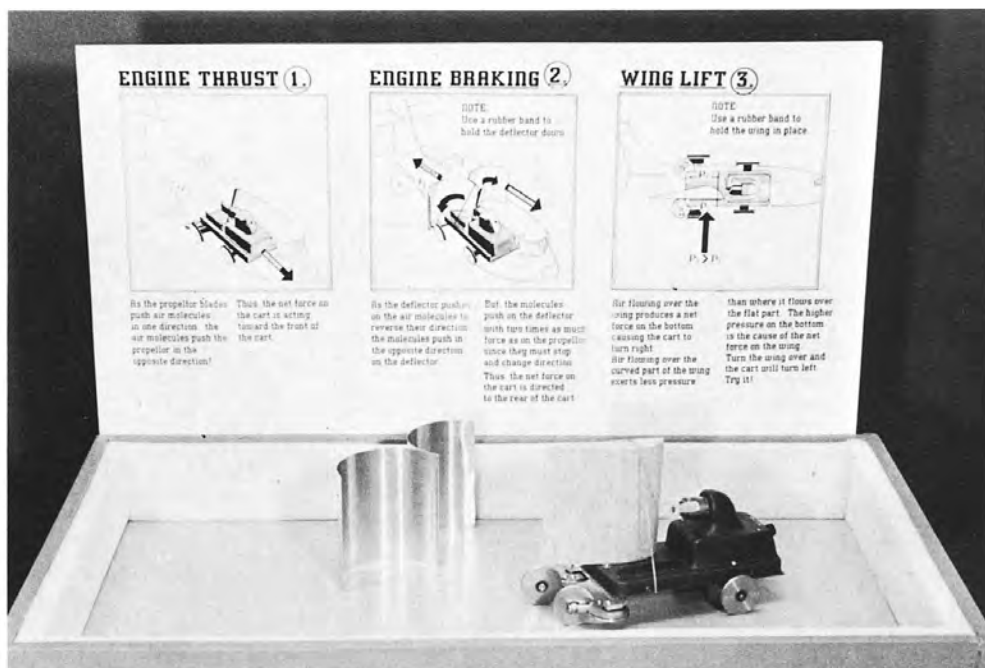

Fig. 1. A fan cart, with appropriate modifications, is used as an exploratory exhibit to demonstrate engine thrust, engine braking, and wing lift of an airplane.

A standard fan cart can be used to observe Activity #1 and Activity #2. Activity #3, however, requires the significant modification of the fan cart so that it can move in two dimensions. (This might be a great engineering challenge for students). Some options include mounting the fan onto a set of low-friction ball-bearings that can slide across the table top, placing it onto a piece of floating Styrofoam in a pool of water, using floating airfoils on a plate of oil, or balancing them on a small slab of dry ice while being blown on by a uniform air stream.

With a few simple instructions, students can modify the placement of airfoils in front of the fan cart, and allow

Activity #1 - Thrust: Students observe the effect of thrust on a low-friction cart. Students will notice that the cart will accelerate due to the constant net force.

Activity #2 – Engine Braking: Aluminum flashing or a cheap, thin aluminum cylinder can be split and then bent open to create model air brakes. As the air blows into the air brakes, the air is directed backwards, causing the cart to move in the same direction as the wind from the fan. CAUTION: The edges of aluminum flashing are very sharp! Use appropriate hand and eye protection when cutting or handling aluminum flashing.

Activity #3 – Lift (Bernoulli effects only): Students can fashion a cambered airfoil from Styrofoam or balsa wood. By placing a cambered airfoil with no angle of attack in front of a low-friction fan cart, students should observe the cart to move to be a net sideways force on the cart, causing it to move at an angle. Bernoulli is the primary effect only when angle of attack is zero, however. Even then, students will observe that effects from Bernoulli are a very small overall contributor to lift.



Fig. 3. When the deflector plates are used on the fan cart, airplane engine braking can be demonstrated.



Fig. 2. A rubber band is used to hold the airfoil-shaped wing section in place, allowing the orientation to be changed easily.



Uniform Acceleration



A joint project of
NASA Aeronautics
and the
American Association of
Physics Teachers





Literary/Data Analysis: Prepare for Landing

Gregory A. DiLisi and Richard A. Rarick. *The Physics Teacher*, 45, 300 (2007).

Objectives

Given the cruising speed of the plane, angle of descent, landing speed, and time until landing, compare the calculated angle of deflection to the actual measured angle of deflection.

Materials

Protractor or computer

NGSS

CDI HS-PS2
SEP 1, 2, 4, 5, 7
CCC 3, 4

The authors of the article *Prepare for Landing* decided to make a quick analysis of their plane's motion on their descent into their destination airport on an Airbus A320. A crude accelerometer was constructed by hanging a homemade pendulum bob on the surface of the window. (Note: This activity requires the use of a worksheet based upon an in-air problem while flying. Students should not be requested to complete a similar in-flight experience without the consent of the airline attendants).

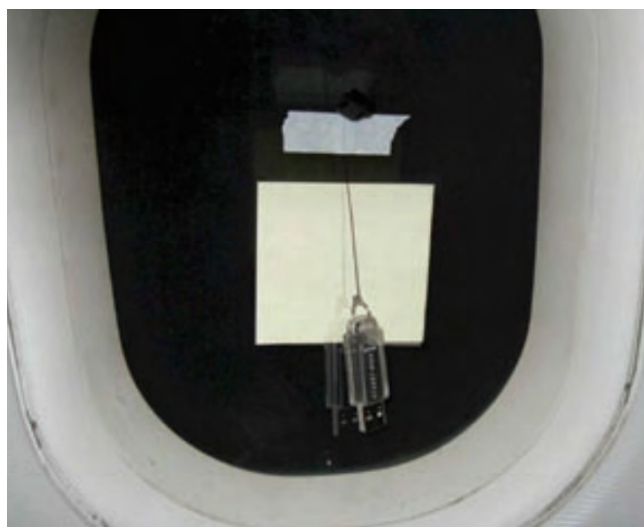

This activity is a “contextualized verification problem,” in which students are asked to compare the actual angle of a pendulum bob during a constant acceleration descent to the theoretically calculated angle of a pendulum bob. Two images can be seen superimposed upon one another: the angle of the pendulum while in the final stages of descent, exactly **eight minutes** before touchdown, and the angle of the pendulum while at rest on the ground. This angle can be fairly easily measured and compared to the estimated angle based upon the Airbus A320's spec sheet for a typical landing.

Teacher Answer Key: Prepare for Landing

A passenger in an Airbus A320 takes a photograph of a pendulum bob suspended from a window during the constant acceleration of the final descent of an airplane, as well as when the airplane is at rest. The pilot of the aircraft announces that the final descent has begun, and that the plane will land in exactly **eight minutes**.

Based upon the specifications offered for the Airbus A320 at cruising altitude, descent, and landing, answer the following questions in order to theoretically estimate the angle measured by the passenger.



	Cruising Speed	Descent Angle of Attack	Landing Speed
Airbus A320 Spec's	525-575 mi/hr		135-155 mi/hr
Average estimates for this problem	550 mi/hr	3.3°	145 mi/hr

1. What two factors would influence the angle of the pendulum recorded during the constant acceleration and descent of the airplane?

The angle of attack of the airplane, as well as the “down-and-forward” acceleration of the airplane’s propulsion system.

2. Assuming an average estimate of the cruising speed, calculate the **horizontal** acceleration of the plane from the beginning of its final descent to its landing.

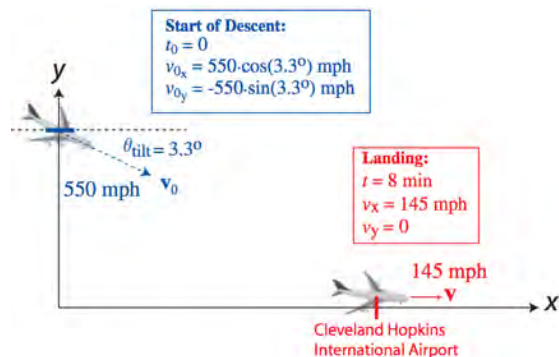

$$a_x = \frac{v_x - v_{x_0}}{t} = \frac{\left(145 \frac{\text{mi}}{\text{hr}}\right) - (550 (\cos 3.3) \text{ mi/hr})}{\left(\frac{8}{60} \text{ hr}\right)} = -3030 (\text{mi/hr})/\text{hr}$$

3. Calculate the **vertical** acceleration of the plane from the beginning of its descent to its landing.

$$a_y = \frac{v_y - v_{y_0}}{t} = \frac{(0) - (550 (\sin 3.3) \text{ mi/hr})}{\left(\frac{8}{60} \text{ hr}\right)} = 240 (\text{mi/hr})/\text{hr}$$

4. Consider that the pendulum bob is *inside* an airplane that is accelerating. Draw a **force diagram** for the pendulum bob, using the airplane as the “flat” frame of reference.

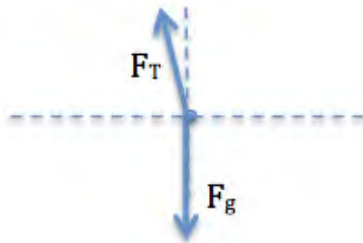

The angle of the tension force is a sum of both the angle of attack (which we assume to be 3.3, according to the Airbus A320’s specifications), and the “down-and-to-the-right” acceleration of the plane’s propulsion system.



5. Now, draw an **acceleration vector diagram** for the pendulum bob. Again, use the airplane as the “flat” frame of reference, and neglect the angle of attack in your frame of reference.

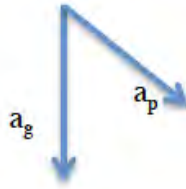

6. Break up the plane’s acceleration vector into its components. (Note: The original article suggests the use of “pseudoforces” for solving this problem. For younger students, an approach with acceleration vectors is likely more appropriate).

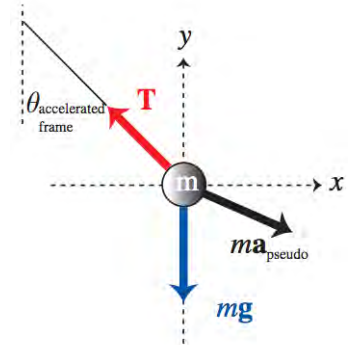
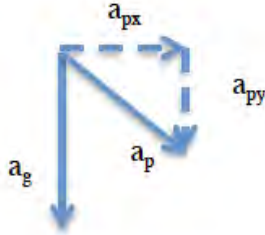

7. Using vector addition, graphically demonstrate how these acceleration vectors can be summed. Draw in the resultant acceleration.



8. Calculate the angle between the two acceleration vector components caused by the *Earth* and due to the *airplane*.

$$\tan \theta = \frac{a_x}{g + a_y}$$

$$\theta = \tan^{-1} \frac{3030 \text{ (mi/hr)/hr}}{((78,900 \text{ (mi/hr)/hr}) + (240 \text{ (mi/hr/hr)}))} = 2.2^\circ$$

9. Calculate the sum total theoretical angle of deflection of the pendulum due to the angle of attack of the airplane as well as the accelerated frame of reference.

$$\theta_{total} = \theta_{attack} + \theta_{inertial \text{ frame}} = 3.3^\circ + 2.2^\circ = 5.5^\circ$$

10. Compare the theoretical angle of deflection of the pendulum to the actual angle of deflection from the image below:

The angle cited by the author, using MS WORD’s “Format Autoshape” function to create a right triangle and to measure the lengths, resulted in a measured deflection of $5.9^\circ \pm 0.9^\circ$.



Prepare for Landing: Student Worksheet

A passenger in an Airbus A320 takes a photograph of a pendulum bob suspended from a window during the constant acceleration of the final descent of an airplane, as well as when the airplane is at rest. The pilot of the aircraft announces that the final descent has begun, and that the plane will land in exactly **eight minutes**.

Based upon the specifications offered for the Airbus A320 at cruising altitude, descent, and landing, answer the following questions to theoretically estimate the angle of the pendulum eight minutes before landing, as measured by the passenger.

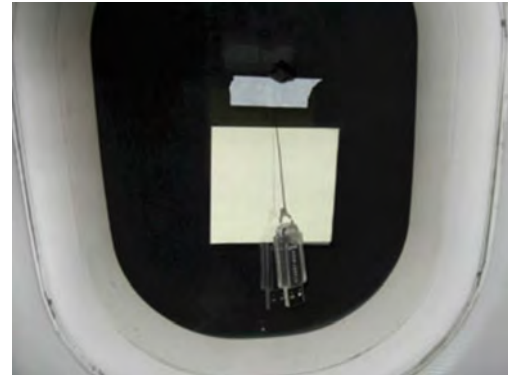

	Cruising Speed	Descent Angle of Attack	Landing Speed
Airbus A320 Spec's	525-575 mi/hr		135-155 mi/hr
Average estimates for this problem	550 mi/hr	3.3°	145 mi/hr

1. What two factors would influence the angle of the pendulum recorded during the constant acceleration and descent of the airplane?

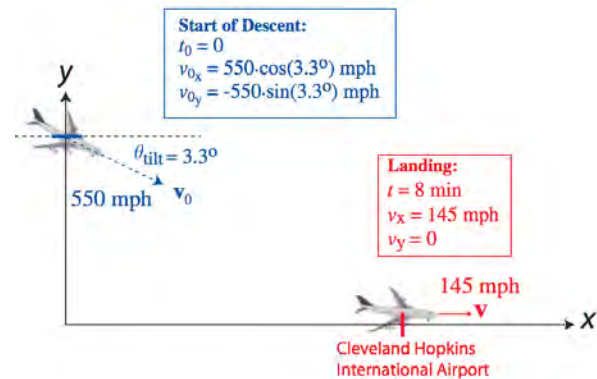

2. Assuming an average estimate of the cruising speed, calculate the **horizontal** acceleration of the plane from the beginning of its final descent to its landing.
3. Calculate the **vertical** acceleration of the plane from the beginning of its descent to its landing.
4. Consider that the pendulum bob is *inside* an airplane that is accelerating. Draw a **force diagram** for the pendulum bob, using the airplane as the “flat” frame of reference.

The angle of the tension force is a sum of both the angle of attack (which we assume to be 3.3, according to the Airbus A320’s specifications), and the “down-and-to-the-right” acceleration of the plane’s propulsion system.



5. Now, draw an **acceleration vector diagram** for the pendulum bob. Again, use the airplane as the “flat” frame of reference, and neglect the angle of attack in your frame of reference.

6. Break up the plane’s acceleration vector into its components.

7. Using vector addition, graphically demonstrate how these acceleration vectors can be summed. Draw in the resultant acceleration.

8. Calculate the angle between the two acceleration vector components caused by the *Earth* and due to the *airplane*.

9. Calculate the sum total theoretical angle of deflection of the pendulum due to the tilt of the airplane as well as the accelerated frame of reference.

10. Compare the theoretical angle of deflection of the pendulum to the actual angle of deflection from the image below:





Shhhh! Keep it Down Please!

http://www.nasa.gov/topics/aeronautics/features/aircraft_noise.html#.VHOhCI29-Rg

Analysis Questions:

- *Takeoff and landing are often the noisiest part of flight. Based on the article you read, why is this the case?*
- *Why is aircraft noise a problem?*
- *The article mentioned N+1, and N+2 aircraft. How will N+1 aircraft be different from what we have today? How will N+2 aircraft be even further improved?*
- *What are some additional ideas about ways you think noise reduction can be improved?*



Objectives

Analyze data for acceleration of an airplane.

Materials

Mobile devices with accelerometer apps, example data

NGSS

CDI HS-PS2-1
SEP 1-7
CCC 2, 7

Application Lesson/Lab: Mobile Accelerometers

The advent of mobile devices, such as tablets and smartphones, allow for a wide array of data collection and analysis opportunities. Ideally, students can collect their own data during an airplane ride in order to make a variety of qualitative and quantitative analyses. (Note: Please remind students that they must always follow FAA and local regulations regarding the use of mobile devices in airplanes, especially during takeoff and landing.) This overview will provide the teacher with some sample data and questions that could be proposed to students.

There are a number of apps from iOS and Android marketplaces that allow mobile devices to display and record linear acceleration and/or g-force. (g-force is the ratio of the strength of acceleration felt compared to acceleration due to gravity, also represented as a/g or F_N/F_g . A thorough discussion of this concept should be undertaken before attempting to use such data).

In order to understand how accelerometers in mobile devices work, have students complete the following activities.

Teacher Answer Key: Mobile Accelerometers

- Download and open an accelerometer app on your device. For the purposes of this activity, Android's "Physics Toolbox Accelerometer" is used, but there are many available apps for iPhone and Android that display acceleration and g-forces.
- Click on the "Acceleration" button in the top menu -- this will change your graph reading from g-force to linear acceleration. You should now have a graph that reads acceleration versus time.
- Lay your device flat on the table. What value do all of the x, y, and z accelerations read? Why?

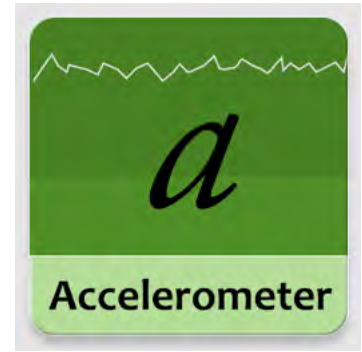

They all read zero. If the device is not moving (no matter where it is placed), then accelerations in all dimensions will read zero.

- Try shaking your device in all three dimensions. Identify which dimensions are x, y, and z, and label them as such. Also, identify which directions are positive and negative.

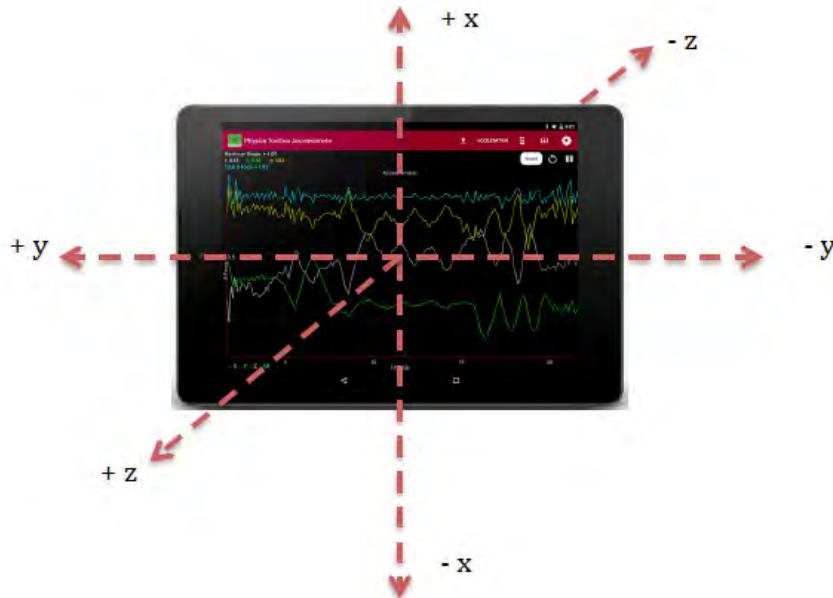

- Pick up your device, still holding it perpendicular to the floor so you can see the screen. Choose ONE dimension, and jump! Record what the acceleration graph looks like for that dimension only. Label the MAX and MIN acceleration for each peak. Avoid putting any data that is irrelevant to the jump.

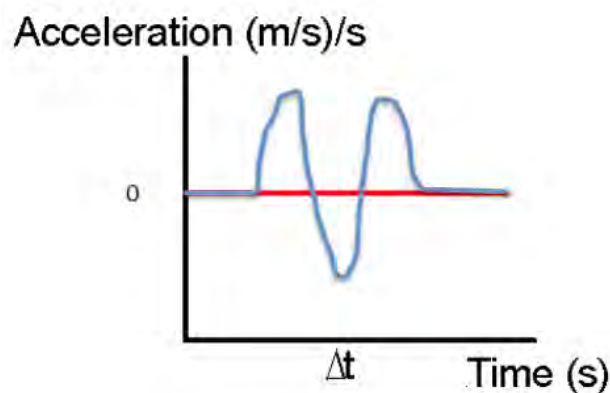

6. You should have 2 maxima, and 1 minima. Explain what is happening at each of these points:

1st Max: *This is the acceleration of the initial jump. This first peak is being recorded as the person is pushing off of the ground (while in contact with it).*

Min: *This is the acceleration due to gravity – and it should be somewhere around -9.8 (m/s)/s, which occurs while the person is in free fall (from the moment the feet come off of the floor, and then just before touching the ground again).*

2nd Max: *This is the acceleration of the “land.”*

7. Determine the mass of your mobile device (or of your body) to find out the net force that is acting to cause these accelerations...if you are already familiar with Newton’s second law of motion.

1st Max: $F_{net} = ma$. *Once students determine the mass of the object of their choosing (device or body, in kg), they can simply multiply it times the max and min values of the acceleration displayed on the graph.*

Min:

2nd Max:

8. Now, go back and forth between the “accelerometer” and “g-force” settings. G-force is a measure of how many times stronger you feel a force acting on you, as compared to the pull of gravity on your body. Hence, a g-force of one is equal to your weight, while a g-force of two means that you feel twice as heavy. A zero g-force means that you feel weightless. (However, near the surface of the earth, your weight doesn’t actually change at all).

Now that you know how to understand accelerometer graphs, try to make sense of the following set of data, recorded while in an aircraft.

9. Which way was the face of the mobile device oriented in the recorder’s hands? How do you know?

The device must have been lying flat with the face up, because the g-force is positive in the z-direction.

10. What is the average g-force acting in each dimension? (Why does one dimension always appear to hover around 1g?)

Initially, the g-force in the z-direction was +1, which would be expected, because we feel our weight in the vertical direction. The other two directions have a g-force around zero, initially, because there is no “weight” experienced in either of those directions.

11. Assuming that the recorder placed the device on his/her lap in such a way that it could be correctly viewed, is this a graph of takeoff or landing? How do you know?

Takeoff. The recorder is experiencing a force from back to front, or “forward-moving.” Also, there appears to be a “blip” later in the z-direction just above +1 g-force, suggesting that the recorder feels “heavy.” This would only be expected as the plane accelerates upward.

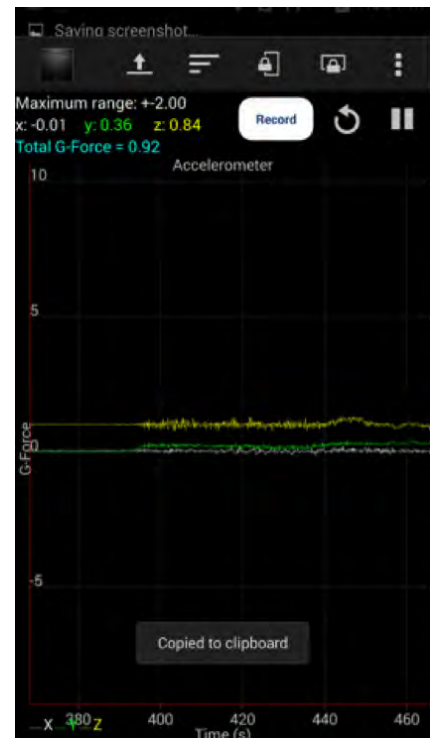

Student Worksheet: Mobile Accelerometers

Objective: Analyze data for acceleration of an airplane.

1. Download and open an accelerometer app on your device. For the purposes of this activity, we will look at Android's "Physics Toolbox Accelerometer," but there are many available apps for iPhone and Android that display acceleration and g-forces.
2. Click on the "Acceleration" button in the top menu – this will change your graph reading from g-force to linear acceleration. You should now have a graph that reads acceleration versus time.
3. Lay your device flat on the table. What value do all of the x, y, and z accelerations read? Why?

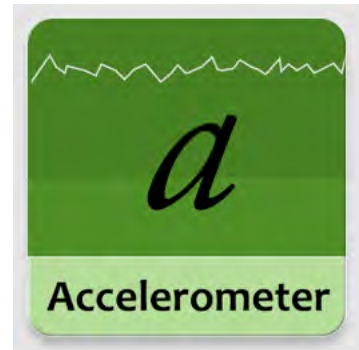

4. Try shaking your device in all three dimensions. Identify which dimensions are x, y, and z, and label them as such. Also, identify which directions are positive and negative.



5. Choose ONE dimension, and jump! Record what the acceleration graph looks like for that dimension only. Label the MAX and MIN acceleration for each peak. Avoid putting any data that is irrelevant to the jump.

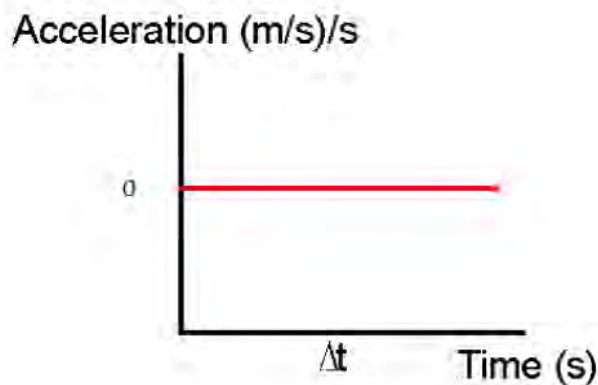

6. You should have 2 maxima, and 1 minima. Explain what is happening at each of these points:

1st Max:

Min:

2nd Max:

7. Determine the mass of your mobile device (or of your body) to find out the net force that is acting to cause these accelerations...if you are already familiar with Newton's second law of motion.

1st Max:

Min:

2nd Max:

8. Now, go back and forth between the "accelerometer" and "g-force" settings. G-force is a measure of how many times stronger you feel a force acting on you, as compared to the pull of gravity on your body. Hence, a g-force of one is equal to your weight, while a g-force of two means that you feel twice as heavy. A zero g-force means that you feel weightless. (However, near the surface of the Earth, your weight doesn't actually change at all).

Now that you know how to understand accelerometer graphs, try to make sense of the following set of data, recorded while in an aircraft.

9. Which way was the face of the mobile device oriented in the recorder's hands? How do you know?

10. What is the average g-force acting in each dimension? (Why does one dimension always appear to hover around one g?)

11. Assuming that the recorded placed the device on his/her lap in such a way that it could be correctly viewed, is this a graph of takeoff or landing? How do you know?

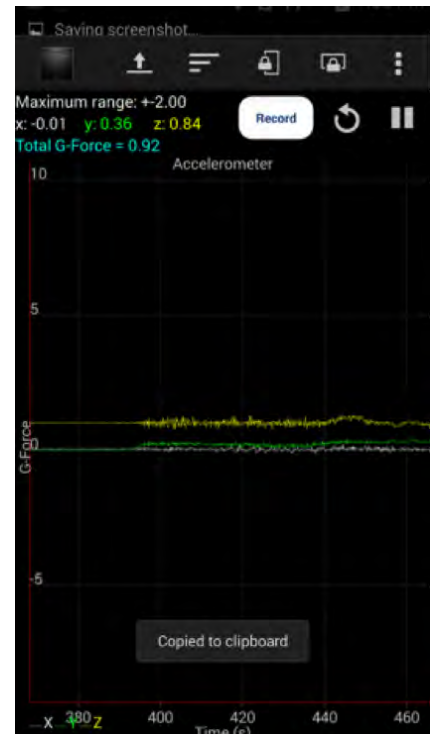



NASA-Pioneered Automatic Ground-Collision Avoidance System Operational

http://www.nasa.gov/centers/armstrong/Features/Auto-GCAS_Installed_in_USAF_F-16s.html#.VHS6So29-Rg

Analysis Questions:

- *What is the purpose of Automatic Ground-Collision Avoidance systems?*
- *Considering your understanding of acceleration, propose an hypothesis for how an airplane's computer determines the time before impact with the ground.*
- *In this particular bit of NASA research, an Android smartphone was used. What kinds of sensors on an Android smartphone might provide information about altitude and location?*



Terminal Velocity



A joint project of
NASA Aeronautics
and the
American Association of
Physics Teachers





Objectives

Identify the variables that influence the drag and time of fall on various objects.

Materials

Electronic balance
Steel balls
Small metal BBS
Large ball bearings
Carpet
Coins of different masses,
Baseball,
Clay or dough,
Meter stick,
Motion detector,
Photogate,
Picket fence,
Regular coffee filters,
Industrial-sized coffee filters
(or muffin/candy cups),
Test tubes or graduated
cylinder filled with water,
soap, etc., small masses,
Pipette (optional),
Cup of water (optional)

NGSS

CDI HS-PS2
SEP 3, 4, 6, 7
CCC 2, 6

Discovery Lab (Raw): Drag Stations Lab

Terminal velocity is something that most students associate with parachutes and other falling objects – not airplanes. However, a study of terminal velocity helps students to understand the difference between objects in idealized, frictionless environments, and objects that are significantly influenced by drag, as is the case of flight. The majority of students believe that, *under all circumstances*, heavier objects fall more quickly than lighter objects. In contrast, students are often erroneously taught in school that *all objects fall at the same rate*.

This discovery lab should first be initiated with a classic interactive demonstration dealing with two similarly-shaped and similarly-sized, aerodynamic objects (such as balls), but with significantly different masses. Ask students to predict which object will hit the ground first. Demonstrate that the difference is negligible, and ask them to keep the demonstration in mind as they work through the Drag Stations Lab.

Following the stations lab, ask students to again return to the demonstration of the two aerodynamic objects (the balls) that appeared to land at the same time. Students should quickly recognize that this is not a “law” that holds true under all circumstances. Aerodynamic effects, such as fluid viscosity, shape, size, and mass all influence the rate of fall *when there is drag*. In contrast, *when drag is negligible*, none of these factors have any effect on the fall times, and objects only continue to keep falling faster.

This activity is particularly important with regard to a discussion of air friction present in the atmosphere. Air density, pressure, and temperature all change in various layers of the atmosphere. As a result, the design of flying aircraft must be different when considering flight at differing altitudes or climatic conditions. In particular, airplane design becomes critical when considering hypersonic or supersonic flight near the edge of the Earth’s atmosphere, or in planes that actually enter into space.

Teacher Answer Key: Drag Stations Lab

Station 1: Mass

Provide **two aerodynamic objects** of the same size and shape, but of significantly different densities. If possible, acquire a large steel ball bearing and an equivalent-sized sports ball, bouncy ball, ball of cork, etc. Ensure that both of the objects accelerate at about the same rate. If heavy steel balls are used, designate a “fall area” on the ground and ensure that students keep their body parts away from that area, and remind students that even heavy balls can rebound and cause injury. Also, protect the floor from collision by padding it with a piece of **carpet** or a **towel**.

Alternatively, have students use **coins** of significantly different masses and drop them instead. Students can do this more efficiently by using a **ruler** to push the coins off of the edge of a table at the same time.

1. Have the same person hold a steel ball and the baseball in one hand. Drop them carefully onto a protected, padded surface. What do you notice about their fall times?

Students should notice that their fall times are approximately the same. (Encourage students to do this with both of their hands, as using two people to do this activity often results in different fall times).

2. Does your observation agree with what you have experienced outside of the classroom? Explain.

Not necessarily. Really lightweight like feathers or leaves don't fall at the same rate as heavy objects.

Station 2: Velocity and Time

Place a large piece of **modeling clay or dough** on the table. Have students flatten the dough into a thick pancake so that it can accurately record the impressions from ball bearings dropped onto it. Provide students with at least one **ball bearing** and a **meter stick**.

1. Hold a steel ball 20 centimeters (cm) above the clay and drop it. Do the same thing again, but at a height of 80 centimeters. Which height resulted in the deepest dent?

The ball at 20 cm made a much smaller dent than the ball dropped from 80 cm. (For more advanced students, consider having students measure the volume of the dents. Using non-permeable clay, have students fill the dents with water, counting the drops as an approximately uniform unit volume. Place a drop of soap into the water to release surface tension. Ask students to compare: How does quadrupling the height affect the volume of the dent? Why?)

2. What factors influence the depth of the dents? (Consider that the balls used each time had the same mass). Explain why the dents had different depths.

Balls released from a higher point end up having a greater final velocity than balls released from a lower point. This is because the higher ball has more time to speed up on its way down.

Station 3: Motion Detector

Provide students with a computer-based **motion detector**, **graphical analysis program**, and a **large ball** (ideally, basketballs or similarly-sized balls are best for motion detection). Ask students to collect velocity-time graph data and to determine the acceleration due to gravity. Students can accomplish this by taking the slope of the velocity-time graph. Caution students to always place the motion detector above the ball (so as to avoid crushing it), and to only get the slope of the relevant portion of the graph.

1. Hold the motion detector *above* the suspended basketball. Determine the acceleration of the basketball as it falls using the velocity graph.

$Acc = \underline{\hspace{2cm}}$ (The value should be somewhere around 9.8 m/s/s, although it might be less for balls with great surface areas).

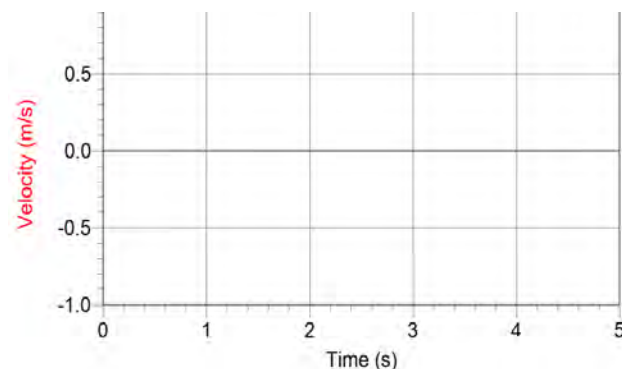

- Explain how you accomplished this.

Students should find the linear portion of the velocity graph, and use the computer program to get the slope of that region.

Station 4: Photogate

Provide students with a **photogate**, **graphical analysis program**, and traditional **“picket fence”** made of alternating clear and opaque segments. Typical graphical analysis programs with photogate sensors will automatically recognize picket fence data (ensure that the settings on the program for the spacings between the opaque segments are correct). This will provide students with a velocity-time graph, which can be used to get a slope to determine acceleration.

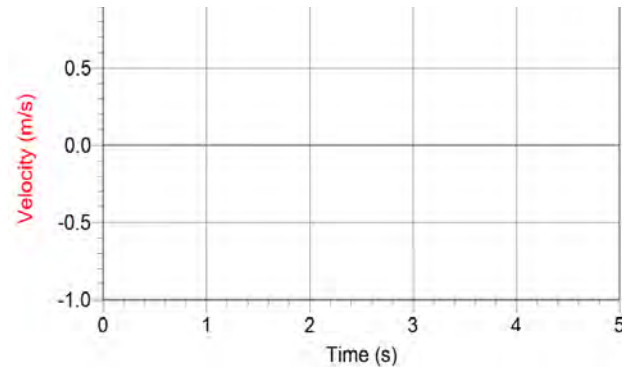

- Determine the acceleration of the picket fence as it falls through the photogate.

$Acc = \underline{\hspace{2cm}}$ (The value should be somewhere around 9.8 (m/s)/s).

- Explain how you accomplished this.

Students should find the linear portion of the velocity graph, and use the computer program to get the slope of that region.

Station 5: Drag Test: Shape

Provide students with multiple **coffee filters** that can be formed into a variety of shapes.

- Drop a single coffee filter from shoulder height. What do you notice about its speed on the way down?

The coffee filter appears to reach a terminal (steady) velocity.

- Take another coffee filter and change its shape. Explain how its falling speed compares to a regular coffee filter.



The coffee filter that has been modified will likely either continue to accelerate, or will achieve a higher terminal velocity than the regular coffee filter.

Station 6: Drag Test: Size

Provide students with **regular and industrial sized coffee filters**. If industrial sized coffee filters are not available, consider having students use similarly-shaped objects (such as **peanut butter cup papers**, **muffin cup papers**, etc.), or allowing students to modify regular coffee filters to get new filters with the different sizes but same shape. Caution students that no matter how size is modified for objects of the same shape, that all mass must be accounted for and equal between the two objects in question. Provide students with an **electronic balance**, if appropriate. For example, if using an industrialized coffee filter, students should compare it to a stack of joined coffee filters that make up the same mass as the industrialized coffee filter.

- Drop a set of regular coffee filters (having the same mass as the industrial sized coffee filter) and one industrial sized coffee filter. (If you are using muffin or candy paper cups instead of an industrial coffee filter, make sure you use several of the smaller objects stacked together to equal the mass of the larger filter). What is the relationship between size and falling speed?

The industrial sized (larger) coffee filter falls much more slowly than the smaller coffee filters of equivalent mass.

- Explain *why* their falling speeds are different.

The larger coffee filter has a greater surface area, so it comes into contact with more air particles, resulting in more drag.

Station 7: Drag Test: Mass

Provide students with **sets of coffee filters** in groups of 1, 3, and 9.

1. Drop the following: 1 coffee filter, 3 coffee filters, and 9 coffee filters. What do you notice about their falling speeds?

The more massive sets of coffee filters fall much faster than the single coffee filter.

2. Explain how this situation is different from the two balls at Station 1.

The two balls are aerodynamic (it is easy for the air particles to move around them, because of their shape), while the coffee filters have a large surface area and tend to “capture” the air more, resulting in greater friction.



Station 8: Drag Test: Viscosity

Provide students with at least two **large test tubes** filled separately with **water and soap** (or, different concentrations of water-soap mixture). Place a single **metal BB/ small ball bearing** into each test tube, and seal with a **rubber stopper**. Allow students to observe the ball bearing as it falls through each test tube as they invert it. If necessary, use adjust the concentrations of water/soap mixture, as too much water might result in a ball bearing that falls too quickly to observe, and pure soap might result in a ball bearing that falls too slowly to observe. In addition, if you are using glass test tubes, caution your students to handle the tubes and ball bearings carefully so they don't break the glass with the ball bearing. Ideally, use metal BBs with as small a diameter as possible.

1. Watch the metal ball as it falls down the length of the test tubes filled with water or soap. Compare the time it takes for a ball bearing to fall through each liquid.

The ball bearing takes much less time to fall through thin liquids than through thick liquids.

2. How does this demonstration relate to objects falling through the air?

The air also has a “thickness” associated with it. Especially at high speeds, drag becomes a significant factor and impacts the object's motion.

Summary Questions

1. When objects fall, what happens to their velocities?

Most of the time, velocities will increase – at least initially – and then either continue to increase, in the absence of drag, or attain its maximum speed – terminal velocity.

2. Under what atmospheric circumstances do size, shape, and mass have an impact on falling speed? Explain.

Whenever there is air friction.

3. Under what atmospheric circumstances do size, shape, and mass NOT have an impact on falling speed? Explain.

Whenever there is NO air friction, and, as a result, no drag.

Student Worksheet: Drag Stations Lab

Station 1: Mass

1. Have the same person hold a steel ball and the baseball in one hand. Drop them carefully onto a protected, padded surface. What do you notice about their fall times?

2. Does your observation agree with what you have experienced outside of the classroom? Explain.

Station 2: Velocity and Time

1. Hold a steel ball 20 centimeters above the clay and drop it. Do the same thing again, but at a height of 80 centimeters. Which height resulted in the deepest dent?

2. What factors influence the depth of the dents? (Consider that the balls used each time had the same mass). Explain why the dents had different depths.

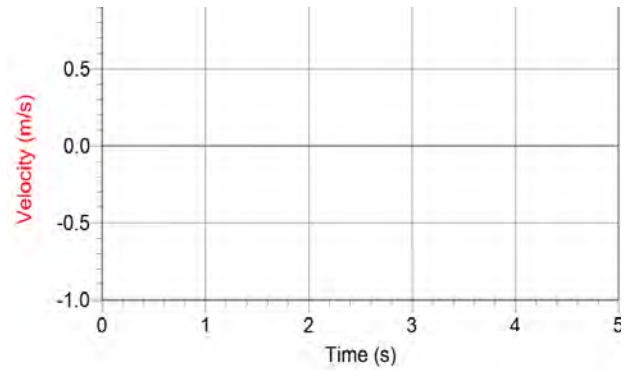

Station 3: Motion Detector

1. Hold the motion detector *above* the suspended basketball. Determine the acceleration of the basketball as it falls using the velocity graph.

$Acc =$

2. Explain how you accomplished this.

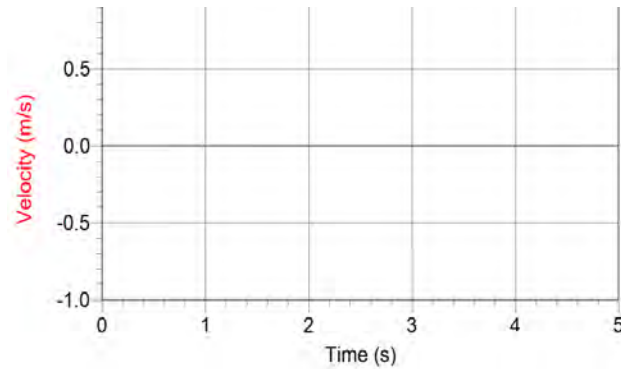

Station 4: Photogate

1. Determine the acceleration of the picket fence as it falls through the photogate.

$Acc =$

2. Explain how you accomplished this.

Station 5: Drag Test: Shape

1. Drop a single coffee filter from shoulder height. What do you notice about its speed on the way down?



2. Take another coffee filter and change its shape. Explain how its falling speed compares to a regular coffee filter.

Station 6: Drag Test: Size

1. Drop a set of regular coffee filters (having the same mass as the industrial sized coffee filter) and one industrial size coffee filter. If you are using muffin or candy cups instead of the industrial coffee filter, make sure you use several of the smaller objects stacked together to equal the mass of the larger filter. What is the relationship between size and falling speed?

2. Explain *why* their falling speeds are different.

Station 7: Drag Test: Mass

1. Drop the following: 1 coffee filter, 3 coffee filters, and 9 coffee filters. What do you notice about their falling speeds?
2. Explain how this situation is different from the two balls at Station 1.



Station 8: Drag Test: Viscosity

1. Watch the metal ball as it falls down the length of the test tubes filled with water or soap. Compare the time it takes for a ball bearing to fall through each liquid.
2. How does this demonstration relate to objects falling through the air?

Summary Questions

1. When objects fall, what happens to their velocities?
2. Under what atmospheric circumstances do size, shape, and mass have an impact on falling speed? Explain.
3. Under what atmospheric circumstances do size, shape, and mass NOT have an impact on falling speed? Explain.



Objectives

Identify the variables that influence the drag and time of fall on various objects.

Materials

Four station cards
Electronic balance,
Ping-pong balls,
Golf balls,
Regular coffee filters,
Industrial-sized coffee filters,
(and/or muffin cups),
Long translucent containers,
Corn syrup,
Water,
Stapler,
Marbles

NGSS

CDI HS-PS2
SEP 3, 4, 6, 7
CCC 2, 6

Discovery Lab (Contextual): Drag and Aircraft Design

NASA Aeronautics works to solve the many challenges that exist in the nation's airspace system. In fact, every U.S. aircraft flying today and every U.S. air traffic control tower uses NASA-developed technology in some way.

This document includes four very simple "station" activities that can be used to teach students about some of NASA Aeronautics' themes of ongoing research: namely, advancing green aviation, reducing flight delays, revisiting supersonic flight, and designing future aircraft. Learn more about these themes at <http://www.nasa.gov/aeronautics>

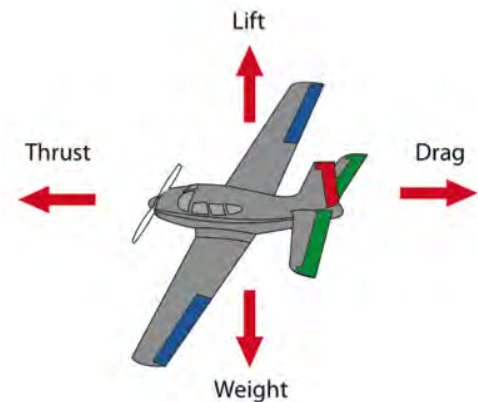

Nearly all of these research themes share a single commonality – an understanding of drag and effects on aircraft. In its simplest form, **drag** is defined as the resistive force on an object as the object attempts to move through a fluid (such as air or water). Drag acts opposite to the direction of motion of the object that is moving.

The purpose of these activities is to help students develop a conceptual understanding of drag, its causes, and its effect on the motion of an object. Students are also asked to consider, very simply, how engineers might design an aircraft to perform a given task (such as fast or slow flight, travel at high or low altitudes, or gliding with high or low finesse).

In fact, NASA engineers are currently working on future aircraft designs that meet many of these needs. Because aircraft experience a variety of conditions in flight, engineers are now also considering how an aircraft might respond, changing its shape so it can fly in the best way possible. To see an example of NASA-designed future aircraft, visit the Down to Earth Future Aircraft Gallery: <http://www.nasa.gov/content/down-to-earth-future-aircraft-0>

Objectives

- **Define drag.**
- **Describe the effect of drag on the motion of various objects of different mass, shape, size, and movement through fluids of different viscosity.**
- **Hypothesize some reasons for the cause of drag.**

Activities

(Note: In advance of all activities, ensure that all stations are set up as described in the lesson.)

Define Drag

Before beginning with these activities, it is important that students first develop a conceptual understanding of force. Most students understand forces to be either a “push” or a “pull,” and while sufficient for this activity, it can be beneficial to first provide students with a thorough understanding of force vectors.

To help students understand drag, provide students with a demonstration that will result in cognitive dissonance – a surprise that, for most, will elicit misconceptions about their understanding of objects falling through a fluid (such as air).

Begin by showing students a golf ball and a ping-pong ball. Ask students to compare their mass, shape, size, and the kind of fluid that surrounds them (air). Students should find that the only *major* difference between the two is that the golf ball is much heavier than the ping-pong ball. Then, ask the students to predict the motion of the two balls if they are released from the same height at the same time. Most students will say that the heavy one will fall faster. Before demonstrating, ask students to prepare to listen for the balls as they hit the ground, and to watch for the collision with the ground as well. Allow the single demonstrator (teacher or student) to drop the two objects from the same height at the same time. Students will often be shocked to find that, on average, the balls hit the ground at the same time!



Then, prepare to show students a single regular coffee filter, and a stack of multiple coffee filters. Again, the only major difference between the two items is that the single coffee filter weighs much less than the stack of coffee filters. Ask students to again predict how their motions will be different. Upon dropping the single filter and the set of coffee filters, students will see that there is a *major difference* in the time it takes to drop the single filter and the set of coffee filters.



In both cases (golf ball vs. ping-pong ball, and single vs. stack of coffee filters), the only difference between them was the mass. So, the question remains: why do the coffee filters behave differently than the balls?

Instead of answering this question outright, ask students to explain what could have caused the single coffee filter to fall so slowly. Most older children with an understanding of forces will be able to describe that there was some resistance from the air (**drag**) that was pushing opposite the motion of the falling object. Once this definition has been elaborated, encourage students to move to the four stations and to determine the effect of drag on objects of various masses, shapes, sizes, and movement through fluids of different viscosity.

Describe the effect of drag on the motion of various objects of different mass, shape, size, and movement through fluids of different viscosity.

Prepare the following stations in advance of having students split into small groups. Then, allow students to rotate through the stations in small groups until they have accomplished each task.

Mass

1. Place the station paper with the RED text box that reads, “Drop coffee filters of different masses. How does this affect their motions?”
2. Prepare sets of regular coffee filters of different masses (1, 2, 3, 4, and 9 coffee filters). Ensure that the stacks stay together by stapling them at the base. Label the stacks with the number of coffee filters in the stack.
3. Encourage students to work together to drop the coffee filters at the same time, and to describe any differences in motion that they perceive.
4. For more advanced students, ask students to determine how much higher a stack with double the mass must be placed in order to fall in the same amount of time as a single-unit stack.
5. After answering the question, ask students to read and discuss in their small groups, “What’s the big idea?” and “How do engineers use this idea in their designs?”



Shape

1. Place the station paper with the GREEN text box that reads, “Drop coffee filters of different shapes. How does this affect their motions?”
2. Prepare quantities of single coffee filters: some single coffee filters used for control tests, and other single coffee filters that have been set aside for students to change their shape (without changing mass). Students may crumple or fold the test coffee filters as they see fit.
3. Encourage students to work together to drop the coffee filters at the same time, and to describe any differences in motion that they perceive.
4. For more advanced students, ask students to determine if they can change or drop the coffee filters in such a way that the modified coffee filter (with the changed shape) actually takes more time to fall than the unmodified coffee filter.
5. After answering the question, ask students to read and discuss in their small groups, “What’s the big idea?” and “How do engineers use this idea in their designs?”



Size

1. Place the station paper with the ORANGE text box that reads, “Drop coffee filters of different sizes. How does this affect their motions?”
2. Prepare quantities of 10-gallon coffee filters (optional; these are readily available online), standard coffee filters, and paper muffin tins that all display different sizes, but same shape and same mass. To ensure that the sets have the same mass, use an electronic or triple-beam balance, and label the stacks so that students know they have equal mass. Use a staple to keep the stacks together (the mass of the staple is likely negligible; or, include its mass on the balance when massing the stacks).
3. Encourage students to work together to drop the coffee filters and muffin tins at the same time, and to describe any differences in motion that they perceive.
4. For more advanced students, allow the students to prepare the stacks of regular coffee filters or muffin tins themselves. In this case, provide the balance at their disposal.
5. After answering the question, ask students to read and discuss in their small groups, “What’s the big idea?” and “How do engineers use this idea in their designs?”



Fluid

1. Place the station paper with the BLUE text box that reads, “Drop marbles through different fluids. How does this affect their motions?”
2. Prepare four or five long and thin transparent bottles and fill them with fluids of different viscosity. (For the bottles, check the store’s travel section for clear shampoo bottles.) To prepare liquids of different viscosities, place different amounts of corn syrup and water into the bottles and shake well. Ensure that one of the bottles is filled with 100% corn syrup, and that another is filled with 100% water. The remaining bottles should be filled with different percentages of corn syrup and water. Drop a marble into each bottle, and then close the bottle tightly.
3. Use clear tape to seal off the bottles so they are not intentionally or inadvertently opened.
4. Encourage students to work together to invert the bottles to determine what is different about the fluids in each bottle, and how they know. Ask students to compare the marble traveling through the corn syrup and water mixture to aircraft travelling through low-altitude or high-altitude atmosphere, where the atmosphere is more and less thick, respectively.
5. For more advanced students, ask them to rank the viscosities of the fluids in the tubes. Ask students to consider a method to quantify the viscosity of the fluids in each tube. (Consider providing a stopwatch, and encouraging them to observe the fast-moving marbles as they roll down a gentle incline, without fully inverting the bottles).
6. After answering the question, ask students to read and discuss in their small groups, “What’s the big idea?” and “How do engineers use this idea in their designs?”



Hypothesize Reasons for Cause of Drag

After all students have had the opportunity to participate in the activities at each station, ask all students to re-convene to share their outcomes. In general, students will find:

- As mass increases, coffee filters tend to fall faster (although, this is not generalizable, given what was seen with the balls).
- As shape gets smaller, coffee filters tend to fall faster.
- As size gets smaller, coffee filters tend to fall faster.
- As viscosity of the fluid increases, marbles tend to fall more slowly.

Ask students to consider if any of these statements are generalizable (could be applied nearly to any object moving through a fluid):

- Students might mention that some very large objects (like the 10-gallon coffee filter) are simply not stable, and won’t fall in a uniform way.
- Students should mention that coffee filters and the balls did not seem to behave the same. Mass seemed to make a difference in the falling rate of the coffee filters, but not the balls.

Encourage students to consider what actually causes drag, and why the same air particles that affect the coffee filters don’t seem to interact with the balls in the same way. Consider discussing the meaning of aerodynamic and non-aerodynamic shapes, and how scientists visualize these.

In the case of the coffee filters, air particles are more likely to get trapped and collide with the surface of the coffee filter, while they tend to move around the balls because of their shape. Dropping balls on the surface of the Earth is very similar to dropping balls on the surface of the moon; although they will accelerate more quickly on Earth, compared to one another they will land on both the Earth and on the moon in nearly the same time. Encourage students to develop their own models, given what they know about air, and encourage students to visualize their concepts on whiteboards or posters.

Drag is not a simple concept. Unlike surface friction, air particles often interact in unexpected, chaotic ways, and a single air particle does not need to directly touch an object in order to be influenced by an object as it moves through a fluid.

For more information about drag, please refer to NASA’s Beginner’s Guide to Aerodynamics:
<https://www.grc.nasa.gov/WWW/k-12/airplane/bga.html>

Drop coffee filters of different masses.
How does this affect their motions?

What's the big idea?

When there is air drag present, heavier items tend to fall more quickly than lighter items. Heavier items take longer to reach their final speed when there is air, because they have more momentum.



How do engineers use this idea in their designs?

It requires more energy (fuel and money) to keep heavier airplanes in the sky. NASA engineers work to make airplanes both strong and lightweight. The X-48B was a NASA test airplane comprised of new composite materials so that it would be as light as possible.



Drop coffee filters of different shapes.
How does this affect their motions?

What's the big idea?

Some shapes experience less drag because air particles are able to flow around them more easily.



How do engineers use this idea in their designs?

Drag can prevent airplanes from moving quickly through the air. NASA engineers work to make the fastest airplanes in the world, like this futuristic design in the image. NASA has designed airplanes that have gone at least 6.7 times the speed of sound.

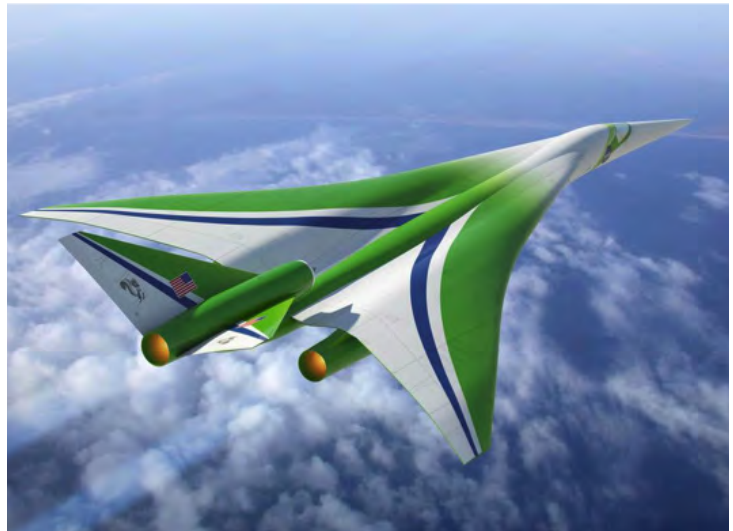

Drop coffee filters of different sizes. How does this affect their motions?

What's the big idea?

Objects with large surfaces have more area that can collide with air particles and cause drag.



How do engineers use this idea in their designs?

Drag isn't always a bad thing in aerospace engineering. NASA engineers use drag to help them slow down fast-moving objects with parachutes. Pictured to the right is the capsule from the Orion mission as it falls from space back to Earth.



Drop marbles through different fluids. How does this affect their motions?

What's the big idea?

Some fluids are more viscous (“stickier”) than others. Stickier fluids cause an object to experience more drag. Air might not seem very thick, but the atmosphere near the ground is much thicker than the atmosphere near the edge of space.



How do engineers use this idea in their designs?

NASA engineers have to design for both thick and thin air. The image to the right, NASA engineers have designed high-altitude aircraft, such as ER-2, with long wings to fly in thin air.





NASA Researchers to Flying Insects: “Bug Off!”

http://www.nasa.gov/aero/bug_off.html#.VHTQqo29-Rg

Analysis Questions:

- *What problems do bugs cause the airline industries?*
- *When airplanes fly through bug-infested air, what impact does that have on the environment?*
- *Describe the tests performed by NASA scientists to overcome the “bug guts” problem.*

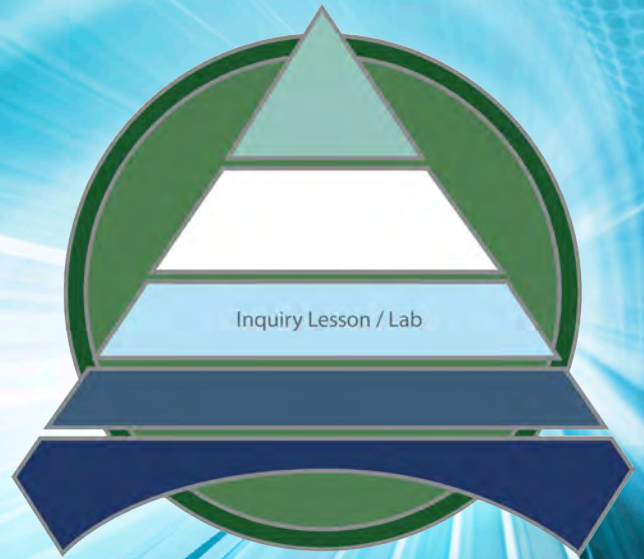

Objectives

Investigate the viscosity of a fluid by determining the relationship between distance traveled and time elapsed for a bubble. Investigate how other variables influence motion through a fluid.

Materials

Bubble tubes
Meter stick
Timer
Graduated cylinder
Viscous fluids (corn syrup, molasses, maple syrup, or honey with varying concentrations of water, oil)
Density spheres
Mass balance

NGSS

CDI HS-PS2
SEP 1-7
CCC 1, 2, 4, 5, 6

Inquiry Lesson/Lab: Viscosity Tubes

In order to study viscosity of a fluid and its effect on the motion of objects going through it, students can drop small items such as marbles through a long tube filled with a viscous fluid. Alternatively, “bubble tubes” can be commercially purchased from many science education retailers. Bubble tubes usually come in sets with fluids of different viscosities in each tube. Students can observe and record the motion of air bubbles as they rise through the fluid. The derived speed of the bubble rising or object falling through the tube can be used as an indicator of viscosity (with slow speeds equating to high viscosity, and fast speeds equating to low viscosity).

Provide students with at least one bubble tube, a meter stick, and a timer, and ask students determine the relationships below for objects traveling through a viscous fluid. (Note: While the use of a meter stick and timer is acceptable, more efficient data collection and analysis can be done through the use of video analysis software).

Part 1: **Distance** and **time**

Part 2: **Viscosity** and **terminal velocity**

Part 3: **Weight** and **terminal velocity**

Part 4: **Temperature** and **terminal velocity**

Although the following student worksheets do not explicitly address each of the stages of the learning cycle for its repetitive nature in this kind of in-depth study with multiple parts, ensure that students address each step.



For each part of this laboratory experiment:

Aim: Ensure that students are able to internalize and describe the objective of the experiment. In particular, ensure that students have correctly identified the variables of study.

Plan: Ensure that students work as individuals and then as small groups to plan to experiments. Special attention must be given to the materials needed to ensure that students are modifying the correct variables while holding other variables constant. This becomes especially important when performing a set of experiments. For example, students in Part 1 are asked to determine the relationship between distance and time for a variety of fluids – this requires multiple controlled experiments with different base conditions. Be attentive to safety considerations, and make sure that students use only harmless fluids, and that they choose to heat the fluids in a responsible matter, especially in Part 4.

Decide: Ensure that students commit to an experimental plan before beginning. Decisions must be made in regard to materials used, data collection procedures, number of trials, number of experiments with different baseline conditions, and range of data.

Act: Allow students to experiment without much teacher interference.

Verify: Encourage students to perform analysis of the validity (accuracy and precision) and reliability of their data before sharing with the whole class. If possible, encourage groups to determine if the relationships they have observed are linear, square, inverse, etc. Fluids can sometimes give surprising relationships – encourage students to have an open mind and not necessarily see relationships that are immediately evident.

Evaluate: Engage students in whole-class discussion to determine the nature of the relationships between all of the variables in the system. If conclusions are unclear, have students consider a plan of action to re-create some of the experiments. Additionally, encourage students to deepen their research by referring to engineering handbooks on fluids.

Part I

Objective: Determine the graphical and mathematical models relating the distance traveled and the time elapsed for a marble falling through a viscous fluid.

Because the marble achieves terminal velocity very quickly through a very viscous medium, all derived relationships should be approximately linear. Allowing students to compare graphs and equations for the motion of marbles through different tubes should result in significantly different slopes.

(Note: Students might note that when the marble is inserted into the fluid the starting level of the fluid goes up as fluid is displaced by the volume of the marble. Encourage students to measure distances from a consistent point that corresponds to time “0.” Remind students that time from the point of the drop above the fluid should not be included when determining the average velocity of the marble through the fluid.)

General derived relationship from graph: $d = v t$

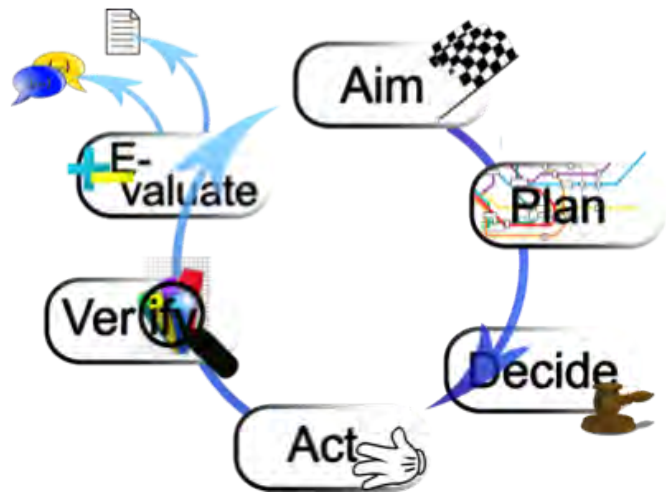

Part II

Objective: Determine the graphical and mathematical models relating the viscosity of a fluid and its terminal velocity.

Although it is easy to demonstrate that the same object traveling more slowly through one medium than another is the result of differences in viscosity, the relationship between terminal velocity and viscosity of a fluid is a bit more complex.

Using the known viscosities of the fluids with which students are working, have students plot the viscosity of the fluid versus the terminal velocity. (Known values can be retrieved online: ensure that the values are accurate for room temperature). For best results, have students collect data on terminal velocity for at least five different fluids of known viscosity, using either a very small air bubble rising upward or a very small sphere falling downward through the fluid. The use of larger, non-spherical objects will significantly distort this relationship.

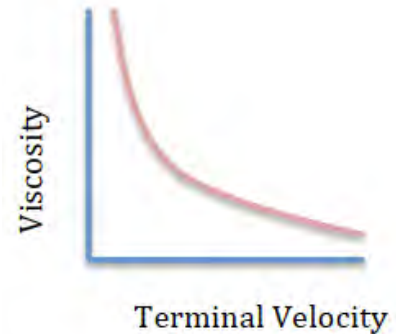

In general, students should find that the relationship between these two variables is approximately an inverse (as viscosity increases, terminal velocity decreases).

General derived relationship: $\eta = k \frac{1}{v}$, where η is viscosity (in Pa s or kg / (m s)) and v is terminal velocity (in m/s) through the fluid. Naturally, it might be valuable to discuss the meaning of the constant, k . Ask students to consider what variables might influence the viscosity of a fluid in contact with a given particle. Variables that might affect perceived viscosity, as measured by terminal velocity, might include things such as difference in density (which thereby affects buoyant force and the ability of a particle to sink or float in the surrounding fluid), acceleration due to gravity, and radius of the object going through it. (It is important to note that viscosity is a term used relevant to a situation. The behavior of a fluid with a given viscosity on Earth might not behave the same way on another planet, where its perceived viscosity might be higher or lower due to different gravitational fields or temperature!)

In fact, for simple Newtonian fluids at room temperature, viscosity can be calculated as $\eta = \frac{2 \Delta \rho g r^2}{9 v}$ where $\Delta \rho$ is the difference in density between the fluid and the object, g is the acceleration due to gravity, and r is the radius of the object moving through the fluid.

Although it is not reasonable to assume that students will be able to derive the full meaning of k on their own, the equation as given can be used to compare experimentally derived values for viscosity compared to their textbook value. In this case, teachers must provide students with a way to measure volume and mass of the fluid and object to determine density, and a measuring tool to estimate the radius of the object.

If appropriate, following a discussion about what other variables might influence terminal velocity, students could be briefly introduced to Stokes' law, which defines the drag force experienced by a small particle through a fluid (so that buoyancy is negligible), where F_d is drag force, μ is the dynamic viscosity of the fluid, R is the radius of the particle, and v is the velocity of the particle. *Caution: This law is only truly an inverse relationship between viscosity and terminal velocity if drag force is constant between trials with different fluids, which is not the case in this experiment, unless the terminal velocities observed are relatively close to one another.*

$$F_d = 6 \pi \mu R v$$

$$\mu = \frac{F_d}{6 \pi R v}$$

Having developed an understanding of the relationship between terminal velocity and viscosity of materials, provide students with an unknown fluid, and ask them to identify the fluid based upon its estimated viscosity.

(Note: Modeling of fluids can be quite tricky, and some models are only applicable for smaller or larger objects, fluids at particular temperatures, or fluids with particular behaviors. This activity ties directly into a study of drag force on airplanes. For example, at low speeds and small, aerodynamic particles, air drag is directly proportional to speed.

$$f_{drag} = -b v.$$

However, for larger particles, such as airplanes,

$$f_{drag} = -\frac{1}{2} C \rho A v^2,$$

where C is the coefficient of lift (a constant dependent upon the shape and angle of attack of the object), ρ is the air density, A is the cross-sectional area of the object, and v is the velocity of the fluid over the surface of the object.)

Part III

Objective: Determine the graphical and mathematical models relating the weight of an object and its terminal velocity falling (or rising) through a viscous medium.

From the previous discovery lab, students will recognize that, when air resistance is present, weight does have a significant impact on terminal velocity. Ideally, provide students with density spheres of equal volume. Alternatively, use density cubes of the same volume.

Students should find that as velocity increases, weight increases by a quantity proportional to terminal velocity or terminal velocity squared (this depends upon if the mass is very, very small at low speeds, or larger or moving at higher speeds). The following equation(s) could be derived, depending upon the type of object dropped:

$$Weight = b v_{terminal} \quad \text{or} \quad Weight = b v_{terminal}^2$$

Students can then be asked to visually model the reason why this might be. Proposals might include items such as that greater weight is more able to push air particles out of the way.

(Note: Teachers might feel that “mass” is a more apt term to use than “weight” in this case, which seems to be a more complex concept. The emphasis here is on weight (as a force), because, in later experiments, students will recognize that weight and frictional drag are equal in magnitude in experiments where objects have achieved terminal velocity.)

Part IV

Determine the graphical and mathematical models relating the temperature of a fluid and terminal velocity.

Using a fluid that has viscosity strongly dependent upon temperature (such as maple syrup), attempt to qualitatively derive the relationship between terminal velocity and temperature. A safe setup can be achieved by filling large test tubes with the fluid, adding a ball bearing, sealing them loosely, and placing them in water baths of various temperatures from cool to warm – all test tubes should be able to be handled without risk of burn. Students can then move from station to station to record temperatures of the water bath and terminal velocities of ball bearings in the tubes. Remind students to hold the test tube stoppers in place as they invert the tubes, and to use caution when working with hot water.

In general, students will find that the relationship is linear, or positively correlated. Students should make an attempt to then relate temperature to viscosity, given what they know about velocity’s relationship to viscosity.

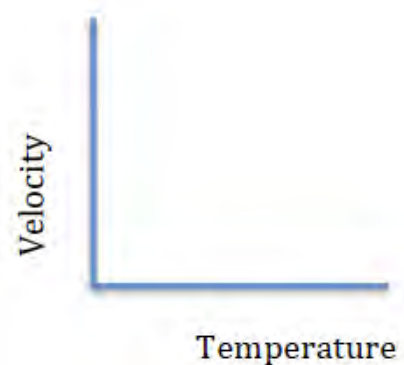
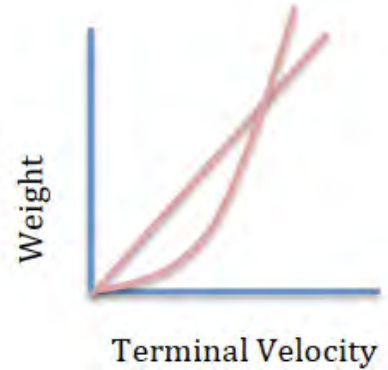

Student Worksheet: Viscosity Tubes

The flight of an airplane through the sky is neither free nor easy. Passenger aircraft are often very large and travel very quickly through the air, exposing them to a considerable amount of resistance, called air resistance or drag. Air is a fluid, so studies of resistance can also take place in other fluids, such as liquids, with similar results. In the following activities, you will learn about how to measure how much a fluid resists the motion of a bubble or marble moving through it.

Part I

Fluids that are dense, thick, and strongly resist the motion of objects going through them have high “viscosity.” One way to measure viscosity is to determine the speed of objects as they travel through the fluid. In this activity, you will use a marble, a cylinder filled with fluid, a meter stick, and a timer to derive a relationship between distance and time as the marble falls through the cylinder.

Objective: Determine the graphical and mathematical models relating the *distance* traveled and the *time* elapsed for a marble falling through a viscous fluid.

1. Show collected data below:

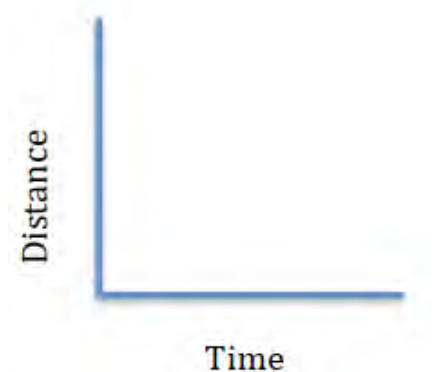

2. Plot a sketch of your data on the graph above.

3. Determine the general relationship of your graph:

4. Extension:

Perform the same experiment as above, but this time using a different fluid. Compare your results.

Part II

As you might have guessed, if an object travels more slowly through one fluid than the other, the fluid resulting in the slower speed is more viscous. However, it is not necessarily the case that a doubly viscous material will cause an object to fall at half the rate as before. Because viscosity can be very difficult to measure, you will instead look for standard viscosity values in a chemical or physical handbook, or online. You will compare these values to the terminal velocity of objects falling through the fluid.

Objective: Determine the graphical and mathematical models relating the *viscosity* of a fluid and its *terminal velocity*.

1. Show collected data below, including your viscosity values source:

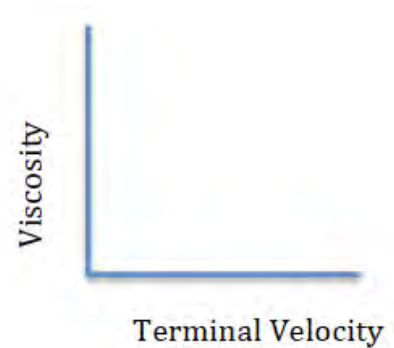

2. Plot a sketch of your data on the graph above.
3. Determine the general relationship of your graph:

4. Extension:

- What kinds of constants in your experiment do you think might factor into the value you calculated for the constant in your equation?
- How do you predict that changing those constants in your experiment might change the graph and the equation?
- Using the equation provided to you by your teacher, determine the experimental value of one of your fluids.

Part III

From the previous discovery lab, you will have noticed that the weight of the object makes a significant difference in drag experience when friction is present. Now, you will investigate how weight influences terminal velocity in a single type of fluid.

Objective: Determine the graphical and mathematical models relating the *weight* of an object and its *terminal velocity* falling (or rising) through a viscous medium.

1. Show collected data below:

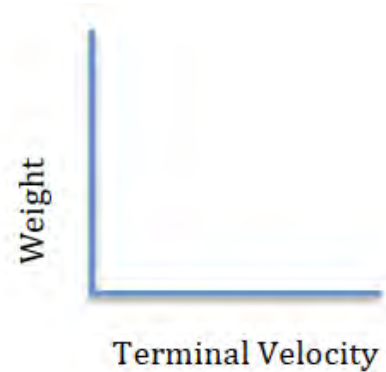

2. Plot a sketch of your data on the graph above.
3. Determine the general relationship of your graph:

4. Extension:

If weight influences terminal velocity, which, in turn, can be used as an indicator for viscosity, where is “weight” evident in the equation provided by your teacher in the Extension problems for Part III?

Part IV

Most equations for viscosity are dependent upon a variety of factors, including fluid density. Fluid density, in turn, is influenced by temperature. In this activity, you will travel from station to station to observe a ball bearing as it falls through a test tube of fluid that has been heated or cooled in a water bath.

Determine the graphical and mathematical models relating the *temperature* of a fluid and *terminal velocity*.

1. Show collected data below:

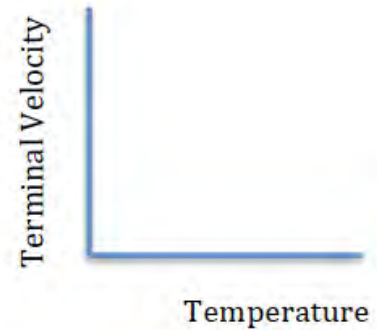

2. Plot a sketch of your data on the graph above.
3. Determine the general relationship of your graph:

4. Extension:

Given what you know about the relationship between terminal velocity and viscosity, what would a graph displaying viscosity vs. temperature look like? Sketch your prediction below, and provide a rationale.



NASA Turns World Cup Into Lesson in Aerodynamics

http://www.nasa.gov/content/nasa-turns-world-cup-into-lesson-in-aerodynamics/#.VHS_-I29-Rg

Analysis Questions:

- Read the article and watch the associated video. Explain how NASA researchers in this article visualize drag, and how it is different/similar to what you did to study drag in the previous activity.
- From the video, explain the effect of a ball's spin on the drag experienced around its surfaces.
- Describe how the traditional soccer ball has evolved from Jabulani to Brazuca, and why it has been designed differently over time.
- What is a boundary layer? What is knuckling?
- How does knuckling compare for traditional versus modern soccer balls? Why do you think this is the case?
- What applications do these studies have on soccer balls have for aeronautics and airplane design?

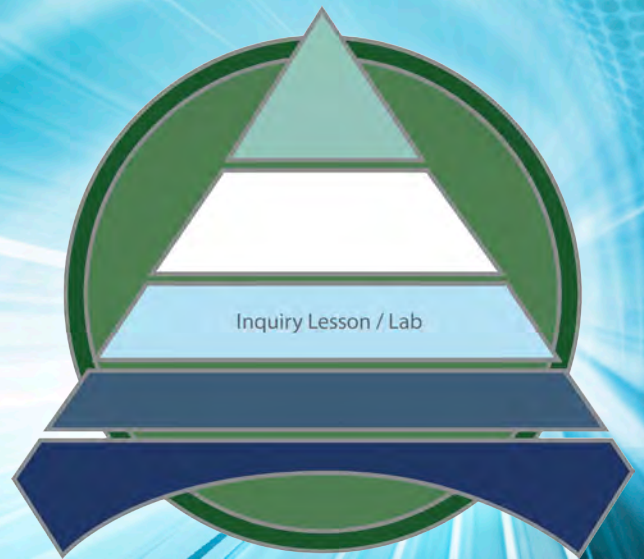

Inquiry Lesson/Lab: The Physics of Soaring (and L/D ratios)

[Kenneth W. Ford. *The Physics Teacher*, 38, 8 \(2000\).](#)

In this activity, students consistently launch paper gliders and make generalizations about their lift to drag ratios. Additionally, students use graphs and – if available – text from *The Physics Teacher* article to analyze horizontal and vertical velocity graphs for a gliders to make inferences about the gliders' L/D ratios.

Objectives

Measure Lift / Drag ratios.
Determine the relationship
between surface area and
Lift / Drag ratios.

Objective: Measure Lift/Drag ratios. Determine the relationship between surface area and Lift/Drag ratios.

Materials

Printer paper
Ruler
Meter stick or tape measure

Ask students to build a number of paper airplanes and to send them gliding. In light of the previous activities dealing with drag, ask them to consider how it would be possible to quantify or at least compare the amount of drag experienced by each glider as it moved through the air. With a bit of prompting, students will likely determine that, all other things being equal, the glider that moves the furthest horizontally has the *least* drag. However, the motion of a glider is a combination of both horizontal and vertical motion, with vertical motion being dependent upon the amount of lift generated by the wings of the glider. A glider with very high drag and very low lift will fall steeply, while a glider with low drag and high lift is more likely to soar for a while. Other variables that influence drag might include the shape of the aircraft, the surface area of the wings, and its speed.

NGSS

CDI HS-PS2
SEP 1-7
CCC 1, 3, 4, 6

Initial launching speed and initial angle of attack of gliders can be controlled for using the same method as in “Inquiry Lab: Scaling and Paper Airplanes.”

While aircraft shape is difficult to quantify, it is much easier to consider the construction of very simple aircraft in order to quantify the surface area of the wings. Again, refer to “Inquiry Lab: Scaling and Paper Airplanes” for suggestions. The two images below demonstrate how a simple aircraft design can be modified to give two dramatically different surface areas for wings.

Help students to understand that the horizontal range and vertical drop of their glider can be used *not* to measure lift or drag separately, but, rather, to get an L/D ratio.

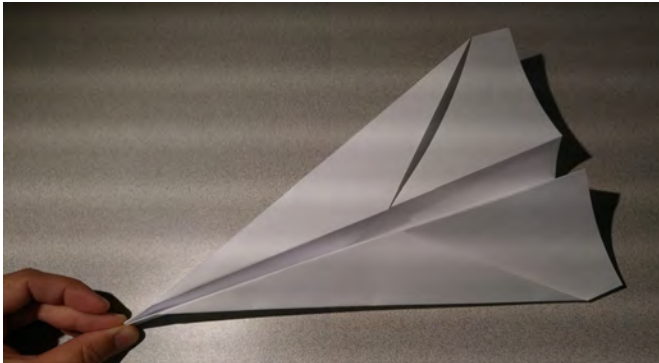
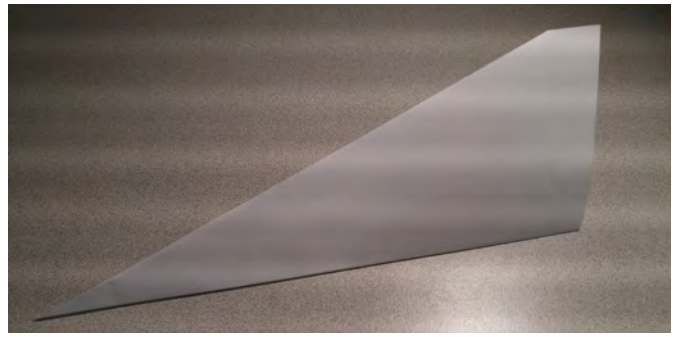

However, help students to understand that for this model to be most accurate, gliders must be launched horizontally.

Ask students to determine the relationship between surface area, A , of the wings and L/D ratios, plot their data on a graph, and determine the relationship between A and L/D. This relationship might not be linear, depending upon the shape, center of gravity, and variety of wind speeds encountered by the gliders throughout their flight. However, students should generally see that as surface area increase, lift/drag ratios increase, because an increase in thin surface areas parallel to the ground result in much greater increase on lift than on drag.

Lift/drag ratios also have significance for coefficients of lift and drag, which will be introduced in later units. For additional teacher background, please refer to the following article:



Lift to Drag Ratio

(L/D Ratio)

Glenn
Research
Center

L = Lift

D = Drag

W = Weight

a = Glide Angle

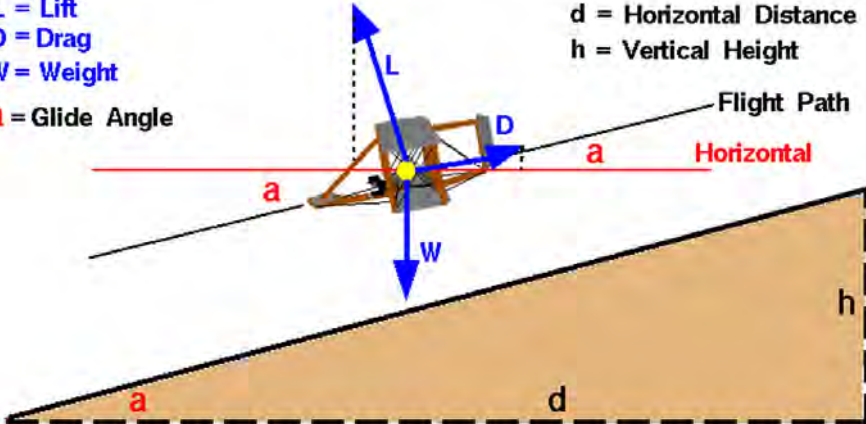

d = Horizontal Distance

h = Vertical Height

Horizontal Force Equation: $L \sin(a) = D \cos(a)$

$$\text{ratio} = \frac{\text{Lift}}{\text{Drag}} = \frac{L}{D} = \frac{cl}{cd} = \frac{1}{\tan(a)} = \frac{d}{h} = \frac{\text{distance}}{\text{height}}$$

BACKGROUND

from [Beginner's Guide to Aeronautics](#)

There are [four forces](#) that act on an aircraft in flight: lift, weight, thrust, and drag. Forces are [vector quantities](#) having both a magnitude and a direction. The [motion](#) of the aircraft through the air depends on the relative magnitude and direction of the various forces. The [weight](#) of an airplane is determined by the size and materials used in the airplane's construction and on the payload and fuel that the airplane carries. The weight is always directed towards the center of the Earth. The [thrust](#) is determined by the size and type of [propulsion system](#) used on the airplane and on the throttle setting selected by the pilot. Thrust is normally directed forward along the center-line of the aircraft. [Lift](#) and [drag](#) are aerodynamic forces that depend on the shape and size of the aircraft, air conditions, and the flight velocity. Lift is directed perpendicular to the flight path and drag is directed along the flight path.

Because lift and drag are both [aerodynamic forces](#), the [ratio](#) of lift to drag is an indication of the aerodynamic efficiency of the airplane. Aerodynamicists call the lift to drag ratio the **L/D ratio**, pronounced "L over D ratio." An airplane has a high L/D ratio if it produces a large amount of lift or a small amount of drag. Under [cruise conditions](#) lift is equal to weight. A high-lift aircraft can carry a large payload. Under cruise conditions thrust is equal to drag. A low-drag aircraft requires low thrust. **Thrust** is produced by burning a fuel and a low thrust aircraft requires [small amounts](#) of fuel be burned. As discussed on the [maximum flight time](#) page, low fuel usage allows an aircraft to stay aloft for a long time, and that means the aircraft can fly [long-range](#) missions. So an aircraft with a high L/D ratio can carry a large payload, for a long time, over a long distance. For [glider](#) aircraft with no engines, a high L/D ratio again produces a long range aircraft by reducing the steady state [glide angle](#) at which the glider descends.

As shown in the middle of the slide, the L/D ratio is also equal to the ratio of the lift and drag coefficients. The [lift equation](#) indicates that the lift **L** is equal to one half the air density ρ times the square of the velocity **V** times the wing area **A** times the [lift coefficient](#) C_L :

$$L = .5 * C_L * \rho * v^2 * A$$

Similarly, the [drag equation](#) relates the aircraft drag **D** to a [drag coefficient](#) C_D :

$$D = .5 * C_D * \rho * v^2 * A$$

Dividing these two equations give:

$$L/D = C_L / C_D$$

Lift and drag coefficients are normally determined experimentally using a [wind tunnel](#). But for some simple geometries, they can be determined mathematically.

Teacher Answer Key: The Physics of Soaring

Pilots who fly gliders (airplanes without engines), and those who do parasailing and other similar activities are intensely interested in the lift/drag ratios of their aircraft. Knowing their L/D ratios helps them to predict when and how far away they will land. In the case of glider pilots, they must know exactly how far away they can get from their landing spot in order to return home safely. In this activity, you will determine the L/D of a simple paper glider, then determine the relationship between L/D and the surface area of the wings of various similar gliders.



Objective: Measure Lift/Drag ratios. Determine the relationship between surface area and Lift/Drag ratios.

1. Build a paper glider that can fly straight. Compare it to a classmate's glider. Which of your gliders has a greater L/D ratio? How do you know?

Answers will vary. Gliders with greater L/D ratios will have a less steep descent.

2. Calculate the L/D ratio of your glider – consider doing this a few times. What is the L/D value? Explain how you accomplished this, and include a sketch to show any measurements you took.

Vertical distance of fall/range



3. What variables do you think influence the L/D ratio of gliders? Consider all of the things you studied in this module on terminal velocity, and list them below.

Aircraft shape, surface area of wings, material, weight, fluid viscosity, etc.



4. Next, decide how to study one of these variables: surface area, A. Collect data on at least five different gliders. Ensure that you will appropriately control for all other variables.



5. Develop a graphical model for the relationship between surface area, A, and L/D ratios. Describe this relationship, in words.

Generally, as surface area increases, lift/drag ratio should increase, although this is likely not usually linear.

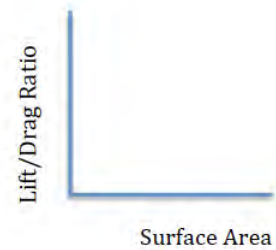

6. Determine if your data is reliable. How much variance is there in your data? Why?



7. Explain *why* you think that your graph displays the relationship you see. If it is linear – why? If it is not linear – why? Compare your graphs to other groups' to see if they display the same relationship.

As wings get bigger (for a paper glider), they tend to result in much more lift, and only a little bit more drag.

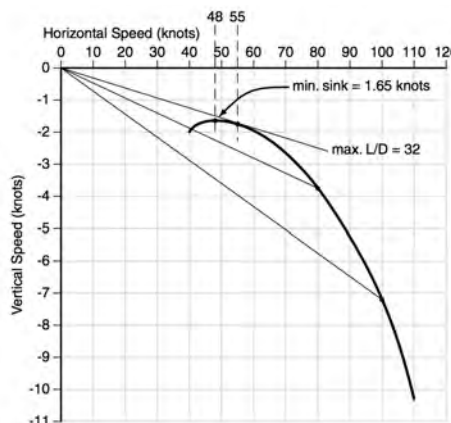

Fig. 4. The "polar" graph for a typical medium-performance glider, displaying the vertical component of velocity (or "vertical speed") vs the horizontal component of velocity (or "horizontal speed," which, to a good approximation, is the same as the glider's speed). A line drawn from the origin to a point on the curve shows the actual path of the glider through still air. (Here the vertical scale is expanded tenfold relative to the horizontal scale.) A line from the origin tangent to the curve defines the glider's maximum L/D (= $\cot \theta$) and locates the speed at which this maximum L/D is achieved. The highest point on the curve provides information on the minimum sink rate and the speed at which this is achieved. The descent of the curve to the right of the maximum L/D speed reveals the penalty for flying fast. (Data are for a Grob 103C, courtesy of Richard H. Johnson and Soaring magazine. Data for the same glider appear in Figs. 5 through 10.)

If possible, acquire a copy of "The Physics of Soaring" from *The Physics Teacher*. Otherwise, use the data extracted from the article below, and use other available Internet resources to more fully understand the importance and meaning of L/D ratios. **All of the graphs below are for the same typical medium-performance glider.**

8. Figure 4 from the article shows a “polar” graph. How is this graph different from the graph you generated above?

The polar graph shows vertical and horizontal speeds. Each curve is for a single glider moving at different horizontal speeds through the air, and their resulting lift or fall speeds. The graph generated in the lab is for many different gliders. Although L/D relationships are plotted, L/D is plotted on a single axis, with surface area on the other axes. The two types of graphs are somewhat related, but display entirely different relationships.

9. Figure 4 shows the possible conditions for a single type of glider. What is the difference between the glider’s circumstances in each of the three diagonal lines?

Each of the gliders are travelling at different horizontal speeds. The top-most line (smallest angle with respect to the horizontal) is the fastest travelling glider.

10. Figure 5 shows the polar curves for a low-performance, medium-performance, and high-performance glider. What do you think is meant by “high-performance”? How is that evident on the graph?

Higher performance has the highest L/D ratio, because it is more likely to stay aloft.

11. Maximum L/D values are shown for each of the three types of gliders. How were they calculated? Show work.

The L/D is actually the inverse of the slope of these graphs. The top value of L/D is about 46.5, and it was calculated from taking 57 knots/1.23 knots, or change in magnitude of x over change in magnitude of y.

12. What is meant by “minimum sink rate”? Why is this value important?

Minimum sink rate is the speed at which you achieve the maximum L/D. Staying at the associated horizontal speed results in the greatest amount of lift, and a longer amount of time in the air before landing.

13. The three curves in Figure 8 are for the same glider in sinking air. What would these curves look like for the same glider, but in rising air? Explain.

The graphs would simply be displaced upward, because the vertical speed is a combination of speed due to lift and speed of the surrounding air.

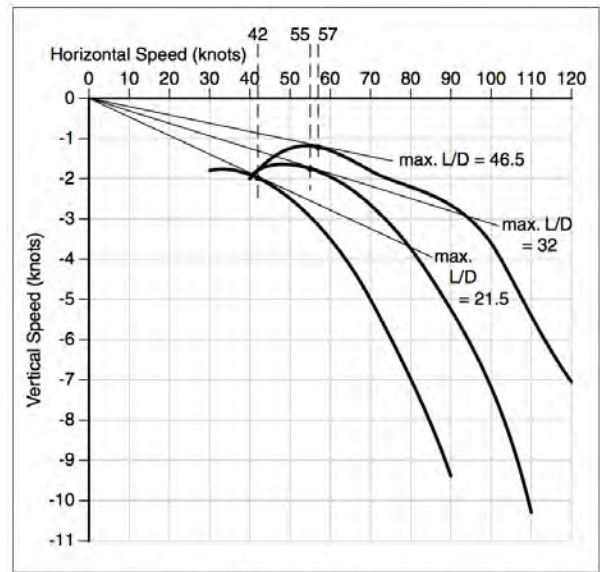

Fig. 5. Polars for a low-performance, a medium-performance, and a high-performance glider. The minimum sink rates for the gliders do not differ greatly, but their maximum L/D’s (labeled) and penalties for flying fast are quite different. (Data are for a Schweizer 1-26E, Grob 103C, and ASH-26E, in order of increasing performance, courtesy of Richard H. Johnson and Soaring magazine.)

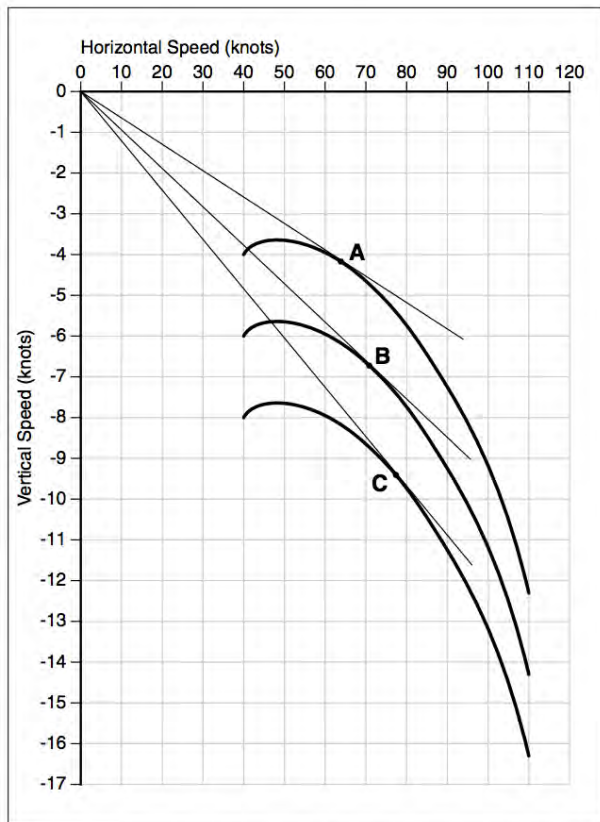

Fig. 8. The three curves are polars for a medium-performance glider in air sinking at 2, 4, and 6 knots. The tangent lines show the paths of minimum descent angle for the three cases. Points A, B, and C (together with corresponding points for other sink rates of the air) correlate speed to fly with the glider’s rate of descent, leaving out the intermediate variable of the air’s sink rate.

Student Worksheet: The Physics of Soaring

Pilots who fly gliders (airplanes without engines), and those who do parasailing and other similar activities are intensely interested in the lift/drag ratios of their aircraft. Knowing their L/D ratios helps them to predict when and how far away they will land. In the case of glider pilots, they must know exactly how far away they can get from their landing spot in order to return home safely. In this activity, you will determine the L/D of a simple paper glider, then determine the relationship between L/D and the surface area of the wings of various similar gliders.

Objective: Measure Lift/Drag ratios. Determine the relationship between surface area and Lift/Drag ratios.

1. Build a paper glider that can fly straight. Compare it to a classmate's glider. Which of your gliders has a greater L/D ratio? How do you know?
2. Calculate the L/D ratio of your glider – consider doing this a few times. What is the L/D value? Explain how you accomplished this, and include a sketch to show any measurements you took.
3. What variables do you think influence the L/D ratio of gliders? Consider all of the things you studied in this module on terminal velocity, and list them below.

4. Next, decide how to study one of these variables: surface area, A . Collect data on at least five different gliders. Ensure that you will appropriately control for all other variables.

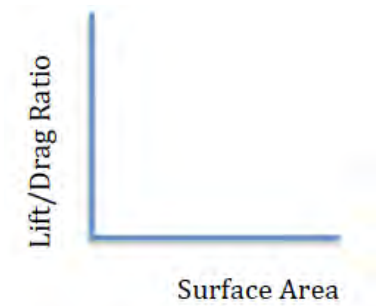

5. Develop a graphical model for the relationship between surface area, A , and L/D ratios. Describe this relationship, in words.

Generally, as surface area increases, lift/drag ratio should increase, although this is likely not usually linear.

6. Determine if your data is reliable. How much variance is there in your data? Why?

7. Explain *why* you think that your graph displays the relationship you see. If it is linear – why? If it is not linear – why? Compare your graphs to other groups’ to see if they display the same relationship.

If possible, acquire a copy of “The Physics of Soaring” from *The Physics Teacher*. Otherwise, use the data extracted from the article below, and use other available Internet resources to more fully understand the importance and meaning of L/D ratios. **All of the graphs below are for the same typical medium-performance glider.**

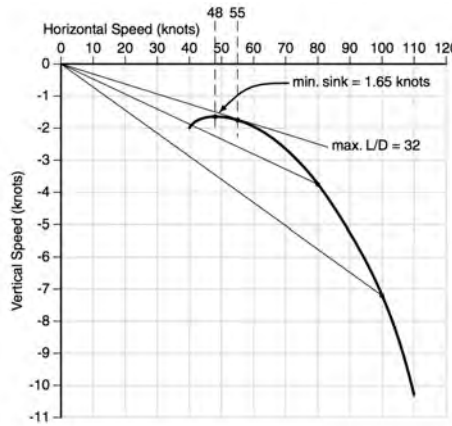

Fig. 4. The “polar” graph for a typical medium-performance glider, displaying the vertical component of velocity (or “vertical speed”) vs the horizontal component of velocity (or “horizontal speed,” which, to a good approximation, is the same as the glider’s speed). A line drawn from the origin to a point on the curve shows the actual path of the glider through still air. (Here the vertical scale is expanded tenfold relative to the horizontal scale.) A line from the origin tangent to the curve defines the glider’s maximum $L/D (= \cot \theta)$ and locates the speed at which this maximum L/D is achieved. The highest point on the curve provides information on the minimum sink rate and the speed at which this is achieved. The descent of the curve to the right of the maximum L/D speed reveals the penalty for flying fast. (Data are for a Grob 103C, courtesy of Richard H. Johnson and *Soaring* magazine. Data for the same glider appear in Figs. 5 through 10.)

8. Figure 4 from the article shows a “polar” graph. How is this graph different from the graph you generated above?

9. Figure 4 shows the possible conditions for a *single* type of glider. What is the difference between the glider’s circumstances in each of the three diagonal lines?

10. Figure 5 shows the polar curves for a low-performance, medium-performance, and high-performance glider. What do you think is meant by “high-performance”? How is that evident on the graph?

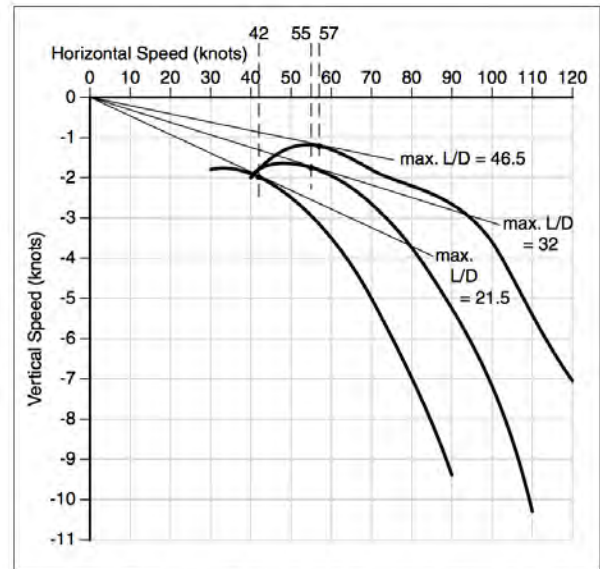

Fig. 5. Polars for a low-performance, a medium-performance, and a high-performance glider. The minimum sink rates for the gliders do not differ greatly, but their maximum L/D 's (labeled) and penalties for flying fast are quite different. (Data are for a Schweizer 1-26E, Grob 103C, and ASH-26E, in order of increasing performance, courtesy of Richard H. Johnson and *Soaring* magazine.)

11. Maximum L/D values are shown for each of the three types of gliders. How were they calculated? Show work.

12. What is meant by “minimum sink rate”? Why is this value important?
13. The three curves in Figure 8 are for the same glider in sinking air. What would these curves look like for the same glider, but in rising air? Explain.

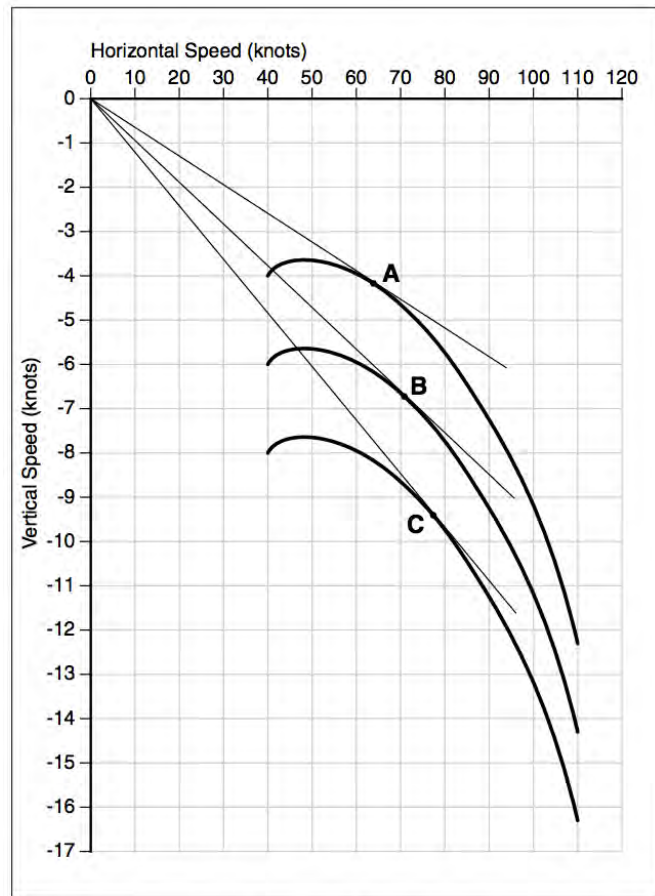



Fig. 8. The three curves are polars for a medium-performance glider in air sinking at 2, 4, and 6 knots. The tangent lines show the paths of minimum descent angle for the three cases. Points A, B, and C (together with corresponding points for other sink rates of the air) correlate speed to fly with the glider's rate of descent, leaving out the intermediate variable of the air's sink rate.

Problem Set: Glider Trajectory Problems

[Beginner's Guide to Aeronautics](#)



Glider Trajectory Problem

Glenn
Research
Center

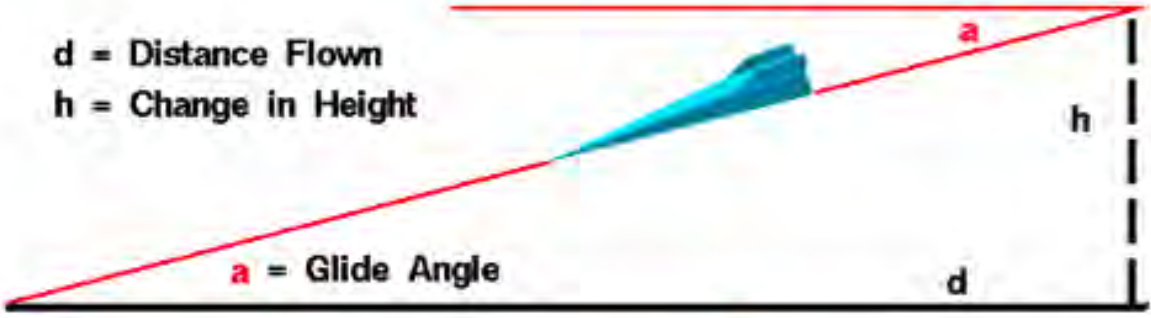

d = Distance Flown
h = Change in Height

a = Glide Angle

From Trigonometry:

$$\tan(a) = \frac{h}{d}$$

D = Drag
L = Lift
W = Weight

From Balance of Forces:

$$L \cos(a) + D \sin(a) = W$$
$$L \sin(a) = D \cos(a)$$

Measure: height (h), distance (d), and weight (W).

Solve 3 equations in 3 unknowns for lift (L), drag (D), and glide angle (a).

You will explore the trigonometric relationship $\tan(a) = h/d$ where a is the glide angle, h is the altitude of the plane, and d is the horizontal distance the plane will travel.

Problems:

1. A full-sized glider has a glide angle of 2 degrees. If it loses 50 meters of altitude, how far would it move horizontally?
2. A model glider moves horizontally 12 meters for every meter of altitude it loses. What is its glide angle?
3. A model glider has a glide angle of 5 degrees. If it flies 23 meters horizontally, how much altitude will it lose?
4. A full-sized glider has a glide angle of 5 degrees. If the altitude is 300 meters, will the glider make it to an airport 4,000 meters away?

5. A full-sized glider loses 2 meters for every 38 meters it travels horizontally. What is its glide angle?
6. A model glider travels 57 meters horizontally after losing 5 meters of altitude. What is its glide angle?
7. A model glider loses 3 meters of altitude. If it has a glide angle of 4 degrees, how far did the glider travel horizontally?
8. A full-sized glider lands 10,000 meters horizontally from where it began its downward diagonal path. If the glide angle is 3 degrees, what was the glider's altitude?
9. A model glider has an average velocity of 2.2 m/s along its downward diagonal path. After 10 seconds, the glider has lost 2 meters of altitude. What is the glider's glide angle and how far horizontally did it travel?
10. A full-sized glider has a velocity of 36 m/s along its downward diagonal path. If it has a glide angle of 4 degrees, how much altitude will it lose in 2 minutes? How far will it travel horizontally in that 2 minutes?

Problems:

Create a spreadsheet that finds the weight of each glider, the measure of each angle in degrees, and the drag on each glider at angles of 2, 3, 4, and 5 degrees.

Model Gliders	Mass	Full-sized Gliders	Mass
1	.5 kg	4	500 kg
2	.9 kg	5	900 kg
3	1.4 kg	6	1,400 kg

Questions:

1. Compare the drag between model glider 1 and the full-sized glider 4 for all four angles. What conclusion can you draw?
2. Based on your answer in Question 1, would it be valid to use a model glider to study the drag on a full-sized glider?
3. What is the relationship between glide angle and drag?



Objectives

Describe the meaning of glide ratio and the variables that influence it.

Materials

The Simple Science of Flight,
Ch. 4

NGSS

SEP 4
CCC 1, 6

CCSS

Reading in Science
Writing in Science

Literary/Data Analysis: Flying with Finesse

Henk Tennekes. *The Simple Science of Flight*. The MIT Press: Cambridge, Massachusetts. Ch. 4

Although the following chapter from *The Simple Science of Flight* must be purchased, the book is well worth the read, and is applicable to many physics concepts from mechanics.

Have students read chapter four of *The Simple Science of Flight* using the following guiding questions for literary and data analysis.

*Cover image and graphics from *The Simple Science of Flight* are reproduced here with permissions from The MIT Press.

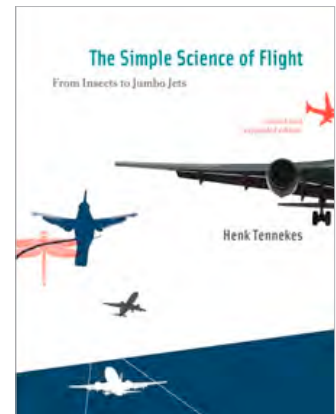

Teacher Answer Key: Flying with Finesse

The Art of Flapping

- Compare the geometry of the forces exerted by people as they skate, birds as they flap, and airplanes as they fly. How are they similar? How are they different? Include a diagram or two in your description.

To move forward, skaters push forward and to the side. Birds, on the other hand, push their wings forward and down. Bird wings essentially perform the same motions as skaters, but within a different plane.

- What should the drag/lift (D/L) ratio be in order to maximize flight efficiency? Explain.

The D/L ratio should be as small as possible. A small drag value means that it is easier for the thrust to result in forward motion.

Horizontal Flight

- What is finesse? Why is it important to both birds and planes?

The L/D ratio. The opposite of D/L, the L/D ratio should be as big as possible. Birds and planes with the greatest finesse are more energy efficient; they tend to have thin wings and aerodynamic body shapes.

The Great Gliding Diagram

- Look at Figure 15, the “Great Gliding Diagram.” Do birds demonstrate constant values of finesse? Explain why you think this is the case.

No. Typically, as flying speed increases, finesse initially increases, then decreases. This likely has something to do with drag. As birds go faster, the drag increases significantly more. There is a “sweet spot” for maximum finesse – the best cruising speed.

- According to Figure 15, which birds are most fit to be long-term soarers?

Swifts – they do not exceed the maximum horizontal speed of 12 m/s, and they exceed the soaring limit of 1 m/s vertically. They also have a greater finesse value than the cabbage white.

- Based upon the data, is the Boeing 747 a good glider? Why do you suspect this is the case?

Moderately so. (Although it has high finesse for an airplane, it is moderate in comparison to some birds). This is likely because the wings are small in comparison to the weight it carries, so that it can also reduce drag at its very high speeds.

- Relate Figure 15 to Figure 6 and Figure 7 from chapter 2. Is there a relationship between the data in these graphs? Explain.

Figures 6 and 7 demonstrate that there is a “sweet spot” in horizontal speed in terms of the minimum power required for flight. This low power requirement seems to correspond with the peaks of each curve on Figure 15 (where the slopes are equal to 0 – where an increase in horizontal flight speed does not change the rate of descent.)

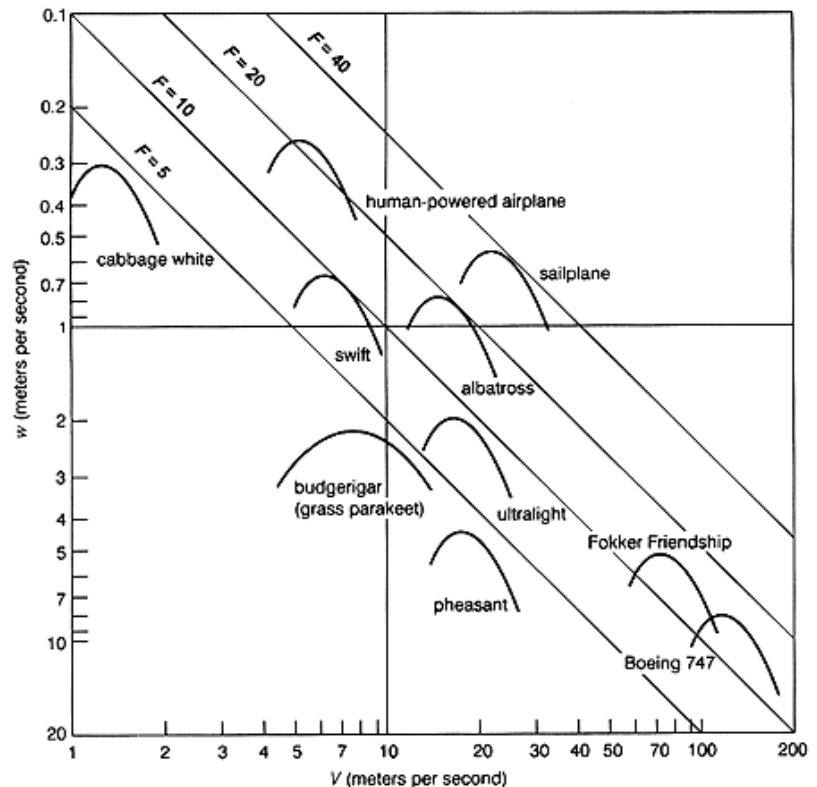

8. Relate Figure 15 to Figure 2 in Chapter 1. Is there a relationship between the data in these graphs? Explain.

Yes. Heavier birds tend to need to cruise at faster speeds.

Induced Drag

9. What kinds of relationships are inferred by equation (29) on page 73?

$$D_i = \frac{W^2}{\rho V^2 S A}$$

*Many parts of this relationship are **opposite** that which we expect for frictional drag. Essentially, as flying things go faster, induced drag decreases.*

10. What is the difference between induced and frictional drag? Provide examples of each.

Frictional drag is a result of wings going through the air, whereas induced drag is a result of flapping.

11. How do induced and frictional drag influence optimal cruising speed? Relate back to Figure 7.

As speed goes up, frictional drag goes up, but induced drag decreases. Optimal cruising speed occurs at the lowest maximum total drag.

12. What information does Table 5 provide that is *not* provided in Figure 15?

S, b, and A

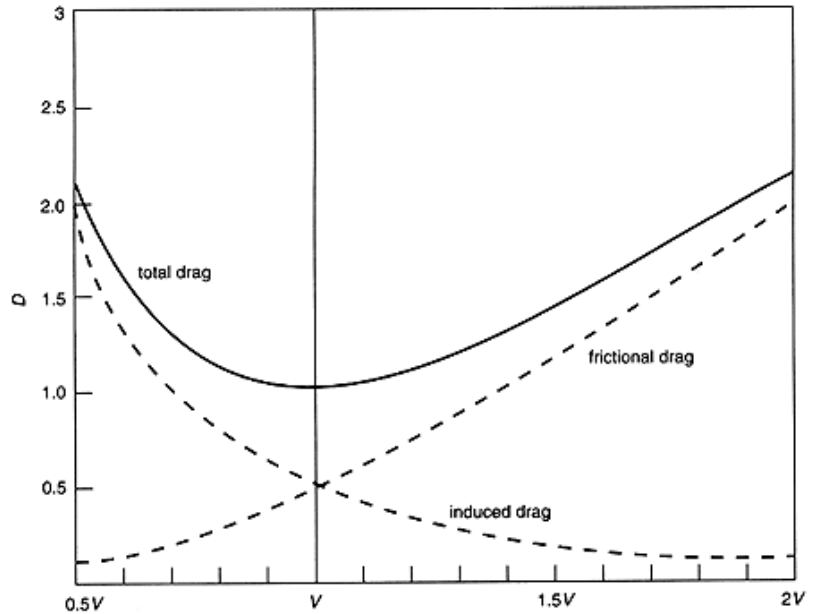

Student Worksheet: Flying with Finesse

Reach chapter four of *The Simple Science of Flight* using the following guiding questions for literary and data analysis.

The Art of Flapping

1. Compare the geometry of the forces exerted by people as they skate, birds as they flap, and airplanes as they fly. How are they similar? How are they different? Include a diagram or two in your description.
2. What should the D/L ratio be in order to maximize flight efficiency? Explain.

Horizontal Flight

3. What is finesse? Why is it important to both birds and planes?

The Great Gliding Diagram

4. Look at Figure 15, the “Great Gliding Diagram.” Do birds demonstrate constant values of finesse? Explain why you think this is the case.
5. According to Figure 15, which birds are most fit to be long-term soarers?
6. Based upon the data, is the Boeing 747 a good glider? Why do you suspect this is the case?
7. Relate Figure 15 to Figure 6 and Figure 7. Is there a relationship between the data in these graphs? Explain.

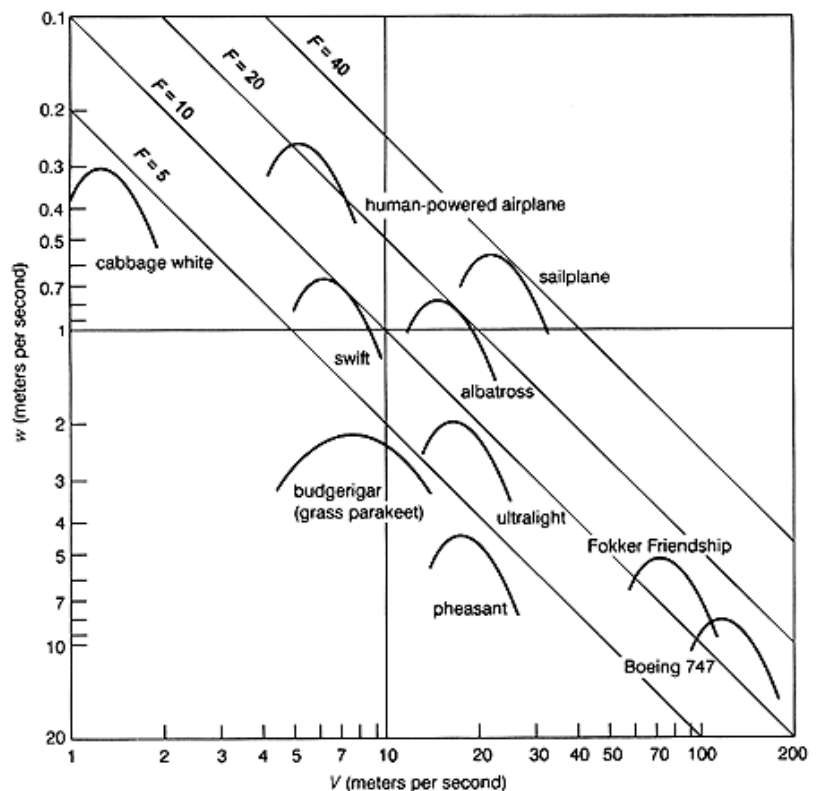

8. Relate Figure 15 to Figure 2. Is there a relationship between the data in these graphs? Explain.

Induced Drag

9. What kinds of relationships are inferred by equation (29) on page 73? Rationalize each variable and its placement in the equation.

$$D_i = \frac{W^2}{dV^2SA}$$

10. What is the difference between induced and frictional drag? Provide examples of each.

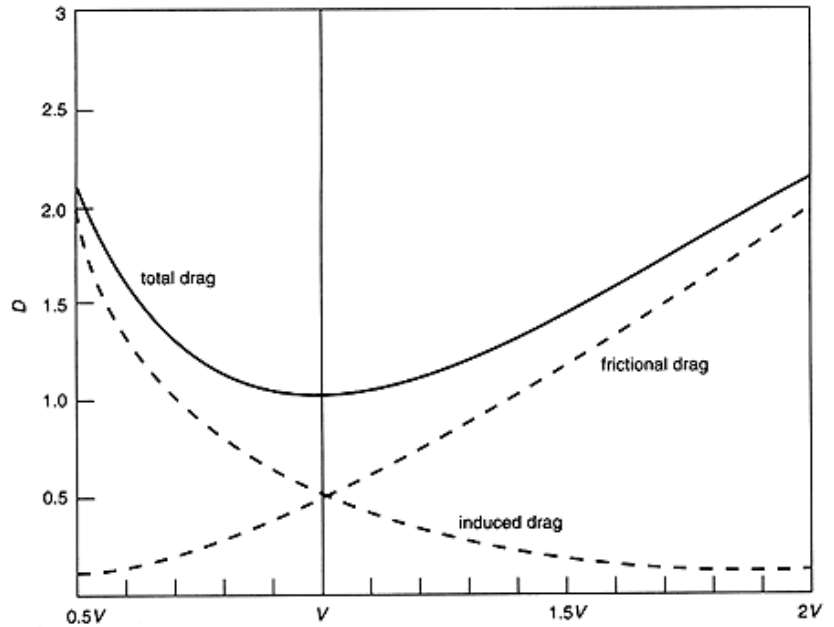

11. How do induced and frictional drag influence optimal cruising speed? Relate back to Figure 7.

12. What information does Table 5 provide that is not provided in Figure 15?



Objectives

Develop a micro and macroscopic model for drag.

Materials

None

NGSS

CDI HS-PS2
SEP 2, 6, 7
CCC 4

CCSS

Reading in Science
Writing in Science

Model Building: Developing a Model for Drag

From the many experiences in this unit, students will understand that drag is a force that is dependent upon many different macroscopic variables, including weight, speed, shape, and the fluid that surrounds the object. However, it is important to have students also consider what is happening microscopically, because drag – and the similar force of lift – are so closely related.

Encourage students to visually and verbally describe their models for drag. Ask students to prepare a poster, whiteboard, or some other form of document, and have students retain those models for the activity “Developing a Model for Drag” so that they can compare their original model for drag with their refined models of lift in the activity “Model: Developing a Model for Lift.”

What do you think causes drag?	How does it work? Drawing	How does it work? Explanation

Students might immediately consider that drag is a result of the following variables, for the following reasons:

MACROSCOPICALLY:

- Object effects:
 - Certain **shapes** *catch*, *spill*, or “*slice*” through the air.
 - Objects with a heavy **weight** can “slice” through the air more easily.

MICROSCOPICALLY:

- Mental representation of fluid flow:
 - Particle model of fluid: As particles bounce against an object, they transfer some of their momentum to the object, preventing it from moving forward through the fluid.
 - Stream or sheet model of fluid: Fluid particles flow around objects. As these streams or sheets of fluid get separated more from their original orientation, it is harder to get through the fluid.
- Fluid variables
 - Density: It is harder to move through more dense fluid, because it’s harder to overcome the inertia of heavy particles, or because it’s harder to move through so many closely spaced particles. Fluid atomic composition, pressure, and temperature all affect its density.
 - Stickiness: It is harder to move through stickier fluid, because the fluid properties (intermolecular forces) make the particles want to stay together more.

While none of the above ideas are wrong, they are almost all very incomplete. See the following articles for some more background on drag.

BACKGROUND

from [Beginner's Guide to Aeronautics](#)

Drag is the aerodynamic [force](#) that opposes an aircraft's motion through the air. Drag is generated by every part of the airplane (even the [engines!](#)). How is drag generated?

Drag is a **mechanical force**. It is generated by the interaction and contact of a solid body with a **fluid** (liquid or gas). It is not generated by a force field, in the sense of a [gravitational](#) field or an **electromagnetic field**, where one object can affect another object without being in physical contact. For drag to be generated, the solid body must be in contact with the fluid. If there is no fluid, there is no drag. Drag is generated by the [difference in velocity](#) between the solid object and the fluid. There must be motion between the object and the fluid. If there is no motion, there is no drag. It makes no difference whether the object moves through a static fluid or whether the fluid moves past a static solid object.

Drag is a force and is therefore a [vector quantity](#) having both a magnitude and a direction. Drag acts in a direction that is opposite to the motion of the aircraft. Lift acts perpendicular to the motion. There are many [factors](#) that affect the magnitude of the drag. Many of the factors also affect [lift](#) but there are some factors that are unique to aircraft drag.

We can think of drag as aerodynamic friction, and one of the sources of drag is the **skin friction** between the molecules of the air and the solid surface of the aircraft. Because the skin friction is an interaction between a solid and a gas, the magnitude of the skin friction depends on properties of both solid and gas. For the solid, a smooth, waxed surface produces less skin friction than a roughened surface. For the gas, the magnitude depends on the [viscosity](#) of the air and the relative magnitude of the viscous forces to the motion of the flow, expressed as the **Reynolds number**. Along the solid surface, a boundary layer of low energy flow is generated and the magnitude of the skin friction depends on conditions in the [boundary layer](#).

We can also think of drag as aerodynamic resistance to the motion of the object through the fluid. This source of drag depends on the [shape](#) of the aircraft and is called **form drag**. As air flows around a body, the local velocity and [pressure](#) are changed. Since pressure is a measure of the momentum of the gas molecules and a change in momentum produces a [force](#), a varying pressure distribution will produce a [force](#) on the body. We can determine the magnitude of the force by integrating (or adding up) the local pressure times the surface area around the entire body. The component of the aerodynamic force that is opposed to the motion is the drag; the component perpendicular to the motion is the lift. Both the lift and drag force act through the [center of pressure](#) of the object.

There is an additional drag component caused by the generation of lift. Aerodynamicists have named this component the [induced drag](#). It is also called “drag due to lift” because it only occurs on finite, lifting wings. Induced drag occurs because the distribution of lift is not uniform on a wing, but varies from root to tip. For a lifting wing, there is a pressure difference between the upper and lower surfaces of the wing. Vortices are formed at the wing tips, which produce a swirling flow that is very strong near the wing tips and decreases toward the wing root. The local [angle of attack](#) of the wing is increased by the **induced flow** of the tip vortex, giving an additional, downstream-facing, component to the aerodynamic force acting on the wing. The force is called **induced drag** because it has been induced by the action of the tip vortices. The magnitude of induced drag depends on the amount of lift being generated by the wing and on the distribution of lift across the span. [Long, thin](#) (chordwise) wings have low induced drag; short wings with a large chord have high induced drag. Wings with an elliptical distribution of lift have the minimum induced drag. Modern airliners use [winglets](#) to reduce the induced drag of the wing.

Two additional sources of drag are **wave drag** and **ram drag**. As an aircraft approaches the speed of sound, [shock waves](#) are generated along the surface. The shock waves produce a change in static pressure and a loss of total pressure. Wave drag is associated with the formation of the shock waves. The magnitude of the wave drag depends on the [Mach number](#) of the flow. **Ram drag** is produced when free stream air is brought inside the aircraft. [Jet engines](#) bring air on board, mix the air with fuel, burn the fuel, then exhausts the combustion products to produce [thrust](#). If we look at the basic [thrust equation](#), there is a mass flow times entrance velocity term that is subtracted from the gross thrust. This “negative thrust” term is the ram drag. Cooling [inlets](#) on the aircraft are also sources of ram drag.

As students consider a model for drag, they are beginning to consider how objects interact with fluid that flows around it. The Navier-Stokes equations describe how fluids interact with their environment, and are the foundation for computational fluid dynamics that is so important in modeling flow around a given aircraft or object. While students of introductory physics are likely unprepared to fully understand differential equations, such equations allow a better understanding of how the many variables identified within their model work together.



Navier–Stokes Equations

3 – dimensional – unsteady

Glenn
Research
Center

Coordinates: (x,y,z) Time: t Pressure: p Heat Flux: q
 Density: ρ Stress: τ Reynolds Number: Re
 Velocity Components: (u,v,w) Total Energy: Et Prandtl Number: Pr

Continuity:
$$\frac{\partial \rho}{\partial t} + \frac{\partial(\rho u)}{\partial x} + \frac{\partial(\rho v)}{\partial y} + \frac{\partial(\rho w)}{\partial z} = 0$$

X – Momentum:
$$\frac{\partial(\rho u)}{\partial t} + \frac{\partial(\rho u^2)}{\partial x} + \frac{\partial(\rho uv)}{\partial y} + \frac{\partial(\rho uw)}{\partial z} = -\frac{\partial p}{\partial x} + \frac{1}{Re_r} \left[\frac{\partial \tau_{xx}}{\partial x} + \frac{\partial \tau_{xy}}{\partial y} + \frac{\partial \tau_{xz}}{\partial z} \right]$$

Y – Momentum:
$$\frac{\partial(\rho v)}{\partial t} + \frac{\partial(\rho uv)}{\partial x} + \frac{\partial(\rho v^2)}{\partial y} + \frac{\partial(\rho vw)}{\partial z} = -\frac{\partial p}{\partial y} + \frac{1}{Re_r} \left[\frac{\partial \tau_{xy}}{\partial x} + \frac{\partial \tau_{yy}}{\partial y} + \frac{\partial \tau_{yz}}{\partial z} \right]$$

Z – Momentum:
$$\frac{\partial(\rho w)}{\partial t} + \frac{\partial(\rho uw)}{\partial x} + \frac{\partial(\rho vw)}{\partial y} + \frac{\partial(\rho w^2)}{\partial z} = -\frac{\partial p}{\partial z} + \frac{1}{Re_r} \left[\frac{\partial \tau_{xz}}{\partial x} + \frac{\partial \tau_{yz}}{\partial y} + \frac{\partial \tau_{zz}}{\partial z} \right]$$

Energy:
$$\frac{\partial(E_T)}{\partial t} + \frac{\partial(uE_T)}{\partial x} + \frac{\partial(vE_T)}{\partial y} + \frac{\partial(wE_T)}{\partial z} = -\frac{\partial(up)}{\partial x} - \frac{\partial(vp)}{\partial y} - \frac{\partial(wp)}{\partial z} - \frac{1}{Re_r Pr_r} \left[\frac{\partial q_x}{\partial x} + \frac{\partial q_y}{\partial y} + \frac{\partial q_z}{\partial z} \right] + \frac{1}{Re_r} \left[\frac{\partial}{\partial x}(u \tau_{xx} + v \tau_{xy} + w \tau_{xz}) + \frac{\partial}{\partial y}(u \tau_{xy} + v \tau_{yy} + w \tau_{yz}) + \frac{\partial}{\partial z}(u \tau_{xz} + v \tau_{yz} + w \tau_{zz}) \right]$$

BACKGROUND

from [Beginner's Guide to Aeronautics](#)

The Navier-Stokes equations describe how the velocity, [pressure](#), [temperature](#), and [density](#) of a moving [fluid](#) are related. The equations were derived independently by G.G. Stokes, in England, and M. Navier, in France, in the early 1800s. The equations are extensions of the [Euler equations](#) and include the effects of [viscosity](#) on the flow. These equations are very complex, yet undergraduate engineering students are taught how to derive them in a process very similar to the derivation that we present on the [conservation of momentum](#) webpage.

The equations are a set of coupled **differential equations** and could, in theory, be solved for a given flow problem by using methods from **calculus**. But, in practice, these equations are too difficult to solve analytically. In the past, engineers made further approximations and simplifications to the equation set until they had a group of equations that they could solve. Recently, high-speed computers have been used to solve approximations to the equations using a variety of techniques like finite difference, finite volume, finite element, and spectral methods. This area of study is called **computational fluid dynamics**, or **CFD**.

The Navier-Stokes equations consist of a time-dependent continuity equation for [conservation of mass](#), three time-dependent [conservation of momentum](#) equations and a time-dependent [conservation of energy](#) equation. There are four independent variables in the problem: the x, y, and z spatial coordinates of some domain, and the time t. There are six dependent variables; the pressure p, density ρ, and temperature T (which is contained in the energy equation through the total energy E_T) and three [components](#) of the velocity [vector](#); the u component is in the x direction, the v component is in the y direction, and the w component is in the z direction, All of the dependent variables are [functions](#) of all four independent variables. The differential equations are therefore **partial** differential equations and not the **ordinary** differential equations that one studies in a beginning calculus class.

Re is the [Reynolds number](#) is a similarity parameter that is the ratio of the scaling of the inertia of the flow to the viscous forces in the flow. The \mathbf{q} variables are the heat flux components and Pr is the Prandtl number which is a similarity parameter that is the ratio of the viscous stresses to the thermal stresses. The $\boldsymbol{\tau}$ variables are components of the **stress tensor**. A tensor is generated when you multiply two vectors in a certain way. Our velocity vector has three components; the stress tensor has nine components. Each component of the stress tensor is itself a second derivative of the velocity components.

The terms on the left-hand side of the momentum equations are called the **convection terms** of the equations. [Convection](#) is a physical process that occurs in a flow of gas in which some property is transported by the ordered motion of the flow. The terms on the right hand side of the momentum equations that are multiplied by the inverse Reynolds number are called the **diffusion terms**. [Diffusion](#) is a physical process that occurs in a flow of gas in which some property is transported by the random motion of the molecules of the gas. Diffusion is related to the stress tensor and to the viscosity of the gas. Turbulence, and the generation of [boundary layers](#), are the result of diffusion in the flow. The Euler equations contain only the convection terms of the Navier-Stokes equations and cannot, therefore, model boundary layers. There is a special simplification of the Navier-Stokes equations that describe boundary layer flows.

Notice that all of the dependent variables appear in each equation. To solve a flow problem, you have to solve all five equations simultaneously; that is why we call this a **coupled** system of equations. There are actually some other equation that are required to solve this system. We only show five equations for six unknowns. An [equation of state](#) relates the pressure, temperature, and density of the gas. And we need to specify all of the terms of the stress tensor. In CFD the stress tensor terms are often approximated by a turbulence model.



Force Particle – Inertia



A joint project of
NASA Aeronautics
and the
American Association of
Physics Teachers



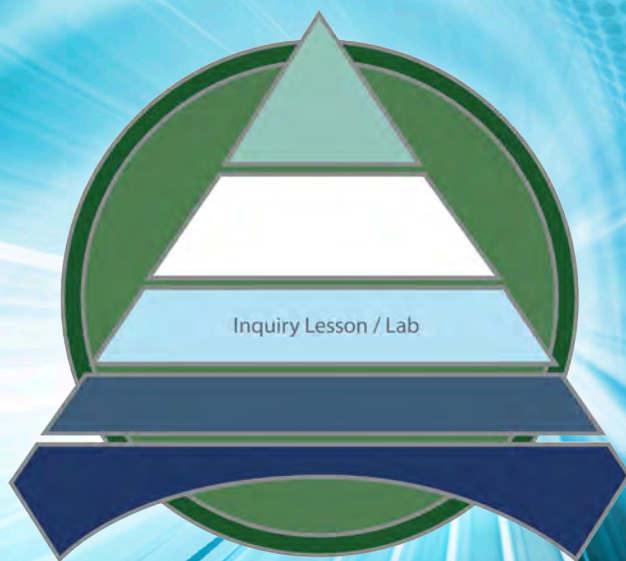

Objectives

Determine the relationship between air drag and terminal velocity.

Materials

Motion detector
Graphical analysis tool
Coffee filters (of a variety of sizes, including industrial coffee filters and / or muffin or candy cups)
Meter stick

NGSS

CDI HS-PS2
SEP 1-7
CCC 1, 2, 4, 5, 6

Inquiry Lesson/Lab: Falling and Air Resistance (Qualitative)

In previous activities, students will have investigated a wide variety of variables that influence the speed of a rising bubble or a falling object through fluids. However, the focus was on the motion as well as the viscosity, both of which are related to the *drag force* on the object.

In this inquiry lab, with their understanding of force diagrams and balanced-force systems, students will investigate how the drag force due to air resistance influences the terminal velocity of a coffee filter. Because an object moving at constant velocity is in a balanced-force system, a coffee filter falling at terminal velocity experiences a drag equal in magnitude to its weight. (Hence, this activity is not terribly different from a study relating the *mass* of an object and its *terminal velocity*.) However, to relate this study more closely to theoretical kinematics, the use of a motion detector and timer will not be permitted for the final portion of the activity. See the theoretical discussion further on.

Objective: Determine the relationship between *air drag* and *terminal velocity*.

The linear model of drag versus terminal velocity is limited only to objects moving at relatively slow speeds. For higher speeds, drag force becomes incrementally greater, and reaches a point at which drag is proportional to the square of the speed of the moving object relative to the motion of the surrounding fluid. The purpose of this activity is to engage students in collecting a wide range of data to see if coffee filters have a drag that is more dependent upon a direct relationship with speed or with speed squared.

(Note: To acquire more data points, consider placing half or portions of coffee filters inside of the bottom filter!)

Teacher Answer Key: Falling and Air Resistance (Qualitative)

Objective: Determine the relationship between *air drag* and *terminal velocity*.

- Holding a motion detector as high as possible, drop a single coffee filter below it. Create a qualitative sketch of position vs. time and velocity vs. time. On both graphs, label the point where terminal velocity begins.



- Draw a force diagram for the coffee filter before it has been released from your hand.
Depending upon how the coffee filter is held, there should be a force of gravity downward, and either a normal force or tension force suspending it upward, with equal magnitude.
- Draw a force diagram for the coffee filter after it has been released from your hand, but before it achieves terminal velocity.
The force of gravity is the same as before, but the upward force is smaller, and is now a drag (friction) force.
- Draw a force diagram that represents a coffee filter falling at terminal velocity through the air.
Constant velocity implies balanced forces, so the drag force pointing up should be equal in magnitude and opposite in direction to the weight.
- From prior experience, it appears as though small objects display a relationship in which weight (equal to F_{air} , the friction force of air) is directly proportional to terminal velocity. $F_{\text{air}} = W = k v_{\text{terminal}}$ where k is a constant. From $W = k v_{\text{terminal}}$, and assuming that the coffee filter is at terminal velocity essentially from the moment of its release, derive an expression for the *displacement* of the coffee filter relating to weight.

$$W = kv \quad \Delta x = vt \quad W = k \left(\frac{\Delta x}{t} \right) \quad \Delta x = \frac{Wt}{k}$$

- Based upon the derived expression above, if drag force is directly proportional to v , what does it say about the distance fallen when the weight is doubled? Tripled?
Double weight would result in double the distance fallen, and triple the weight would result in triple the distance fallen in the same amount of time.
- In contrast, at high speeds, experiments show that F_{air} could be proportional to velocity squared, leading to $F_{\text{air}} = W = kv^2$. Derive an alternate expression for Δx in relationship to weight, if this is the case.

$$W = kv^2 \quad \Delta x = vt \quad W = k \left(\frac{\Delta x^2}{t^2} \right) \quad \Delta x = \frac{\sqrt{Wt}}{k}$$

- Based upon the derived expression above, if drag force is proportional to v^2 , what does it say about the distance fallen when the weight is doubled? Tripled?
Doubling the weight would increase the displacement by 1.4 times (the square root of 2), while tripling the weight would increase the displacement by 1.7 times (the square root of 3).

Goal: Determine the graphical and general mathematical model relating *air friction drag* and *terminal velocity* for *falling coffee filters*. Limitation: You must achieve this without the use of a motion detector or any devices that record time.

Hint: This can be accomplished by estimating the distances at which two or more sets of coffee filters of varying weights fall in the same amount of time. This requires some team effort and consistency!

- Looking at your data, which theoretical model does your data support? Create a presentation and/or report. Be sure to include all parts of the learning cycle, from your experimental planning to the evaluation of your data. Provide an argument for the accuracy and precision of your data collection process as well.

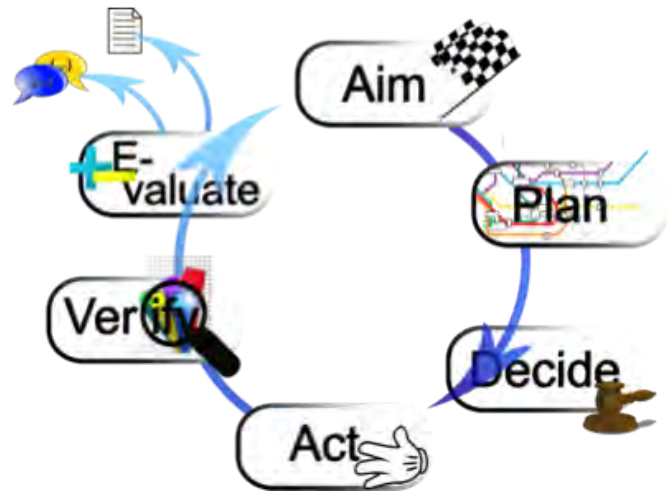

Student Worksheet: Falling and Air Resistance (Qualitative)

In many aspects, physics is beautiful because of its simplicity. Many simple rules govern the universe. However, there are some phenomena that simply cannot be easily modeled by a single relationship – fluids is one of them. Typically, physics textbooks report that drag is proportional to speed squared. Hence, if you run twice as fast into the wind, you will feel four times the resistance. However, this relationship doesn't always hold true for smaller objects. In this activity, you will investigate coffee filters as they fall at terminal velocity. Because weight is equal to drag at terminal velocity, you will use weight to determine if drag is proportional to the coffee filter's speed, v , or speed squared, v^2 .

1. Holding a motion detector as high as possible, drop a single coffee filter below it. Create a qualitative sketch of position vs. time and velocity vs. time. On both graphs, label the point where terminal velocity begins.

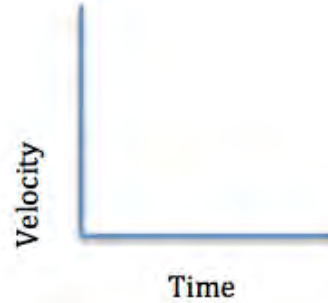
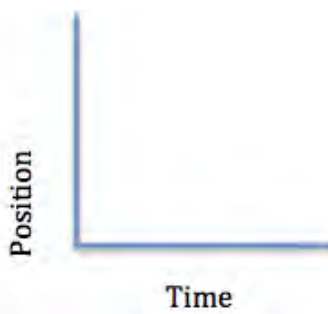

2. Draw a force diagram for the coffee filter before it has been released from your hand.
3. Draw a force diagram for the coffee filter after it has been released from your hand, but before it achieves terminal velocity.
4. Draw a force diagram that represents a coffee filter falling at terminal velocity through the air.
5. From prior experience, it appears as though small objects display a relationship in which weight (equal to F_{air} , the friction force of air) is directly proportional to terminal velocity. $F_{\text{air}} = W = k v_{\text{terminal}}$, where k is a constant. From $W = k v_{\text{terminal}}$, and assuming that the coffee filter is at terminal velocity essentially from the moment of its release, derive an expression for the *displacement* of the coffee filter relating to weight.

$$W = kv \quad \Delta x = vt \quad W = k \left(\frac{\Delta x}{t} \right) \quad \Delta x = \frac{Wt}{k}$$

6. Based upon the derived expression above, *if drag force is directly proportional to v* , what does it say about the distance fallen when the weight is doubled? Tripled?

7. In contrast, at high speeds, experiments show that F_{air} could be proportional to velocity squared, leading to $F_{\text{air}} = W = kv^2$. Derive an alternate expression for Δx in relationship to weight, if this is the case.
8. Based upon the derived expression above, if drag force is proportional to v^2 , what does it say about the distance fallen when the weight is doubled? Tripled?

Goal: Determine the graphical and general mathematical model relating air friction drag and terminal velocity for falling coffee filters. Limitation: You must achieve this without the use of a motion detector or any devices that records time.

Hint: This can be accomplished by estimating the distances at which two or more sets of coffee filters of varying weights fall in the same amount of time. This requires some team effort and consistency!

9. Looking at your data, which theoretical model does your data support? Create a presentation and/or report. Be sure to include all parts of the learning cycle, from your experimental planning to the evaluation of your data. Provide an argument for the accuracy and precision of your data collection process as well.

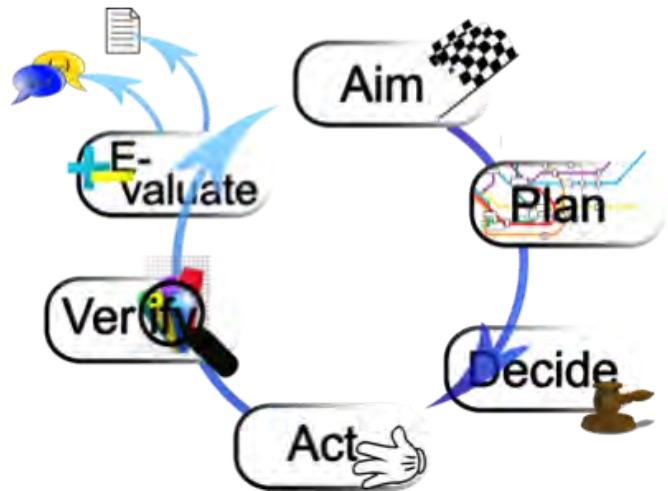



Skyray 48 Takes Flight

http://www.nasa.gov/vision/earth/improvingflight/skyray_48.html#.VHO5Y29-Rg

Analysis Questions:

- The X-48B is a blended wing body aircraft. What is the purpose behind this kind of design?
- The X-48B is also a remotely controlled aircraft. Why do you think that NASA is pursuing research for remote-controlled and autonomous vehicles?



Real-World Applications: Hanging an Airplane: A Case Study in Static Equilibrium

Debora M. Katz. *The Physics Teacher*, 47, 516 (2009).

Objectives

Determine tensile strength needed to hang an airplane, identify center of mass, and suspend the airplane at a given angle.

Materials

Thread
Meter sticks
Masses
Tape
Ring stand
Protractor
Force meter (optional)

NGSS

CDI HS-PS2
SEP 1-7
CCC 3, 6, 7



A wonderful way to help students understand concepts of static equilibrium is to “hang an airplane,” much in the same way as an artifact airplane would be suspended in a museum. Because planes are generally suspended in such a way as to give the perception of flight, a specific angle might be desired. The following is an activity to help students measure tensile strength of a string, measure the center of mass of the airplane to be suspended, and calculate the necessary lengths and forces in each string to support the plane at a given angle.

Teacher Answer Key: Hanging an Airplane

Objective: Determine the minimum number of strings required to support the aircraft by measuring tensile strength.

For this activity, it is best to provide students with a thread with a low tensile strength. A string that might break when supporting a model airplane should be provided to them, so that they feel compelled to determine the minimum number of strands necessary to support the aircraft from a single point.

In order to determine the required number of threads to support any object, the tensile strength should be determined, where

$$\sigma = \frac{F_{break}}{A},$$

and F_{break} is the force at which the string breaks, and A is the cross-sectional area of the string. F_{break} can be measured by pulling on the string with a digital force meter, or adding masses to a string suspended from a point until it breaks, and recording the final force. The cross-sectional area can be measured by placing threads side by side on a piece of tape, and using a ruler to estimate the diameter of a single thread to calculate its cross-sectional area.

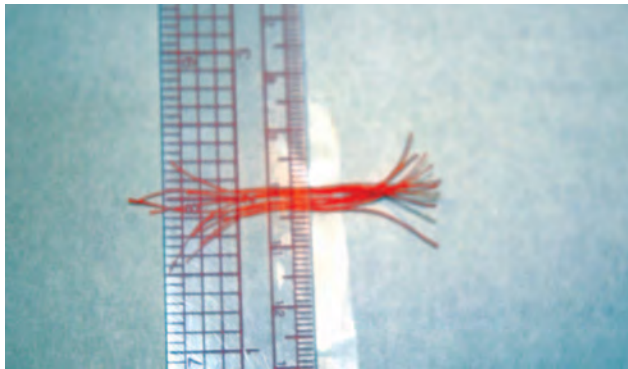

If a model aircraft is not available, the teacher or students can construct a mock aircraft by joining together four meter sticks for the wings, a single meter stick for the fuselage, and one or two meter sticks for the tail. The difficulty level across the class can be modified by giving each group a different assembly.

Objective: Support the airplane from a single point, with the fuselage and wings parallel to the ground, by first identifying the center of mass.

Students can estimate or calculate the center of mass of the airplane. Most simply, students can find the point at which the plane balances. Alternatively, students could weigh the airplane by placing at least three different points on three balances, and, using their understanding of torque, estimate the center of mass.



Objective: Using two vertical strings, determine where two strings must be attached to the wings to make the plane incline with 10 degrees from the ground.

This final task can be considerably more challenging. Because the airplane must be in static equilibrium, the airplane can be considered, along the fuselage, to act much like a lever pivoting around its center of mass. The placement of the two support points, as a result, must balance each other. The goal is to place the fuselage horizontal to the ground, but the wings at a 10 degree incline to the ground. In this particular case, net force in the z-axis must equal zero, and the torque in the x-axis and y-axis must add up to zero as well, respectively.

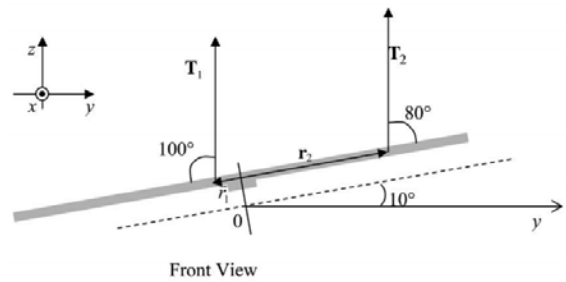
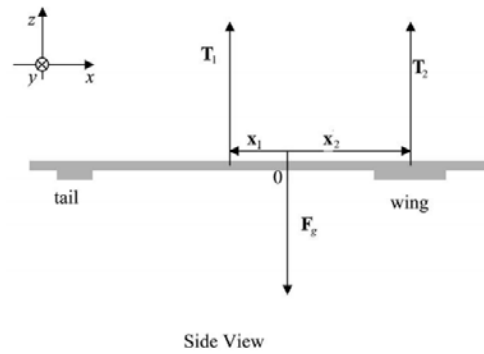

$$\sum F_z = T_1 + T_2 - F_g = 0$$

$$\sum \tau_y = T_1 x_1 - T_2 x_2 = 0$$

$$\sum \tau_x = T_2 r_2 \sin 80^\circ - T_1 r_1 \sin 100^\circ = 0$$

Using this system, knowing the weight of the aircraft, students can solve for T_1 , T_2 , and r_1 . Students should be reminded that there are multiple correct solutions to this problem, and that they can choose one variable to see the resulting variable, and determine if the values are within the appropriate range (i.e. wing span and length).

Again, this lab includes three parts with three different objectives. Encourage students to work through the full learning cycle for each part of the laboratory experience, either formally (in the form of a written notebook or report and explicit discussion) or informally (through small group and whole class discussion).

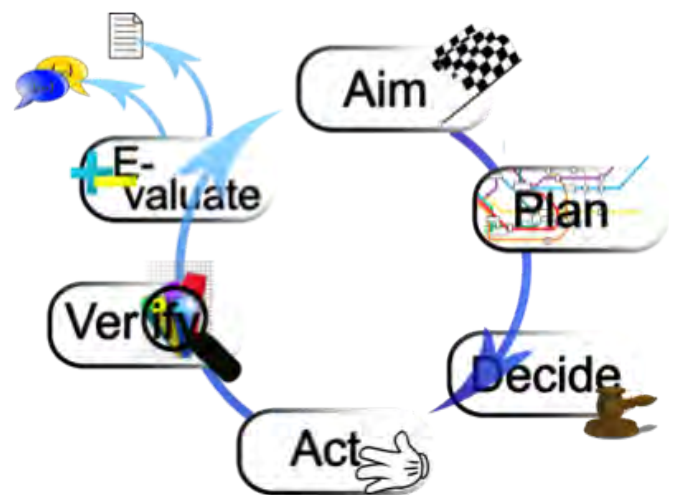

Student Worksheet: Hanging an Airplane

Objective: Determine the minimum number of strings required to support an aircraft by measuring tensile strength.

Tensile strength (σ) is the maximum force (F_{break}) supported by a string per unit of cross-sectional area (A), and is defined mathematically as

$$\sigma = \frac{F_{break}}{A},$$

1. Explain how you determined tensile strength of the string. Include sketches and/or images to demonstrate how you know that your value for tensile strength is accurate and precise.

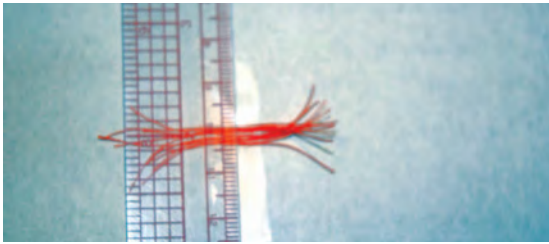

2. Your teacher has provided a model aircraft to you that must be suspended from a single point. How many strands of string must be used to support the airplane from a single point? Explain how you know.



Objective: Support the airplane from a single point, with the fuselage and wings parallel to the ground, by first identifying the center of mass.

3. Using any method you prefer (without yet suspending the airplane from the string), identify the center of mass of your airplane. Explain how you accomplished this.

4. Attach the string to your predicted center of mass of the plane to determine if, in fact, the plane balances. Get your teacher's approval. Teacher signature: _____

Objective: Using two vertical strings, determine where two strings must be attached to the wings make the plane incline with 10 degrees from the ground.

Unlike in the picture displayed below, the goal of this task is to make the airplane's fuselage **parallel** to the ground, with the wings titled 10 degrees with respect to the ground.

This activity requires that the plane be in static equilibrium. As a result, answer the following questions:



5. What will be the sum of all net forces on the plane? Explain.

6. Considering that the plane will be supported by two strings (with tension force T_1 and T_2), write an expression for the sum of all vertical forces on the plane in the box below:

Using a force meter, measure F_g and record it here: _____

7. Consider the two tension forces. Look at the airplane from the top perspective, where the dotted lines meet at the center of gravity of the airplane. Draw two dots to show in which quadrants the vertical strings must be placed in order to achieve a horizontal fuselage and titled wings. Provide a rationale for your answer. (There are multiple correct answers – consistency is key!)

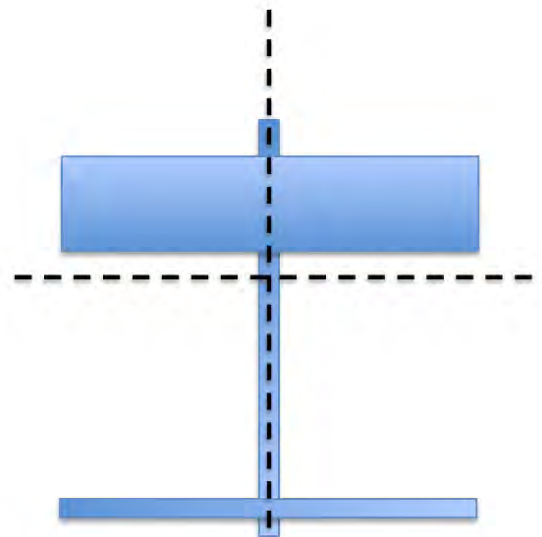

8. Consider the fuselage only. The goal is to have it parallel to the ground. Because we can think about rotation around any point as a result of torque, think about the airplane dipping forward and back about its center of gravity. Draw in lines showing the distance from the two dots normal to the wing (side-to-side axis), and label them as x_1 and x_2 . In this way, you can derive an expression for the torque exerted on each point, given the tension in the string and its distance from the wing (side-to-side) axis.

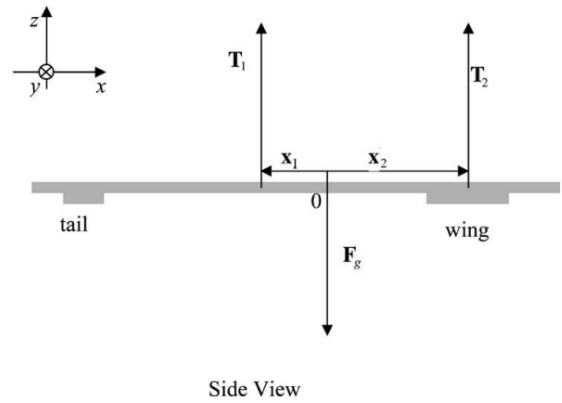

9. Using T_1 and T_2 , and x_1 and x_2 , write an expression for the sum of the torques along the fuselage's (tip-to-tail) axis. (Use the Side View image to help!)

10. There are multiple correct placements for x_1 and x_2 . Working only to get the fuselage horizontal to the ground, without concern for wing support, work to experimentally measure where those two locations are. Record them here: _____ and _____

11. Using the two expressions you developed in the two boxes above, solve for the value of T_1 (first), and then T_2 .

12. Check your actual tension values using a force meter. Get teacher approval to move on: _____

13. Now consider the 10 degree tilt of the wings. Using the front view diagram as a guide, write an expression for the torque of the wings along the fuselage's (front-to-back) axis. Recall that torque only considers the forces that are perpendicular to the surface.

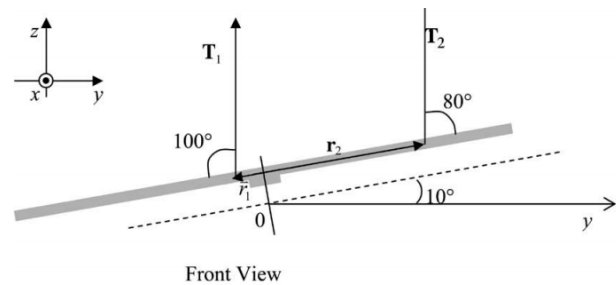

14. Work the strings around the plane until you have achieved a horizontal fuselage and a wing tilt of 10 degrees. Using your experimental values for r_1 and r_2 , x_1 and x_2 , now solve for the new values of T_1 and T_2 .
15. Check your answers with the use of a force meter, and get teacher approval:



NASA Model Flies at Air and Space

http://www.nasa.gov/topics/aeronautics/features/bwb_smithsonian.html#.VHOfy429-Rg

Analysis Questions

- The X-48B has no tail rudder, like typical aircraft. How does it make up for this loss of rudder control?
- The model was built for actual testing in a wind tunnel. Provide three reasons why scientists begin their work with a model before producing a full-sized aircraft.

Problem Set: Trimmed Aircraft Activity

Beginner's Guide to Aeronautics

BACKGROUND

An airplane in flight can be maneuvered by the pilot using the aerodynamic control surfaces; the [elevator](#), [rudder](#), or [ailerons](#). As the control surfaces change the amount of [force](#) that each surface generates, the aircraft [rotates](#) about a point called the [center of gravity](#). The center of gravity is the average location of the weight of the aircraft. The [weight](#) is actually distributed throughout the airplane, and for some problems it is important to know the distribution. But for total aircraft maneuvering, we need to be concerned with only the total weight and the location of the center of gravity.

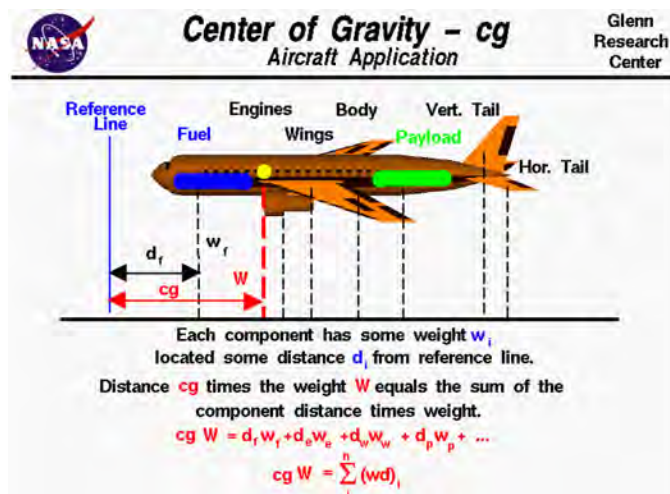

How do engineers determine the location of the center of gravity for an airplane which they are designing?

An airplane is a combination of many parts; the [wings](#), [engines](#), [fuselage](#), and [tail](#), plus the payload and the fuel. Each part has a weight associated with it which the engineer can estimate, or calculate, using Newton's [weight equation](#):

$$F_g = m * g$$

where F_g is the weight, m is the mass, and g is the gravitational constant which is 32.2 (ft/s)/s in English units and 9.8 (m/s)/s or N/kg in metric units. To determine the center of gravity [cg](#), we choose a reference location, or [reference line](#). The [cg](#) is determined relative to this reference location. The total weight of the aircraft is simply [the sum](#) of all the individual weights of the components.

Since the center of gravity is an average location of the weight, we can say that the weight of the entire aircraft F_g times the location [cg](#) of the center of gravity is equal to the sum of the weight F_g of each component times the distance [d](#) of that component from the reference location:

$$F_g * cg = [F_g * d](fuselage) + [F_g * d](wing) + [F_g * d](engines) + \dots$$

The center of gravity is the mass-weighted average of the component locations.

We can generalize the technique discussed above. If we had a total of "n" discrete components, the center of gravity [cg](#) of the aircraft times the weight F_g of the aircraft would be the sum of the individual i component weight times the distance [d](#) from the reference line ($F_g * d$) with the index i going from 1 to n. Mathematicians use the Greek letter sigma to denote this addition. (Sigma is a zig-zag symbol with the index designation being placed below the bottom bar, the total number of additions placed over the top bar, and the variable to be summed placed to the right of the sigma with each component designated by the index.)

$$F_g * cg = \text{SUM}(i=1 \text{ to } i=n) [F_g * d]i$$

This equation says that the center of gravity times the sum of "n" parts' weight is equal to the sum of "n" parts' weight times their distance. The discrete equation works for "n" discrete parts.

Problem Set

from *Beginner's Guide to Aeronautics*

[Student Worksheet](#)

[Teacher Answer Key](#)

A Boeing 747-400 domestic airplane is soaring the friendly skies (shown below). Use data from the [Boeing 747 Wikipedia website](#) to complete Table 1. Estimate values for data you are unable to locate in a reasonable amount of time. You will have to select an engine to go on your aircraft. You should be able to find the length of the airplane (for the reference distances requested), the mass of the engine, and the fuel capacity. The distances in Table 1 should be measured from a reference line that starts at the nose (front) of the 747. Use the BACK key to return to this page.

Problem 1 will guide you in the calculation to find the mass of the fuel.

All problems are expressed in metric units.

	Mass (kg)	Distance from Reference Line (m)	
payload			d_1
engine			d_2
wings			d_3
fuselage			d_4
fuel			d_5
vertical tail			d_6
horizontal tail			d_7

Table 1 : Airplane component masses and distances from reference line

1. What is the fuel capacity of the 747?

Fuel capacity = Volume of fuel = _____

2. Assuming the density of an average jet fuel is 0.75 g/ml, use the density equation,

$$\text{density} = \text{mass} / \text{volume},$$

to calculate the mass of the fuel. (**Hint:** You must convert from liters to milliliters.)

Mass of fuel = _____

Record this value for the mass of the fuel in Table 1.

3. In Table 2, record the weights of the components (parts) listed in Table 1.

(**Hint:** Remember, $F_g = mg = W$. The gravitational constant is 9.8 N/kg.)

	Mass (kg)	Distance from Reference Line (m)	
Payload			w_1
Engine			w_2
Wings			w_3
Fuselage			w_4
Fuel			w_5
Vertical Tail			w_6
Horizontal Tail			w_7

Table 2 : Airplane component weights

4. What does n equal?
 [Hint: The number n is the number of quantities being added together.]

$$n = \underline{\hspace{2cm}}$$

5. What are the values for i ?
 $i = \underline{\hspace{3cm}}$

6. What is the total weight W of the airplane?

$$W = \sum_i^n w_i = \underline{\hspace{2cm}}$$

7. What is the value of the sum of the component weights times their distances from the reference line (see the equation below)?

$$\sum_i^n (wd)_i = \underline{\hspace{2cm}}$$

8. Using your answers from Problems 6 and 7, calculate the center of gravity.

$$cg = \frac{\sum_i^n (wd)_i}{W} = \underline{\hspace{2cm}}$$

9. After a long flight, the amount of fuel left in the tanks is 20% of the initial amount. What is the mass and weight of the fuel that is left? Record your answers in Table 3.

	Mass (kg)	Weight (N)
Remaining Fuel		

Table 3 : Remaining Fuel Data

10. Recalculate the airplane's center of gravity with the reduced fuel weight.

$$cg = \frac{\sum_i^n (wd)_i}{W} = \underline{\hspace{2cm}}$$

11. Did the center of gravity change?
 a. If yes, by how many meters did the center of gravity move?
 b. If yes, did the center of gravity move toward or away from the nose of the airplane?
 c. Do you think the pilot would notice such a change in the center of gravity while flying? Why?

Problem Set

from *Beginner's Guide to Aeronautics*

[Student Worksheet](#)

[Teacher Answer Key](#)

The supply company you work for has just purchased a DC 8-62 cargo transport airplane. You will find the specifications for the new company "toy" below. The company has decided to promote you to ground crew supervisor. You are responsible for loading the DC 8-62 so that the center of gravity of the airplane is maintained at 75 feet (22.9 meters).

1. For the first flight, the cargo airplane is loaded with 2 Igloo cargo shells. The first fiberglass shell contains 4,550 pounds (lbs) of cargo and is located 40 feet from the reference point. The second aluminum shell contains 7,000 lbs of cargo and is located 110 feet from the reference point. The empty mass (see specifications) is located 75 feet from the reference point. Calculate the center of gravity of your aircraft. (**HINT:** Don't forget to add in the weight of the Igloo shell to the mass of the cargo.)
2. The second flight is loaded with 2 aluminum Igloo cargo shells each containing 9,590 lbs. Your ground crew has placed one container at 120 ft. from the reference point and the other at 90 ft. from the reference point. The empty mass is still located at 75 ft. Calculate the center of gravity of your aircraft . (**HINT:** Don't forget to add in the weight of the Igloo shell to the mass of the cargo.)
3. Did your first flight meet your required center of gravity specifications? If you answered no, go to Question 5.
4. Did your second flight meet your required center of gravity specifications? If you answered no, go to Question 5.
5. What correction would the pilot of the airplane have to make during flight to fly the airplane as it is loaded? Where would you move your cargo shells to get the center of gravity to equal the required 75 ft.?

DC 8-62

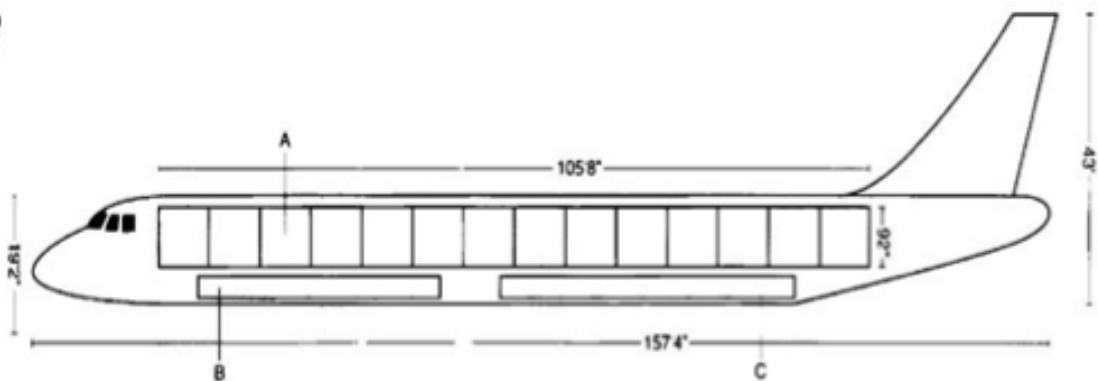

Forward Belly (bulk) - 800 cu. ft.
Aft Belly (bulk) - 815 cu. ft.
Main Cargo Door (A)- 85" high by 140" wide
Forward Belly Door (B) - 36" high by 44" wide
Aft Belly Door (C) - 36" high by 44" wide
Payload maximum - 90,000 lbs.
Empty mass - 136,600 lbs
Main deck cargo volume (containerized) - 6,160 cu. ft.
[thirteen (13) - 88" x 125" containers or pallets]

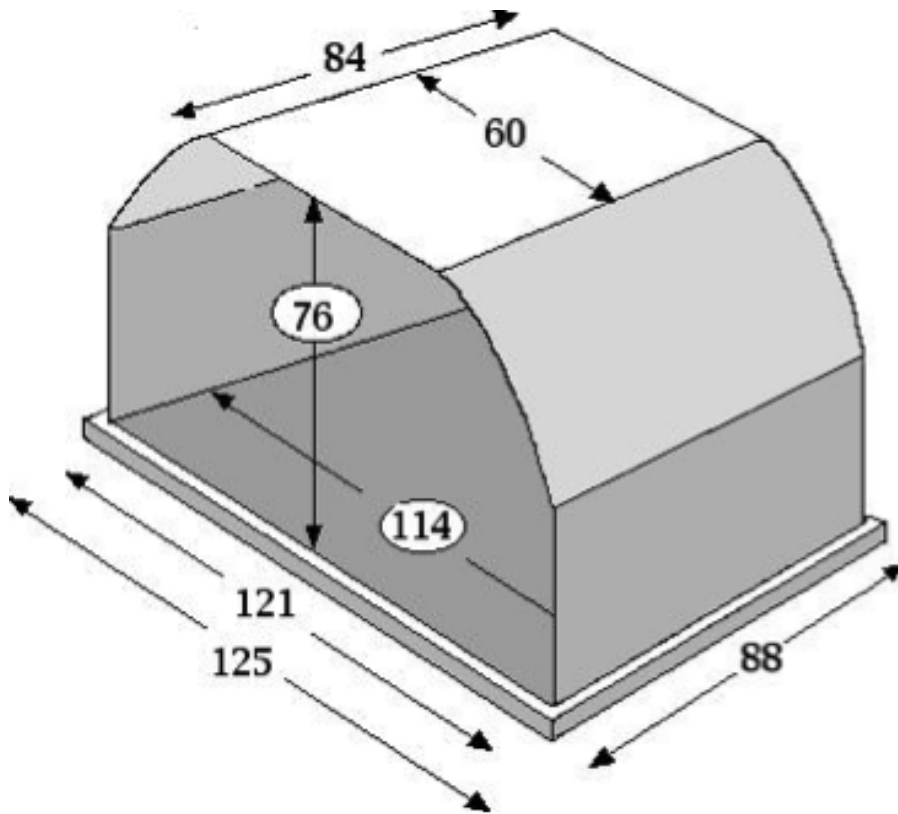

Emery Worldwide aircraft are units loaded utilizing Type A-3 containers and pallets. The Igloo illustrated, is an enclosed fiberglass or aluminum shell, open on one side and closed after loading with a fabric cover and straps. Pallets are essentially the same size as the Igloo, but without the permanent shell. Freight loaded on pallets is restrained with nets.

Inside dimensions - 121" long, 84" wide, 76" high

Pallet dimensions - 88" x 125"

Volume capacity - 450 cu. ft.

Maximum gross weight - 10,500 lbs.

Approximate tare weights: 410 lbs. - Aluminum shell; 520 lbs. - Fiberglass shell

Problem Set

from Beginner's Guide to Aeronautics

[Student Worksheet](#)

[Teacher Answer Key](#)

Suppose an airplane has a center of pressure on the wings that provides a wing lift force of W . The force W is located a distance d_w from the airplane's center of gravity (cg). The center of pressure on the tail provides a lift force of T . The force T is located a distance d_t from the airplane's center of gravity (cg). The lift force W will always be positive, which indicates an upward force. However, the lift force T can be positive for some airplanes (upward force) and negative (downward force) for other airplanes.

The plane is traveling to the left; the tail is on the right.

1. An airplane has a wing lift of 30,000 lbs. centered 20 feet to the right of the cg. The tail lift is centered 100 feet to the right of the cg. How much force must the tail lift supply in order to keep the plane from rotating? Is this force upward or downward?
2. Continuing with Problem 1, suppose the lift force is located 20 feet to the left of the cg. How much force must the tail lift supply in order to keep the plane from rotating? Is this force upward or downward?

(Hint: Distances measured to the right of the cg are positive while distances to the left are negative.)

Explain why the tail lift force is different in Problems 1 and 2 while the wing lift force is the same.

3. Consider Problem 1 again. Suppose the fuel tanks become significantly lighter after a long flight. This causes the cg to move toward the front of the plane (to the left). Will a change in the position of the cg of 10 feet to the left affect the previously trimmed (balanced) airplane? (Mathematically support your answer.)
4. If the movement of the cg causes the airplane to become unbalanced, what do you think the pilot will do to regain balance?
5. Consider Problem 2 again. Suppose the same thing that happened in Problem 4 happens in Problem 2. Will a change in the position of the cg of 10 feet to the left affect the previously trimmed (balanced) airplane? (Mathematically support your answer.)

ACTIVITY
Investigating Flight
with a Toy Helicopter



Objectives

Determine the relationship between frequency of helicopter propellers and lift.

Materials

RC helicopter
Electronic balance
Tape
Stroboscope

NGSS

CDI HS-PS2
SEP 1-7
CCC 2, 4

Inquiry Lesson/Lab: Investigating Flight with a Toy Helicopter

Michael Liebl. *The Physics Teacher*, 48, 458 (2010).

Although lift has traditionally been measured with the use of a wind tunnel and force meters, there is an alternative way to measure lift produced by a small remote-controlled helicopter. An electronic balance can be used to measure mass, which can then be converted into weight. Any decrease in “apparent mass” on the electronic balance is the result of a net upward force, called lift.

A small helicopter can be loaded onto an electronic balance and mounted with the help of bits of duct tape. By taring the balance and starting at “0,” any lift produced by the helicopter (up to the lift that is equal to its weight plus the platform to which it has been affixed, unless the helicopter itself cannot lift that mass) will be represented in the measurement unit with a negative value. Students can also measure the related frequencies of rotation of the propellers by using a stroboscope to perfectly match the frequency of the propellers until they appear stationary. (Note: Paint or mark ONE tip of a single rotor blade with a bright color or correction fluid in order to ensure that the same propeller wing is being matched with the frequency of the stroboscope). Once students understand how they can collect this information, they can be prompted to develop a model.



(Note: It is possible that teachers and students alike would expect the force reading on the electronic balance to read the same value, whether or not the helicopter is spinning. However, unlike a fan-cart and card scenario, in which internal forces cancel each other out, helicopters tend to push the column of air down and around them, not entirely on the plate below it. A variety of techniques can be used to minimize this “ground effect” on the balance reading. Consider mounting the helicopter on a tall stand a foot or so above the plate – this can be easily achieved by building a Lego or K’nex tower to support the helicopter. Alternatively, consider mounting the helicopter on the end of a meter stick lever suspended over the edge of a table, and measuring force with a force meter on the opposite side of the lever, as shown below.)

Image and idea credit:

Blanco, C. (2013), “Prop It Up! Static Thrust and Efficiency of Small Aircraft Propellers”, California State Science Fair Project J0105, online at <http://www.usc.edu/CSSF/History/2013/Projects/J0105.pdf>

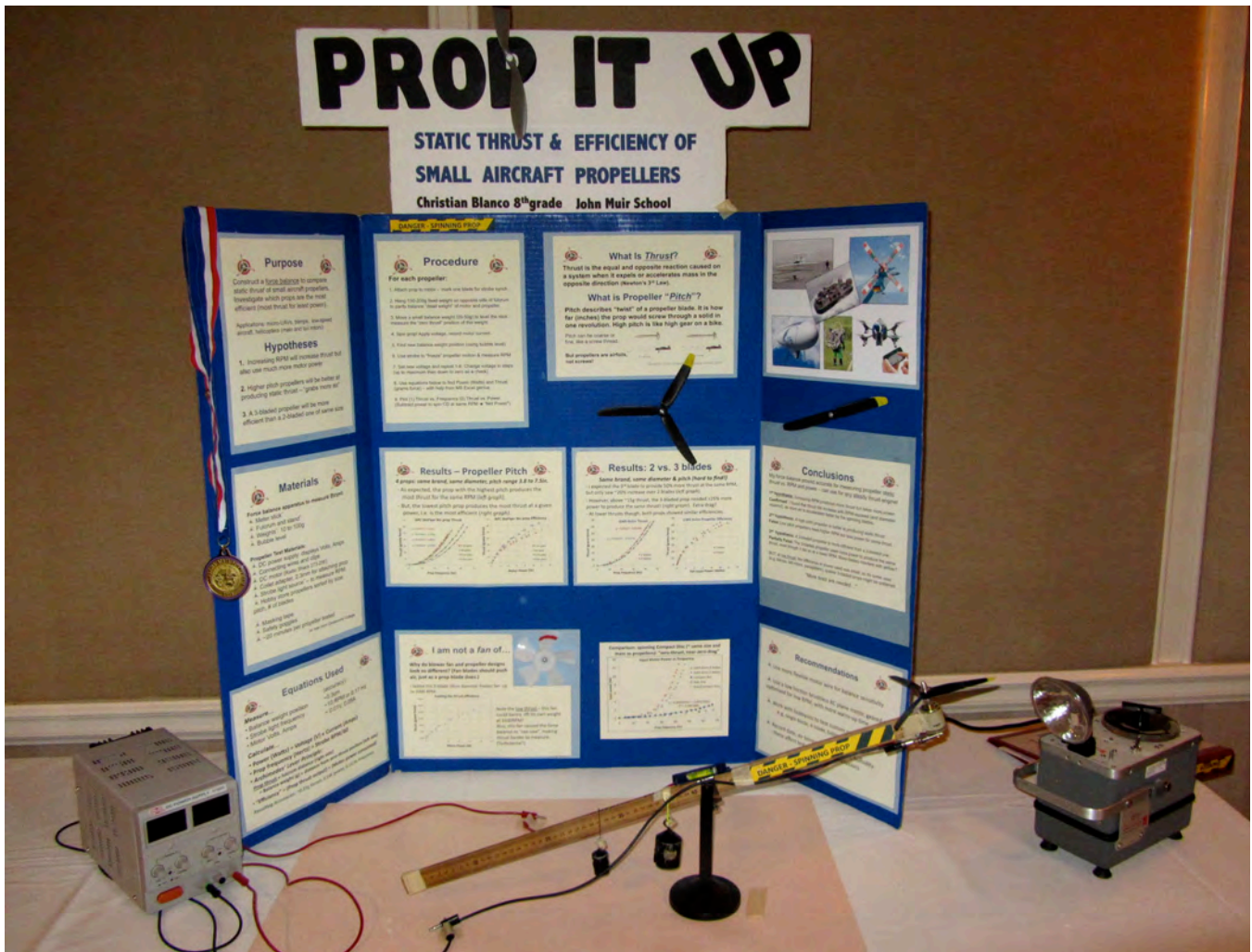

Teacher Background and Key: Investigating Flight with a Toy Helicopter

Achieving lift is a difficult task for heavy objects. As such, it is important to understand what factors influence lift – such as the frequency of propeller rotation – and how lift can be achieved in the most efficient way possible.

First, allow students to qualitatively determine the relationship between frequency and lift. Help them to note that the scale maxes out its “lift” reading once the lift equals the weight of the helicopter, and that data collection near at this high end of the data range might result in inaccurate values.

Next, help students learn how to use the stroboscope in order to determine the frequency of the propellers. (Caution: Check student medical records and ask students about any sensitivities to bright, flashing lights, as these are known triggers for many seizure disorders and some emotional traumas). Darken the room as much as possible (or, for observation by a single student, you can place the apparatus inside of a box or container), and flash the stroboscope as the helicopter propellers rotate. By holding the frequency of the propellers as steady as possible with the remote controller, adjust the stroboscope frequency until the propellers appear to be stationary. Once the frequency of the propellers and the frequency of the stroboscope match, students can record the value on the stroboscope. (Caution students to always use the lowest frequency possible – students might find variable harmonics if the frequency increases too much.)

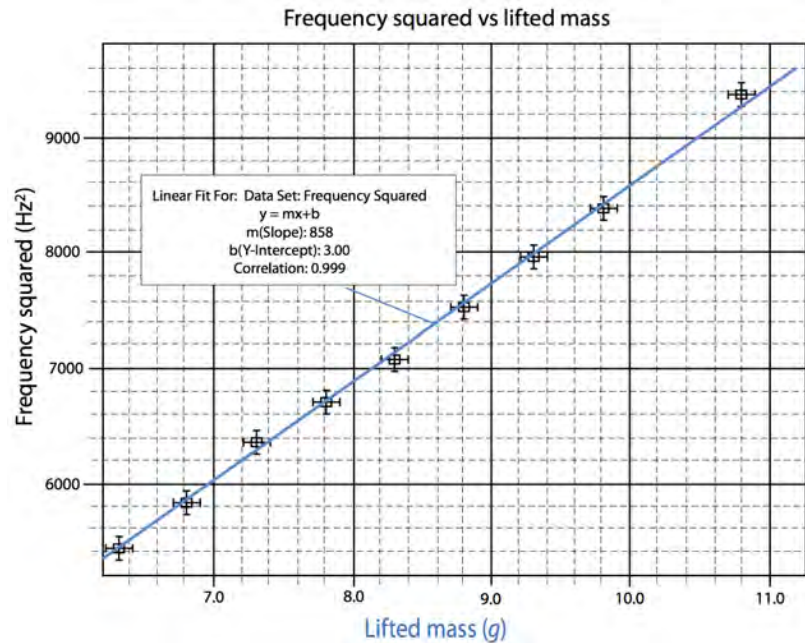

Goal: Determine the graphical and mathematical model relating frequency and lift.

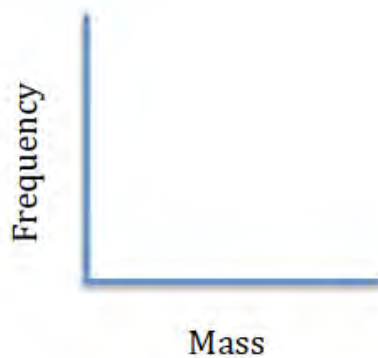

Ask students to collect as many data points as possible within a wide range of frequencies. Students should find that the relationship is a square-root curve. The data can be effectively linearized to result in a graph such as that developed by the article’s author and seen below.

Generally, students should find that

$$f^2 = k m \quad \text{or}$$

$$f = \sqrt{k m}.$$

Deriving a relationship from this particular data, students should get

$$f^2 = (858 \text{ Hz}^2/\text{g}) m + 3.00 \text{ Hz}^2.$$

Students can then hypothesize significance and meaning of slope and intercept. In this particular case, the slope likely has some relationship to the mechanics and physical design of the helicopter and its propellers. An interesting engineering challenge might be to attempt to minimize the slope of this graph by modifying the surface area and shape of the propellers.

An opportunity to test this theoretical data is to actually load the helicopter with a given mass, and to see at which minimum propeller frequency the helicopter is able to hover. Theoretically, aeronautical research regularly uses the principle of “ground effect” to maximize lift near the ground. Ground effect is an interruption of wingtip vortices and downwash that occurs behind a wing, causing drag on an aircraft. When this is interrupted and there is less drag, lift increases as a result. Hence, actual lift on the scale’s platform, derived from propeller rotations, is likely lower in the air, where ground effect has little impact.

The above mathematical model for the relationship between frequency and lifted mass can be derived from downward concentrations of airflow through the propellers. The complete derivation can be found in the full article from *TPT*. However, one interesting point to note is that helicopter blades are curved, with the greatest angle of attack nearest to the rotor. Because tangential velocity significantly increases near the edge of the propeller tip, less “twist” is needed to achieve the same lift.

Lifted mass (g)	Frequency (Hz)
10.8	97
9.8	91
9.3	89
8.8	87
8.3	84
7.8	82
7.3	80
6.8	76
6.3	74

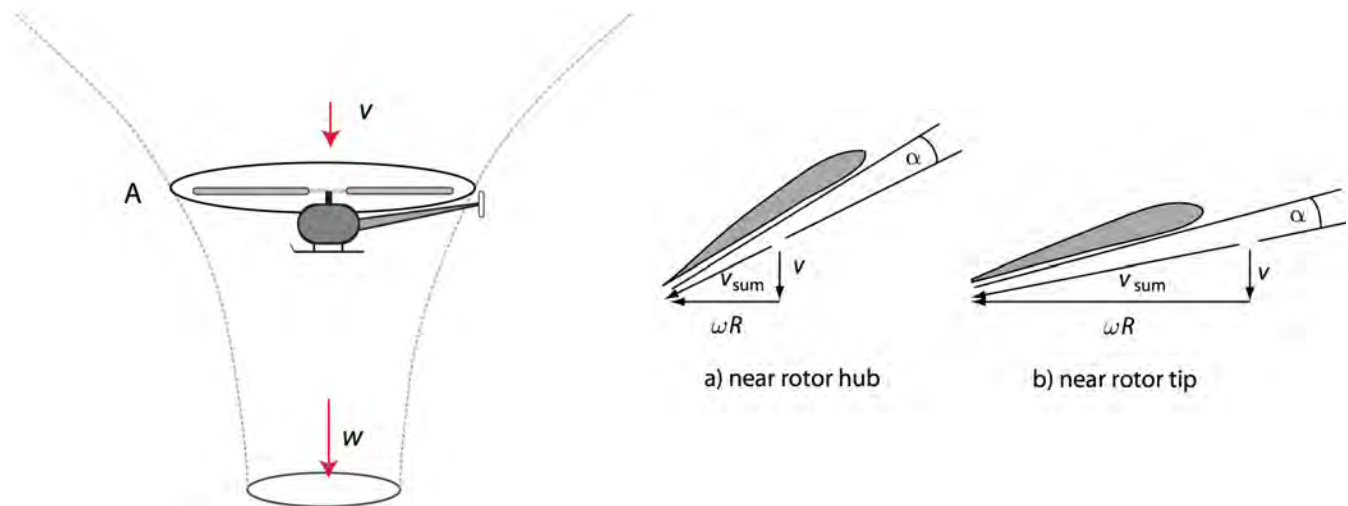

Student Worksheet: Investigating Flight with a Toy Helicopter

Achieving lift is a difficult task for heavy objects. As such, it is important to understand what factors influence it, and how it can be achieved in the most efficient way possible. One of the primary factors that influences lift of rotocraft is the frequency of rotation of the propellers.



Goal: Determine the graphical and mathematical model relating *frequency* and *lift*.



1. Get to know your helicopter – play with it and learn how to lift it off of the ground remotely. Plan how you will collect data on frequency and lift. If you are uncertain of how to measure frequency, ask your teacher for help! (Hint: Use a stroboscope!) To measure lift, consider using an electronic balance. With your small group, discuss how lift can be inferred from the reading on the balance.



2. Decide what data you will collect, and how you will go about doing it. Confer with your teacher to make sure that your plan is safe.



3. Collect your data below, plot it using a graphical analysis tool, and then sketch the general graph to the right:

4. Generally, what kind of relationship is displayed by your graph?

5. If appropriate, perform a linearization or curve fit. Write the general form of the equation below:



6. If you have any constants in your equation, what do they mean? What constants (or error) in your experiment might account for them?

7. Share your results with the class. What conclusions can you draw about the relationship you studied? Do you think there are any limitations to your study? Why or why not?
8. Most propellers (on RC helicopters and on standard aircraft) are “twisted.” Explain why! (Consider angular velocity).

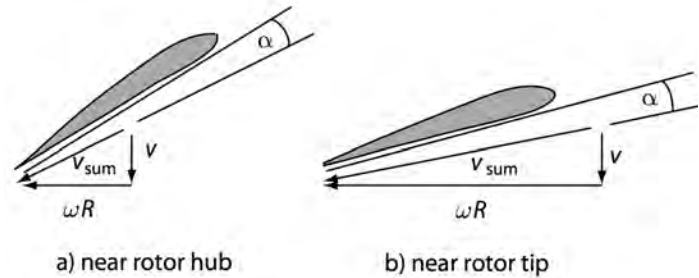

Future Helicopters Get SMART

http://www.nasa.gov/topics/aeronautics/features/smart_rotor.html#.VHOgJ429-Rg

Analysis Questions:

- Why are rotocraft currently not used for typical transportation, like airplanes?
- What would be a benefit of using rotocraft instead of airplanes, as a primary means for transportation in the future?
- What are piezoelectric materials, and what benefits could they offer rotocraft?



Objectives

Determine the relationship between the surface area and lift.

Materials

Fan
Pencils / Sticks
Notecards
Glue
Tape

NGSS

CDI HS-PS2
SEP 6
CCC 1, 2, 3, 6

Interactive Demonstration: Lift Demonstrations

Students are often incorrectly taught that the primary means for heavier-than-air flight is a result of Bernoulli's principle. While it is true that the cambered shape of an aircraft wing results in a lower pressure above the wing, and an increased pressure below the wing, the resulting upward force is only partially the cause for the overall lift of an aircraft. Additionally, some aircraft do not have cambered wings at all. Further, even those who speak of Bernoulli often attribute the effect to the theory of equal transit times of particles above and below the wing, which is a misconception and simply not true. Lift can be achieved on a variety of wing shapes, including simple airfoils made from paper.



A discussion of Newton's third law of motion more accurately represents how lift is achieved in this case. Because of the way wings obstruct air particles, air is deflected downward, resulting in an upward force on the wing. However, even this perspective can be oversimplified to a fault, and can result in student misconceptions. Air particles do not simply move directly toward the wing, hit it, and then reflect off. In contrast, air behaves much more smoothly and in "sheets." (Hence, smoke contrails are seen to smoothly go around airfoils, and might not encounter any obstruction). Air particles interact with other air particles, and indirectly are affected by the wing even before arriving at it.

To demonstrate this effect, students or teachers can prepare note cards on sticks or long pencils. Area #1 can be achieved by taking two note cards (one above the other), and Area #2 can be achieved by pasting the two cards together, giving the same weight, but half the surface area. The airfoils can then be suspended from the ends of the pencils and held in the stream of a fan. Students should quickly and easily realize that lift is much greater on an object with greater surface area. For more information on lift, see: <http://goo.gl/m88nr1>



ACTIVITY
Measuring Lift with
Wright Airfoils



Objectives

Determine graphical models that relate lift and drag forces to wind speed, surface area, angle of attack (and stall angle), camber, and aspect ratio.

Materials

Rotating platform
Soda can and scissors
Tin and tin snips (optional)
PVC pipe
Wind source
Pulley system
Small masses or force meter
Wind speed sensor (mechanical or digital anemometer probe, Prandtl pressure probe, and / or a manometer)

NGSS

CDI HS-PS2
SEP 1-7
CCC 2, 4, 6

Inquiry Lesson/Lab: Measuring Lift with the Wright Airfoils

Richard M. Heavers & Arianne Soleymanloo. *The Physics Teacher*, 49, 502 (2011).

A large portion of aeronautics research is conducted within wind tunnels: open or closed systems in which gases of varying speeds, pressures, and temperatures bombard a full-scale or model aircraft or aircraft part, such as a wing cross-section.

From the previous lift demonstrations, it should be apparent to students that wind speed, surface area, and angle of attack all have a significant impact on the lift experienced by an airplane wing. Although there are a number of options to buy commercial wind tunnels for the high school laboratory, the following is a smaller-scale, cheaper approach to creating a wind tunnel to test miniature airfoils.

Most scientific probeware companies such as Pasco and Vernier offer rotating rods or plates for the study of rotational motion. A protractor can be mounted onto the end in order to help students align the airfoil with a given angle of attack. A make-do miniature wind tunnel (made with a large PVC pipe and a wind source such as a leaf blower, hair dryer, or focused box fan) can be aligned with the rotating rod or plate.

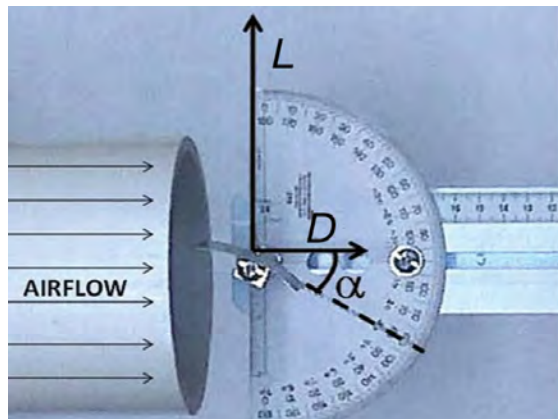

A small airfoil can be constructed out of tin or other malleable metal that retains its shape easily but can also be bent to change its shape/camber/aspect ratio. (However, before introducing these variables, it is best to begin with a flat plate airfoil). Aluminum soda cans provide a cheap source of tin. Using tin snips, a variety of airfoils can be created with varying amounts of surface area. (Caution: Metal can have very sharp corners and edges. Always caution students to use protective eyewear when cutting the tin). The airfoil can also be mounted on the end of the rotating rod or plate in such a way as to change its angle of attack. A dab of glue from a hot glue gun allows for easy mounting and removal of the airfoil.

Once the air source is turned on and the airfoil is exposed to the wind, the rotating plate or rod will tend to move toward one direction. By simply touching the opposite end of the rod, students can literally feel the force of the lift produced by the airfoil. To quantify this, the end of the rod can be connected via a pulley system, and mass added to a small hanger to equal the rotating plate or rod until it is “balanced” in the wind.

Wind speed can be measured with the use of a mechanical or digital anemometer probe.

Given all of these materials, students can measure lift (or drag, if the apparatus is rotated by ninety degrees) as they relate to each of the following variables. See [Wing Geometry Definitions](#) for further information.

- wind speed (relative speed)
- surface area
- angle of attack
- camber
- aspect ratio

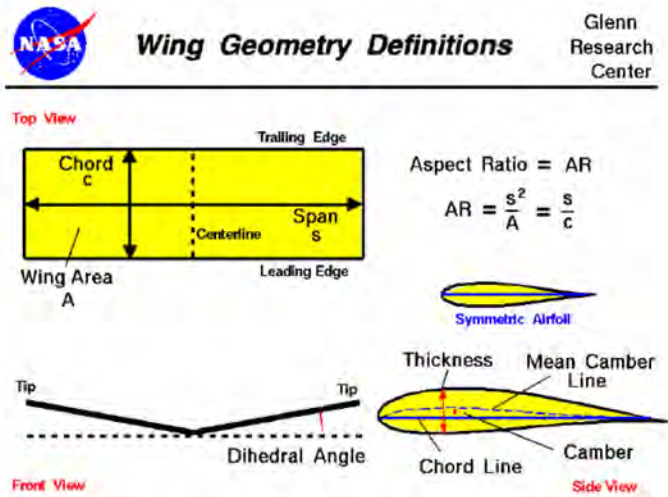
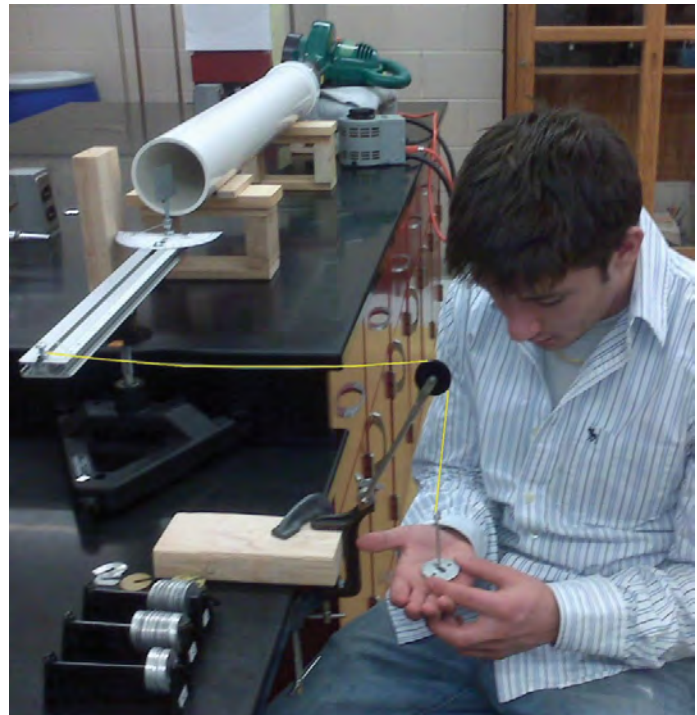

Although the following student worksheets do not explicitly address each of the stages of the learning cycle for its repetitive nature in this kind of in-depth study with multiple parts, ensure that students address each step.

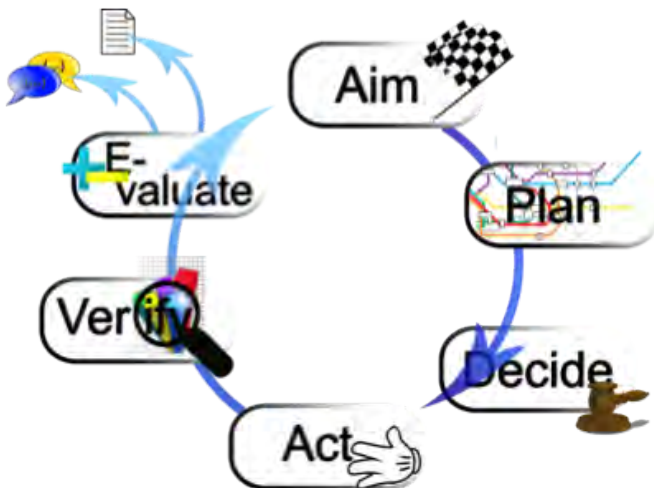

Teacher Guide/Key: Measuring Lift with Wright Airfoils

Goal: Determine the mathematical and graphical models relating lift and wind speed.

From simple experiments with a fan and a pie pan, students can see that an increase in wind speed increases the lift on an airfoil. (Likewise, when driving in an open area, students might have placed their hand out a window, tilted it up slight, and experienced the upward push of the wind on their hands).

In this and the following experiments, students modify variables associated with air flowing around a tin airfoil. *Begin by having students work with a flat plate airfoil.* Doing this helps students to challenge the misconception that lift can only be produced on an curved airfoil. *Curvature can later be introduced during the study of camber.*

Perhaps the easiest way to modify wind speed is to use a fan with multiple speed settings. An anemometer can be used to measure the wind speed. Given that a wind-tunnel effect produced by a standard fan is likely to have only a small cross-section of constant air flow, it is preferable to use a very small anemometer as opposed to a wide, mechanical one. Alternatively, students can change the wind speed by changing the wind source – hair dryer, fan, leaf blower, etc.

In general, students should find that the lift is proportional to speed squared. Hence, a plot of lift versus speed will result in a parabolic curve.

$$F_L \sim v^2$$

Goal: Determine the mathematical and graphical models relating lift and surface area.

Students can cut out various tin airfoils of different surface areas. If the concept of **aspect ratio** has not yet been introduced to students, help them to understand that it is also a variable that must also be accounted for. (Aspect ratio is the ratio of the long side to the width of the rectangle, or L/W). Not only should students be careful to maintain aspect ratio, but they also must be careful to mount the airfoil in the same way, so that the leading edge of the airfoil is either the length or the width.

This is also an opportunity to introduce to students to the concepts of **camber**. Many students are used to seeing airfoils that are curved – these airfoils have a **camber**. In its simplest form, camber of a curved airfoil can be calculated by taking the length of the chord (from the leading edge to the trailing edge) divided by the thickness of the airfoil (from the chord to the highest point of the curve). While this is beneficial for optimizing the lift/drag ratio at big angles of attack, it is not necessary in order to generate lift. For the purposes of studying surface area, it is probably best to avoid having any curvature at all.

Lastly, students must also ensure that **angle of attack** is controlled throughout this experiment. The **angle of attack** refers to the angle from the direction of the wind measured against the chord of the airfoil (which, for a flat airfoil, would simply measure to the surface of the airfoil). Students may choose any angle of attack they like, but the angle tends to be small for most aircraft (around 3-5 degrees above or below the horizontal, depending upon if the airplane is gaining or losing altitude). Angles above 15-30 degrees, depending upon the airfoil, will tend to result in a stall – a dramatic decrease in lift and increase in drag. (Caution: This result might not be reproducible for a model wind tunnel using a low wind speed and a self-made airfoil, as the wind only blows under the airfoil at some point).

Students should find that the relationship between lift and surface area is linear.

$$F_L \sim A$$

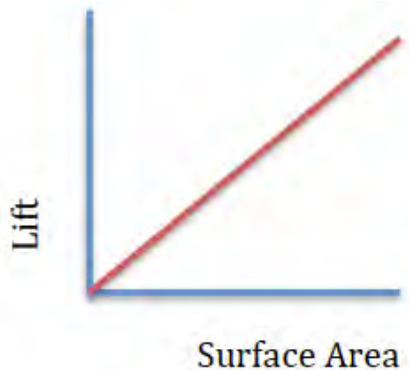
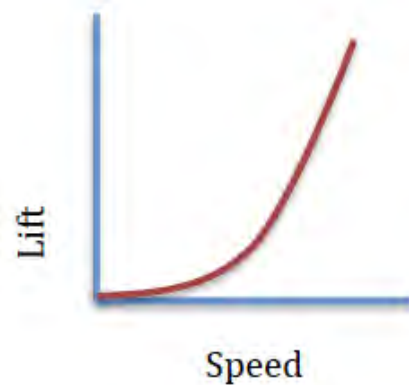

Combining the relationship between lift and air speed, and lift and surface area, it can be easy to derive the expression

$$F_L = k_1 A v^2.$$

This relationship offers a wonderful opportunity to perform some dimensional analysis to determine the meaning and source of k_1 . Substituting basic dimensions M (mass), L (length), and T (time), the equation above can be represented as

$$\frac{M}{L} = k_1 (L^2) \left(\frac{L^2}{T^2} \right).$$

The above relationship can be simplified and solved for the dimensions of k_1 .

$$M = k_1 (L^3)$$

$$k_1 = M/L^3$$

Students should recognize that these units, in SI notation, would be kg/m^3 , representative of a measure of density!

By using data points from both graphs for the airfoil in the same situation, students will, however, find that the value of k_1 is ridiculously high to be the density of the fluid (air) surrounding the airfoil.

The constant, k_1 , although it does include a measure of fluid density, is dependent upon a number of situational variables. Hence:

$$F_L = k_2 \rho A v^2$$

Students should consider other variables that influence lift, including, most notably, the shape of the airfoil (camber and aspect ratio) and angle of attack. Likewise, all of these variables can be evaluated for their effect on lift.

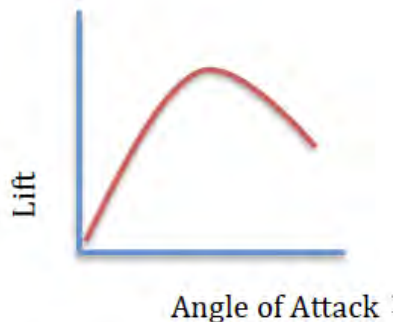

Students can then be asked to perform a number of other experiments to determine relationships. Lift and angle of attack are perhaps the easiest of the remaining three variables to study, although its relationship cannot be readily developed into a mathematical model.

Goal: Determine the graphical model relating lift versus angle of attack (and the stall angle).

As the angle of attack increases from zero, the lift increases, initially. The lift then reaches a maximum value until just before it hits the stall angle. At this point, lift decreases as angle of attack increases, because most of the momentum transfer from the wind now pushes the airfoil backward as opposed to upward.

Goal: Determine the graphical model relating lift and camber.

Students can change the camber of an airfoil by curving it various amounts. Generally, as camber increases, lift increases, within reasonable limits.

Goal: Determine the graphical model relating lift and aspect ratio.

Students can change the aspect ratio of an airfoil by cutting out rectangular foils of the same surface area, but different lengths and widths. Generally, as aspect ratio increases, lift increases.

The above three relationships are not linear, and they are not simple. However, using simple calculus, it can be demonstrated that k_2 is composed of a coefficient of lift (which depends upon the angle of attack, camber, and aspect ratio) and the constant, $\frac{1}{2}$. This relationship can be developed and helps students to see that lift is actually generated by the conservation of energy and mass.

For a moving object (such as in fluid flow),

$$F_{net} = ma = m \frac{\Delta v}{t}$$

$$F_{net}t = m\Delta v = \text{impulse}$$

$$E_{motion} = \frac{1}{2}mv^2$$

$$\frac{dE_{motion}}{dv} = mv$$

$$F_L = \frac{1}{2}\rho C_L A v^2$$

$$\frac{dF_L}{dv} = \rho C_L A v$$

There are plenty of opportunities to engage in data analysis with the relationships demonstrated from what is collected. The following is a display of some example data provided by the article's authors.

Perhaps the most important aspect in studying the angle of attack is identifying the "peak" of lift force, which shows the angle at which lift force begins to decrease. This is known as the "stall angle," and should never be exceeded unintentionally, as it results in loss of control of the aircraft.

Goal: Develop a visual and descriptive model for why long, narrow airfoils produce more lift at small angles of attack, as compared to square airfoils with the same surface area and camber.

Students can develop visual and descriptive models to explain the molecular and fluid behaviors resulting in varying lift forces. Because it is a chaotic system, this kind of modeling can be hard to do accurately.

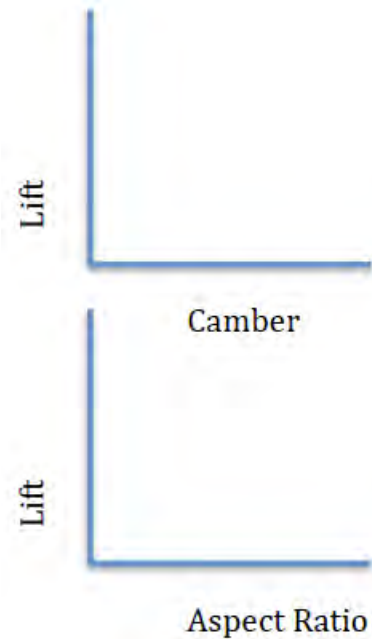

Table I. Airfoil parameters. Values for the Wrights' airfoils are given in parentheses where they differ from ours. Dimensions of airplane wings are in meters.

Airfoil	Length (cm)	Width (cm)	Aspect Ratio = length/width	Camber= height/width	Stall Angle (degrees)
#4	4.58 (6.22)	4.58 (6.22)	1	1/12	35 (32.5)
#6	4.58 (6.22)	4.58 (6.22)	1	1/20	35 (32.5)
#7	8.26 (15.24)	2.54	3.25 (6)	1/12	22.5 (17.5)
#9	8.26 (15.24)	2.54	3.25 (6)	1/20	22.5 (17.5)
1903 Flyer ³	13.5 m	2.0 m	6.8	1/20	—
Modern Transport ⁶	52 m	9.5 m	5.5	—	—

One thing that can help students is to have them observe fluid flow visually. Flow can be seen using a piece of glass and an airfoil section (perhaps made out of Styrofoam, clay, or gelatin to easily modify the airfoil), and then slowly pouring colored water around it.

See <http://amasci.com/wing/lasrWing.gif> for an example of fluid flow around wings.

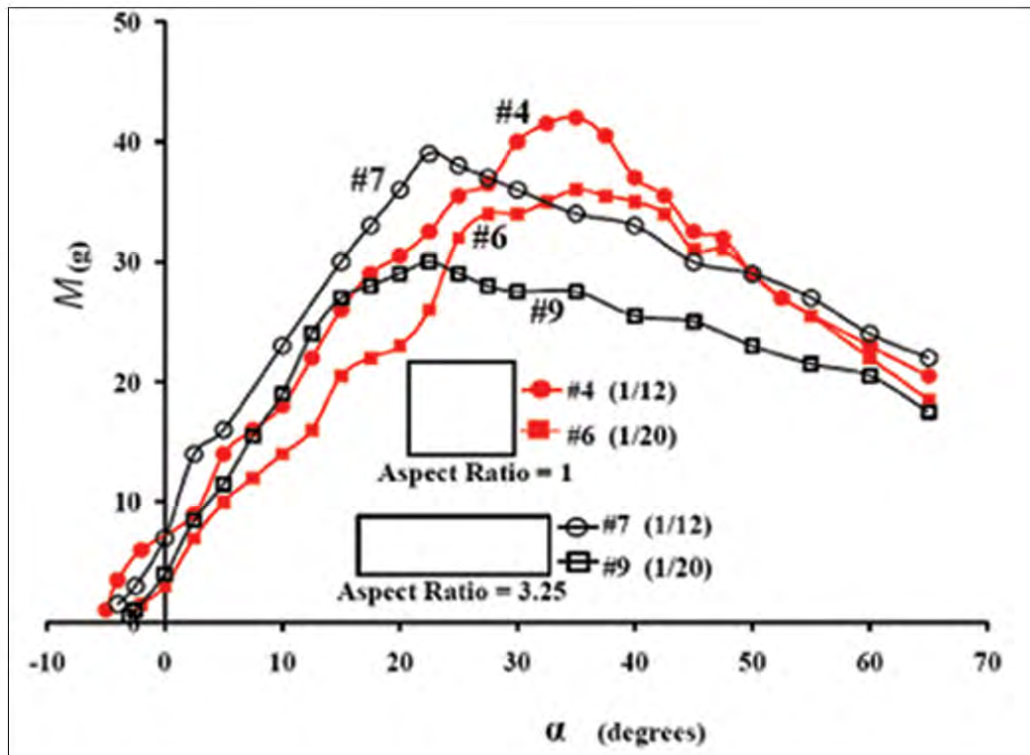

Fig. 3. Lift plots (mass M versus angle of attack α) for four airfoils with the same area. Camber is 1/12 or 1/20. Airfoils #4 (1/12) and #6 (1/20) are square; airfoils #7 (1/12) and #9 (1/20) are rectangular.

Student Worksheet: Measuring Lift with Wright Airfoils

In the mid to late 1800s, the use of wind tunnels to test the effectiveness of airplane wing shapes became popular. In the early 1900s, the Wright brothers also began completing their own tests, to determine which kind of airfoil would generate the most lift.

1. What kinds of design aspects do you think influence the lift produced by a wing?

To measure how much wind impacts an airfoil, create a setup following your teacher's guidelines. Ensure that the device – with the mounted airfoil – is balanced before you turn on the wind generator/fan. (The rotating rod should not tend toward one direction or the other).

2. Turn the wind generator on. The airflow should cause the entire rotating rod to turn toward one direction. Explain why this happens by annotating the image of wind currents and an airfoil below:



3. Looking at your setup, explain how you will determine the *lift* on the airfoil produced by the wind.

Goal: Determine the mathematical and graphical models relating *lift* and wind *speed*.

4. If you have ever tried to take a kite out gliding on a calm day, you know that wind speeds makes a big difference on lift! Perform an experiment to determine the relationship between lift and wind speed. Collect your data below, then draw a sketch of the graph.

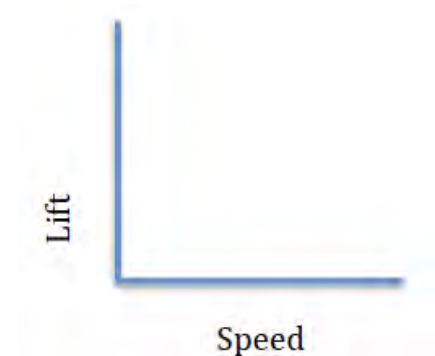

5. What is the general mathematical model of the relationship displayed by the graph?

Goal: Determine the mathematical and graphical models relating *lift* and surface area.

6. Perform an experiment to determine the relationship between lift and wind speed. Collect your data below, then draw a sketch of the graph.

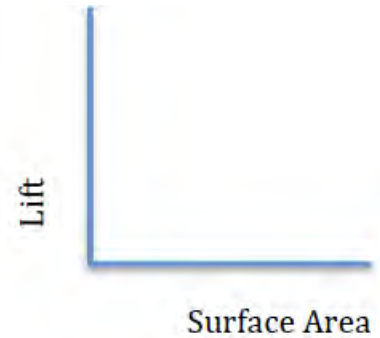

7. What is the general mathematical model of the relationship displayed by the graph?
8. Combining the two relationships (from lift and air speed, and lift and surface area), to form a single equation with an unknown constant:
9. Using what you know about the units for lift (N), speed (m/s), and surface area (m²), perform dimensional analysis to determine the units of the unknown constant.
10. Based upon the unit for the unknown constant, what might be the meaning of this constant? Perform data analysis to determine what the unit might be. Ask your teacher for assistance, if necessary.

Aeronautical engineers combine all of these known variables into something called the “Lift Equation,” which, after discussing with your classmates, your teacher will help you to derive here:

Extension

You will likely find that the unknown constant is actually a combination of constants associated with both the nature of the fluid flowing around the airfoil as well as the physical characteristics of the airfoil. We will study three of these variables.

Goal: Determine the graphical model relating *lift* versus *angle of attack* (and the stall angle).

11. Perform an experiment to determine the relationship between lift and angle of attack. Be certain to collect data from 5 to 50 degrees. Collect your data below, then draw a sketch of the graph.

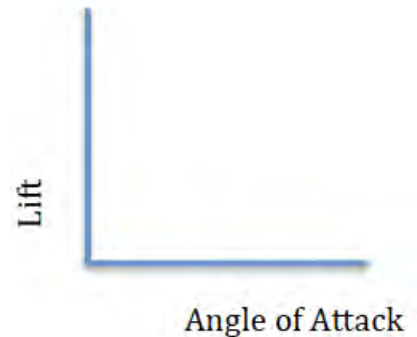

12. Describe, in words, the relationship displayed by the graph.
13. Your graph should display a maximum value known as the “stall angle.” Based upon your graph and your understanding of aeronautical “stall,” explain what happens to a plane at this point, and why.

Goal: Determine the graphical model relating *lift* and *camber*.

14. Perform an experiment to determine the relationship between lift and camber. Collect your data below, then draw a sketch of the graph.

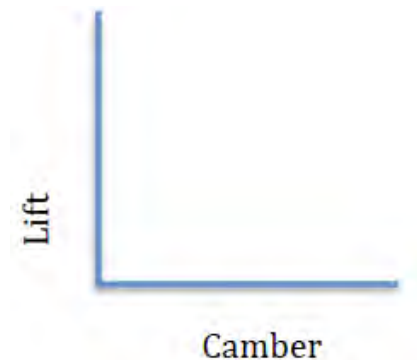

15. Describe, in words, the relationship displayed by the graph.

Goal: Determine the graphical model relating lift and aspect ratio.

16. Perform an experiment to determine the relationship between lift and aspect ratio. Be certain to collect data from 5 to 50 degrees. Collect your data below, then draw a sketch of the graph.

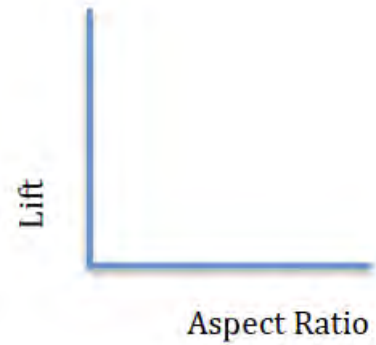

17. Describe, in words, the relationship displayed by the graph.

18. Look at some data provided by another group of students and even the Wright brothers themselves. How well does your data compare? If you find that you observed other trends, explain why this might be the case.

Table I. Airfoil parameters. Values for the Wrights' airfoils are given in parentheses where they differ from ours. Dimensions of airplane wings are in meters.

Airfoil	Length (cm)	Width (cm)	Aspect Ratio = length/width	Camber = height/width	Stall Angle (degrees)
#4	4.58 (6.22)	4.58 (6.22)	1	1/12	35 (32.5)
#6	4.58 (6.22)	4.58 (6.22)	1	1/20	35 (32.5)
#7	8.26 (15.24)	2.54	3.25 (6)	1/12	22.5 (17.5)
#9	8.26 (15.24)	2.54	3.25 (6)	1/20	22.5 (17.5)
1903 Flyer ³	13.5 m	2.0 m	6.8	1/20	—
Modern Transport ⁶	52 m	9.5 m	5.5	—	—

Goal: Develop a visual and descriptive model for why long, narrow airfoils produce more lift at small angles of attack, as compared to square airfoils with the same area and camber.

19. Using the graph to the right, attempt to explain why airfoils of different angle of attack, aspect ratio, and camber, all result in different amounts of lift. Consider component forces, drag, Coander effect, boundary layer, turbulence, measuring errors, Bernoulli's principle, etc.

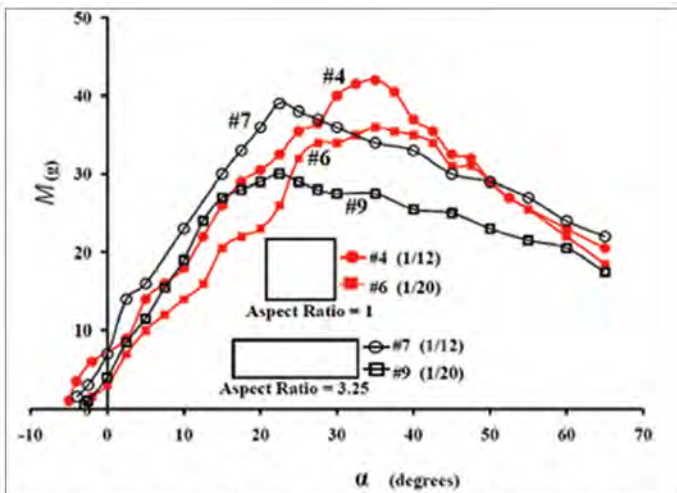

Fig. 3. Lift plots (mass M versus angle of attack α) for four airfoils with the same area. Camber is 1/12 or 1/20. Airfoils #4 (1/12) and #6 (1/20) are square; airfoils #7 (1/12) and #9 (1/20) are rectangular.



Glow With the Flow

http://www.nasa.gov/aero/flow_patterns_image.html#.VHTRmY29-Rg

Analysis Questions:

- Describe the technique observed in the picture. How are scientists visualizing airflow?
- Do a quick Internet search to find out what other information can be collected from wind tunnel tests (list at least three, and how they are collected).

Problem Set: Lift-Velocity Relationship Problems

[Beginner's Guide to Aerodynamics](#)

BACKGROUND

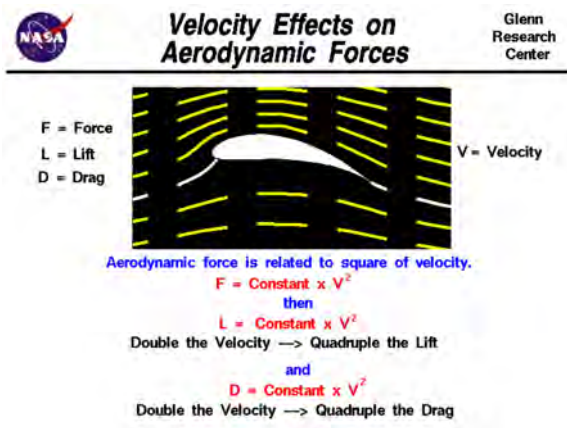

NASA Glenn Research Center

Velocity Effects on Aerodynamic Forces

F = Force
L = Lift
D = Drag

V = Velocity

Aerodynamic force is related to square of velocity.
 $F = \text{Constant} \times V^2$
then
 $L = \text{Constant} \times V^2$
Double the Velocity \rightarrow Quadruple the Lift
and
 $D = \text{Constant} \times V^2$
Double the Velocity \rightarrow Quadruple the Drag

Lift is created by deflecting a flow of air and drag is generated on a body in a wide variety of ways. From Newton's second law of motion, the **aerodynamic forces** on the body (lift and drag) are directly related to the change in momentum of the fluid with time. The **fluid momentum** is equal to the mass times the velocity of the fluid. Since the air moves, defining the mass gets a little tricky and aerodynamicists usually relate the effect of mass on lift and drag to the air density. The mathematical derivation for this conversion is given on another slide dealing with momentum effects on lift. As a result of this derivation, we find that lift and drag depend on the **square of the velocity**. The velocity used in the lift and drag equations is the relative velocity between an object and the flow. Since the aerodynamic force depends on the square of the velocity, doubling the velocity will quadruple the lift and drag.

PROBLEM SET

[Student Worksheet](#)

[Teacher Answer Key](#)



You may have been wondering about the photo of the “Spirit of St. Louis” above. We will now use our lift/velocity relationship information on an imaginary flight in the Spirit of St. Louis where we again maintain altitude. Data needed to continue is found at “[Ryan, Spirit of St. Louis.](http://en.wikipedia.org/wiki/Spirit_of_St._Louis)” (http://en.wikipedia.org/wiki/Spirit_of_St._Louis)

1. Find “k” as above using the Spirit of St. Louis maximum velocity and the takeoff weight less 20 kg (an arbitrary amount of fuel to attain maximum velocity). Once you have determined k, write an equation for velocity as a function of lift (as in our example). $v = \underline{\hspace{2cm}}$.

2. Using a function grapher (such as your graphing calculator), graph this equation (default window settings are acceptable). Do you recognize the graph? It is a $\underline{\hspace{2cm}}$.

3. Now key in the following RANGE window values: $x_{\min} = 1000$, $x_{\max} = 2500$, $x_{\text{scl}} = 100$, $y_{\min} = 120$, $y_{\max} = 220$, $y_{\text{scl}} = 10$, and graph the equation. Because the domain and range are limited to real Spirit of St. Louis values, the curvature of the parabola segment is limited.

4. Return to the equation and solve it for lift. $L = \underline{\hspace{2cm}}$. Graph the equation. Then exchange the x and y values in the RANGE window; that is, key in: $x_{\min} = 120$, $x_{\max} = 220$, $x_{\text{scl}} = 10$, $y_{\min} = 1000$, $y_{\max} = 2500$, $y_{\text{scl}} = 100$, and graph. The parabola segment now opens upwards, instead of to the side.

(Note: You may wish to try this for other aircraft.)

Problem Set: Lift Equation Problems

Beginner's Guide to Aerodynamics



The Lift Equation

Glenn
Research
Center



$$L = C_L \times \frac{\rho \times V^2 \times A}{2}$$

Lift = coefficient x density x velocity squared x wing area
two

Coefficient C_L contains all the complex dependencies
and is usually determined experimentally.

Lift depends on the density of the air, the square of the velocity, the air's viscosity and compressibility, the surface area over which the air flows, the shape of the body, and the body's inclination to the flow. In general, the dependence on body shape, inclination, air viscosity, and compressibility is very complex.

One way to deal with complex dependencies is to characterize the dependence by a single variable. For lift, this variable is called the lift coefficient, designated " C_L ." This allows us to collect all the effects, simple and complex, into a single equation. The lift equation states that lift L is equal to the lift coefficient C_L times the density ρ times half of the velocity v squared times the wing area A .

$$L = C_L * A * .5 * \rho * v^2$$

For given air conditions, shape, and inclination of the object, we have to determine a value for C_L to determine the lift. For some simple flow conditions and geometries and low inclinations, aerodynamicists can determine the value of C_L mathematically. But, in general, this parameter is determined experimentally.

In the equation given above, the density is designated by the letter " ρ ." We do not use "d" for density, since "d" is often used to specify distance. In many textbooks on aerodynamics, the density is given by the Greek symbol ρ - "rho" (Greek for "r"). The combination of terms "density times the square of the velocity divided by two" is called the dynamic pressure and appears in Bernoulli's pressure equation.

You can view a short movie of Orville and Wilbur Wright discussing the lift force and how it affected the flight of their aircraft. The movie file can be saved to your computer and viewed as a podcast.

1. Identify each letter in the lift equation and list acceptable units for each quantity.
2. Use Wikipedia (http://en.wikipedia.org/wiki/Boeing_747), or a search engine, to find information about the Boeing 747. What is its wing area?
3. If the Boeing 747 above is cruising at 940 km/h, the density of the air is 1.20 g/L, and the lift coefficient is 1, what is the lift?
4. Use Wikipedia (http://en.wikipedia.org/wiki/Boeing_777), or a search engine, to find information about the Boeing 777. What is its wing area?

5. If the Boeing 777 is cruising at the same velocity under the same conditions as the 747 above, what is its lift?
6. Look up the DC-8 on [Wikipedia](http://en.wikipedia.org/wiki/DC-8) (<http://en.wikipedia.org/wiki/DC-8>), or a search engine. What is its wing area?
7. What is the DC-8's cruising velocity?
8. If the air density is 1.26 g/L and the lift coefficient is 1.5, what is the lift of the DC-8?
9. Find the F/A-18A Hornet on [Wikipedia](http://en.wikipedia.org/wiki/F-18) (<http://en.wikipedia.org/wiki/F-18>), or use a search engine. What is its wing area?



10. What is the F/A-18A's lift while it flies at 700 mi/hr, the air density is 1.31 g/L, and the lift coefficient is 1.8?

ACTIVITY
Developing a Model
for Lift



Objectives

Compare and contrast common incorrect theories of lift.

Materials

Incorrect Theory
Readings

NGSS

CDI HS-PS2
SEP 2, 6, 7
CCC 4

CCSS

Reading in Science
Writing in Science

Model Building: Developing a Model for Lift

[Beginner's Guide to Aerodynamics: Lift Theories](#)

When two solid objects interact in a mechanical process, **forces** are transmitted, or applied, at the point of contact. But when a solid object interacts with a fluid, things are more difficult to describe because the fluid can change its shape. For a solid body immersed in a fluid, the point of contact is every point on the surface of the body. The fluid can flow around the body and maintain physical contact at all points. The transmission, or application, of mechanical forces between a solid body and a fluid occurs at every point on the surface of the body. And the transmission occurs through the fluid **pressure**.

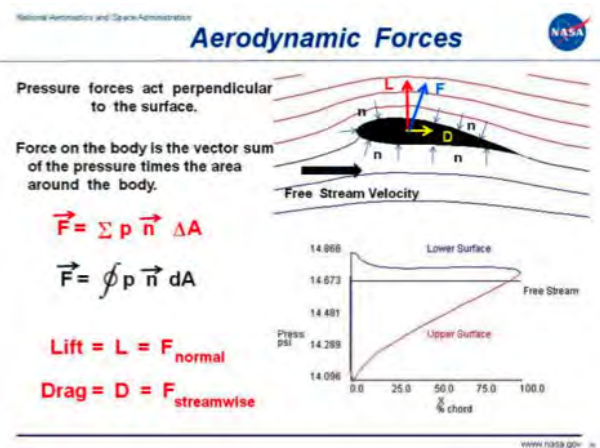

Variation in Pressure

The magnitude of the force acting over a small section of an object immersed in a fluid equals the pressure **P** times the area **A** of the section. A quick units check shows that:

$$P * A = (\text{force/area}) * \text{area} = \text{force}$$

As discussed on the fluid pressure slide, **pressure** is a scalar quantity related to the momentum of the molecules of a fluid. Since a force is a **vector quantity**, having both magnitude and direction, we must determine the direction of the pressure force. Pressure acts **perpendicular (or normal)** to the solid surface of an object. So the direction of the force on the small section of the object is along the normal to the surface. We denote this direction by the letter **n**.

The normal direction changes from the front of the airfoil to the rear and from the top to the bottom. We indicate this variation on the figure by several small arrows pointing perpendicular to the surface and labeled with an **n**. To obtain the net mechanical force over the entire solid object, we must sum the contributions from all the small sections. Mathematically, the summation is indicated by the Greek letter **sigma** (Σ) The net aerodynamic force **F** is equal to the sum of the product of the pressure **P** times the incremental area **delta A** in the normal direction **n**.

$$F = \sum P * n * \Delta A$$

In the limit of infinitely small sections, this gives the integral of the pressure times the area around the closed surface. Using the symbol $\int dA$ for integration, we have:

$$F = \int (P * n) dA$$

where the integral is taken all around the body. On the figure, that is why the integral sign has a circle through it.

If the pressure on a closed surface is a **constant**, there is no net force produced because the summation of the directions of the normal adds up to zero. For every small section there is another small section whose normal points in exactly the opposite direction.

$$F = \int (P * n) dA = P * \int n dA = 0$$

For a fluid in motion, the velocity has different values at different locations around the body. The local pressure is [related](#) to the local velocity, so the pressure also varies around the closed surface and a net force is produced. On the figure at the lower right, we show the variation of the pressure around the airfoil as obtained by a solution of the [Euler equations](#). The blue line shows the variation from front to back on the lower surface, while the red line shows the variation from front to back on the upper surface, The black line gives the reference free stream pressure. **Summing** the pressure perpendicular to the surface times the area around the body produces a **net force**.

$$F = \int (P * n) dA$$

Definitions of Lift and Drag

Since the fluid is in motion, we can define a flow direction along the motion. The [component](#) of the net force perpendicular (or normal) to the flow direction is called the [lift](#); the component of the net force along the flow direction is called the [drag](#). These are definitions. In reality, there is a single, net, integrated force caused by the pressure variations along a body. This **aerodynamic force** acts through the average location of the pressure variation which is called the [center of pressure](#).

Velocity Distribution

For an ideal fluid with no [boundary layers](#), the surface of an object is a [streamline](#). If the velocity is low, and no energy is added to the flow, we can use [Bernoulli's equation](#) along a [streamline](#) to determine the pressure distribution for a known velocity distribution. If boundary layers are present, things are a little more confusing, since the external flow responds to the edge of the boundary layer and the pressure on the surface is imposed from the edge of the boundary layer. If the boundary layer separates from the surface, it gets even more confusing. How do we determine the velocity distribution around a body? **Specifying** the velocity is the [source of error](#) in two of the more popular [incorrect theories](#) of lift. To correctly determine the velocity distribution, we have to solve [equations](#) expressing a conservation of [mass](#), [momentum](#), and [energy](#) for the fluid passing the object. In some cases, we can solve [simplified versions](#) of the equations to determine the velocity and pressure.

Summary

To summarize, for any object immersed in a fluid, the mechanical forces are transmitted at every point on the surface of the body. The forces are transmitted through the pressure, which acts perpendicular to the surface. The net force can be found by integrating (or summing) the pressure times the area around the entire surface. For a moving flow, the pressure will vary from point to point because the velocity varies from point to point. For some simple flow problems, we can determine the pressure distribution (and the net force) if we know the velocity distribution by using Bernoulli's equation.

Teacher Worksheet: Theories of Lift

Read the three explanations on lift and the popular incorrect theories on how lift is produced. Then using the information about each of the theories, complete the questions below designed to demonstrate your understanding of the theories.

1. Compare and contrast the incorrect lift theories #1 and #3.

Answers will vary.

2. Contrast the incorrect lift theories #2 and #3.

Answers will vary.

3. Which theory(ies) cannot explain why airplanes can fly upside down?

Answers will vary.

4. Which theory(ies) cannot explain why the upper surface of a wing has an effect on lift?

Answers will vary.

5. Which theory(ies) cannot explain why the air flowing past the lower surface of a wing has an effect on lift?

Answers will vary.

6. Explain the correct theory of lift in your own words.

Answers will vary.

Student Worksheet: Theories of Lift

Read the three explanations on lift and the popular incorrect theories on how lift is produced. Then using the information about each of the theories, complete the questions below designed to demonstrate your understanding of the theories.

1. Compare and contrast the incorrect lift theories #1 and #3.
2. Contrast the incorrect lift theories #2 and #3.
3. Which theory(ies) cannot explain why airplanes can fly upside down?
4. Which theory(ies) cannot explain why the upper surface of a wing has an effect on lift?
5. Which theory(ies) cannot explain why the air flowing past the lower surface of a wing has an effect on lift?
6. Explain the correct theory of lift in your own words



Incorrect Theory #1

Glenn
Research
Center

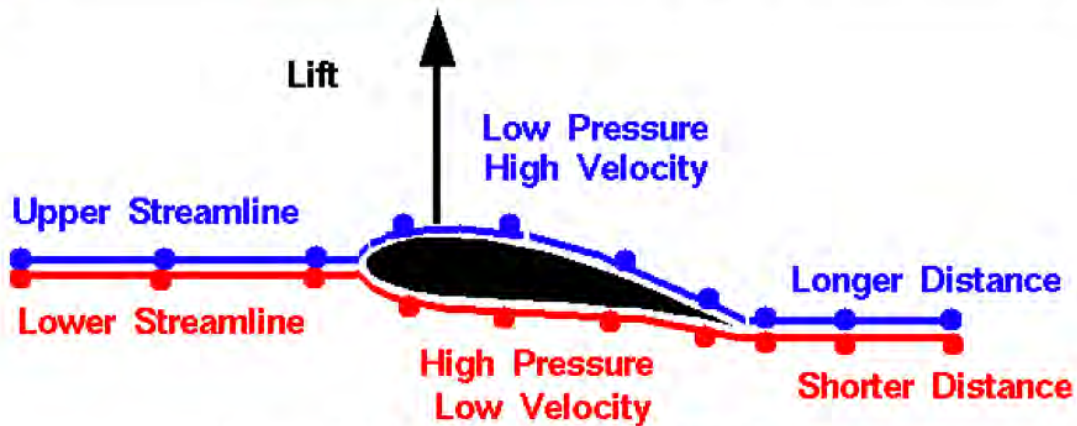

"Longer Path" or "Equal Transit" Theory

Top of airfoil is shaped to provide longer path than bottom.

Air molecules have farther to go over the top.

Air molecules must move faster over the top to meet molecules at the trailing edge that have gone underneath.

From Bernoulli's equation, higher velocity produces lower pressure on the top.

Difference in pressure produces lift.

The theory described here is one of the most widely circulated, incorrect explanations. The theory can be labeled the "longer path" theory, or the "equal transit time" theory. The theory states that airfoils are shaped with the upper surface longer than the bottom. The air molecules (the little colored balls on the figure) have farther to travel over the top of the airfoil than along the bottom. In order to meet up at the trailing edge, the molecules going over the top of the wing must travel faster than the molecules moving under the wing. Because the upper flow is faster, then, from [Bernoulli's equation](#), the pressure is lower. The [difference in pressure](#) across the airfoil produces the lift.

Let's use the information we've just learned to evaluate the various parts of the "equal transit time" theory.

- *Lifting airfoils are designed to have the upper surface longer than the bottom.*
 - This is not always correct. The symmetric airfoil in our experiment generates plenty of lift and its upper surface is the same length as the lower surface. Think of a paper airplane. Its airfoil is a flat plate --> top and bottom exactly the same length and shape and yet they fly just fine. This part of the theory probably got started because early airfoils **were** curved and shaped with a longer distance along the top. Such airfoils do produce a lot of lift and flow [turning](#), but it is the turning that's important, not the distance. There are modern, low-drag airfoils which produce lift on which the bottom surface is actually longer than the top. This theory also does not explain how airplanes can fly upside down which happens often at air shows and in air-to-air combat. The longer surface is then on the bottom!
- *Air molecules travel faster over the top to meet molecules moving underneath at the trailing edge.*
 - Experiments show that the flow over the top of a lifting airfoil **does** travel faster than the flow beneath the airfoil. But the flow is much faster than the speed required to have the molecules meet up at the trailing edge. Two molecules near each other at the leading edge will not end up next to each other at the trailing edge. This

part of the theory attempts to provide us with a value for the velocity over the top of the airfoil based on the non-physical assumption that the molecules meet at the aft end. We can calculate a velocity based on this assumption, and use Bernoulli's equation to compute the pressure, and perform the pressure-area calculation and the answer we get does not agree with the lift that we measure for a given airfoil. The lift predicted by the "equal transit time" theory is much less than the observed lift, because the velocity is too low. The actual velocity over the top of an airfoil is much faster than that predicted by the "longer path" theory and particles moving over the top arrive at the trailing edge before particles moving under the airfoil.

- *The upper flow is faster and from Bernoulli's equation the pressure is lower. The difference in pressure across the airfoil produces the lift.*
 - As we have seen in Experiment #1, this part of the theory is **correct**. In fact, this theory is very appealing because many parts of it are correct. In our discussions on [pressure-area](#) integration to determine the force on a body immersed in a fluid, we mentioned that if we know the velocity, we can obtain the pressure and determine the force. The problem with the "equal transit" theory is that it attempts to provide us with the velocity based on a non-physical assumption as discussed above.



Incorrect Theory #2

Glenn
Research
Center

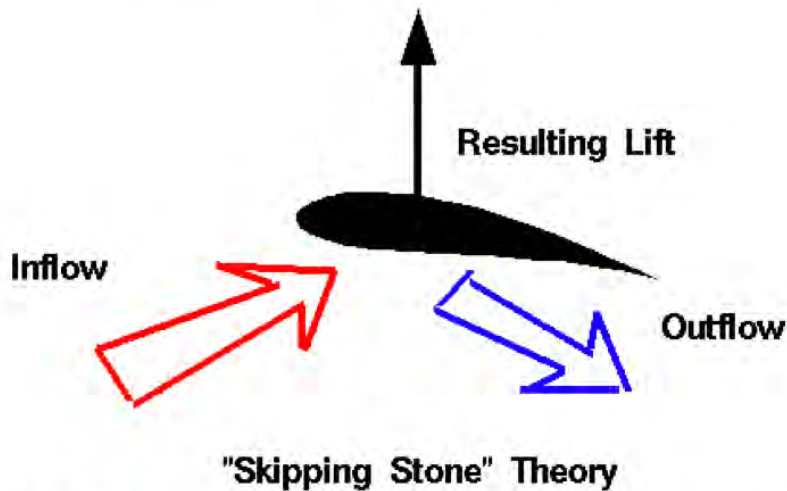

**Lift is the result of simple action <--> reaction
as air molecules strike bottom of the airfoil
imparting momentum to the foil.**

The theory described here is often seen on websites and in popular literature. The theory is based on the idea that lift is the [reaction force](#) to air molecules striking the bottom of the airfoil as it moves through the air. Because this is similar to the way in which a flat rock thrown at a shallow angle skips across a body of water, it is called the “skipping stone” theory of lift. *It is sometimes called a Newtonian theory of lift, since it involves Newton’s third law, but to avoid confusion with the correct Newtonian [theory](#) of flow turning, we shall call it the “skipping stone” theory.*

Let’s use the information we’ve just learned to evaluate the “Skipping Stone” Theory.

- This theory is concerned with only the interaction of the lower surface of the moving object and the air. It assumes that all of the flow turning (and therefore all the lift) is produced by the lower surface. But as we have seen in our experiment, the upper surface also turns the flow. In fact, when one considers the [downwash](#) produced by a lifting airfoil, the upper surface contributes more flow turning than the lower surface. This theory does not predict or explain this effect.
- Because this theory neglects the action <--> reaction of molecules striking the upper surface, it does not predict the negative lift present in our experiment when the angle of attack is negative. On the top of the airfoil, no vacuum exists. Molecules are still in constant random motion on the upper surface (as well as the lower surface), and these molecules strike the surface and impart momentum to the airfoil as well.
- The upper airfoil surface doesn’t enter into the theory at all. So using this theory, we would expect two airfoils with the same lower surface but very different upper surfaces to give the same lift. We know this doesn’t occur in reality. In fact, there are devices on many airliners called [spoilers](#) which are small plates on the upper surface between the leading and trailing edges. They are used to change the lift of the wing to maneuver the aircraft by disrupting the flow over the upper surface. This theory does not predict or explain this effect.
- If we make lift predictions based on this theory, using a knowledge of air density and the number of molecules in a given volume of air, the predictions are totally inaccurate when compared to actual measurements. The chief problem with the theory is that it neglects the physical properties of the fluid. Lift is created by [turning](#) a moving fluid, and all parts of the solid object can deflect the fluid.



Incorrect Theory #3

Glenn
Research
Center

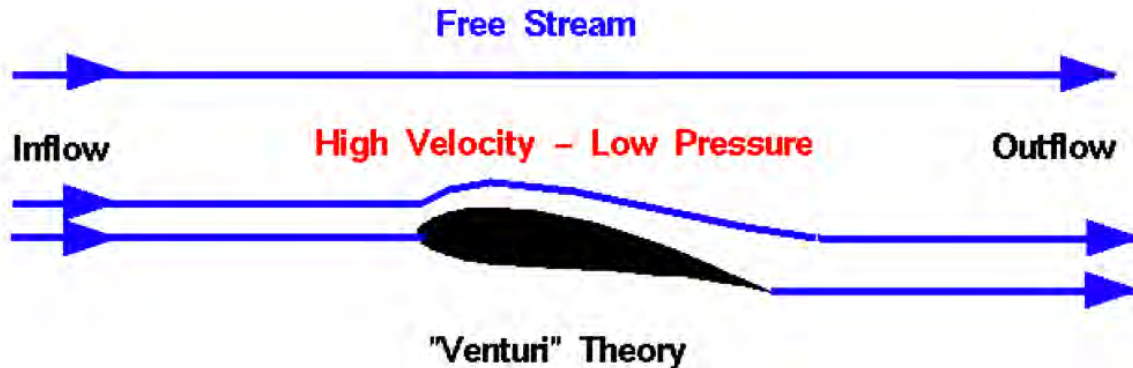

Upper surface of airfoil behaves like a Venturi nozzle constricting the flow.

Through the constriction, flow speeds up (velocity times area equals a constant).

From Bernoulli's equation, high velocity gives low pressure.

The theory described here is often seen on websites and in popular literature. The theory is based on the idea that the airfoil upper surface is shaped to act as a nozzle which accelerates the flow. Such a nozzle configuration is called a **Venturi nozzle** and it can be analyzed classically. Considering the [conservation of mass](#), the mass flowing past any point in the nozzle is a constant; the mass flow rate of a Venturi nozzle is a constant. The [mass flow rate](#) \dot{m} is equal to the [density](#) ρ times the velocity v times the flow area A :

$$\dot{m} = \rho * v * A = \text{constant}$$

For a constant density, decreasing the area increases the velocity.

Turning to the incorrect airfoil theory, the top of the airfoil is curved, which constricts the flow. Since the area is decreased, the velocity over the top of the foil is increased. Then from [Bernoulli's equation](#), higher velocity produces a lower pressure on the upper surface. The low pressure over the upper surface of the airfoil produces the lift.

Let's use the information we've just learned to evaluate the various parts of the "Venturi" theory.

- The theory is based on an analysis of a Venturi nozzle. But an airfoil is **not** a Venturi nozzle. There is no phantom surface to produce the other half of the nozzle. In our experiments we've noted that the velocity gradually decreases as you move away from the airfoil eventually approaching the free stream velocity. This is not the velocity found along the centerline of a nozzle which is typically higher than the velocity along the wall.
- The Venturi analysis cannot predict the lift generated by a flat plate. The leading edge of a flat plate presents no constriction to the flow so there is really no "nozzle" formed. One could argue that a "nozzle" occurs when the angle of the flat plate is negative. But as we have seen in Experiment #2, this produces a negative lift. The velocity actually slows down on the upper surface at a negative angle of attack; it does not speed up as expected from the nozzle model.
- This theory deals with only the pressure and velocity along the upper surface of the airfoil. It neglects the shape of the lower surface. If this theory were correct, we could have any shape we want for the lower surface, and the lift would be the same. This obviously is not the way it works - the lower surface does contribute to the lift generated by an airfoil. (In fact, one of the other [incorrect theories](#) proposed that only the lower surface produces lift!)

- The part of the theory about Bernoulli's equation and a difference in pressure existing across the airfoil is **correct**. In fact, this theory is very appealing because there are parts that are correct. In our discussions on [pressure-area](#) integration to determine the force on a body immersed in a fluid, we mentioned that if we knew the velocity, we could obtain the pressure and determine the force. The problem with the "Venturi" theory is that it attempts to provide us with the velocity based on an incorrect assumption (the constriction of the flow produces the velocity field). We can calculate a velocity based on this assumption, use Bernoulli's equation to compute the pressure, perform the pressure-area calculation, and yet the answer we get does not agree with the lift that we measure for a given airfoil.

Student Worksheet: Theories of Lift

Beginner's Guide to Aerodynamics is a web-based textbook of information prepared at NASA Glenn Research Center to help you better understand aerodynamics. Click [Beginner's Guide Index](#) to access the list of slides. Open the slides called [Aerodynamic Forces](#), [Incorrect Theory #1](#), [Incorrect Theory #2](#), and [Incorrect Theory #3](#) (with text) and read the explanations on lift and the popular incorrect theories on how lift is produced. Then using the information found in these slides, complete the questions below designed to demonstrate your understanding of the theories.

1. Compare and contrast the incorrect lift theories #1 and #3.
2. Contrast the incorrect lift theories #2 and #3.
3. Which theory(ies) cannot explain why airplanes can fly upside down?
4. Which theory(ies) cannot explain why the upper surface of a wing has an effect on lift?
5. Which theory(ies) cannot explain why the air flowing past the lower surface of a wing has an effect on lift?
6. Explain the correct theory of lift in your own words.

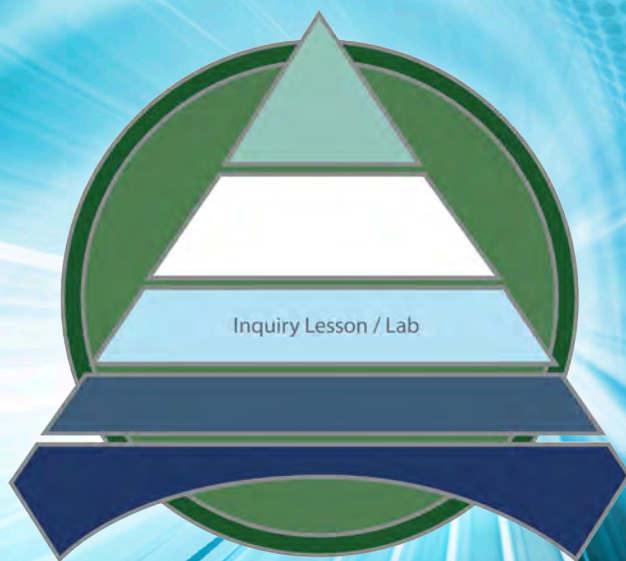

Inquiry Lesson/Lab: Rubber-Band-Driven Airplane Contest

Douglas Oliver & Terry Ng. *The Physics Teacher*. 37, 108 (1999).

In this activity, students are provided with a balsa and rubber band airplane, and are asked to make their airplane travel as far as possible while supporting a load. This goal can be achieved by considering how to maximize the amount of lift (while also decreasing the amount of drag). Students should consider the lift equation, which should have been partially derived from the wind tunnel experiment:

$$F_L = \frac{1}{2} \rho C_L A v^2$$

Although the density of the surrounding fluid (air) cannot be modified, students can make changes to the coefficient of lift, the surface area, and the velocity of the airplane through the fluid. Each of these will be examined separately.

Although the following student worksheets do not explicitly address each of the stages of the learning cycle for its repetitive nature in this kind of in-depth study with multiple parts, ensure that students address each step.

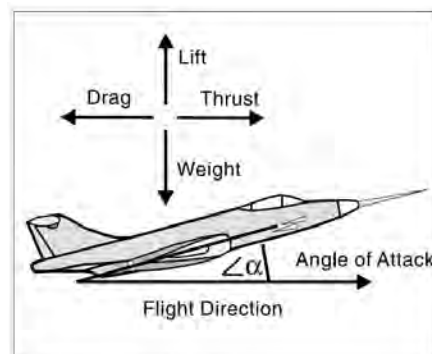
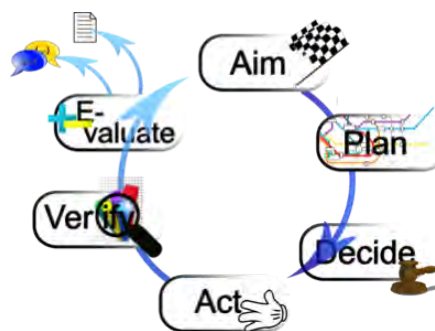

Fig. 1. Angle of attack, $\angle \alpha$.



Objectives

Design the furthest-traveling airplane.

Materials

Rubber band airplanes
Pennies / small masses
Meter stick

NGSS

CDI HS-PS2
SEP 1-7
CCC 1, 2, 4, 6, 7

The Rubber-Band Airplane Contest

Students work in groups of two or three to design, test, and fly a rubber-band-driven airplane that carries a “cargo” of pennies. Each team has three tries, with the scores for each try summed. Points are based on the number of penny-meters the plane carries aloft for each flight. For example, if a plane carries two pennies for 3.5 meters, the scores would be seven points (2 pennies x 3.5 meters = 7 penny-meters).

- Distances are measured as the linear distance from the point of take-off to the point at which the plane lands.
- All of the energy imparted to the plane must come from a single rubber band, through a single propeller, in the spirit of a propeller-driven plane. No slingshot type of devices are allowed. Students are not to push or throw the planes.
- All planes are launched from ground level.

Goal: Design the furthest-travelling airplane.

In order to design the furthest-travelling airplane, all part of the lift equation must be accounted for and maximized, as follows:

Coefficient of lift

Although there are a number of variables that influence the actual value of the coefficient of lift, one of them – the angle of attack – can be modified by the placement of a penny at a point along the long axis of the plane from tip to tail. The relationship between angle of attack and coefficient of lift is not linear, however, as demonstrated in the graph to the right. Ideally, students will want to increase the angle of attack just enough, but before it reaches the stall angle, at which the coefficient of lift drops precipitously.

Students can identify the stall angle by watching for a “roller coaster” effect of the airplane as it flies. Once this effect has been achieved, students will want to slightly move the penny forward so that the airplane moves at an angle of attack just below the stall angle.

Students might also attempt to change the wing camber or aspect ratio by replacing the wooden wings provided in the kit with other materials.

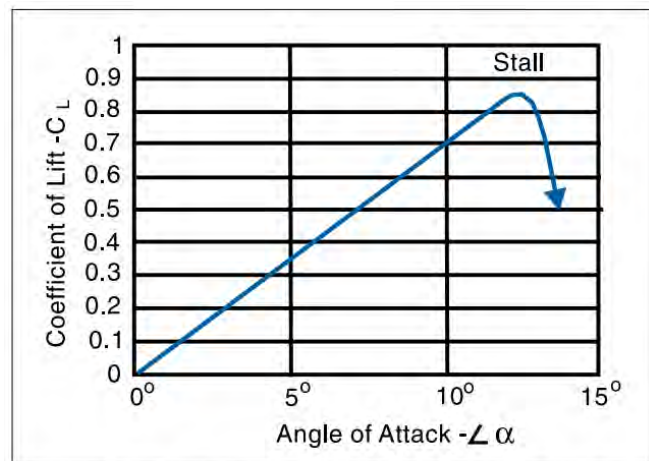

Fig. 2. Coefficient of lift as a function of angle of attack.

Surface Area

The surface area of the wings can also be modified, however, increasing surface area can also increase drag and have a net negative effect. Further, an increase in the size of the wings could also result in an increase in the mass of the total airplane. Students might consider cutting away bits of the balsa wings and replace them with paper, or replace them entirely with lighter new materials such as thin plastic.

Velocity

The speed of the wings relative to the air can be modified by maximizing the acceleration – either by changing propeller torque by winding the rubber band as far as possible or by decreasing the mass of the airplane. Students might also want to modify the airplane propeller to maximize thrust.

Rolling

Another aspect that must be considered, specifically for rubber band airplanes, is the rolling that results from the counteracting torque. Because most rubber band airplanes have a single propeller that moves in one direction, the airplane body itself will tend to roll in the direction opposite to the propeller's spin. This can be resolved by appropriately locating the placement for a counterweight (such as a penny) to equalize the force of the roll opposite the direction of the propeller.

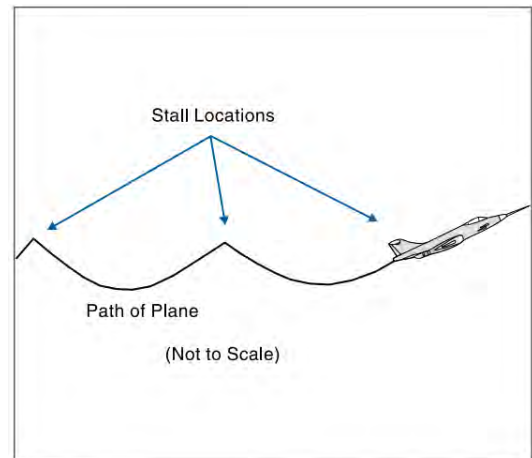

Fig. 3. "Roller-coaster" path is a sign of stall.

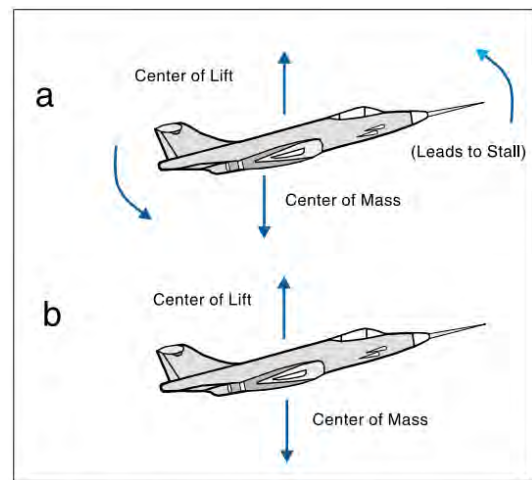

Fig. 4. Adjusting center of mass changes angle

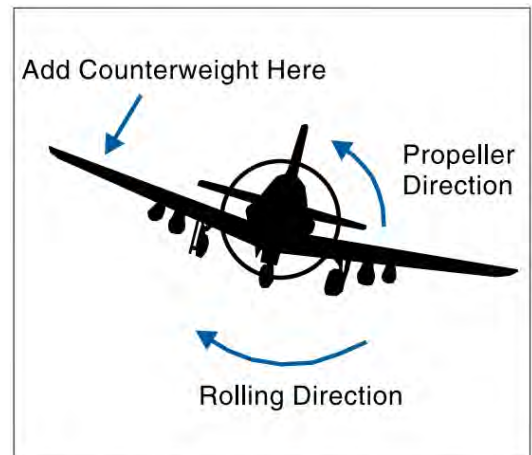

Fig. 5. Properly placed counterweight can reduce rolling.

Student Worksheet: Rubber-Band-Driven Airplane Contest

Goal: Design the furthest-travelling airplane.

In this activity, you will design a rubber-band airplane that can travel as far as possible while carrying a load.

You will be first provided with a balsa wood airplane kit. Assemble it according to the instructions, and try to fly it (release it from ground level).

1. Record your observations. Especially include any observations if you notice that the airplane doesn't fly straight.

2. Unless you inserted a counterweight on one of the wings, you might have noticed that the airplane tended toward one direction. This is a result of "torque." To understand torque, suspend an airplane from the tail, nose down, from a piece of string. Then, wind the propeller, and release, allowing the propeller to unwind. What happens to the body of the plane?

3. Before re-designing your airplane, develop a baseline distance of the plane without modification, to see if your changes improve or worsen the airplane's performance. Modification to your plane can include changes in shape, material, or size, so long as your plane is powered by a single rubber band and has only one propeller. Record your baseline values here:

Then, consider the lift equation partially derived from the wind tunnel lab. By increasing lift, your plane is more likely to travel further.

$$F_L = \frac{1}{2} \rho C_L A v^2$$

4. Look at all parts of the lift equation. Which terms are constants over which you have no control? Explain why you have no control over these constants.

5. Which terms are variables that you can modify? Explain how you plan to do this.

The Rubber-Band Airplane Contest

Students work in groups of two or three to design, test, and fly a rubber-band-driven airplane that carries a "cargo" of pennies. Each team has three tries, with the scores for each try summed. Points are based on the number of penny-meters the plane carries aloft for each flight. For example, if a plane carries two pennies for 3.5 meters, the scores would be seven points (2 pennies x 3.5 meters = 7 penny-meters).

- Distances are measured as the linear distance from the point of take-off to the point at which the plane lands.
- All of the energy imparted to the plane must come from a single rubber band, through a single propeller, in the spirit of a propeller-driven plane. No slingshot type of devices are allowed. Students are not to push or throw the planes.
- All planes are launched from ground level.

Use the following tips to assist you in your re-design of the rubber band plane:

Tip #1: Angle of Attack

Recall the graph of lift vs. angle of attack from your wind tunnel activity. Note that the peak value is the stall angle. For this example from the graph, what angle would be ideal for the airplane?

You can also change your own plane's angle of attack by inserting a penny along the length of the fuselage. Once in flight, the airplane will adjust its angle so that the center of lift and center of gravity are directly over one another.

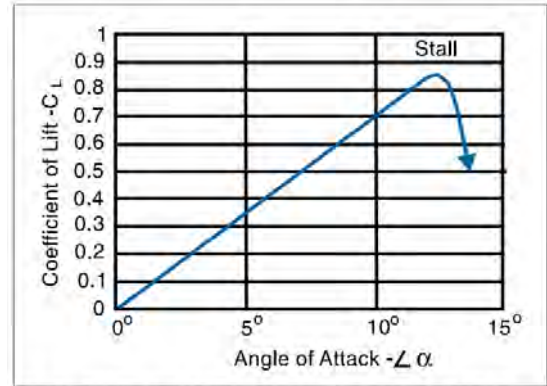

Fig. 2. Coefficient of lift as a function of angle of attack.

In order to identify the stall angle on your plane, continue to adjust the location of the penny until you notice that the path of the plane becomes “bumpy.” These bumps are locations at which the plane is stalling.

Tip #2: Get Creative

Feel free to make modifications to your airplane. Remove parts of the aircraft and replace it with your own materials. Whatever you choose to do, be certain to provide a rationale based upon the lift equation or other reasonable principles.

Tip #3: Test and Revise

You will not know the effect of your modifications (good or bad) until you test them multiple times. Keep a recording of your tests. Work to increase both the total distance travelled as well as the mass supported.



Recalling a Record: X-43A Scramjet Sets New Hypersonic Record a Decade Ago

http://www.nasa.gov/centers/armstrong/Features/X-43A_recalling_a_record.html#.VHT0oo29-Rg

Analysis Questions:

- What is “Mach”?
- The flight of the X-43A was described in the article as “the first demonstration of an integrated scramjet in atmospheric flight.” What is a scramjet? How does it work?
- What are the challenges of achieving hypersonic flight in the Earth’s atmosphere?
- What are the challenges of achieving hypersonic speeds outside of the Earth’s atmosphere?



Real-World Applications: Helicopter Toy and Lift Estimation

Said Shakerin. *The Physics Teacher*, 51 310 (2013).

Objectives

Estimate the maximum lift generated by a Wacky Whirler.

Materials

Wacky Whirler
Meter stick / ruler
Video recorder
Video analysis tool

NGSS

CDI HS-PS2
SEP 1-7
CCC 3, 6

Rotocraft use similar principles as static wings on airplanes in order to generate lift. The popular toy, Wacky Whirler, can be used to estimate lift. This is a good activity to help students come up with reasonable estimates by making some basic assumptions. This activity could be extended to see how small groups compare in their estimates.

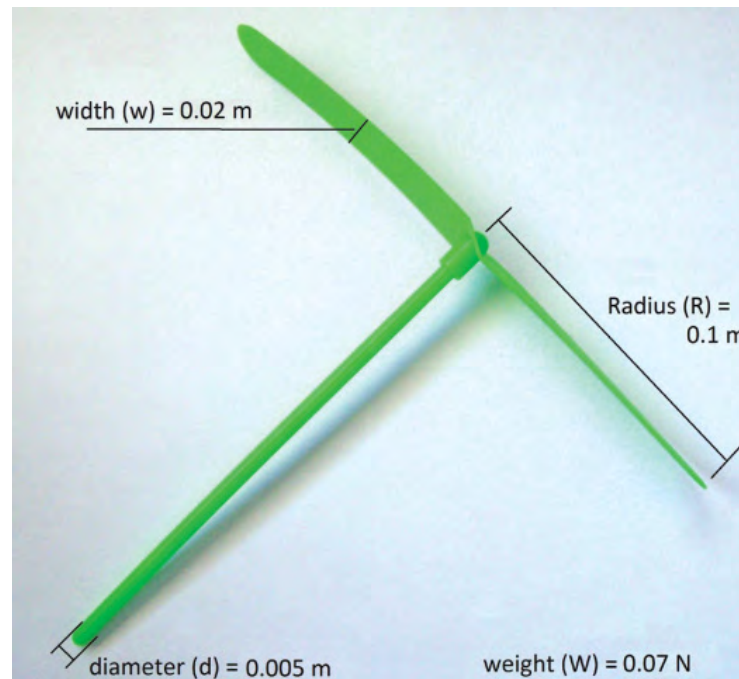

Teacher Guide and Key: Helicopter Toy and Lift Estimation

Goal: Estimate the maximum lift generated by a Wacky Whirler.

Students should be provided with a Wacky Whirler, meter stick or ruler, and the ability to record a video of the Wacky Whirler in motion, along with video analysis software. (Caution: Always advise students to use eye protection when releasing toy helicopters, as they can spin with high frequency and behave erratically).

Because the Wacky Whirler will have its greatest spin frequency immediately after being released from the hands, that is the point at which the toy will also have its greatest lift. (Note: Some students might intuitively come up with the correct idea that the highest frequency is reached some time after releasing the propeller, due to the propellers moment of inertia. After praising this precise observation they may feel positively challenged by devising more accurate ways of measuring.) Using the lift equation for an airplane, it is safe to assume that lift can be calculated with

$$F_L = \frac{1}{2} C_L \rho A v^2.$$

Starting with the last variable, the velocity, v , can be estimated by using a video camera in one of many ways. Perhaps the simplest approach is to record the spin frequency at take-off using video analysis software. From this, determine the period of one rotation of the wings. Measure the diameter of the full set of helicopter wings, and determine the distance traveled by the edge of the wings in the given period for one rotation. Although velocity for the edge of the wings can be calculated by taking the circumference they travel and dividing it by the period of rotation, this is a tangential velocity that is most accurate only for the edge of the propellers. A more accurate average velocity would be the edge velocity divided by two. (Note: Actually, the average velocity is about 79.37 % of the wing tip's track velocity, since the square of the velocity contributes to the lift.) An alternate approach to resolving this problem can be found in the reference article in *The Physics Teacher*.

The second to last variable, the surface area, A , can be easily estimated using a meter stick and treating the wings as approximate rectangles.

The density of air, ρ , is typically around 1 kg/m^3 , but can be better estimated given the known room temperature and pressure.

The coefficient of lift, C_L , is perhaps the most difficult value to estimate for this activity, because it is typically a value that is determined experimentally when the magnitude of lift is measured and known. However, some simple research into typical C_L values should result in students seeing that values are typically around $C_L = 1$ for a 10 degree angle of attack (see the previous lab activity), and that flat plates differ very little from modern wings as this angle of attack. Therefore, it is not unreasonable to choose a value of 1.

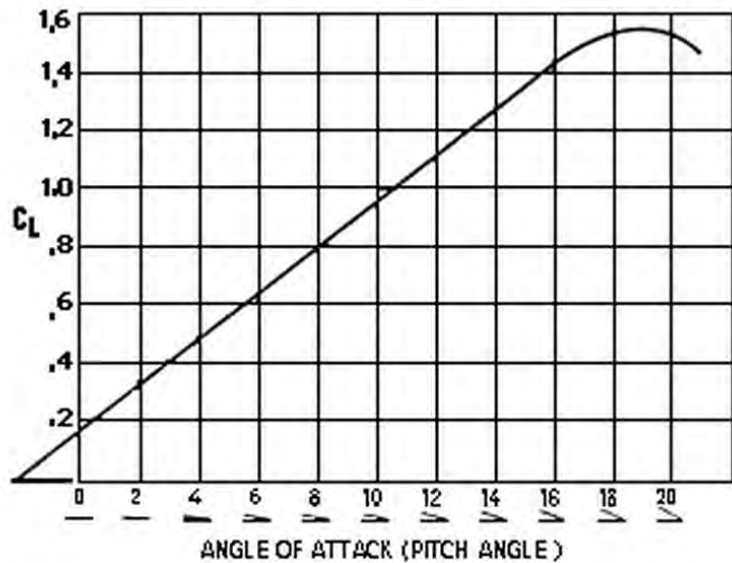

1 knot = 1 nautical mile per hour = 6,076 ft per hour
1 mph = 1 mile per hour = 5,280 feet per hour

After the estimation of lift, students should compare their estimates between groups and defend their estimation values. The values should also be considered in comparison to the weight. The maximum lift value must exceed the weight if any upward acceleration was observed.

Student Worksheet: Helicopter Toy and Lift Estimation

Aim



Objective: Estimate the maximum lift generated by a Wacky Whirler.

Just like some airplanes, helicopters use propellers. However, while airplanes tend to use propellers for propulsion, helicopters use them for lift. Because helicopter “wings” follow similar rules as airplane wings, we can use the lift equation:

$$F_L = \frac{1}{2} C_L \rho A v^2.$$

(Note: For *very* high frequencies, rotor lift actually will decrease, which is different than the behavior of airplane wings).

Play with a helicopter toy, and get it to fly. (Caution: Always use eye protection, especially when the helicopters are released near eye level). Watch the path of the toy after it is released from your hands.

1. At which point of its flight path is the maximum lift generated? How do you know?

Plan



In order to estimate the lift at this point in the path, you need to know the value of each variable in the equation. With your small group, discuss how you might be able to measure or calculate the value of each variable in the lift equation.

Decide



Speed

The only thing that really makes the helicopter toy’s wings different from an airplane is that their motion is in a circle – not in a straight line. Decide how you can measure the speed of the propellers.

2. How can you determine the speed of something moving in a circle?
3. One of the challenges of dealing with propellers is that each part of the propeller has a different linear speed. Where is the speed the fastest? Slowest? Average? Annotate the image, and explain.



4. Using a ruler, determine the radius of the propeller at the point of *average* speed, and label the image above.



- Using a video recorder and a video analysis tool, determine the period of one rotation of the propeller. *Hint: Paint one end of the propellers with a bright color, so that you can observe a single side as it rotates completely.* Consider recording from the below the release, above it, to the side, or even changing lighting and background contrast in order to clearly measure a single rotation.
- Using the distance and time measurements, determine the average speed of the propellers as they move through the air.

Surface Area

- Using a meter stick, estimate the total surface area spanned by the wings. Record measurements and total surface area below on the image.



Surface Area

- The density of air, ρ , is typically around 1.2 kg/m^3 at STP, but can be better estimated given the known room temperature and pressure. Look online to determine the air density at your current location (consider altitude, temperature, and humidity). Record that value here.

Coefficient of Lift

The coefficient of lift, C_L , is perhaps the most difficult value to estimate for this activity, because it is typically a value that is determined experimentally when the magnitude of lift is measured and known. However, the graph to the right gives some typical values of the coefficients of lifts.

- From this graph, what would you consider to be the average coefficient?

Lift Calculation

10. Using the lift equation, calculate the total estimated maximum lift.

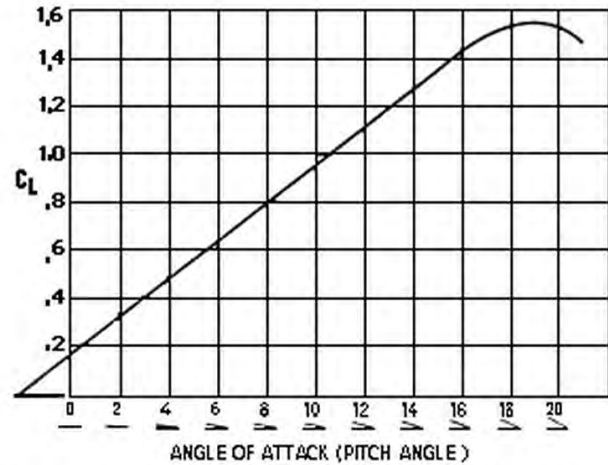

1 knot = 1 nautical mile per hour = 6,076 ft per hour
1 mph = 1 mile per hour = 5,280 feet per hour



11. How does this value for maximum lift compare to weight? Is this value reasonable? Why or why not?



12. How should this value for lift compare when the helicopter toy is accelerating up versus accelerating down? Explain.



Constant Net Force



A joint project of
NASA Aeronautics
and the
American Association of
Physics Teachers





Objectives

Calculate the forces acting on a parachute as it falls.

Materials

Parachuter object
Parachute material
String
Tape
Electronic Balance
Meter stick

NGSS

CDI HS-PS-1
SEP 1-7
CCC 4, 6

Real-World Applications: Parachute Lab

Although students familiar with wind tunnels might have a sense of how lift and drag can be measured, there are alternative ways to measure forces without the use of a force meter.

The following activity helps students to use the concepts of force diagrams and Newton's second law to infer the amount of drag force acting on an accelerating parachuter.

(Note: Although students are asked to design a parachute – intended to help the object achieve terminal velocity – in this activity, students should design an object that actually does accelerate constantly, albeit at a much lower value than acceleration due to gravity. If students are unable to design a parachute with such requirements, consider asking students to instead design an object to fall attached to a paper or Styrofoam ball.)

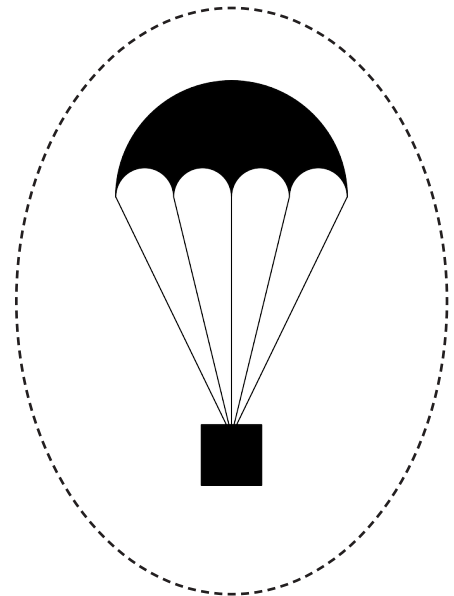

Teacher Guide and Key: Parachute Lab



Objective: Calculate the forces acting on the parachute as it falls.

For this activity, students must build a parachute system that allows an object to accelerate at a value less than 9.8 m/s/s (so that it can be easily timed), but so that it is not falling at terminal velocity. At terminal velocity, the frictional drag force simply is equal to the weight of the falling object, which overly simplifies this learning experience.

To ensure that the parachute does not reach terminal velocity, students might be encouraged to use more massive objects, such as golf balls, instead of plastic parachute men, that have a very low mass. Alternatively, use Styrofoam balls or crumpled paper to slow down a falling object without it reaching terminal velocity. It can be difficult to determine if an object has reached terminal velocity or not. Students can check for this by holding a digital motion sensor above the parachute after it has been released and has begun dropping, or by recording the drop with a video recorder for video analysis. (Alternatively, teachers can just ensure that students are getting average acceleration, even if terminal velocity is reached during a portion of the fall).

In order to measure the acceleration of their parachuters, they will need to know both the distance of the fall as well as the time. Teachers can help speed up the process by measuring the height of the fall in advance. To make it possible for students to time the fall, parachuters should be dropped the equivalent of approximately one story or the height of a three-meter stairwell with an opening in the middle. Balconies and windows are also good places from which to release the parachute. (Caution: Ensure that there are spotters on the ground to observe parachutes as they fall. Ensure that no one is standing under the falling parachutes. If using a balcony or window, ensure that students always keep the center of gravity of their bodies below the ledge).



1. Look back at the “Drag Stations Lab.” How might you design a parachute to decrease velocity of a parachuter as it falls, but ensure that it is still accelerating, and does not attain terminal velocity?

Mass should be moderate, so that a small parachute will not cause it to reach terminal velocity. Parachutes can slow down falling objects by increasing size and having a shape that “captures” the air as it falls.



2. Consider your available materials and decide on a design to try.



3. Build your parachute. When it falls, **ensure that it has a constant acceleration** towards the ground. How will you determine the acceleration of the parachute? (Hint: You may use a meter stick and a timer to help you. What equation will you use? What measurements will you take?)

Measure the distance fallen with the meter stick (or use a string and bob hanger to measure long distances). Measure the time it takes to fall with the timer. Acceleration can be calculated from

$$x_f = \frac{1}{2}at^2 + (v_i t + x_i).$$

4. Calculate the acceleration of your parachute.

5. Draw a force diagram for your parachute system as it accelerates downward. Make sure relative force vector lengths are correct. Label the *net force* on the system.

The drag force points upward, and gravitational force points downward (and is longer than the drag force). The net force is the excess force, part of the gravitational force.

6. Measure the mass of your parachute system:
_____ kg

7. What is the value of the net force acting to pull your parachute down?

Net force can be calculated using Newton's second law. ($F_{net} = ma$).

8. What is the weight of your parachute system?

This value comes from $F_g = (9.8 \text{ N/kg}) m$



9. What is the value of the frictional drag force acting on your parachute system? Does this value seem reasonable?

Because the magnitude of weight minus the magnitude of the net force equals drag force, these two numbers simply need to be subtracted from one another.



10. How does the value of the frictional drag force on your parachute compare to others' parachutes? Do you notice any relationship between frictional drag and heavier/lighter or bigger/smaller parachutes?



Student Worksheet: Parachute Lab



Aim

Objective: Calculate the forces acting on the parachute as it falls.



Plan

1. Look back at the “Drag Stations Lab.” How might you design a parachute to decrease velocity of a parachuter as it falls, but ensure that it is still accelerating, and does not attain terminal velocity?

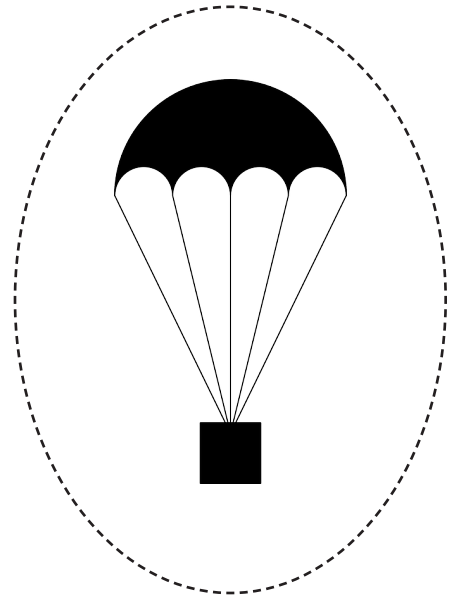

Decide

2. Consider your available materials and decide on a design to try.



Act

3. Build your parachute. When it falls, **assume that it has a constant acceleration** towards the ground. Look back at your “Constant Acceleration” concept map. How will you determine the acceleration of the parachute? (Hint: You may use a meter stick and a timer to help you. What equation will you use? What measurements will you take?)

4. Calculate the acceleration of your parachute.

5. Draw a force diagram for your parachute system as it accelerates downward. Make sure relative force vector lengths are correct. Label the *net force* on the system.

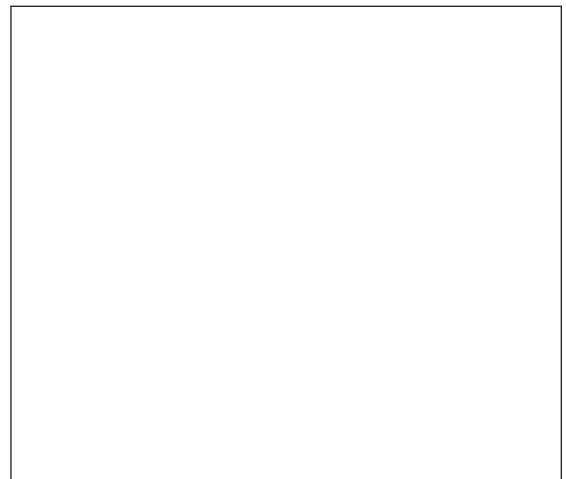

6. Measure the mass of your parachute system: _____ kg
7. What is the value of the net force acting to pull your parachute down?
8. What is the weight of your parachute system?



9. What is the value of the frictional drag force acting on your parachute system?



10. How does the value of the frictional drag force on your parachute compare to others' parachutes? Do you notice any relationship between frictional drag and heavier/lighter or bigger/smaller parachutes?

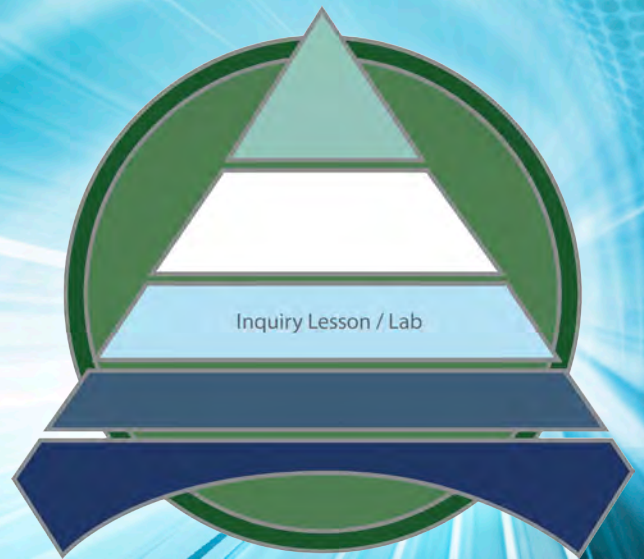

Objectives

Derive an expression for mass and terminal velocity for an object falling with air resistance.

Materials

Coffee filters
Electronic balance
Motion detector
Data analysis software

NGSS

CDI HS-PS2
SEP 1-7
CCC 1, 2, 4, 6

Inquiry Lesson/Lab: Falling and Air Resistance (Quantitative)

The following is a higher-level mathematical approach to determining air drag's dependency upon the velocity of an object through a medium (as opposed to the Inquiry Lab: Falling and Air Resistance (Quantitative).) Although simple investigations in mass or weight dependency on terminal velocity likely have helped students realize that drag is approximately proportional to the square of the velocity, the reality is that this is not a perfect model. Help students critically analyze this relationship using a general expression for drag dependence (simplified as mass) upon velocity.

(Note: To acquire more data points, consider placing half or portions of coffee filters inside of the bottom filter!)

Teacher Guide and Key: Falling and Air Resistance (Quantitative)



Aim

Objective: Derive an expression for mass and terminal velocity for an object falling with air resistance.

Before performing an experiment, it is important to have a good conceptual understanding of the variables that can influence drag. Work through the following prompts to prepare your for your laboratory investigation.

1. Envision an object falling through a friction-free atmosphere near the surface of the Earth. According to Newton's second law, $F_{\text{net}} = ma$, which in this case is $F_{\text{net}} = mg$, where $g = 9.8 \text{ N/kg}$. Draw a force diagram for this scenario.

The point mass should have a single, downward force vector (weight).

2. Now, envision that the object is falling and accelerating downward, but that there is some air drag present. Draw a force diagram for this scenario.

The point mass should have the downward force of weight, as well as a smaller upward force of air drag.

3. Write a mathematical expression to describe the net force acting on the object.

$$F_{\text{net}} = ma = mg - F_{\text{drag}}$$

4. Now, assume that the coffee filter has achieved terminal velocity. Draw a force diagram for this situation.

The point mass should have weight as well as an equal-length drag vector.

5. Re-write the expression above where $F_{\text{net}} = 0$.

$$0 = mg - F_{\text{drag}} \quad mg = F_{\text{drag}}$$

6. From prior experience, we know that F_{drag} has a dependence upon speed, but that relationship is not exact. While, in general, it is a parabolic relationship, this is not always the case for objects with irregular surfaces or at very high or very low speeds. As a result, we can describe that F_{drag} is proportional to v^n , or $F_{\text{drag}} = b v^n$, where b is a constant that factors all other variables that influence drag (i.e. shape, fluid viscosity, etc.). Substitute the new expression for F_{drag} into the equation above.

$$mg = b v_{\text{terminal}}^n$$

7. Because we want to find out the exponent of the velocity, solve for v .

$$v_{\text{terminal}} = \left(\frac{mg}{b}\right)^{\frac{1}{n}}$$

8. Re-arrange the equation so that it can be plotted linearly on a logarithmic graph (i.e. “ $\ln y = (m) x + b$ ”).

$$\ln v_{\text{terminal}} = \left(\frac{1}{n}\right) [\ln m + \ln g - \ln b]$$



9. Going back to the goal statement, remember that we are looking at the relationship between terminal velocity and mass. If we were to plot data on a logarithmic graph, what would be the significance of each piece of the graph, from the equation above?
- y-axis variable: *natural log of terminal velocity*
 - slope: $1/n$
 - x-axis variable: *natural log of mass*
 - y-intercept: $(1/n)(\textit{natural log of } g - \textit{natural log of } b)$



10. Using stacks of coffee filters, decide how to collect a wide range of multiple-trial data for terminal velocity and mass. (Feel free to simply use average velocity for terminal velocity – however, if you do this, provide a justification for why this is acceptable).



11. Plot the data on a log-log graph (terminal velocity on the vertical axis, and mass of filter sets on the horizontal axis).



12. What is the value of slope, from the log-log graph? How does this value compare to the typically estimated value of 2?

13. What is the value of the y-intercept, from the log-log graph? What is the value of “b” in this experiment?

14. Now plot the data by inverting the axes. What is the value of the slope? Explain! (Careful – this is not a simple “inverse.” Remember that you are using a log-log graph).

*The value of the slope should be equal to the **negative** inverse of the slope from the first graph.*

15. If you assumed that terminal velocity was approximately equal to the average velocity of the falling coffee filter, how did this influence your value for n and for b?

Average velocities are lower than terminal velocity (because time is spent speed up to terminal velocity), so the effect would be an increase in the value of n.

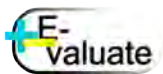

16. Write your final equation, based on your data, for the dependence of drag on velocity for your experiment. Compare this value to the rest of the lab groups in your class.

$$F_{\text{drag}} = bv^{-2}$$

Student Worksheet: Falling and Air Resistance (Quantitative)

In previous lessons, you have learned about fluid friction's dependence upon speed. In some cases (for small, aerodynamic objects), as the speed through the fluid is doubled, the frictional drag is doubled. In other cases (for larger, less aerodynamic objects), as the speed through the fluid is doubled, the frictional drag is quadrupled. In the "Falling and Air Resistance Lab (Qualitative)," you likely saw that coffee filters tend to behave more like large, less aerodynamic objects. However, sometimes objects don't display linear or parabolic (square) relationships. Sometimes they display relationships right through the middle, or something totally different. This is the same case with airplanes and flying objects. Every object's drag experience is different, and that dependency can change based upon speed, air composition and density, and airplane structure.

In the following experiment, you will not just look to see if drag is proportional to v or v^2 . Rather, you will determine how drag is proportional to v^n , and you will solve for n using a logarithmic graph.

Objective: Derive an expression for mass and terminal velocity for an object falling with air resistance.

Before performing an experiment, it is important to have a good conceptual understanding of the variables that can influence drag. Work through the following prompts to prepare your for your laboratory investigation.



1. Envision an object falling through a friction-free atmosphere near the surface of the Earth. According to Newton's second law, $F_{\text{net}} = ma$, which in this case is $F_{\text{net}} = mg$, where $g = 9.8 \text{ N/kg}$. Draw a force diagram for this scenario.
2. Now, envision that the object is falling and *accelerating* downward, but that there is some air drag present. Draw a force diagram for this scenario.
3. Write a mathematical expression to describe the net force acting on the object.
4. Now, assume that the coffee filter has achieved terminal velocity. Draw a force diagram for this situation.
5. Re-write the expression above where $F_{\text{net}} = 0$.

6. From prior experience, we know that F_{drag} has a dependence upon speed, but that relationship is not exact. While, in general, it is a parabolic relationship, this is not always the case for objects with irregular surfaces or at very high or very low speeds. As a result, we can describe that F_{drag} is proportional to v^n , or $F_{\text{drag}} = b v^n$, where b is a constant that factors all other variables that influence drag (i.e. shape, fluid viscosity, etc.). Substitute the new expression for F_{drag} into the equation above.

7. Because we want to find out the exponent of the velocity, solve for v .

8. Re-arrange the equation so that it can be plotted linearly on a logarithmic graph (i.e. “ $\ln y = (m) x + b$ ”).



9. Going back to the goal statement, remember that we are looking at the relationship between terminal velocity and mass. If we were to plot data on a logarithmic graph, what would be the significance of each piece of the graph, from the equation above?
 - a. y-axis variable:
 - b. slope:
 - c. x-axis variable:
 - d. y-intercept:



10. Using stacks of coffee filters, decide how to collect a wide range of multiple-trial data for terminal velocity and mass. (Feel free to simply use average velocity for terminal velocity – however, if you do this, provide a justification for why this is acceptable).



11. Plot the data on a log-log graph (terminal velocity on the vertical axis, and mass of filter sets on the horizontal axis).



12. What is the value of slope, from the log-log graph? How does this value compare to the typically estimated value of 2?

13. What is the value of the y-intercept, from the log-log graph? What is the value of “b” in this experiment?

14. Now plot the data by inverting the axes. What is the value of the slope? Explain! (Careful – this is not a simple “inverse.” Remember that you are using a log-log graph).

15. If you assumed that terminal velocity was approximately equal to the average velocity of the falling coffee filter, how did this influence your value for n and for b?



16. Write your final equation, based on your data, for the dependence of drag on velocity for your experiment. Compare this value to the rest of the lab groups in your class.



Hitchhiking Sensors Capture Curiosity's Entry

<http://www.nasa.gov/topics/aeronautics/features/medli.html#.VHjBzo29-Rg>

Analysis Questions:

- Scientists from NASA collected data on both temperature and pressure. What effect could extremes of both of these variables have on a flying aircraft?
- How might scientists expect Curiosity to behave differently (in terms of motion) and experience different effects if it were to fall through the Earth's atmosphere, as opposed to through Mars'?

Problem Set: Simplified Aircraft Motion

[Beginner's Guide to Aeronautics](#)

BACKGROUND

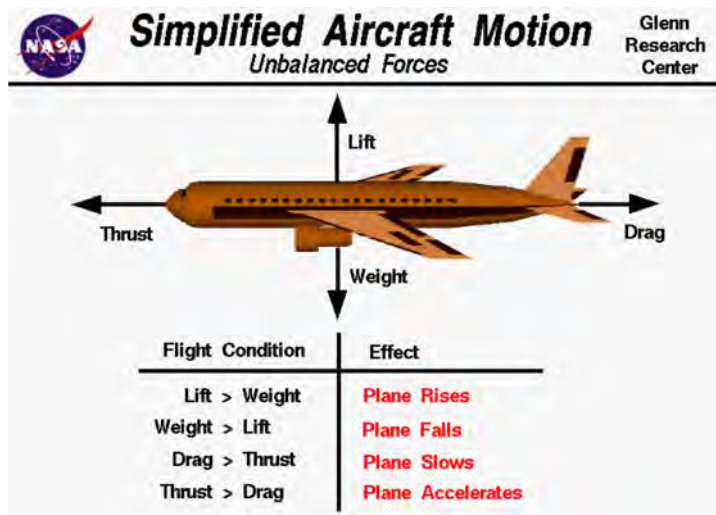

This image below shows some rules for the simplified motion of an aircraft. By simplified motion we mean that some of the **four forces** acting on the aircraft are **balanced** by other forces and that we are looking at only one force and one direction at a time. In reality, this simplified motion doesn't occur because all of the forces are interrelated to the aircraft's speed, altitude, orientation, etc. But looking at the forces ideally and individually does give us some insight and is much easier to understand.

In an ideal situation, an airplane could sustain a constant speed and level flight in which the weight would be balanced by the lift, and the drag would be balanced by the thrust. The closest example of this condition is a [cruising airliner](#). While the weight decreases due to fuel burned, the change is very small

relative to the total aircraft weight. In this situation, the aircraft will maintain a constant cruise velocity as described by [Newton's first law of motion](#).

If the forces become unbalanced, the aircraft will move in the direction of the greater force. We can compute the acceleration which the aircraft will experience from [Newton's second law of motion](#)

$$F_{\text{net}} = m * a$$

Where **a** is the acceleration, **m** is the mass of the aircraft, and **F_{net}** is the net force acting on the aircraft. The net force is the difference between the opposing forces; lift minus weight, or thrust minus drag. With this information, we can solve for the resulting [motion](#) of the aircraft.

If the weight is decreased while the [lift](#) is held constant, the airplane will rise:

$$\text{Lift} > \text{Weight} - \text{Aircraft accelerates upward}$$

If the lift is decreased while the [weight](#) is constant, the plane will fall:

$$\text{Weight} > \text{Lift} - \text{Aircraft accelerates downward}$$

Similarly, increasing the thrust while the [drag](#) is constant will cause the plane to accelerate:

$$\text{Thrust} > \text{Drag} - \text{Aircraft accelerates forward (speeds up)}$$

And increasing the drag at a constant [thrust](#) will cause the plane to slow down:

$$\text{Drag} > \text{Thrust} - \text{Aircraft accelerates backward (slows down)}$$

Problem Set from Beginner's Guide to Aeronautics

[Student Worksheet](#)

[Teacher Answer Key](#)

- What is the smallest angle in degrees between the lift and drag forces?
 - 0°
 - 90°
 - 180°
 - 270°
 - 360°
- What is the smallest angle in degrees between the weight and lift forces?
 - 0°
 - 90°
 - 180°
 - 270°
 - 360°
- What is the smallest angle in degrees between the thrust and drag forces?
 - 0°
 - 90°
 - 180°
 - 270°
 - 360°
- What is the smallest angle in degrees between the weight and thrust forces?
 - 0°
 - 90°
 - 180°
 - 270°
 - 360°
- When an airplane (or any object) is moving at a constant speed, the forces acting on the airplane must be
 - unbalanced, which means that the total force is not zero
 - balanced, which means that the total force is zero



A fighter jet is flying at 37,000 feet with a constant speed of 1,310 km/h. The jet has a weight of 110,000 N and its engines provide a thrust of 106,752 N (using afterburners).

- What is the jet's height (altitude) in meters?
 - 1.13×10^8 m
 - 61,248 m
 - 8,679 m
 - 356 m
 - 11,277.6 m
- What is the jet's mass? [**Hint:** Use $F = mag = W$, where $ag = 9.8$ m/s².]
 - 520,120 kg
 - 11,224.49 kg
 - 3,527 kg
 - 614,853 kg
 - 215 kg
- How much lift force is being applied to the jet?
 - 512,128 N
 - 5,634 N
 - 110,000 N
 - 9,935 N
 - 106,752 N

9. If the jet engines are creating a thrust of 106,752 N, what is the drag force applied to the jet?
- a. 512,128 N
 - b. 5,634 N
 - c. 110,000 N
 - d. 9,935 N
 - e. 106,752 N

Suppose the jet engines are providing a thrust of 100,102 N while the drag force is only 90,167 N.

10. What is the total unbalanced (or net) force on the jet?
- a. 512,128 N
 - b. 5,634 N
 - c. 110,000 N
 - d. 9,935 N
 - e. 106,752 N
11. What will be the jet's acceleration?
- a. 0.89 m/s²
 - b. 4.35 m/s²
 - c. 0.36 m/s²
 - d. 4,253 m/s²
 - e. 65.3 m/s²
12. If the jet is cruising at 223.47 m/s and accelerates at 0.25 m/s² for 1,530 seconds, what is the jet's final speed?
- a. 401.28 m/s
 - b. 605.97 m/s
 - c. 731.67 m/s
 - d. 634,521.6 m/s
 - e. 3,452 m/s
13. Using the data from the previous problem, calculate how far the jet traveled while it accelerated during the 1,530 seconds.
- a. 401.28 m
 - b. 605.97 m
 - c. 731.67 m
 - d. 634,521.6 m
 - e. 3,452 m
14. If the jet cruised at a speed of 1,310 km/h for 2.53 hours, how far did it travel?
- a. 517.79 km
 - b. 4,639.00 km
 - c. 218.42 km
 - d. 6,547.23 km
 - e. 3,314.30 km

Problem Set: Forces in a Climb

Beginner's Guide to Aeronautics

BACKGROUND

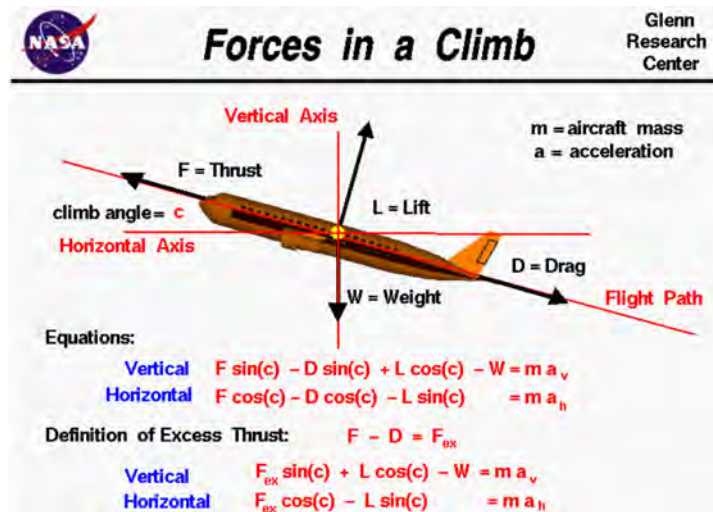

(Note: This background is most appropriate *after* students have been introduced to these concepts through constructivist and/or inquiry activities.)

There are [four forces](#) that act on an aircraft in flight: [lift](#), [weight](#), [thrust](#), and [drag](#). The [motion](#) of the aircraft through the air depends on the relative size of the various forces and the orientation of the aircraft. For an aircraft in [cruise](#), the four forces are balanced, and the aircraft moves at a constant velocity and altitude. On this slide, we consider the relations of the forces during a gradual climb. We have drawn a vertical and horizontal axis on our aircraft through the [center of gravity](#). The flight path is shown as a red line inclined to the horizontal at angle c . The lift and drag are [aerodynamic forces](#) that are defined relative to the flight path. The lift is perpendicular to the flight path and the drag is along the flight path. The thrust of the aircraft is

also usually aligned with the flight path. Some modern fighter aircraft can [change the angle of the thrust](#), but we are going to assume that the thrust is along the flight path direction. The weight of an airplane is always directed towards the center of the Earth and is, therefore, along the vertical axis.

Forces are [vector quantities](#). We can write two [component](#) equations for the motion of the aircraft based on Newton's [second law of motion](#) and the rules of [vector algebra](#). One equation gives the vertical acceleration a_v , and the other gives the horizontal acceleration a_h in terms of the components of the forces and the mass m of the aircraft. If we denote the thrust by the symbol F , the lift by L , the drag by D , and the weight by W , the vertical component equation is:

$$F * \sin(c) - D * \sin(c) + L * \cos(c) - W = m * a_v$$

where \sin and \cos are the trigonometric sine and cosine functions. Similarly, the horizontal component equation is:

$$F * \cos(c) - D * \cos(c) - L * \sin(c) = m * a_h$$

We can simplify the equations a little by using the definition of excess thrust F_{ex} :

$$F_{ex} = F - D$$

The resulting equations of motion are:

$$\text{Vertical: } F_{ex} * \sin(c) + L * \cos(c) - W = m * a_v$$

$$\text{Horizontal: } F_{ex} * \cos(c) - L * \sin(c) = m * a_h$$

For small climb angles, the $\cos(c)$ is nearly 1.0 and the $\sin(c)$ is nearly zero. The equations then reduce to:

$$\text{Vertical: } L - W = m * a_v$$

$$\text{Horizontal: } F - D = m * a_h$$

The resulting simplified motion is described on another [slide](#). The horizontal equation is [integrated](#) on another slide to give the velocity and location as functions of time.

For more moderate angles, high excess thrust can provide an important contribution to the vertical acceleration. The next time you visit an airport, notice the high climb angles used by modern airliners. This flight path is possible because modern [turbine engines](#) develop high excess thrust at takeoff. The pilot climbs sharply to get the aircraft as high as possible within the confines of the airport which produces the least noise for nearby homes.

Problem Set

[Student Worksheet](#)

[Teacher Answer Key](#)

A Boeing 737-600 takes off from a major airport at a speed of 160 knots. At 15,946 feet from the liftoff point this plane must be 2812 feet (about 1/2 mile) high.

1. Assuming the angle of ascent is a constant, find the angle the plane must use to achieve this height at this distance - to the nearest degree. Make a diagram and explain how you arrived at your answer.
(Open the [Beginner's Guide to Propulsion](#) and open the slide Forces in a Climb under Aircraft Motion.)
(Note: Don't forget to change radians to degrees.)

2. We are going to use this information to find vertical and horizontal net forces.
 - a. Find the thrust for a Boeing 737-600 airplane.

To find the thrust of the airplane go to [Boeing 737-600](#)
http://www.boeing.com/commercial/737family/pf/pf_600tech.html.

Thrust = _____

- b. What is the take off weight of the plane?

Change this weight to newtons

Weight in lbs. = _____ Weight in newtons = _____

- c. Use the first equation on the [Forces In A Climb](#) page to find vertical net force.

Use 700,000 N as the lift and 35,000 N as the drag.

Show the original equation and then show the substitutions with your answer. Label answer with correct units.

- d. Use the second equation to find the horizontal net force, use lift and drag from part c above.

Show the original equation and then show the substitutions with your answer. Label answer with correct units.

3. Divide your net force from 2c and 2d by the weight of the airplane to get the vertical and horizontal acceleration in “g’s” (ratioed to gravitational acceleration).

a. Vertical acceleration = _____ g’s

b. Horizontal acceleration = _____ g’s

ACTIVITY
Newton's 3rd Law
using a Balloon
Helicopter



Interactive Demonstration: Demonstration of Newton's Third Law Using a Balloon Helicopter

Yee-kong Ng, Se-yuen Mak, and Choi-man Chung. *The Physics Teacher*, 40, 181 (2002).

Objectives

Draw force diagrams to explain how the balloon helicopter whistle works.

Materials

Balloon helicopter whistle
Balloon

NGSS

CDI HS-PS2
SEP 2, 7
CCC 2, 4, 6

Cheap balloon helicopter whistles can be purchased from toy stores online.

As students observe the balloon take off and then remain in the air for up to a half-minute, students can draw force diagrams and explain how the balloon remains in the air due to the "exhaust" through the air channel. Students should consider both horizontal forces causing rotation, as well as vertical lift forces from the blades. (Students can construct their own nozzles and wings).

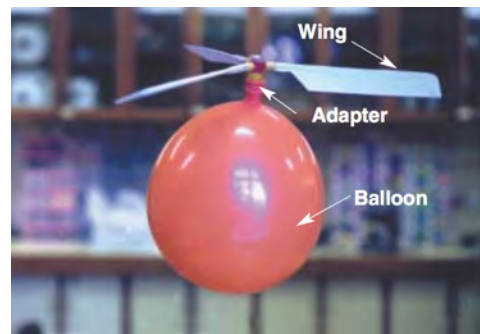
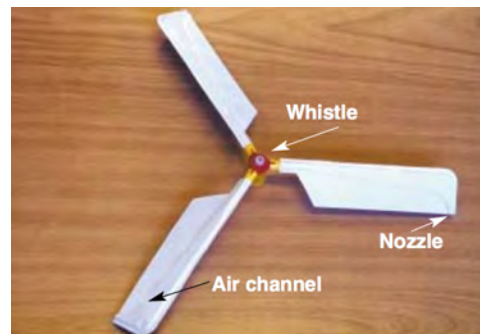

Student Worksheet: Demonstration of Newton's 3rd Law Using a Balloon Helicopter

Observe the balloon helicopter as it launches.

1. Explain why the balloon helicopter **rotates**. Include separate force diagrams for points on the helicopter blades as well as for parcels of air just outside of the air nozzles. Be certain to identify any **force pairs** that interact with the helicopter system.

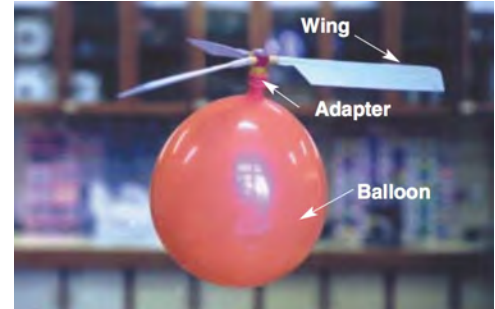

2. Explain why the balloon helicopter **lifts** vertically. Include separate force diagrams for points on the helicopter blades as well as for parcels of air surrounding the blades. Be certain to identify any **force pairs** that interact with the helicopter system.

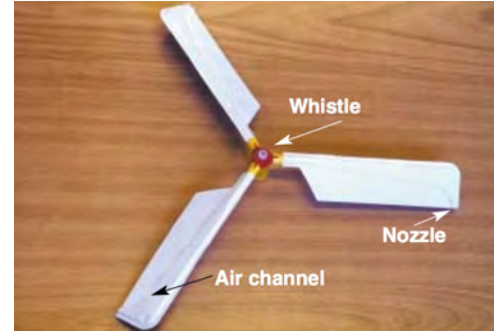

3. Get your balloon helicopter to *hover* for a few moments, and be certain to record a video of the blades spinning at the required frequency for it to hover. During the time of the hover:
 - a. Estimate the lift produced by the helicopter. Explain how you measured/calculated this amount.
 - b. Estimate the total surface area of the blades (single side, for all three). Show work.
 - c. Using a coefficient of lift of 1 (a reasonable value for toys such as these), determine the average required velocity of the blades through the air.
 - d. Determine the average radius of the blades.
 - a. Work backwards to estimate the time for one rotation of the set of blades.
 - b. Use a video analysis tool to estimate the actual time for one rotation of the set of blades. Is your estimated value very different? Why might this be?



2-D Combination



A joint project of
NASA Aeronautics
and the
American Association of
Physics Teachers





Real-World Applications: Measuring the Flight Speeds of Fire Bombers from Photos: An In-Class Exercise in Introductory Kinematics

Greg W. Lowe & Eric Ayars. *The Physics Teacher*, 48, 106 (2010).

Objectives

Estimate flight speed from a fire bomber.

Materials

Fire bomber photos
Photo analysis software
Fire bomber aircraft statistics

NGSS

CDI HS-PS2
SEP 2, 4, 5
CCC 4, 5

Image and video analysis software can be used to determine the speed of a fire bomber, as the plane leaves a nice “track” with the leading edge of the falling flame retardant.

In this activity, students are asked to evaluate another hypothetical student’s claim to be able to determine the speed of the aircraft based upon the photograph of the fire bomber and its trail. Students should identify potential:



Assumptions:

- Wind is still
- Airplane does *not* propel the flame retardant (it is simply dropped)
- Airplane is flying level

Mistakes:

- Give the above assumptions, it would be a mistake to assume that the lowest leading edge of the flame retardant was released first – the back end would have been dropped first!

Student Worksheet: Measuring the Flight Speed of Fire-Bombers

Fire bombers are aircraft that eject flame retardant on large fires, and are regularly used to put out massive forest fires. Frequently, the retardant has a visible color.

The following is an example of another student's work and calculations, in which s/he is attempting to determine the speed of the airplane. **It is your job to identify any assumptions and/or potential mistakes (if any!) made by the student.**

A single known value (the plane length) can be found online. In this particular case, the S-2A is 13.3 meters long. This value can be used to estimate the vertical and horizontal distances of the flame retardant.

When the retardant is ejected, it creates a parabolic shape at the trailing (bottom) edge.

Because the flame retardant appears to have fallen a distance of about 1.1 plane lengths (15 m), the total time since the release of the retardant can be estimated – assuming there is no air resistance.

Using the kinematics equation:

$$\Delta x_v = \frac{1}{2} a_g t^2 + v_{x_i} t,$$

t is equal to about 1.7 seconds.

Given that the length of the horizontal trail appears to be 6.7 airplane lengths, or 89 m, the constant horizontal velocity should be about 52 m/s, which seems to be a reasonable value!

What assumptions and potential mistakes did the student make about this image?





NASA Tests Radio for Unmanned Aircraft Operations

http://www.nasa.gov/topics/aeronautics/features/uas_prototype_radio.html#.VHjAeI29-Rh

Analysis Questions:

- There has been some use of autonomous vehicles to fight wildfires. Why might this be beneficial, compared to the use of standard manned aircraft?
- There has been some concern over maintaining the quality of signals when communicating with autonomous vehicles. What factors – especially those in the vicinity of a wildfire – might be cause for concern?

Problem Set: Aircraft Motion Activity

from *Beginner's Guide to Aeronautics*

[Student Worksheet](#)

[Teacher Answer Key](#)

The pilot of an airplane sent to drop supplies to victims of an accident that are stranded on a small island. The plane's altitude is always 500 meters and your speed is 89.61 m/s.

1. Once released, how much time will elapse before the supply package reaches the island's surface?

(**Hint:** Use the distance equation in the y-direction.)

time = _____

2. Will the descent time of the supply package change if the airplane's speed changes?

a. Yes

b. No

3. At what (horizontal) distance in front of the island should the package be released in order land safely on the island?

$d_x =$ _____

4. What is the package's horizontal speed when it makes landfall on the island?

$v_x =$ _____

5. What is the package's vertical speed when it makes landfall?

$v_y =$ _____

6. What will be the package's flight angle with respect to the level of the island as it descends?

$q =$ _____

Suppose the victims on the island can retrieve supply packages that land within 30 meters of the island. The length of the island is 50 meters along the direction you are approaching.

7. How far from the island would the airplane have to release the supply package for it to land 30 meters offshore from the island's nearest point?

$$d_{x(\text{front})} = \underline{\hspace{2cm}}$$

8. How far from the island would the airplane have to release the supply package for it to land 30 meters offshore from the island's farthest point?

$$d_{x(\text{back})} = \underline{\hspace{2cm}}$$

9. Time₁ will be the time on your watch when you release the package and it lands 30 meters in **front** of the island. Time₂ will be the time on your watch when you release the package and it lands 30 meters in **back** of the island. Calculate the amount of time you have to successfully drop the package, namely, time₁ - time₂.

$$\text{time}_1 - \text{time}_2 = \underline{\hspace{2cm}}$$

10. What could be done to decrease the package's speed when it reaches the ground?



Energy



A joint project of
NASA Aeronautics
and the
American Association of
Physics Teachers



ACTIVITY
A Hard Day's Flight



Objectives

Estimate flight speed from a firebomber.

Materials

Firebomber photos
Photo analysis software
Firebomber aircraft statistics

NGSS

CDI HS-PS2
SEP 2, 4, 5
CCC 4, 5

CCSS

Reading in Science
Writing in Science

Literary/Data Analysis: A Hard Day's Flight

Henk Tennekes. *The Simple Science of Flight*. The MIT Press: Cambridge, Massachusetts. Ch. 2

Have students read Chapter 2 of *The Simple Science of Flight*.

This chapter provide a great example of the connections between physics, biology, and chemistry, as it discusses metabolic energy, combustion, and flight mechanics.

Have students use the questions on the following page for literary and data analysis.

*Cover image and graphics from *The Simple Science of Flight* are reproduced here with permissions from The MIT Press.

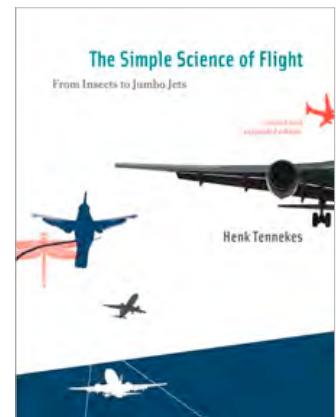

Teacher Answer Key: A Hard Day's Flight

1. How does the basal metabolic rate of birds compare to humans? Why do you think this is the case?

A birds' basal metabolic rate is about 10 times faster than humans'. This is because birds need to access energy from their food much more quickly: flight demands a lot more energy than anything that humans typically do throughout the day.

2. Only about 25% of metabolic energy gets converted to mechanical energy. Where does the remainder go? How does this value compare to the chemical to mechanical energy conversion of airplanes? (You might need to do some internet research to figure this out!)

Heat! For most fuel types, only about 15% of the energy is extracted from fuel.

3. Looking at Figure 6, how does speed required for maximum efficiency compare between a 5 degree climb, horizontal flight, and 5 degree descent? Why?

The speed for maximum efficiency is about the same for a climb or horizontal flight (8 m/s). It is about 9 m/s for a 5 degree descent. It makes sense that the value is higher for descent, because the bird is falling and picking up speed without much effort – attempting to slow down would take energy.

4. Looking at Figure 6, why is it so difficult to fly slowly or quickly, compared to at a medium speed?

Speed has to be relatively high in all cases, because flying slowing means that less lift is achieved. Going too fast, however, increases total drag, and results in it being harder to fly.

Energy, Work, and Power

5. Relating Figure 6 to Figure 7, explain why the speed at which drag is the smallest is not the same as the speed at which the required power is a minimum.

Figure 7 shows how much energy is needed per unit distance, while figure 6 shows how much energy is needed per unit time. Figure 6 is looking at energy rate, not total energy for a given distance of travel.

6. Look at Figure 8 displaying power and velocity for a variety of vehicles. What would this graph look like on a Cartesian, non-logarithmic graph? Explain why the data demonstrates a curved, non-linear relationship.

The graph would curve to the upper right and then flatten out to an asymptote. Doubling speed requires power to increase logarithmically, partly because friction is more difficult to overcome as one moves more quickly.

Nutrition and Combustion

7. What is the difference between fuel consumption and energy consumption?

Fuel consumption refers to the food or chemical energy taken in. Energy consumption refers to the number of calories that can actually be used or processed from the intake.

8. Looking at Table 3, which foodstuff and which fuel provide the greatest energy density?

Vegetable oil and natural gas

Student Worksheet: A Hard Day's Flight

1. How does the basal metabolic rate of birds compare to humans? Why do you think this is the case?
2. Only about 25% of metabolic energy gets converted to mechanical energy. Where does the remainder go? How does this value compare to the chemical to mechanical energy conversion of airplanes? (You might need to do some Internet research to figure this out!)
3. Looking at Figure 6, how does speed required for maximum efficiency compare between a 5 degree climb, horizontal flight, and 5 degree descent? Why?
4. Looking at Figure 6, why is it so difficult to fly slowly or quickly, compared to at a medium speed?

Energy, Work, and Power

5. Relating Figure 6 to Figure 7, explain why the speed at which drag is the smallest is not the same as the speed at which the required power is a minimum.
6. Look at Figure 8 displaying power and velocity for a variety of vehicles. What would this graph look like on a Cartesian, non-logarithmic graph? Explain why the data demonstrates a curved, non-linear relationship.

Nutrition and Combustion

7. What is the difference between fuel consumption and energy consumption?
8. Looking at Table 3, which foodstuff and which fuel provide the greatest energy density?



ACCESS II Confirms JetBiofuel Burns Cleaner

<http://www.nasa.gov/aero/access-ii-confirms-jet-biofuel-burns-cleaner/#.VHS9BY29-Rg>

Analysis Questions:

- What evidence does NASA have that blended fuel is better than typical jet fuel?
- What is the new biofuel made of? Why is it considered “renewable”?
- Compare the benefits and disadvantages to using biofuels that were not mentioned in this article. (What kind of impact would the mass usage of biofuel have on the economy, pollution, agriculture, food availability, deforestation, etc.?)
- One of the goals of ACCESS is to study contrail formation. What is a contrail, and why are they generally perceived as negative for the environment?



Objectives

Explain how birds and planes store and use energy during flight.

Materials

The Simple Science of Flight, Ch. 3

NGSS

CDI HS-PS3
SEP 4, 6
CCC 1, 4, 5

CCSS

Reading in Science
Writing in Science

Literary/Data Analysis: In Wind and Weather

Henk Tennekes. *The Simple Science of Flight*. The MIT Press: Cambridge, Massachusetts. Ch. 3

Have students read Chapter 3 of *The Simple Science of Flight*.

This chapter continues to provide additional examples of the connections between physics, biology, and chemistry. It discusses the effect of wind on the achievement of lift, the ability to soar, the effect of thermals and slopes, long-distance migration, and the mechanics of take-off and landing.

Have students use the questions on the following page for literary and data analysis.

*Cover image and graphics from *The Simple Science of Flight* are reproduced here with permissions from The MIT Press.



Teacher Guide and Key: In Wind and Weather

1. How does wind direction influence flight times, takeoff, and landing? Explain.

Wind vectors can cause an airplane to arrive sooner (as with a tailwind) or arrive later (as with a headwind). Airplanes benefit from having a headwind during takeoff, however, because it generates lift. In contrast, a tailwind necessitates that an airplane achieve a greater groundspeed before takeoff. For an ultralight plane (with a takeoff speed of approximately 40 miles per hour), just a 10 mile per hour tailwind almost doubles the necessary takeoff speed.

2. How does wind influence insects, small birds, large birds, and very large planes? Why?

Wind has a much greater impact on the direction and speed of small animals than large ones. Smaller animals have less inertia to keep them on their track.

3. What are the two primary methods for soaring? Explain how they work.

1. *Birds “slope soar” in areas where wind moves upward as it pushes against tall structures such as boats or ridges.*
2. *Birds track down thermals (rising pockets of hot air) that form above hot ground.*

4. How do birds prepare to have enough energy for migration? (Likewise, how do airplanes prepare for long flights?) What is the downside to being overly prepared, in terms of energy storage, during the first portions of the flight?

Birds gorge on food and gain fat. Airplanes fill up on fuel (although not much more than they know they will need). The downside is that the initial part of the trip will require more energy expenditure to sustain such heavy mass.

5. Verify the calculations (that $R = 2160$ m) for the Boeing 747-400 using kinematics equations. (see pg. 52).

6. Describe the flight procedures for takeoff and landing for birds, and compare this to takeoff and landing procedures for airplanes.

*It might seem unusual, but birds actually prefer to have a bit of headwind when they take off in order to generate lift at low speeds. Preferably, birds will take off from a high point so that they can use the force of gravity to speed themselves up and generate lift. When landing, birds will often “backwing,” which is a form of air braking. Winds are very important for lift, especially during takeoff and landing. Both takeoff and landing should occur with a headwind, because planes need to have a high speed **with respect to the wind** in order to gain lift. A tailwind could cause a stall much more easily at the slow speeds of takeoff and landing.*

Student Worksheet: In Wind and Weather

1. How does wind direction influence flight times, takeoff, and landing? Explain.
2. How does wind influence insects, small birds, large birds, and very large planes? Why?
3. What are the two primary methods for soaring? Explain how they work.
4. How do birds prepare to have enough energy for migration? (Likewise, how do airplanes prepare for long flights?) What is the downside to being overly prepared, in terms of energy storage, during the first portions of the flight?
5. Verify the calculations (that $R = 2160$ m) for the Boeing 747-400 using kinematics equations. (see pg. 52).
6. Describe the flight procedures for takeoff and landing for birds, and compare this to takeoff and landing procedures for airplanes.



NASA Helicopter Drop Test a Smashing Success

<http://www.nasa.gov/larc/helicopter-drop-test-a-smashing-success/#.VHS7go29-Rg>

Analysis Questions:

- Explain how the floor of the helicopter was modified to improve crash-landing safety.
- What was the purpose of the dots on the helicopter? Explain how this works.



Rotational Motion



A joint project of
NASA Aeronautics
and the
American Association of
Physics Teachers





Real-World Applications: Circular Motion Studies with a Toy Airplane/The Airplane Experiment

[Frank Butcher, *The Physics Teacher*, 25, 572 \(1987\).](#)

[Lee Larson & Roderick Grant, *The Physics Teacher*, 29, 564 \(1991\).](#)

Objectives

Determine the tension in the string of an airplane flying in a circle.

Materials

Toy airplane
String
Meter stick
Flashlight (opt.)
Force meter
Electronic balance (opt.)
Stop watch

NGSS

CDI HS-PS2
SEP 1-7
CCC 4, 6

There are a number of mobiles and battery-powered airplanes (flyers or remote controlled) that can be easily attached to a ceiling and caused to move in a horizontal circle. These toys provide a wonderful opportunity for students to predict the tension in the string, which can then be checked against a measurement taken by an analog or digital force meter.

Under normal conditions, in which an airplane is traveling at a constant velocity, the lift force would equal the weight. When flying in a circle, however, a net inward force must be directed on the plane to cause it to accelerate (and change direction).

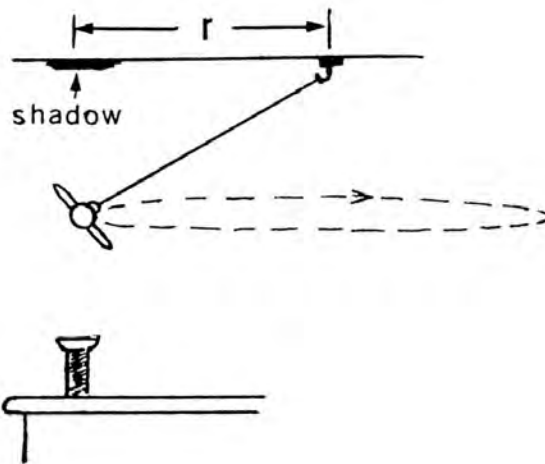

The force on the airplane can be easily identified as F_g and F_T . However, F_T is unknown. A force diagram can be drawn in which F_T can be resolved into both a horizontal, F_{Tx} , and vertical F_{Ty} . Because the plane does not accelerate vertically, it can be assumed that F_g is equal to F_{Ty} , and that F_{Tx} is the net force (centripetal force), for which we have an expression and for which we can calculate a value. Using the measured weight of the plane and equating it to F_{Ty} , the angle can be estimated and used to solve for F_T , which can be checked against a spring scale or digital force meter from which the flying plane is supported.

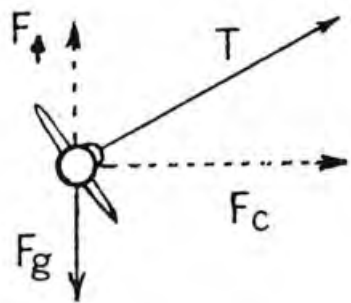

Additionally, the wings of an airplane can sometimes be removed or broken off, and data compared to determine the effect of lift due to the wings.

Table I. Sample data from a run in the airplane experiment.

	With wings	Without wings
Mass of plane	0.140 ± 0.001 kg	0.120 ± 0.001 kg
Length of string, L	1.056 ± 0.002 m	1.083 ± 0.002 m
Period, T	1.35 ± 0.01 s	1.13 ± 0.01 s
Tension computed from kinematics	3.20 ± 0.06 N	4.01 ± 0.08 N
Tension measured	2.97 ± 0.03 N	3.97 ± 0.03 N
Ratio, computed to measured (authors)	1.08 ± 0.02	1.01 ± 0.02
Ratio, computed to measured (averaged from 28 student data sets; fall semester, 1989)	1.08 ± 0.09	(not done)

Teacher Worksheet: Circular Motion Studies with a Toy Airplane

Aim



Objective: Determine the tension of string on an aircraft flying in a circle.

Plan



1. Observe the toy airplane as it flies in a circle. What variables must be known about it in order to determine the tension in the string?

(Hint: Feel free to stop the toy at any time, remove it from its string, etc. Consider using the “flashlight method” to determine the radius of the circle it makes as it flies. To do this, place a flashlight directly below the flying airplane. The smallest, crispest shadow will be produced when the flashlight is directly below it, point directly up. A small mark can be made on the ceiling where the shadow is, and a measurement can be made from the pivot point to the mark from the location of the shadow.)

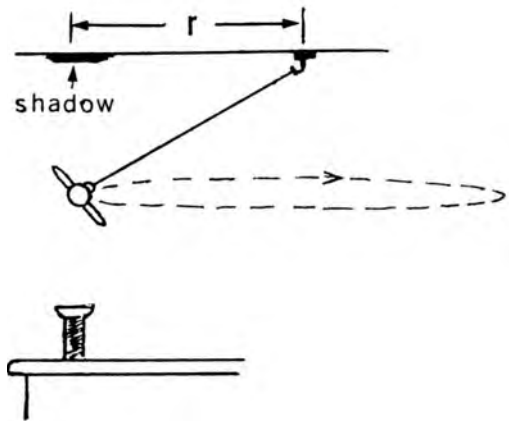

Students will need to collect the mass of the airplane, radius, and rotational speed (using the radius and average time to complete a cycle).

Decide



2. Decide what data you will need to collect, and how you will go about doing it.

Act



3. Once you have collected your necessary data, draw a force diagram (with components) and label any known values. Solve for the tension force.

Students should note that weight (determined from kg on a balance or directly read on a force meter) is equivalent to the magnitude of the vertical force.

Using the length of the string and the radius, they can then determine the angle. Using the vertical force and the angle, the tension force and the centripetal force (for #4 below) can be easily calculated.

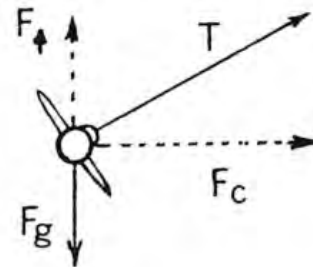

Verify



4. With the help of your teacher, attach a force meter to flying airplane device. Record the force measured by the force meter. Address any discrepancies between your calculated tension force, and the measured tension force.

Answers will vary.

5. Determine the centripetal force on the aircraft.

See #3.

E-valueate



6. If possible, remove the wings of the aircraft. How do you anticipate this will affect the tension and the centripetal forces? Why? Perform an experiment, and check.

Weight will decrease, but so will lift. So, the required vertical component of the tension force will decrease because the weight will decrease, but it will also increase because the lift generated by the wings will decrease. The net result on the centripetal force will also be dependent upon the mass, which is now smaller.

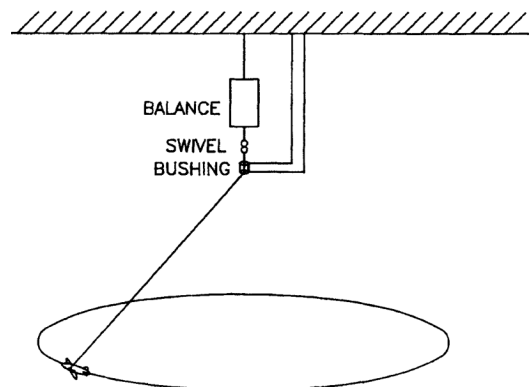

Student Worksheet: Circular Motion Studies with a Toy Airplane

Aim



Plan



Objective: Determine the tension of string on an aircraft flying in a circle.

1. Observe the toy airplane as it flies in a circle. What variables must be known about it in order to determine the tension in the string?

(Hint: Feel free to stop the toy at any time, remove it from its string, etc. Consider using the “flashlight method” to determine the radius of the circle it makes as it flies. To do this, place a flashlight directly below the flying airplane. The smallest, crispest shadow will be produced when the flashlight is directly below it, point directly up. A small mark can be made on the ceiling where the shadow is, and a measurement can be made from the pivot point to the mark from the location of the shadow.)

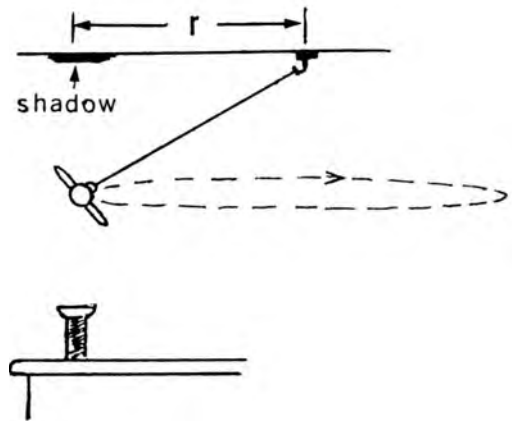

Decide



2. Decide what data you will need to collect, and how you will go about doing it.

Act



3. Once you have collected your necessary data, draw a force diagram (with components) and label any known values. Solve for the tension force.

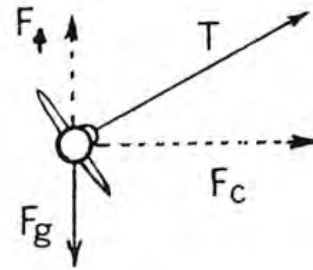

Verify



4. With the help of your teacher, attach a force meter to flying airplane device. Record the force measured by the force meter. Address any discrepancies between your calculated tension force, and the measured tension force.

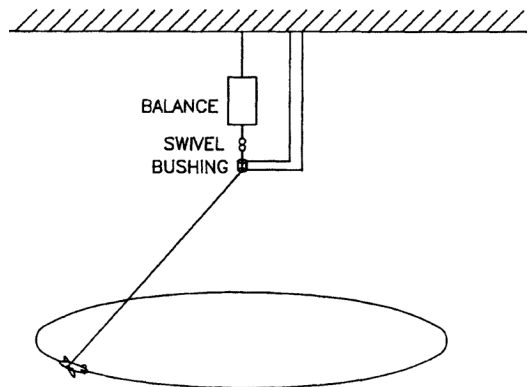

5. Determine the centripetal force on the aircraft.

E-valuate



6. If possible, remove the wings of the aircraft. How do you anticipate this will affect the tension and the centripetal forces? Why? Perform an experiment, and check.

ACTIVITY
Measuring the
Moment of Inertia
of an Airplane



Real-World Applications: Measuring the Moment of Inertia of an Airplane

[Lyle F. Minkler, *The Physics Teacher*, 13, 46 \(1975\).](#)

Objectives

Determine the center of mass and moment of inertia of a model aircraft.

Materials

Model aircraft
Razor blades
Rubber stoppers
Small compression spring
Timer
Electronic balances

NGSS

CDI HS-PS2
SEP 1, 2, 5, 6
CCC 4, 6, 7

The general public is typically surprised to find that, even in rough turbulence, pilots are generally “riding it out” as opposed to fiercely gripping the aircraft controls white-knuckled, trying to maintain control. This is because aircraft are made to be stable. Airplanes “want” to fly level, so to speak, and are designed to be that way.

The stability of an aircraft in flight is directly tied to the center of mass and moment of inertia of the aircraft.

Because setups for this laboratory experience are likely to be so diverse, no student worksheet is provided for this activity.



Objective: Determine the center of mass of a model aircraft.

Finding the center of mass of an aircraft can be easily accomplished in a variety of ways. For model aircraft, it is easy enough to simply attach a loop of string to the fuselage, and to place it in such a way that the aircraft is balanced when suspended from a given point.

However, realistically, this cannot be easily accomplished with a full-sized aircraft. Alternatively, the aircraft can be treated as a “lever” with the reference datum point starting at the nose of the aircraft. Students can measure the force exerted by the forward and aft gear (placed on two or three balances), as well as the distances from the reference datum line to the points of contact with the balances. Because the sum of the torques produced at each contact point must equal the total torque of the aircraft measured from the reference datum line,

$$F_{\text{forward}} d_{\text{forward}} + F_{\text{aft}} d_{\text{aft}} = F_{\text{weight}} d_{\text{center of mass}}$$

The following NASA resource has a very good video describing the above process:

Video: Flight Testing Newton’s Laws – Weight and Balance

http://www.nasa.gov/mov/194114main_020_weight_and_balance.mov



Objective: Determine the moment of inertia of a model aircraft.

An aircraft with a *high* moment of inertia about its center of mass is very stable, while an aircraft with a *low* moment of inertia is less stable (however, it is easier to maneuver). An important part of testing aircraft before flight is to identify their moment of inertia.

Ideally, moment of inertia should be measured with respect to the center of gravity. However, to determine the moment of inertia with an oscillating spring (as is used in this approach, and has been used historically in the aircraft industry), the center of rotation cannot be placed at the center of gravity, otherwise it would not oscillate effectively.

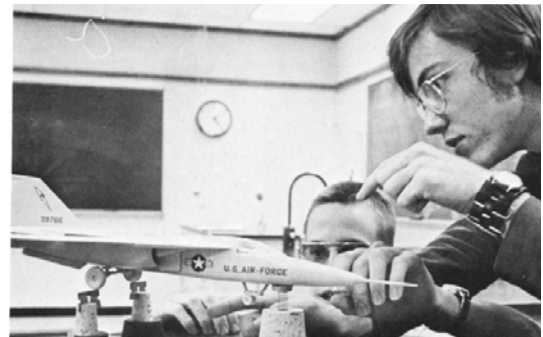

The frictionless pivot for the study of moment of inertia should be placed at a location that is not at the center of gravity. The aircraft can be balanced at this point with the use of razorblades mounted onto corks, and attached to a solid platform. The front end of the aircraft can then rest upon a coiled compression spring of known spring constant, *k*.

Using an expression for torque and moment of inertia, the period of oscillation can be used to calculate the moment of inertia of the aircraft.

$$\begin{aligned} \tau_x &= I \alpha \\ T &= \frac{2\pi}{\omega} \\ T &= 2\pi \sqrt{\frac{I}{k(\Delta x)^2}} \end{aligned}$$

Students must then locate the center of mass, and use the transformation formula:

$$I = I_{cm} + ma^2$$

Additionally, an historical document demonstrates how this process has been used throughout aeronautical history:

<http://naca.central.cranfield.ac.uk/reports/arc/rm/3620.pdf>



Additional Resources



A joint project of
NASA Aeronautics
and the
American Association of
Physics Teachers





Objectives

Compare the 747 and its competitors

Materials

The Simple Science of Flight, Ch. 6

CCSS

Reading in Science
Writing in Science

Literary/Data Analysis Activity: The 747 and its Competitors

Henk Tennekes. *The Simple Science of Flight*. The MIT Press: Cambridge, Massachusetts. Ch. 6

Have students read Chapter 6 of *The Simple Science of Flight*, and use the following guiding questions for literary analysis.

*Cover image and graphics from *The Simple Science of Flight* are reproduced here with permissions from The MIT Press.

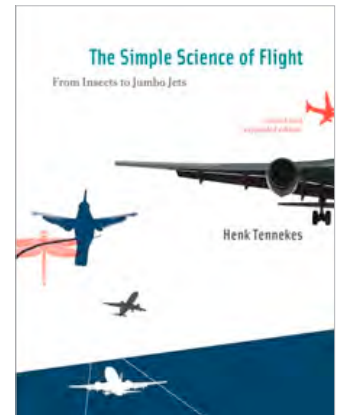

Teacher Guide and Key: The 747 and its Competitors

1. Compare the benefits and disadvantages of the Boeing 747 contrasted with the Concorde.

Benefits of 747: Uses less fuel, carries more people and cargo, can go twice the range, higher finesse, cheaper

Disadvantages of 747: Goes more slowly. (It also has much smaller stall angle).

2. List the four requirements for the Boeing 747 design team, and include a brief rationale for each requirement.

Requirement	Rationale
<i>High speed and finesse</i>	<i>Save time and money</i>
<i>Fly just below speed of sound</i>	<i>Greater engine efficiency</i>
<i>Fly in lower stratosphere</i>	<i>Cooler temps for engine, avoids weather</i>
<i>Don't fly any higher!</i>	<i>Wings are good design for particular height</i>

3. Look at Table 6. At which listed altitude would an airplane fly to be most efficient? Consider all variables, and how they influence engine performance, drag, and lift. Keep your answers based upon qualitative analysis only.

Around 10,000-11,000 m. At this altitude, you are reaching the maximum coldness that makes for efficient jet engines. Going higher would also require larger wings to sustain flight, as the density of the air decreases to a sub-optimal value.

Student Worksheet: The 747 and its Competitors

1. Compare the benefits and disadvantages of the Boeing 747 contrasted with the Concorde.

2. List the four requirements for the Boeing 747 design team, and include a brief rationale for each requirement.

Requirement	Rationale

3. Look at table 7. At which listed altitude would an airplane fly to be most efficient? Consider all variables, and how they influence engine performance, drag, and lift. Keep your answers based upon qualitative analysis only.



NASA Resources

NASA Aeronautics

<http://www.nasa.gov/topics/aeronautics/index.html>

NASA Aeronautics Education

http://www.aeronautics.nasa.gov/k_12.htm

Museum in a Box

<http://www.aeronautics.nasa.gov/mib.htm>

- Dressing for Altitude
- History of Flight
- Parts of an Airplane
- Principles of Flight
- Structures and Materials
- Propulsion
- Future Flight
- Careers in Aeronautics
- Airspace

Beginner's Guide to Aeronautics

- Beginner's Guide to Aerodynamics
<http://www.grc.nasa.gov/WWW/k-12/BGA/BGAindex.html>
- Beginner's Guide to Propulsion
<http://www.grc.nasa.gov/WWW/K-12/airplane/bgp.html>
- Beginner's Guide to Wind Tunnels
<http://www.grc.nasa.gov/WWW/K-12/airplane/bgt.html>
- Beginner's Guide to Compressible Aerodynamics
<http://www.grc.nasa.gov/WWW/K-12/airplane/bgc.html>
- Beginner's Guide to Hypersonics
<http://www.grc.nasa.gov/WWW/BGH/bgh.html>



AAPT Resources

American Association of Physics Teachers

<http://www.aapt.org/>

***The Physics Teacher* magazine**

<https://www.aapt.org/Publications/>



Additional Resources

Literature Resources

Tennekes, Henk. *The Simple Science of Flight*. MIT Press. (1996.) *Cover image and graphics from *The Simple Science of Flight* are reproduced in this document with permissions from The MIT Press.

Leybold Lessons (and Laboratory Equipment)

<http://www.ld-didactic.de/en.html>

- [P1.8.5.1 Static Pressure in a reduced cross section – Measuring the pressure with the precision manometer](#)
- [P1.8.5.2 Determining the volume flow with a Venturi tube – Measuring the pressure with a precision manometer](#)
- [P1.8.5.3 Determining the wind speed with a pressure head sensor – Measuring the pressure with the precision manometer](#)
- [P1.8.6.1 Measuring the air resistance as a function of the wind speed – Measuring the wind speed with the precision manometer.](#)
- [P1.8.6.2 Drag coefficient \$c_W\$: Relationship between air resistance and body shape – Measuring the wind speed with a precision manometer.](#)
- [P1.8.6.3 Pressure curve on an airfoil profile – Measuring the pressure with the precision manometer.](#)
- [P1.8.7.1 Recording an airfoil profile polar in a wind tunnel](#)
- [P1.8.7.2 Measuring students' own airfoils and panels in the wind tunnel](#)[P1.8.7.3 Verifying the Bernoulli equation – Measuring with the precision manometer](#)

Other Aeronautics Education Resources

[FliteTest](#) – Webshows, Podcasts, Articles, and Forums

[Civil Air Patrol](#) – Find a local squadron, become an Educator member

Developed by:

Rebecca E. Vieyra, 2014-2015 Albert Einstein Distinguished Educator Fellow placed at NASA ARMD, lead
Tony Springer, NASA ARMD Director of Communications and Education, lead
Lillian Gipson, Maria Werries, Jim Schultz, NASA ARMD Office of Communications and Education, graphic design, editing

Reviewers/Contributors:

Dr. Beth Cunningham, Executive Officer, AAPT
Dr. Robert Hilborn, Associate Executive Officer, AAPT
Dr. André Bresges, Managing Director, Institute of Physics Education, University of Cologne/Germany, AAPT member
Florian Genz, Doctoral Candidate, Institute of Physics Education, University of Cologne/Germany, AAPT member
Dr. Colleen Megowan-Romanowicz, Executive Officer, American Modeling Teachers Association, AAPT member
Dr. Philip Blanco, Grossmont College, AAPT member
Dr. Roger Freedman, Physics Education, UC Santa Barbara, AAPT member
Ron Bowerman, St. Wendelin High School, AAPT member
Col. George Zamka (USMC, ret.), NASA Astronaut, Test Pilot
Daniel Scopel, Pilot
April Lanotte, Science Education, University of Colorado-Boulder, 2011-2013 Albert Einstein Distinguished Educator Fellow
Thomas Benson, NASA Glenn, Beginner's Guide to Aeronautics

National Aeronautics and Space Administration, Aeronautic Research Mission Directorate

Washington, DC 20546-0001

<http://www.aeronautics.nasa.gov/education.htm>

<http://www.nasa.gov/aeronautics>

American Association of Physics Teachers

1 Physics Ellipse Dr.

College Park, MD 20740

<http://www.aapt.org>

National Aeronautics and Space Administration

Headquarters

300 E. Street, SW

Washington, DC 20546

www.nasa.gov

EG-2015--03-005-HQ