

# International Space Station-enabled Educational Opportunities

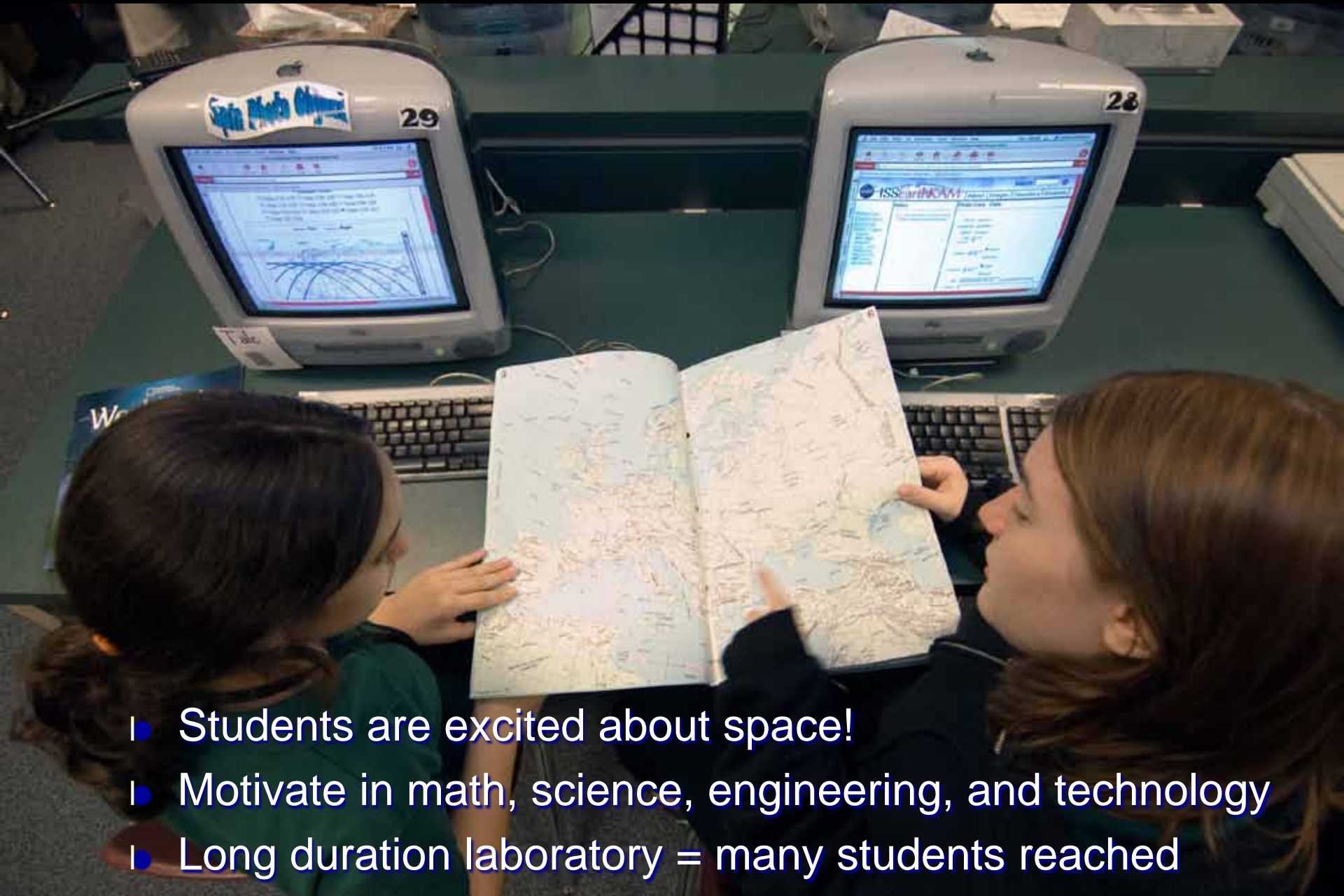

Julie A. Robinson, Ph.D.,  
ISS Program Scientist, NASA  
Outreach Seminar on the ISS  
United Nations  
February 2011

# Importance of ISS as an Education Platform



- Students are excited about space!
- Motivate in math, science, engineering, and technology
- Long duration laboratory = many students reached

# Educational Activities on ISS

- 
- A photograph of four children in a classroom setting. They are gathered around a table, focused on a project involving several small green plants in a black tray. One child is holding a yellow ruler. The background features a large, colorful mural of a cityscape with a satellite in the sky, a globe, and various buildings. To the left, there are bookshelves filled with books. The children are dressed in casual clothing, and the overall atmosphere is one of collaborative learning.
- Student-developed experiments, including contests
  - Students perform classroom versions of ISS experiments
  - Students participate in actual experiments
  - Students participate in engineering, hardware development, and operations activities
  - Educational demonstrations by astronaut/cosmonauts

# NASA-led International Opportunities



- Over 31 million students around the world
- Amateur Radio on ISS (ARISS)
  - 39 countries
  - Over 550 sessions with the ISS crew
- Earth Knowledge Acquired by Middle School Students (EarthKAM)
  - Students from 16 countries
  - Control Earth observations cameras onboard ISS

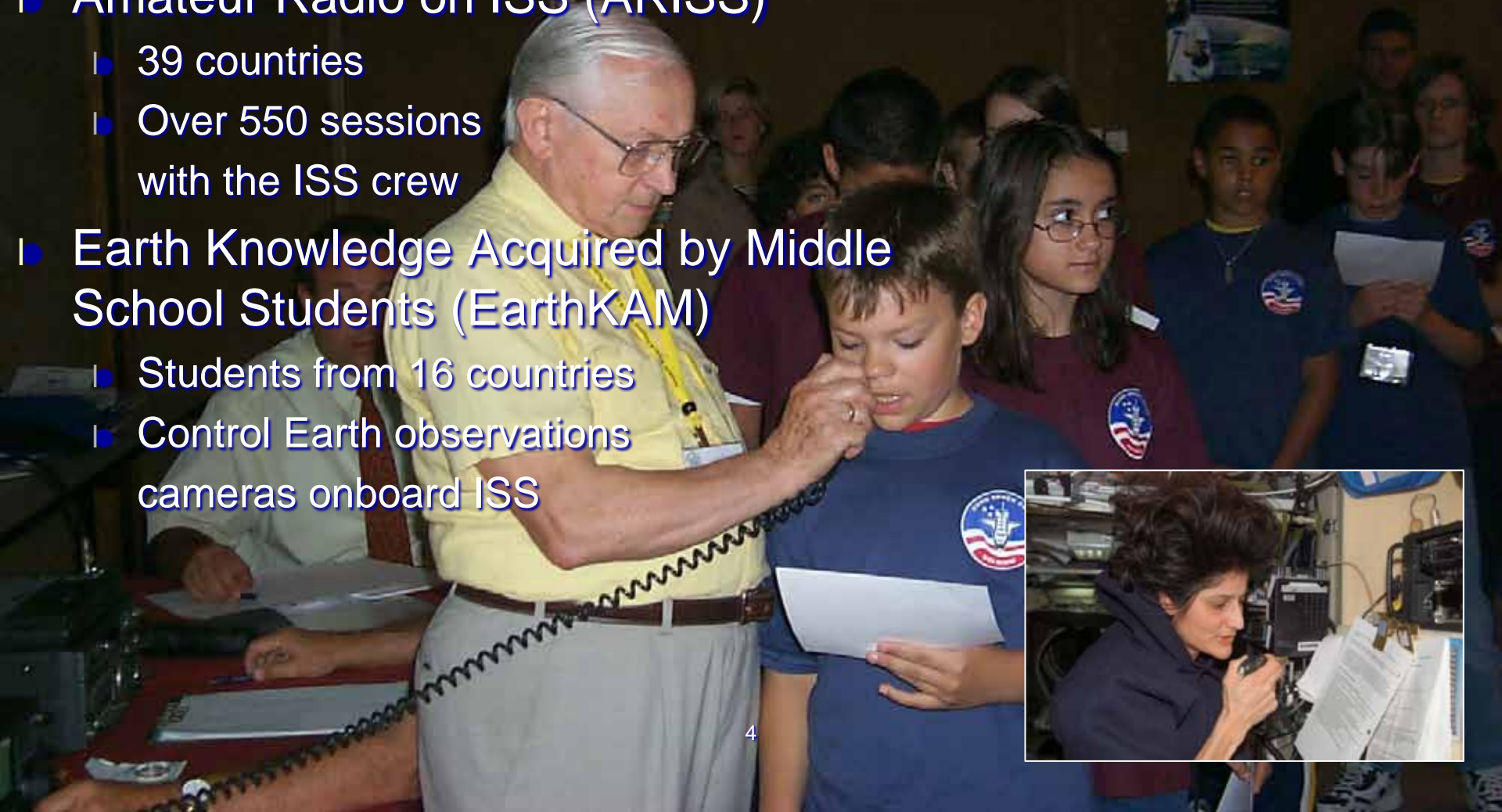

# NASA-led International Opportunities



- 1 In-flight Downlinks have also offered live audio/visual interaction between the ISS crew with students and the general public
- 1 Education Public Outreach (EPO) Demonstrations have provided a means of demonstrating the behavior of simple items in microgravity
- 1 Buzz Lightyear Mission Logs special feature video showcasing life on ISS developed in partnership with Disney-Pixar



# NASA Student-led Experiments



- Nanoracks/CubeLab: Self-contained cubesat form factor laboratory modules enabling student as well as professional grade experiments
- Synchronized Position Hold Engage and Reorient Experimental Satellite (SPHERES) internal satellites flying inside the ISS under the control of student developed software
- The Kids In Micro-g student microgravity design competition entering its 2<sup>nd</sup> year

# NASA: US Museums and Universities Sponsor Activities



- CGBA Student Investigations (CSI) allow students to conduct classroom controls to ISS experiments
  - Over 180,000 students participated in the Monarch butterflies life cycle experiment of CSI-3
- DRAGONSat built by students at University of Texas and Texas A&M to investigate new autonomous rendezvous technologies
- ARISSat-1 satellite developed by the Radio Amateur Satellite Corp. provides a platform for student built experiments to telemeter data via amateur radio links
  - International student participation in the development of satellite and experiment hardware through AMSAT



All NASA ISS Educational Opportunities at  
<http://www.nasa.gov/iss-science/> Click “Just for Educators”

# Roscosmos Education on ISS



РОСКОСМОС

- Conduct scientific experiments and lessons from space for:
  - education and popularization of space research;
  - promotion of the achievements of cosmonautics;
  - getting students practical skills in soft and hardware development;
  - realization of space experiments which clearly highlight the differences between conditions on the ground and space.
- Education space experiments:
  - A large number of schools and amateur radio network in Russia and world-wide are involved in space experiments Shadow-beacon and MAI-75.
  - Coulomb crystals and Coulomb's liquids on board the RS ISS (Coulomb crystal experiment) studies Study the processes of formation by charged dispersive diamagnetic macro-particles of condensed dust media

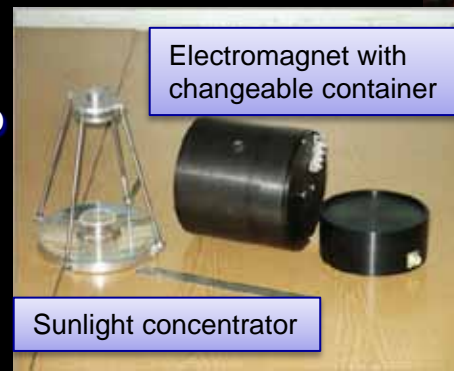
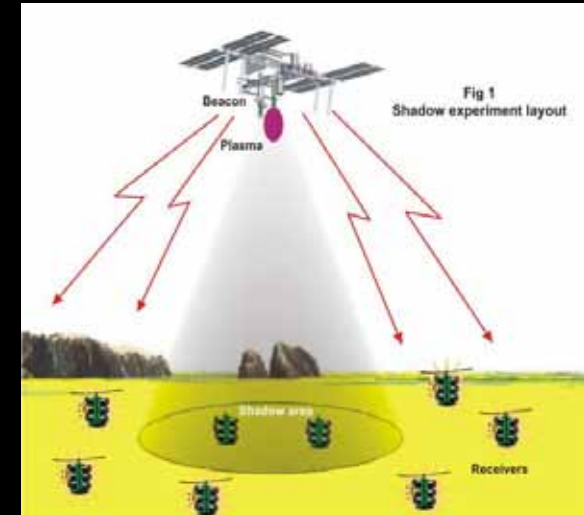



# Roscosmos Education on ISS



РОСКОСМОС

- Integrated space experiment Physics-Education:
  - Flying saucer: in a series of experiments intended to demonstrate stable and unstable rotation, reactive forces, Coriolis forces, gyroscopic effect.
  - Phase is a 3 sealed transparent vessel filled with fluid and air in different proportions, the experiment demonstrates processes of phase separation in containers after intense shaking.
  - Otolit: a hydromechanical model of vestibular human analyzer with three mutually perpendicular channels.

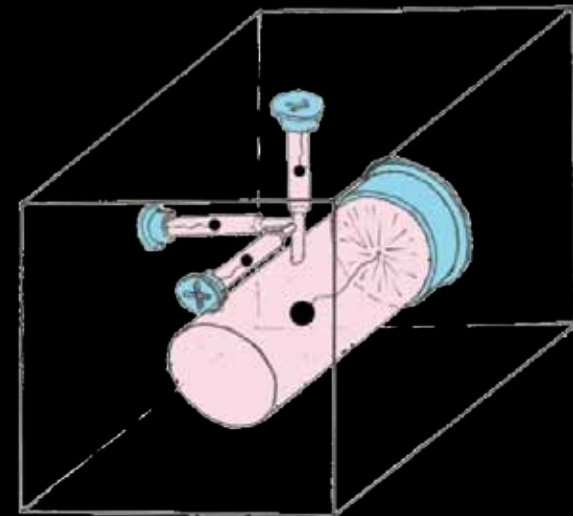



# CSA Education and Outreach Learning Products

- Learning Math, Science & Technology concepts while experiencing space
- Reaching 1.89 million Canadian students in 63,000 classrooms

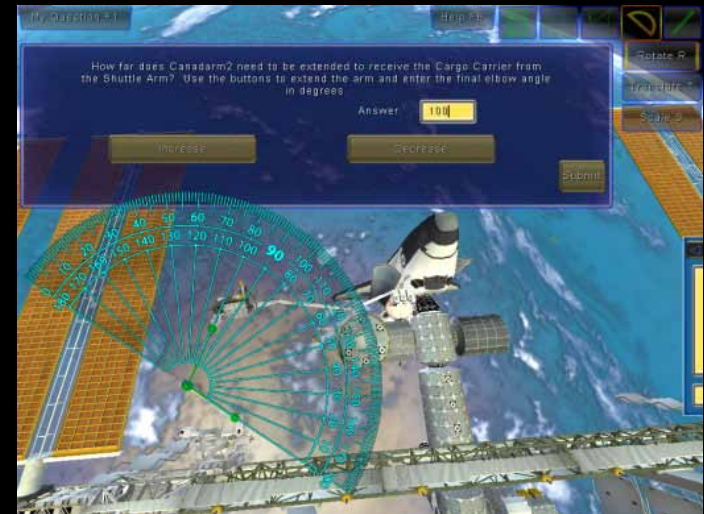

# CSA Education and Outreach Student Workshop Program



- Direct access to CSA scientists and engineers, graduate level researchers and astronauts
- Engaging 20,000 students across the nation



# CSA Education and Outreach Educator Professional Development



- Increasing educator awareness of the space context and how to use it to teach Math, Science and Technology concepts
- Providing educators with tools and scenarios to support learning



# CSA Education and Outreach Inquiry Based Learning Programs



- Unique learning experiences that encourage hands-on space focused science learning
- Mirroring similar research taking place within the Canadian Space Program



# ESA Classroom resources (Primary and Secondary)



## Web

- Online lessons: Lessons on various topics including the Columbus module. Translated in 13 languages
- mISSion possible series: 18 lessons and 100 activities covering topics such as ISS, weightlessness and being an astronaut
- Space in Bytes: short films 4-8 mins on ISS activities
- DVDs: 4 DVDs on ISS and 2 on Space Exploration



## Paper

- ISS education kit I and II: fully illustrated information source and experiment book on ISS and life in space. Translated into 12 languages.



## Radio

- ARISS (Amateur Radio on ISS): radio contact between astronauts on ISS and participating schools

# ESA “Take your classroom into space” (Secondary)



- Concept where schools participate in an experiment performed in classrooms as well as on ISS by astronaut.
- Frank de Winne (oasISS mission) :  
“Capillarity and Mass in Space”
  - Basic physics experiments performed in microgravity to demonstrate principles of physics
- Paolo Nespoli (magISStra mission):  
“Greenhouse in Space”
  - Demonstration to show growing plants from seed to generate More seeds is a viable option during long term space travel For food production purposes.  
Forthcoming Feb 2011
- André Kuipers: “Growing Crystals and Convection in Space”
  - Forthcoming 2012

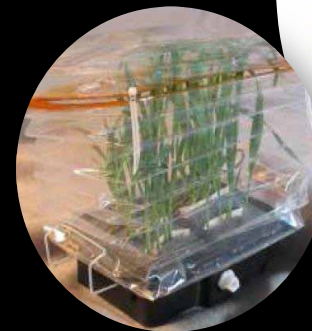

# ESA University-level education



- **SUCCESS programme: Space station Utilisation Contest Calls for European Student initiatives**

University students submit ideas for payloads which are reviewed by scientists at ESA for scientific merit and feasibility. One payload is then typically developed with the student or the student is given a post doctoral position in an academic team participating in a similar payload

- **Starting in 2011, SPHERES (Synchronised Position Hold Engage Reorient Experimental Satellites) will be opened to ESA member states in close collaboration with NASA/MIT**



# JAXA Educational Activities



## JAXA Seeds in Space I

- Mutation effects of spaceflight on seeds,
- Plants with diploid and self-pollination such as of Asagao (Japanese morning glory) and Miyako-gusa ( Japanese bird's foot trefoil )
- Identify the mutants from their phenotypes on the M2 generation.
- Twenty hundreds of Asagao seeds and sixty hundreds of Miyako-gusa seeds were stowed on the ISS for about 9 months and were delivered to Japanese schools after recovery to the earth.

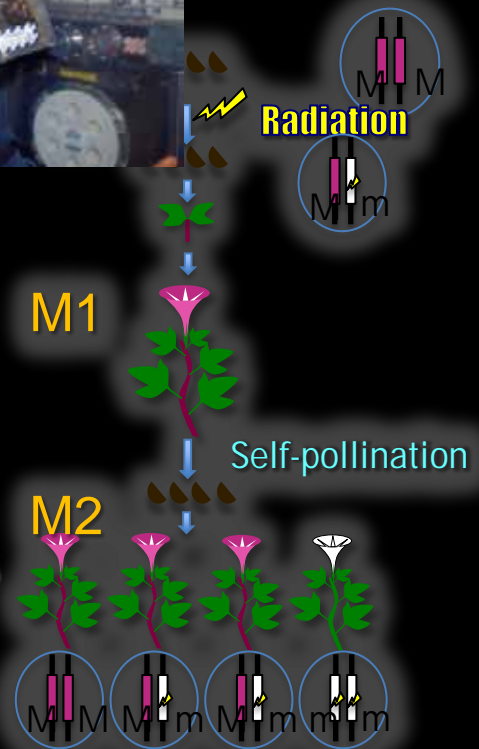

How to get the recessive homozygote (white flower in this figure).

## JAXA Spaceflight Kids Space Mission I

- Study the ecosystems and the Earth environments through growing spaceflight plant seeds and also by studying the space environment,
- Sunflower seeds stowed on the ISS for about 9 months were distributed to Japanese schools.

# JAXA Educational Activities



## Try Zero-G

- Japanese astronauts challenged space experiments selected from the general public taking advantage of the uniqueness of space environments.
- Examples: Physical exercises, Spin, Daily living skills, Flying carpet, Arm wrestling, etc.



## Space Poem Chain

- JAXA introduced “Renshi (Chain poetry)”
- Collaborative place through “linked verse” by thinking together about the universe, Earth, and life itself, unfettered by barriers of nation, culture, generation, profession, and position or rank.
- Among the contributors were poets from Asia and the Pacific region and also people in many countries around the world as well. This attempt and the created poems are quoted in an official schooltext in Japan.

*This year's ants are rushing through  
the shell of last year's snail, but  
look—there in the pond  
before us, legs slowly swaying,  
two wild ducks are taking a lazy swim*



Copyright(c)www.eso.org  
All Rights Reserved.

# JAXA Educational Opportunities



- Opportunities for participating in future missions
- JAXA Seeds in Space II/JAXA Spaceflight Kids Space Mission II
  - Planned to be conducted in year 2012 or later.
  - Detailed information on the announcement of opportunities will be posted on the following website (Japanese only): <http://edu.jaxa.jp/>
  - (Depending on regulations in each country some seeds cannot be imported or need complicated customs procedure.)
- Space Poem Chain
  - The composition of the Space Poem Chain Vol. 4 has begun with the first poem composed by astronaut Soichi Noguchi. The last invitation deadline is Feb. 21, 2011.
  - Anyone is eligible to submit their work to the Space Poem Chain. Please visit website below to read the poem chain in edition.
  - The Space Poem Chain is formed from alternating repetition of three lines and five lines poems. If the immediate preceding poem is five lines, then the next poem should be three lines.
  - Submissions must be in either Japanese or English.
  - On Fridays the latest poem will be announced and applications will be invited for the next poem. The due date for the next poem is the following Monday (Japan Standard Time).
  - Please refer to the following website for more information: <http://www7.jsforum.or.jp/>

# International Space Educators Board (ISEB)

- Founding members include NASA, ESA, JAXA, CSA
- Other agencies and non-agency partners involved in space-related educational pursuits may also be members
  - CNES
  - Victorian Space Science Education Center (VSSEC, Australia)
- To share best practices and unite efforts to foster interest in space, science and technology among the student community worldwide
- 2011 Chair is Mr. Leland D. Melvin, Associate Administrator for Education, NASA

