

# Rocket Activity

## Water Rocket Launcher

### Objectives

Construct a launch platform for launching water rockets.

### Description

Water rockets, built from plastic soft drink bottles, are capable of flights greater than 100 m. The bottles are partially filled with water and pressurized with compressed air delivered by a hand bicycle pump or small compressor. A special launch pad is required for holding the rocket while it is being pressurized. When the desired pressure is reached, the rocket is launched by releasing hold-down clamps. The instructions that follow explain how to construct the launcher and provides a list of needed materials. Only a few tools and simple construction techniques are required to construct a launch pad that can be used year after year.

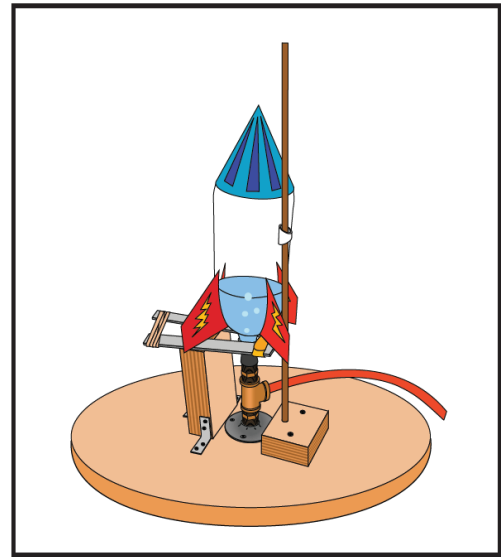

### National Science Content Standards

#### Physical Science

- Position and motion of objects
- Motions and forces

#### Science and Technology

- Abilities of technological design

### National Mathematics Content Standards

- Measurement

### National Mathematics Process Standards

- Connections

### Management

Most of the materials on the shopping list are obtained from a hardware/lumber store. If needed, the list can be given to a salesperson to assist in locating the needed parts. The list includes sizes, descriptions, and the number of each part required.

A scrap piece of 2 x 4 may be available at the lumber store. You will need two short pieces, 6 in. and 3 in. long. The short piece should have pilot holes drilled for the screws that will attach the block to the launcher base. The block supports a launch rod that guides the rocket during the first few moments of the liftoff. The other block should have pilot holes for attaching the corner irons to mount the block to the base and for supporting the hold-down clamps.

### Materials

- Refer to the shopping list (see page 91)
- Saw
- Drill
- Screw driver
- Bicycle pump or small electric compressor

Although not required, it is recommended that the wooden parts are painted or varnished. These parts will be blasted with water each time a rocket is launched, and finishing the wood will reduce potential warping.

## Assembly Instructions

1. Screw the galvanized floor flange (part #7) to the center of the launcher base.
2. Slide one end of the air hose (part #13) into the center hole of the pipe tee (part #9). The hose should be bent so that it extends about 7 cm out the top hole of the tee. It will take a little force to make the bend.
3. Thread the brass nipples (part #8) into each end of the tee. The hose will extend through the top nipple.
4. Jam the barb splicer (part #10) into the end of the hose that you pushed through the tee and nipple. Push the other end of the barb into the hole of the stopper (part #12). The wide end of the stopper should be nearest the nipple. Pull on the hose until the stopper just rests on the tee. Thread the lower nipple into the flange.
5. Stand the 6 in. 2 x 4 block (part #3) next to the flange. Mark screw holes for three corner braces (part #6). The braces will hold the block in place. One brace goes on each side and one on the side of the block opposite the flange. Drill pilot holes into the base and the block. Screw the block to the base.

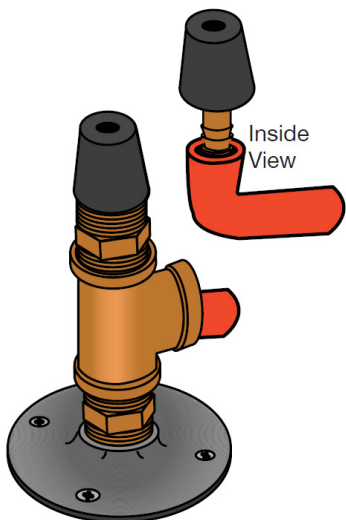

6. Drill two pilot holes into the small block (part #2), laid on its side. The holes should go straight through. Place the block next to the flange opposite the first block. Screw it in place.
7. Push an empty soft drink bottle on to the stopper for alignment of the other parts to be added.
8. Drill a hole in the small block large enough to accept the launch rod (part #4). The hole should be positioned so that the rod will just rest against the side of the bottle.
9. Align the two 8 in. mending plates (part #11) with the bottle lip (just above the cap threads - the bottle is upside down). You will probably have to adjust the height of the stopper. When launching, the bottle neck (rocket nozzle) will have to make a tight seal with the stopper. The mending plates (hold down clamps) press and hold the bottle on the stopper while air is being pumped in. Turn one or both of the nipples to raise or lower the stopper and the bottle to match the clamps with the bottle lip. (The two plates are like vice jaws that pivot sideways against the bottle neck just above the lip.)

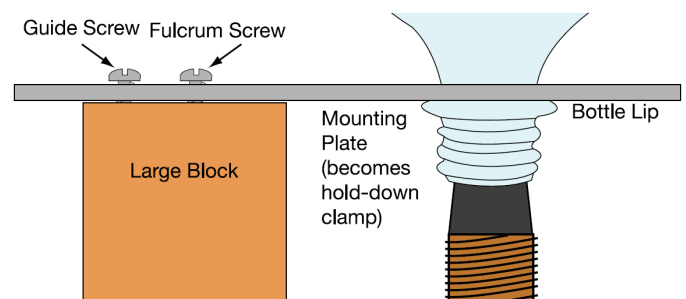

Screws inserted into the second hole (from the back) of each plate serve as fulcrums. The plates pivot inward to grab the bottle. (When the plates are pivoted outward, they release it.) When you are satisfied that the plates will get a good grip on the bottle, mark the positions of the second holes and screw the plates to the upper end of the large block. Screw them in just enough to keep the plates from rocking but not so tight as enough to prevent them from swinging from side to side.

10. Install two guide screws about 3/4 in. apart. The guide screws ensure that both plates open fully and release the bottle. Refer to the diagram to see the positioning of the plates on the 6 in. block.

11. Wrap several rubber bands around the short ends of the clamps. You will have to experiment a bit to get the right tension in the bands to pull the clamps apart for the launch.

12. Thread the hook and loop cable tie (part #14) through the end screw hole of one of the two mounting plates. This permanently attaches the tie to the plate. Tie the launch string to the other end of the tie. The string should be about 4 m long.

13. Connect the bicycle pump or compressor hose to the air hose. Depending upon the kind of pump you have, you may have to obtain a connector to fit the pump. One approach is to install a second barb splicer into the other end of the launcher's air hose. Cut the pump hose and push the barb into it to make the connection. Use small hose clamps to secure the barb to the hose. Other kinds of connectors are available, and some experimentation may be necessary. (One approach is to take the launcher and your pump to the hardware store and ask for recommendations.)

**Top Down View of Hold-Down Clamps**

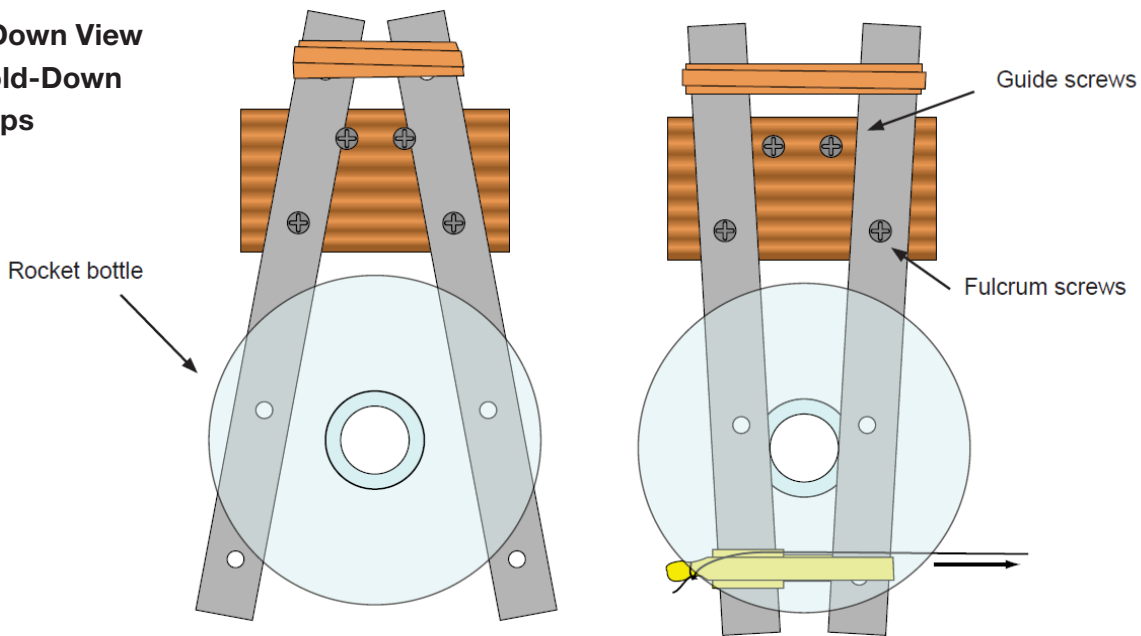

## Placing the hold-down clamps (8 in. mending plates)

The diagram above shows the position of a rocket bottle. The clamps are screwed into the block and are free to swing side-to-side. The guide screws ensure that both clamps open at the same time (not just one opening wide and the other one staying put). When ready for launch, the clamps are swung to the middle to grab on to the bottle neck just above the lip. The diagram to the right shows the hook and loop cable tie wrapped around the clamps. When the string is pulled, the tie is peeled off, and the clamps are released. The rubber bands on the other end of the clamps pull them apart, and the rocket lifts off.







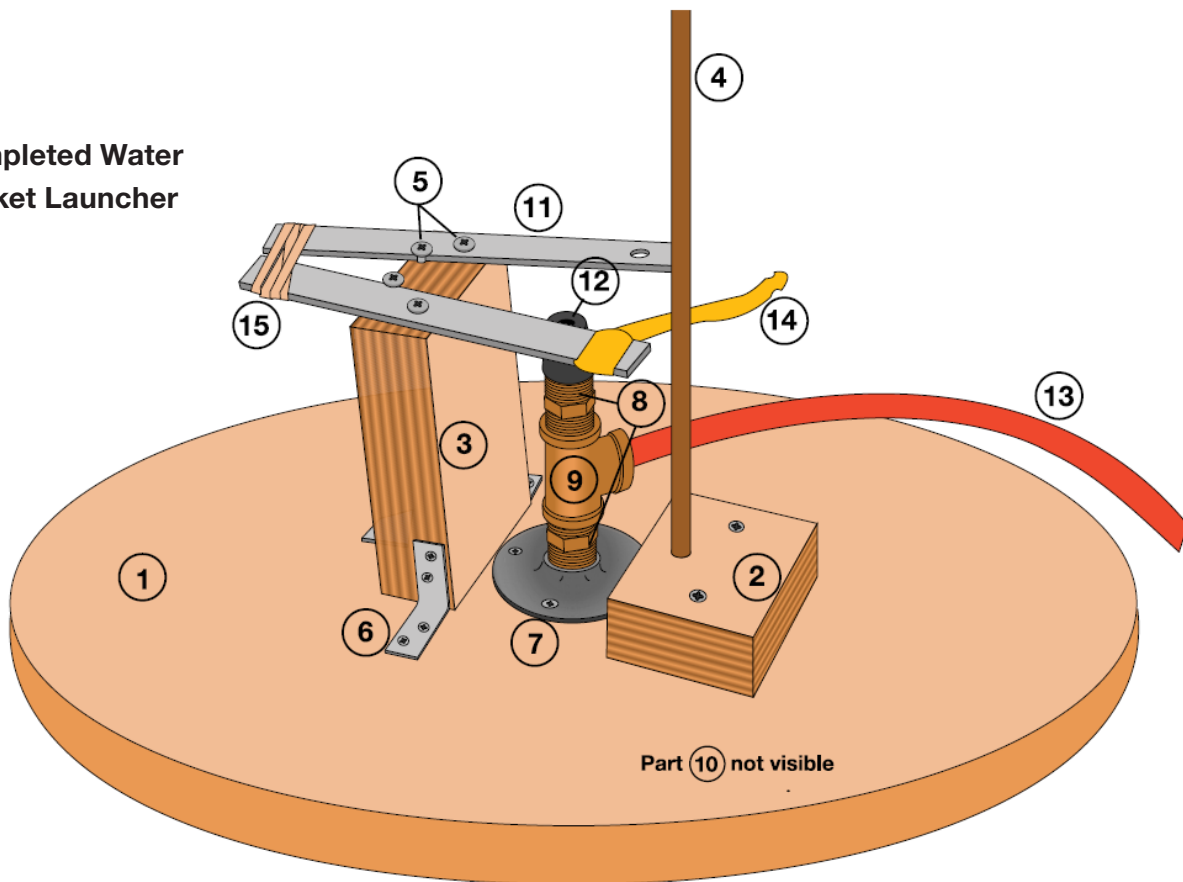

## Tips on Using the Launcher

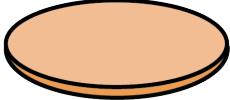
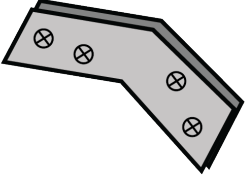
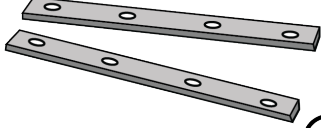
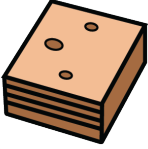
- It is important to keep the bottle sealed with the stopper as it is being pressurized. If the bottle leaks (a small spray comes out as it is being pressurized), the seal is too loose. Raise the stopper by unscrewing one or both of the nipples a turn or two to elevate the stopper.
- New plastic (PET) soft drink bottles are capable of withstanding about 100 or more pounds per square inch (psi) of pressure. A 2 to 1 safety factor is recommended. Do not let students pump the bottle above 50 psi. Bottles can be damaged during the construction process. Also bottles can be damaged on landing. Retire water rockets after 10 flights or sooner if you suspect damage.
- To place a rocket with water inside on the base, hold the rocket horizontally. Tip up the base and push the nozzle onto the stopper. Grasp the bottle with the clamps and hold them in position with the cable wrap. Set the rocket and launch platform level. It is not necessary to anchor the pad on the ground.
- A small pull on the string attached to the cable wrap is enough to peel it back and release the hold-down clamps.
- Students near the launcher should wear eye protection while the rocket is being pressurized and launched.
- Keep other students about 5 to 10 m from the launcher (further if you elect to use higher launch pressures).
- Do not let students attempt to catch their rockets unless the rocket has successfully deployed its parachute.

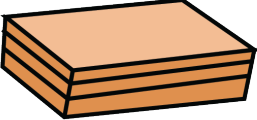
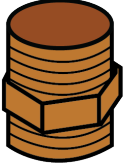
**Completed Water Rocket Launcher**

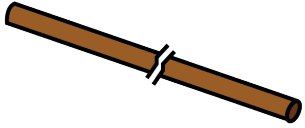

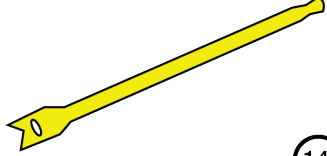
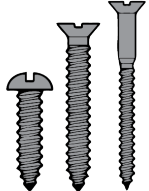
# Shopping List

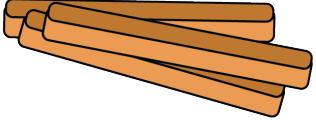
<p><b>1 - Wooden Base</b> (Circle 16 in. diameter or 16 in. square 16 in., plywood or joined lumber, 3/4 in. to 1 1/2 in. thick) Lumber Supply.</p>  <p>1.</p>	<p><b>3 - 1 1/2 in. x 5/8 in. Corner Brace</b> Hardware store.</p>  <p>6.</p>	<p><b>2 - 8 in. Mending Plate with screws</b> Hardware store.</p>  <p>11.</p>
<p><b>1 - 3 in. Wood Block (cut from 2 x 4)</b> Lumber Supply.</p>  <p>Drill pilot screw holes and hole for the dowel (launch rod).</p> <p>2.</p>	<p><b>1 - 1/2 in. Galv FLR Flange with screws</b> Hardware store.</p>  <p>7.</p>	<p><b>1 - Number 3, 1 hole Rubber Stopper</b> School science supply, Some hardware stores.</p>  <p>12.</p>
<p><b>1 - 6 in. Wood Block (cut from 2 x 4)</b> Lumber Supply.</p>  <p>3.</p>	<p><b>2 - 1/2 in. MIP Hex Nipple (Brass)</b> Hardware store.</p>  <p>8.</p>	<p><b>6 - 10' - 1/2 in. O.D. 1/4 in. I.D. High Pressure Air Hose</b> (with connector for bicycle pump/compressor) Hardware Store.</p>  <p>13.</p>
<p><b>1 - 5/16 in. Dowel (36 in. long)</b> Lumber Supply.</p>  <p>4.</p>	<p><b>1 - 1/2 in. Cast Female Pipe Tee (brass)</b> Hardware store.</p>  <p>9.</p>	<p><b>Hook and Loop Cable Tie</b> (e.g., Velcro® One Wrap) Office or Hardware store.</p>  <p>14.</p>
<p><b>4 - #12 pan head metal screws</b> <b>4 - #10 x 3/4 in. wood screws</b> <b>2 - #10 x 2 1/2 in. wood screws</b> Hardware store.</p>  <p>5.</p>	<p><b>1 - 1/4 in. I.D. Barb Splicer (brass)</b></p>  <p>10.</p>	<p><b>#64 Rubber Bands</b> Office Store.</p>  <p>15.</p>