



National Aeronautics and  
Space Administration

Educational Product

Teachers

Grades 5-12

# MICROGRAVITY

A Teacher's Guide With Activities in Science, Mathematics, and Technology

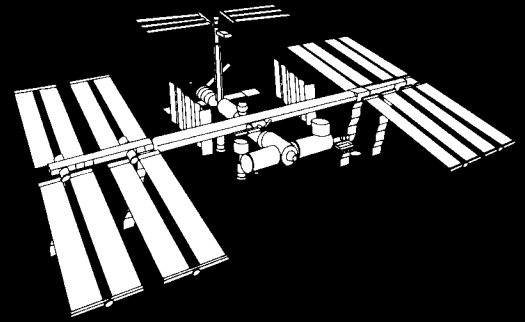

$$F = G \frac{m_1 m_2}{r^2}$$

# Microgravity

**A Teacher's Guide With Activities  
in Science, Mathematics, and Technology**

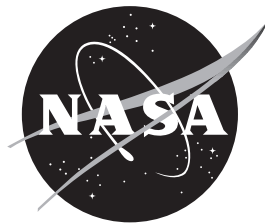

**National Aeronautics and Space Administration**

**Office of Life and Microgravity Sciences and Applications  
Microgravity Research Division**

**Office of Human Resources and Education  
Education Division**

This publication is in the Public Domain and is not protected by copyright.  
Permission is not required for duplication.

EG-1997-08-110-HQ

---

## **Acknowledgements**

This publication was developed for the National Aeronautics and Space Administration with the assistance of the many educators of the Aerospace Education Services Program, Oklahoma State University.

Writers:

**Melissa J. B. Rogers, MS**

TAL-CUT Company  
NASA Lewis Research Center  
Cleveland, OH

**Gregory L. Vogt, Ed-D.**

Teaching From Space Program  
NASA Johnson Space Center  
Houston, TX

**Michael J. Wargo, Sc.D.**

Microgravity Research Division  
NASA Headquarters  
Washington, DC

---

## Activity Contributors

**Microgravity In The Classroom  
Accelerometers  
Around The World  
Inertial Balance  
Candle Drop**

**Crystallization Model**  
Gregory L. Vogt, Ed.D.  
Teaching From Space Program  
NASA Johnson Space Center

**Gravity-Driven Fluid Flow**  
Charles E. Bugg, Ph.D. Professor Emeritus  
University of Alabama, Birmingham  
and  
Chairman and Chief Executive Officer  
Biocrypt Pharmaceuticals, Inc.

Craig D. Smith, Ph.D.  
Manager  
X-Ray Crystallography Laboratory  
Center for Macromolecular  
Crystallography  
University of Alabama at Birmingham

**Surface Tension-Driven Flows**  
Gregory L. Vogt, Ed.D.  
Teaching From Space Program  
NASA Johnson Space Center

R. Glynn Holt, Ph.D.  
Research Assistant Professor  
Boston University  
Aeronautics and Mechanical Engineering  
Department

**Temperature Effects on Surface  
Tension**  
Michael F. Schatz  
School of Physics  
Georgia Institute of Technology

Stephen J. VanHook  
Center for Nonlinear Dynamics  
Department of Physics  
University of Texas at Austin

**Candle Flames**  
Howard D. Ross, Ph.D.  
Chief  
Microgravity Combustion Branch  
NASA Lewis Research Center

**Crystal Growth and Buoyancy-Driven  
Convection Currents**  
Roger L. Kroes, Ph.D.  
Researcher  
Microgravity Science Division  
NASA Marshall Space Flight Center

Donald A. Reiss, Ph.D.  
Researcher  
Microgravity Science Division  
NASA Marshall Space Flight Center

**Rapid Crystallization  
Microscopic Observation of Crystals**  
David Mathiesen, Ph.D.  
Assistant Professor  
Case Western Reserve University  
and  
Alternate Payload Specialist  
USML-2 Mission

**Zeolite Crystal Growth**  
Albert Sacco, Jr.  
Head  
Department of Chemical Engineering  
Worcester Polytechnical Institute  
and  
Payload Specialist  
USML-2 Mission

# How To Use This Guide

As opportunities for extended space flight have become available, microgravity research in physical and biological sciences has grown in importance. Using the Space Shuttle and soon the International Space Station, scientists are able to add long term control of gravity's effects to the short list of variables they are to manipulate in their experiments. Although most people are aware of the floating effects of astronauts and things in orbiting spacecraft, few understand what causes microgravity much less how it can be utilized for research.

The purpose of this curriculum supplement guide is to define and explain microgravity and show how microgravity can help us learn about the phenomena of our world. The front section of the guide is designed to provide teachers of science, mathematics, and technology at many levels with a foundation in microgravity science and applications. It begins with background information for the teacher on what microgravity is and how it is created. This is followed with information on the domains of microgravity science research; biotechnology, combustion science, fluid physics, fundamental physics, materials science, and microgravity research geared toward exploration. The background section concludes with a history of microgravity research and the expectations microgravity scientists have for research on the International Space Station.

Following the background information are classroom activities that enable students to experiment with the forces and processes microgravity scientists are investigating today. The activities employ simple and inexpensive materials and apparatus that are widely available in schools. The activities emphasize hands-on involvement, prediction, data collection and interpretation, teamwork, and problem solving. Activity features include objectives, materials and tools lists, management suggestions, assessment ideas, extensions, instructions and illustrations, student work sheets, and student readers. Because many of the activities and demonstrations apply to more than one subject area, a matrix chart relates activities to national standards in science and mathematics and to science process skills.

Finally, the guide concludes with a suggested reading list, NASA educational resources including electronic resources, and an evaluation questionnaire. We would appreciate your assistance in improving this guide in future editions by completing the questionnaire and making suggestions for changes and additions. The evaluation can be sent to us by mail or electronically submitted through the Internet site listed on the form.



# Note on Measurement and Format

In developing this guide, metric units of measurement were employed. In a few exceptions, notably within the “Materials and Tools” lists, British units have been listed. In the United States, metric-sized parts such as screws and wood stock are not as accessible as their British equivalents. Therefore, British units have been used to facilitate obtaining required materials.

The main text of this guide uses large print located in a wide column. Subjects relating to mathematics, physical science, and technology are highlighted in bold. Definitions, questions for discussion, and examples are provided in smaller print in the narrow column of each page. Each area highlighted in the text has a corresponding section in the narrow column. This corresponding section first lists applicable Mathematics and Science Content Standards, indicated by grade level:  $\Delta$  Grades 5–8,  $\square$  Grades 9–12. We have attempted to position the appropriate discussion as close as possible to the relevant highlighted text. A key word or phrase in each margin discussion is also highlighted for ease in identifying related text.



# Table of Contents

Introduction	
First, What is Gravity? .....	1
What is Microgravity? .....	1
Creating Microgravity .....	3
Drop Facilities .....	7
Aircraft .....	8
Rockets .....	9
Orbiting Spacecraft .....	10
Microgravity Science Primer .....	13
The Microgravity Environment of Orbiting Spacecraft .....	15
Biotechnology .....	16
Protein Crystal Growth .....	18
Mammalian Cell and Tissue Culture .....	19
Fundamental Biotechnology .....	21
Combustion Science .....	21
Premixed Gas Flames .....	25
Gaseous Diffusion Flames .....	25
Liquid Fuel Droplets and Sprays .....	25
Fuel Particles and Dust Clouds .....	26
Flame Spread Along Surfaces .....	26
Smoldering Combustion .....	27
Combustion Synthesis .....	27
Fluid Physics .....	28
Complex Fluids .....	29
Multiphase Flow and Heat Transfer .....	31
Interfacial Phenomena .....	32
Dynamics and Stability .....	33
Fundamental Physics .....	34
Materials Science .....	37
Electronic Materials .....	39
Glasses and Ceramics .....	40
Metals and Alloys .....	41
Polymers .....	43
Microgravity Research and Exploration .....	44



Microgravity Science Space Flights .....	46
International Microgravity Laboratory-1, January 1992 .....	49
United States Microgravity Laboratory-1, June 1992 .....	49
Spacelab-J, September 1992 .....	51
United States Microgravity Payload-1, October 1992 .....	52
United States Microgravity Payload-2, March 1994 .....	53
International Microgravity Laboratory-2, July 1994 .....	55
United States Microgravity Laboratory-2, October 1995 .....	57
United States Microgravity Payload-3, February 1996 .....	59
Life and Microgravity Spacelab, June 1996 .....	62
Shuttle/Mir Science Program, March 1995 to May 1998 .....	64
 Future Directions .....	 68
 Glossary .....	 71
 Activities .....	 75
 NASA Resources for Educators .....	 167
 NASA Educational Materials .....	 168





# Introduction

Space flight is important for many reasons. Space flight carries scientific instruments and human researchers high above the ground, permitting us to see Earth as a planet and to study the complex interactions of atmosphere, oceans, land, energy, and living things. Space flight lifts scientific instruments above the filtering effects of the atmosphere, making the entire **electromagnetic spectrum** available and allowing us to see more clearly the distant planets, stars, and galaxies. Space flight permits us to travel directly to other worlds to see them close up and sample their compositions. Finally, space flight allows scientists to investigate the fundamental states of matter—solids, liquids, and gases—and the **forces** that affect them in a microgravity environment.

The study of the states of matter and their interactions in microgravity is an exciting opportunity to expand the frontiers of science. Areas of investigation include biotechnology, combustion science, fluid physics, fundamental physics, materials science, and ways in which these areas of research can be used to advance efforts to explore the Moon and Mars.

Microgravity is the subject of this teacher's guide. This publication identifies the underlying mathematics, physics, and technology principles that apply to microgravity. Supplementary information is included in other NASA educational products.

## First, What is Gravity?

Gravitational attraction is a fundamental property of matter that exists throughout the known universe. Physicists identify gravity as one of the four types of forces in the universe. The others are the strong and weak nuclear forces and the electromagnetic force.

### Mathematics Standards

- Mathematical Connections
- Mathematics as Communication
- Δ  Number and Number Relationships
- Δ  Number Systems and Number Theory

### Science Standards

- Δ  Physical Science
- Δ  Unifying Concepts and Processes

The **electromagnetic spectrum** is generally separated into different radiation categories defined by frequency (units of Hertz) or wavelength (units of meters). Wavelength is commonly represented by the symbol  $\lambda$ .

Example:

Name	Approximate Wavelength (m)
Xrays	$= 10^{-15}$ to $10^{-9}$
Ultraviolet	$= 10^{-8}$ to $10^{-7}$
Visible Light	$= 10^{-7}$ to $10^{-6}$
Infrared	$= 10^{-6}$ to $10^{-3}$
Microwave	$= 10^{-3}$ to $10^{-1}$
Television	$= 10^{-1}$ to 1
AM Radio	$= 10^{-2}$ to $10^3$

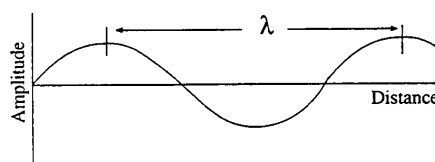

### Mathematics Standards

- Δ  Algebra
- Conceptual Underpinnings of Calculus
- Geometry
- Geometry from an Algebraic Perspective
- Δ  Mathematical Connections
- Δ  Mathematics as Reasoning
- Trigonometry

### Science Standards

- Δ  Physical Science
- Δ  Unifying Concepts and Processes

An impressed **force** is an action exerted upon a body, in order to change its state, either of rest, or of uni-



form motion in a straight line. A body force acts on the entire mass as a result of an external effect not due to direct contact; gravity is a body force. A surface force is a contact force that acts across an internal or external surface of a body.

#### Mathematics Standards

- Δ  Algebra
- Conceptual Underpinnings of Calculus
- Δ  Geometry
- Geometry from an Algebraic Perspective
- Δ  Mathematical Connections
- Δ  Mathematics as Reasoning
- Trigonometry

#### Science Standards

- Δ  Physical Science
- Δ  Unifying Concepts and Processes

**Velocity** is the rate at which the position of an object changes with time; it is a vector quantity. Speed is the magnitude of velocity.

#### Mathematics Standards

- Δ  Mathematical Connections
- Δ  Mathematics as Reasoning

#### Science Standards

- Δ  History and Nature of Science
- Δ  Science as Inquiry
- Δ  Unifying Concepts and Processes

Newton's discovery of the universal nature of the **force of gravity** was remarkable. To take the familiar force that makes an apple fall to Earth and be able to recognize it as the same force that keeps the planets on their quiet and predictable paths represents one of the major achievements of human intellectual endeavor. This ability to see beyond the obvious and familiar is the mark of a true visionary. Sir Issac Newton's pioneering work epitomizes this quality.

#### Mathematics Standards

- Δ  Algebra
- Δ  Computation and Estimation
- Functions
- Δ  Mathematical as Communication
- Δ  Number and Number Relationships
- Δ  Patterns and Functions

#### Science Standards

- Δ  Unifying Concepts and Processes

More than 300 years ago the great English scientist Sir Isaac Newton published the important generalization that mathematically describes this universal force of gravity. Newton was the first to realize that gravity extends well beyond the domain of Earth. The basis of this realization stems from the first of three laws he formulated to describe the motion of objects. Part of Newton's first law, the law of inertia, states that objects in motion travel in a straight line at a constant **velocity** unless acted upon by a net force. According to this law, the planets in space should travel in straight lines. However, as early as the time of Aristotle, scholars knew that the planets travelled on curved paths. Newton reasoned that the closed orbits of the planets are the result of a net force acting upon each of them. That force, he concluded, **is the same force that causes an apple to fall to the ground—gravity.**

Newton's experimental research into the force of gravity resulted in his elegant mathematical statement that is known today as the Law of Universal Gravitation. According to Newton, every mass in the universe attracts every other mass. The attractive force between any two objects is **directly proportional** to the product of the two masses being considered and inversely proportional to the square of the distance separating them. If we let  $F$  represent this force,  $r$  represent the distance between the centers of the masses, and  $m_1$  and  $m_2$  represent the magnitudes of the masses, the relationship stated can be written symbolically as:

$$F \propto \frac{m_1 m_2}{r^2}$$

From this relationship, we can see that the greater the masses of the attracting objects, the greater the force of attraction between them. We can also see that the farther apart the objects are from each other, the less the attraction. If the distance between the objects doubles, the attraction between them diminishes by a factor of four, and if the distance triples, the attraction is only one-ninth as much.



The eighteenth-century English physicist Henry Cavendish later quantified Newton's Law of Universal Gravitation. He actually measured the gravitational force between two **one kilogram masses** separated by a distance of one meter. This attraction was an extremely weak force, but its determination permitted the proportional relationship of Newton's law to be converted into an equality. This measurement yielded the universal gravitational constant,  $G$ . Cavendish determined that the value of  $G$  is  $6.67 \times 10^{-11} \text{ N m}^2/\text{kg}^2$ . With  $G$  added to make the equation, the Law of Universal Gravitation becomes:

$$F = G \frac{m_1 m_2}{r^2}$$

## What is Microgravity?

The presence of Earth creates a gravitational field that acts to attract objects with a force inversely proportional to the square of the distance between the center of the object and the center of Earth. When we measure the acceleration of an object acted upon only by Earth's gravity at the Earth's surface, we commonly refer to it as one  $g$  or one Earth gravity. This acceleration is approximately 9.8 meters per second squared ( $\text{m/s}^2$ ). The mass of an object describes how much the object accelerates under a given force. The weight of an object is the gravitational force exerted on it by Earth. In British units (commonly used in the United States), force is given in units of pounds. The British unit of mass corresponding to one pound force is the slug.

While the mass of an object is constant and the weight of an object is constant (ignoring differences in  $g$  at different locations on the Earth's surface), the environment of an object may be changed in such a way that its apparent weight changes. Imagine standing on a scale in a stationary elevator car. Any vertical accelerations of the elevator are considered to be positive

$F \propto \frac{m_1 m_2}{r^2}$  indicates **proportionality**

$F = G \frac{m_1 m_2}{r^2}$  indicates equality

$G \frac{m_1 m_2}{r^2}$  is an expression

$F = G \frac{m_1 m_2}{r^2}$  is an equation

### Mathematics Standards

- $\Delta$   Algebra
- $\Delta$   Mathematical Connections
- $\Delta$   Mathematics as Communication
- $\Delta$   Measurement

### Science Standards

- $\Delta$   Science and Technology
- $\Delta$   Science as Inquiry
- $\Delta$   Unifying Concepts and Processes

The internationally recognized Systeme International (SI) is a system of measurement units. The SI units for length (meter) and **mass (kg)** are taken from the metric system. Many dictionaries and mathematics and science textbooks provide conversion tables between the metric system and other systems of measurement. Units conversion is very important in all areas of life, for example in currency exchange, airplane navigation, and scientific research.

#### Units Conversion Examples

1 kg  $\cong$  2.2lb      1 in = 2.54cm  
 1 liter  $\cong$  1 qt      1 yd  $\cong$  0.9 m

#### Questions for Discussion

- What common objects have a mass of about 1 kg?
- What are the dimensions of this sheet of paper in cm and inches?
- How many liters are there in a gallon?

### Mathematics Standards

- $\Delta$   Computation and Estimation
- $\Delta$   Mathematics as Communication
- $\Delta$   Number and Number Relationships
- $\Delta$   Number Systems and Number Theory



## Science Standards

- Δ  Science as Inquiry
- Δ  Science in Personal and Social Perspectives
- Δ  Unifying Concepts and Processes

**Scientific notation** makes it easier to read, write, and manipulate numbers with many digits. This is especially useful for making quick estimates and for indicating the number of significant figures.

*Examples:*

$$\begin{aligned}0.001 &= 10^{-3} \\ 10 &= 10^1 \\ 1000 &= 10^3\end{aligned}$$

Which is bigger,  $6 \times 10^{-3}$  or  $8 \times 10^{-4}$ ?  $6 \times 10^3$  or  $8 \times 10^4$ ?  
How much bigger?

## Mathematics Standards

- Δ  Mathematical Connections
- Δ  Mathematics as Reasoning

## Science Standards

- Δ  Science and Technology
- Δ  Science as Inquiry
- Δ  Unifying Concepts and Processes

*Questions for Discussion*

- How does a **scale** work ?
- What does a scale measure?
- How many different kinds of scales can you list?
- Do they need gravity for them to work?
- Would you get different results on the Moon or Mars?
- How can you measure the mass of an object in microgravity?

upwards. Your weight, **W**, is determined by your mass and the acceleration due to gravity at your location.

If you begin a ride to the top floor of a building, an additional force comes into play due to the acceleration of the elevator. The force that the floor exerts on you is your apparent weight, **P**, the magnitude of which the **scale** will register. The total force acting on you is  $\mathbf{F}=\mathbf{W}+\mathbf{P}=m\mathbf{a}_e$ , where  $\mathbf{a}_e$  is the acceleration of you and the elevator and  $\mathbf{W}=m\mathbf{g}$ . Two example calculations of apparent weight are given in the margin of the next page. Note that if the elevator is not accelerating then the magnitudes **W** and **P** are equal but the direction in which those forces act are opposite ( $\mathbf{W}=-\mathbf{P}$ ). Remember that the sign (positive or negative) associated with a vector quantity, such as force, is an indication of the direction in which the vector acts or points, with respect to a defined frame of reference. For the reference frame defined above, your weight in the example in the margin is negative because it is the result of an acceleration (gravity) directed downwards (towards Earth).

Imagine now riding in the elevator to the top floor of a very tall building. At the top, the cables supporting the car break, causing the car and you to fall towards the ground. In this example, we discount the effects of air friction and elevator safety mechanisms on the falling car. Your apparent weight  $\mathbf{P}=m(\mathbf{a}_e-\mathbf{g})=(60\text{ kg})(-9.8\text{ m/s}^2-(-9.8\text{ m/s}^2))=0\text{ kg m/s}^2$ ; you are weightless. The elevator car, the scale, and you would all be accelerating downward at the same rate, which is due to gravity alone. If you lifted your feet off the elevator floor, you would float inside the car. This is the same experiment that Galileo is purported to have performed at Pisa, Italy, when he dropped a cannonball and a musketball of different mass at the same time from the same height. Both balls hit the ground at the same time, just as the elevator car, the scale, and you would reach the ground at the same time.

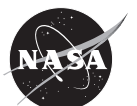

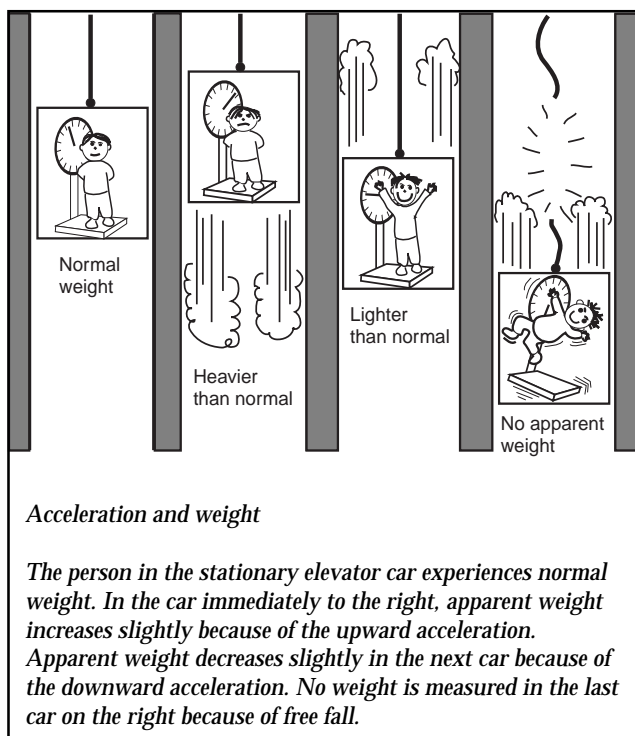

For reasons that are discussed later, there are many advantages to performing scientific experiments under conditions where the apparent weight of the experiment system is reduced. The name given to such a research environment is microgravity. The prefix micro- (m) derives from the original Greek mikros meaning small. By this definition, a **microgravity environment is one in which the apparent weight of a system is small compared to its actual weight due to gravity.** As we describe how microgravity environments can be produced, bear in mind that many factors contribute to the experienced accelerations and that the quality of the microgravity environment depends on the mechanism used to create it. In practice, the microgravity environments used by scientific researchers range from about one percent of Earth's gravitational acceleration (aboard aircraft in parabolic flight) to better than one part in a million (for example, onboard Earth-orbiting research satellites).

Quantitative systems of measurement, such as the metric system, commonly use **micro-** to mean one part in a million. Using that definition, the acceleration experienced by an object in a

### Mathematics Standards

- Δ  Algebra
- Δ  Computational and Estimation
- Δ  Conceptual Underpinnings of Calculus
- Δ  Mathematical Connections
- Δ  Mathematics as Problem Solving
- Δ  Measurement

### Science Standards

- Δ  Physical Science
- Δ  Science and Technology
- Δ  Science as Inquiry
- Δ  Unifying Concepts and Processes

$$F=W+P=ma_e$$

Rewriting yields  $P=ma_e - mg=m(a_e - g)$ .

If your mass is 60 kg and the elevator is accelerating upwards at  $1 \text{ m/s}^2$ , your apparent weight is

$$P=60 \text{ kg} (+1 \text{ m/s}^2 - (-9.8 \text{ m/s}^2)) = +648 \text{ kg m/s}^2$$

while your weight remains

$$W=mg=(60 \text{ kg})(-9.8 \text{ m/s}^2) = -588 \text{ kg m/s}^2.$$

If the elevator accelerates downwards at  $0.5 \text{ m/s}^2$ , your apparent weight is

$$P=60 \text{ kg} (-0.5 \text{ m/s}^2 - (-9.8 \text{ m/s}^2)) = +558 \text{ kg m/s}^2.$$

### Mathematics Standards

- Δ  Mathematics as Communications
- Δ  Mathematics as Reasoning

### Science Standards

- Δ  Science as Inquiry
- Δ  Science in Personal and Social Perspectives
- Δ  Unifying Concepts and Processes

$$1 \text{ micro-g or } 1 \mu\text{g} = 1 \times 10^{-6} \text{ g}$$

### Questions for Discussion

- What other common prefixes or abbreviations for powers of ten do you know or can you find?
- In what everyday places do you see these used?  
*Grocery stores, farms, laboratories, sporting facilities, pharmacies, machine shops.*

Common prefixes for powers of ten:

$10^{-9}$	nano-	n
$10^{-3}$	milli-	m
$10^2$	centi-	c
$10^3$	kilo-	k
$10^6$	mega-	M
$10^9$	giga-	G





## Mathematics Standards

- Δ  Algebra
- Δ  Computation and Estimation
  - Conceptual Underpinnings of Calculus
  - Discrete Mathematics
- Δ  Mathematical Connections
- Δ  Mathematics as Problem Solving
- Δ  Mathematics as Reasoning
- Δ  Number and Number Relationships

## Science Standards

- Δ  Unifying Concepts and Processes

Calculate the times in these **examples**. Teachers can use these examples at several different scholastic levels.

Provide the equation as:

$$t = \sqrt{\frac{2d}{a}} \text{ or } \left(\frac{2d}{a}\right)^{1/2}$$

Provide the equation as  $d=(1/2)at^2$ , and have the students re-order the equation.

Making measurements and calculating results involve the concepts of accuracy and precision, significant figures, and orders of magnitude. With these concepts in mind, are the drop times given in the text “correct”?

## Mathematics Standards

- Δ  Algebra
- Δ  Computation and Estimation
- Δ  Mathematical Connections
- Δ  Mathematics as Problem Solving
- Δ  Mathematics as Reasoning
- Δ  Measurement

## Science Standards

- Δ  Science and Technology
- Δ  Science as Inquiry
- Δ  Unifying Concepts and Processes

### Questions for Discussion

- **How far away is the Moon?**
- How far away is the center of Earth from the center of the Moon?
- Why did we ask the previous question?
- How far away is the surface of Earth from the surface of the Moon?
- What are the elevations of different features of Earth and the Moon?
- How are elevations measured?

microgravity environment would be one-millionth ( $10^{-6}$ ) of that experienced at Earth’s surface. The use of the term microgravity in this guide will correspond to the first definition. For illustrative purposes only, we provide the following simple example using the quantitative definition. This **example** attempts to provide insight into what might be expected if the local acceleration environment would be reduced by six orders of magnitude from 1 g to  $10^{-6}$  g,

If you dropped a rock from a roof that was **five meters** high, it would take just **one second** to reach the ground. In a reduced gravity environment with **one percent** of Earth’s gravitational pull, the same drop would take **10 seconds**. In a microgravity environment equal to **one-millionth** of Earth’s gravitational pull, the same drop would take **1,000 seconds** or about **17 minutes!**

Researchers can create microgravity conditions in two ways. Because gravitational pull diminishes with distance, one way to create a microgravity environment (following the quantitative definition) is to travel away from Earth. To reach a point where Earth’s gravitational pull is reduced to onemillionth of that at the surface, you would have to travel into space a distance of **6.37 million kilometers from Earth (almost 17 times farther away than the Moon, 1400 times the highway distance between New York City and Los Angeles, or about 70 million football fields)**. This approach is impractical, except for automated spacecraft, because humans have yet to travel farther away from Earth than the distance to the Moon. However, freefall can be used to create a microgravity environment consistent with our primary definition of microgravity. We discuss this in the next section.



# Creating Microgravity

As illustrated in the elevator examples in the previous section, the effects of gravity (apparent weight) can be removed quite easily by putting anything (a person, an object, an experiment) into a state of freefall. This possibility of using Earth's gravity to remove the effects of gravity within a system were not always evident. Albert Einstein once said, "I was sitting in a chair in the patent office at Bern when all of a sudden a thought occurred to me: 'If a person falls freely, he will not feel his own weight.' I was startled. This simple thought made a deep impression on me. It impelled me toward a theory of gravitation." Working with this knowledge, scientists involved in early space flights rapidly concluded that micro-gravity experiments could be performed by crew members while in orbit.

## *Gravity and Distance*

The inverse square relationship between gravitational force and distance can be used to determine the acceleration due to gravity at any distance from the center of Earth,  $r$ .

$$F = Gm_e m / r_e^2 \quad \text{force of gravity due to Earth on a mass, } m, \text{ at Earth's surface}$$

$$F = mg \rightarrow g = Gm_e / r_e^2$$
$$F = Gm_e m / r^2 \quad \text{force of gravity due to Earth on a mass, } m, \text{ at a distance, } r, \text{ from Earth's center}$$

$$F = ma \rightarrow a = Gm_e / r^2$$
$$gr_e^2 = ar^2$$
$$a = gr_e^2 / r^2 \quad \text{acceleration due to Earth's gravity at distance, } r, \text{ from Earth's center}$$

A typical altitude for a Space Shuttle Orbiter orbit is 296 km. The Earth's mean radius is  $6.37 \times 10^6$  m. The acceleration due to gravity at the Orbiter's altitude is

$$a = 9.8 \text{ m/s}^2 (6.37 \times 10^6 \text{ m})^2 / (6.67 \times 10^6 \text{ m})^2 = 8.9 \text{ m/s}^2$$

This is about 90% of the acceleration due to gravity at Earth's surface. Using the same equations, you can see that to achieve a microgravity environment of  $10^{-6}$  g by moving away from Earth, a research laboratory would have to be located  $6.37 \times 10^9$  m from the center of Earth.



## Mathematics Standards

- Δ  Algebra
- Δ  Computation and Estimation
  - Conceptual Underpinnings of Calculus
  - Discrete Mathematics
  - Functions
- Δ  Mathematical Connections
- Δ  Mathematics as Problem Solving
- Δ  Mathematics as Reasoning
- Δ  Patterns and Functions
- Δ  Statistics

## Science Standards

- Δ  Physical Science
- Δ  Science and Technology
- Δ  Science as Inquiry
- Δ  Science in Personal and Social Perspectives
- Δ  Unifying Concepts and Processes

### Questions for Discussion

- What is the functional relationship between acceleration, distance, and time?

Use the four sets of **drop facility data points** given in the text and the additional data set (0 meters, 0 seconds). What does the (0 meters, 0 seconds) data set represent? Why is it a valid data set to use?

*Suggested solution methods: Use different types of graph paper Use a computer e urvefitting r)rogram Do a dimensional analysis.*

- Knowing that  $g=9.8 \text{ m/s}^2$ , what equation can you write to incorporate acceleration, distance, and time?
- Assume it costs \$5,000 per meter of height to build a drop tower.

How much does it cost to build a drop tower to allow drops of 1 second, 2 seconds, 4 seconds, 10 seconds?

Why does it cost so much more for the longer times?

What would be an inexpensive way to double low-gravity time in a drop tower?

*Shoot the experiment package up from the bottom.*

The use of orbiting spacecraft is one method used by NASA to create microgravity conditions. In addition, four other methods of creating such conditions are introduced here and we give examples of situations where the student can experience microgravity.

## Drop Facilities

Researchers use high-tech facilities based on the elevator analogy to create micro-gravity conditions. The NASA Lewis Research Center has two drop facilities. One provides a **132 meter** drop into a hole in the ground similar to a mine shaft. This drop creates a reduced gravity environment for **5.2 seconds**. A tower at Lewis allows for 2.2 second drops down a **24 meter** structure. The NASA Marshall Space Flight Center has a different type of reduced gravity facility. This **100 meter** tube allows for drops of **4.5 second** duration. Other NASA Field Centers and other countries have additional drop facilities of varying sizes to serve different purposes. The longest drop time currently available (about **10 seconds**) is at a **490 meter** deep vertical mine shaft in Japan that has been converted to a drop facility. Sensations similar to those resulting from a drop in these reduced gravity facilities can be experienced on freefall rides in amusement parks or when stepping off of diving platforms.

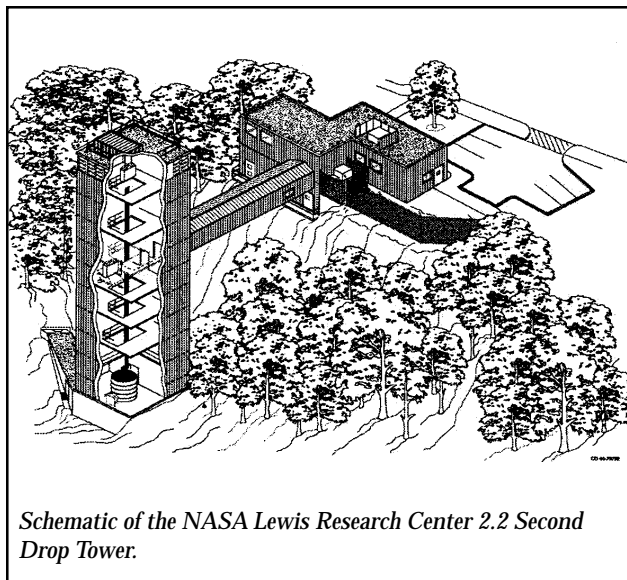



## Aircraft

Airplanes are used to achieve reduced gravity conditions for periods of about 15 seconds. This environment is created as the plane flies on a parabolic path. A typical flight lasts two to three hours allowing experiments and crew members to take advantage of about forty periods of microgravity. To accomplish this, the plane climbs rapidly at a 45 degree angle (this phase is called pull up), **traces a parabola** (pushover), and then descends at a 45 degree angle (pull out). During the pull up and pull out segments, crew and experiments experience accelerations of about 2 g. During the parabola, net accelerations drop as low as  $1.5 \times 10^{-2} g$  for about 15 seconds. Due to the experiences of many who have flown on parabolic aircraft, the planes are often referred to as "Vomit Comets." Reduced gravity conditions created by the same type of parabolic motion described above can be experienced on the series of "floater" hills that are usually located at the end of roller coaster rides and when driving over swells in the road.

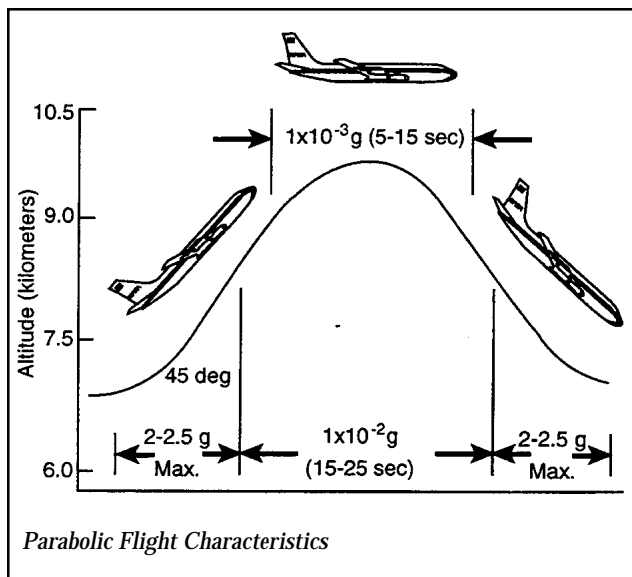

## Mathematics Standards

- Conceptual Underpinnings of Calculus
- Functions
- $\Delta$   Mathematical Connections
- $\Delta$  Patterns and Functions

## Science Standards

- $\Delta$   Earth and Space Science
- $\Delta$   Physical Science
- $\Delta$   Unifying Concepts and Processes

Microgravity carriers and other spacecraft follow paths best described by conic sections. The aircraft and sub-orbital rockets trace out **parabolas**. Orbiting spacecraft are free falling on elliptical paths. When a meteoroid is on a path that is influenced by Earth or any other planetary body but does not get captured by the gravitational field of the body, its motion, as it approaches then moves away from the body, traces out a hyperbolic path.

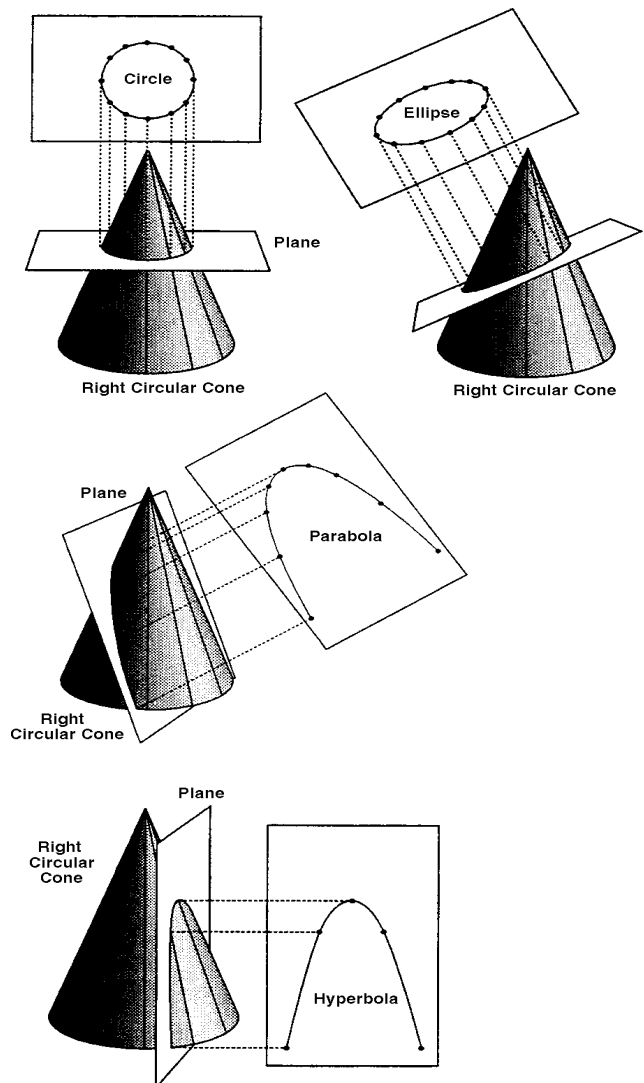

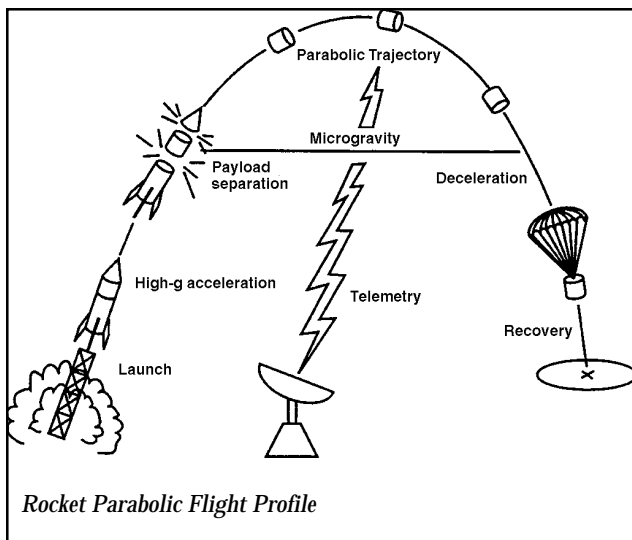

## Rockets

Sounding rockets are used to create reduced gravity conditions for several minutes; they follow suborbital, parabolic paths. Freefall exists during the rocket's coast: after burn out and before entering the atmosphere. Acceleration levels are usually around  $10^{-5}$  g. While most people do not get the opportunity to experience the accelerations of a rocket launch and subsequent freefall, springboard divers basically launch themselves into the air when performing dives and they experience microgravity conditions until they enter the water.

## Orbiting Spacecraft

Although drop facilities, airplanes, and rockets can establish a reduced gravity environment, all these facilities share a common problem. After a few seconds or minutes, Earth gets in the way and freefall stops. To conduct longer scientific investigations, another type of freefall is needed.

To see how it is possible to establish microgravity conditions for long periods of time, one must first understand what keeps a spacecraft in orbit. Ask any group of students or adults **what keeps satellites and Space Shuttles in orbit** and you will probably get a variety of answers. Two common answers are "The rocket engines keep firing to hold it up," and "There is no gravity in space."

Although the first answer is theoretically possible, the path followed by the spacecraft would technically not be an orbit. Other than the altitude involved and the specific means of exerting an upward force, little difference exists between a spacecraft with its engines constantly firing and an airplane flying around the world. A satellite could not carry enough fuel to maintain its altitude for more than a few minutes. The second answer is also wrong. At the altitude that the Space Shuttle typically orbits Earth, the gravitational pull on the Shuttle by Earth is about 90% of what it is at Earth's surface.

### Mathematics Standards

- Δ  Algebra
- Δ  Computation and Estimation
  - Conceptual Underpinnings of Calculus
  - Discrete Mathematics
  - Functions
- Δ  Mathematical Connections
- Δ  Mathematics as Problem Solving
- Δ  Mathematics as Reasoning
- Δ  Number and Number Relationships

### Science Standards

- Physical Science
- Δ  Science and Technology
  - Science as Inquiry
  - Unifying Concepts and Processes

### Questions for Discussion

- **How does the Shuttle stay in orbit?** Use the following two equations that describe the force acting on an object. The first equation represents the force of gravity acting on the Shuttle.

$$F_1 = G \frac{m_e m_s}{r^2}$$

Where:

- $F_1$  = Force of gravity acting on the Shuttle
- $G$  = Universal gravitational constant
- $m_e$  = Mass of Earth
- $m_s$  = Mass of the Shuttle
- $r$  = Distance from center of Earth to the Shuttle



In a previous section, we indicated that Issac Newton reasoned that the closed orbits of the planets through space were due to gravity's presence. Newton expanded on his conclusions about gravity and hypothesized how an artificial satellite could be made to orbit Earth. He envisioned a very tall mountain extending above Earth's atmosphere so that friction with the air would not be a factor. He then imagined a cannon at the top of that mountain firing cannonballs parallel to the ground. Two forces acted upon each cannonball as it was fired. One force, due to the explosion of the black powder, propelled the cannonball straight outward. If no other force were to act on the cannonball, the shot would travel in a straight line and at a constant velocity. But Newton knew that a second force would act on the cannonball: gravity would cause the path of the cannonball to bend into an arc ending at Earth's surface.

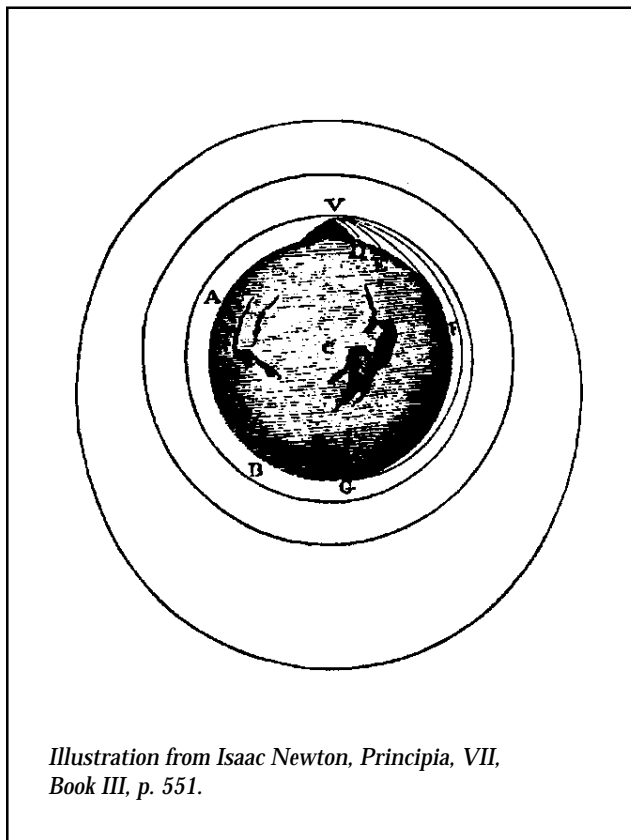

The second equation represents the force acting on the Shuttle that causes a centripetal acceleration,

$$\frac{v^2}{r}$$

This is an expression of Newton's second law,  $F=ma$ .

- $F_2$  = Force acting on the Shuttle that causes uniform circular motion (with centripetal acceleration)  
 $v$  = Velocity of the Shuttle

These two forces are equal:  $F_1=F_2$

$$G \frac{m_e m_s}{r^2} = \frac{m_s v^2}{r}$$

$$v^2 = \frac{Gm_e}{r}$$

$$v = \sqrt{\frac{Gm_e}{r}}$$

In order to stay in a circular orbit at a given distance from the center of Earth,  $r$ , the Shuttle must travel at a precise velocity,  $v$ .

- How does the Shuttle change its **altitude**? From a detailed equation relating the Shuttle velocity with the Shuttle altitude, one can obtain the following simple relationship for a circular orbit. Certain simplifying assumptions are made in developing this equation: 1) the radius of the Shuttle orbit is nearly the same as the radius of Earth, and 2) the total energy of the Shuttle in orbit is due to its kinetic energy,  $1/2 mv^2$ ; the change in potential energy associated with the launch is neglected.

$$\Delta r = \frac{\tau}{\pi} \Delta v$$

$\tau$  = orbital period. the time it takes the Shuttle to complete one revolution around Earth

$$= \frac{2 \pi r^{3/2}}{(Gm_e)^{1/2}}$$

$\Delta v$  = the change in Shuttle velocity

$\Delta r$  = the change in Shuttle altitude



For example:

Consider a Shuttle in a circular orbit at 160 nautical miles (296.3 km) altitude. Determine the new altitude caused by the Shuttle firing a thruster that increases its velocity by 1 m/s.

First, calculate the orbital period,  $X$ , from the above equation.

$$\begin{aligned}\tau &= \frac{2\pi(re+2.96 \times 10^5 \text{ m})^{3/2}}{(Gm_e)^{1/2}} \\ &= \frac{2\pi(6.37 \times 10^6 \text{ m} + 2.96 \times 10^5 \text{ m})^{3/2}}{(6.67 \times 10^{-11} \frac{\text{m}^3}{\text{s}^2 \text{kg}} \times 5.98 \times 10^{24} \text{ kg})^{1/2}} \\ &= 5.41 \times 10^3 \text{ s}\end{aligned}$$

Next, use the period and the applied velocity change to calculate the altitude change.

$$\begin{aligned}\Delta r &= \frac{\tau}{\pi} \Delta v \\ &= \frac{5.41 \times 10^3 \text{ s}}{\pi} (1 \text{ m/s}) \\ &= 1.72 \times 10^3 \text{ m}\end{aligned}$$

This altitude change is actually seen on the opposite side of the orbit. In order to make the orbit circular at the new altitude, the Shuttle needs to apply the same  $\Delta v$  at the other side of the orbit.

In the discussion and example just given, we state that the equations given are simple approximations of more complex relationships between Shuttle velocity and altitude. The more complex equations are used by the Shuttle guidance and navigation teams who track the Shuttles' flights. But the equations given here can be used for quick approximations of the types of thruster firings needed to achieve certain altitude changes. This is helpful when an experiment team may want to request an altitude change. Engineers supporting the experiment teams can determine approximately how much propellant would be required for such an altitude change and whether enough would be left for the required de-orbit burns. In this way, the engineers and experiment teams can see if their request is realistic and if it has any possibility of being implemented.

Newton considered how additional cannonballs would travel farther from the mountain each time the cannon fired using more black powder. With each shot, the path would lengthen and soon the cannonballs would disappear over the horizon. Eventually, if one fired a cannon with enough energy, the cannonball would fall entirely around Earth and come back to its starting point. The cannonball would be in orbit around Earth. Provided no force other than gravity interfered with the cannonball's motion, it would continue circling Earth in that orbit.

This is how the Space Shuttle stays in orbit. It launches on a path that arcs above Earth so that the Orbiter travels at the right speed to keep it falling while maintaining a constant altitude above the surface. For example, if the Shuttle climbs to a 320 kilometer high orbit, it must travel at a speed of about 27,740 kilometers per hour to achieve a stable orbit. **At that speed and altitude**, the Shuttle executes a falling path parallel to the curvature of Earth. Because the Space Shuttle is in a state of freefall around Earth and due to the extremely low friction of the upper atmosphere, the Shuttle and its contents are in a high-quality microgravity environment.



# Microgravity Science Primer

We experience many manifestations of gravity on a day to day basis. If we drop something, it falls toward Earth. If we release a rock in a container of water, the rock settles to the bottom of the container. We experience other effects of gravity regularly, although we may not think of gravity as playing a role.

Consider what happens when a container of water is **heated** from below. As the water on the bottom is heated by conduction through the container, it becomes less dense than the un-heated, cooler water. Because of gravity, the cooler, more dense water sinks to the bottom of the container and the heated water rises to the top due to buoyancy. A circulation pattern is produced that mixes the hot water with the colder water. This is an example of buoyancy driven (or gravity driven) convection. The convection causes the water to be heated more quickly and uniformly than if it were heated by conduction alone. This is the same density driven convection process to which we refer when we state matter-of-factly that "hot air rises."

In addition to mixing, **density** differences can also cause things to differentially settle through a process called sedimentation. In this process, the more dense components of mixtures of **immiscible** fluids or solid particles in fluids settle to the bottom of a container due to gravity. If you fill a bucket with very wet mud, and then leave the bucket sitting on the ground, over time the more dense soil particles will sink to the bottom of the bucket due to gravity, leaving a layer of water on top. When you pick up a bottle of Italian salad dressing from the grocery store shelf, you see several different layers in the bottle. The dense solids have settled to the bottom, the vinegar forms a middle layer, and the least dense oil is on top.

## Science Standards

- Δ  Physical Science
- Δ  Unifying Concepts and Processes

**Heat** transfer occurs through one of three processes or a combination of the three. Conduction is the flow of heat through a body from an area of higher temperature to an area of lower temperature. Molecules in the hot region increase their vibrational energy as they are heated. As they collide with molecules with lower vibrational energy (cooler ones), some of the vibrational energy is passed to the cooler ones, their energy is increased, and heat is passed on.

Heat transfer by convection is the movement of heat by motion of a fluid. This motion can be the result of some force, such as a pump circulating heated water, and is referred to as forced convection. If the motion is the result of differences in density (thermal or compositional), the convection is referred to as buoyancy-driven, density-driven, or natural convection.

Radiation is the emission of energy from the surface of a body. Energy is emitted in the form of electromagnetic waves or photons (packets of light). The character (wavelength, energy of photons, etc.) of the radiation depends on the temperature, surface area, and characteristics of the body emitting the energy. Electromagnetic waves travel with the speed of light through empty space and are absorbed (and/or reflected) by objects they fall on, thus transferring heat. An excellent example of radiative heating is the sun's heat that we experience on Earth.

## Mathematics Standards

- Δ  Mathematical Connections

## Science Standards

- Δ  Earth and Space Science
- Δ  Physical Science
- Δ  Unifying Concepts and Processes

The mass of a body divided by its volume is its average **density**.

## Science Standards

- Δ  Physical Science
- Δ  Unifying Concepts and Processes

When two or more liquids are **immiscible** they do not mix chemically.



<i>Density Table</i>	<i>Units (kg/m<sup>3</sup>)</i>
Interstellar space	10 <sup>-21</sup> - 10 <sup>-18</sup>
Atmosphere at normal altitude of Space Shuttle in orbit	1-4x10 <sup>-11</sup>
Air at 0°C and 1 atm	1.3
Carbon Dioxide	1.9
Balsa	110-140
Bone	170-200
Cork	220-260
The Larch	500-560
Lithium	530
Applewood	660-840
Peat Blocks	840
Ice	920
Olive Oil	920
Sodium	970
Water at 0°C and 1 atm	1000
Rock Salt	2180
Graphite	2300-2700
Aluminum	2700
Basalt	2400-3100
Talc	2700-2800
Dolomite	2830
Diamond	3010-3520
Average density of Earth	5520
Iron	7860
Lead	11340
Iridium	22400
Osmium	22500
Uranium nucleus	3x10 <sup>17</sup>
Neutron star (center)	10 <sup>17</sup> -10 <sup>18</sup>

### Mathematics Standards

- Δ  Algebra
- Functions
- Δ  Geometry
- Geometry from a Synthetic Perspective
- Δ  Mathematical Connections
- Δ  Mathematics as Communication
- Δ  Mathematics as Problem Solving
- Δ  Measurement
- Trigonometry

### Science Standards

- Δ  Physical Science
- Δ  Science and Technology
- Δ  Science in Personal and Social Perspectives
- Δ  Unifying Concepts and Processes

Gravity can also mask some phenomena that scientists wish to study. An example is the process of diffusion. Diffusion is the intermingling of solids, liquids, and gases due to differences in composition. Such intermingling occurs in many situations, but diffusion effects can be easily hidden by stronger convective mixing. As an example, imagine a large room in which all air circulation systems are turned off and in which a group of women are spaced ten feet apart standing in a line. If an open container of ammonia were placed in front of the first woman in line and each woman raised her hand when she smelled the ammonia, it would take a considerable amount of time before everyone raised her hand. Also, the hand raising would occur sequentially along the line from closest to the ammonia to furthest from the ammonia. If the same experiment were performed with a fan circulating air in the room, the hands would be raised more quickly, and not necessarily in the same order. In the latter case, mixing of the ammonia gas with the air in the room is due to both diffusion and convection (forced convection due to the fan) and the effects of the two processes cannot be easily separated. In a similar manner, buoyancy driven convection can mask diffusive mixing of components in scientific experiments.

Some behavior of liquids can also be masked by gravity. If you pour a liquid into a container on Earth, the liquid conforms to the bottom of the container due to gravity. Depending on the shape of the container and on the properties of the container and the liquid, some of the liquid may creep up the walls or become depressed along the walls due to the interrelated phenomena of **surface tension**, adhesion, cohesion, and **capillarity**.

The resulting curved surface may be familiar to anyone who has measured water in a small diameter glass container (**the water cups upward**) or has looked at the level of mercury in a glass thermometer (**the mercury cups downward**). The distance the contact





line between the liquid and the container moves up or down the container wall is affected by gravity.

Experiments performed on Earth often take advantage of the effects of gravity discussed. For many experiments, however, these effects tend to make the execution of experiments or the analysis of experimental results difficult and sometimes even impossible. Therefore, many researchers design experiments to be performed under microgravity conditions. The different scientific research areas that are studied in microgravity include biotechnology, combustion science, fluid physics, fundamental physics, and materials science. Each of these areas, or disciplines, is discussed below. The discipline is defined, some of the specific effects of gravity that illustrate the benefits of microgravity research are discussed, and some examples of current research are presented. In addition, a brief discussion of the microgravity environment of orbiting spacecraft is provided as is an introduction to the application of microgravity research to the exploration and development of space.

## The Microgravity Environment of Orbiting Spacecraft

While freefall reduces the effects of gravity, being in an orbiting laboratory introduces other accelerations that cause effects that are indistinguishable from those due to gravity. When a spacecraft is in orbit around Earth, the orbit is actually defined by the path of the center of mass of the spacecraft around the center of Earth. Any object in a location other than on the line traversed by the center of mass of the spacecraft is actually in a different orbit around Earth. Because of this, all objects not attached to the spacecraft move relative to the orbiter center of mass. Other relative motions of unattached objects are related to aerodynamic drag on the

**Capillarity** can be defined as the attraction a fluid has for itself versus the attraction it has for a solid surface (usually the fluid's container). The **surface tension**  $\sigma$  in a liquid-liquid or liquid-gas system is the fluids' tendency to resist an increase in surface area. Surface tension is temperature dependent. Surface tension, capillarity, adhesion, and cohesion work together to drive the contact angle  $\theta$  between a solid-liquid interface and liquid-liquid interface when a small diameter tube is dipped into a liquid. When the contact angle  $\theta=0$ , the liquid "wets" the tube completely. When  $\theta<90^\circ$  (an acute angle), the liquid rises in the tube; when  $\theta>90^\circ$  (an obtuse angle), the liquid is depressed in the tube and does not wet the walls. The distance between the liquid surface in the container and in the tube is  $h=2\sigma\cos\theta/r\rho g$  where  $r$  is the radius of the tube ( $D/2$ ),  $\rho$  is the density of the liquid, and  $g$  is the acceleration due to gravity.

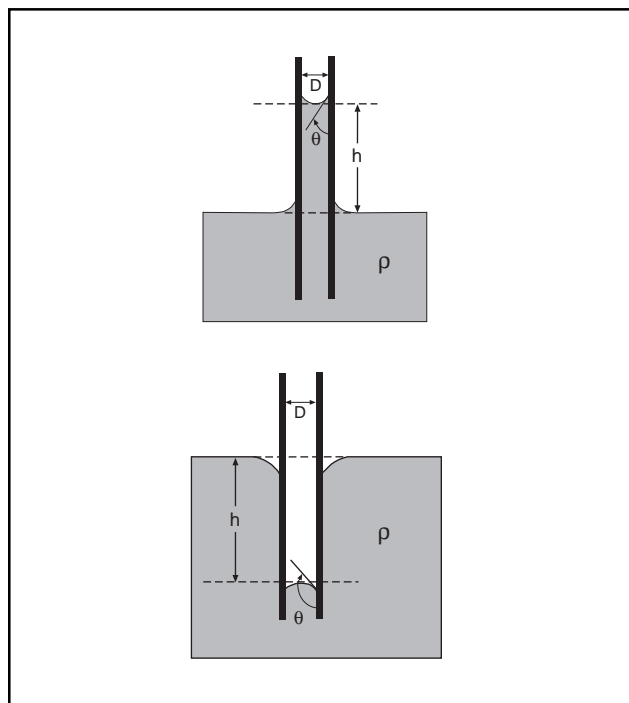

### Mathematics Standards

- Functions
- $\Delta$   Geometry
- Geometry from a Synthetic Perspective

### Science Standards

- $\Delta$   Science and Technology
- $\Delta$   Science in Personal and Social Perspectives
- $\Delta$   Unifying Concepts and Processes

Something that is **concave** is curved inward like the inner surface of a sphere. Something that is **convex** is curved like the outer surface of a sphere. A variety of concave and convex lenses and mirrors are used in the design of eyeglasses, magnifying glasses, cameras, microscopes, and telescopes. In the example in the text, water cupping upward produces a concave surface; mercury cupping downward produces a convex surface.



## Mathematics Standards

- Δ Computation and Estimation
- Δ  Mathematical Connections
- Δ  Mathematics as Communication
- Δ Measurement

## Science Standards

Grades 5-8 (Δ); Grades 9-12 ()

- Δ  Physical Science
- Δ  Science and Technology
- Δ  Unifying Concepts and Processes

**Quasi-steady accelerations** in spacecraft are related to the position in the spacecraft, aerodynamic drag, and vehicle rotation. For the Space Shuttle Orbiters, these accelerations are on the order of  $1 \times 10^{-6}$  g and vary with the orbital frequency.

## Mathematics Standards

- Δ Computation and Estimation
- Δ  Mathematical Connections
- Δ  Mathematics as Communication
- Δ Measurement

## Science Standards

- Δ  Physical Science
- Δ  Science and Technology
- Δ  Unifying Concepts and Processes

**g-jitter** indicates the vibrations experienced by microgravity experiments (for example on parabolic aircraft and the Space Shuttle) that cause effects similar to those that would be caused by a time-varying gravitational field.

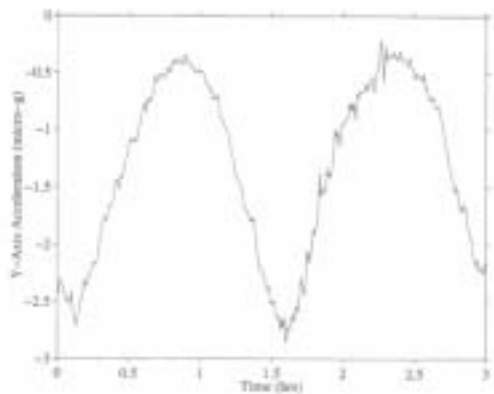

*The quasi-steady microgravity environment on the Orbiter Columbia shows the effects of variations in Earth's atmospheric density. The primary contribution to the variation is the day/night difference in atmospheric density. The plot shows that the drag on the Orbiter varies over a ninety minute orbit.*

vehicle and spacecraft rotations. A spacecraft in low-Earth orbit experiences some amount of drag due to interactions with the atmosphere. An object within the vehicle, however, is protected from the atmosphere by the spacecraft itself and does not experience the same deceleration that the vehicle does. The floating object and spacecraft therefore are moving relative to each other. Similarly, rotation of the spacecraft due to orbital motion causes a force to act on objects fixed to the vehicle but not on objects freely floating within it. On average for the Space Shuttles, the **quasi-steady accelerations** resulting from the sources discussed above (position in the spacecraft, aerodynamic drag, and vehicle rotation) are on the order of  $1 \times 10^{-6}$  g, but vary with time due to variations in the atmospheric density around Earth and due to changes in Shuttle orientation.

In addition to these quasi-steady accelerations, many operations on spacecraft cause vibrations of the vehicle and the payloads (experiment apparatus). These vibrations are often referred to as **g-jitter** because their effects are similar to those that would be caused by a time-varying gravitational field. Typical sources for vibrations are experiment and spacecraft fans and pumps, motion of centrifuges, and thruster firings. With a crew onboard to conduct experiments, additional vibrations can result from crew activities.

The combined acceleration levels that result from the quasi-steady and vibratory contributions are generally referred to as the microgravity environment of the spacecraft. On the Space Shuttles, the types of vibration-causing operations discussed above tend to create a cumulative background microgravity environment of about  $1 \times 10^{-4}$  g, considering contributions for all frequencies below 250 Hz.

## Biotechnology

Biotechnology is an applied biological science that involves the research, manipulation, and





manufacturing of biological molecules, tissues, and living organisms. With a critical and expanding role in health, agriculture, and environmental protection, biotechnology is expected to have a significant impact on our economy and our lives in the next century. Microgravity research focuses on three principal areas—protein crystal growth, mammalian cell and tissue culture, and fundamental biotechnology.

Gravity significantly influences attempts to grow protein crystals and mammalian cell tissue on Earth. Initial research indicates that protein crystals grown in microgravity can yield substantially better structural information than can be obtained from crystals grown on Earth. Proteins consist of thousands—or in the case of viruses, millions—of atoms, which are weakly bound together, forming large molecules. On Earth, buoyancy-induced convection and sedimentation may inhibit crystal growth. In microgravity, convection and sedimentation are significantly reduced, allowing for the creation of structurally better and larger crystals.

The absence of sedimentation means that protein crystals do not sink to the bottom of their growth container as they do on Earth. Consequently, they are not as likely to be affected by other crystals growing in the solution. Because convective flows are also greatly reduced in microgravity, crystals grow in a much more quiescent environment, which may be responsible for the improved structural order of space-grown crystals. Knowledge gained from studying the process of protein crystal growth under microgravity conditions will have implications for protein crystal growth experiments on Earth.

Research also shows that mammalian cells—particularly normal cells—are sensitive to conditions found in ground-based facilities used to culture (grow) them. Fluid flows caused by gravity can separate the cells from each other,

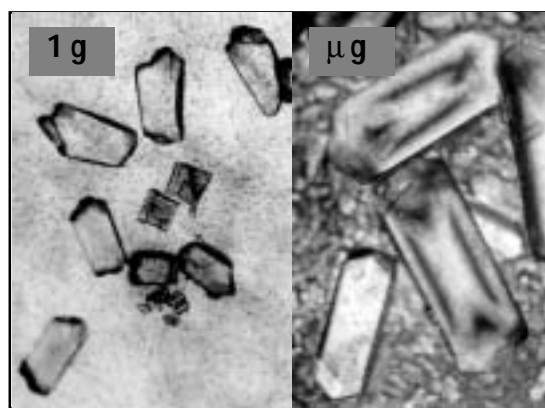

*Protein crystals grown in microgravity can have regular, simple shapes and a more highly ordered internal structure than those grown on Earth.*

severely limiting the number of cells that will aggregate (come and stay together). But tissue samples grown in microgravity are much larger and more representative of the way in which tissues are actually produced inside the human body. This suggests that better control of the stresses exerted on cells and tissues can play an important role in their culture. These stresses are greatly reduced in microgravity.

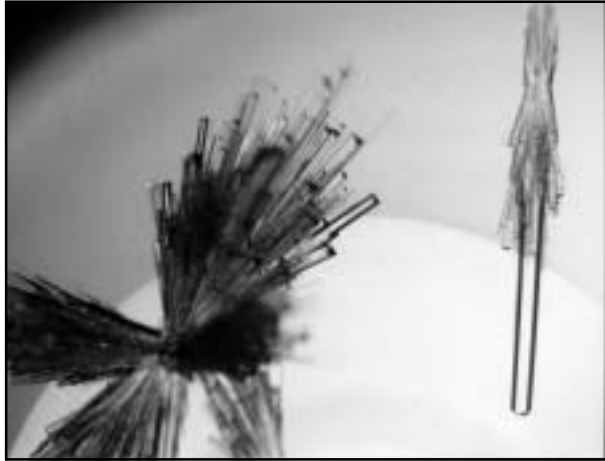

*Crystallized protein lysozyme after dialysis to remove small molecule contaminants.*

## Protein Crystal Growth

The human body contains over 100,000 different proteins. These proteins play important roles in the everyday functions of the body, such as the transport of oxygen and chemicals in the blood, the formation of the major components of muscle and skin, and the fighting of disease. Researchers in this area seek to determine the structures of these proteins, to understand how a protein's structure affects its function, and ultimately to design drugs that intercede in protein activities (penicillin is a well-known example of a drug that works by blocking a protein's function). Determining protein structure is the key to the design and development of effective drugs.

The main purpose in growing protein crystals is to advance our knowledge of biological molecular structures. Researchers can use microgravity to help overcome a significant stumbling block in the determination of molecular structures: the difficulty of growing crystals suitable for structural analysis. Scientists use X-ray diffraction to determine the three-dimensional molecular structure of a protein. They can calculate the location of the atoms that make up the protein based on the intensity and position of the spots formed by the diffracted X-rays. From high resolution diffraction data, scientists can describe a protein's structure on a molecular scale and determine the parts of the protein that are important to its functions. Using computer analysis, scientists can create and manipulate three-dimensional models of the protein and examine the intricacies of its structure to create a drug that "fits" into a protein's active site, like inserting a key into a lock to "turn off" the

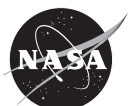

protein's function. But X-ray diffraction requires large, **homogeneous** crystals (about the size of a grain of table salt) for analysis. Unfortunately, crystals grown in Earth's gravity often have internal defects that make analysis by X-ray diffraction difficult or impossible. Space Shuttle missions have shown that crystals of some proteins (and other complex biological molecules such as viruses) grown on orbit are larger and have fewer defects than those grown on Earth. The improved data from the space-grown crystals significantly enhance scientists' understanding of the protein's structure and this information can be used to support structure-based drug design.

Scientists strive for a better understanding of the fundamental mechanisms by which proteins form crystals. A central goal of microgravity protein crystal growth experiments is to determine the basic science that controls how proteins interact and order themselves during the process of crystallization. To accomplish this goal, NASA has brought together scientists from the protein crystallography community, traditional crystal growers, and other physical scientists to form a multidisciplinary team in order to address the problems in a comprehensive manner.

### Mammalian Cell and Tissue Culture

Mammalian cell tissue culturing is a major area of research for the biotechnology community. Tissue culturing is one of the basic tools of medical research and is key to developing future medical technologies such as ex vivo (outside of the body) therapy design and tissue transplantation. To date, medical science has been unable to fully culture human tissue to the mature states of **differentiation** found in the body.

The study of normal and cancerous mammalian tissue growth holds enormous promise for applications in medicine. However, conventional static tissue culture methods form flat sheets of growing cells (due to their settling on the bottom of the container) that differ in appearance and function from their three-dimensional counterparts

### Science Standards

- Δ □ Physical Science
- Δ □ Unifying Concepts and Processes

A substance that is **homogeneous** is uniform in structure and/or composition.

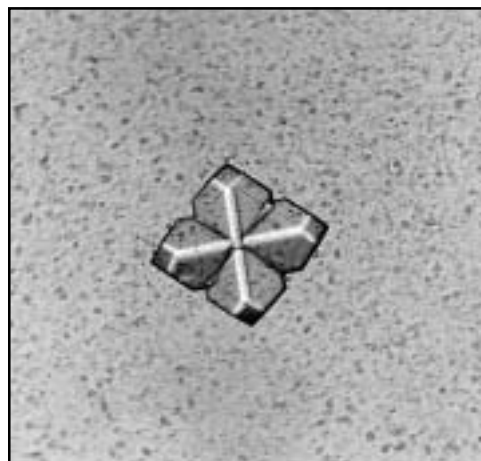

*Three different types of protein crystals grown on the Space Shuttle Columbia in 1995: satellite tobacco mosaic virus, lysozyme, and thaumatin.*



### Science Standards

- Δ  Life Science
- Δ  Unifying Concepts and Processes

**Differentiation** is the process (or the result of that process) by which cells and/or tissues undergo a progressive specialization of form or function.

### Mathematics Standards

- Algebra
- Conceptual Underpinnings of Calculus
- Geometry from an Algebraic Perspective
- Δ  Mathematical Connections
- Δ  Mathematics as Problem Solving

### Science Standards

- Δ  Physical Science
- Δ  Science and Technology
- Δ  Unifying Concepts and Processes

The **forces** acting on a surface can be separated into components perpendicular (normal) to and tangential to the surface. The normal force causes a normal stress and the tangential force is responsible for a tangential, or shear, stress acting on the surface. Shear forces cause contiguous parts of a structure or liquid to slide relative to each other.

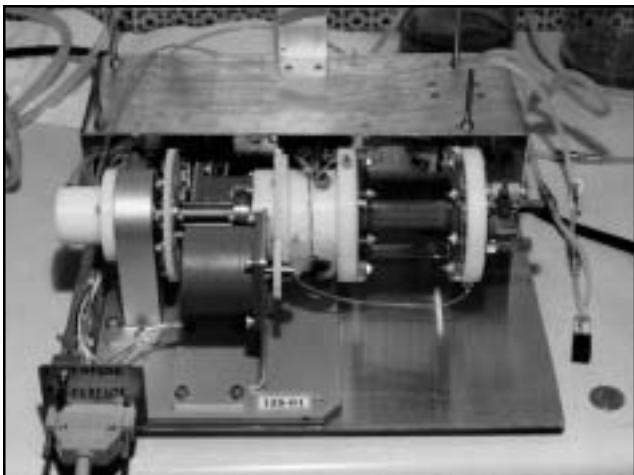

*A bioreactor vessel that flew on the Space Shuttle Discovery in July 1995.*

growing in a living body. In an effort to enhance three-dimensional tissue formation, scientists have developed a ground-based facility for cell and tissue culture called a bioreactor. This instrument cultures cells in a slowly rotating horizontal cylinder, which produces lower stress levels on the growing cells than previous Earth-based experimental environments. The continuous rotation of the cylinder allows the sample to escape much of the influence of gravity, but because the bioreactor environment tends to be rather passive, it is sometimes difficult for the growing tissue to find the fresh media (food supply) it needs to survive.

Another reason normal mammalian cells are sensitive to growth conditions found in standard bioreactors is that fluid flow causes **shear forces** that discourage cell aggregation. This limits both the development of the tissue and the degree to which it possesses structures and functions similar to those found in the human body. Tissue cultures of the size that can be grown in these bioreactors allow tests of new treatments on cultures grown from cells from the patient rather than on patients themselves. In the future, this technology will enable quicker, more thorough testing of larger numbers of drugs and treatments. Ultimately, the bioreactor is expected to produce even better results when used in a microgravity environment.

In cooperation with the medical community, the bioreactor design is being used to prepare better models of human colon, prostate, breast, and ovarian tumors. Cells grown in conventional culture systems may not differentiate to form a tumor typical of cancer. In the bioreactor, however, these tumors grow into specimens that resemble the original tumor. Similar results have been observed with normal human tissues as well. Cartilage, bone marrow, heart muscle, skeletal muscle, pancreatic islet cells, liver cells, and kidney cells are examples of the normal tissues currently being grown in rotating bioreactors by investigators. In addition,

laboratory models of heart and kidney diseases, as well as viral infections (including Norwalk virus and Human Immunodeficiency Virus (HIV)) are currently being developed using a modified NASA bioreactor experiment design with slight variations in experimental technique and some adjustments to hardware. Continued use of the bioreactor can improve our knowledge of normal and cancerous tissue development. NASA is beginning to explore the possibility of culturing tissues in microgravity, where even greater reduction in stresses on growing tissue samples may allow much larger tissue masses to develop. A bioreactor is in use on the Russian Space Station Mir in preparation for the International Space Station.

## Fundamental Biotechnology

**Electrophoresis** has been studied on a dozen Space Shuttle flights and has led to additional research in fluid physics in the area of electrohydrodynamics. Phase partitioning experiments, which use interfacial energy (the energy change associated with the contact between two different materials) as the means of separation, have flown on six missions.

## Combustion Science

Combustion, or burning, is a rapid, self-sustaining chemical reaction that releases a significant amount of heat. Examples of common combustion processes are burning candles, forest fires, log fires, the burning of natural gas in home furnaces, and the burning of gasoline in internal combustion engines. For combustion to occur, three things must normally be present: **a fuel, an oxidizer, and an ignition stimulus**. Fuels can be solid, liquid, or gas. Examples of solid fuels include filter paper, wood, and coal. Liquid fuels include gasoline and kerosene. Propane and hydrogen are examples of gaseous fuels. Oxidizers can be solid (such as ammonium perchlorate, which is used in Space Shuttle booster rockets), liquid (like hydrogen peroxide), or gaseous

### Science Standards

- Δ □ Physical Science
- Δ □ Science and Technology
- Δ □ Sciences in Personal and Social Perspectives
- Δ □ Unifying Concepts and Processes

**Electrophoresis** is the separation of a substance based on the electrical charge of the molecule and its motion in an applied electric field.

### Science Standards

- Δ □ Physical Science
- Δ □ Science and Technology
- Δ □ Science in Personal and Social Perspectives
- Δ □ Unifying Concepts and Processes

An **exception to the standard combustion process** is hypergolic combustion. In this situation, a fuel and an oxidizer spontaneously react on contact without the need for an ignition stimulus. The jets used to maintain and change the Shuttle's orientation when in orbit are powered by hypergolic reactions.





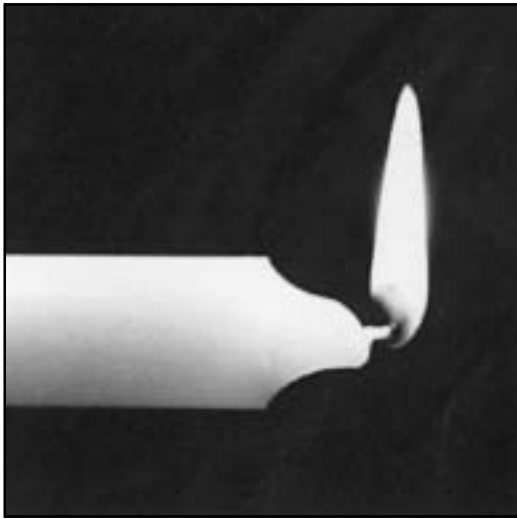

*The familiar shape of a candle flame on Earth is caused by buoyancy-driven convection. In microgravity, a candle flame assumes a spherical shape as fresh oxidizer reaches it by diffusion processes.*

(like oxygen). Air, which contains oxygen, is a particularly common oxidizer. An electrical spark is an example of an ignition stimulus.

Combustion is a key element in many of modern society's critical technologies. Electric power production, home heating, ground transportation, spacecraft and aircraft propulsion, and materials processing are all examples in which combustion is used to convert chemical energy to thermal energy. Although combustion, which accounts for approximately 85 percent of the world's energy usage, is vital to our current way of life, it poses great challenges to maintaining a healthy environment. Improved understanding of combustion will help us deal better with the problems of pollutants, atmospheric change and global warming, unwanted fires and explosions, and the incineration of hazardous wastes. Despite vigorous scientific examination for over a century, researchers still lack full understanding of many fundamental combustion processes.

Some objectives of microgravity combustion science research are to enhance our understanding of the fundamental combustion phenomena that are affected by gravity, to use research results to advance combustion science and technology on Earth, and to address issues of fire safety in space. NASA microgravity combustion science research combines the results of experiments conducted in ground-based microgravity facilities and orbiting laboratories and studies how flames ignite, spread, and extinguish (go out) under microgravity conditions.

Research in microgravity permits a new range of combustion experiments in which buoyancy-induced flows and sedimentation are virtually eliminated. The effects of gravitational forces often impede combustion studies performed on Earth. For example, combustion generally produces hot gas (due to the energy released in the reaction), which is less dense than the cooler gases around it. In Earth's gravity, the

hot gas is pushed up by the denser surrounding gases. As the hot gas rises, it creates buoyancy-induced flow that promotes the mixing of the unburned fuel, oxidizer, and combustion products.

The ability to significantly reduce gravity-driven flows in microgravity helps scientists in several ways. One advantage is that the “quieter” and more symmetric microgravity environment makes the experiments easier to **model (describe mathematically)**, thus providing a better arena for testing theories. In addition, eliminating buoyancy-induced flows allows scientists to study phenomena that are obscured by the effects of gravity, such as the underlying mechanisms of fuel and heat transport during combustion processes. Because buoyancy effects are nearly eliminated in microgravity, experiments of longer duration and larger scale are possible, and more detailed observation and examination of important combustion processes can occur.

Scientists often desire an even mixture of the component parts of fuels so that models developed for their experiments can use simplified sets of equations to represent the processes that occur. Sedimentation affects combustion experiments involving particles or droplets because, as the components of greater density sink in a gas or liquid, their movement relative to the other particles creates an asymmetrical flow around the dropping particles. This can complicate the interpretation of experimental results. On Earth, scientists must resort to mechanical supports, levitators, and stirring devices to keep fuels mixed, while fluids in microgravity stay more evenly mixed without sticking together, colliding, or dispersing unevenly.

### Mathematics Standards

- Δ  Computation and Estimation
  - Discrete Mathematics
- Δ  Mathematical Connections
- Δ  Mathematics as Communication
- Δ  Mathematics as Problem Solving
- Δ  Mathematics as Reasoning

### Science Standards

- Δ  Physical Science
- Δ  Science as Inquiry
- Δ  Science and Technology
- Δ  Unifying Concepts and Processes

The creation and use of **mathematical models** is a key element of science, engineering, and technology. Modeling begins with identifying the physical and chemical phenomena involved in an experiment. Associated mathematical equations such as equations of motion are then identified. These governing equations are solved in order to predict important aspects of the experiment behavior, using appropriate values of experiment parameters such as density, composition, temperature, and pressure. Simple mathematical models can be solved by hand, while more complex experiments are generally modeled using sophisticated algorithms on high speed computers.

In microgravity research, scientists use modeling in preparation for flight experiments and in analysis of the results. Models and experiment procedures are fine-tuned based on comparisons between model predictions and the results of ground-based microgravity experiments (for example, drop facilities and parabolic aircraft flights). This preliminary work allows researchers to best take advantage of space flight opportunities.



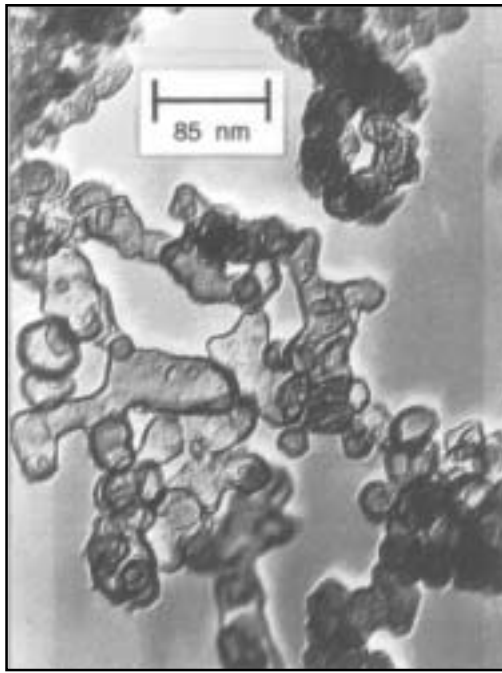

*Transmission Electron Microscope image of laser-heated soot.*

To date, combustion science researchers have demonstrated major differences in the structures of various types of flames burning under microgravity conditions and under 1 g conditions. In addition to the practical implications of these results in combustion efficiency, pollutant control, and flammability, these studies establish that better understanding of the individual processes involved in the overall combustion process can be obtained by comparing results from microgravity and Earth gravity tests. One clear example of the advantage of these comparison tests is in the area of fire safety. Most smoke detectors have been designed to detect soot particles in the air, but the sizes of soot particles produced in 1 g are different from those produced in microgravity environments. This means that smoke-detecting equipment must be redesigned for use on spacecraft to ensure the safety of equipment and crew.

Comparisons of research in microgravity and in 1 g have also led to improvements in combustion technology on Earth that may reduce pollutants and improve fuel efficiency. Technological advances include a system that measures the composition of gas emissions from factory smoke stacks so that they can be monitored. In addition, a monitor for ammonia, which is one gas that poses dangers to air quality, is already being produced and is available for industrial use. Engineers have also designed a device that allows natural gas appliances to operate more efficiently while simultaneously reducing air pollution. This may be used in home furnaces, industrial processing furnaces, and water heaters in the future. Another new technology is the use of advanced optical diagnostics and lasers to better define the processes of soot formation so that soot-control strategies can be developed. Devices have also been developed to measure percentages of soot in exhausts from all types of engines and combustors, including those in automobiles and airplanes.



The combustion science program supports experiments in the following research areas:

### Premixed Gas Flames

In premixed gas flame research, the fuel and oxidizer gases are completely mixed prior to ignition. Scientists are interested in flame speed (the rate at which the flame zone travels away from the ignition source and into the unreacted mixture) as a function of both the type of fuel and oxidizer used and the oxidizer-to-fuel ratio. With sufficiently high or low ratios, the flame does not move into the unreacted mixture; these critical ratios are referred to as lower and upper flammability limits and are of considerable interest in terms of both safety and fundamental science. Gravity can strongly affect both flame speed and flammability limits, chiefly through buoyancy effects. Scientists in this area are also researching gravity's effects on the stability, extinction, structure, and shape of premixed gas flames.

### Gaseous Diffusion Flames

In this area of research, the fuel and oxidizer gases are initially separate. They tend to diffuse into each other and will react at their interface upon ignition. The structure of these flames under microgravity conditions is quite different than on Earth because of buoyancy-induced flows caused by Earth's gravity. Scientists study flammability limits, burning rates, and how diffusion flame structure affects soot formation. Within this area, results of studies of the behavior of gas-jet flames in a microgravity environment, both in transition and in turbulent flows, are being used to develop models with potential applications in creating effective strategies to control soot formation in many practical applications.

### Liquid Fuel Droplets and Sprays

In this research area, scientists study the combustion of individual liquid fuel droplets suspended in an oxidizing gas (air, for example). For these experiments, investigators commonly use fuels

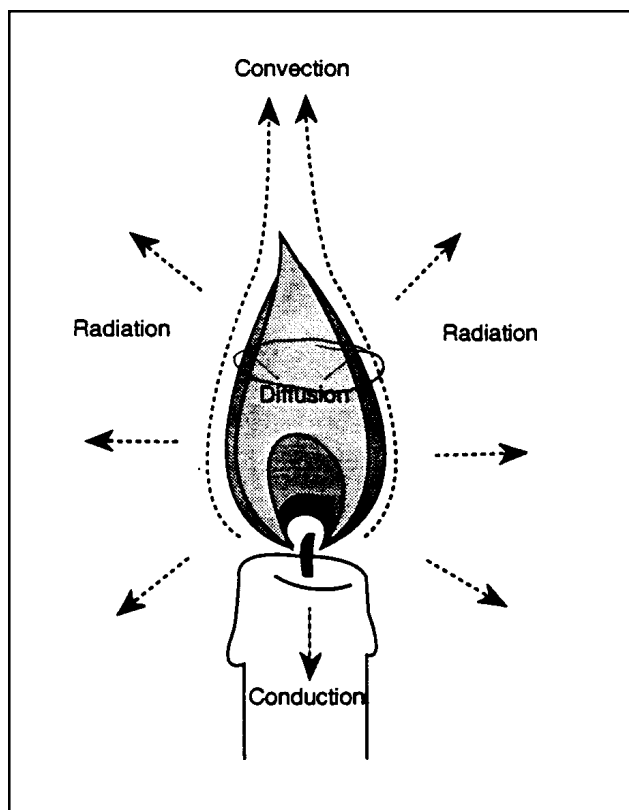

Candle flame energy flow. Adapted from “The Science of Flames” poster, National Energy Foundation, Salt Lake City, Utah.



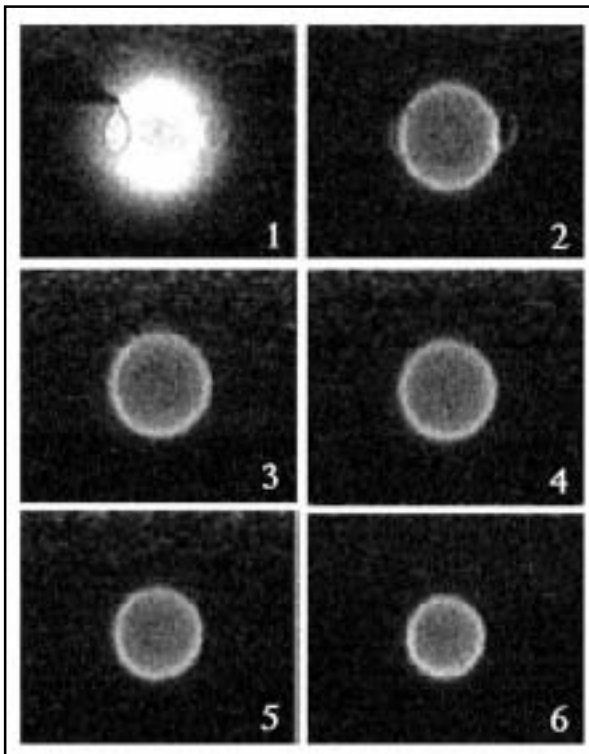

*Ultraviolet images of OH radiation taken at half-second intervals during a drop tower test of the Droplet Combustion Experiment. The diameter of the flame produced by burning a heptane droplet decreases in freefall.*

such as heptane, kerosene, and methanol. Gravity hinders fundamental studies of droplet combustion on Earth due to flows induced by high-density droplets that sink and buoyancy-induced upward acceleration of hot combustion products relative to the surrounding gas. These flows cause drops to burn unevenly, making it difficult for scientists to draw meaningful conclusions from their experiments.

This area of study also includes the investigation of the combustion of sprays and ordered arrays of fuel droplets in a microgravity environment for an improved understanding of interactions between individual burning droplets in sprays. Knowledge of spray combustion processes resulting from these studies should lead to major improvements in the design of combustors using liquid fuels.

### **Fuel Particles and Dust Clouds**

This area is particularly important in terms of fire safety because clouds of coal dust have the potential to cause mine explosions and grain-dust clouds can cause silos and grain elevators to explode. It is particularly difficult to study the fundamental combustion characteristics of fuel-dust clouds under normal gravity because initially well-dispersed dust clouds quickly settle due to density differences between the particles and the surrounding gas. Because particles stick together and collide during the sedimentation process, they form nonuniform fuel-air ratios throughout the cloud. In microgravity, fuel-dust clouds remain evenly mixed, allowing scientists to study them with much greater experimental control with a goal of mitigating coal mine and grain elevator hazards.

### **Flame Spread Along Surfaces**

An important factor in fire safety is inhibiting the spread of flames along both solid and liquid surfaces. Flame spread involves the reaction between an oxidizer gas and a condensed-phase fuel or the vapor produced by the “cooking” of

such a fuel. Research has revealed major differences in ignition and flame-spreading characteristics of liquid and solid fuels under microgravity and normal gravity conditions. Material flammability tests in 1 g, which are strongly affected by buoyancy-induced flows, do not match results obtained in microgravity. It is therefore useful to study both flame spread and material flammability characteristics in microgravity to ensure fire safety in environments with various levels of gravity. The knowledge gained from these studies may also lead to better understanding of dangerous combustion reactions on Earth. Microgravity experiments eliminate complexities associated with buoyancy effects, providing a more fundamental scenario for the development of flame-spreading theories.

### Smoldering Combustion

Smoldering combustion is a relatively slow, nonflaming combustion process involving an oxidizer gas and a porous solid fuel. Well-known examples of smoldering combustion are “burning” cigarettes and cigars. Smoldering combustion can also occur on much larger scales with fuels such as polyurethane foam. When a porous fuel smolders for a long period of time, it can create a large volume of gasified fuels, which are ready to react suddenly if a breeze or some other oxidizer flow occurs. This incites the fuel to make the transition to full-fledged combustion, often leading to disastrous fires (like those involving mattresses or sofa cushions). Since heat is generated slowly in this process, the rate of combustion is quite sensitive to heat exchange; therefore, buoyancy effects are particularly important. Accordingly, smoldering combustion is expected to behave quite differently in the absence of gravity.

### Combustion Synthesis

Combustion synthesis, a relatively new area of research, involves creating new materials through a combustion process and is closely tied to work in materials science. One area of particular interest is referred to as self-deflagrating high-

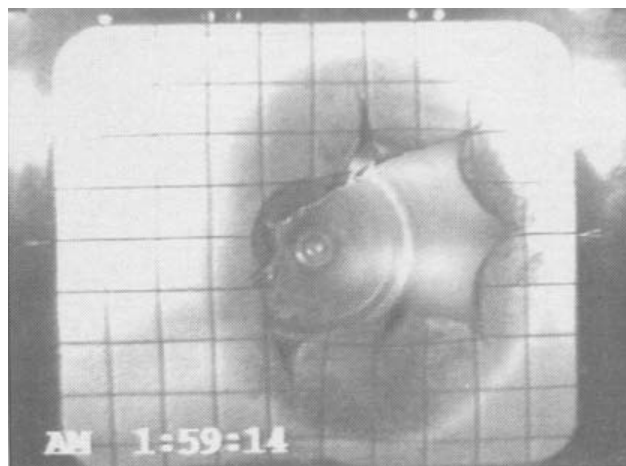

*View looking down at a piece of ashless filter paper with a 1 centimeter grid on it. On the USMP-3 Shuttle mission, a radiant heater (two concentric rings exposed at the center of the image) was used to ignite samples to study flame spread and smoldering in weak air flows under microgravity conditions. In this image, areas where the grid is not seen have been burned, with the cracking and curling edges of the burning paper leaving a cusped appearance. The flame started at the heater site and propagated toward the right where a fan provided a source of fresh air. Charred paper around the burnt area is a darker grey than the unaffected paper. White areas to the right of the heater rings are soot zones.*



temperature synthesis. This occurs when two materials— usually two solids—are mixed together, are reactive with one another, and create a reaction that gives off a large amount of heat. Once the reaction is started, the flame will propagate through a pressed mixture of these particles, resulting in a new material. Much of the initial research in this groundbreaking area involves changing variables such as composition, pressure, and preheat temperature. Manipulating these factors leads to interesting variations in the properties of materials created through the synthesis process.

Flame processes are also being used to create fullerenes and nanoparticles. Fullerenes, a new form of carbon, are expensive to produce at this time and cannot be produced in large quantities, but scientists predict more uses for them will be developed as they become more readily available. Nanoparticles (super-small particles) are also of great interest to materials scientists due to the changes in the microstructure of compacted materials that can be produced by sintering, which results in improved properties of the final products. These nanoparticles can thus be used to form better pressed composite materials.

### Science Standards

- Δ □ Physical Science
- Δ □ Unifying Concepts and Processes

A **fluid** is something that flows. Highly compressible fluids are usually considered gases; essentially incompressible fluids are usually considered liquids. Fluids tend to conform to the shape of a container. On Earth's surface, liquids tend to fill the bottom of an open or closed container and gases tend to fill closed containers.

## Fluid Physics

A **fluid** is any material that flows in response to an applied force; thus, both liquids and gases are fluids. Some arrangements of solids can also exhibit fluid-like behaviors; granular systems (such as soil) can respond to forces, like those induced by earthquakes or floods, with a flow-like shift in the arrangement of solid particles and the air or liquids that fill the spaces between them. Fluid physicists seek to better understand the physical principles governing fluids, including how fluids flow under the influence of energy, such as heat or electricity; how particles and gas bubbles suspended in a fluid interact with and change the properties of the fluid; how fluids interact with solid boundaries; and how fluids change phase, either from fluid to solid or from one fluid phase to another. Fluid phenomena studied



range in scale from microscopic to atmospheric and include everything from the transport of cells in the human body to changes in the composition of the atmosphere.

The universal nature of fluid phenomena makes their study fundamental to science and engineering. Understanding the fluid-like behavior of soils under stress will help civil engineers design safe buildings in earthquake-prone areas. Materials engineers can benefit from a better grasp of how the structure and properties of a solid metal are determined by fluid behavior during its formation. And knowledge of the flow characteristics of vapor-liquid mixtures is useful in designing power plants to ensure maximum stability and performance. The work of fluid physics researchers often applies to the work of other microgravity scientists.

## Complex Fluids

This research area focuses on the unique properties of complex fluids, which include colloids, gels, magneto-rheological fluids, foams, and granular systems.

Colloids are suspensions of finely divided solids or liquids in fluids. Some examples of colloidal dispersions are aerosols (liquid droplets in gas), smoke (solid particles in gas), and paint (solid in liquid). Gels are colloidal mixtures of liquids and solids in which the solids have linked together to form a continuous network, becoming very viscous (resistant to flow). Magneto-rheological fluids consist of suspensions of colloidal particles. Each particle contains many tiny, randomly oriented magnetic grains and an externally applied magnetic field can orient the magnetic grains into chains. These chains may further coalesce into larger-scale structures in the suspension, thereby dramatically increasing the viscosity of the suspension. This increase, however, is totally reversed when the magnetic field is turned off.

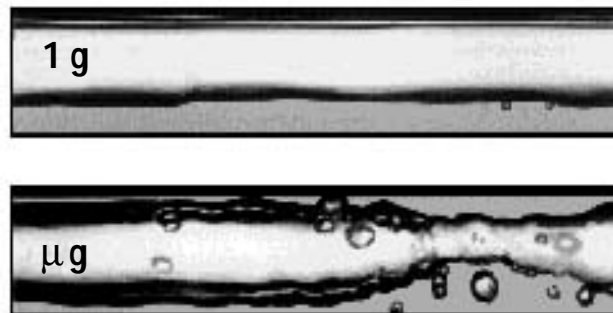

*Side views of water and air flowing through a clear pipe. At 1g, the air stays on top. In microgravity, the air can form a core down the center of the pipe.*





### Science Standards

- Δ □ Physical Science
- Δ □ Unifying Concepts and Processes

**Rheology** is the scientific study of the deformation and flow of matter.



*USML-2 Payload Commander Kathryn C. Thomson works at the Drop Physics Module, used to investigate liquid drop behavior in microgravity.*

A foam is a nonuniform dispersion of gas bubbles in a relatively small volume of liquid that contains surface-active macromolecules, or surfactants (agents that reduce the surface tension of liquids). Foams have striking properties in that they are neither solid, liquid, nor vapor, yet they exhibit features of all three. Important uses for customdesigned foams include detergents, cosmetics, foods, fire extinguishing, oil recovery, and many physical and chemical separation techniques. Unintentional generation of foam, on the other hand, is a common problem affecting the efficiency and speed of a vast number of industrial processes involving the mixing or agitation of multicomponent liquids. It also occurs in polluted natural waters and in the treatment of wastewater. In all cases, control of foam rheology and stability is required.

Examples of granular systems include soil and polystyrene beads, which are often used as packing material. Granular systems are made up of a series of similar objects that can be as small as a grain of sand or as large as a boulder. Although granular systems are primarily composed of solid particles, their behavior can be fluid-like. The strength of a granular system is based upon the friction between and geometric interlocking of individual particles, but under certain forces or stresses, such as those induced by earthquakes, these systems exhibit fluidic behavior.

Studying complex fluids in microgravity allows for the analysis of fluid phenomena often masked by the effects of gravity. For example, researchers are particularly interested in the phase transitions of colloids, such as when a liquid changes to a solid. These transitions are easier to observe in microgravity. Foams, which are particularly sensitive to gravity, are more stable (and can therefore be more closely studied for longer periods of time) in microgravity. In magneto-rheological fluids, controlling rheology induced by a magnetic field has many potential applications, from shock absorbers and clutch controls for cars to robotic joint controls. Under the force

of Earth's gravity, the magnetic particles in these fluids often fall out of suspension due to sedimentation, but in microgravity this problem is eliminated. Investigations of the behavior of granular systems, which have previously been hampered by Earth's gravity, are more feasible in microgravity because they do not settle as they do on Earth.

## **Multiphase Flow and Heat Transfer**

This research area, which has applications in the engineering of heat transfer systems and gas purification systems, focuses on complex problems of fluid flow in varying conditions. Scientists are seeking to add to their currently limited knowledge of how gravity-dependent processes, such as boiling and steam condensation, occur in microgravity. Boiling is known to be an efficient way to transfer large amounts of heat, and as such, it is often used for cooling and for energy conversion systems. In space applications, boiling is preferable to other types of energy conversion systems because it is efficient and the apparatus needed to generate power is smaller.

Another of the mechanisms by which energy and matter move through liquids and gases is diffusive transport. The way atoms and molecules diffuse, or move slowly, through a liquid or gas is due primarily to differences in concentration or temperature. Researchers use microgravity to study diffusion in complex systems, a process that would normally be eclipsed by the force of gravity.

Understanding the physics of multiphase flow and heat transfer will enable scientists to extend the range of human capabilities in space and will enhance the ability of engineers to solve problems on Earth as well. Applications of this research may include more effective air conditioning and refrigeration systems and improvements in power plants that could reduce the cost of generating electricity.



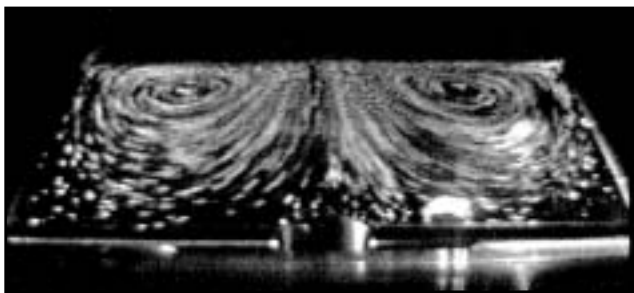
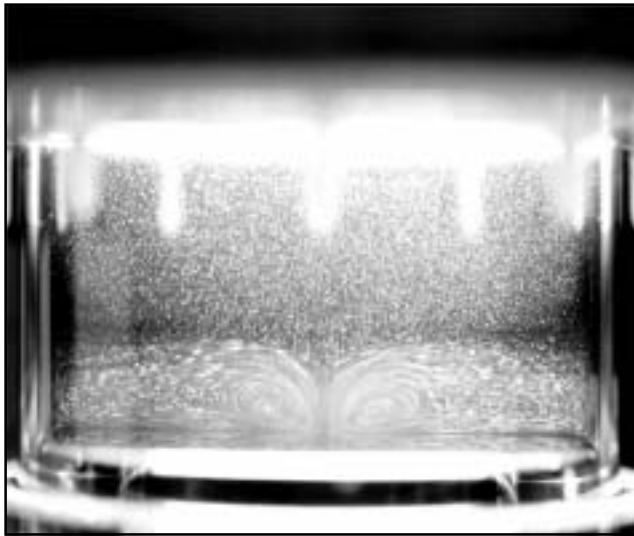

*Comparison of thermocapillary flows on Earth (top) and in microgravity (bottom). The flow pattern (indicated by the white areas) in the Earth-based experiments is only evident on the fluid's surface, while the flow pattern in microgravity encompasses the entire fluid.*

## Interfacial Phenomena

Research in this area focuses on how an interface, like the boundary between a solid and a liquid, acquires and maintains its shape. Interface dynamics relate to the interaction of surfaces in response to heating, cooling, and chemical influences. A better understanding of this topic will contribute to improved materials processing and other applications.

Interfacial phenomena, such as the wetting and spreading of two immiscible liquids or the spreading of fluid across a solid surface, are ubiquitous in nature and technology. Duck feathers and waterproof tents repel water because the wetting properties of the surfaces of their fibers prevent water from displacing the air in the gaps between the fibers. In contrast, water spontaneously displaces air in the gaps of a sponge or filter paper. Technologies that rely on dousing surfaces with fluids like agricultural insecticides, lubricants, or paints depend on the wetting behavior of liquids and solids. Wetting is also a dominant factor in materials processing techniques, including film and spray coating, liquid injection from an orifice, and crystal growth. Interfaces dominate the properties and behavior of advanced composite materials, where wetting of the constituent materials dictates the processing of such materials. Understanding and controlling wetting and spreading pose both scientific and technological challenges.

In reduced gravity, wetting determines the configuration and location of fluid interfaces, thus greatly influencing, if not dominating, the behavior of multiphase fluid systems. This environment provides scientists with an excellent opportunity to study wetting and surface tension forces that are normally masked by the force of Earth's gravity. This research also provides information that can help improve the design of space engineering systems strongly affected by wetting, including liquid-fuel supply tanks, two-phase heat transfer and/or storage loops, and fluids management devices for life support purposes.



## Dynamics and Stability

This broad area of research includes drop dynamics, capillarity, and magneto/electrohydrodynamics.

Drop dynamics research deals with the behavior of liquid drops and gas bubbles under the influence of external forces and chemical effects. Research in drop dynamics ranges from the study of rain in the atmosphere to the investigation of chemical processes. A potential application of these studies is in the realm of materials processing. In forming solid materials from liquids in space, it is usually important to create pure and/or uniform solids—gas bubbles and drops of foreign liquids are undesirable. Yet due to the microgravity environment, these bubbles and drops of substances of lower densities would not “rise to the top” the way they would if they were on the ground, which makes extraction of the bubbles difficult. Researchers are attempting to resolve this problem in order to facilitate better materials processing in space.

Scientists are also interested in studying single bubbles and drops as models for other natural systems. The perfect spheres formed by bubbles and drops in microgravity (due to the dominance of surface tension forces) are an easy fit to theoretical models of behavior—fewer adjustments need to be made for the shape of the model. Investigators can manipulate the spherical drops using sound and other impulses, creating an interactive model for processes such as atom fissioning.

Capillarity refers to a class of effects that depend on surface tension. The shape a liquid assumes in a liquid-liquid or liquid-gas system is controlled by surface tension forces at the interface. Small disturbances in the balance of molecular energies at these boundaries or within the bulk of the liquid can cause shifts in the liquid’s position and shape within a container (such as a fuel tank) or in a containing material (such as soil). These changes, or capillary effects, often occur in liquids on Earth,

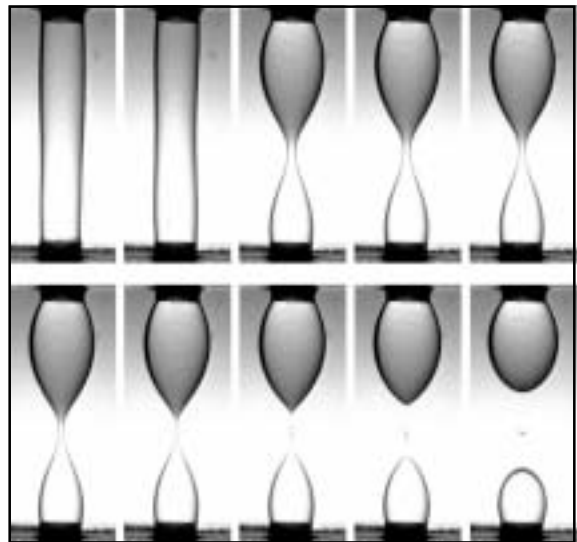

*This sequential photo shows a liquid bridge undergoing a series of shape changes. Liquid bridge investigations on the Shuttle have tested theories of electrohydrodynamics.*

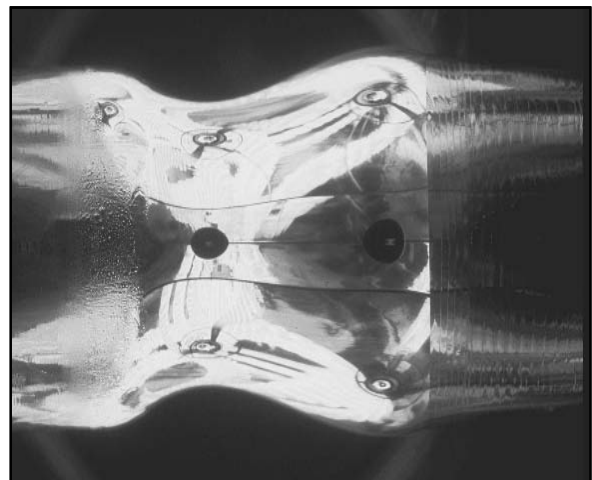

In materials science research, float zone samples are sometimes used for crystal growth. For a float-zone sampler the surface tension of the melt keeps the sample suspended between two sample rods in a furnace. A thorough understanding of the capillarity and surface tension effects in a molten sample allows better experiment control and results prediction.



but are to some degree masked or minimized by the stronger force of gravity. In microgravity, however, capillary effects become prominent. The study of capillary phenomena in microgravity will enable researchers to better understand and predict fluid configurational changes both on Earth and in low-gravity environments.

Microgravity fluid physics researchers also study the effects of magnetic and electric fields on fluid flows, or magneto/electrohydrodynamics. Promising microgravity research subjects in this area include weak fluid flows, such as those found in poorly conducting fluids in a magnetic field, and Joule heating. In Earth's gravity, **Joule heating** causes buoyancy-driven flows which, in turn, obscure its effects. In microgravity, however, buoyancy-driven flows are nearly eliminated, so researchers are not only able to study the effects of Joule heating, but they can also observe other processes involving applied electric fields, such as electrophoresis.

### Science Standards

- Δ □ Physical Science
- Δ □ Science and Technology
- Δ □ Unifying Concepts and Processes

**Joule heating** occurs when electric current flows through a material. This is how an electric toaster works .



*Researchers observe the float package and data rack of a superfluid helium experiment on a parabolic aircraft flight.*

## Fundamental Physics

Physics is a major part of fundamental science where the ultimate goal is to establish a unified description of the basic laws that govern our world. At present fundamental physics includes low temperature physics, condensed matter physics (the study of solids and liquids), laser cooling and atomic physics, and gravitational and relativistic physics. A unifying characteristic of these research areas is that they address fundamental issues which transcend the boundaries of a particular field of science.

The majority of experiments in fundamental physics are extensions of investigations in Earthbased laboratories. The microgravity experiment in these cases presents an opportunity to extend a set of measurements beyond what can be done on Earth, often by several orders of magnitude. This extension can lead either to a more precise confirmation of our previous understanding of a problem,

or it can yield fundamentally new insight or discovery. The remainder of fundamental physics research involves tests of the fundamental laws which govern our universe. Investigations aim at enhancing our understanding of the most basic aspects of physical laws, and as such may well have the most profound and lasting longrange impact on mankind's existence on Earth and in space.

There are many examples of how fundamental science has had an impact on the average person. Basic research in condensed matter physics to explain the behavior of semiconductors led to the development of transistors which are now used in communication devices, and which produce ever more prevalent and capable computer technology. Research in low temperature physics to explore the properties of fluids at very low temperatures led to advanced magnetic resonance techniques that have brought extremely detailed magnetic resonance imaging to the medical doctor, so today much exploratory surgery can be avoided. A less widely appreciated part played by fundamental science in today's world has been the need to communicate large quantities of data from physics experiments to collaborators at many locations around the world. Satisfying this need was instrumental in the development of the Internet and the World Wide Web.

Fundamental physics research benefits from both the reduction in gravity's effects in Earth-orbit and from the use of gravity as a variable parameter. In condensed matter physics, the physics of **critical points** has been studied under microgravity conditions. This field needs microgravity because the ability to approach a critical point in the Earthbound laboratory is limited by the uniformity of the sample which is spoiled by **hydrostatic pressure** variations. One of the important issues in condensed matter physics is the nature of the interface between solids and fluids. The boundary conditions at this interface have an influence on macroscopic phenomena, including wetting. The microscopic aspects of the system near the

#### Science Standards

- Δ □ Physical Science
- Δ □ Science and Technology
- Δ □ Unifying Concepts and Processes

The **critical point** is the temperature at which the differences between liquids and gases disappear. Above that temperature, the liquid smoothly transforms to the gaseous state; boiling disappears.

#### Mathematics Standards

- Δ □ Mathematical Connections
- Δ □ Mathematics as Communication
- Δ □ Mathematics as Problem Solving

#### Science Standards

- Δ □ Physical Science
- Δ □ Science and Technology
- Δ □ Unifying Concepts and Processes

**Hydrostatic pressure** is the result of the weight of a material above the point of measurement.



## Mathematics Standards

- Δ  Mathematical Connections
- Δ  Mathematics as Communication
- Δ  Mathematics as Problem Solving
- Δ  Measurement

## Science Standards

- Δ  History and Nature of Science
- Δ  Physical Science
- Δ  Science and Technology
- Δ  Science as Inquiry
- Δ  Unifying Concepts and Processes

There are three **temperature** scales commonly used in the world. The Kelvin scale, the Celsius temperature scale, and the Fahrenheit scale. The SI unit for temperature is the Kelvin. In most scientific laboratories, temperatures are measured and recorded in Kelvin's or degrees Celsius. The Celsius scale is used for weather reporting in most of the world. The United States and some other countries use the Fahrenheit scale for weather reporting.

The Kelvin scale is defined around the triple point of water (solid ice, liquid water, and water vapor coexist in thermal equilibrium) which is assigned the temperature 273.16 K. This is equal to 0.01°C and 32.02°F. Absolute zero, the coldest anything can get, is 0 K, -273.15°C, and -459.67°F.

### *Questions for Discussion*

- How do you convert between these different temperature scales?
- What are the boiling and freezing points of water on all these scales, at 1 atm pressure?

boundary are difficult to study. However, when the fluid is near a critical point, the boundary layer adjacent to the solid surface acquires a macroscopic thickness. Research under microgravity conditions permits the study of not only the influence of the boundaries on thermodynamic properties, but also transport properties such as heat and mass transport. One of the most dramatic advancements in atomic physics over the last decade has been the demonstration that laser light can be used to cool a dilute atomic sample to within micro- or even nano-degrees of absolute zero. At these low **temperatures**, the mean velocity of the atoms drops from several hundred m/s to cm/s or mm/s, a reduction by four to five orders of magnitude. When atoms are moving this slowly, measurements of atomic properties can be made more precisely because the atoms stay in a given point in space for a longer time. In this regime, the effects of gravity dominate atomic motion so experiments performed in a microgravity environment would allow even more precise measurements.

Among the most important goals of such research is the improvement of ultra-high precision clocks. These clocks not only provide the standard by which we tell time, but are crucial to the way we communicate and navigate on Earth, in the air, and in space. Laser cooled atoms have significantly improved the accuracy and precision of clocks because these atoms move very slowly and they remain in a given observation volume for very long times. However, observation times in these clocks are still affected by gravity. Because of the effects of gravity, the atoms used in these clocks ultimately fall out of the observation region due to their own weight. Increased observation times are possible in microgravity and can result in further improvements in precision of at least one or two orders of magnitude.

Indeed, clocks are central to the study of general relativity and in questions concerning the very nature of gravity itself. The motivation for space



based clocks is not only tied to the improved performance expected in a microgravity environment but also these clocks will have access to different positions in space than are available on Earth. An important example of this physics is revealed in the comparison of an Earth-based clock with a space-based clock. This comparison provides a direct measurement of the gravitational redshift. Tests of Einstein's theories of relativity and of other theories of gravitation serve as a foundation for understanding how matter and space-time itself behave at large length scales and under extreme conditions. The freefall environment of orbit, the use of low temperature techniques, and the use of high precision frequency standards offer opportunities to perform improved tests of these theories. Direct tests of gravitation theories and other fundamental theories, including the Law of Universal Gravitation, can be performed in a microgravity environment.

## Materials Science

Materials science is an extremely broad field that encompasses the study of all materials. Materials scientists seek to understand the formation, structure, and properties of materials on various scales, ranging from the atomic to microscopic to macroscopic (large enough to be visible). Establishing quantitative and predictive relationships between the way a material is produced (processing), its structure (how the atoms are arranged), and its properties is fundamental to the study of materials.

Materials exist in two forms: solids and fluids. Solids can be subdivided into two categories—crystalline and noncrystalline (amorphous)—based on the internal arrangement of their atoms or molecules. Metals (such as copper, steel and lead), ceramics (such as aluminum oxide and magnesium oxide), and **semiconductors** (such as silicon and gallium arsenide) are all crystalline solids because their atoms form an ordered

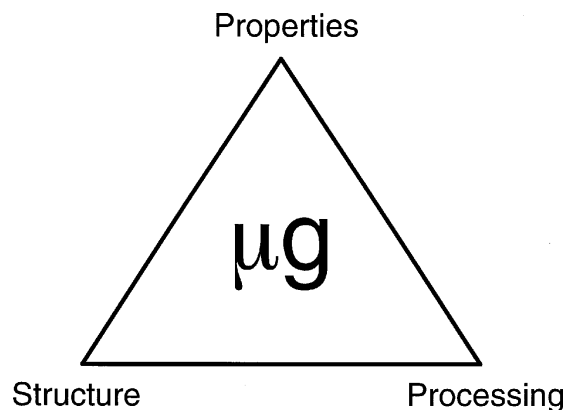

*Many materials scientists use a triangle such as this to describe the relationship between structure, processing, and properties. Microgravity can play an important role in establishing the relationships in a quantitative and predictive manner.*





## Science Standards

- Δ □ Physical Science
- Δ □ Science and Technology
- Δ □ Unifying Concepts and Processes

A **semiconductor** is a substance, such as germanium and silicon, that is a poor electrical conductor at room temperature but is improved by minute additions of certain substances (dopants) or by the application of heat, light, or voltage; a material with a forbidden energy gap less than 3 eV.

internal structure. Most polymers (such as plastics) and glasses are amorphous solids, which means that they have no long range specifically ordered atomic or molecular arrangement.

One principal objective of microgravity materials science research is to gain a better understanding of how gravity-driven phenomena affect the solidification and crystal growth of materials. Buoyancy-driven convection, sedimentation, and hydrostatic pressure can create defects (irregularities) in the internal structure of materials, which in turn alter their properties.

The virtual absence of gravity-dependent phenomena in microgravity allows researchers to study underlying events that are normally obscured by the effects of gravity and which are therefore difficult or impossible to study quantitatively on Earth. For example, in microgravity, where buoyancy-driven convection is greatly reduced, scientists can carefully and quantitatively study segregation, a phenomenon that influences the distribution of a solid's components as it forms from a liquid or gas.

Microgravity also supports an alternative approach to studying materials called containerless processing. Containerless processing has an advantage over normal processing in that containers can contaminate the materials being processed inside them. In addition, there are some cases in which there are no containers that will withstand the very high temperatures and corrosive environments needed to work with certain materials. Containerless processing, in which acoustic, electromagnetic, or electrostatic forces are used to position and manipulate a sample, thereby eliminating the need for a container, is an attractive solution to these problems.

Furthermore, microgravity requires much smaller forces to control the position of containerless samples, so the materials being studied are not

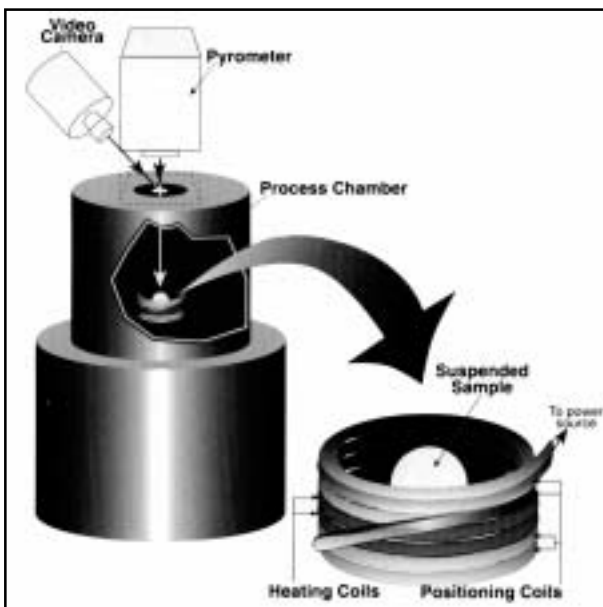

*Schematic of the Electromagnetic Containerless Processing Facility (TEMPUS) used on Shuttle missions STS-65 and STS-83.*



disturbed as much as they would be if they were levitated on Earth.

Materials science research in microgravity leads to a better understanding of how materials are formed and how the properties of materials are influenced by their formation. Researchers are particularly interested in increasing their fundamental knowledge of the physics and chemistry of phase changes (when a material changes from liquid to solid, gas to solid, etc.). This knowledge is applied to designing better process-control strategies and production facilities in laboratories on Earth. In addition, microgravity experimentation will eventually enable the production of limited quantities of high-quality materials and of materials that exhibit unique properties for use as benchmarks.

Microgravity researchers are interested in studying various methods of crystallization, including solidification (like freezing water to make ice cubes), crystallization from solution (the way rock candy is made from a solution of sugar and water), and crystal growth from the vapor (like frost forming in a freezer). These processes all involve fluids, which are the materials that are most influenced by gravitational effects. Examining these methods of transforming liquids or gases into a solid in microgravity gives researchers insight into other influential processes at work in the crystallization process.

## Electronic Materials

Electronic materials play an important role in the operation of computers, medical instruments, power systems, and communications systems. Semiconductors are well-known examples of electronic materials and are a main target of microgravity materials science research. Applications include creating crystals for use in X-ray, gamma-ray, and infrared detectors, lasers, computer chips, and solar cells. Each of these devices depends on the ability to manipulate the crystalline and chemical structure (perfection) of

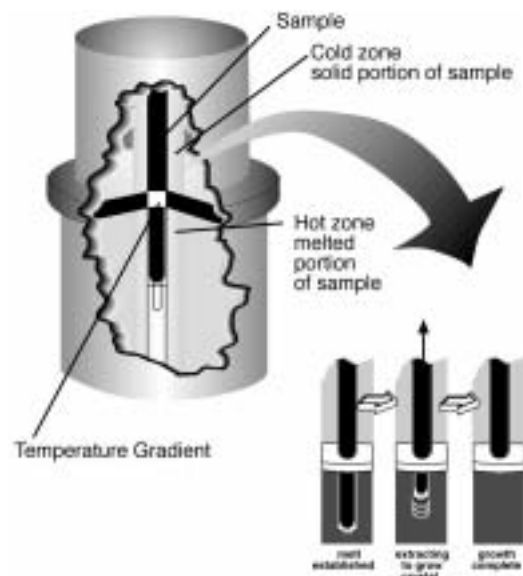

*Schematic diagram of a multizone furnace used to grow semiconductor materials on the Shuttle. A mechanism moves an existing c crystal through the temperature zones, melting the sample then cooling it so that it solidifies. In other furnace designs, the heating mechanism moves and the sample is stationary. What are the advantages and disadvantages of each approach?*



## Mathematics Standards

- Δ  Mathematical Connections
- Δ  Patterns and Functions
- Δ  Geometry
- Geometry from a Synthetic Perspective

## Science Standards

- Δ  Earth and Space Science
- Δ  Physical Science
- Δ  Science and Technology
- Δ  Unifying Concepts and Processes

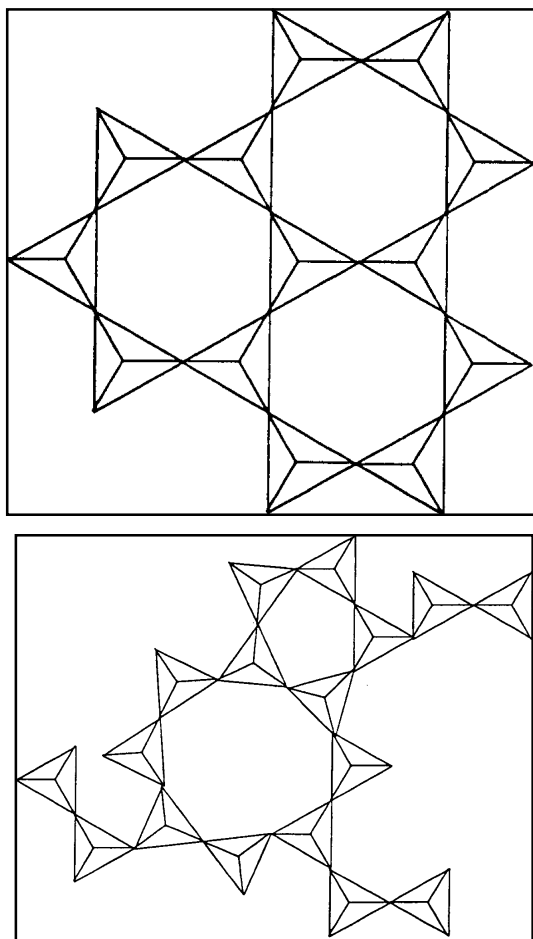

*Schematic of silicon dioxide tetrahedra. The top view is of a crystalline ordered structure. The bottom view is of a disordered glassy solid.*

### Questions for Discussion

- What is an ordinary drinking glass made from?
- What different things are added to glass to change its properties?
- What natural processes produce glasses?
- What are the differences between how glasses and crystalline solids fracture?

the material, which can be strongly influenced by gravity as crystals are formed.

The properties of electronic materials are directly related to the degree of chemical and crystalline perfection present in the materials. However, perfect crystals are not normally the ultimate goal. For example, the presence of just a few impurities in some electronic materials can change their ability to conduct electricity by over a million times. By carefully controlling crystalline defects and the introduction of desirable impurities to the crystals, scientists and engineers can design better electronic devices with a wide range of applications.

## Glasses and Ceramics

A glass is any material that is formed without a long range ordered arrangement of atoms. Some materials that usually take crystalline forms, like metals, can also be forced to form as glasses by rapidly cooling molten materials to a temperature far below their normal solidification point. When the material solidifies, it freezes so quickly that its atoms or molecules do not have time to arrange themselves systematically.

Ceramics are inorganic nonmetallic materials that can be extraordinarily strong at very high temperatures, performing far better than metallic systems under certain circumstances. They will have many more applications when important fundamental problems can be solved. If a ceramic turbine blade, for example, could operate at high temperatures while maintaining its strength, it would provide overall thermodynamic efficiencies and fuel efficiencies that would revolutionize transportation. The problem with ceramics is that when they fail, they fail catastrophically, breaking in an irreparable manner.

Glasses and ceramics are generally unable to absorb the impacts that metals can; instead, they crack under great force or stress (whereas metals generally bend before they break). An important part of ceramics and glass research in

microgravity involves controlling the minute flaws that govern how these materials fail. From information obtained through microgravity research, scientists hope to be able to control the processing of ceramics so that they can, during processing, prevent the formation of imperfections that lead to catastrophic failure.

Applications for knowledge obtained through research in these areas include improving glass fibers used in telecommunications and creating high-strength, abrasion-resistant crystalline ceramics used for gas turbines, fuel-efficient internal combustion engines, and bioceramic artificial bones, joints, and teeth.

## Metals and Alloys

Metals and **alloys** constitute an important category of engineered materials. These materials include structural materials, many types of composites, electrical conductors, and magnetic materials. Research in this area is primarily concerned with advancing the understanding of metals and alloys processing so that structure and, ultimately, properties, can be controlled as the materials are originally formed. By removing the influence of gravity, scientists can more closely observe influential processes in structure formation that occurs during solidification. The properties of metals and alloys are linked to their crystalline and chemical structure; for example, the mechanical strength and corrosion resistance of an alloy are determined by its internal arrangement of atoms, which develops as the metal or alloy solidifies from its molten state.

One aspect of the solidification of metals and alloys that influences their microstructures is the shape of the boundary, or interface, that exists between a liquid and a solid in a solidifying material. During the solidification process, as the rate of solidification increases under the same thermal conditions, the shape of the solidifying interface has been shown to go through a series of transitions. At low rates of growths the interface is planar (flat or smoothly curved

### Science Standards

- Δ □ Physical Science
- Δ □ Science and Technology
- Δ □ Unifying Concepts and Processes

An **alloy** is a combination of two or more metals.

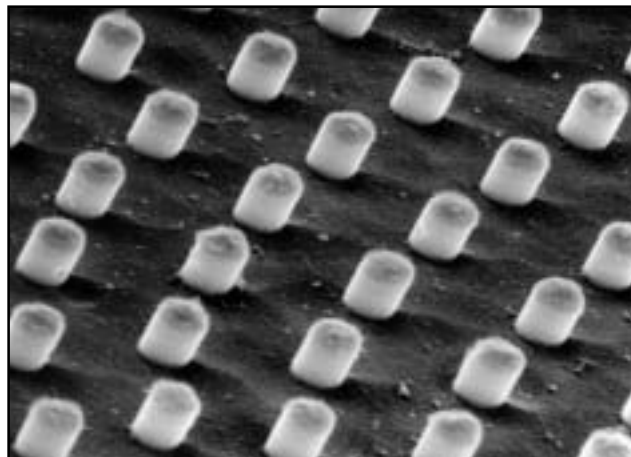

*Magnification of a sample of an aluminum-indium alloy. When the sample is melted then controllably solidifies in the AGHF; the indium forms in cylindrical fibers within a solid aluminum matrix.*



## Mathematics Standards

- Δ Geometry
  - Geometry from an Algebraic Perspective
  - Geometry from a Synthetic Perspective
- Δ □ Mathematical Connections
- Δ □ Mathematics as Communication

## Science Standards

- Δ □ Physical Science
- Δ □ Unifying Concepts and Processes

One of the important characteristics of a solid is its **shape**. On a visible scale, the function of some solids may depend on the ability to sit in a stable manner on a surface or to fit tightly into some configuration. On a smaller scale, the structures of crystalline solids are defined by the ordered placement of atoms. The basis of understanding crystalline structure and the shapes of solids is a knowledge of the definitions of two-dimensional shapes (polygons) and three-dimensional solids (polyhedra).

A simple  $k$ -sided polygon is defined by connecting  $k$  points in a plane with line segments such that no edges intersect except at the defining points (vertices). The sum of the angles in any polygon equals  $2\pi(k-2)$  or  $90^\circ(k-2)$ . Specific names given to some simple polygons are given below.

Name	# of Sides ( $k$ )
triangle	3
quadrilateral	4
pentagon	5
hexagon	6
heptagon	7
octagon	8
nonagon	9
decagon	10
undecagon	11
dodecagon	12

Regular polygons are those for which all the sides are the same length and all the angles are the same. The angles of a regular polygon are defined by  $\theta = (k-2) \times 180^\circ / k$ .

### Questions for Discussion

- Discuss special cases of triangles and quadrilaterals such as isosceles triangles, parallelograms, trapezoids.
- What is the common name for a regular triangle? For a regular quadrilateral?
- Is there a general equation for the area of any polygon?

on a macroscopic scale). As the rate of growth increases, the interface develops a corrugated texture until three dimensional cells (similar in **shape** to the cells in a beehive but much smaller) form in the solid. A further increase in the rate of growth causes the formation of dendrites. The development of these different interface shapes and the transition from one shape to another is controlled by the morphological stability (shape stability) of the interface. This stability is influenced by many factors. Gravity plays an important role in a number of them. In particular, buoyancy-driven convection can influence the stability and, thus, the shape of the solidifying interface. Data obtained about the conditions under which certain types of solidification boundaries appear can help to explain the formation of the crystalline structure of a material.

Another area of interest in metals and alloys research in microgravity is multiphase solidification. Certain materials, which are known as eutectics and monotectics, transform from a single phase liquid to substances of more than one phase when they are solidified. When these materials are processed on Earth, the resultant substances have a structure that was influenced by gravity either due to buoyancy-driven convection or sedimentation. But when processed in microgravity, theory predicts that the end product should consist of an evenly dispersed, multiphase structure.

Eutectic solidification is when one liquid, of uniform composition, forms with two distinct solid phases. An example of such a material is the alloy manganese-bismuth. Solidifying liquid Mn-Bi results in two different solids, each of which has a chemical composition that differs from the liquid. One solid (the minor phase) is distributed as rods, particles, or layers throughout the other solid (a continuous matrix, or major phase).

Monotectics are similar to eutectics, except that a monotectic liquid solidifies to form a solid and a



liquid (both of which are different in composition from the original liquid). Al-In is a monotectic that starts out as indium dissolved completely in aluminum, but when the alloy is solidified under the appropriate conditions, it forms a solid aluminum matrix with long thin “rods” of liquid indium inside it. As the system cools, the rods of liquid indium freeze into solid rods. The indium rods are dispersed within the structure of the solidified material.

## Polymers

Polymers are macromolecules (very large molecules) made up of numerous small repeating molecular units called monomers. They appear naturally in wool, silk, and rubber and are manufactured as acrylic, nylon, polyester, and plastic. Polymers are typically composed of long chains of monomers, appearing on the molecular scale as if they had a spine of particular elements such as carbon and nitrogen. The bonding between individual polymer molecules affects the material's physical properties such as surface tension, miscibility, and solubility. Manipulation of these bonds under microgravity conditions may lead to the development of processes to produce polymers with more uniform and controlled specific properties. Important optoelectronic and photonic applications are emerging for polymers, and many of the properties needed are affected by the polymers' crystallinity. This crystallinity, which is the extent to which chains of molecules line up with each other when the polymer is formed, may be more easily understood and controlled when removed from the influence of gravity.

Growing polymer crystals is more difficult than growing inorganic crystals (such as metals and alloys) because the individual polymer molecules weigh more and are more structurally complex, which hinders their ability to attach to a growing crystal in the correct position. Yet in microgravity, the process of polymer crystal growth can be studied in a fundamental way, with special attention to the effects of such variables as

Regular polyhedra (or the Platonic Solids) are listed and shown below.

<i>Name</i>	<i>Formed By</i>
tetrahedron	4 triangles
cube	6 squares
octahedron	8 triangles
dodecahedron	12 pentagons
icosahedron	20 triangles

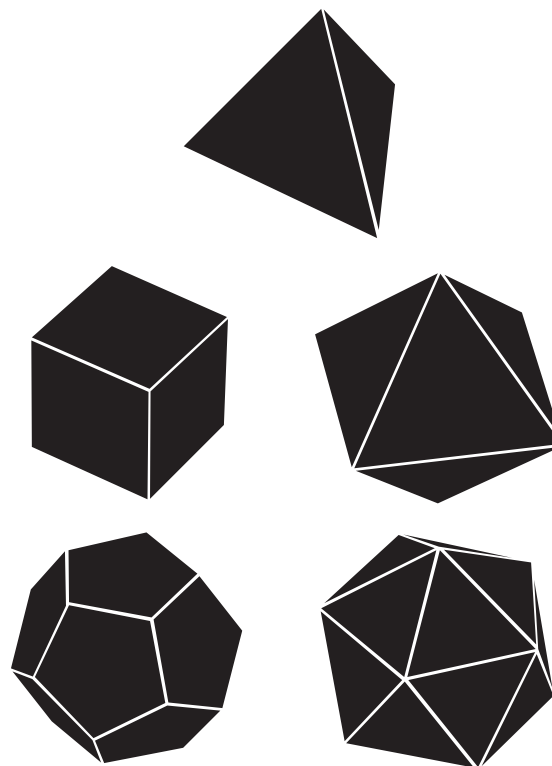

*The Five Regular Polyhedra or Platonic Solids Tnp-Tetrahedron; second row left-Cube; second row right- Octahedron; third row left-Dodecahedron; third row right-Icosahedron.*

### *Questions for Discussion*

- What do you think of as a cylinder and cone?
- What are the general definitions cylinder and cone'?
- What shapes are some mineral samples you have in your classroom?
- Investigate the crystalline structure of halite (rock salt), fluorine, quartz, diamond, iron.





temperature, compositional gradients, and the size of individual polymer units on crystal growth. In addition, just as microgravity enables the growth of larger protein crystals, it may allow researchers to grow single, large polymer crystals for use in studying properties of polymers and determining the effects of crystal defects on those properties.

## Microgravity Research and Exploration

### *NASA's Enterprise for the Human Exploration and Development of Space*

The goals of this Enterprise are to

- Increase human knowledge of nature's processes using the space environment,
- Explore and settle the Solar System,
- Achieve routine space travel,
- Enrich life on Earth through people living and working in space.

Microgravity research will contribute to the areas of cryogenic fuel management, spacecraft systems, in-situ resource utilization, power generation and storage, life support, fire safety, space structures, and science exploration.

### *Elemental Percent Weight on Earth and Moon*

	<i>Earth's Crust</i>	<i>Lunar Highland Soils</i>
<i>O</i>	47	45
<i>Fe</i>	5	5
<i>Si</i>	28	21
<i>Mg</i>	2	4
<i>Ca</i>	4	11
<i>Al</i>	8	13
<i>Na</i>	3	0
<i>K</i>	3	0

There is one endeavor for which microgravity research is essential. That is the goal of exploring new frontiers of space and using the Moon and Mars as stepping stones on our journey. To achieve these goals, we must design effective life support systems, habitation structures, and transportation vehicles. To come up with workable designs, we must have a thorough understanding of how the liquids and gases that we need to sustain human, plant, and animal life can be obtained, transported, and maintained; of how structural materials can be formed in-situ (on site); and of what types of fuels and fuel delivery systems would allow us to get around most efficiently. Microgravity research can provide the insight needed to get us on our way.

The ability to use extraterrestrial resources is a key element in the exploration of the solar system. We believe that we can use the Moon as a research base to develop and improve processes for obtaining gases and water for human life support and plant growth; for creating building materials; and for producing propellants and other products for transportation and power generation. Oxygen extracted from lunar rocks and soils will be used for life support and liquid oxygen fuel. A byproduct of the extraction of oxygen from lunar minerals may be metals and semiconductors such as magnesium, iron, and silicon. Metals produced on the Moon and material mined from the surface will then be used for construction of habitats, successive processing plants, and solar cells.





Current research in the areas of microgravity science will guide our path as we develop the means to use the Moon as a stepping stone to Mars. Research into how granular materials behave under reduced gravity conditions will be important when we design equipment to mine and move large amounts of lunar material. The ability to extract gases and metals from minerals requires an understanding of how gases, liquids, and solids of different densities interact in lunar gravity. Building blocks for habitats and other structures can be made from the **lunar regolith**. Research into sedimentation and sintering under reduced gravity conditions will lead to appropriate manufacturing procedures. Experiments have already been performed on the Space Shuttle to determine how concrete and mortar mixes and cures in microgravity. An understanding of fluid flow and combustion processes is vital for all the materials and gas production facilities that will be used on the Moon and beyond.

#### Science Standards

- Δ □ Earth and Space Science
- Δ □ Physical Science

**Regolith** is a layer of powder-like dust and loose rock that rests on bedrock. In the case of the moon, fragmentation of surface rocks by meteorite bombardment created much of the regolith material.



# Microgravity Science Space Flights

Until the mid-20th century, gravity was an unavoidable aspect of research and technology. During the latter half of the century, the use of drop towers to reduce the effects of gravity became more prevalent, although the extremely short periods of time they provided (<6 seconds) severely restricted the type of research that could be performed.

Initial microgravity research centered around solving space flight problems created by the reduction in gravity's effects experienced on orbit. How do you get the proper amount of fuel to a rocket engine in space or water to an astronaut on a spacewalk? The brief periods of microgravity available in drop towers at the Lewis Research Center and the Marshall Space Flight Center were sufficient to answer these basic questions and to develop the pressurized systems and other new technologies needed to cope with this new environment. But, they still were not sufficient to investigate the host of other questions that were raised by having gravity as an experimental variable.

The first long-term opportunities to explore microgravity and conduct research relatively free of the effects of gravity came during the latter stages of NASA's first great era of discovery. The Apollo program presented scientists with the chance to test ideas for using the space environment for research in materials, fluid, and life sciences. The current NASA microgravity program had its beginning in experiments conducted in the later flights of Apollo, the Apollo-Soyuz Test Project, and onboard Skylab, America's first space station.



*Skylab, America's first space station.*

Preliminary microgravity experiments conducted during the 1970's were severely constrained, either by the relatively low power levels and space available on the Apollo spacecraft, or by the low number of flight opportunities provided to Skylab. These experiments, as simple as they were, provided new insights into the roles of fluid and heat flows in materials processing. Much of our understanding of the physics underlying semiconductor crystal growth, for example, can be traced back to research initiated on Skylab.

Since the early 1980's, NASA has sent crews and payloads into orbit on board the Space Shuttle. The Space Shuttle has given microgravity scientists an opportunity to bring their experiments to low-Earth orbit on a more regular basis. The Shuttle introduced significant new capabilities for microgravity research: larger, scientifically trained crews; a major increase in payload volume and mass and available power; and the return to Earth of all instruments, samples, and data. The Spacelab module, developed for the Shuttle by the European Space Agency, gives researchers a laboratory with enough power and volume to conduct a limited range of sophisticated microgravity experiments in space.

Use of the Shuttle for microgravity research began in 1982, on its third flight, and continues today on many missions. In fact, most Shuttle missions that aren't dedicated to microgravity research do carry microgravity experiments as secondary payloads.

The Spacelab-1 mission was launched in November 1983. The primary purpose of the mission was to test the operations of the complex Spacelab and its subsystems. The 71 microgravity experiments, conducted using instruments from the European Space Agency, produced many interesting and provocative results. One investigator used the travelling heater method to grow a crystal of gallium antimonide doped with tellurium (a compound useful for

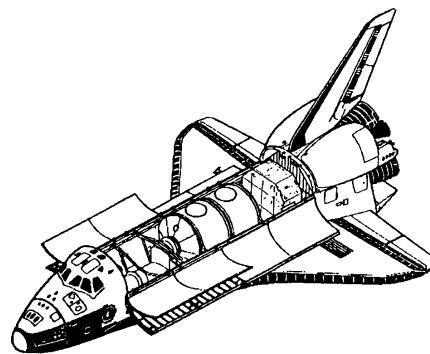

*The Spacelab module in the Orbiter Cargo Bay.*



making electronic devices). Due to the absence of gravity-driven convection, the space-grown crystal had a far more uniform distribution of tellurium than could be achieved on Earth. A second investigator used molten tin to study diffusion in low gravity- research that can improve our understanding of the solidification of molten metals.



*The first Spacelab mission dedicated to United States microgravity science on USML-I. The coast of Florida appears in the background.*

Another Shuttle mission using the Spacelab module was Spacelab-3, which flew in April 1985. SL-3 was the first mission to include U.S. developed microgravity research instruments in the Spacelab. One of these instruments supported an experiment to study the growth of crystals of mercury iodide—a material of significant interest for use as a sensitive detector of X-rays and gamma rays. Grown at a high rate for a relatively short time, the resulting crystal was as good as the best crystal grown in the Earth-based laboratory. Another U.S. experiment consisted of a series of tests on fluid behavior using a spherical test cell. The microgravity environment allowed the researcher to use the test cell to mimic the behavior of the atmosphere over a large part of Earth's surface. Results from this experiment were used to improve mathematical models of our atmosphere.

In October 1985, NASA launched a Spacelab mission sponsored by the Federal Republic of Germany, designated Spacelab-D1. American and German scientists conducted experiments to synthesize high quality semiconductor crystals useful in infrared detectors and lasers. These crystals had improved properties and were more uniform in composition than their Earth-grown counterparts. Researchers also successfully measured critical properties of molten alloys.

## **International Microgravity Laboratory-1, January 1992**

More than 220 scientists from the United States and 14 other countries contributed to the experiments flown on the first International Microgravity Laboratory (IML-1) in January 1992. Several biotechnology experiments concerned with protein crystal growth enabled NASA scientists to successfully test and compare two different crystal-growing devices.

A German device called the Cryostat produced superior-quality crystals of proteins from several microorganisms including the satellite tobacco mosaic virus (STMV), which has roles in diseases affecting more than 150 crop plants. As a result of this experiment, scientists now have a much clearer understanding of the overall structure of STMV. This information is useful in efforts to develop strategies for combating viral damage to crops.

IML-1 also carried experiments designed to probe how microgravity affects the internal structure of metal alloys as they solidify. The growth characteristics, determined from one of the experiments, matched the predictions of existing models, providing experimental evidence that current hypotheses about alloy formation are correct.



*Payload Commander Bonnie J. Dunbar and Payload Specialist Lawrence J. DeLucas working in the module on USML-1.*

## **United States Microgravity Laboratory-1, June 1992**

In June 1992 the first United States Microgravity Laboratory (USML-1) flew aboard a 14-day shuttle mission, the longest up to that time. This Spacelab-based mission was an important step in a long-term commitment to build a microgravity program involving government, academic, and industrial researchers.

The payload included 31 microgravity experiments using some facilities and instruments from previous flights, including the Protein Crystal Growth facility, a Space



Acceleration Measurement System, and the Solid Surface Combustion Experiment. New experiment facilities, all designed to be reusable on future missions, included the Crystal Growth Furnace (CGF), a Glovebox provided by the European Space Agency, the Surface Tension Driven Convection Experiment apparatus (STDCE), and the Drop Physics Module.

### Science Standards

- Δ □ Earth and Space Science
- Δ □ History and Nature Of Science
- Δ □ Physical Science
- Δ □ Unifying Concepts and Processes

#### Questions for Discussion

- What are Cd, Hg, Te, Zn?
- What do these elements have in common?

Hint: Look at their position on the periodic table of the elements.

Investigators used the CGF to grow crystals of four different semiconductor materials at temperatures as high as 1260°C. One space-grown **CdZnTe** crystal developed far fewer imperfections than even the best Earth-grown crystals, results that far exceeded pre-flight expectations. Thin crystals of **HgCdTe** grown from the vapor phase had mirror-smooth surfaces even at high magnifications. This type of surface was not observed on Earth-grown crystals.

Researchers used the STDCE apparatus to explore how internal movements of a liquid are created when there are spatial differences in temperature on the liquid's surface. The results are in close agreement with advanced theories and models that the experiment researchers developed.

In the Drop Physics Module, sound waves were used to position and manipulate liquid droplets. Surface tension controlled the shape of the droplets in ways that confirmed theoretical predictions. The dynamics of rotating drops of silicone oil also conformed to theoretical predictions. Experimental and theoretical results of this kind are significant because they illustrate an important part of the scientific method: hypotheses are formed and carefully planned experiments are conducted to test them.

Sixteen different investigations run by NASA researchers used the Glovebox, which provided a safe enclosed working area; it also was equipped with photographic equipment to provide a visual record of investigation operations. The Glovebox allowed crew members to perform protein crystallization studies as they would on Earth, including procedures that require

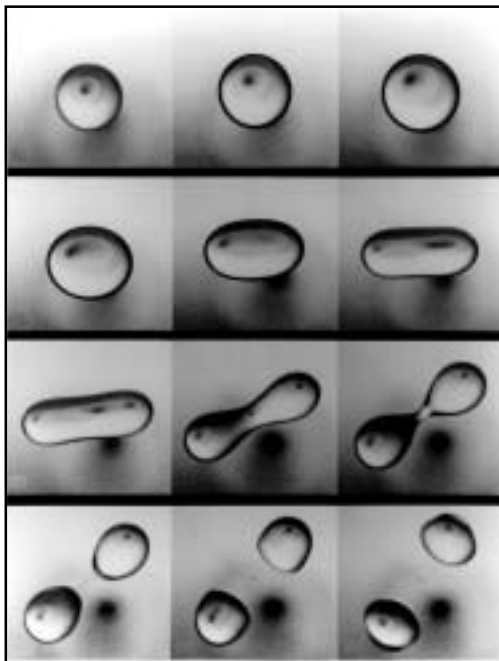

*Fission sequence of a rotating levitated drop.*



hands-on manipulation. Among other results, use of the Glovebox provided the best-ever crystals of malic enzyme that may be useful in developing anti-parasitic drugs.

The burning of small candles in the Glovebox provided new insights into how flames can exist in an environment in which there is no air flow. The results were similar (though much longer lived) to what can be seen by conducting similar experiments in freefall here on Earth. (See Candle Flames in Microgravity, in the Activities section of this guide.) The candles burned for about 45 to 60 seconds in the Glovebox experiments.

Another Glovebox investigation tested how wire insulation burns under different conditions, including in perfectly still air (no air flow) and in air flowing through the chamber from different directions. This research has yielded extremely important fundamental information and also has practical applications, including methods for further increasing fire safety aboard spacecraft.

The crew of scientist astronauts in the Spacelab played an important role in maximizing the science return from this mission. For instance, they attached a flexible type of glovebox, which provided an extra level of safety, to the Crystal Growth Furnace. The furnace was then opened, previously processed samples were removed and an additional sample was inserted. This enabled another three experiments to be conducted. Two other unprocessed samples were already in the furnace.

## **Spacelab-J, September 1992**

The Spacelab-J (SL-J) mission flew in September 1992. SL-J was the first Space Shuttle mission shared by NASA and Japan's National Space Development Agency (NASDA). NASA microgravity experiments focused on protein crystal growth and collecting acceleration data in support of the microgravity experiments.

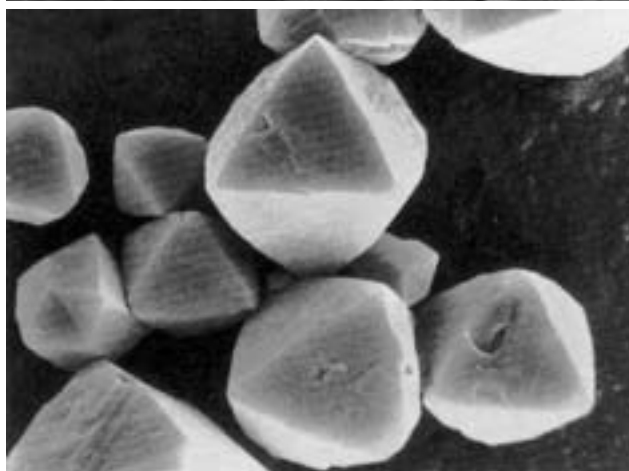
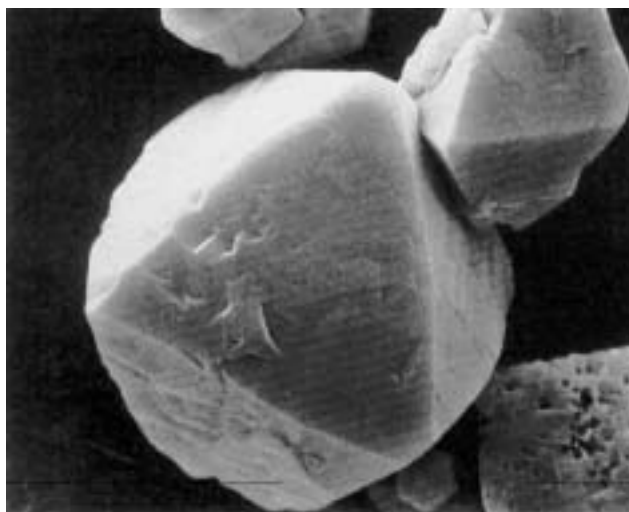

*Zeolite crystals can be grown in the Glovebox Facility. Shown here are photos (at the same scale) of zeolite crystals grown on USML-I (top) and on Earth (bottom).*



NASDA's science payload consisted of 22 experiments focused on materials science and the behavior of fluids, and 12 human biology experiments. NASDA also contributed two experiment facilities. One of these, the Large Isothermal Furnace, was used to explore how various aspects of processing affect the structure and properties of materials. The second apparatus was a Free-Flow Electrophoresis Unit used to separate different types of molecules in a fluid.

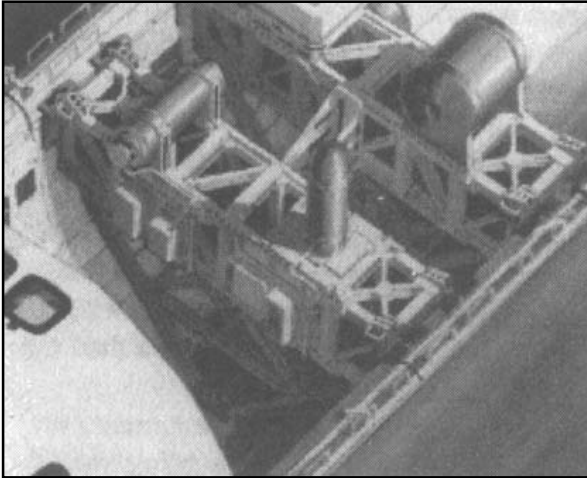

*USMP experiments are mounted on Mission Peculiar Equipment Support Structures in the Shuttle Cargo Bay.*

### **United States Microgravity Payload-1, October 1992**

The first United States Microgravity Payload (USMP-1) flew on a 10-day Space Shuttle mission launched on October 22, 1992. The mission was the first in an ongoing effort that employs telepresence to conduct experiments on a carrier in the Space Shuttle Cargo Bay. Telepresence refers to how microgravity experiments can be conducted by scientists on the ground using remote control.

The carrier in the Cargo Bay consisted of two Mission Peculiar Equipment Support Structures. On-board, the two Space Acceleration Measurement Systems measured how crew movements, equipment operation, and thruster firings affected the microgravity environment during the experiments. This information was relayed to scientists on the ground, who then correlated it with incoming experiment data.

A high point of USMP-1 was the first flight of MEPHISTO, a multi-mission collaboration between NASA-supported scientists and French researchers. MEPHISTO (designed and built by the French Space Agency, Centre National d'Etudes Spatiales or CNES) is designed to study the solidification process of molten metals and other substances. Three identical samples of one alloy (a combination of tin and bismuth) were solidified, melted, and resolidified more than 40 times, under slightly different conditions each time. As each cycle ended, data were transmitted

from the Space Shuttle to Marshall Space Flight Center. There, researchers analyzed the information in combination with data from the Space Acceleration Measurement System and sent back commands for adjustments. In all, the investigators relayed more than 5000 commands directly to their instruments on orbit. Researchers compared experiment data with the predictions of theoretical models and showed that mathematical models can predict important aspects of the experiment behavior. This first MEPHISTO effort proved that telescience projects can be carried out efficiently, with successful results.

The lambda point for liquid helium is the combination of temperature and pressure at which normal liquid helium changes to a superfluid. On Earth, effects of gravity make it virtually impossible to measure properties of substances very close to this point. On USMP-1, the Lambda Point Experiment cooled liquid helium to an extremely low temperature—a little more than 2 K above absolute zero. Investigators measured changes in its properties immediately before it changed from a normal fluid to a superfluid. Performing the test in microgravity yielded temperature measurements accurate to within a fraction of one billionth of a degree—several hundred times more accurate than would have been possible in normal gravity. Overall the new data were five times more accurate than in any previous experiment.

### **United States Microgravity Payload-2, March 1994**

The second United States Microgravity Payload (USMP-2) flew aboard the Space Shuttle Columbia for 14 days from March 4 to March 18, 1994. Building on the success of telescience in USMP-1, the Shuttle Cargo Bay carried four primary experiments which were controlled by approximately 10,000 commands relayed by scientists at Marshall Space Flight Center. USMP-2 also included two Space Acceleration Measurement Systems, which provided scientists



*Science and mission management teams monitor and control experiments from operations centers worldwide.*



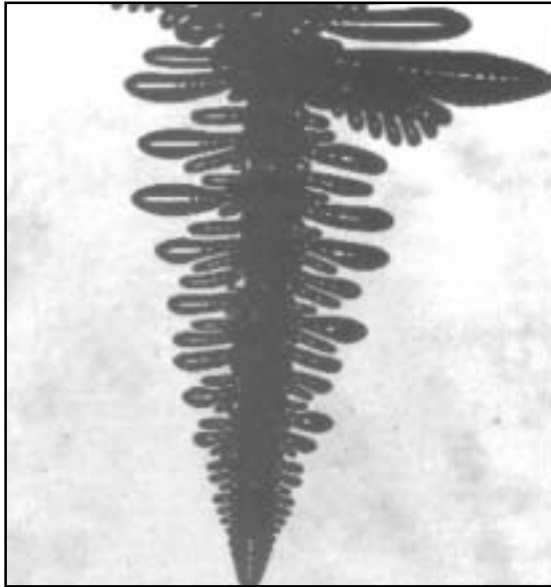

*A dendrite grown in the Isothermal Dendritic Growth Experiment aboard the USMP-2. This is an example of how most metals solidify.*

#### Science Standards

- Δ  Physical Science
- Δ  Unifying Concepts and Processes

**Dendrites** are branching structures that develop as a molten metal solidifies under certain conditions. The root of this word is the (Greek dendron, meaning tree. Branching structures in biology (nerve cells) and geology (drainage systems) are also referred to as being dendritic.

on the ground with nearly instant feedback on how various kinds of motion—including crew exercise and vibrations from thruster engines—affected mission experiments. The Orbital Acceleration Research Experiment in the Cargo Bay collected supplemental data on acceleration, providing an indication of the quasi-steady acceleration levels experienced by the experiments.

Throughout the mission, the Critical Fluid Light Scattering Experiment—nicknamed Zeno—analyzed the behavior of the element xenon as it fluctuated between two different states, liquid and gas. First, a chamber containing liquid xenon was heated. Then, laser beams were passed through the chamber as the xenon reached temperatures near this transition point. A series of measurements were taken of how the laser beams were scattered (deflected) as the xenon shifted from one state to another. Researchers expected that performing the experiment on orbit would provide more detailed information about how a substance changes phase than could be obtained on Earth. In fact, the results produced observations more than 100 times more precise than the best measurement on the ground.

The Isothermal Dendritic Growth Experiment (IDGE) examined the solidification of a material that is a well-established model for metals. This material is especially useful as a model because it is transparent, so a camera can actually record what happens inside a sample as it freezes. In 59 experiments conducted during 9 days, over 100 television images of growing **dendrites** were sent to the ground and examined by the research team. Dendritic growth velocities and tip radii of curvature were measured. Results obtained under certain experiment conditions were not consistent with current theory. This inconsistency was the subject of subsequent research on USMP-3. In another successful demonstration of telescience, the team relayed more than 200 commands to the IDGE, fine-tuning its operations.

USMP-2 also included a MEPHISTO experiment. On this mission, the MEPHISTO apparatus was used for U.S. experiments to test how gravity affects the formation of crystals from an alloy of bismuth and tin that behaves much like a semiconductor during crystal growth. Metallurgical analysis of the samples has shown that interactions between the molten and solid alloy during crystallization play a key role in controlling the final morphological stability of the alloy.

Another USMP-2 materials science experiment used the Advanced Automated Directional Solidification Furnace (AADSf). An eleven day experiment using the AADSf yielded a large, well-controlled sample of the alloy semiconductor, HgCdTe. The results of various analysis techniques performed on the crystal indicate that variations in the acceleration environment had a marked effect (due to changing residual fluid flow) on the final distribution of the alloy's components in the crystal.

### **International Microgravity Laboratory-2, July 1994**

The second International Microgravity Laboratory (IML-2), with a payload of 82 major experiments, flew in July 1994 on the longest Space Shuttle flight to that time. IML-2 truly was a world class venture, representing the work of scientists from the U.S. and 12 other countries.

Materials science experiments focused on various types of metals processing. One was sintering, a process that can combine different metals by applying heat and pressure to them. A series of three sintering experiments expanded the use in space of the Japanese built Large Isothermal Furnace, first flown on SL-J. It successfully sintered alloys of nickel, iron, and tungsten.

Other experiments explored the capabilities of a German-built facility called TEMPUS. It was designed to position molten metal experiment

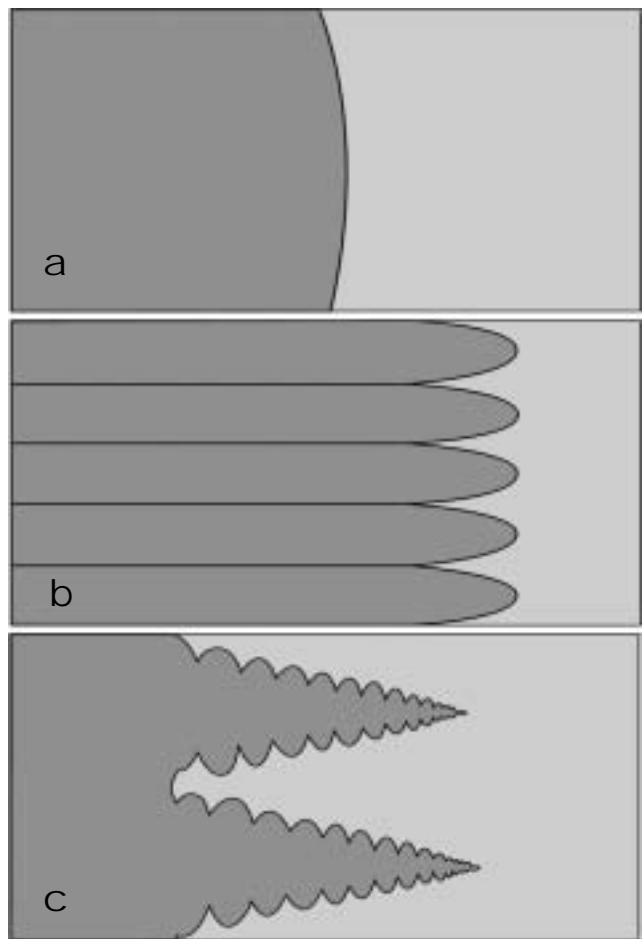

*Representations of different shapes of the liquid-solid interface in a solidifying material: a) planar; b) cellular; and c) dendritic. More information about interface morphology is provided in the Metals and Alloys discussion in the Materials Science section of this publication.*





samples (molten drops) away from the surfaces of a container in order to eliminate processing side effects of containers. Experiments of four U.S. scientists were successfully completed, and the research team developed improved procedures for managing multi-user facilities.

One of the experiments used a clever approach to measure two important thermophysical properties of molten metals. While a spherical drop of molten metal was positioned in a containerless manner it was momentarily distorted by using electromagnetic forces to squeeze it. When the squeezing was released, the droplet began to oscillate. The surface tension of the molten metal was determined from the frequency of the oscillation. The oscillation gradually decayed. The rate at which the decay occurred was used to determine the viscosity of the molten material.

Biotechnology experiments were performed using the Advanced Protein Crystallization Facility, developed by the European Space Agency. The facility's 48 growth chambers operated unattended throughout the flight, producing high-quality crystals of nine proteins. High-resolution video cameras monitored critical crystal growth experiments, providing the research team with a visual record of the processes. U.S. investigators used the Bubble, Drop, and Particle Unit to study how temperature **gradients** in the liquids influence the movement and shape of gas bubbles and liquid drops. The Critical Point Facility enabled researchers to study how a fluid behaves at its critical point. Research using the Critical Point Facility is applicable to a broad range of scientific questions, including how various characteristics of solids change under different experimental conditions.

#### Mathematics Standards

- Conceptual Underpinnings of Calculus
- Functions
- Δ  Mathematical Connections
- Δ  Patterns and Functions

#### Science Standards

- Δ  Earth and Space Science
- Δ  Physical Science
- Δ  Science and Technology
- Δ  Science in Personal and Social Perspectives
- Δ  Unifying Concepts and Processes

A **gradient** is the variation of a quantity such as temperature, pressure, or concentration with respect to a given parameter, typically distance. A temperature gradient can have dimensions of temperature per length, for example, °C/cm.

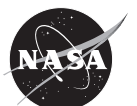



## United States Microgravity Laboratory-2, October 1995

The second United States Microgravity Laboratory (USML-2) launched on October 20, 1995 for a mission with more than 16 days on orbit. During that time microgravity research was conducted around-the-clock in the areas of biotechnology, combustion science, fluid physics, and materials science. It was a perfect example of interactive science in a unique laboratory environment.

Along with investigations that previously flew on USML-1, several additional experiment facilities flew on USML-2. Fourteen protein crystal growth experiments in the Advanced Protein Crystallization Facility had varied results that provided more insight into the structures of some of the proteins and into optimal experiment conditions. The goal of the Geophysical Fluid Flow Cell experiment was to study how fluids move in microgravity as a means of understanding fluid flow in oceans, atmospheres, planets, and stars. The results of the studies of fluid movement and velocity are still being analyzed.

Four separate studies were performed in the Crystal Growth Furnace (CGF). The goals of the experiments were to investigate quantitatively the gravitational influences on the growth and quality of the compound semiconductor, CdZnTe, using the seeded, modified Bridgman-Stockbarger crystal growth technique; to investigate techniques for uniformly distributing a **dopant**, selenium, during the growth of GaAs crystals; to understand the initial phase of the process of vapor crystal growth of complex, alloy-type semiconductors (HgCdTe); and to test the integration of a current induced interface demarcation capability into the CGF system and to assess the influences of a change in Shuttle attitude on a steady-state growth system using the demonstrated capabilities of the interface demarcation technique.

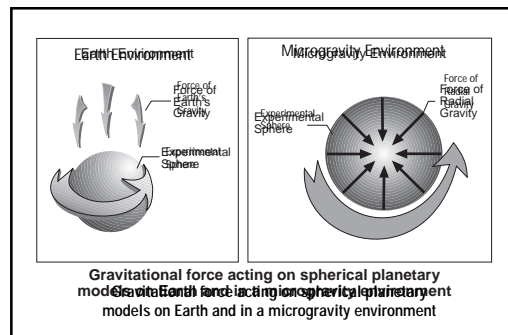

*In the Geophysical Fluid Flow Cell, electric charges, electrostatic force, and heaters are used to simulate buoyancy forces, radial gravity, and heating patterns in planetary atmospheres. As shown in the diagram, attempts to use spherical models on Earth are hampered by the force of Earth's gravity acting perpendicular to the sphere's rotation (indicated by the large curving arrow around the sphere's equator). In microgravity, this problem is removed.*

### Science Standards

- Δ  Physical Science
- Δ  Science and Technology
- Δ  Science in Personal and Social Perspectives
- Δ  Unifying Concepts and Processes

A **dopant** is an impurity intentionally added to a pure semiconductor to alter its electronic or optical properties.



## Science Standards

- Δ  Physical Science
- Δ  Science and Technology
- Δ  Science in Personal and Social Perspectives
- Δ  Unifying Concepts and Processes

A **surfactant** is a substance added to a liquid to change its surface tension. Surfactants are used in experiments where a liquid must wet its container in a particular way. A common use of surfactants is dishwashing detergent. The surfactant properties of the detergent is what causes food grease and oil to separate from most household dishware.

Two investigators had experiments conducted in the Drop Physics Module. The Science and Technology of Surface-Controlled Phenomena Experiments had three major goals: to determine the surface properties of liquids in the presence of **surfactants**; to investigate the dynamic behavior and the coalescence of droplets coated with surfactant materials; and to study the interactions between droplets and acoustic waves. The shapes of oscillating drops recorded on videotape were analyzed frame by frame, revealing the variations of the oscillation amplitude with time. The frequency and damping constant of the droplet shape oscillations were calculated. Analysis of the results is ongoing.

The goals of the Drop Dynamics Experiment were to gather high-quality data on the dynamics of liquid drops in microgravity for comparison with theoretical predictions and to provide scientific and technical information needed for the development of new fields, such as containerless processing of materials and polymer encapsulation of living cells. The experiments on the USML-2 mission included breaking one drop into two drops (bifurcation) and positioning a drop of one liquid at the center of a drop of a different liquid. Preliminary results show that the acoustic levitation technique has a strong influence on the drop bifurcation process.

Seven investigations were performed in the Glovebox on USML-2. These studies examined various aspects of fluid behavior, combustion, and crystal growth. Two separate devices were used for protein crystal growth experiments.

The Surface Tension Driven Convection Experiment investigated the basic fluid mechanics and heat transfer of thermocapillary flows generated by temperature variations along free surfaces of liquids in microgravity. It determined when and how oscillating flows were created. Preliminary analysis indicates that current theoretical models used to predict the onset of oscillations are consistent with the experiment results.



The USML-2 Zeolite Crystal Growth experiment attempted to establish a quantitative understanding of **zeolite** crystallization to allow control of both crystal defect concentration and crystallite size. The preliminary conclusions indicate that, with few exceptions, the crystals from USML-2 are larger in size than their Earth-grown counterparts and are twice as large as those grown on previous Shuttle flights. Analysis will continue to determine the effect of space processing on crystal defect concentration.

The projects that measured the microgravity environment added to the success of the mission by providing a complete picture of the Shuttle's environment and its disturbances. The Orbital Acceleration Research Experiment (OARE) provided real-time quasi-steady acceleration data to the science teams. The Microgravity Analysis Workstation (MAWS) operated closely with the OARE instrument, comparing the environment models produced by the MAWS with the actual data gathered by the OARE. Two other instruments, the Space Acceleration Measurement System and the Three Dimensional Microgravity Accelerometer, took g-jitter measurements throughout the mission. The Suppression of Transient Events by Levitation demonstrated a vibration isolation technology that may be suitable for experiments that are sensitive to variations in the microgravity environment.

## United States Microgravity Payload-3, February 1996

The third United States Microgravity Payload mission launched on February 22 for 16 days of research on orbit. During that time, microgravity research was conducted in the areas of combustion science, fluid physics, and materials science. The ultimate benefit of USMP-3 research will be improvements in products manufactured on Earth. During the eight and one-half days dedicated to microgravity science, researchers used telepresence to control materials processing and thermodynamic experiments in the Cargo Bay

### Science Standards

- Δ □ Physical Science
- Δ □ Science and Technology
- Δ □ Science in Personal and Social Perspectives
- Δ □ Unifying Concepts and Processes

**Zeolites** are hydrous aluminum silicate minerals which also contain cations of sodium, potassium, calcium, strontium, barium, or a synthetic compound. They are commonly used as molecular filters. For example, they are used to make every drop of gasoline sold in the United States.

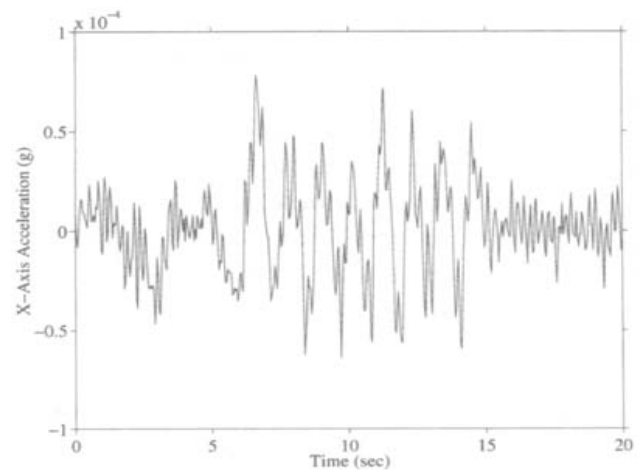

*The change in acceleration character seen in the middle of this plot is due to a crew member swinging an experiment container around to mix its contents. Examination of the plot indicates that the crew member swung his arm around seven to eight times in ten seconds.*



**Vibration Frequencies Commonly Seen in Orbiter Accelerometer Data**

<i>Freq. (Hz)</i>	<i>Disturbance Source</i>
0.43	cargo bay doors
3.5	Orbiter fuselage torsion
3.66	structural frequency of Orbiter
4.64	structural frequency of Orbiter
5.2	Orbiter fuselage normal bending
7.4	Orbiter fuselage lateral bending
17	Ku band antenna dither
20	experiment air circulation fan
22	refrigerator freezer compressor
38	experiment air circulation fan
39.8	experiment centrifuge rotation speed
43	experiment air circulation fan
48	experiment air circulation fan
53	experiment air circulation fan
60	refrigerator piston compressor
80	experiment water pump
166.7	Orbiter hydraulic circulation pump

and astronauts performed combustion studies in the Middeck Glovebox.

The MEPHISTO science team used flight-proven equipment to learn how the chemical composition of solidifying Sn-Bi alloys changes, and can be controlled, during solidification. Such knowledge applies to ground-based materials processing. For the first time, the changes in the microgravity environment caused by carefully planned Shuttle thruster firings were correlated with the effects of fluid flows in a growing crystal. With the help of data from the Space Acceleration Measurement System, the experiment data showed that with thruster accelerations parallel to the crystal-melt interface a large effect was noted, whereas when thruster accelerations were perpendicular to the interface there was little impact. Also, the MEPHISTO team successfully monitored the point at which their sample's crystal interface underwent a key change—from flat to cellular (like three dimensional ripples)—as it solidified. Measurements from the MEPHISTO facility will now be analyzed, along with the final metallic samples, in order to increase our understanding of subtle changes that occurred during the samples' solidification and subsequent cooling.

In the Advanced Automated Directional Solidification Furnace, three lead tin telluride (PbSnTe) crystals were grown while Columbia orbited in three different attitudes, to determine how these orientations affect crystal growth. This knowledge is expected to help researchers develop processes, and semiconductor materials that perform better and cost less to produce.

The Isothermal Dendritic Growth Experiment (IDGE) on USMP-3 achieved its mission objectives. After collecting data to answer some of the questions opened by the USMP-2 results, research has shown that the small variations in dendritic growth rates (how fast the tree-like solid pattern in a molten metal forms) measured in microgravity on the Space Shuttle are not due to variations in the microgravity environment on



orbit. The investigators are currently completing measurements on the three-dimensional shape of these dendritic tips, which will further advance the empirical basis from which more accurate solidification models are being developed and tested. This is an early step in what will ultimately be solidification models that could be used to make less expensive and more reliable cast or welded metal and alloy products.

The IDGE team also participated in an important technology demonstration by commanding a microgravity space instrument from a remote site located at the Rensselaer Polytechnic Institute. This first-ever remote commanding to the Shuttle from a U.S. university campus foreshadows operations aboard the International Space Station.

Investigators for the Critical Fluid Light Scattering Experiment were successful in observing, with unprecedented clarity, xenon's critical point behavior—the precise temperature and pressure at which it exists as both a gas and a liquid. The transparent xenon sample displayed the unusual critical point condition, with maximum light scattering followed by a sudden increase in cloudiness. This effect was much more distinctive than observed during the USMP-2 mission and happened at a lower temperature than expected. Knowledge gained from this experiment will prove valuable for applications from liquid crystals to superconductors.

This mission was the first flight of a Glovebox facility in the Middeck section of the Shuttle. Three combustion science investigations were conducted by the crew. The Forced Flow Flamespreading Test burned 16 paper samples, both flat and cylindrical. Video of the cylindrical samples showed significant differences in flame size, growth rate, and color with variations in air flow speed and fuel temperature. The Comparative Soot Diagnostics investigation completed 25 combustion experiment runs. The



*As we move toward the era of the International Space Station, more experiment monitoring and control is being performed from NASA centers and university laboratories “remote” from Marshall Space Flight Center and Johnson Space Center.*



*Glovebox Investigation Module hardware.*







*The Space Shuttle Columbia, carrying the Life and Microgravity Spacelab, launched from Kennedy Space Center June 20, 1996.*

team obtained excellent results, testing the effectiveness of two different smoke-sensing techniques, for detecting fires aboard the Shuttle and the International Space Station. The Radiative Ignition and Transition to Spread Investigation team observed new combustion phenomena, such as tunneling flames which move along a narrow path instead of fanning out from the burn site. Also, for the first time, these investigators studied the effects of sample edges and corners on fire spreading in microgravity.

### **Life and Microgravity Spacelab, June 1996**

The Life and Microgravity Spacelab mission successfully completed a 17 day flight on July 6, 1996. For this mission there was an unprecedented distribution of teams monitoring their experiments around the world, with experiment commanding performed from three sites.

A number of researchers conducted experiments using the Advanced Gradient Heating Facility (AGHF) from the European Space Agency. Three aluminum-indium alloys were directionally solidified to study the physics of solidification processes in immiscible alloys called monotectics. The three samples, which differed only in indium content, were processed at the same growth rate to permit a comparison of microstructures, how the indium was distributed in the aluminum matrix. Two of these samples were of compositions which cannot be processed under steady state conditions on Earth due to gravitationally-driven convective instabilities and subsequent sedimentation of the liquid indium.

Another AGHF experiment used commercial Al-based samples to obtain insight into the mechanism of particle redistribution during solidification. Additional studies were geared toward enhancement of the fundamental understanding of the dynamics of insoluble particles at solid/liquid interfaces. The physics of the problem is of direct relevance to such areas as solidification of metal matrix composites,



management of defects such as inclusions and porosity in metal castings, development of high temperature superconductor crystals with superior current carrying capacity, and the solidification of monotectics.

A series of experiments was performed in the Advanced Protein Crystallization Facility. The experiments were generally successful in terms of yielding crystals. Those crystals which showed particular promise, based on early microscopic examination, were ferritin, satellite tobacco mosaic virus, satellite panicum mosaic virus, lysozyme, and canavalin.

Several experiments were conducted using the Bubble, Drop and Particle Unit (BDPU) from the European Space Agency. In one experiment, the transition to periodic and chaotic convection was detected. The results of this experiment will trigger ground based research on the nonlinear dynamics of convecto-diffusive systems. In another experiment, thermocapillary flows in two and three layer systems were observed for five temperature gradients. The results of this experiment will improve our understanding of heat and mass transfer in other fluid physics research.

An additional experiment studied the interaction between pre-formed gas bubbles inside a solid and a moving solid/liquid interface, obtained by heating an initially solid sample. Early results concerning the release of bubbles from the melting front indicate that once a hole has been made and the gas inside the bubble contacts the liquid then the liquid enters the cavity (by wetting the solid walls) and pushes out the gas inside the bubble.

The scientific results of one set of BDPU experiments provide us with new insights into bubble dynamics and into evaporation. This will lead to a better understanding and modeling of steam generation and boiling. Initial findings of another experiment showed that, under

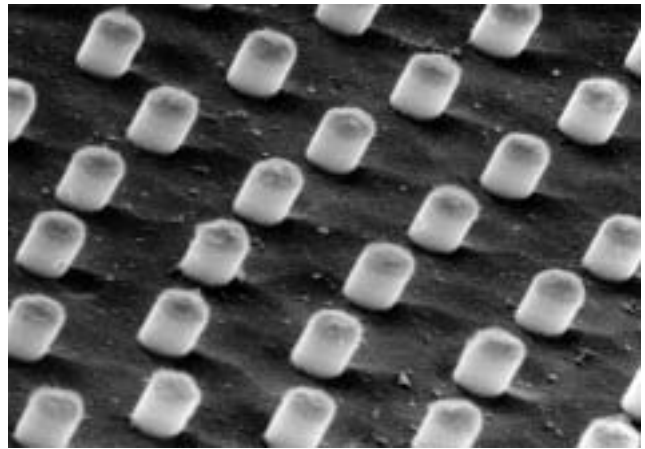

*Magnification of a sample of an aluminum-indium alloy. When the sample is melted then controllably solidifies in the AGHF; the indium forms in cylindrical fibers within a solid aluminum matrix.*



microgravity conditions, boiling heat transfer is still as efficient as under normal Earth gravity. In contrast to the existing theory the findings show that the influence of Earth gravity is less than predicted. The heat transfer in a microgravity environment is still as efficient, sometimes even more efficient than, at normal gravity.

Real-time Orbital Acceleration Research Experiment data were used by the science teams to monitor the microgravity environment during their experiment operations. The effects of mission activities, such as venting of unneeded water and Orbiter orientation changes, were presented to help the science teams understand the environment in which their experiments operated. The Microgravity Measurement Assembly (MMA) used this mission to verify a new system, augmented by a newly developed accelerometer for measuring the quasi-steady range. MMA provided real-time quasi-steady and g-jitter data to the science teams during the mission.

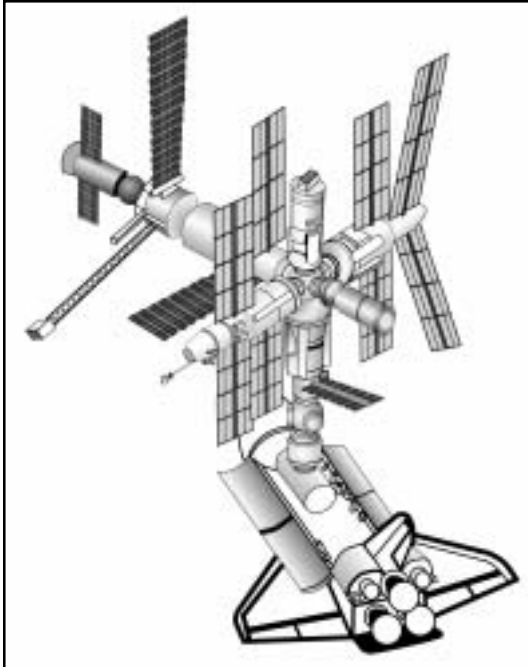

*Schematic diagram of Space Shuttle Orbiter docked to Mir.*

### **Shuttle/Mir Science Program, March 1995 to May 1998**

Although competition in the space program has existed between the United States and Russia for some time, there has also been a rich history of cooperation that has grown into the highly successful joint science program that it is today. One part of that program is geared towards microgravity research.

Many of the investigations from that program are configured to run in a Glovebox facility that has been installed in the Priroda research module of the Mir Space Station. The Microgravity Isolation Mount (MIM) is also located in Priroda. The MIM was developed by the Canadian Space Agency to isolate experiments attached to it from ongoing g-jitter. The MIM is also able to induce defined vibrations so that the effects of specific disturbances on experiments can be studied. Additional experiments are being performed in individual experiment facilities that have been placed in the Priroda and other Mir modules.

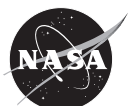

Various protein crystal growth experiments use the Gaseous Nitrogen Dewar (GN2 Dewar). Samples are placed in the GN2 Dewar and it is charged with liquid nitrogen, freezing them. The system is designed so that the life of the nitrogen charge lasts long enough to get the payload launched and into orbit. As the system absorbs heat, the nitrogen boils away and the chamber approaches ambient temperature. As the samples thaw, crystals start growing in the Dewar. The crystals are allowed to form throughout the long duration mission and are returned to Earth for analysis. Initial investigations using the Dewar served as a proof of concept for the experiment facility. Successive experiment runs using different samples will continue to improve our knowledge of protein crystal structures.

The Diffusion-Controlled Crystallization Apparatus for Microgravity experiment is designed primarily for the growth of protein crystals in a microgravity environment. It uses the liquid/liquid and dialysis methods in which a precipitant solution diffuses into a bulk solution. In the experiment, a small protein sample is covered by a semipermeable membrane that allows the precipitant solution to pass into the protein solution to initiate the crystallization process. Diffusion starts on Earth as soon as the chambers are filled. However, the rate is so slow that no appreciable change occurs before the samples reach orbit one or two days later. Such an apparatus is ideally suited for the long duration Mir missions.

The Cartilage in Space—Biotechnology System experiment began with cell cultures being transported to Mir by the Shuttle in September 1996 on mission STS-79. The investigation is a test bed for the growth, maintenance, and study of long-term on-orbit cell growth in microgravity. The experiment investigates cell attachment patterns and interactions among cell cultures as well as cellular growth and the cellular role in forming functional tissue.

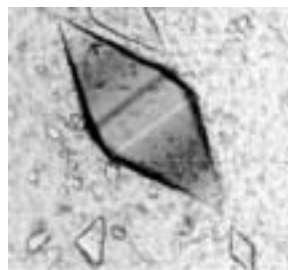

*Thaumatin*

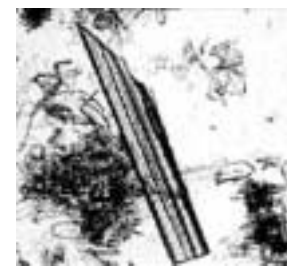

*Alpha Amylase*



*Creatine Kinase*

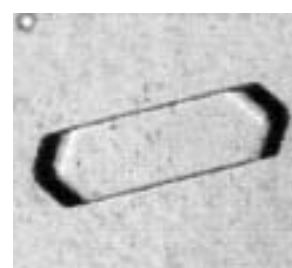

*STMV*



*Ribonuclease*



*Rhombohedral Canavalin*

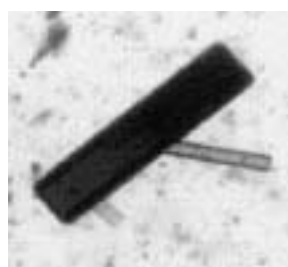

*Myoglobin*



*Hemoglobin*

*Protein and virus crystals grown in the GN2 Dewar on Mir.*





*The Biotechnology System-Cartilage in Space Experiment in orbit. Top: Astronauts Carl Walz (left) and Jay Apt prepare the experiment for transfer from the middeck of the Space Shuttle Atlantis to the Priroda module of Mir Bottom: Walz and Apt test the bioreactor media for pH, carbon dioxide, and oxygen levels.*

The Candle Flames in Microgravity investigation conducted 79 candle tests in the Glovebox in July 1996. The experiments explored whether wick flames (candles) can be sustained in a purely diffusive environment or in the presence of a very slow, sub-buoyant convective flow. An associated goal was to determine the effect of wick size and candle size on burning rate, flame shape and color, and to study interactions between two closely spaced diffusion flames. Preliminary data indicate long-term survivability with evidence of spontaneous and prolonged flame oscillations near extinction (when the candle goes out).

The Forced Flow Flame Spreading Tests ran in the Glovebox in early August 1996. The investigations studied flames spreading over solid fuels in low-speed air flows in microgravity. The effects of varying fuel thickness and flow velocity of flames spreading in a miniature low-speed wind tunnel were observed. The data are currently being analyzed and compared to theoretical predictions of flame spreading. The numerical model predicted that the flame would spread at a steady rate and would not experience changes in speed, shape, size, or temperature.

The Interface Configuration Experiment Glovebox investigation studied how a liquid with a free surface in contact with a container behaves in microgravity. This provides a basis for predicting the locations and configurations of fluids with the use of mathematical models. The data are currently being analyzed.

The Technological Evaluation of the MIM (TEM) was a technology demonstration to determine the capabilities of the MIM. Through observations of liquid surface oscillations, TEM evaluated the ability of the MIM to impart controlled motions. The data are still being analyzed. A follow-on technology demonstration (TEM-2) was transferred to Mir in September 1996.



The Binary Colloidal Alloy Test Glovebox investigation was also launched to Mir on STS-79 in September 1996. The objective is to conduct fundamental studies of the formation of gels and crystals from binary colloid mixtures.

The Angular Liquid Bridge and Opposed Flow Flame Spread Glovebox investigations were carried to Mir by the Shuttle on mission STS-81 in early 1997. The former is an extension of previous fluid physics investigations conducted on the Shuttle and Mir and studies the behavior and shape of liquid bridges, liquid that spans the distance between two solid surfaces. The objective of the latter is to extend the understanding of the mechanisms by which flames spread, or fail to spread, over solid fuel surfaces in the presence of an opposing oxidizer flow.

A Space Acceleration Measurement System (SAMS) unit was launched to Mir on a Progress rocket in August 1994. Starting in October 1994, the SAMS was used to measure and characterize the microgravity environment of various Mir modules in support of microgravity experiments. Between October 1994 and September 1996, SAMS collected about sixty gigabytes of acceleration data. The data have been used to identify common vibration sources, as has been done with the Shuttles. This information has helped experimenters plan the timing and location of their experiments. The Passive Accelerometer System is a simple tool that is being used to estimate the quasi-steady microgravity environment of Mir during the increment between STS-79 and STS-81. The motion of a steel ball in a water-filled glass tube is tracked and the distance travelled over time is used to estimate accelerations caused by atmospheric drag and the location of the tube with respect to Mir's center of gravity.

**Vibration Frequencies Commonly Seen in Mir Accelerometer Data**

<i>Freq. (Hz)</i>	<i>Disturbance Source</i>
0.6	Kristall structural mode
1.0	Kristall structural mode
1.1	structural mode
1.2	structural mode
1.3	Kristall structural mode
1.9	Kristall structural mode
2.75	structural mode
3.75	structural mode
15	air quality system
24.1	humidifier/dehumidifier
30	air quality system harmonic
41	fan
43.5	fan
45	air quality system harmonic
90	air quality system harmonic
166.6	gyrodyne (system used to maintain Mir orientation)





*This illustration depicts the International Space Station in its completed and fully operational state with elements from the United States, Europe, Canada, Japan, and Russia.*

# Future Directions

Microgravity science has come a long way since the early days of space flight when researchers realized that they might be able to take advantage of the reduced gravity environment of orbiting spacecraft to study different phenomena. Shuttle and Mir based experiments that study biotechnology, combustion science, fluid physics, fundamental physics, and materials science have opened the doors to a better understanding of many of the basic scientific principles that drive much of what we do on Earth and in space.

To reach the next level of understanding about phenomena in a microgravity environment, we need to perform experiments for longer periods of time, to be able to conduct a series of experiments as is done on Earth, and to have improved environmental conditions. The International Space Station is being developed as a microgravity research platform. Considerable attention has been given to the design of the station and experiment facility components so that experiments can be performed under high-quality microgravity conditions. The International Space Station will provide researchers with continuous, controlled microgravity conditions for up to thirty days at a time. (The time in between these thirty day increments is used for vibration-intensive activities such as Shuttle dockings, station reconfiguration, and upkeep.) This is almost twice as long as the microgravity periods available on the Space Shuttle and there will be a better environment than that provided by Mir. This increase in experiment time and improvement in conditions will be conducive to improved understanding of microgravity phenomena.

Continued microgravity research on the Shuttles, Mir, and on the International Space Station will lead to, among other things, the design of

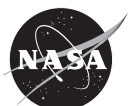



improved drugs, fire protection and detection systems, spacecraft systems, high-precision clocks, and semiconductor materials. In addition, this research will allow us to create outposts on the Moon where we can build habitats and research facilities. The end result of research in microgravity and on the Moon will be the increased knowledge base necessary for our trips to and exploration of Mars.



# Glossary

**Acceleration**—The rate at which an object's velocity changes with time.

**Altitude**—Height above Earth's mean sea level.

**Apparent Weight**—The net sum of all forces acting on a body is its apparent weight.

**Biotechnology**—Any technique that involves the research, manipulation, and manufacturing of biological molecules, tissues, and living organisms to improve or obtain products, or perform specific functions.

**Buoyancy**—Driven Convection Convection created by the difference in density between two or more fluids in a gravitational field.

**Capillarity**—The attraction a liquid has for itself versus the attraction it has for a solid surface, such as the liquid's container.

**Combustion Science**—The study of the process of burning.

**Concave**—Curved inward like the inner surface of a sphere.

**Convection**—Energy and/or mass transfer in a fluid by means of bulk motion of the fluid .

**Convex**—Curved like the outer surface of a sphere.

**Critical Point**—The temperature at which the differences between liquids and gases disappear. Above that temperature, the liquid smoothly transforms to the gaseous state; boiling disappears.

**Dendrites**—Branching structures that develop as a molten metal solidifies under certain conditions.

**Density**—The mass of a body divided by its volume (average density).

**Differentiation**—The process by which cells and/or tissues undergo a progressive specialization of form or function.

**Diffusion**—Intermixing of atoms and/or molecules in solids, liquids, and gases due to a difference in composition.

**Dopant**—An impurity intentionally added to a pure semiconductor to alter its electronic or optical properties.

**Drop Facility**—Research facility that creates a microgravity environment by permitting experiments to freefall through an enclosed vertical tube.

**Fluid**—Anything that flows (liquid or gas).

**Fluid Physics**—The study of the properties and motions of liquids, gases, and fluid-like solids.

**Force**—An action exerted upon a body in order to change its state, either of rest, or of uniform motion in a straight line.

**Freefall**—Falling in a gravitational field where the acceleration is the same as that due to gravity alone.

**Fundamental Physics**—The study of several physics subfields, including studies where interaction forces are weak, where extremely uniform samples are required, where objects must be freely suspended and their acceleration must be minimized, and where mechanical disturbances that are unavoidably present in Earth-bound laboratories must be eliminated.



**G**–Universal Gravitational Constant ( $6.67 \times 10^{-11}$  N m<sup>2</sup>/kg<sup>2</sup>)

**g**–The acceleration Earth’s gravitational field exerts on objects at Earth’s surface (approximately 9.8 meters per second squared).

**g-jitter**–The vibrations experienced by microgravity experiments (for example on parabolic aircraft and the Space Shuttle) that cause effects similar to those that would be caused by a time-varying gravitational field.

**Gradient**–The variation of a quantity such as temperature with respect to a given parameter, typically distance, °C/cm.

**Gravitation**–The attraction of objects due to their masses.

**Homogeneous**–Uniform in structure and/or composition.

**Immiscible**–The situation where two or more liquids do not mix chemically.

**Inertia**–A property of matter that causes it to resist changes in velocity.

**Joule Heating**–Heating a material by flowing an electric current through it.

**Law of Universal Gravitation**–A law stating that every mass in the universe attracts every other mass with a force proportional to the product of their masses and inversely proportional to the square of the distances between their centers.

**Materials Science**–The study of developing quantitative and predictive relationships between the processing, structure, and properties of materials.

**Microgravity ( $\mu g$ )**–An environment in which the apparent weight of a system is small compared to its actual weight (due to gravity).

**Morphology**–The form and structure of an object.

**Nucleus**–A source upon which something, such as a crystal, grows or develops.

**Quasi-steady Acceleration**–Accelerations in spacecraft related to the position in the spacecraft, aerodynamic drag, and vehicle rotation.

**Regolith**–A layer of powder-like dust and loose rock that rests on bedrock. In the case of the moon, fragmentation of surface rocks by meteorite bombardment created much of the regolith material.

**Rheology**–The scientific study of the deformation and flow of matter.

**Satellite**–A natural or man-made object that orbits a celestial body.

**Semiconductor**–A substance, such as germanium and silicon, that is a poor electrical conductor at room temperature but is improved by minute additions of certain substances (dopants) or by the application of heat, light, or voltage; a material with a forbidden energy gap less than 3 eV.



**Skylab**—NASA's first orbital laboratory that was operated in 1973 and 1974.

**Spacelab**—A scientific laboratory developed by the European Space Agency that is carried into Earth orbit in the Space Shuttle's payload bay.

**Speed**—The magnitude of velocity.

**Surfactant**—A substance added to a liquid to change its surface tension.

**Velocity**—The rate at which the position of an object changes with time; it is a vector quantity.

**Weight**—The weight of an object is the gravitational force exerted on it by Earth.



# Activities

Activity Matrix .....	76
Microgravity In The Classroom .....	79
Accelerometers .....	88
Around The World .....	95
Inertial Balance .....	101
Gravity-Driven Fluid Flow .....	109
SurfaceTension-Driven Flows .....	114
Temperature Effects on Surface Tension .....	119
Candle Flames .....	124
Candle Flames in Microgravity .....	129
Crystallization Model .....	135
Crystal Growth and Buoyancy-Driven Convection Currents .....	141
Rapid Crystallization .....	148
Microscopic Observation of Crystal Growth .....	152
Zeolite Grystal Growth .....	159







# Mathematics Standards

	Problem Solving	Communication	Reasoning	Connections	Number & Number Relationships	Computation & Estimation	Patterns & Functions	Statistics	Probability	Geometry
<b>Microgravity In The Classroom</b>										
<b>Accelerometers</b>					■					■
<b>Around The World</b>	■				■	■				■
<b>Inertial Balance</b>		■						■		
<b>Gravity-Driven Fluid Flow</b>		■			■	■				■
<b>Surface Tension-Driven Flows</b>										
<b>Temp. Effects on Surface.....</b>										
<b>Candle Flames</b>									■	
<b>Candle Flames in Microgravity</b>										
<b>Crystallization Model</b>										
<b>Crystal Growth and Buoy.....</b>									■	
<b>Rapid Crystallization</b>		■							■	
<b>Microscopic Observation of....</b>										
<b>Zeolite Crystal Growth</b>									■	



# Microgravity In The Classroom

## Objective:

- To demonstrate how microgravity is created by freefall.

## Science Standards:

- Science as Inquiry  
 Physical Science  
 - position and motion of objects  
 Change, Constancy, & Measurement  
 - evidence, models, & exploration

## Science Process Skills:

- Observing  
 Communicating  
 Making Models  
 Defining Operationally  
 Investigating  
 Predicting  
 Mathematics Standards:  
 Computation & Estimation  
 Measurement

## Activity Management:

This activity consists of three demonstrations that create microgravity conditions by freefall. Although the first demonstration is best done by the teacher, the other demonstrations can be done as activities by students working in groups of three or four.

Each demonstration requires a clear space where drop tests can be conducted. Two of the demonstrations require water and you should have a mop, sponges, or paper towels available to clean up any mistakes.

Begin with the Falling Weight apparatus teacher demonstration. Before dropping the device, conduct a discussion with the students to consider possible outcomes. Ask students to predict what they think will happen when the device is dropped. Students will focus on the proximity of the balloon and the needle.

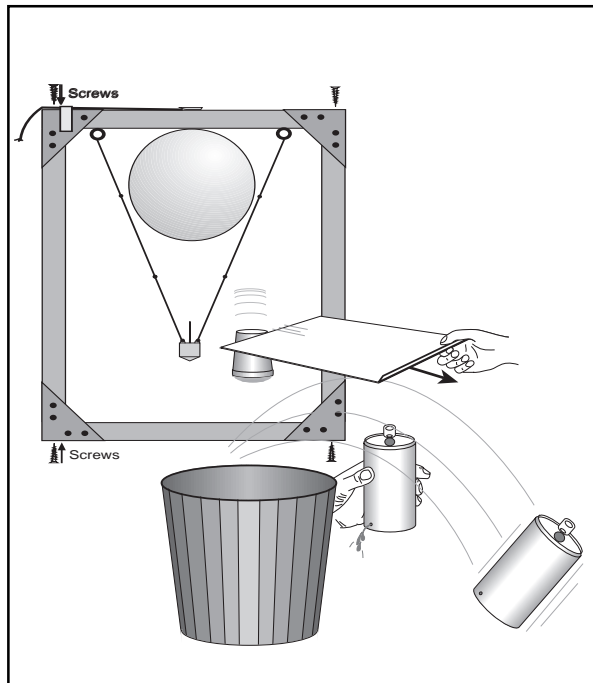

Various objects demonstrate microgravity as they are dropped.

## MATERIALS AND TOOLS

- Falling weight apparatus (see special instructions)
- Plastic cup
- Small cookie sheet or plastic cutting board
- Empty soft drink can
- Nail or some other punch
- Catch basin - plastic dish pan, bucket, large waste barrel
- Mop, paper towels, or sponges for cleanup

Will the balloon break when the device is dropped? If the balloon does break, will it break immediately or when the device hits the floor? Try to get students with different predictions to debate each other. After the debate, drop the device.



Be sure to hold the wooden frame by the middle of the top cross piece. Hold it out at arm's length in case the weight and needle bounce your way.

Discuss the demonstration to make sure the students understand why the balloon popped when it did. Before trying any of the other demonstrations, student groups should read the student reader entitled *Microgravity*.

The second and third demonstrations can also be done by the teacher or by small groups of students. One student drops or tosses the test item and the other students observe what happens. Students should take turns observing.

### **Assessment:**

Have students write a paragraph or two that define microgravity and explain how freefall creates it.

### **Extensions:**

1. Videotape the demonstrations and play back the tape a frame at a time. Since each second of videotape consists of 30 frames, the tape can be used as a simple timing device. Count each frame as onethirtieth of a second.
2. Replace the rubber bands in the falling weight apparatus with heavy string and drop the apparatus again to see whether the balloon will break. Compare the results of the two drops.
3. Conduct a microgravity science field trip to an amusement park that has roller coasters and other rides that involve quick drops. Get permission for the students to carry accelerometers on the rides to study the gravity environments they experience. On a typical rollercoaster ride, passengers experience normal  $g$  (gravity), microgravity, high  $g$ , and negative  $g$ .



# Microgravity

Gravity is an attractive force that all objects have for one another. It doesn't matter whether the object is a planet, a cannonball, a feather, or a person. Each exerts a gravitational force on all other objects around it.

The amount of force between two objects depends upon how much mass each contains and the distance between their centers of mass. For example, an apple hanging from a tree branch will have less gravitational force acting on it than when it has fallen to the ground. The reason for this is because the center of mass of an apple, when it is hanging from a tree branch, is farther from the center of mass of Earth than when lying on the ground.

Although gravity is a force that is always with us, its effects can be greatly reduced by the simple act of falling. NASA calls the condition produced by falling *microgravity*.

You can get an idea of how microgravity is created by looking at the diagram below. Imagine riding in an elevator to the top floor of a very tall building. At the top, the cables supporting the car break, causing the car and you to fall to the ground. (In this example, we discount the effects of air friction on the falling car.) Since you and the elevator car are falling together, you feel like you are floating inside the car. In other words, you and the elevator car are accelerating downward at the same rate due to gravity alone. If a scale were present, your weight would not register because

the scale would be falling too. The ride is lots of fun until you get to the bottom.

NASA uses several different strategies for conducting microgravity research. Each strategy serves a different purpose and produces a microgravity environment with different qualities. One of the simplest strategies is the use of drop towers. A drop tower is like a high-tech elevator shaft. A small experiment package is suspended from a latch at the top. The package contains the experiment, television or movie cameras, and a radio or wire to transmit data during the test. For some drop towers, when the test is ready, air from the shaft is pumped out so

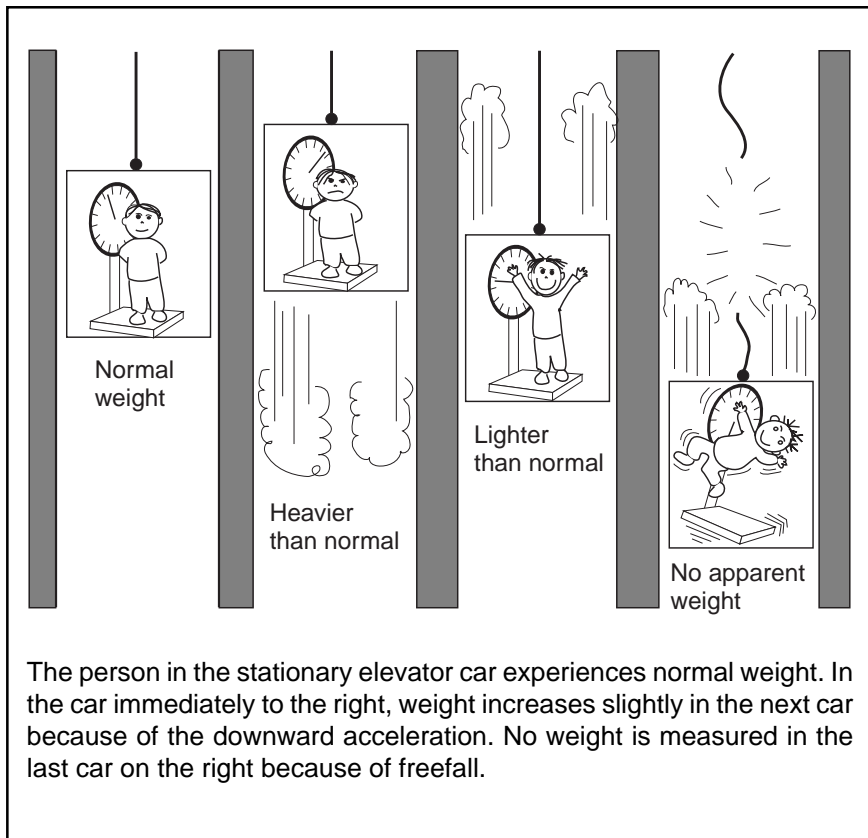

the package will fall more smoothly. The cameras, recording equipment, and data transmitter are turned on as a short countdown commences. When T minus zero is reached, the package is dropped.

NASA has several drop tower facilities including the 145 meter drop tower at the NASA Lewis Research Center in Cleveland, Ohio. The shaft is 6.1 meters in diameter and packages fall 132 meters down to a catch basin near the shaft's bottom. For 5.2 seconds, the experiment

One of the advantages of using an airplane to do microgravity research is that experimenters can ride along with their experiments. A typical flight lasts 2 to 3 hours and carries experiments and crew members to a beginning altitude about 7 kilometers above sea level. The plane climbs rapidly at a 45-degree angle (pull up) and follows a path called a parabola. At about 10 kilometers high, the plane starts descending at a 45-degree angle back down to 7 kilometers where it levels out (pull out). During the pull up and pull out segments, crew and experiments experience a force of between 2 g and 2.5 g. The microgravity experienced on the flight ranges between one one-hundredth and one one-thousandth of a g. On a typical flight, 40 parabolic trajectories are flown. The gut-wrenching sensations produced on the flight have earned the plane the nickname of "Vomit Comet."

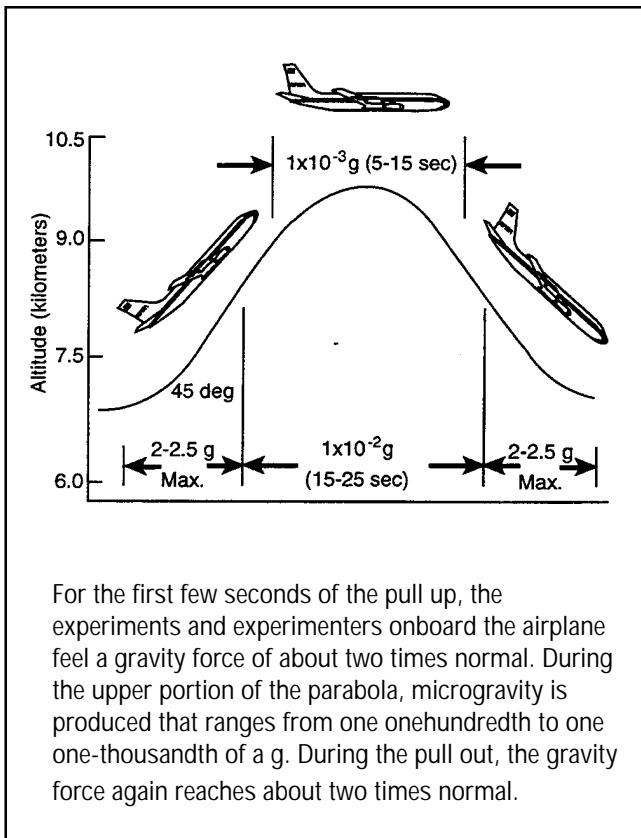

experiences a microgravity environment that is about equal to one one-hundred-thousandth ( $1 \times 10^{-5}$ ) of the force of gravity experienced when the package is at rest.

If a longer period of microgravity is needed, NASA uses a specially equipped jet airplane for the job. Most of the plane's seats have been removed and the wall, floor, and ceiling are covered with thick padding similar to tumbling mats.

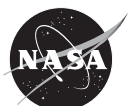
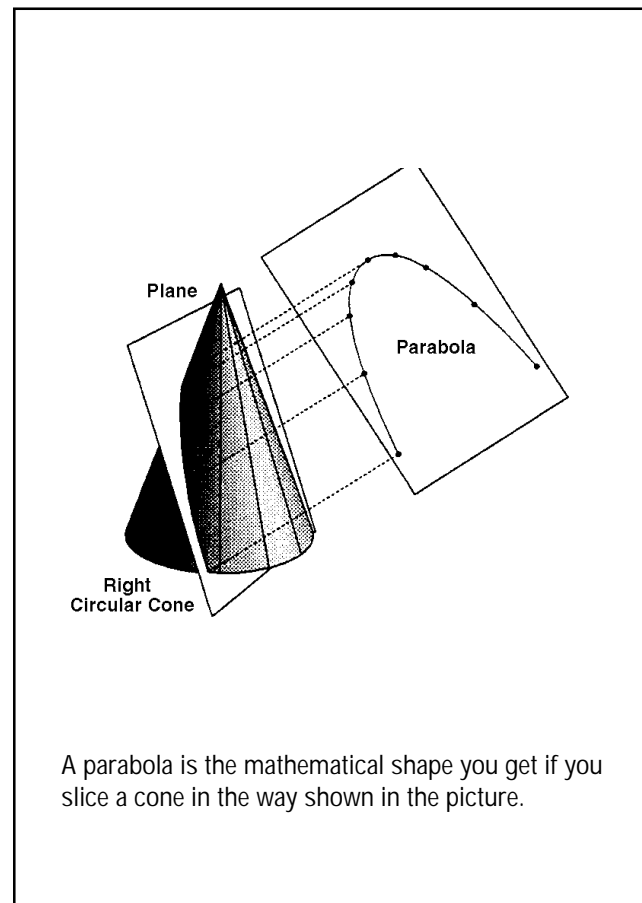

Student Reader -3

Small rockets provide a third technology for creating microgravity. A sounding rocket follows a parabolic path that reaches an altitude hundreds of kilometers above Earth before falling back. The experiments onboard experience several minutes of freefall. The microgravity environment produced is about equal to that produced onboard falling packages in drop towers.

Although airplanes, drop facilities, and small rockets can be used to establish a microgravity environment, all of these laboratories share a common problem. After a few seconds or minutes of low-g, Earth gets in the way and the freefall stops. When longer term experiments (days, weeks, months, and years) are needed, it is necessary to travel into space and orbit Earth. We will learn more about this later.

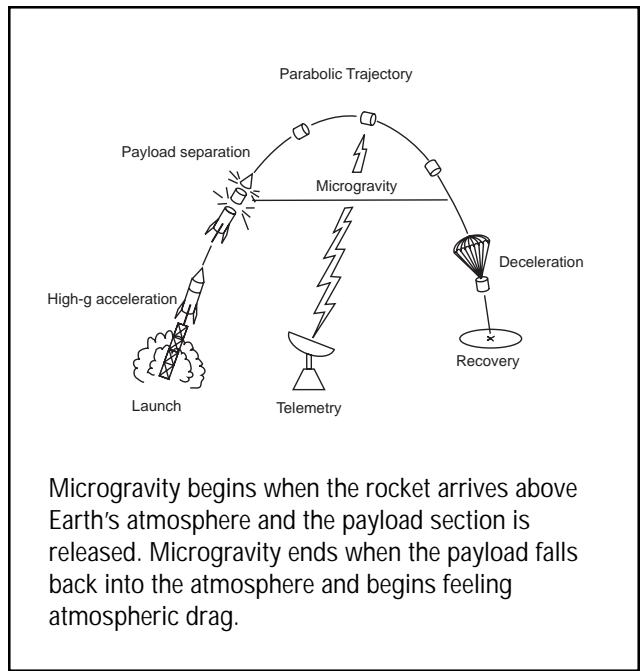

Microgravity begins when the rocket arrives above Earth's atmosphere and the payload section is released. Microgravity ends when the payload falls back into the atmosphere and begins feeling atmospheric drag.

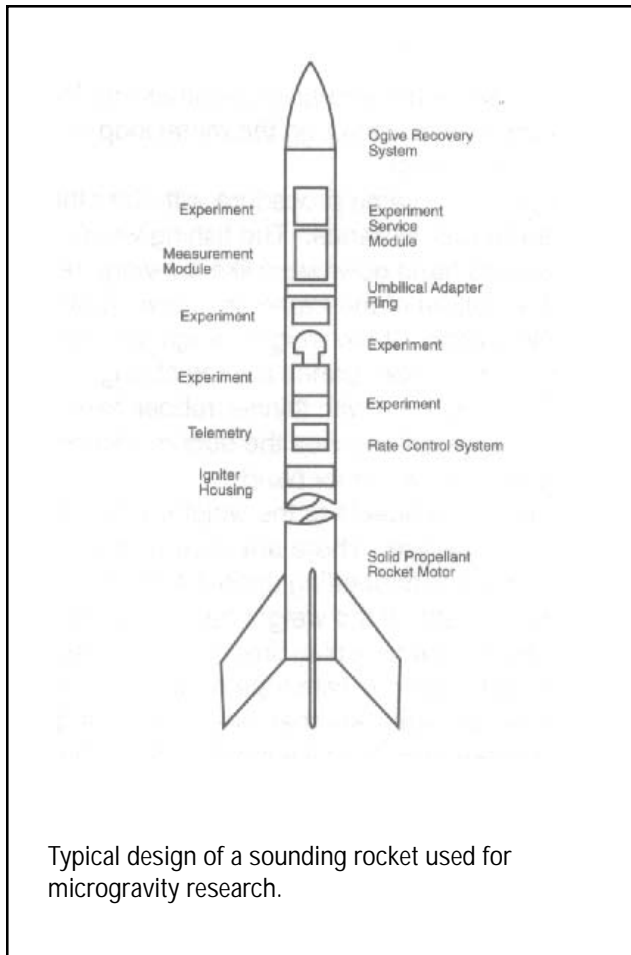

Typical design of a sounding rocket used for microgravity research.

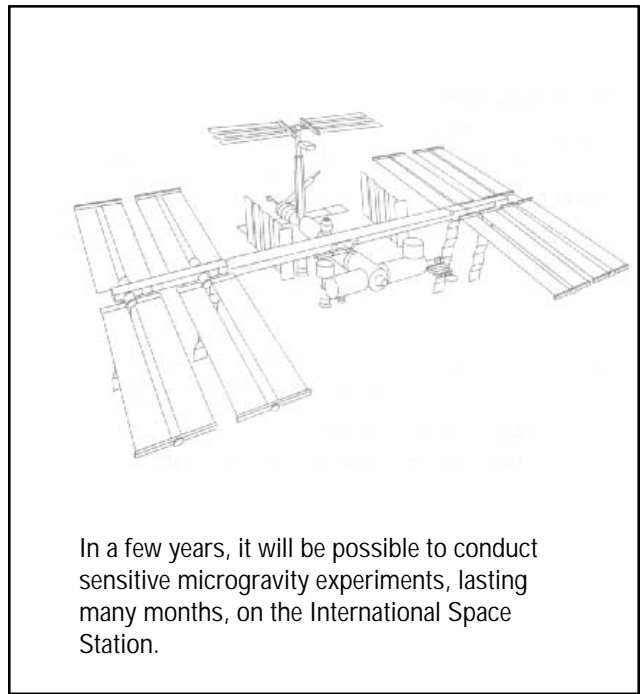

In a few years, it will be possible to conduct sensitive microgravity experiments, lasting many months, on the International Space Station.





# Falling Weight Apparatus

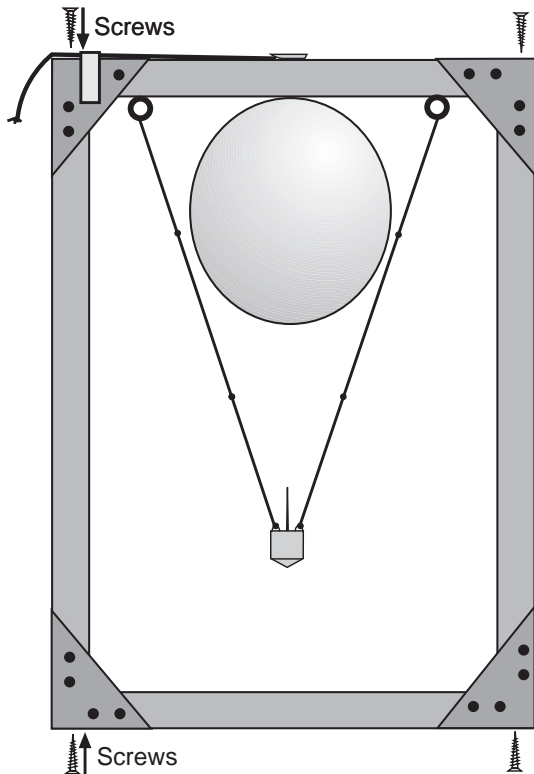

## MATERIALS AND TOOLS

### MATERIALS NEEDED:

- 2 pieces of wood 16x2x1 in.
- 2 pieces of wood 10x2x1 in.
- 4 wood screws (#8 or #10 by 2 in.)
- 8 corner brace triangles from 1/4 in. plywood
- Glue
- 2 screw eyes
- 4-6 rubber bands
- 1 6-oz fishing sinker or several lighter sinkers taped together
- Long sewing needle
- Small round balloons (4 in.)
- String
- Drill, 1/2 in. bit, and bit for piloting holes for wood screws
- Screwdriver
- Pillow or chair cushion
- (Optional - Make a second frame with string supporting the sinker.)

## Construction:

1. Assemble the rectangular supporting frame as shown in the diagram. Be sure to drill pilot holes for the screws and glue the frame pieces before screwing them together. Brace the front and back of each corner with small triangles of plywood. Glue and nail them in place.
2. Drill a 1/2 inch-diameter hole through the center of the top of the frame. Be sure the hole is free of splinters.
3. Twist the two screw eyes into the underside of the top of the frame as shown in the diagram. (Before doing so, check to see that the metal gap at the eye is wide enough to slip a rubber band over it. If not, use pliers to spread the gap slightly.)
4. Join three rubber bands together and then loop one end through the metal loop of the fishing sinker.
5. Follow the same procedure with the other three rubber bands. The fishing weight should hang downward like a swing, near the bottom of the frame as shown in the illustration. If the weight hangs near the top, the rubber bands are too strong. Replace them with thinner rubber bands. If the weight touches the bottom, remove some of the rubber bands.
6. Attach the needle to the weight, with the point upward. There are several ways of doing this depending upon the design of the weight. If the weight has a loop for attaching it to fishing line, hold the needle next to the loop with tape or low-temperature hot glue. Another way of attaching the needle is to drill a small hole on top of the weight to hold the needle.

## Use:

Inflate the balloon and tie off the nozzle with a short length of string. Thread the string through the hole and pull the balloon nozzle through. Pull the string snugly and tape it to the top of the frame.

## Demonstration:

1. Place a pillow or cushion on the floor. Hold the frame above the pillow or cushion at shoulder level.
2. Ask the students to predict what will happen when the entire frame is dropped.
3. Drop the entire unit onto the cushion. The balloon will pop almost immediately after release.

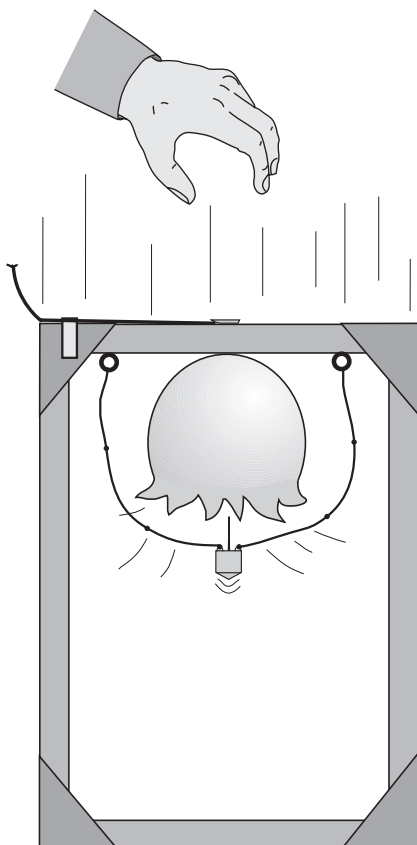

## Explanation:

When stationary, the lead fishing weight stretches the rubber bands so the weight hangs near the bottom of the frame. When the frame is dropped, the whole apparatus goes into freefall. The microgravity produced by the fall removes the force the fishing weight is exerting on the rubber bands. Since the stretched rubber bands have no force to counteract their tension, they pull the weight—with the needle—up toward the balloon, causing it to pop. (In fact, the sinker's acceleration toward the balloon will initially be zero due to the energy released as the rubber bands relax to their normal, unstretched length.) If a second frame, with string instead of rubber bands supporting the weight, is used for comparison, the needle will not puncture the balloon as the device falls because the strings will not rebound like the rubber bands did.

In tests of this device using a television camera and videotape machine as a timer (see extensions), the balloon was found to pop in about 4 frames which is equal to fourthirtieths of a second or 0.13 seconds. Using the formula for a falling body (see below), it was determined that the frame dropped only about 8 centimeters before the balloon popped. This was the same as the distance between the balloon and the needle before the drop.

$$d = \frac{1}{2} at^2$$

$$d = \frac{1}{2} \times 9.8 \text{ m/s}^2 \times (0.13\text{s})^2 = 0.08\text{m}$$

$d$  is the distance of the fall in meters  
 $a$  is the acceleration of gravity in meters per second squared  
 $t$  is the time in seconds



# Falling Water

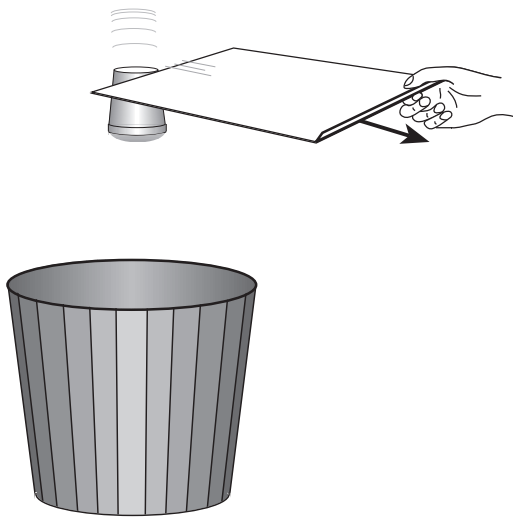

## MATERIALS AND TOOLS

Plastic drinking cup  
Cookie sheet (with at least one edge without a rim)  
Catch basin (large pail, waste basket)  
Water  
Chair or stepladder (optional)  
Towels  
Television camera, videotape recorder, and monitor (optional)

## Procedure:

1. Place the catch basin in the center of an open area in the classroom.
2. Fill the cup with water.
3. Place the cookie sheet over the opening of the cup. Press the cup tight to the sheet while inverting the sheet and cup.
4. Hold the cookie sheet and cup high above the catch basin. You may wish to stand on a sturdy table or climb on a stepladder to raise the cup higher.
5. While holding the cookie sheet level, slowly slide the cup off the edge of the cookie sheet and observe what happens.
6. Refill the cup with water and invert it on the cookie sheet.
7. Quickly pull the cookie sheet straight out from under the cup and observe the fall of the cup and water.
8. (Optional) Videotape the cup drop and play back the tape frame-to-frame to observe what happens to the water.

## Explanation:

Air pressure and surface tension keep the water from seeping around the cup's edges while it is inverted on the cookie sheet. If the cup were slowly pushed over the edge of the sheet, the water would pour out. However, when the sheet is quickly pulled out from under the filled cup, the cup and water both fall at the same time. Since they are both accelerated downward by gravity an equal amount, the cup and water fall together. The water remains in the cup but the lower surface of the water bulges. Surface tension tends to draw liquids into spherical shapes. When liquids are at rest, gravity overcomes surface tension, causing drops to spread out. In freefall, gravity's effects are greatly reduced and surface tension begins to draw the water in the cup into a sphere.

# Can Throw

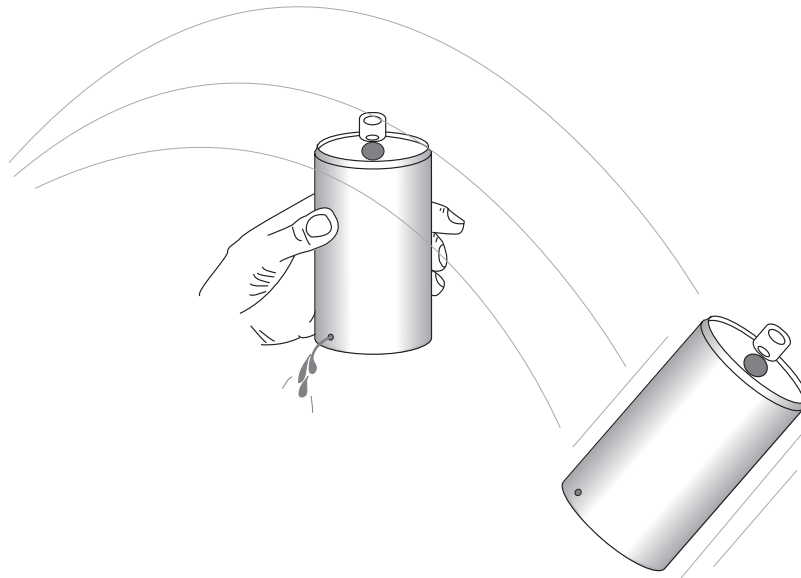

## Procedure:

1. Punch a small hole with a nail near the bottom of an empty soft drink can.
2. Close the hole with your thumb and fill the can with water.
3. While holding the can over a catch basin, remove your thumb to show that the water falls out of the can.
4. Close the hole again and stand back about 2 meters from the basin. Toss the can through the air to the basin, being careful not to rotate the can in flight.
5. Observe the can as it falls through the air.
6. (Optional) Videotape the can toss and play back the toss frame-to-frame to observe the hole of the can.

## Explanation:

When the can is stationary, water easily pours out of the small hole and falls to the catch basin. However, when the can is tossed, gravity's effects on the can and its contents are greatly reduced. The water remains in the can through the entire fall including the upward portion. This is the same effect that occurs on aircraft flying in parabolic arcs.

### MATERIALS AND TOOLS

Empty aluminum soft drink can  
Sharp nail  
Catch basin  
Water  
Towels  
Television camera, videotape recorder, and monitor (optional)



# Accelerometers

## Objective:

- To measure the acceleration environments created by different motions.

## Science Standards:

- Physical Science
- position and motion of objects
- Unifying Concepts and Processes
- Change, Constancy, & Measurement
- Science and Technology
- abilities of technological design

## Science Process Skills:

- Communicating
- Measuring
- Collecting Data

## Mathematics Standards:

- Communication
- Number & Number Relationships
- Measurement Computation & Estimation

## Activity Management:

This activity provides students with the plans for making a one-axis accelerometer that can be used to measure acceleration in different environments ranging from +3 g to -3 g. The device consists of a triangular shaped poster board box they construct with a lead fishing sinker suspended in its middle with a single strand of a rubber band. Before using the device, students must calibrate it for the range of accelerations it can measure.

The pattern for making the accelerometer box is included in this guide. It must be doubled in size. It is recommended that

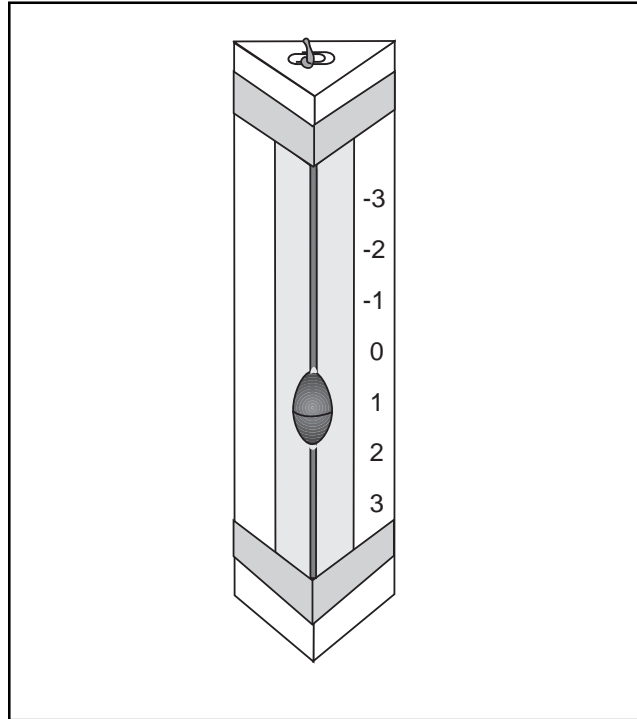

Students construct a device that can measure acceleration environments from +3 to -3 g.

## MATERIALS AND TOOLS

- Lightweight poster board (any color)
- 3 "drilled egg" lead fishing sinkers, 1 ounce size
- Masking tape
- Rubber band, #19 size
- 4 small paper clips
- Scissors
- Straightedge
- Ballpoint pen
- Pattern
- Hot glue (low temperature)

several patterns be available for the students to share. To save on materials, students can work in teams to make a single accelerometer. Old file folders can be substituted for the poster board. The student reader can be used at any time during the activity.

The instructions call for three egg (shaped) sinkers. Actually, only one is needed for the accelerometer. The other two are used for calibrating the accelerometer and can be shared between teams.

When the boxes are being assembled, the three sides are brought together to form a prism shape and held securely with masking tape. The ends should not be folded down yet. A rubber band is cut and one end is inserted into a hole punched into one of the box ends. Tie the rubber band to a small paper clip. This will prevent the end of the rubber band from sliding through the hole. The other end of the rubber band is slipped through the sinker first and then tied off at the other end of the box with another paper clip. As each rubber band end is tied, the box ends are closed and held with more tape. The two flaps on each end overlap the prism part of the box on the outside. It is likely that the rubber band will need some adjustment so it is at the right tension. This can be easily done by rolling one paper clip over so the rubber band winds up on it. When the rubber band is lightly stretched, tape the clip down.

After gluing the sinker in place on the rubber band, the accelerometer must be calibrated. The position of the sinker when the box is standing on one end indicates the acceleration of 1 gravity (1 g). By making a paper clip hook, a second sinker is hung from the first and the new position of the first sinker indicates an acceleration of 2g. A third sinker indicates 3 g. Inverting the box and repeating the procedure yields positions for negative 1, 2, and 3 g. Be sure the students understand that a negative g acceleration is an acceleration in a direction opposite gravity's pull. Finally, the half way position of the sinker when the box is laid on its side is 0 g.

Students are then challenged to use their accelerometers to measure various accelerations. They will discover that tossing the device or letting it fall will cause the sinker to move, but it will be difficult to read the scale. It is easier to

read if the students jump with the meter. In this case, they must keep the meter in front of their faces through the entire jump. Better still would be to take the accelerometer on a fast elevator, on a trampoline, or a roller coaster at an amusement park.

### Assessment:

Test each accelerometer to see that it is constructed and calibrated properly. Collect and review the student sheets.

### Extensions:

1. Take the accelerometer to an amusement park and measure the accelerations

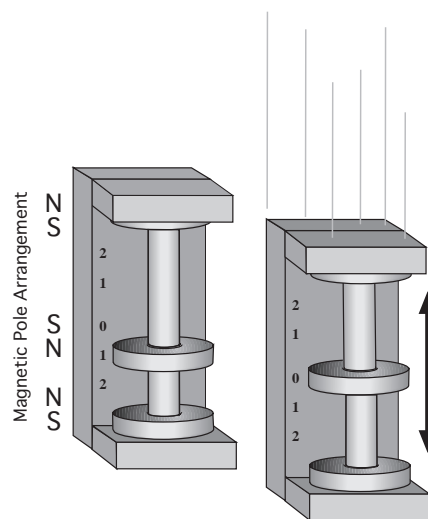

### Magnetic Accelerometer

Three ring magnets with like poles facing each other.

1. you experience riding a roller coaster and other fast rides.
2. Construct a magnetic accelerometer.
3. Design and construct an accelerometer for measuring very slight accelerations such as those that might be encountered on the Space Shuttle.





# Accelerometer Box Pattern

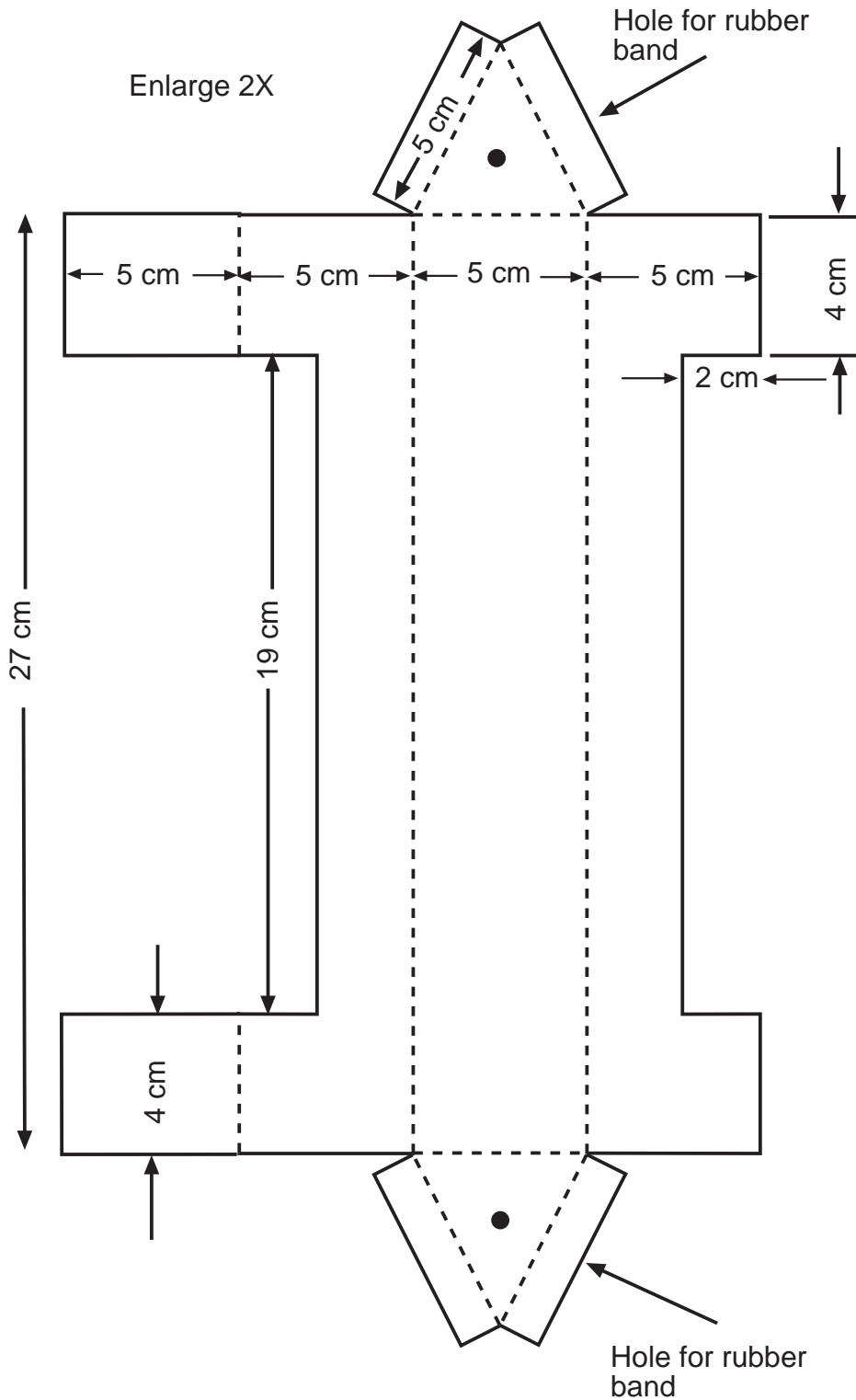



# Acceleration

## Gravity

*Acceleration* is the rate at which an object's velocity is changing. The change can be in how fast the object is moving, a direction change, or both. If you are driving an automobile and press down on the gas pedal (called the accelerator), your velocity changes. Let's say you go from 0 kilometers to 50 kilometers per hour in 10 seconds. Your acceleration is said to be 5 kilometers per hour per second. In other words, each second you are going 5 kilometers per hour faster than the second before. In 10 seconds, you reach 50 kilometers per hour.

You feel this acceleration by being pressed into the back of your car seat. Actually, it is the car seat pressing against you. Because of the property of *inertia*, your body resists acceleration. You also experience acceleration when there is a change in direction. Let's say you are driving again but this time at a constant speed in a straight line. Then, the road curves sharply to the right. Without changing speed, you make the turn and feel your body pushed into the left wall of the car. Again, it is actually the car pushing on you. This time, your acceleration was a change in direction. Can you think of situations in which acceleration is both a change in speed and direction?

The reason for this discussion on acceleration is that it is important to understand that the force of gravity produces an acceleration on objects. Imagine you are standing at the edge of a cliff and you drop a baseball over the edge. Gravity accelerates the ball as it falls. The acceleration is 9.8 meters per second per second. After 5 seconds, the ball is traveling at a rate of nearly 50 meters per second. To create a microgravity environment where the effects of gravity on an experiment are reduced to zero, NASA would have to accelerate that experiment (make it fall) at exactly the same rate gravity does. In practice, this is hard to do. When you jump into the air, the microgravity environment you experience is about 1/100th the acceleration of Earth's gravity. The best microgravity environment that NASA's parabolic aircraft can create is about 1/1000th g. On the Space Shuttle in Earth orbit, microgravity is about one-millionth g. In practical terms, if you dropped a ball there, the ball would take about 17 minutes just to fall 5 meters!



# Accelerometer Construction and Calibration

The instructions below are for making a measuring device called an accelerometer. Accelerometers are used to measure how fast an object changes its speed in one or more directions. This accelerometer uses a lead weight suspended by a rubber band to sense changes in an object's motion.

## Building the Accelerometer:

1. Trace the pattern for the accelerometer on a piece of poster board. Cut out the pattern.
2. Use a ruler and a ballpoint pen to draw the fold lines on the poster board in the same place they are shown on the pattern. As you draw the lines, apply pressure to the poster board. This will make the poster board easier to fold.
3. Fold the two long sides up as shown in the first illustration. The left side with the tabs is folded over first. The right side is folded second. This makes a long triangle shape. Use tape to hold the sides together.
4. Punch a small hole in one of the end triangles. Cut the rubber band to make one long elastic band. Tie one end of the band to a small paper clip. Thread the other end through the hole.
5. Slip the lead weight on the band. Punch a hole in the other end triangle. While stretching the band, slip the free end through the second hole and tie it to a second paper clip.
6. Set the triangular box on its side so the window is up. Slide the weight so it is in the middle of the elastic band. Put a dab of hot glue on each end of the weight where the elastic band enters the holes.
7. If the elastic band sags inside the box, roll the elastic around one of the paper clips until it is snug. Then tape the paper clip in place. Tape the other triangular end in place.

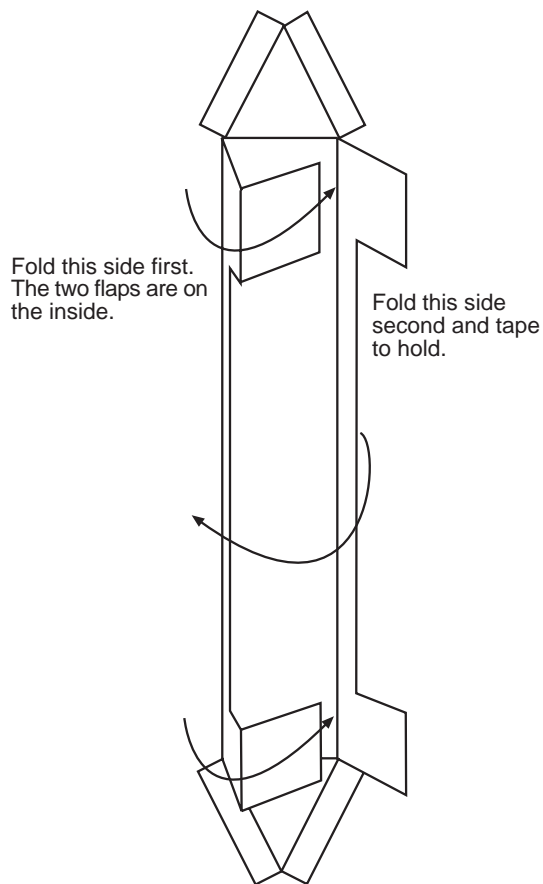

Fold ends after rubber band and weight are attached. The two flaps on each end are folded to the outside.

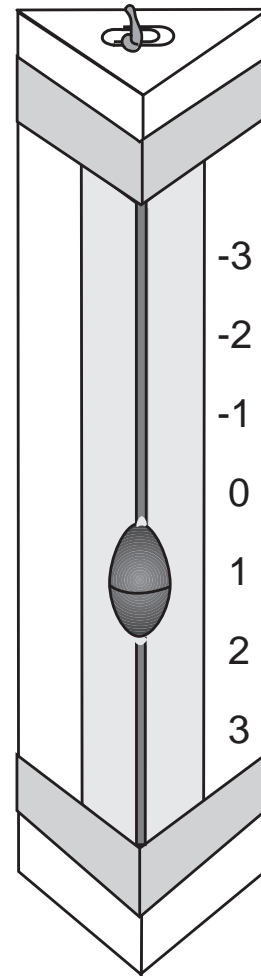
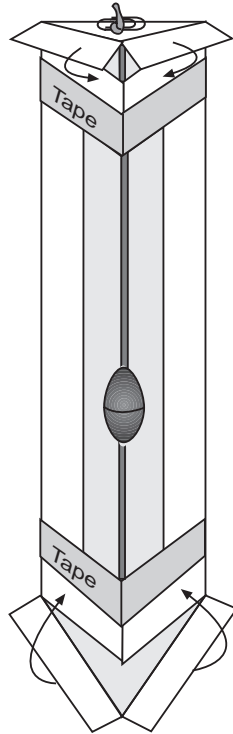

Finished Accelerometer

### Calibrating the Accelerometer:

1. Stand the accelerometer on one end. Using a pencil, mark one side of the accelerometer next to the middle of the weight. Identify this mark as 1 g.
2. Using a small paper clip as a hook, hang a second weight on the first. Again, mark the middle of the first weight on the accelerometer. Identify this mark as 2 g. Repeat this step with a third weight and identify the mark as 3 g.
3. Remove the two extra weights and stand the accelerometer on its other end. Repeat the marking procedure and identify the marks as -1 g, -2 g, and -3 g.
4. The final step is to mark the midway position between 1 and -1 g. Identify this place as 0 g. The accelerometer is completed.



# Accelerometer Tests

## Instrument Construction Team:

---

---

---

Test your accelerometer by jumping in the air with it a few times. What happens to the position of the sinker?

What g forces did you encounter in your jumps?

Where else might you encounter g forces like these?

Explain how your accelerometer measures different accelerations.

## Design Activity:

How can this accelerometer be redesigned so it is more sensitive to slight accelerations? Make a sketch of your idea below and write out a short explanation.



# Around The World

## Objective:

- To create a model of how satellites orbit Earth.

## Science Standards:

- Science as Inquiry
- Physical Science
  - position and motion of object
- Change, Constancy, & Measurement
  - evidence, models, & exploration

## Science Process Skills:

- Observing
- Communicating
- Making Models
- Defining Operationally Investigating

## Mathematics Standards:

- Communication
- Geometry

## Activity Management:

This activity can be conducted as a demonstration or a small group activity at a learning station where student groups take turns.

Pick a small ball to which it is easy to attach a string. A small slit can be cut into a tennis ball or racquetball with a sharp knife. Then, a knotted string can be shoved through the slit. The slit will close around the string. A screw eye can be screwed into a solid rubber or wood ball and a string attached to it.

If using this as an activity, have students work in groups of two. The large ball and flowerpot should be placed on the floor in an open area. Tell students to imagine the

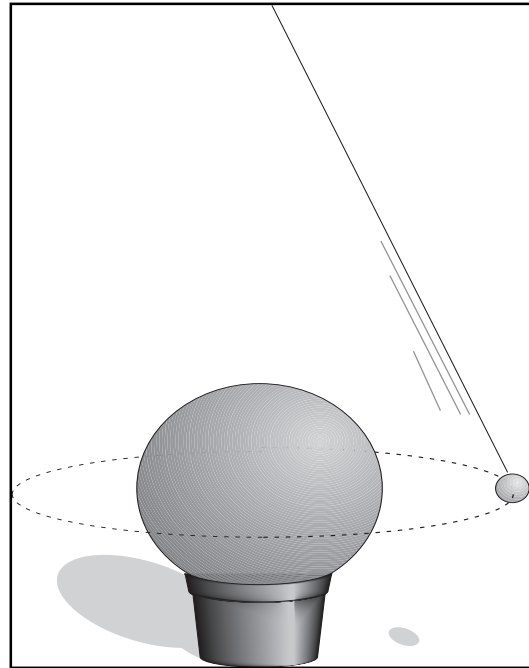

A ball on a string circles a ball to simulate the orbits of satellites around Earth.

### MATERIALS AND TOOLS

- Large ball\*
- Small ball
- 2 meters of string
- Flower pot\*

\* A world globe can substitute for the large ball and flower pot

ball is Earth with its north pole straight up. One student will stand near the ball and pot and hold the end of the string the small ball is attached to. This student's hand should be held directly over the large ball's north pole, and enough string should be played out so that the small





ball comes to rest where the large ball's equator should be. While the first student holds the string steadily the second student starts the small ball moving. The objective is to move the small ball in a direction and at a speed that will permit it to orbit the big ball.

Save the student reader for use after students have tried the activity.

### Additional Information:

This model of a satellite orbiting around Earth is effective for teaching some fundamentals of orbital dynamics. Students will discover that the way to orbit the small ball is to pull it outward a short distance from the large ball and then start it moving parallel to the large ball's surface. The speed they move it will determine where the ball ends up. If the small ball moves too slowly, it will arc "down" to Earth's surface. NASA launches orbital spacecraft in the same way. They are carried above most of Earth's atmosphere and aimed parallel to Earth's surface at a particular speed. The speed is determined by the desired altitude for the satellite. Satellites in low orbits must travel faster than satellites in higher orbits.

In the model, the small ball and string become a pendulum. If suspended properly, the at-rest position for the pendulum is at the center of the large ball. When the small ball is pulled out and released, it swings back to the large ball. Although the real direction of gravity's pull is down, the ball seems to move only in a horizontal direction. Actually, it is moving downward as well. A close examination of the pendulum reveals that as it is being pulled outward, the small ball is also being raised higher off the floor.

The validity of the model breaks down when students try orbiting at different distances from the large ball *without* adjusting the length of the string. To make the small ball orbit at a higher altitude without lengthening the string, the ball has to orbit faster than a ball in a lower orbit. This is the opposite of what happens with real satellites.

### Assessment:

Use the student pages for assessment.

### Extensions:

1. Investigate the mathematical equations that govern satellite orbits such as the relationship between orbital velocity and orbital radius.
2. Learn about different kinds of satellite orbits (e.g., polar, geostationary, geosynchronous) and what they are used for.
3. Look up the gravitational pull for different planets. Would there be any differences in orbits for a planet with a much greater gravitational pull than Earth's? Less than Earth's?
4. Use the following equation to determine the velocity a satellite must travel to remain in orbit at a particular altitude:

$$V = \sqrt{\frac{GM}{r}}$$

- $v$  = velocity of the satellite in meters  
 $GM$  = gravitational constant times Earth's mass (3.99x10<sup>14</sup> meters<sup>3</sup>/sec<sup>2</sup>)  
 $r$  = Earth's radius (6.37x10<sup>6</sup> meters) plus the altitude of the satellite





A microgravity environment is created by letting things fall freely. NASA uses airplanes, drop towers, and small rockets to create a microgravity environment lasting a few seconds to several minutes. Eventually, freefall has to come to an end because Earth gets in the way. When scientists want to conduct experiments lasting days, weeks, months, or even years, it is necessary to travel into space and orbit Earth. Having more time available for experiments means that slower processes and more subtle effects can be investigated.

To see how it is possible to establish microgravity conditions for long periods of time, it is first necessary to understand what keeps a spacecraft in orbit. Ask just about anybody what keeps satellites and Space Shuttles in orbit and you will probably hear, "There is no gravity in space." This is simply not true. Gravity is what keeps a satellite or Space Shuttle from drifting into space. It does this by bending an orbiting object's path into a circular shape. To explain how this works, we can use an example presented by English scientist Sir Isaac Newton. In a book he wrote in 1673, *Philosophiae Naturalis Principia Mathematica* (Mathematical Principles of Natural Philosophy), Newton explained how a satellite could orbit Earth.

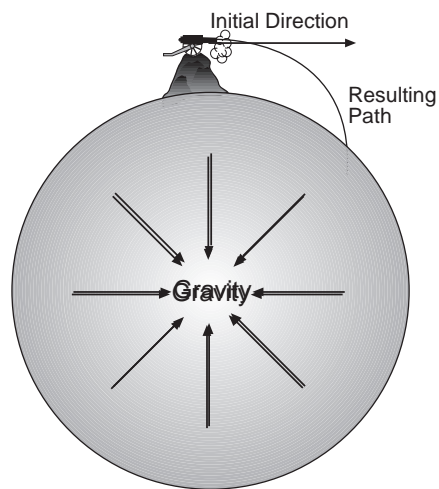

Newton's cannon fires the first cannonball. The combination of the cannonball's initial velocity and the pull of Earth's gravity causes the cannonball to arc to the ground near the mountain.

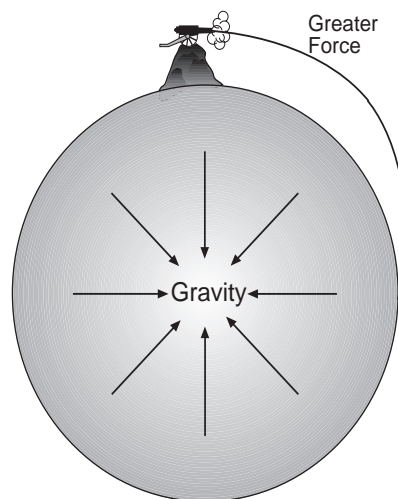

A second cannonball is fired using a larger charge of black powder. The force exerted on the cannonball causes it to travel faster than the first cannonball. Gravity bends its path into an arc but because of the greater speed, the cannonball travels farther before it lands on Earth.

Newton envisioned a very tall mountain on Earth whose peak extended above Earth's atmosphere. This was to eliminate friction with Earth's atmosphere. Newton then imagined a cannon at the top of that mountain firing cannonballs parallel to the ground. As each cannonball was



fired, it was acted upon by two forces. One force, due to the explosion of the black powder, propelled the cannonball straight outward. If no other force were to act on the cannonball, the shot would travel in a straight line and at a constant velocity. But Newton knew that a second force would also act on the cannonball: Earth's gravity would cause the path of the cannonball to bend into an arc ending at Earth's surface.

Newton demonstrated how additional cannonballs would travel farther from the mountain if the cannon were loaded with more black powder each time it was fired. With each shot, the path would lengthen and soon the cannonballs would disappear over the horizon. Eventually, if a cannonball were fired with enough energy it would fall entirely around Earth and come back to its starting point. This would be one complete orbit of Earth. Provided no force other than gravity interfered with the cannonball's motion, it would continue circling Earth in that orbit.

In essence, this is how the Space Shuttle stays in orbit. The Shuttle is launched on a path that arcs above Earth so that the Orbiter is traveling parallel to the ground at the right speed. For example, if the Shuttle climbs to a 160-kilometer-high orbit, it must travel at a speed of about 28,300 kilometers per hour to achieve an orbit. At that speed and altitude, the Shuttle's falling path will be parallel to the curvature of Earth. Because the Space Shuttle is freefalling around Earth, a microgravity environment is created that will last as long as the Shuttle remains in orbit.

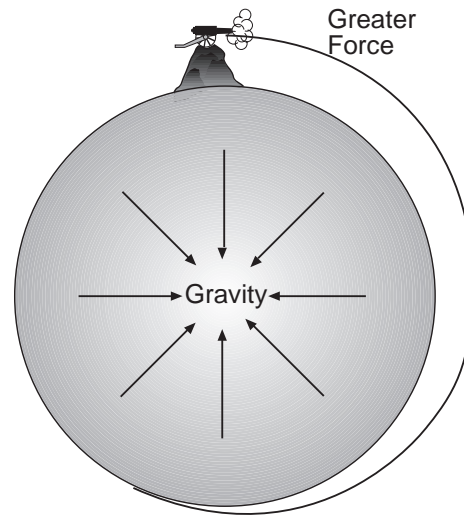

This cannonball travels halfway around Earth because of the greater charge of black powder used. The cannonball's falling path nearly matches the shape of Earth.

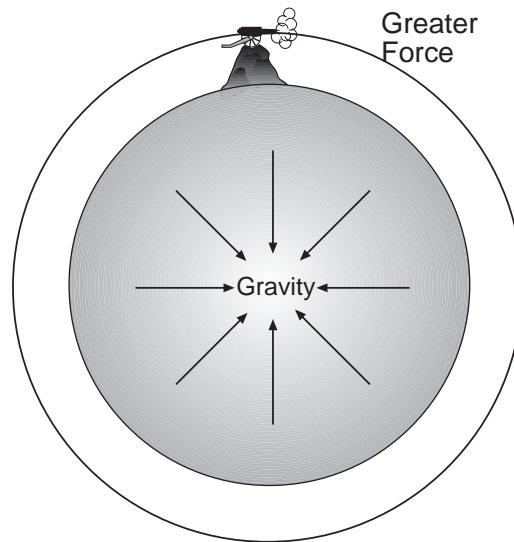

The black powder charge in this final cannon shot propels the ball at exactly the right speed to cause it to fall entirely around Earth. If the cannon is moved out of the way, the cannonball will continue orbiting Earth.



# Around The World

## Procedure:

1. Set up your equipment as shown in the picture. One team member stands above the large ball and holds the end of the string. The second team member's job is to move the small ball in different ways to answer the following questions. Write down your answers where indicated and draw pictures to show what happened. Draw the pictures looking straight down on the two balls.

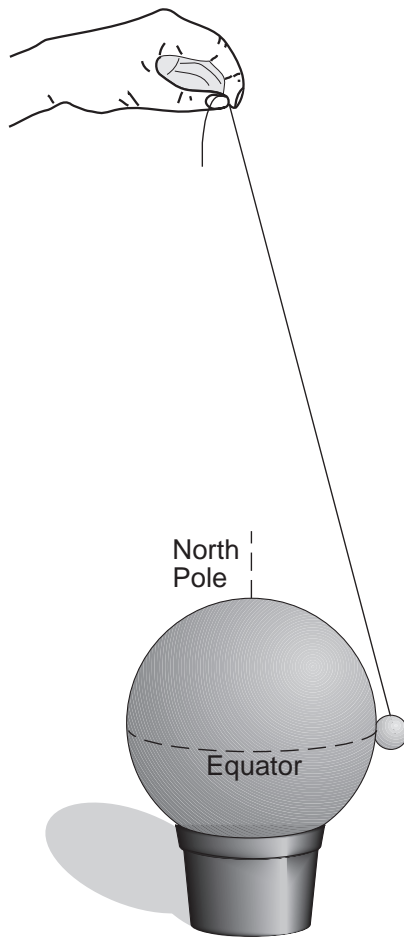

## Orbital Deployment Team Members:

1. \_\_\_\_\_

2. \_\_\_\_\_

1. What path does the satellite (small ball) follow when it is launched straight out from Earth?

---

---

---

Show what happened.



2. What path does the satellite follow when it is launched at different angles from Earth's surface?

---

---

---

Show what happened.

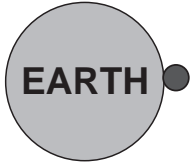

3. What effect is there from launching the satellite at different speeds?

---

---

---

4. What must you do to launch the satellite so it completely orbits Earth?

---

---

---

---

---

---

5. Using the results of your investigation and the information contained in the student reader, write a paragraph that explains how satellites remain in orbit.

---

---

---

---

---

---

---

---

---

---

6. Why will the International Space Station be an excellent place to conduct microgravity research?

---

---

---

---

---



# Inertial Balance

## Objective:

- To demonstrate how mass can be measured in microgravity.

## Science Standards:

- Science as Inquiry
- Physical Science
  - position and motion of objects
- Unifying Concepts and Processes
- Change, Constancy, & Measurement

## Science Process Skills:

- Observing
- Communicating
- Measuring
- Collecting Data
- Making Graphs
- Interpreting Data
- Controlling Variables

## Mathematics Standards:

- Communication
- Number & Number Relationships
- Computation & Estimation
- Measurement

## Activity Management:

Before doing this activity, you will need to construct enough inertial balances for the entire class. Plan on having one balance for every three or four students. Except for the empty film canisters, which are free from photo processors, materials and tools for making all the balances can be obtained at a hardware store where lumber is also sold. To reduce your cost, buy hacksaw blades in multipacks. The dimensions for the wood blocks are not critical and you may be able to find a piece of scrap lumber to meet your needs. The only tools needed to construct the balances are a crosscut or backsaw to cut

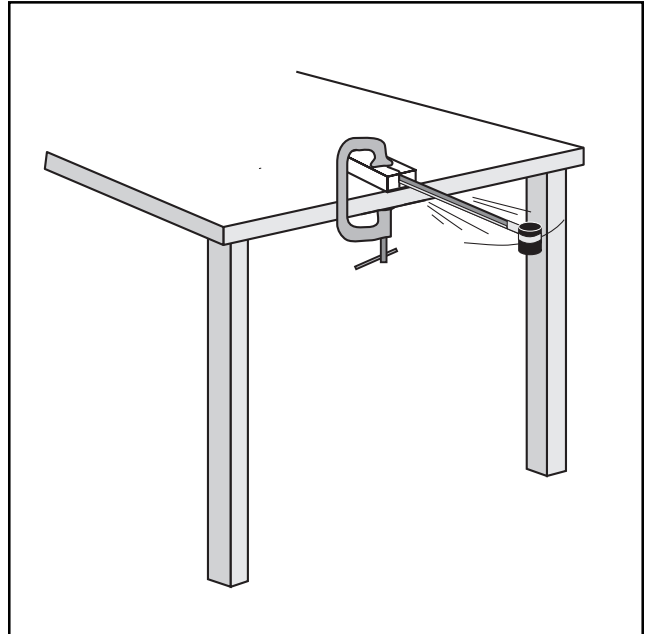

Objects of unknown mass are measured with a balance that works in microgravity.

<b>MATERIALS AND TOOLS</b>	Hacksaw blade (12 inch) Coping saw (optional) 1 C-clamp (optional) Plastic 35mm film canister Tissue paper Masking tape Wood block (1x2.5x4 inch) Wood saws Glue Objects to be measured Graph paper, ruler, and pencil Pennies and nickels Stopwatch
----------------------------	--

the wood into blocks and a coping saw to cut the notch for insertion of the blade. If you have access to power tools, use a table scroll saw to cut the notches. The notches should be just wide enough for the hacksaw blade to be slid in. If the notches are too wide, select a thinner blade for the coping or scroll saw.





Cut the blocks, one for each balance, about 10 centimeters long. Cut a 2 centimeter deep notch in one end of each block. Slip one end of the hacksaw blade into the notch to check the fit. It should be snug. Remove the blade and apply a small amount of glue to both sides of the end and slip the blade back in place. Make sure the blade is slightly above and parallel to the bottom flat side of the block. Set the balance aside to dry.

Use tape to attach a film canister to the opposite end of each balance. Squirt hot glue into the bottom of the canister and drop in a large metal

washer. Repeat two more times. The reason for doing this is to provide extra mass to the canister end of the inertial balance. Students will be counting how long it takes the device to oscillate from side to side 25 times. A very light canister will swing faster than the students can count. Extra mass will slow the device so that counting is possible.

To use the inertial balance, students will place the wood block on the edge of a table

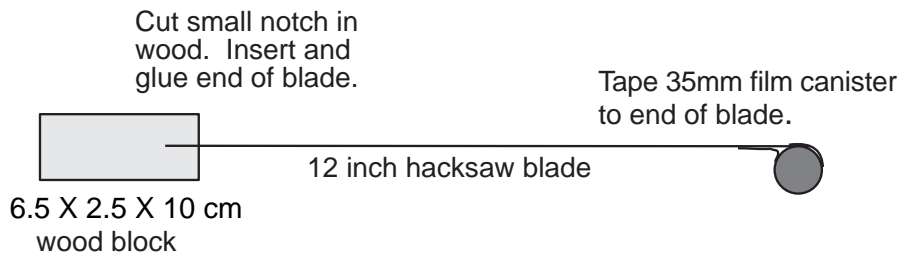
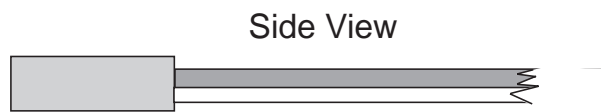
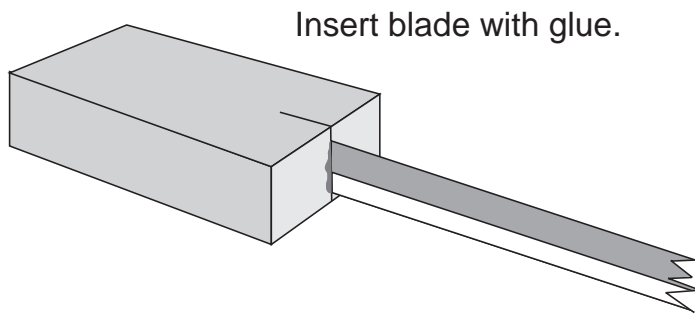
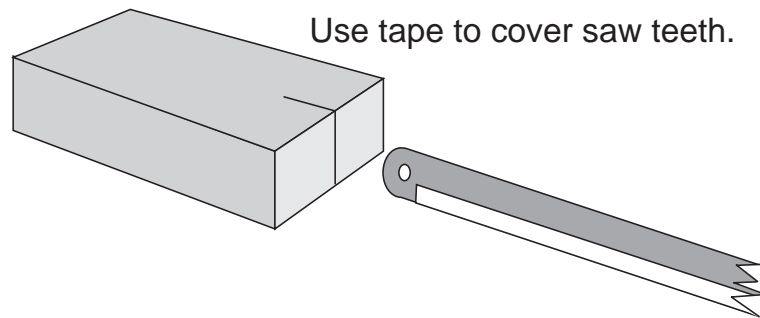

so the hacksaw and canister stick over the edge. The balance can be anchored with a clamp or just pressed to the tabletop by one student in the team. An object of unknown mass is placed in the canister and the students determine its mass by deflecting the blade so it swings from side to side. Unknown masses can be such things as nuts and bolts, washers, and pebbles. The tissue paper called for in the instructions anchors the unknown object in the canister so it will not slosh around and throw off the accuracy.

The first step for students is to calibrate the balance. This is done with a standard mass such as a penny. The length of time the balance takes to oscillate 25 times is measured for zero through 10 pennies. The results are plotted on a graph. When an unknown mass is placed in the canister, its time will be measured. By referring to the graph, students will be able to determine the unknown object's mass by seeing where it falls on the graph. The mass will be given in units of pennies. If desired, the balance can be calibrated in grams by measuring the pennies on a metric beam balance.

Save the student reader for use after the activity.

### Assessment:

Collect calibration graphs and data sheets.

### Extensions:

1. Construct and demonstrate inertia rods. The instructions follow. The materials list is found on the next page.
- A. Using a saw, cut the PVC tube in half. Smooth out the ends, and check to see that the caps fit the ends.
- B. Squeeze a generous amount of silicone rubber sealant into the end of one of the tubes. Slide the pipe into the tube. Using the dowel rod, push the pipe to the middle of the tube. Add sealant to the other end of the tube and insert

**Sample Graph**

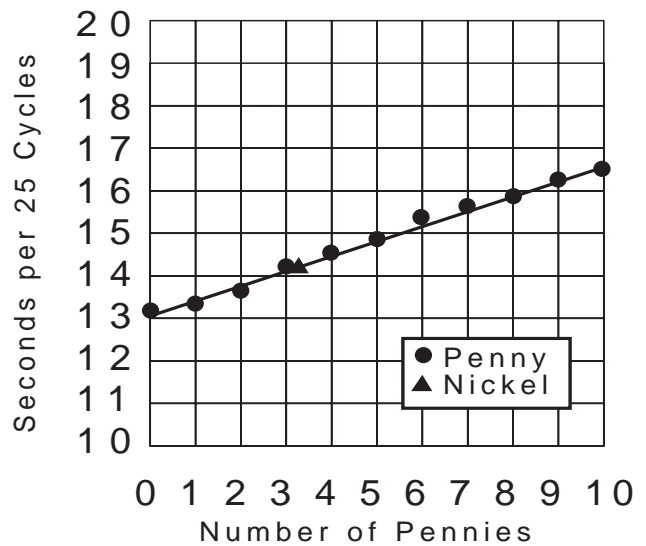

the second pipe. Position both pipes so they are touching each other and straddling the center of the tube.

Set the tube aside to dry.

- C. Squeeze sealant into the ends of the second tube. Push the remaining pipes into the ends of the tubes until the ends of the pipes are flush with the tube ends. Be sure there is enough compound to cement the pipes in place. Set the tube aside to dry.
- D. When the sealant of both tubes is dry, check to see that the pipes are firmly cemented in place. If not, add additional sealant to complete the cementing. Weigh both rods. If one rod is lighter than the other, add small amounts of sealant to both ends of the lighter rod. Re-weigh. Add more sealant if necessary.
- E. Spread some sealant on the inside of the PVC caps. Slide them onto the ends of the tubes to cement them in place.
- F. Use fine sandpaper to clean the rods.

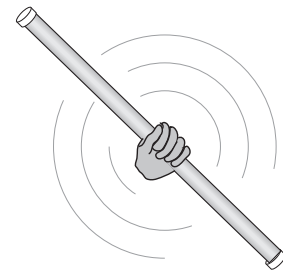

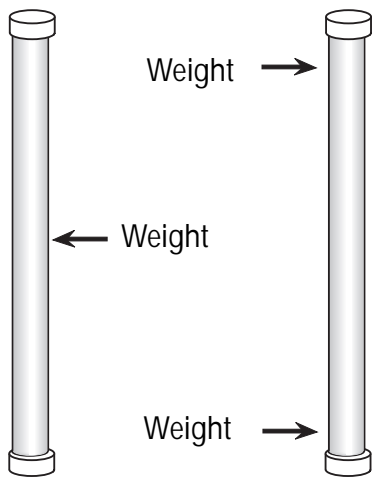

**MATERIALS AND TOOLS**

- PVC 3/4 in. water tube  
(about 1.5 to 2 m long)
- 4 iron pipe nipples (4-6 in. long  
sized to fit inside PVC pipe)
- 4 PVC caps to fit water pipe
- Silicone rubber sealant
- Scale or beam balance
- Saw
- Very fine sandpaper
- 1/2 in. dowel rod

Demonstrate the rods by having a student pick up both of the rods from their upper ends and tell the class whether the rods feel the same. Then, the student grasps each rod by its middle, extends arms, and twists the rods side to side as rapidly as possible. One rod will be easy to twist and the other difficult. The effect is caused by the distribution of the mass in each rod. Because the ends of the rods move more rapidly than the middle during twisting, the student feels more

inertia in the rods with the masses at the ends than the rod with the masses in the middle. Relate this experience to the way the inertial balances operate.

2. Ask students to design an inertial balance that automatically counts oscillations.
3. Have students enter their calibration data into a graphing calculator and use the calculator to determine unknown masses when new measurement results are entered.

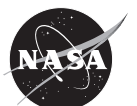

# Inertia and Microgravity

The microgravity environment of an orbiting Space Shuttle or space station presents many research problems for scientists. One of these problems is measurement of mass. On Earth, mass measurement is simple. Samples, such as a crystal, or subjects, such as a laboratory animal, are measured on a scale or beam balance. In a scale, springs are compressed by the object being measured. The amount of compression tells what the object's weight is. (On Earth, weight is related to mass. Heavier objects have greater mass.) Beam balances, like a seesaw, measure an unknown mass by comparison to known masses. With both these devices, the force produced by Earth's gravitational attraction enables them to function.

In microgravity, scales and beam balances don't work. Setting a sample on the pan of a scale will not cause the scale springs to compress. Placing a subject on one side of a beam balance will not affect the other side. This causes problems for researchers. For example, a life science study on the nutrition of astronauts in orbit may require daily monitoring of an astronaut's mass. In materials science research, it may be necessary to determine how the mass of a growing crystal changes daily. How can mass be measured without gravity's effects?

Mass can be measured in microgravity by employing inertia. Inertia is the property of matter that causes it to resist acceleration. If you have ever

tried to push anything that is heavy, you know about inertia. Imagine trying to push a truck. You will quickly realize that the amount of inertia or resistance to acceleration an object has is directly proportional to the object's mass. The more mass, the more inertia. By directly measuring an object's inertia in microgravity, you are indirectly measuring its mass.

The device employed to measure inertia and, thereby, mass is the inertial balance. It is a spring device that vibrates the subject or sample being measured. The object to be measured is placed in the sample tray or seat and anchored. The frequency of the vibration will vary with the mass of the object and the stiffness of the spring (in this activity, the hacksaw blade). An object with greater mass will vibrate more slowly than an object with less mass. The time needed to complete a given number of cycles is measured, and the mass of the object is calculated.



Payload Commander Dr. Rhea Seddon is shown using the Body Mass Measurement Device during the Spacelab Life Sciences 2 mission. The device uses the property of inertia to determine mass.



# Measuring Mass With Inertia

## Calibrating the Inertial Balance:

1. Clamp the inertial balance to the table so the spring (saw blade) and sample bucket extends over the edge of the table.
2. Pick one member of your team to be the timekeeper, another to record data, and another to count cycles. Refer to the box to the right for details on how to perform each task.
3. Begin calibration by inserting a wad of tissue paper in the bucket and deflecting the spring. Release the bucket and start counting cycles. When the time for 25 cycles is completed, enter the number in the data chart and plot the point on the graph for zero pennies. To improve accuracy, repeat the measurements several times and average the results.
4. Insert 1 penny into the bucket next to the tissue paper wad and measure the time it takes for 25 cycles. Record the data as 1 penny.
5. Repeat the procedure for 2 through 10 pennies and record the data.

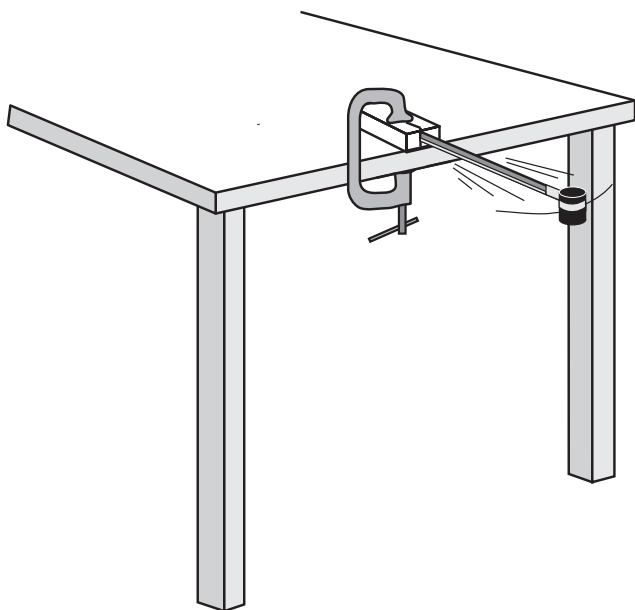

**Counter:** Pull the sample bucket a few centimeters to one side and release it. At the moment of release, say "Now" and begin counting cycles. A cycle is completed when the sample bucket starts on one side, swings across to the other and then returns to its starting point. When 25 cycles are complete, say "Stop."

**Timer:** Time the number of cycles being counted to the nearest tenth of a second. Start timing when the counter says "Now" and stop when the counter says "Stop."

**Recorder:** Record the time for 25 cycles as provided to you by the timer. There will be 11 measurements. Plot the measurements on the graph and draw a line connecting the points.

6. Draw a line that goes through or close to all points on the graph. Your inertial balance is calibrated.

## Using the Inertial Balance:

1. Place an unknown object in the inertial balance bucket. Remember to use the same tissue paper for stuffing. Measure the time for 25 cycles. And record your answer.
2. Starting on the left side of the graph, find the number of seconds you measured in step 1. Slide straight over to the right until you reach the graph line you drew in the previous activity. From this intersection point, go straight down to the penny line. This will tell you the mass of the unknown object in penny weights.

# Measuring Mass With Inertia

Measurement Team: \_\_\_\_\_

\_\_\_\_\_

\_\_\_\_\_

\_\_\_\_\_

## Calibration Graph

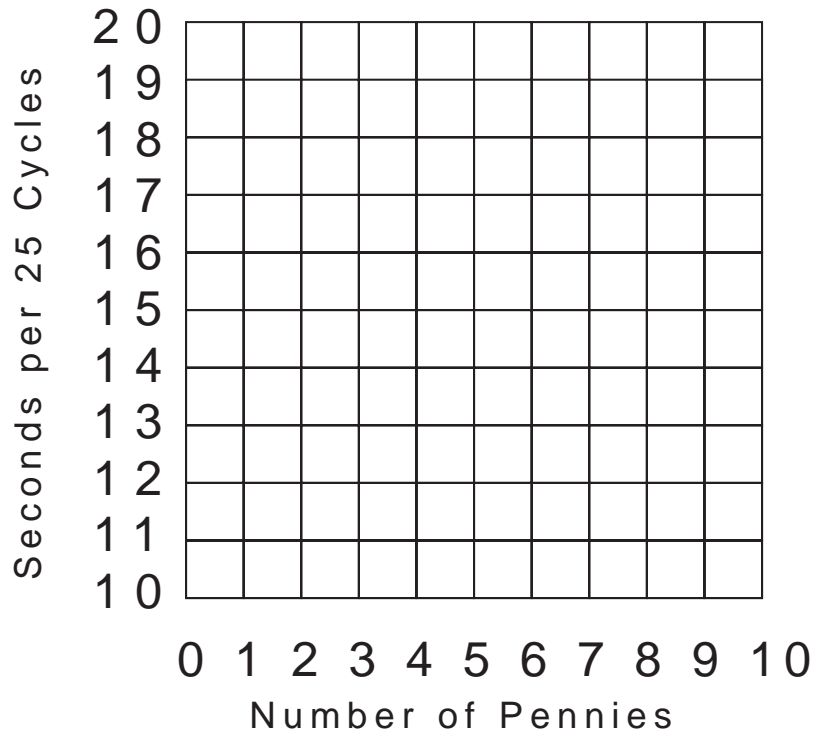

### Unknown Object 1

Mass: \_\_\_\_\_ pw

### Unknown Object 3

Mass: \_\_\_\_\_ pw

### Unknown Object 2

Mass: \_\_\_\_\_ pw

### Unknown Object 4

Mass: \_\_\_\_\_ pw





**Questions:**

1. Will this technique for measuring mass work in microgravity? Yes\_\_\_\_\_ No\_\_\_\_\_  
Explain your answer:

2. Why was it necessary to use tissue paper for stuffing?

3. How could you convert the penny weight measurements into grams?

4. Would the length of the hacksaw blade make a difference in the results?

5. What are some of the possible sources of error in measuring the cycles?

6. What does a straight line in the calibration graph imply?



## Gravity-Driven Fluid Flow

### Objective:

- To study gravity-driven fluid flow that is caused by differences in solution density.

### Science Standards:

- Science as Inquiry
- Physical Science
  - position and motion of objects
  - properties of Objects and Materials
- Unifying Concepts and Processes
- Change, Constancy, & Measurement
- Science and Technology
  - abilities of technological design

### Science Process Skills:

- Observing
- Communicating
- Collecting Data
- Inferring
- Hypothesizing
- Interpreting Data
- Controlling Variables
- Investigating

### Activity Management:

In this activity, students combine liquids of different densities to observe the fluid flow caused by gravity-driven buoyancy and settling. The activity is best done in student groups of two or three. It can also be done as a demonstration for the entire class. In this case, obtain an overhead projector and place beakers on the lighted stage. The light from below will illuminate the contents of the jars to make them easily visible from across the room. To reduce distraction, cover the projector lens to prevent blurry images from falling on the wall or screen behind. Caution: Be careful not to spill liquid on the projector.

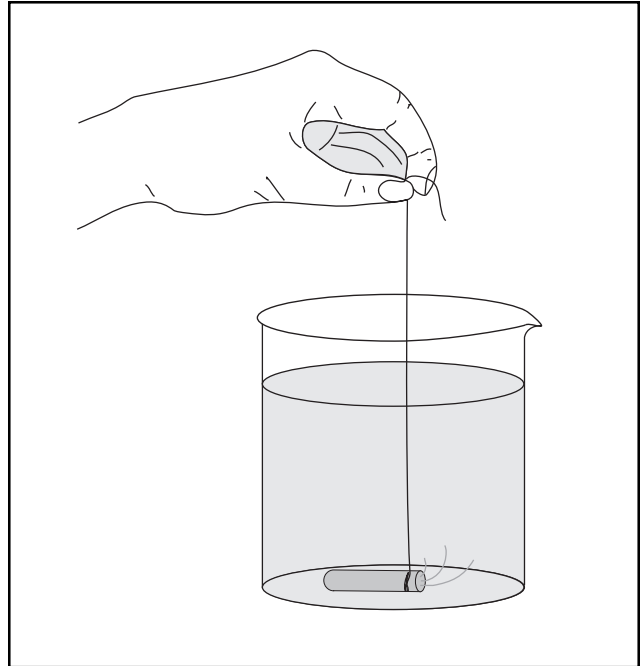

Water of different densities is mixed to produce gravity-driven fluid flow.

### MATERIALS AND TOOLS

- 2 large (500 ml) glass beakers or tall drinking glasses
- 2 small (5 to 10 ml) glass vials
- Thread
- Food coloring
- Salt
- Spoon or stirring rod
- Measuring cup (1/4 cup)
- Water
- Paper towels

If using this as an activity, provide each student group with a set of materials. Salt canisters, food coloring dispensers, and measuring cups can be shared among groups. The materials list calls for glass beakers or tall drinking glasses. Other containers can be substituted such as mason jars or plastic jars like those in which peanut butter is sold.



The vials are available from school science supply catalogs for a few dollars per dozen. Choose glass vials with screw tops and a capacity of 3 to 4 ml. Small cologne sample bottles can be substituted for the vials. It is important that the vials or bottles are not too large because the process of lowering large containers into the beakers can stir up the water too much. It is recommended you tie the string around the neck of the vial yourself to make sure there is no slippage.

The student instructions ask the students to conduct three different experiments. In the first, the effects of saltwater and freshwater are investigated. In the second, the effects of warm and cold water are investigated. The third experiment is an opportunity for students to select their own materials. They might try mixing oil and vinegar, sugar and saltwater, or oil and water. It may be necessary for the third experiment to be conducted on another day while the new materials are collected.

Give each student group at least one set of instructions and two data sheets. Save the student reader for use after the experiment.

### **Assessment:**

Discuss the experiment results to determine whether the students understand the concepts of buoyancy and sedimentation. Collect the student pages for assessment of the activity.

### **Extensions:**

1. How could this experiment be conducted if it were not possible to use food coloring for a marker? (In experiments where the density of the two fluids is very close, the addition of food coloring to one fluid could alter the results.)
2. Design an apparatus that can be used to combine different fluids for experiments on the future International Space Station.
3. Design an experiment apparatus that would permit the user to control the buoyancy and sedimentation rates in the beakers.
4. Design an experiment to measure the gravity-driven effects on different fluids in which the fluids are actually gases.



# Gravity-Driven Fluid Flow

Gravity is an important force at work in the movement of fluids. Fluids can be liquids or gases. The important thing about fluids is they can flow from place to place and can take the shape of the container they are in.

When you pour a liquid from one container into another, gravity is the driving force that accomplishes the transfer. Gravity also affects fluids “at rest” in a container. Add a small amount of heat to the bottom of the container and the fluid at the bottom begins to rise. The heated fluid expands slightly and becomes less dense. In other words, the fluid becomes buoyant. Cooler fluid near the top of the container is more dense and falls or sinks to the bottom.

Many crystals grow in solutions of different compounds. For example, crystals of salt grow in concentrated solutions of salt dissolved in water. In the crystal growth process, the ions that make up the salt come out of solution and are deposited on the crystal to make it larger. When this happens, the solution that held the molecule becomes a little less salty than it was a moment

ago. Consequently, the density of the solution is a little bit less than it was. This, in turn, causes a fluid flow in the solution. The slightly less salty solution is buoyant and rises to the top of the container while saltier, or more dense, solution moves in to take its place.

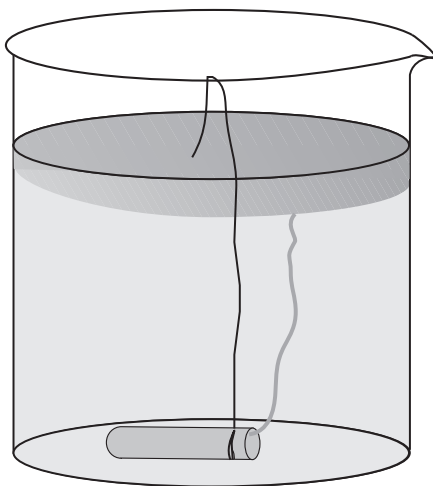

Dyed freshwater in saltwater beaker

Scientists are interested in gravity-driven fluid flows because they have learned that these flows, when occurring during the growth of crystals, can create subtle changes in the finished crystals. Flaws, called defects, are produced that can alter the way those crystals perform in various applications. Crystals

are used in many electronic applications, such as in computers and lasers.

To learn how to grow improved crystals on Earth, scientists have been growing crystals in the microgravity environment of Earth orbit. Microgravity virtually eliminates gravity-driven fluid flows and often produces crystals of superior quality to those grown on Earth. One of the major areas of materials science research on the International Space Station will involve crystal growth.



# Gravity-Driven Fluid Flow

## Procedure

1. Fill the first beaker with freshwater and set it on the lab surface. Also fill the second beaker with freshwater. Into the second beaker add approximately 50 to 100 grams of salt. Stir the water until the salt is dissolved.
2. Dip the first small glass vial into the beaker with freshwater. Fill it nearly to the top. Add a couple of drops of food coloring to the water in the vial. Close the top of the vial with your thumb and shake the water until the food coloring is mixed throughout. Place this vial next to the saltwater beaker.
3. Partially fill a second vial with salty water and food coloring. After mixing, place it in front of the beaker filled with freshwater.
4. Wait a few minutes until the water in the two beakers is still. Gently lift one of the vials by the string and slowly lower it into the beaker next to it. Let the vial rest on its side on the bottom of the beaker and drape the string over the side as shown in the pictures. Answer the questions on the data sheets and sketch what you observed in the diagrams.
5. Place the second vial in the other beaker as before. Make your observations, sketch what you observed, and answer the questions about the data.

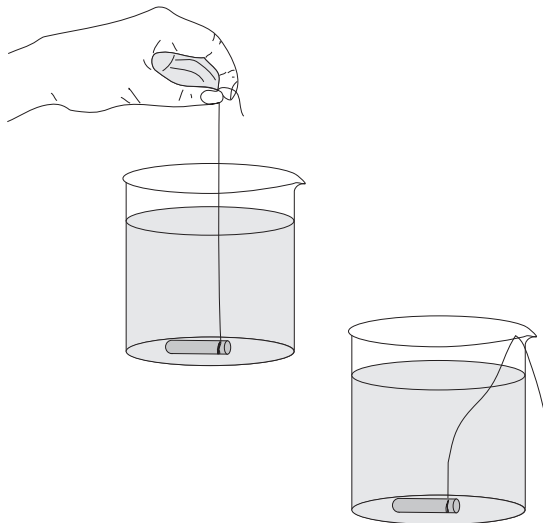

## Second Experiment Procedure:

1. Empty the two beakers and rinse them thoroughly.
2. Fill one beaker with cold water and the other with warm water.
3. Repeat steps 2 through 5 in the previous experiments.

## Original Experiment:

1. On a blank sheet of paper, write a proposal for an experiment of your own design that uses different materials in the beakers. Include in your proposal an experiment hypothesis, a materials list, and the steps you will follow to conduct your experiment and collect data. Submit your experiment to your teacher for review.
2. If your experiment is accepted for testing,
  - gather your materials
  - conduct the experiment
  - submit a report summarizing your observations and conclusions

# Gravity-Driven Fluid Flow Data Sheet

## Research Team Members:

---

---

---

---

### Beaker and Vial:

1. Water in beaker (check one)  
Fresh   
Salty
2. Water in vial (check one)  
Fresh   
Salty
3. Describe and explain what happened

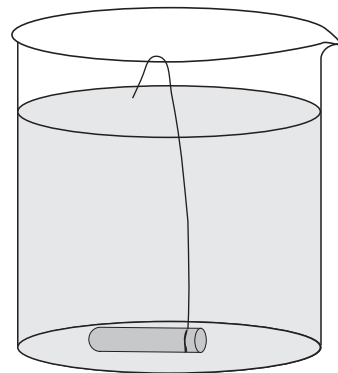

Sketch what happened.

### Beaker and Vial:

1. Water in beaker (check one)  
Fresh   
Salty
2. Water in vial (check one)  
Fresh   
Salty
3. Describe and explain what happened

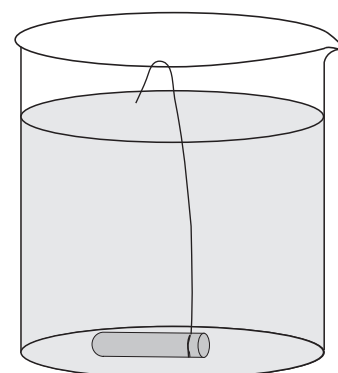

Sketch what happened.





# Surface Tension-Driven Flow

## Objective:

- To study surface tension and the fluid flows caused by differences in surface tension.

## Science Standards:

- Science as Inquiry  
Physical Science
- position and motion of objects
  - properties of objects and materials
- Unifying concepts and processes  
Change, Constancy, &  
Measurement
- evidence, models, & exploration

## Science Process Skills:

- Observing  
Communicating  
Measuring  
Collecting Data  
Inferring  
Predicting  
Interpreting Data  
Investigating

## Activity Management:

The purpose of this activity is to demonstrate how surface tension changes can cause fluids to flow. It requires shallow trays with raised edges such as cafeteria trays. Large Styrofoam food trays from a supermarket can also be used, but they should be the kind with a smooth surface and not a waffle texture. Light-colored trays make a better background for seeing the surface tension effects. Encourage students to try different mazes and investigate the effects of wide versus narrow mazes.

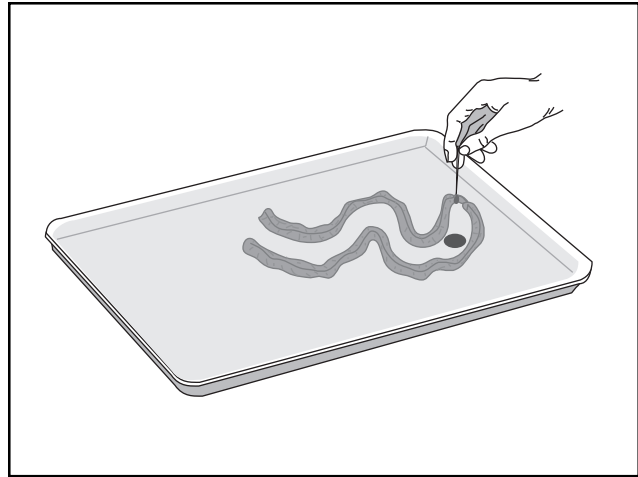

A clay maze is constructed on a cafeteria tray. Water is added. A drop of liquid soap disrupts the surface tension of the water and creates currents that are made visible with food coloring.

### MATERIALS AND TOOLS

Cafeteria tray (with raised edge)  
Plasticine modeling clay  
Water  
Liquid soap  
Food coloring  
Toothpick  
Paper towels  
Bucket or basin for waste water

Water handling will be a bit of a problem. After a drop of liquid soap is applied to the water, the water must be discarded and replaced before trying the activity again. Carrying shallow water-filled trays to a sink could be messy. Instead, it is recommended that a bucket or large waste basket be brought to the trays so the trays can be emptied right at the workstation.

When soap is applied to the water, food coloring at the water's surface will be driven along the maze by the disruption of the water's surface tension. Make sure students observe what happens to the water at the bottom of the tray as well. A reverse current flows along the bottom to fill in for the water that was driven along the surface.

Save the student reader for use after the activity.

### Assessment:

Conduct a class discussion to ensure the students understand that variations in surface tension in a fluid cause fluid flow. Collect the student pages.

### Extensions:

1. Demonstrate additional surface tension effects by shaking black pepper into a glass of water. Because of surface tension, the pepper will float. When a drop of soap is added to the water, the pepper will sink. This same effect can be seen in a broader view by placing water into a petri dish and adding pepper and then soap. The pepper will be driven to the sides of the dish where particles will start sinking. The petri dish experiment can be done as a demonstration with an overhead projector.
2. Make a surface tension-propelled paper boat by cutting a small piece of paper in the shape shown to the right and floating it on clean water. Touch a small amount of detergent to the water in the hole at the back of the boat.
3. Design an experiment to test whether the temperature of a liquid has any effect on surface tension.

4. Try floating needles on water and observe what happens when detergent is added. To float the needle, gently lower it to the water's surface with a pair of tweezers.



Surface Tension Paper Boat  
(actual size)



# Surface Tension



If you have ever looked closely at drops of water, you will know that drops try to form spherical shapes. Because of gravity's attraction, drops that cling to an eye dropper, for example, are stretched out. However, when the drops fall they become spherical.

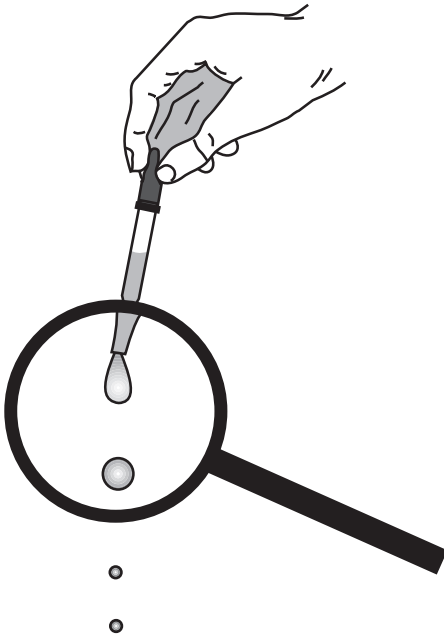

The shape of a water drop is a result of surface tension. Water is composed of molecules consisting of two hydrogen atoms and one atom of oxygen. These molecules attract each other. In the middle of a drop of water, molecules attract each other in all directions so no direction is preferred. On the surface, however, molecules are attracted across the surface and inward. This causes the water to try to pull itself into a shape that has the least surface area possible—the sphere. Because of gravity, drops resting on a surface, like water drops on a well-waxed car, flatten out somewhat like the figure above.

The molecules on the surface of a liquid behave like an elastic membrane. You can easily see the elastic membrane effect by floating a needle on the surface of a glass of water. Gently lower the needle to the water surface with a pair of tweezers. Examine the water near the needle and you will observe that it is depressed slightly as though it were a thin sheet of rubber.

The addition of a surfactant, such as liquid soap, to water reduces its surface tension. Water molecules do not bond as strongly with soap molecules as they do with themselves. Therefore, the bonding force that enables the molecules to behave like an elastic membrane is weaker. If you put a drop of liquid soap in the glass with the needle, the surface tension is greatly reduced and the needle quickly sinks. When you added liquid soap to the water in the experiment, the surface tension was weakened in one place. The water on the surface immediately began spreading away from the site of the soap. The clay walls channeled the flow in one direction. To make up for the water moving away from the site where the soap was added, a second water current formed in the opposite direction along the bottom of the tray.

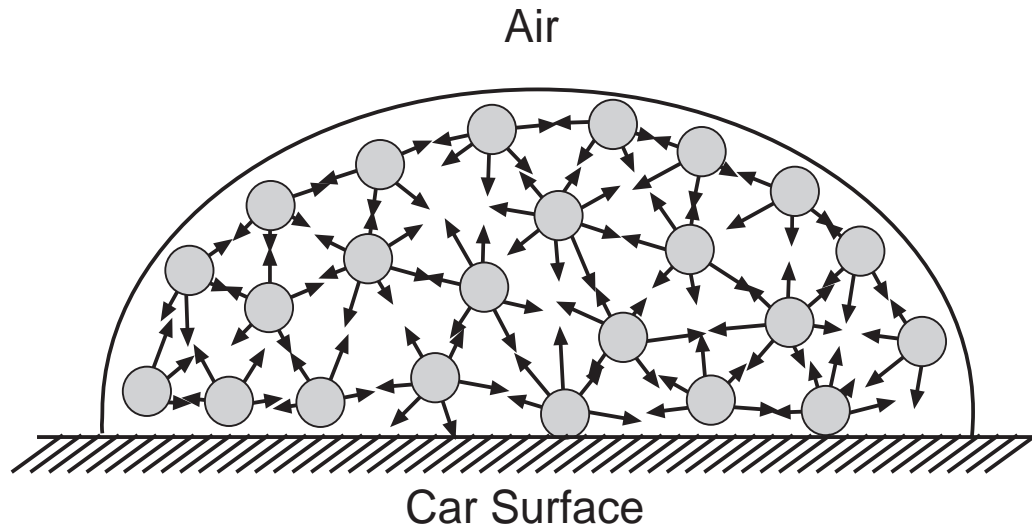

Molecules inside a water drop are attracted in all directions. Drops on the surface are attracted to the sides and inward.

Because a microgravity environment greatly reduces buoyancy-driven fluid flows and sedimentation, surface tension flows become very important. Microgravity actually makes it easier to study surface tension-driven flows. On Earth, studying surface tension in the midst of gravity-driven flows is like trying to listen to a whisper during a rock concert. The importance of surface tension research in microgravity is that surface tension-driven flows can interfere with experiments involving fluids. For example, crystals growing on the International Space

Station could be affected by surface tension-driven flows, leading to defects in the crystal structure produced. Understanding surface tension better could lead to new materials processing techniques that either reduce surface tension's influence or take advantage of it. One example of a positive application of surface tension is the use of sprayers to paint a surface. Surface tension causes paint to form very small droplets that cover a surface uniformly without forming drips and runs.

# Surface Tension-Driven Flows

## Team Members:

---

---

---

4. Dip the toothpick in the liquid soap and touch the end of the toothpick to the water at the end of the maze beyond the dye. Observe what happens.
5. Try a different maze to see how far you can get the dye to travel.

## Setup Instructions:

1. Roll clay into long "worms" 1 to 2 centimeters in diameter. Lay the worms out on the tray to produce a narrow valley about 3 to 4 centimeters wide that is closed on one end. Squeeze the worms so they stick to the tray and form thin walls.
2. Add water to the tray until it almost reaches the tops of the maze walls. Let the water settle before the next step.
3. Add a drop of food coloring to the maze near its end. Drop the coloring from a height of about 5 centimeters so that some of the food coloring spreads out slightly on the surface while the rest sinks to the bottom.

## Questions:

1. Why did the surface water move?
2. Did water near the bottom move as well? If it moved, why?

Make a sketch of the clay maze you constructed. Use arrows to show the direction of surface water movement after you added the soap. Use dashed line arrows to indicate the direction of any subsurface currents.



# Temperature Effects on Surface Tension

## Objective:

- To investigate the effects of temperature on the surface tension of a thin liquid.

## Science Standards:

- Science as Inquiry  
 Physical Science  
 - position and motion of objects  
 - properties of objects and materials  
 Unifying Concepts and Processes  
 Change, Constancy, & Measurement

## Science Process Skills:

- Observing  
 Communicating  
 Measuring  
 Collecting Data  
 Inferring  
 Predicting  
 Interpreting Data  
 Controlling Variables  
 Investigating

## Activity Management:

This experiment can be done as a student activity or a classroom demonstration for small groups of students. If done as a demonstration, it can be set up while students are conducting the Surface Tension-Driven Flows activity. Rotate small groups through the demonstration.

Be sure to use Pyrex® petri dishes for the demonstration. Also provide eye protection for yourself and the students. It is important that the heating surface of the hot plate be

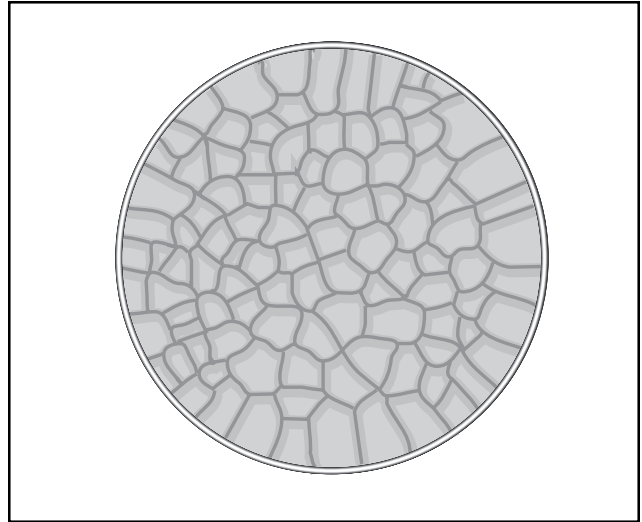

A thin pool of liquid heated from below exhibits polygonal cell structure due to surface tension-driven flows.

<b>MATERIALS AND TOOLS</b>	<p>Cooking oil                  Powdered cinnamon                  Two Pyrex® petri dishes and covers                  Laboratory hot plate                  Heat-resistant gloves, hotpad, or tongs                  Ice cubes                  Eye protection</p>
----------------------------	---

level. Otherwise, it will be necessary to add more oil to cover the bottom of the petri dish. A thin layer of oil is essential to the success of the experiment. Thin layers, on the order of 1 or 2 millimeter, do not exhibit significant convection currents as do layers that are much thicker. There simply is not enough room for convection currents to develop in thin layers. Heat is conducted through the thin layer to the surface very quickly. Since the lower and upper parts of





the liquid are at nearly the same temperature, no convection currents develop.

The demonstration is conducted with two petri dishes. Use the lids of both dishes for holding the oil and spice. To see the surface tension effects, sprinkle the cinnamon from a height of 20 or 30 centimeters to help it spread out evenly on the surface of the oil.

Place the first dish on the hot plate and observe that patterns are produced by the cinnamon. Before placing the second dish lid on the hot plate, invert and insert the bottom of the second dish into the lid. This will effectively place all the oil in contact with glass so there is not any exposed oil surface. The reason for the two different runs of the demonstration is to verify whether or not buoyancy-driven convection currents are involved in moving the cinnamon markers. If these currents are at work, the cinnamon will spread out and swirl through the oil. In other words, the second part of the demonstration is a control for the first part.

**Assessment:**

Conduct a class discussion on why it is important for microgravity scientists to understand about surface tension. Collect the student pages.

**Extensions:**

1. Experiment with other fluid and marker combinations. Several microgravity experiments in space have used 10 centistoke silicone oil (dimethylpolysiloxane) with powdered aluminum as a marker. Both chemicals are available from chemical supply catalogs. The demonstration works best if the aluminum is more flaky than powder. Aluminum flakes will provide reflective surfaces that intensify the optical effect. You can make your own aluminum flakes by obtaining flat enamel hobby paint and allowing the aluminum flakes to settle to the bottom of the bottle. Pour off the fluid and wash the sediment several times with nail polish remover and let dry.
2. Videotape the convective flow patterns and play them back at different speeds to see more details on how surface tension-driven flows develop.
3. Look for patterns in nature, such as mud cracks, that are similar to the patterns seen in this activity. Are nature's patterns produced in the same way or by some different mechanism?



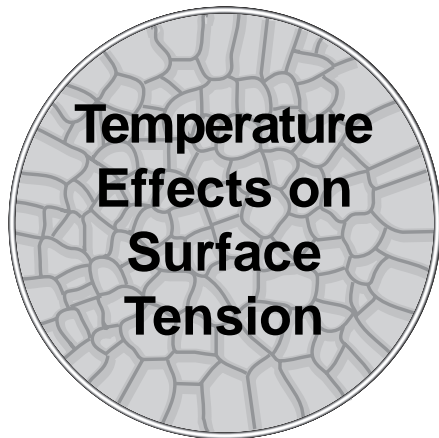

Around the turn of this century, physicist Henri Benard discovered that liquid in thin pools heated from below quickly forms flow patterns consisting of polygonal cells. He made this discovery by placing tiny markers in the fluid that showed how the fluid moved. The cells resembled those that form due to convection currents when a pot of soup is heated. The interesting thing about Benard's discovery is that buoyancy-driven convection currents were not responsible for the flow that was produced.

When a thick pool of liquid is heated from below, liquid at the bottom expands and becomes less dense. Because of buoyancy, the less dense liquid rises to the top of the pool where it spreads out. Cooler surrounding liquid moves in to take the place of the warmer fluid that rose to the top. This liquid heats up, becomes less dense, and also rises to the top to create a cycle that continues as long as heat is applied. This cycling is called a buoyancy-driven convection current.

The problem with studying fluid flows in a heating pot of soup is that convection currents appear to be the only force at work. Actually, surface tension flows are also present but, because they are of lower intensity, they are masked by the more violent buoyancy-driven convection currents. By creating a very thin liquid pool (about 1 mm or thinner), Bénard was able to

eliminate buoyancy-driven convection. In very thin liquids there just is not enough vertical distance for significant buoyancy-driven convection currents to get started. The fluid flow Benard observed was produced by changes in surface tension.

In the cooking oil experiment, you observed two petri dishes with a thin layer of oil and powdered cinnamon markers. The uncovered dish, when heated from below, began forming circular cells that eventually grew into each other to produce polygonal cells. Heat from hot spots in the hot plate was quickly conducted to the surface of the oil. The increase in temperature of the oil reduced the surface tension in those locations. This reduction was apparent because the oil flowed from the center of the hot spots in all directions to the outside. Compare this action to what happened when a drop of liquid soap was touched to the surface of a tray of water in the previous activity. In the second petri dish, a layer of glass was placed over the thin oil layer so the oil did not have an exposed surface. In this manner, surface tension effects were eliminated. No fluid flows were observed, meaning that

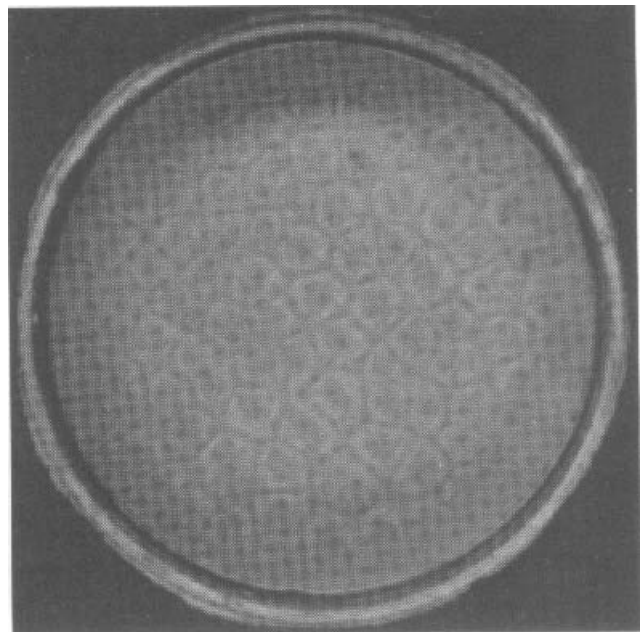

Polygonal cells produced in a thin pool of liquid heated from below.



buoyancy-driven convection was not at work. This demonstration served as a scientific control for the first experiment.

In fluid physics experiments aboard the Space Shuttle and the International Space Station, buoyancy is practically eliminated because of microgravity. Surface tension, however, becomes an important force because it is not a gravity

dependent phenomenon. In crystal growing and other fluid physics experiments, surface tension-driven flows can affect the outcome. For this reason, scientists are trying to understand the mechanics of surface tension-driven flows in microgravity.

In these two diagrams, the difference between buoyancy-driven convection currents (left) and surface tension-driven convection currents (right) is shown. Flow in the left diagram is produced by changes in fluid density brought about by heating the bottom. Flow in the right diagram is brought about by reducing surface tension above a heated plate.

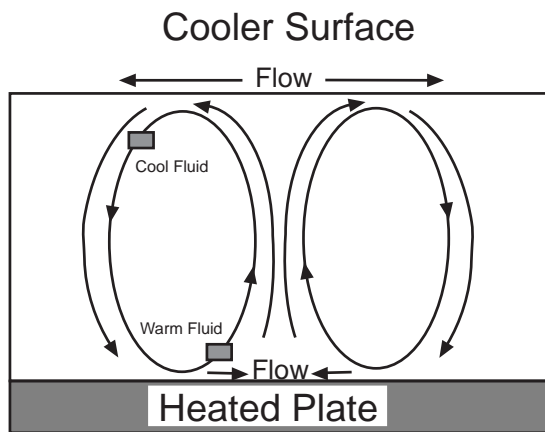

Thick Liquid Pool

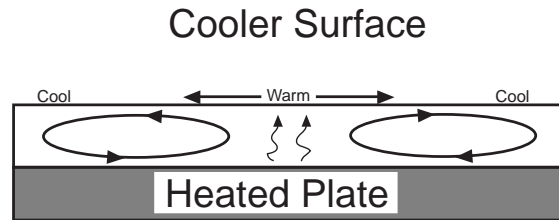

Thin Liquid Pool

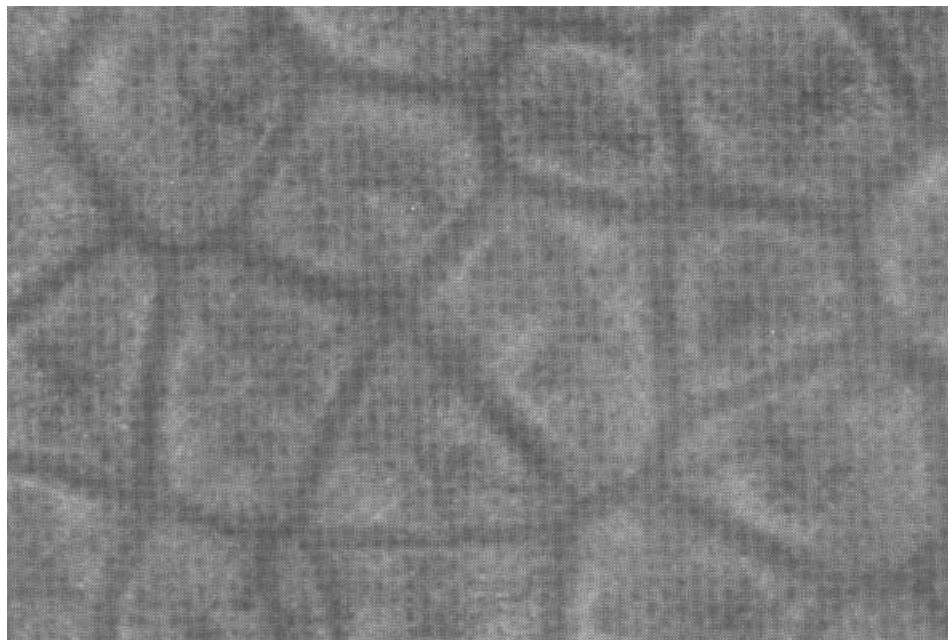

Magnified view of the polygonal cells that are produced by surface tension-driven convection.

# Temperature Effects on Surface Tension

Name: \_\_\_\_\_

1. Sketch the fluid flow patterns that appeared in the thin pool of cooking oil when heat was applied to the bottom of the first petri dish. Indicate with arrows which direction(s) the fluid flowed.

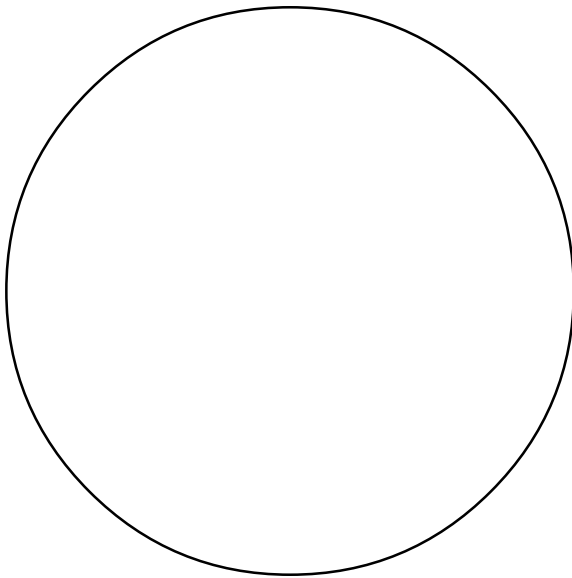

What effect did an increase in temperature have on the surface tension of the oil?

Why?

2. Sketch the fluid flow patterns that appeared when heat was applied to the bottom of the second petri dish. Indicate with arrows the direction(s) of any fluid flows observed.

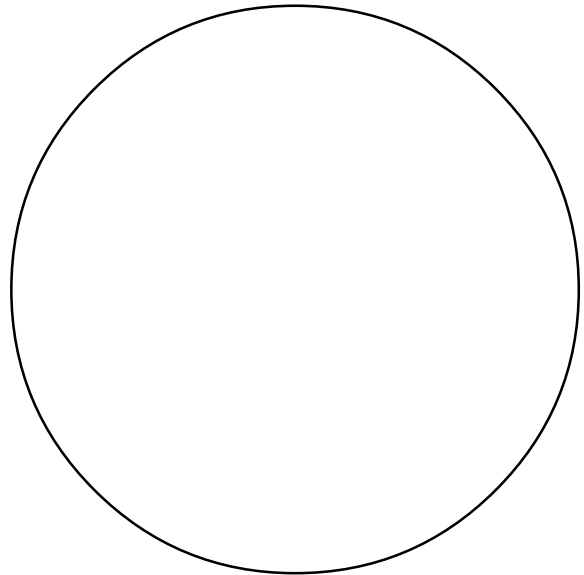

Explain what you observed.

What effect on surface tension do you predict lowering the temperature of the oil would have? How could this be observed?





# Candle Flames

## Objective:

- To investigate the effect of gravity on the burning rate of candles.

## Science Standards:

Science as Inquiry  
Physical Science  
- properties of objects & materials  
Unifying Concepts & Processes  
Change, Constancy, &  
Measurement

## Science Process Skills:

Observing  
Communicating  
Measuring  
Collecting Data  
Inferring  
Hypothesizing  
Predicting  
Investigating

## Mathematics Standards:

Measurement

## Activity Management:

This activity serves as an introduction to the candle drop activity that follows. In both activities, students are organized into cooperative learning groups of three. It may be useful to keep the same groups together for both activities.

The objective of this activity is to observe candle flame properties and prepare students to make observations of candle flames in microgravity where observing conditions are more difficult. Before

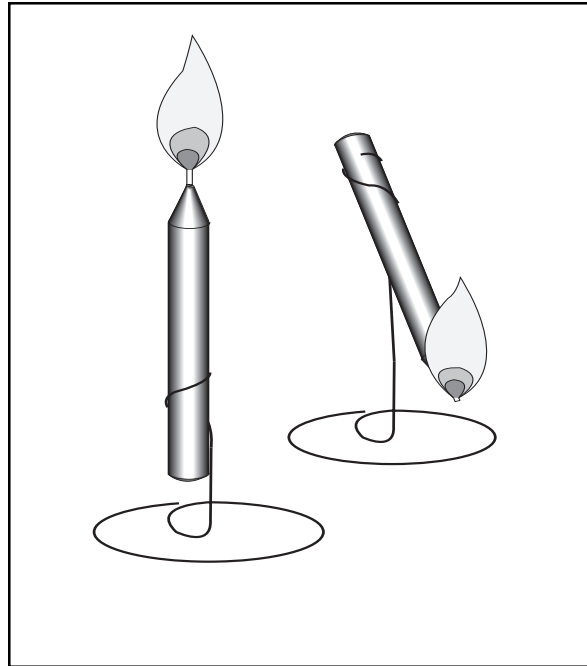

The burning rate and other properties of candle flames are investigated.

## MATERIALS AND TOOLS

Birthday candles (2 per group)  
Matches  
Balance beam scale (0.1 gm or greater sensitivity)  
Clock with second hand or stopwatch  
Wire cutter/pliers  
Wire (florist or craft)  
20 cm square of aluminum foil  
Eye protection

letting students start the activity, conduct a discussion on the different observations they can make. Make a list of terms that can be used to describe flame shape, size, color, and brightness.

At the end of the experiment, student groups are asked to write a hypothesis to explain the differences observed in the burning of the two candles. It may be helpful to discuss hypothesis

writing before they get to that part. The hypotheses should relate to gravity-induced effects. In the case of candle 2, the wax of the candle is above the flame. Convection currents (a gravity-driven phenomenon) deliver lots of heat to the candle which causes more rapid melting than occurs with candle 1. Much of that wax quickly drips off the candle (gravity pulls the wax off) so more wick is exposed and the candle burns faster.

The wire used in this activity is a lightweight wire of the kind used by florists and in craft work. You can find this wire in craft and hardware stores. Do not use wire with plastic insulation. The flame of the candle tipped at an angle of 70 degrees may reach the wire and begin burning the insulation. Each group will need two wires about 20 centimeters long. Precut the aluminum foil into 20 centimeter squares. One square is needed for each group.

Provide each group with one set of student sheets. Save the student reader for use after the activity has been completed.

### Assessment:

Discuss student observations of the candle burning and their hypotheses. Collect the student work sheets for assessment.

### Extensions:

1. Burn a horizontally held candle for one minute. Weigh the candle before lighting it. As it burns, record the colors, size, and shape of the candle flame. Weigh the candle again and calculate how much mass was lost.
2. Repeat the above experiments with the candles inside a large sealed jar. Let the candles burn to completion. Record the time it takes each candle to burn. Determine how and why the burning rate changed.
3. Burn two candles which are close together. Record the burning rate and weigh the candles. Is the burning rate faster or slower than each candle alone? Why?
4. Investigate convection currents with a convection current demonstration apparatus that is obtained from science supply catalogs, or construct the apparatus as shown below.
5. Obtain a copy of Michael Faraday's book, *The Chemical History of a Candle*, and do the experiments described. (See reference list.)

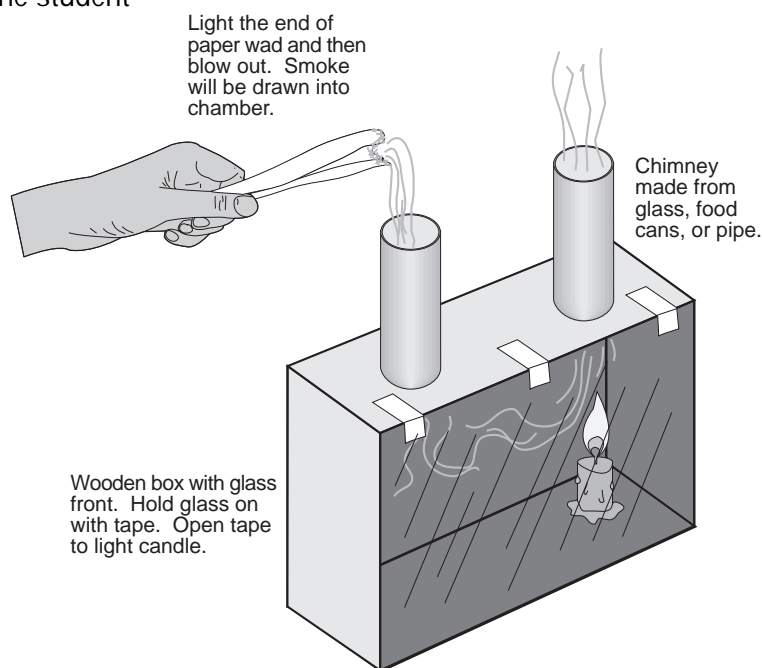



# Candle Flames

Candles are useful for illustrating the complicated physical and chemical processes that take place during combustion. The candle flame surface itself is the place where fuel (wax vapor) and oxygen mix and burn at high temperatures, radiating heat and light. Heat from the flame is conducted down the wick and melts the wax at the wick base. The liquid wax rises up the wick because of capillary action. As the liquid wax nears the flame, the flame's heat causes it to vaporize. The vapors are drawn into the flame where they ignite. The heat produced melts more wax, and so on.

Fresh oxygen from the surrounding air is drawn into the flame primarily because of convection currents that are created by the released heat. Hot gases produced during burning are less dense than the cooler surrounding air. They rise upward and, in doing so, draw the surrounding air, containing fresh oxygen, into the flame. Solid particles of soot, that form in the region between the wick and flame, are also carried upward by the convection currents. They ignite and form the bright yellow tip of the flame. The upward flow of hot gases causes the flame to stretch out in a teardrop shape.

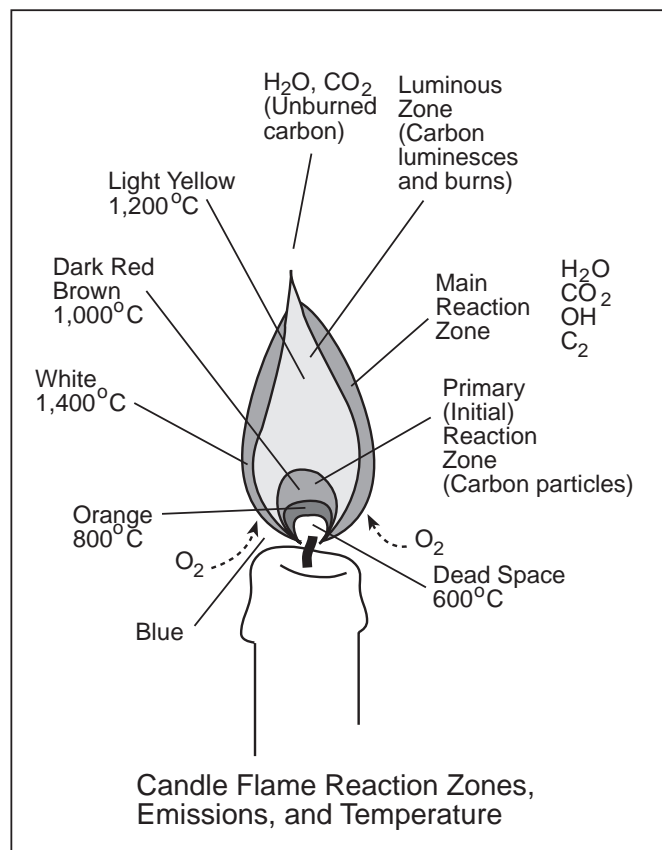
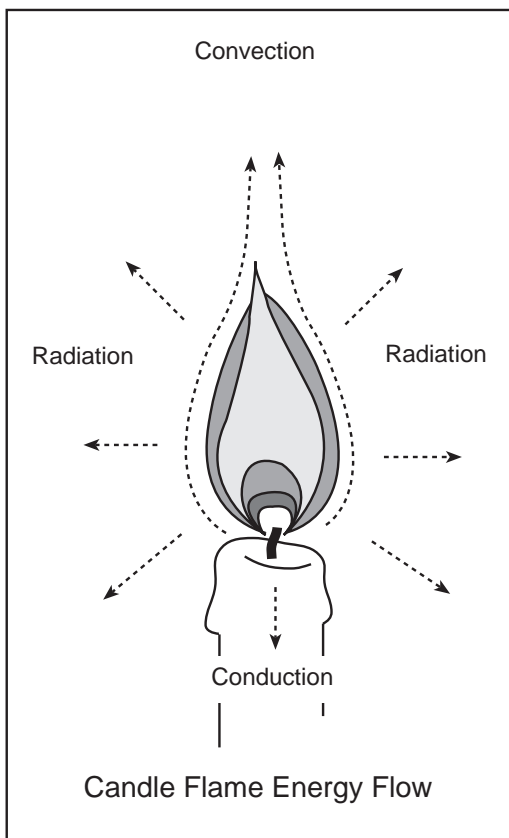

Candle flame diagrams adapted from "The Science of Flames" poster, National Energy Foundation, Salt Lake City, UT.



# Candle Flames

## Candle Flame Research

### Team Members:

---

---

---

4. Place candle 1 on the aluminum square. Light the candle and let it burn for 1 minute. While it is burning, observe what is happening and write your observations below.

---

---

---

---

### Procedure:

1. Make a wire stand for each candle so that it looks like the picture below.
2. Weigh each candle by standing it on a balance beam scale and recording its weight in grams on the chart on the next page.
3. Put on eye protection.

Draw a life-size picture of the candle flame.

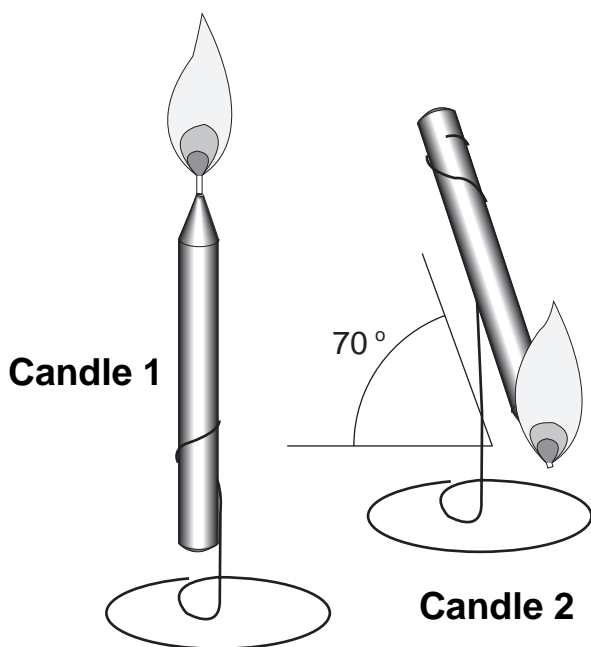
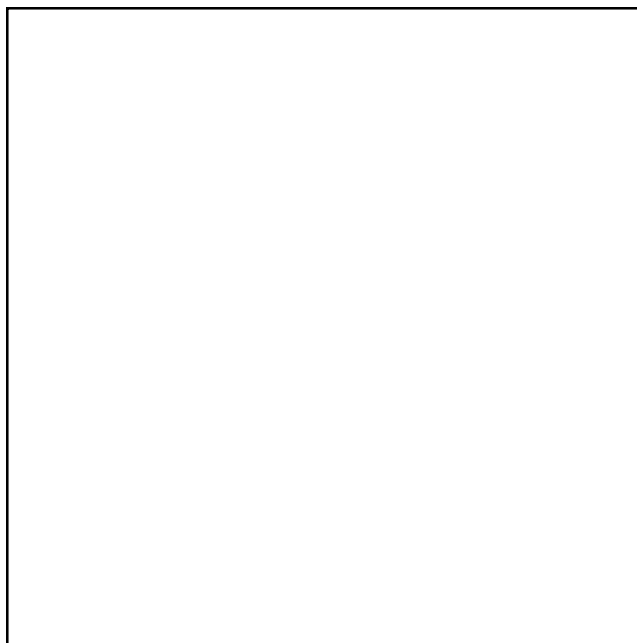

Weigh candle 1 again and record its mass in the chart.



5. Place candle 2 on the aluminum square. Light the candle and let it burn for 1 minute. While it is burning, observe what is happening and write your observations below.

---



---



---



---

Draw a life-size picture of the candle flame.

Weigh candle 2 again and record its mass in the table.

Calculate the difference in mass for each candle and enter your answers in the table.

### Candle Mass Table

	1	2
Before burning mass		
After burning mass		
Difference		

Summarize your observations below.

---



---



---



---



---



---

Write a hypothesis for how you think a candle will burn in microgravity.

---



---



---



---



---



---



## Candle Flame in Microgravity

### Objective:

- To observe candle flame properties in freefall.

### Science Standards:

- Science as Inquiry
- Physical Science
  - position and motion of objects
- Unifying Concepts & Processes
- Change, Constancy, & Measurement
- Science & Technology
  - abilities of technological design

### Science Process Skills:

- Observing
- Communicating
- Collecting Data
- Inferring
- Predicting
- Interpreting Data
- Hypothesizing
- Controlling Variables
- Investigating

### Activity Management:

Before attempting this activity, be sure to conduct the Candle Flames activity. Doing so will sharpen the observation skills of the students. This is important because, in this activity, students will be observing the size, shape, and color of a candle flame as it is falling.

Investigating candle flames in microgravity can be done as either a demonstration or an activity. If used as a demonstration, only one candle drop jar is necessary. If used as an activity, one candle drop jar is needed for each student group. Clear plastic food storage jars are available at variety

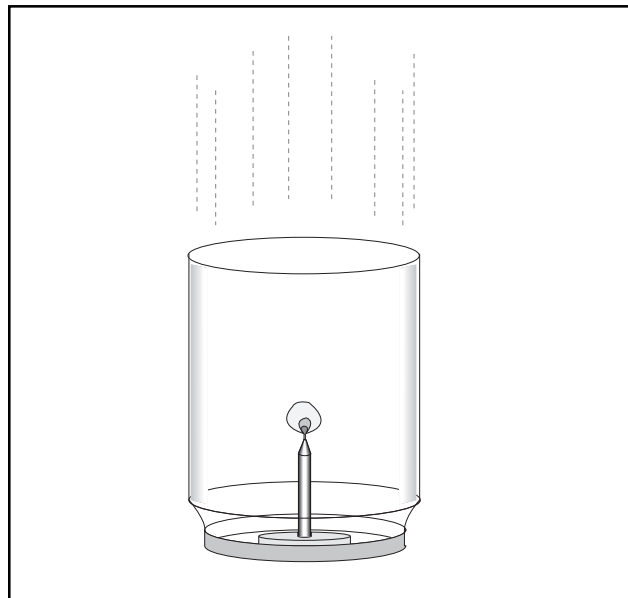

A burning candle is encased by a clear plastic jar and dropped for a study of flames in microgravity.

### MATERIALS AND TOOLS

- Clear plastic jar and lid (2 liter volume)\*
- Wood block
- Screws
- Birthday candles
- Matches
- Drill and bit
- Video camera and monitor (optional)
- Eye protection
- \* Empty 3-lb plastic peanut butter jar can be used.

stores, but plastic peanut butter jars will work as well. The jars should be 1 quart or half gallon size (3 pound size if peanut butter jars are used). The oxygen supply in smaller jars runs out too quickly for proper observations.

The wood block and screws called for in the materials and tools list can be replaced with a lump of clay. Press the lump to the inside of the



jar lid and push the end of the candle into the clay. It will probably be necessary to reform and/or reposition the clay after a couple of drops. The wood block and screws make a longlasting candle drop jar.

If you are using wood blocks and screws, prepare the candle drop jars by drilling a hole in the center of the block to hold the end of the candle. Drill two pilot holes into the wood for the screws. Finally, drill holes through the plastic jar lid. With the block in place, insert screws through the lid holes and screw them into the wood block where you drilled the pilot holes. The candle drop jar is ready.

If you are using this as an activity, divide students into groups of three. Save the student reader for use after the experiment has been conducted. Students will drop the candle at least three times during their investigation. During the drops, there are three jobs that must be performed. One student will drop the candle, another will catch it, and the third will observe the properties of the candle flame as it falls. The jobs should be rotated through the group so each student performs each job once.

Since fire is used, be sure everyone working with the activity wears eye protection. The activity works best in a room that can be darkened. Coordinate the observations of the student groups so all are ready to drop the candle when the lights are dimmed.

Students will observe that the first time a birthday candle is lit, the flame is larger than when it is lit again. This happens because the wick sticks out farther from the wax on a new candle than it does on a used candle. The excess is burned quickly and the flame size diminishes slightly.

### **Assessment:**

Use the student pages for assessment. For additional work, have students actually build a model of the microgravity experiment they are instructed to design in the last step on the student pages. The students can present their ideas to the rest of the class and exhibit their device.

### **Extensions:**

1. If videotape equipment is available, videotape the candle flame during the drop. Use the pause control during the playback to examine the flame shape.
2. If a balcony is available, drop the jar from a greater distance than is possible in a classroom. Does the candle continue to burn through the entire drop? For longer drops, it is recommended that a catch basin be used to catch the jar. Fill up a large box or plastic trash can with Styrofoam packing material or loosely crumpled plastic bags or newspaper.



# Candle Flames in Microgravity

Microgravity experiments using drop towers and Space Shuttle Orbiters have provided scientists valuable insights on how things burn. In the typical experiment, a flammable material, such as a candle, is ignited by a hot wire. The ignition and combustion process is recorded by movie cameras and other data collection devices. Using these devices, scientists have learned there are significant differences between fires on Earth in normal gravity and those in microgravity.

The sequence of pictures, at the bottom of this page, illustrates a combustion experiment conducted at the NASA Lewis Research Center 132 Meter Drop Tower. These pictures of a candle

flame were recorded during a 5-second drop tower test. An electrically heated wire was used to ignite the candle and then withdrawn 1 second into the drop. As the pictures illustrate, the flame stabilizes quickly, and its shape appears to be constant throughout the remainder of the drop. Instead of the typical teardrop shape seen on Earth, the microgravity flame becomes spherical. On Earth, the flame is drawn into a tip by the rising hot gases. However, convection currents are greatly reduced in microgravity. Fresh oxygen is not being delivered to the candle by these currents. Instead, oxygen works its way slowly to the flame by the process of diffusion. Soon, the flame temperature begins to drop because the

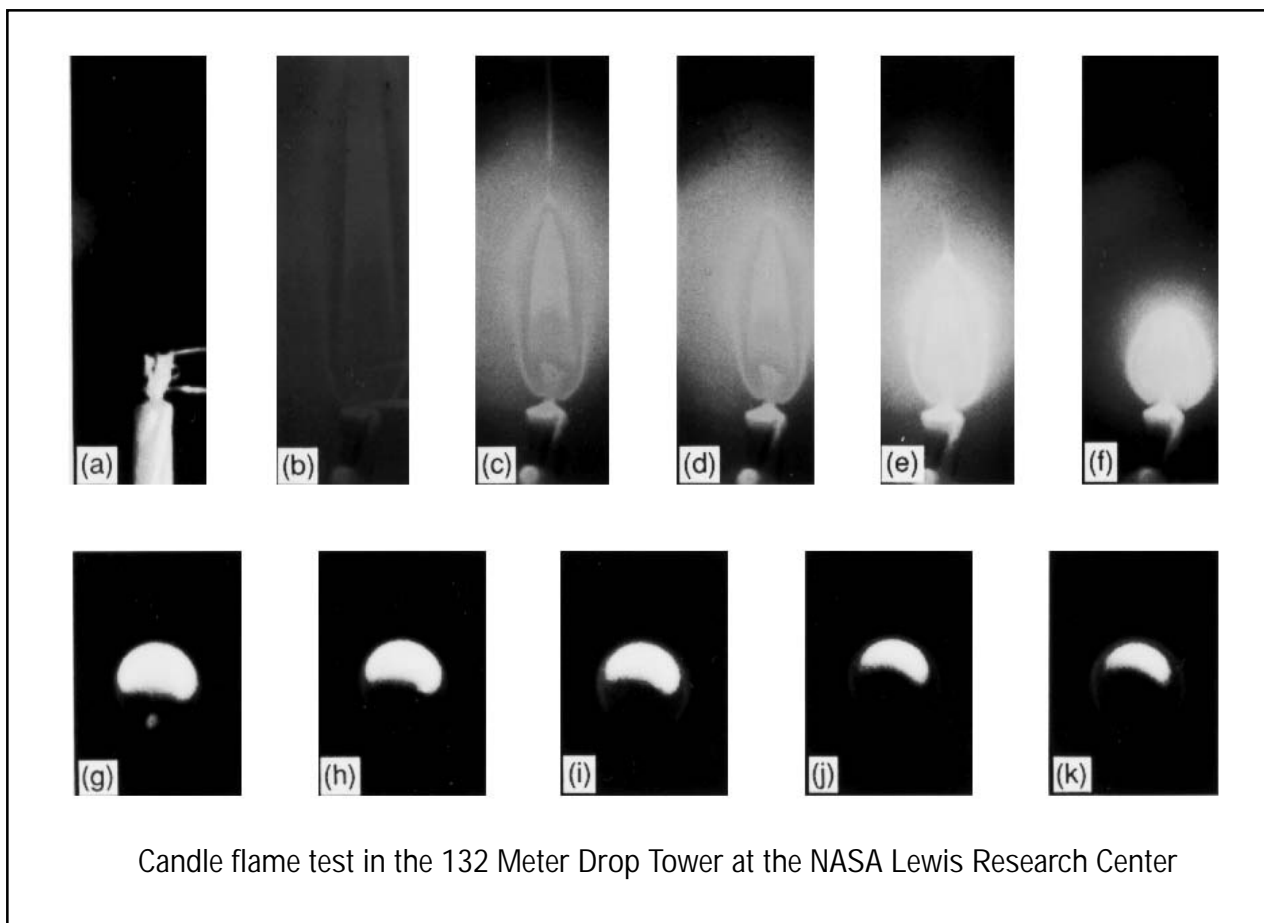



combustion is less vigorous. The lower temperature slows down the melting and vaporization of the candle wax. Candles onboard the first United States Microgravity Laboratory, launched in June 1992, burned from 45 seconds to about 1 minute before being extinguished because of the dropping temperature and reduction of wax vapor.

Combustion studies in microgravity are important to spacecraft safety. Unlike house fires on Earth, you can not run outside of a space station and wait for the fire department to arrive. Fires have to be extinguished quickly and safely. To do this it is essential to understand how fires are ignited in microgravity and how they spread. The goal is to make sure that a fire never gets started.

In the absence of buoyancy-driven convection, as in microgravity, the supply of oxygen and fuel vapor to the flame is controlled by the much slower process of molecular diffusion. Where there is no “up” or “down,” the flame tends toward sphericity. Heat lost to the top of the candle causes the base of the flame to be quenched, and only a portion of the sphere is seen. The diminished supply of oxygen and fuel causes the flame temperature to be lowered to the point that little or no soot forms. It also causes the flame to anchor far from the wick, so that the burning rate (the amount of wax consumed per unit time) is reduced.



# Candle Drop

## Candle Drop Team Members:

---

---

---

What is the color of the flame?

---

Predict what you think will happen to the candle flame when the candle is dropped.

---

---

---

## Procedure:

1. Put on eye protection.
2. Light the candle and screw the jar on to the lid. Observe the candle until it goes out.
3. Draw a picture of the shape of the candle flame below.
4. Open the jar to release the bad air. Relight the candle and screw the jar back on to the lid. Have one team member hold the jar as high off the floor as possible. On the count of three, the jar is dropped to the floor where a second team member is waiting to catch it. The third member acts as the observer. Data are recorded by the observer in the table on the next page.
5. Repeat step 4 twice more but rotate the jobs so each team member gets the chance to drop the jar, catch the jar, and write down observations.



# Candle Drop Data Table

Team Member:

1

2

3

Candle flame shape			
Candle flame brightness			
Candle flame color			
Other observations			

What changes took place when the candle flame experienced microgravity?

---

---

Compare these changes to the candle flame that was not dropped.

---

---

Why do you think these changes took place?

---

---

Design a candle flame experiment that could be used on the International Space Station. Write out, on another piece of paper, the experiment hypothesis and sketch the apparatus that will be needed. Write a short paragraph describing the device, how it will work, and what safety procedures you would use.



# Crystallization Model

## Objective:

- To demonstrate how atoms in a solid arrange themselves.

## Science Standards:

- Science as Inquiry  
 Physical Science  
 - position and motion of objects  
 Unifying Concepts & Processes  
 Change, Constancy, &  
 Measurement  
 Science & Technology  
 - abilities of technological design

## Science Process Skills:

- Observing  
 Communicating  
 Collecting Data  
 Inferring  
 Predicting  
 Interpreting Data  
 Hypothesizing  
 Controlling Variables  
 Investigating

## Activity Management:

The crystal model device described here is best suited for use as a classroom demonstration. It is a vibrating platform that illustrates in two dimensions the development of crystal structure and defect formation. BBs, representing atoms of one kind, are placed into a shallow pan which is vibrated at different speeds. The amount of vibration at any one time represents the heat energy contained in the atoms. Increasing the vibration rate simulates heating of a solid material.

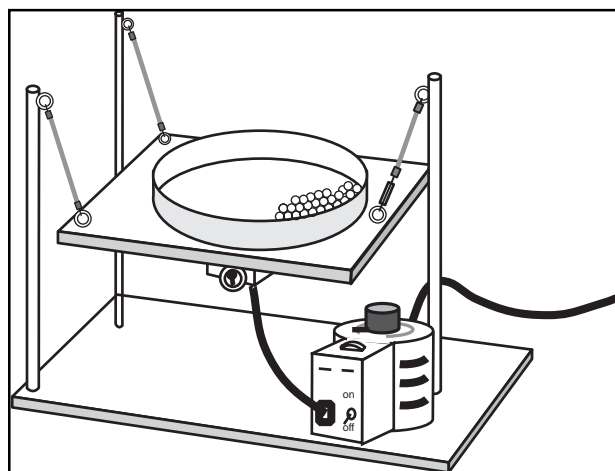

BBs on a vibrating platform arrange themselves in patterns similar to the atoms in solids.

<b>MATERIALS AND TOOLS</b>	Wood base and supports Shallow pan 3 Small bungee cords Small turnbuckle Surplus 1 10 volt AC electric motor Motor shaft collar Variable power transformer Several hundred BBs Hook and loop tape
----------------------------	---

Eventually, the atoms begin to separate and move chaotically. This simulates melting. Reducing the amount of vibration brings the atoms back together where they “bond” with each other. In this demonstration, gravity pulls the BBs together to simulate chemical bonds. By observing the movement of BBs, a number of crystal defects can be studied as they form and transform. Because of movements in the pan, defects can combine (annihilation) in such a way that the ideal hexagonal structure is achieved and new defects form.



The model is viewed best with small groups of students standing around the device. After the solid “melts,” diminish the motor speed gradually to see the ways the atoms organize themselves. It is important that the platform be adjusted so it is slightly out of level. That way, as the motor speed diminishes the BBs will move to the low side of the pan and begin organizing themselves. If this does not happen, apply light finger pressure to one side of the pan to lower it slightly. This will not affect the vibration movements significantly. While doing the demonstration, also stop the vibration suddenly. This will simulate what happens when molten material is quenched (cooled rapidly) .

The motor collar required in the materials list is available from a hardware store. The purpose of the collar is to provide an offcenter weight to the shaft of the motor. The set screw in the collar may have to be replaced with a longer one so that it reaches the motor shaft for proper tightening.

## Constructing The Vibrating Platform

Note: Specific sizes and part descriptions have not been provided in the materials list because they will depend upon the dimensions of the surplus electric motor obtained. The motor should be capable of several hundred revolutions per minute.

1. Mount three vertical supports on to the wooden base. They can be attached with corner braces or by some other means. 2. Mount the surplus motor to the bottom of the vibrating platform. The specific mounting technique will depend upon the motor. Some motors will feature mounting screws. Otherwise, the motor may have to be mounted with some sort of strap. When mounting, the shaft of the motor should be aligned parallel to the bottom of the platform.
3. Slip the collar over the shaft of the motor and tighten the mounting screw to the shaft. See the diagram below for how the shaft and collar

should look when the collar is attached properly.

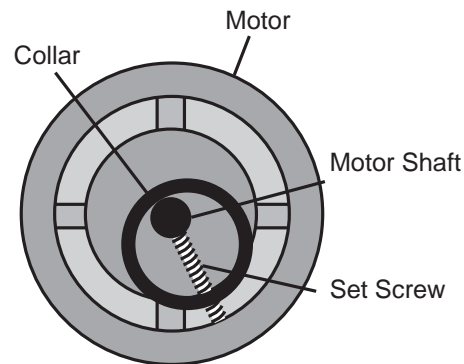

4. Suspend the platform from the three vertical supports with elastic shock (bungee) cords or springs. Add a turnbuckle to one of the cords for length adjustment. Shorten that cord an amount equal to the length of the turnbuckle so the platform hangs approximately level.
5. Using hook and loop tape, mount the pan on the upper side of the vibrating platform.
6. Place several hundred BBs in the pan. If the BBs spread out evenly over the pan, lengthen the turnbuckle slightly so the BBs tend to accumulate along one side of the pan.
7. Turn on the motor by raising the voltage on the variable transformer. If the device is adjusted properly, the BBs will start dancing in the pan in a representation of melting. Lower the voltage slowly. The BBs will slow down and begin to arrange themselves in a tight hexagonal pattern. If you do not observe this effect, adjust the leveling of the platform slightly until you do. It may also be helpful to adjust the position of the motor slightly.

## Conducting The Experiment

1. Turn up the voltage on the variable transformer until the BBs are dancing about in the pan. This represents melting of a solid.
2. Shut the variable transformer off. This represents rapid cooling of the liquid to a glassy (amorphous) state. Observe and sketch the pattern of the BBs and of the defects.
3. Turn up the voltage again and gradually reduce the vibration until the BBs are moving slowly. Observe how the BBs move and pack together.

### Assessment:

Collect the student work sheets.

## Extensions:

1. Obtain some mineral crystal samples and examine them for defects. Most crystals will have some visible defects. The defects will be at a much larger scale than those illustrated in the student reader. One defect that is easy to find in the mineral quartz is color variations due to the presence of impurities.
2. Investigate the topic of impurities deliberately incorporated in crystals used to manufacture computer chips. What do these defects do?
3. Design a crystal-growing experiment that could be used on the International Space Station. Conduct a ground-based version of that experiment. How would the experiment apparatus have to be changed to work on the space station?





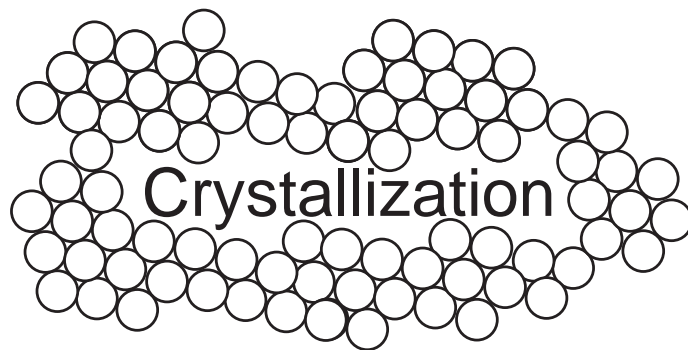

Crystalline solids are substances whose atoms or molecules are arranged into a fixed pattern that repeats in three dimensions. Crystalline materials generally begin as a fluid of atoms or molecules in either the liquid or gaseous state. As they change to the solid state, the atoms or molecules join together in repeating patterns. Materials that do not form these patterns are called amorphous. Glass is a good example of an amorphous material.

The usefulness of a crystal depends on its structure. All crystalline materials have varying degrees of defects. Defects can take many forms. Gem-quality diamonds sometimes have small inclusions of carbon (carbon spots) that diminish their light refraction and thereby reduce their value. In other crystalline materials, defects may actually enhance value. Crystals used for solid state electronics have impurities deliberately introduced into their structure that are used to control their electrical properties. Impurity atoms may substitute for the normal atoms in a crystal's structure or may fit in the spaces within the structure. Other defects include vacancies, where atoms are simply missing from the structure, and dislocations, in which a half plane of atoms is missing. The important thing about crystal defects is to be able to control their number and distribution. Uncontrolled defects can result in unreliable electronic properties or weaknesses in structural metals.

### Sample Crystal Defects

The following diagrams show a magnified view of an ideal two-dimensional crystalline structure (hexagonal geometry) and a variety of defects that the structure might have.

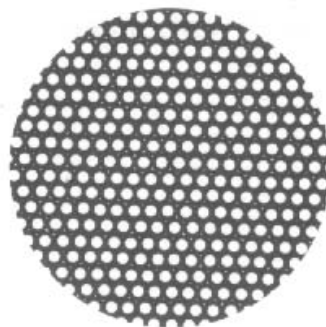

Ideal crystalline structure

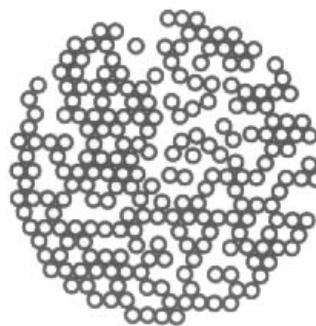

Amorphous or glassy structure (when stationary) or a liquid structure (when in motion)

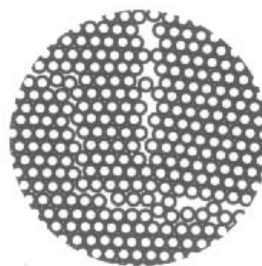

Crystalline structure with surface (grain boundary) defect

Many forces can affect the structure of a crystal. One of the most important forces that can influence the structure of a growing crystal is gravity. Growing crystals in microgravity can reduce gravity effects to produce crystals with better defined properties. The information gained by microgravity experiments can lead to improved crystal processing on Earth.

The connection between the force of gravity and the formation of defects varies from very simple and straightforward to complicated and nonintuitive. For example, mercury iodide crystals can form from the vapor phase. However, at the growth temperature (approximately 125° C) the crystal structure is so weak that defects can form just due to the weight of the crystal. On the other hand, the relationship between residual fluid flows caused by gravity and any resulting crystalline defects is not well understood and may be very complex.

Crystalline structure with point defects (vacancies and substitution impurities)

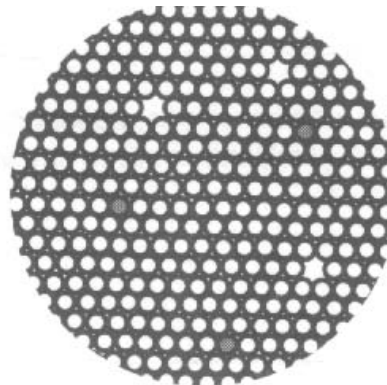

Crystalline structure (further magnified) with interstitial defect and edge dislocations

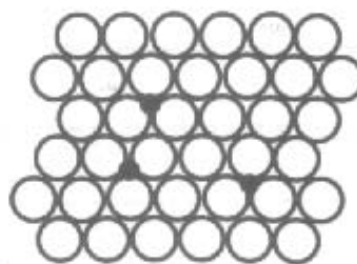

- Interstitial -

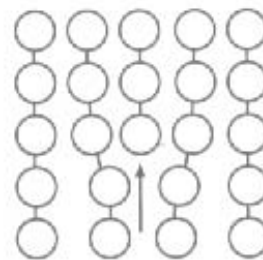

- Edge

# Crystallization

Name: \_\_\_\_\_

Based on your observations, describe and sketch each crystallization stage shown with the model.

Melting:

---

---

---

---

---

---

---

---

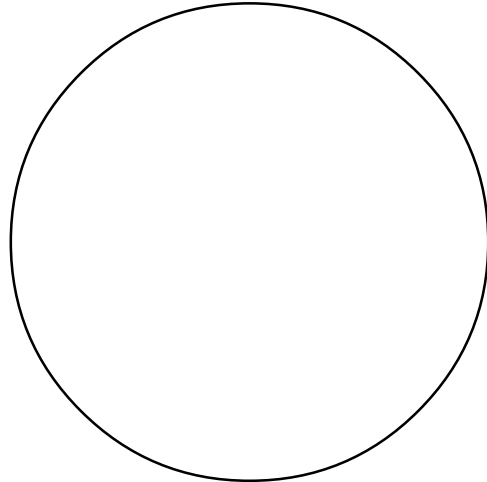

Fast Cooling:

---

---

---

---

---

---

---

---

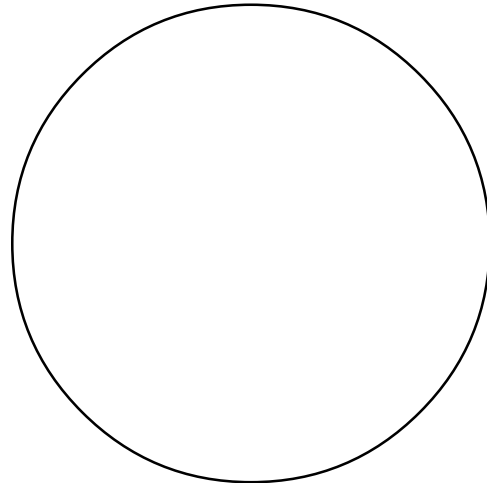

Slow Cooling:

---

---

---

---

---

---

---

---

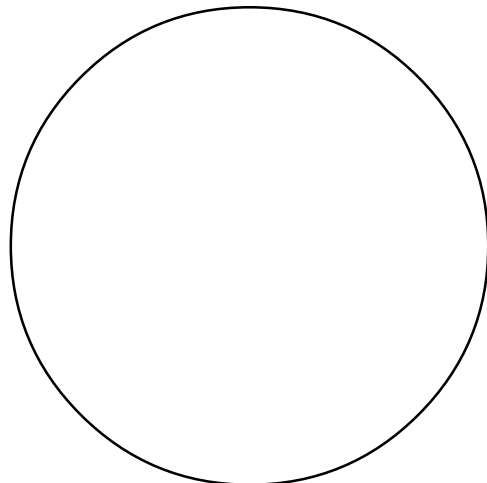

## Crystal Growth and Buoyancy-Driven Convection Currents

### Objective:

- To observe buoyancy-driven convection currents that are created as crystals grow in a crystal growing solution.

### Science Standards:

- Science as Inquiry
- Physical Science
  - position and motion of objects
  - properties of objects and materials
- Unifying Concepts and Processes
- Change, Constancy, & Measurement

### Science Process Skills:

- Observing
- Communicating
- Measuring
- Collecting Data
- Inferring
- Predicting
- Hypothesizing

### Mathematics Standards:

- Measurement

### Activity Management:

This activity is best done as a demonstration. While it is easy for students to grow crystals by following the directions, the success of observing the density-driven convection currents depends upon a very still environment. The crystal-growing chamber should be placed on a firmly mounted counter where it will not be disturbed. The convection currents are very sensitive to vibrations. Place a slide projector on one side of the chamber and direct the

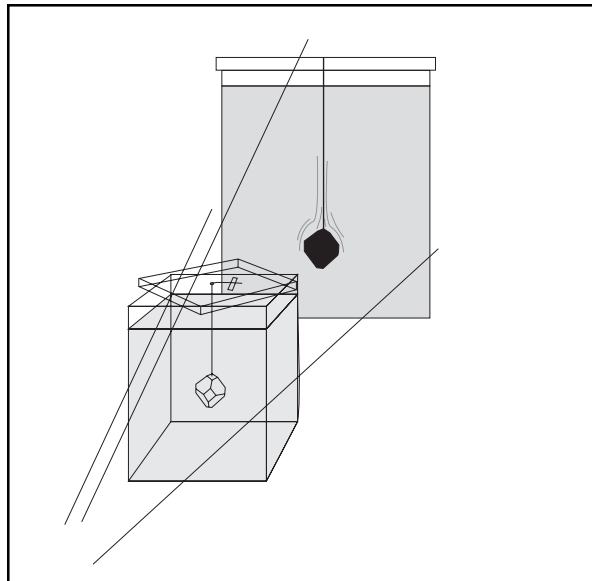

Gravity-driven convection currents are created in a crystal growth chamber by the interaction of the growing crystal and the solution.

### MATERIALS AND TOOLS

- Aluminum potassium sulfate  $\text{AlK}(\text{SO}_4)_2 \cdot 12\text{H}_2\text{O}^*$  (alum)
- Square acrylic box\*\*
- Distilled water
- Stirring rod
- Monofilament fishing line
- Silicone cement
- Beaker
- Slide projector
- Projection screen
- Eye protection
- Hot plate
- Thermometer Balance

\*Refer to the chart for the amount of alum needed for the capacity of the growth chamber (bottle) you use.

\*\*Clear acrylic boxes, about 10x10x13 cm, are available from craft stores. Select a box that has no optical distortions.



light from the projector through the growth chamber so it casts a shadow on the wall behind. If the wall behind the chamber is textured or a dark color, tape a piece of white paper there to act as a screen. Viewing may be improved by adding dark paper shields around the screen to reduce outside light falling on the screen. The projector can be replaced by a clear lightbulb of about 100 to 150 watts that has a straight filament. Place the bulb in a clip lamp light socket and aim the bulb so the filament is pointing directly at the growth chamber. This will make the bulb serve as a point source of light so the shadows will be clear. Do not use a reflective lamp shade with the light.

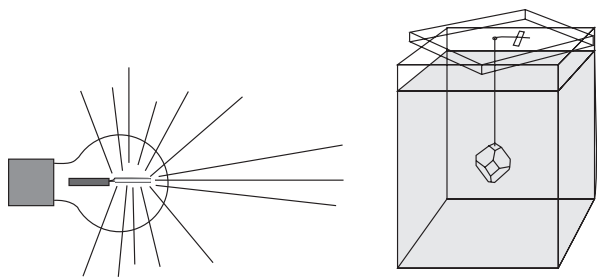

When preparing the crystal growing solution, be sure to follow routine safety precautions such as wearing eye protection. You can obtain this chemical from school science supply companies or even in food stores in the spice section. Alum is used in pickling.

To produce large alum crystals, it is necessary to obtain seed crystals first. This is accomplished by dissolving some alum in a small amount of water and setting it aside for a few days. Plan to do this step several weeks before you will use the demonstration with your students. To save time, dissolve as much alum as you can in warm water. This will produce a supersaturated solution when the liquid cools and crystallization will start shortly. After the seed crystals form (about 3-5 mm in size) pour the solution through some filter paper or a paper towel to capture the seeds. Let them dry before attaching the fishing line. In attaching the line, simply place a dab of silicone

cement on a piece of paper and then touch the end of a short length of monofilament fishing line to the cement. Then, touch the same end of the line to the crystal. Prepare several seed crystals in this manner. When the cement dries, you will be ready for the steps below.

You may discover mysterious variations in the growth of the crystal over several days. Remember, the amount of alum that can be dissolved in a given quantity of water will vary with the water's temperature. Warm water can hold more alum than cold water. If the air-conditioning in a building is shut off for the weekend, the temperature of the alum solution will climb with the room's temperature and some or all of the crystal may dissolve back into the water.

### Procedure:

1. Prepare the crystal growth solution by dissolving powdered or crystalline alum in a beaker of warm water. The amount of alum that can be dissolved in the water depends upon the amount of water used and its temperature. Refer to the plot (Alum Solubility in Water) for the quantity required.
2. When no more alum can be dissolved in the water, transfer the solution to the growth chamber acrylic box.
3. Punch or drill a small hole through the center of the lid of the box. Thread the seed crystal line through the hole and secure it in place with a small amount of tape. Place the seed crystal in the box and place the lid on the box at a 45 degree angle. This will expose the surface of the solution to the outside air to promote evaporation. It may be necessary to adjust the length of the line so the seed crystal is several centimeters above the bottom of the box.
4. Set the box aside in a place where it can be observed for several days without being disturbed. If the crystal should disappear, dissolve more alum into the solution and suspend a new seed crystal. Eventually, growth will begin.

- Record the growth rate of the crystal by measuring it with a metric ruler. The crystal may also be removed and its mass measured on a balance.
- Periodically observe the fluid flow associated with the crystal's growth by directing the light beam of a slide projector through the box to a projection screen. Observe plumes around the shadow of the crystal. Convection currents in the growth solution distort the light passing through the growth solution. Refer to the diagram at the beginning of this activity for information on how the observation is set up.

### Assessment:

Collect the student work sheets.

### Extensions:

- Try growing other crystals. Recipes for crystals can be found in reference books on crystal growing.
- Collect natural crystals and observe their surfaces and interiors (if transparent). Look for uniformity of the crystals and for defects. Make a list of different kinds of defects (fractures, bubbles, inclusions, color variations, etc.). Discuss what conditions must have existed in nature at the time of the crystal's formation or after its formation to cause the defects.
- Review scientific literature for results from microgravity crystal-growing experiments.

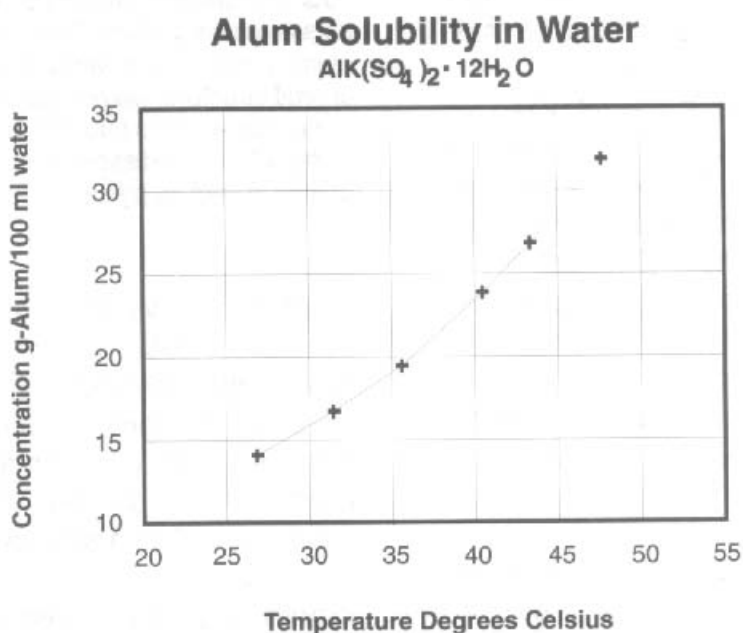



# Crystal Growth and Buoyancy-Driven Convection Currents

Crystals can be grown using a variety of methods. One of the simplest methods involves dissolving a solid into a liquid. As the liquid evaporates, the solid comes out of solution and forms a crystal (or many crystals). This can be done with sugar or salt or a variety of other compounds such as alum (aluminum potassium sulfate), LAP (L-arginine phosphate), or TGS (triglycine sulfate).

The usual procedure for growing crystals from a solution is to create the solution first. In this activity, a quantity of alum is dissolved into warm water. Warm water was used to increase the amount of alum that could be dissolved. You may have observed this effect by stirring sugar into a cup of hot coffee or tea. Hot liquids can dissolve more sugar than cold liquids. After the alum was dissolved, the solution was allowed to cool back down to room temperature. As a result, the water held more alum than it normally could at that temperature. The solution was supersaturated. A seed crystal was suspended in the solution and it began to grow. The excess alum dissolved in the water migrated to the crystal and was deposited on its surface. Because the crystal growth chamber was open to the surrounding air, the solution began evaporating. This continued the crystal growth process because the alum left over from the evaporated water was deposited on the crystal.

At first glance, the growth process of the alum crystal looks very quiet and still. However, examination of the solution and growing crystal with light to produce shadows shows that currents exist in the solution. These currents become visible when light is projected through them because the convection currents distort the light rays, making them appear as dark plumes on

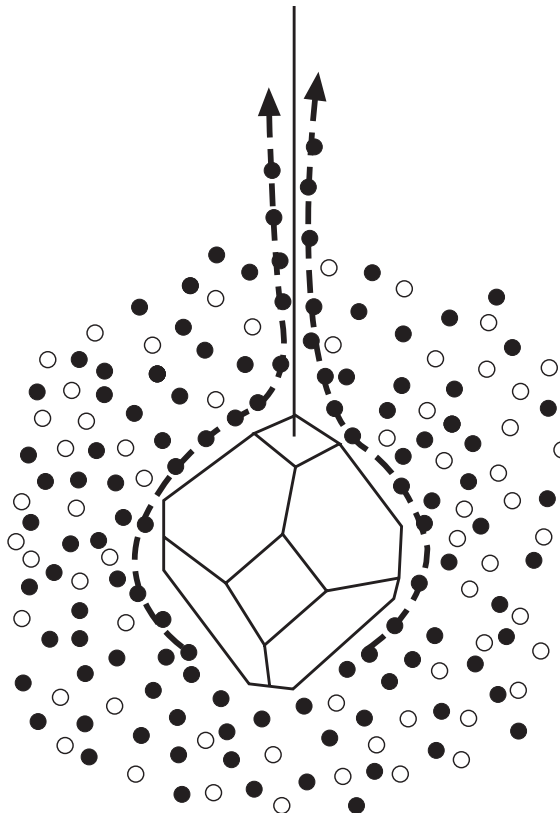

Water molecules in this diagram are represented by black dots and the alum dissolved represented by the lighter dots. Throughout most of the solution, the dots are randomly mixed but, next to the crystal, the dots are mostly black. This happens because the alum nearest the growing crystal attaches to the crystal structure, leaving behind the water. The remaining water is buoyant and rises while denser water with more dissolved alum moves next to the crystal to take its place.

the screen. This image on the screen is called a shadowgraph.

Where do these convection currents come from? The answer has to do with the difference in the amount of alum in solution near the growing crystal compared with the solution near the wall of the growth chamber. Except for near the

crystal, the solution is homogeneous. This means it has the same composition and density. The solution near the crystal is another matter. As each molecule of alum leaves the solution to become deposited on the crystal's surface, the solution left behind becomes slightly less dense than it was. The less dense solution is buoyant and begins to rise in the chamber. More dense solution moves closer to the crystal to take its place. The alum in the replacement solution also deposits on the crystal, causing this solution to become less dense as well. This keeps the convection current moving.

Microgravity scientists are interested in the convection currents that form around a crystal growing in solution. The currents may be responsible for the formation of defects such as liquid inclusions. These are small pockets of liquid that are trapped inside the crystal. These defects can degrade the performance of devices made from these materials. The virtual absence of buoyancy-driven convection in a microgravity environment may result in far fewer inclusions than in crystals grown on Earth. For this reason, solution crystal growth has been an active area of microgravity research.

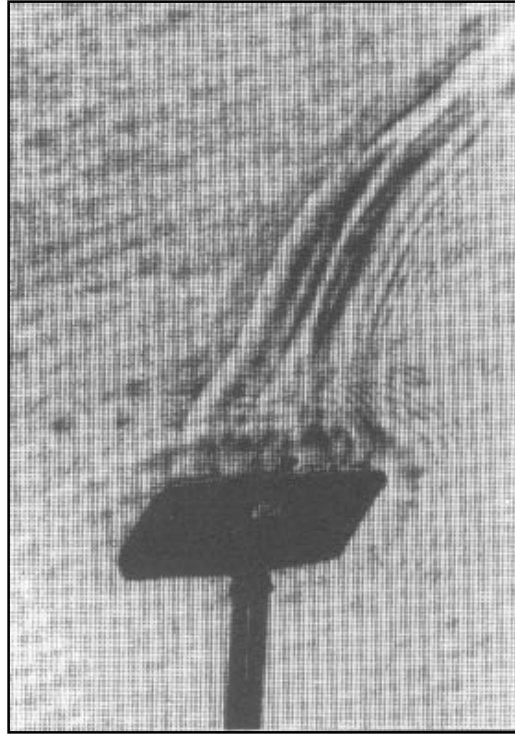

Shadowgraph image of a growth plume rising from a growing crystal.

# Crystal Growth and Buoyancy-Driven Convection Currents

Name: \_\_\_\_\_

1. In the box to the right, make a sketch of what you observed in the shadowgraph of a crystal growing from solution.
2. Explain below what is happening.



Shadowgraph for growing alum crystal

3. In the box to the right, sketch what a shadowgraph should look like for a crystal that is dissolving back into solution.
4. Explain your diagram below.



Shadowgraph for dissolving alum crystal

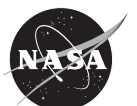

5. Draw a picture in the space to the right of what you think the shadowgraph should look like for a crystal grown from solution in a microgravity environment.

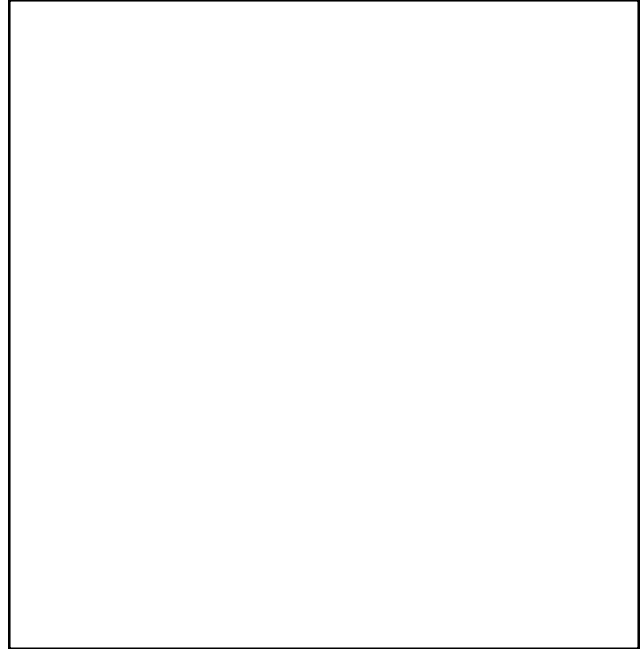

6. Explain your picture below.

Shadowgraph for alum crystal grown in microgravity



# Rapid Crystallization

## Objective:

- To investigate the growth of crystals under different temperature conditions.

## Science Standards:

Science as Inquiry  
Physical Science  
- properties of objects and materials  
Unifying Concepts and Processes  
Change, Constancy, & Measurement

## Science Process Skills:

Observing  
Communicating  
Measuring  
Collecting Data  
Inferring  
Predicting  
Interpreting Data  
Controlling Variables  
Investigating

## Mathematics Standards:

Communication  
Measurement

## Activity Management:

This activity is best done with cooperative learning groups of two or three students. This will minimize the number of heat packs that have to be obtained. Heat packs are sold at camping supply stores. It is important to get the right kind of pack. The pack, sold under different names, consists of a plastic pouch (approximately 9 by 12 centimeters in size) containing a solution of sodium acetate and water and a small metal disk. When the disk

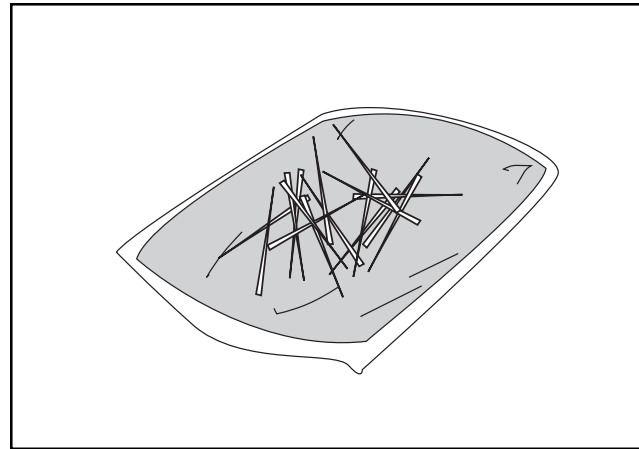

The rapid growth of crystals in a heat pack is observed under different heating conditions.

## MATERIALS AND TOOLS

Heat pack hand warmers  
(1 or more per group)  
Water boiler (an electric kitchen  
hot pot can be used)  
Styrofoam food tray  
(1 per group)  
Metric thermometer  
(1 or more per group)  
Observation and data table  
(1 per student group)  
Cooler  
Clock or other timer

clicked or snapped, crystals begin to form and heat is released. The pack can be reused by reheating until all the crystals are dissolved.

Assemble all the materials needed for the activity in sets for the number of student groups you have. Prepare the heat packs by heating any that are solidified until all the crystals dissolve.

Allow one half of the packs to cool to room temperature. Maintain the other packs at a temperature of about 45°C. This can be done by placing the packs in an insulated cooler with some hot water until the packs are needed.

Before starting the experiment, discuss the data collection procedure. To reduce heat conductivity problems, heat packs are placed on the Styrofoam food tray with the bulb of a thermometer slipped between the pack and the tray. Discuss with the students why the tray is necessary and ask them where the best placement of the bulb should be. Remind students that the thermometer should be placed the same way for each test. Give each student group one student data sheet for each test to be performed.

Begin with observation of the room temperature pack first. The students should be prepared to make observations immediately after the disk is clicked. Complete crystallization should take less than a minute. Since the crystallization process is dramatic, demonstrate the clicking process with another heat pack and pass it around for students to feel. If you have some sort of video display system, show crystallization on the television as it is happening. This may help students focus on the investigation when they start their own packs crystallizing. Distribute the second pack after observations of the first pack are complete. Crystallization of the second pack will take several minutes to complete.

Students will discover that heat packs with higher initial temperatures will take longer to crystallize. Crystals will be more defined than those forming in packs with cooler initial starting temperatures. Depending upon the initial temperature, crystals may resemble needles or blades. Gravity will influence their development. Crystals will settle to the bottom of the pack and intermingle, causing distortions. Crystals forming in an initially cool heat packs will be needlelike but, because so

many form at once, the growth pattern will be fan-shaped.

Use the questions below as a guide to discuss the results of the investigation.

1. Is there any relationship between the initial temperature of the pouch and the temperature of the pouch during crystallization?
2. Is there a relationship between the initial temperature of the pouch and the time it takes for the pouch to completely solidify?
3. Do other materials, such as water, release heat when they freeze?

### **Assessment:**

Collect the student work sheets.

### **Extensions:**

1. Discuss what might happen if the heat pack were crystallized in microgravity. What effect does gravity have? Hold the pack vertically with the steel disk at the bottom and trigger the solidification. Repeat with the disk at the top.
2. Try chilling a heat pack pouch in a freezer and then triggering the solidification.





# Heat Packs and Crystals

Crystals are solids composed of atoms, ions, or molecules arranged in orderly patterns that repeat in three dimensions. The geometric form of a crystal visible to the naked eye can provide clues to the arrangement inside. Many of the unique properties of materials, such as strength and ductility, are a consequence of crystalline structure.

It is easy to get confused about the nature of crystals because the word crystal is frequently misused. For example, a crystal chandelier is not crystal at all. Crystal chandeliers are made of glass which is a solid material but does not have a regular interior arrangement. Glass is called an *amorphous* material because it does not have a regular interior arrangement of atoms.

Scientists are very interested in growing crystals in microgravity because gravity often interferes with the crystalgrowing process, leading to defects forming in the crystal structure. The goal of growing crystals in microgravity is not to develop crystal factories in space but to better understand the crystal-growing process and the effects that gravity can have on it.

In this activity, you will be investigating crystal growth with a hand warmer. The hand warmer consists of a plastic pouch filled with a food-grade solution of sodium acetate and S water. Also in the pouch is a small disk of stainless steel.

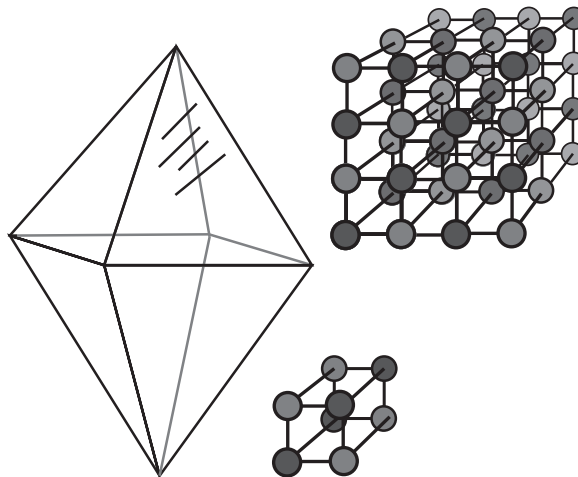

Snapping the disk triggers the crystallization process. (The exact cause for this phenomena is not well understood.) The pouch is designed so that at room temperature the water contains many more molecules of sodium acetate than would normally dissolve at that temperature. This is called a supersaturated solution. The solution remains that way until it comes in contact with a seed crystal or some way of rapidly introducing energy into the solution which acts as a trigger for the start of crystallization. Snapping the metal disk inside the pouch delivers a sharp mechanical energy input to the solution that triggers the crystallization process. Crystallization takes place so rapidly that the growth of crystals can easily be observed. Heat is released during the precipitation that maintains the pouch temperature at about 54°C for about 30 minutes. This makes the pouch ideal for a hand warmer. Furthermore, the pouch can be reused by reheating and dissolving the solid contents again.

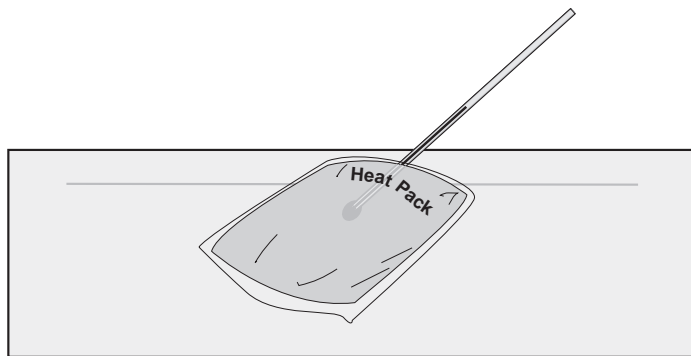

**Team Member Names:**

# Heat Pack Experiment Data Sheet

---

---

---

Test number: \_\_\_\_\_

Initial temperature of pouch: \_\_\_\_\_

Temperature and time at beginning of crystallization: \_\_\_\_\_

Temperature and time at end of crystallization: \_\_\_\_\_

Length of time for complete crystallization: \_\_\_\_\_

Describe the crystals (shape, growth rate, size, etc.)

---



Sketch of Crystals

Test number: \_\_\_\_\_

Initial temperature of pouch: \_\_\_\_\_

Temperature and time at beginning of crystallization: \_\_\_\_\_

Temperature and time at end of crystallization: \_\_\_\_\_

Length of time for complete crystallization: \_\_\_\_\_

Describe the crystals (shape, growth rate, size, etc.)



Sketch of Crystals



# Microscopic Observation of Crystal Growth

## Objective:

- To observe crystal nucleation and growth rate during directional solidification .

## Science Standards:

Science as Inquiry

Physical Science

- position and motion of objects

- properties of objects and materials

Unifying Concepts and Processes

Change, Constancy, & Measurement

## Science Process Skills:

Observing

Communicating

Investigating

## Activity Management

The mannite part of this activity should be done as a demonstration, using a microprojector or microscope with a television system. It is necessary to heat a small quantity of crystalline mannite on a glass slide to 168°C and observe its recrystallization under magnification. The instructions call for melting the mannite twice and causing it to cool at different rates. It is better to prepare separate samples so they can be compared to each other. The slide that is cooled slowly can easily be observed under magnification as crystallizes. You may not have time to observe the rapidly chilled sample properly before crystallization is complete. The end result, however,

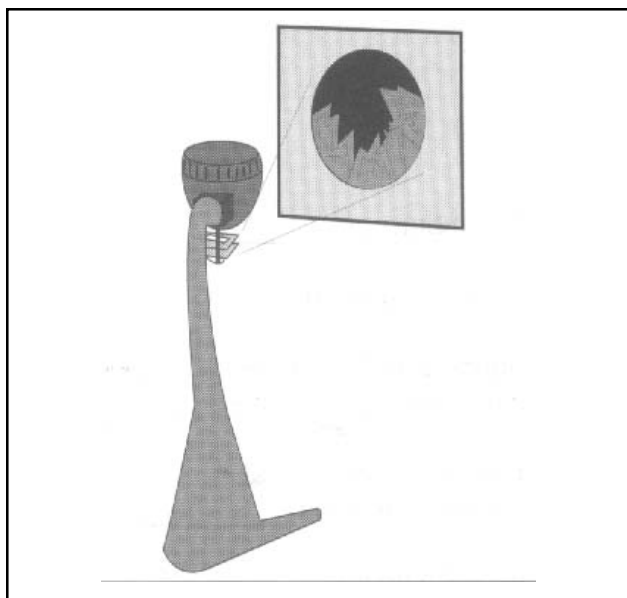

A microprojector is used to observe crystal growth.

## MATERIALS AND TOOLS

Bismarck brown Y  
 Mannite (d-mannitol)  
 $\text{HOCH}_2(\text{CHOH})_4\text{CH}_2\text{OH}$   
 Salol (Phenyl salicylate)  
 $\text{C}_{13}\text{H}_{10}\text{O}_3$   
 Microprojector  
 Student microscopes (instead of a microprojector)  
 Glass microscope slides with cover glass  
 Ceramic bread-and-butter plate  
 Refrigerator  
 Hot plate or desktop coffee cup warmer  
 Forceps  
 Dissecting needle  
 Spatula  
 Eye protection

will be quite apparent under magnification. If students will be conducting the second part of the activity, it is suggested that you prepare several sets of mannite slides so they may be

distributed for individual observations. The salol observations are suitable for a demonstration, but because of the lower melting temperature (48°C), it is much safer for students to work with than the mannite. A desktop coffee cup warmer is sufficient for melting the salol on a glass slide. Because of the recess of the warmer's plate, it is best to set several large metal washers on the plate to raise its surface. The washers will conduct the heat to the slide and make it easier to pick up the heated slide with forceps. Point out to the students that they should be careful when heating the salol because overheating will cause excessive evaporation and chemical odors, and will increase the time it takes for the material to cool enough for crystallization to occur. The slide should be removed from the hot plate just as it starts melting. The glass slide will retain enough heat to complete the melting process.

Only a very small amount of bismarck brown is needed for the last part of the activity with salol. Only a few dozen grains are needed. Usually just touching the spatula to the chemical causes enough particles to cling to it. Gently tap the spatula held over the melted salol to transfer the particles. It will be easier to do this if the salol slide is placed over a sheet of white paper. This will make it easier to see that the particles have landed in the salol.

If students are permitted to do individual studies, go over the procedures while demonstrating crystallization with the d-mannitol. Have students practice sketching the crystallized mannitol samples before they try sketching the salol.

Refer to the chemical notes below for safety precautions required for this activity.

## Notes On Chemicals Used: Bismarck Brown Y

Bismarck brown is a stain used to dye bone specimens for microscope slides. Because bismarck brown is a stain, avoid getting it on your fingers. Bismarck brown is water soluble.

## Mannite (d-mannitol)

$\text{HOCH}_2(\text{CHOH})_4\text{CH}_2\text{OH}$  Mannite has a melting point of approximately 168°C. It may be harmful if inhaled or swallowed. *Wear eye protection and gloves when handling this chemical. Conduct the experiment in a well-ventilated area.*

## Salol (phenyl salicylate)

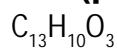

It has a melting point of 43° C. It may irritate eyes. *Wear eye protection.*

## Procedure: Observations of Mannite

1. Place a small amount of mannite on a microscope slide and place the slide on a hot plate. Raise the temperature of the hot plate until the mannite melts. Be careful not to touch the hot plate or heated slide. Handle the slide with forceps.
2. After melting, cover the mannite with a cover glass and place the slide on a ceramic bread-and-butter plate that has been chilled in a refrigerator. Permit the liquid mannite to crystallize.
3. Observe the sample with a microprojector. Note the size, shape, number, and boundaries of the crystals.
4. Prepare a second slide, but place it immediately on the microprojector stage. Permit the mannite to cool slowly. Again observe the size, shape, and boundaries of the crystals. Mark and save the two slides for comparison using student microscopes. Forty power is sufficient for comparison. Have the students make sketches of the crystals on the two slides and label them by cooling rate.



## Observations of Salol

5. Repeat the procedure for mannite (steps 1–4) with the salol, but do not use glass cover slips. Use a desktop coffee cup warmer to melt the salol. It may be necessary to add a seed crystal to the liquid on each slide to start the crystallization. Use a spatula to carry the seed to the salol. If the seed melts, wait a moment and try again when the liquid is a bit cooler. (If the microprojector you use does not have heat filters, the heat from the lamp may remelt the salol before crystallization is completed.)
6. Prepare a new salol slide and place it on the microprojector stage. Drop a tiny seed crystal into the melt and observe the solid-liquid interface.
7. Remelt the salol on the slide and sprinkle a tiny amount of bismarck brown on the melt. Drop a seed crystal into the melt and observe the motion of the bismarck brown granules. The granules will make the movements of the liquid visible. Pay close attention to the granules near the growing edges and points of the salol crystals.

## Assessment:

Collect the student data sheets.

## Extensions:

1. Design a crystal-growing experiment that could be flown in space. The experiment should be self-contained and the only astronaut involvement that of turning a switch on and off.
2. Design a crystal-growing experiment for spaceflight that requires astronaut observations and interpretations.
3. Research previous crystal-growing experiments in space and some of the potential benefits researchers expect from space-grown crystals.



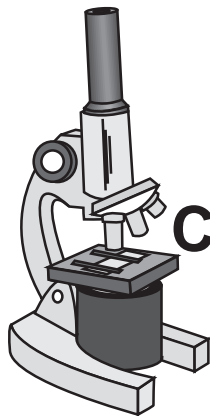

# Crystal Growth

Directional solidification refers to a process by which a liquid is transformed (by freezing) into a solid through the application of a temperature gradient (a temperature difference over a specified distance such as 100C/cm) in which heat is removed in one direction. The heat travels down the temperature gradient from hot to cold. A container of liquid will turn to a solid in the direction the temperature is lowered. If this liquid has a solute (something dissolved in the liquid) present, typically some of the solute will be rejected into the liquid ahead of the liquid/solid interface. However, not all of the solute can be contained in the solid as it forms; the remaining solute is pushed back into the liquid near the interface. This phenomenon has many important consequences for the solid including how much of the solute eventually ends up in the solid. The concentration of solute in the solid can control the electrical properties of semiconductors and the mechanical and corrosion properties of

metals. As a result, solute rejection is studied extensively in solidification experiments.

The rejected material tends to build up at the interface (in the liquid) to form a layer rich in solute. This experiment demonstrates what happens when the growth rate is too fast and solute in the enriched layer is trapped.

Fluid flow in the melt can also affect the buildup of this enriched layer. On Earth, fluids that expand become less dense. This causes a vertical flow of liquid which will interfere with the enriched layer next to the growing solid. In space, by avoiding this fluid flow, a more uniform enriched layer will be achieved. This, in turn, can improve the uniformity with which the solute is incorporated into the growing crystal.

### Sample Microscope Sketches Mannite Crystallization

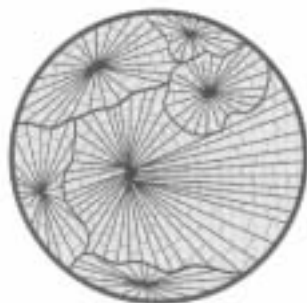

Slow Cooling



Fast Cooling





# Microscopic Observation of Crystals

Name: \_\_\_\_\_

1. Study the mannite crystallization slides. Sketch what you observe in the two circles below. Identify the cooling rate for each slide and the magnification you used for your observations.

## Mannite (d-Mannitol)

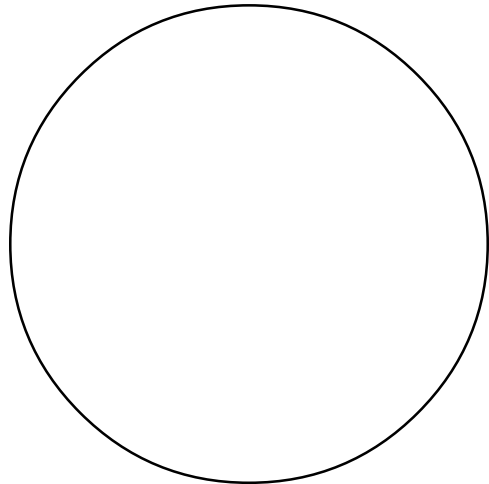
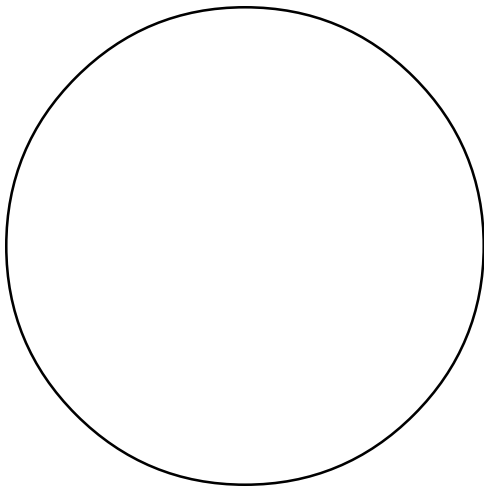

Cooling Rate: \_\_\_\_\_

Cooling Rate: \_\_\_\_\_

Magnification: \_\_\_\_\_

Magnification: \_\_\_\_\_

Describe below the difference between the two mannite samples.

How can you explain these differences?



2. Prepare the salol samples according to instructions provided by your teacher. Remember to wear eye protection as you handle the chemical. Study the salol crystallization slides. Sketch what you observe in the two circles below. Identify the cooling rate for each slide and the magnification you used for your observations.

### Salol (Phenyl Salicylate)

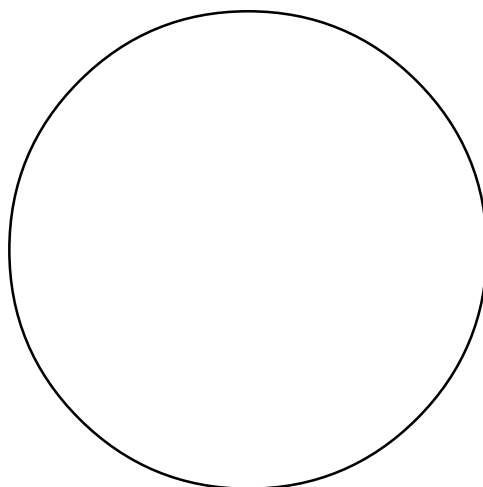
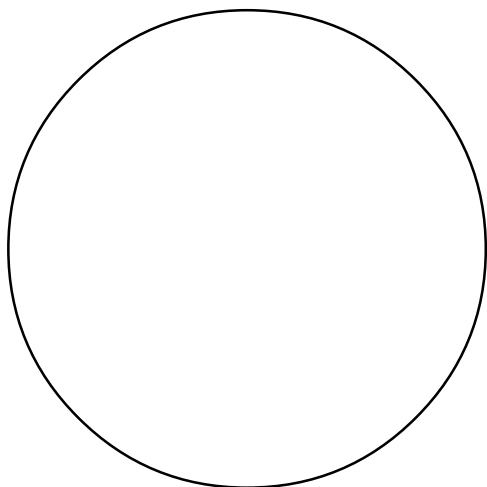

Cooling Rate: \_\_\_\_\_

Cooling Rate: \_\_\_\_\_

Magnification: \_\_\_\_\_

Magnification: \_\_\_\_\_

Describe below the difference between the two salol samples.

How can you explain these differences?





# Zeolite Crystal Growth

## Objective:

- To grow zeolite crystals and investigate how gravity affects their growth.

## Science Standards:

Science as Inquiry  
Physical Science  
Unifying Concepts and Processes  
Change, Constancy, & Measurement  
Science in Personal and Social Perspectives

## Science Process Skills:

Observing  
Communicating  
Measuring  
Collecting Data  
Controlling Variables  
Investigating

## Mathematics Standards:

Measurement

## Activity Management:

The preparation of zeolite crystals, although not difficult, is an involved process. A number of different chemicals must be carefully weighed and mixed. You may wish to prepare the chemicals yourself or assign some of your more advanced students to the task. Refer to the materials and tools list on the next page for a detailed list of what is required.

This activity involves maintaining a hot water bath continuously for up to 8 days. If you do not have the facilities to do this, you can conduct



Zeolite crystals are being grown in a hot water bath.

the experiment for just the 0 and 1 TEA (triethanolamine) samples described below. Crystals may also be formed if the hot water bath is turned off at the end of the school day and turned on the succeeding day. Crystallization times will vary under this circumstance, and close monitoring of the formation of the crystalline precipitate will be necessary.

Following the growth of zeolite crystals, small samples can be distributed to student groups for microscopic study.

## Procedure:

- While wearing hand and eye protection, weigh 0.15 grams of sodium hydroxide and place it in a 60 ml, high-density polyethylene bottle. Add 60 ml of distilled water to the bottle and cap it. Shake the bottle vigorously until the solids are completely dissolved. Prepare a second bottle identical to the first.
- Add 3.50 grams of sodium

## MATERIALS AND TOOLS

Sodium aluminate  $\text{NaAlO}_2$   
FW=81.97  
Sodium metasilicate anhydrous,  
purum,  $\text{Na}_2\text{O}_3\text{Si}$ , FW=122.06  
Sodium hydroxide pellets,  
97+%, average composition  
 $\text{NaOH}$ , FW=40  
Triethanolamine (TEA), 98%  
 $(\text{HOCH}_2)_3\text{N}$ , FW=149.19  
Distilled water  
1000 ml Pyrex® glass beaker  
Aluminum foil  
Metric thermometer with range up  
to 100°C  
Laboratory hot plate  
2-60 ml high-density polyethylene  
bottles with caps  
4-30 ml high-density polyethylene  
bottles with caps  
Plastic gloves  
Goggles  
Glass microscope slides  
Permanent marker pen for  
marking on bottles  
Waterproof tape  
Lead fishing sinkers  
Tongs  
Eyedropper  
Optical microscope, 400X

metasilicate to one of the bottles and again cap it and shake it until all the solids are dissolved. Mark this bottle "silica solution." To the second bottle, add 5.6 grams of sodium aluminate and cap it and shake it until all the solids are dissolved. Mark this bottle "alumina solution."

3. Using a permanent marker pen, mark the four, 30 ml high-density polyethylene bottles with the following identifications: 0 TEA, 1 TEA, 5 TEA, and 10 TEA.

- Place 0.85 grams of TEA into the bottle marked "1 TEA." Place 4.27 grams of TEA into the bottle marked "5 TEA." Place 8.55 grams of TEA into the bottle marked "10 TEA." Do not place any TEA into the bottle marked "0 TEA."
- Add 10 ml of the alumina solution to each of the bottles. Also add 10 ml of the silica solution to each bottle.
- Cap each bottle tightly and shake vigorously. Secure each cap with waterproof tape and tape a lead sinker to the bottom of each bottle. The sinker should weigh down the bottle so it will be fully immersed in the hot water.
- Prepare a hot water bath by placing approximately 800 ml of water in a 1000 ml Pyrex beaker. Place the four weighted bottles into the beaker. The bottles should be covered by the water. Cover the beaker with aluminum foil and punch a small hole in the foil to permit a metric thermometer to be inserted. Fix the thermometer in such a way as to prevent it from touching the bottom of the beaker. Place the beaker on a hot plate and heat it to between 85 and 95° C. It will be necessary to maintain this temperature throughout the experiment. Although the aluminum foil will reduce evaporation, it will be necessary to periodically add hot (85 to 90° C) water to the beaker to keep the bottles covered.
- After 1 day of heating, remove the bottle marked 0 TEA from the bath with a pair of tongs. Using an eyedropper, take a small sample of the white precipitate found on the bottom of the bottle. Place the sample on a glass microscope slide and examine for the presence of crystals under various magnifications. Make sketches or photograph any crystals found. Be sure to identify magnification of the sketches or photographs and estimate the actual sizes of the crystals. Determine the geometric form of the crystals. Look for crystals that have grown together.



- Repeat procedure 8 for the 1 TEA bottle after 2 days of heating. Repeat the procedure again for the 5 TEA bottle after 5 days and for the 10 TEA bottles after 8 days. Compare the size, shape, and intergrowth of the crystals formed in each of the bottles.

### Assessment

Collect student sketches and written descriptions of the zeolite crystals.

### Extension:

- Obtain zeolite filter granules from a pet shop. The granules are used for filtering ammonia from aquarium water. Set up a funnel with filter paper and fill it with the granules. Slowly pour a solution of water and household ammonia (ammonia without lemon or other masking scents) into the granules. Collect the liquid below and compare the odor of the filtered solution and the unfiltered solution. Try running the filtered solution through a second time and again compare the odors. Be sure to wear eye protection.

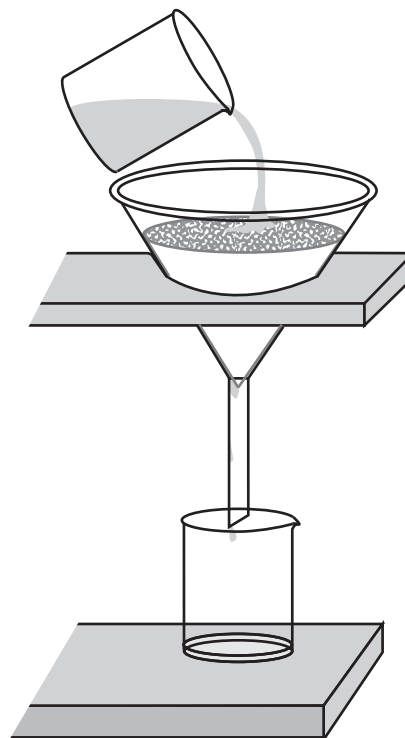



# Zeolites

Zeolites are crystals made up of the elements silicon, aluminum, and oxygen. The crystals consist of alternating arrays of silica (beach sand,  $\text{SiO}_2$ ) and alumina (aluminum oxide,  $\text{Al}_2\text{O}_3$ ) and can take on many geometric forms such as cubes and tetrahedra. Internally, zeolites are rigid sponge-like structures with uniform but very small openings (e.g., 0.1 to 1.2 nanometers or  $0.1$  to  $1.2 \times 10^{-9}$  meters). Because of this property, these inorganic crystals are sometimes called "molecular sieves." For this reason, zeolites are employed in a variety of chemical processes. They allow only molecules of certain sizes to enter their pores while keeping molecules of larger sizes out. In a sense, zeolite crystals act like a spaghetti strainer that permits hot water to pass through while holding back the spaghetti. As a result of this filtering action, zeolites enable chemists to manipulate molecules and process them individually.

The many chemical applications for zeolite crystals make them some of the most useful inorganic materials in the world. They are used as catalysts in a large number of chemical reactions. (A catalyst is a material that has a pronounced

effect on the speed of a chemical reaction without being affected or consumed by the reaction.)

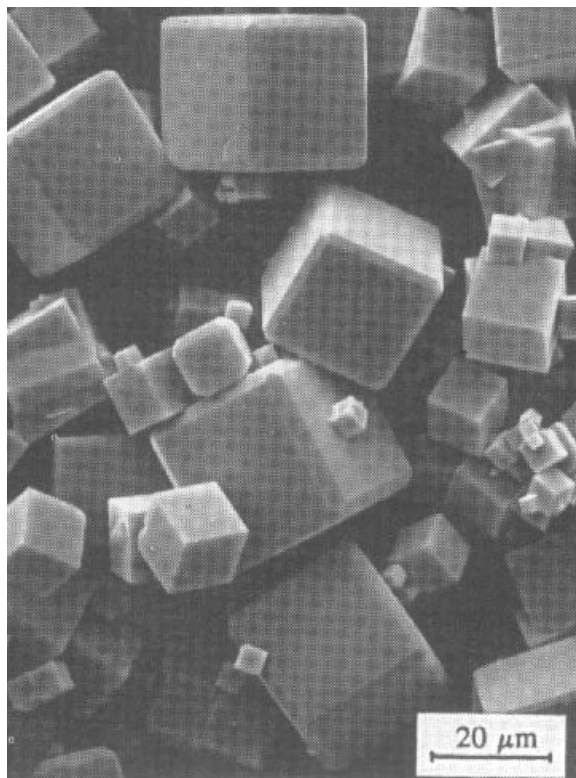

Scientists use zeolite crystals to produce all the world's gasoline through a chemical process called catalytic cracking. Zeolite crystals are often used in filtration systems for large municipal aquariums to remove ammonia from the water. Because they are environmentally safe, zeolites have been used in laundry detergents to remove magnesium and calcium ions. This greatly improves detergent sudsing in mineral-rich "hard" water. Zeolites can also function as filters for removing low

concentrations of heavy metal ions, such as Hg, Cd, and Pb, or radioactive materials from waste waters.

Although scientists have found many beneficial uses for zeolites, they have only an incomplete understanding of how these crystals nucleate (first form from solution) and grow (become larger). When zeolites nucleate from a water solution, their density (twice that of water) causes them to sink to the bottom of the special container (called an autoclave) they are growing

in. This is a process called sedimentation, and it causes the crystals to fall on top of each other. As these crystals continue to grow after they have settled, some merge to produce a large number of small, intergrown zeolite crystals instead of larger, separate crystals.

Zeolite crystal growth research in the microgravity environment of Earth orbit is expected to yield important information for scientists that may enable them to produce better zeolite crystals on Earth. In microgravity, sedimentation is significantly reduced and so is gravity-driven convection.

Zeolite crystals grown in microgravity are often of better quality and larger in size than similar crystals grown in control experiments on Earth. Exactly how and why this happens is not fully understood by scientists. Zeolite crystal growth experiments on the Space Shuttle and on the future International Space Station should provide invaluable data on the nucleation and growth process of zeolites. Such an understanding may lead to new and more efficient uses of zeolite crystals.



# Microscopic Observation of Zeolite Crystals

Name: \_\_\_\_\_

## Instructions:

Observe through a microscope each zeolite crystal sample provided to you by your teacher. Sketch the samples in the circles provided and write a brief description of what you see.

### Sample 1

\_\_\_\_\_ TEA

Sample age \_\_\_\_\_ day(s)

Description:

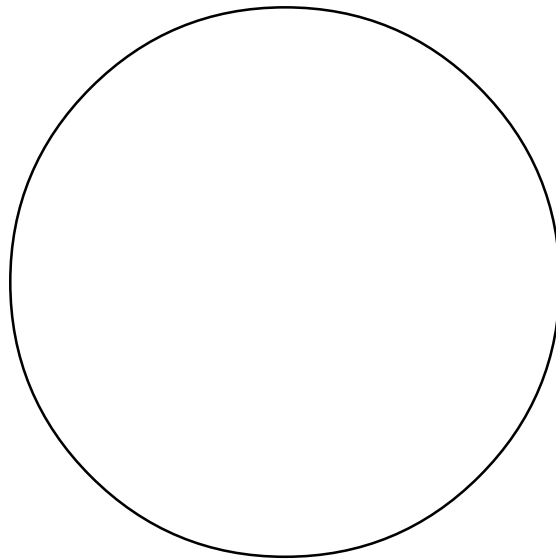

Magnification: \_\_\_\_\_ X

### Sample 2

\_\_\_\_\_ TEA

Sample age \_\_\_\_\_ day(s)

Description:

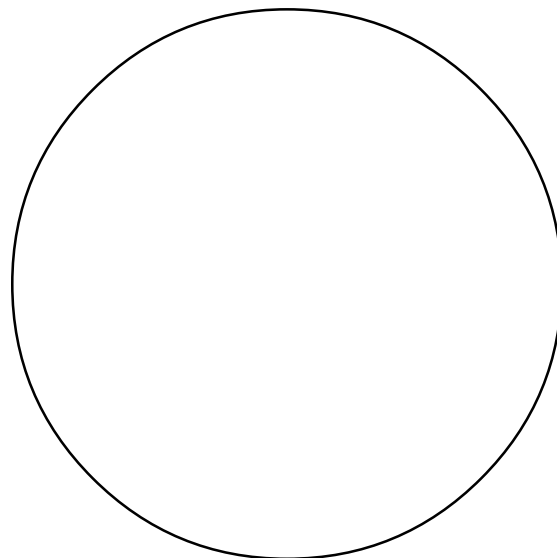

Magnification: \_\_\_\_\_ X

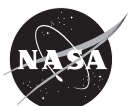

### Sample 3

\_\_\_\_\_ TEA

Sample age \_\_\_\_\_ day(s)

Description

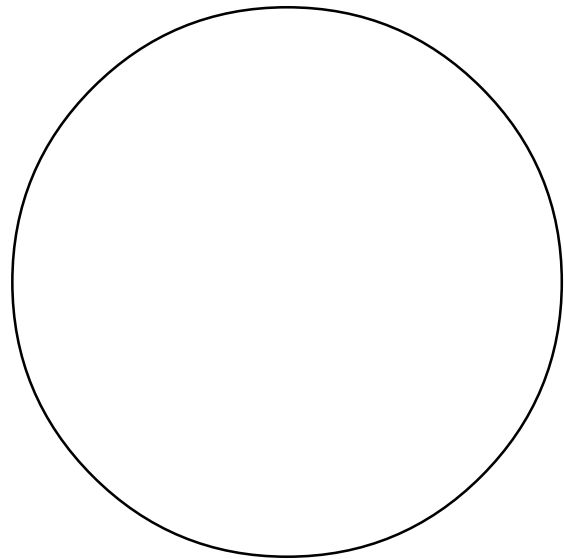

Magnification: \_\_\_\_\_ X

### Sample 4

\_\_\_\_\_ TEA

Sample age \_\_\_\_\_ day(s)

Description

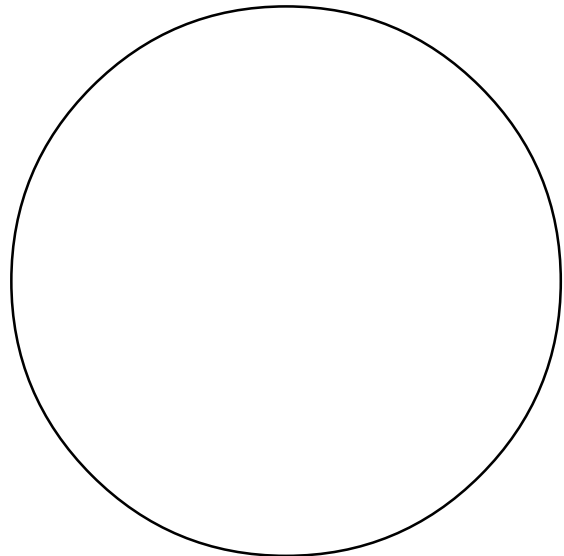

Magnification: \_\_\_\_\_ X

### QUESTIONS:

1. What geometric form (crystal habit) did the zeolite crystals assume as they grew? Was there more than one form present? How did the zeolite crystals appear when they grew into each other?
2. Can you detect any relationship between the length of time crystals were permitted to form, their size and their geometric perfection?
3. Would additional growing time yield larger crystals? Why or why not?



# NASA Resources for Educators

**NASA's Central Operation of Resources for Educators (CORE)** was established for the national and international distribution of NASA-produced educational materials in audiovisual format. Educators can obtain a catalogue and an order form by one of the following methods:

- NASA CORE  
Lorain County Joint Vocational School  
15181 Route 58 South  
Oberlin, OH 44074
- Phone (440) 774-1051, Ext. 249 or 293
- Fax (440) 774-2144
- E-mail [nasaco@leeca8.leeca.ohio.gov](mailto:nasaco@leeca8.leeca.ohio.gov)
- Home Page: <http://spacelink.nasa.gov/CORE>

## Educator Resource Center Network

To make additional information available to the education community, the NASA Education Division has created the NASA Educator Resource Center (ERC) network. ERCs contain a wealth of information for educators: publications, reference books, slide sets, audio cassettes, videotapes, telelecture programs, computer programs, lesson plans, and teacher guides with activities. Educators may preview, copy, or receive NASA materials at these sites. Because each NASA Field Center has its own areas of expertise, no two ERCs are exactly alike. Phone calls are welcome if you are unable to visit the ERC that serves your geographic area. A list of the centers and the regions they serve includes:

*AK, AZ, CA, HI, ID, MT, NV, OR, UT, WA, WY*

NASA Educator Resource Center  
Mail Stop 253-2

**NASA Ames Research Center**  
Moffett Field, CA 94035-1000  
Phone: (415) 604-3574

*CT, DE, DC, ME, MD, MA, NH, NJ, NY, PA, RI, VT*

NASA Educator Resource Laboratory  
Mail Code 130.3

**NASA Goddard Space Flight Center**  
Greenbelt, MD 20771-0001  
Phone: (301) 286-8570

*CO, KS, NE, NM, ND, OK, SD, TX*

JSC Educator Resource Center  
Space Center Houston

**NASA Johnson Space Center**  
1601 NASA Road One  
Houston, TX 77058  
Phone: (281) 483-8696

*FL, GA, PR, VI*

NASA Educator Resource Laboratory  
Mail Code ERL

**NASA Kennedy Space Center**  
Kennedy Space Center, FL 32899-0001  
Phone: (407) 867-4090

*KY, NC, SC, VA, WV*

Virginia Air and Space Museum  
NASA Educator Resource Center for

**NASA Langley Research Center**  
600 Settler's Landing Road  
Hampton, VA 23669-4033  
Phone: (757) 727-0900 x 757

*IL, IN, MI, MN, OH, WI*

NASA Educator Resource Center  
Mail Stop 8-1

**NASA Lewis Research Center**  
21000 Brookpark Road  
Cleveland, OH 44135-3191  
Phone: (216) 433-2017

*AL, AR, IA, LA, MO, TN*

U.S. Space and Rocket Center  
NASA Educator Resource Center for  
**NASA Marshall Space Flight Center**  
P.O. Box 070015  
Huntsville, AL 35807-7015  
Phone: (205) 544-5812

*MS*

NASA Educator Resource Center  
Building 1200

**NASA John C. Stennis Space Center**  
Stennis Space Center, MS 39529-6000  
Phone: (601) 688-3338

NASA Educator Resource Center  
JPL Educational Outreach

Mail Stop CS-530  
**NASA Jet Propulsion Laboratory**  
4800 Oak Grove Drive  
Pasadena, CA 91109-8099  
Phone: (818) 354-6916

*CA cities near the center*

NASA Educator Resource Center for  
**NASA Dryden Flight Research Center**  
45108 N. 3rd Street East  
Lancaster, CA 93535  
Phone: (805) 948-7347

*VA and MD's Eastern Shores*

NASA Educator Resource Lab  
Education Complex - Visitor Center  
Building J-1

**NASA Wallops Flight Facility**  
Wallops Island, VA 23337-5099  
Phone: (757) 824-2297/2298

**Regional Educator Resource Centers (RERCs)** offer more educators access to NASA educational materials. NASA has formed partnerships with universities, museums, and other educational institutions to serve as RERCs in many states. A complete list of RERCs is available through CORE, or electronically via NASA Spacelink at <http://spacelink.nasa.gov>

**NASA On-line Resources for Educators** provide current educational information and instructional resource materials to teachers, faculty, and students. A wide range of information is available, including science, mathematics, engineering, and technology education lesson plans, historical information related to the aeronautics and space program, current status reports on NASA projects, news releases, information on NASA educational programs, useful software and graphics files. Educators and students can also use NASA resources as learning tools to explore the Internet, accessing information about educational grants, interacting with other schools which are already on-line, and participating in on-line interactive projects, communicating with NASA scientists, engineers, and other team members to experience the excitement of real NASA projects.

Access these resources through the NASA Education Home Page: <http://www.hq.nasa.gov/education>

**NASA Television (NTV)** is the Agency's distribution system for live and taped programs. It offers the public a front-row seat for launches and missions, as well as informational and educational programming, historical documentaries, and updates on the latest developments in aeronautics and space science. NTV is transmitted on the GE-2 satellite, Transponder 9C at 85 degrees West longitude, vertical polarization, with a frequency of 3880 megahertz, and audio of 6.8 megahertz.

Apart from live mission coverage, regular NASA Television programming includes a Video File from noon to 1:00 pm, a NASA Gallery File from 1:00 to 2:00 pm, and an Education File from 2:00 to 3:00 pm (all times Eastern). This sequence is repeated at 3:00 pm, 6:00 pm, and 9:00 pm, Monday through Friday. The NTV Education File features programming for teachers and students on science, mathematics, and technology. NASA Television programming may be videotaped for later use.

For more information on NASA Television, contact: NASA Headquarters, Code P-2, NASA TV, Washington, DC 20546-0001 Phone: (202) 358-3572  
NTV Home Page: <http://www.hq.nasa.gov/ntv.html>

**How to Access NASA's Education Materials and Services, EP-1996-11-345-HQ** This brochure serves as a guide to accessing a variety of NASA materials and services for educators. Copies are available through the ERC network, or electronically via NASA Spacelink. NASA Spacelink can be accessed at the following address: <http://spacelink.nasa.gov>



---

# NASA Educational Materials

## Educational Videotape

Educational Videotapes and slide sets are available through the Educator Resource Center Network and CORE (see listing on page 167).

*Microgravity*- Length 23:24

This video describes the restrictions that gravity imposes on scientific experimentation and how they can be greatly reduced in the exciting research environment of the Space Shuttle and the International Space Station.

NASA publishes a variety of educational resources suitable for classroom use. The following resources specifically relate to microgravity and living, working, and science research in the microgravity environment. Resources are available from different sources as noted.

### Slides

Microgravity Science - Grades: 8-12

This set of 24 slides illustrates the basic concepts of microgravity and describes four areas of microgravity research, including: biotechnology, combustion science, fluid physics, and materials science. 1994

### NASA Publications

NASA (1980), Materials Processing In Space: Early Experiments, Scientific and Technical Information Branch, NASA Headquarters, Washington, DC.

NASA (1982), Spacelab, EP-165, NASA Headquarters, Washington, DC.

NASA (1976-Present), Spinoff. NASA Headquarters, Washington, DC (annual publication).

NASA (1994), "Microgravity News," Microgravity Science Outreach, Mail Stop 359, NASA Langley Research Center, Hampton, VA (quarterly newsletter)

NASA (1988), Science in Orbit - The Shuttle and Spacelab Experience: 1981 -1986, NASA Marshall Space Flight Center, Huntsville, AL.

## Suggested Reading

### Books

Faraday, M., (1988) The Chemical History of a Candle. Chicago Review Press, Chicago, IL.

Halliday, D. & Resnick, R., (1988) Fundamentals of Physics. John Wiley & Sons, Inc., New York, NY.

Holden, A. & Morrison, P., (1982), Crystals and Crystal Growing. The MIT Press, Cambridge, MA.

Lyons, J., (1985), Fire. ScientificAmerican. Inc., New York, NY.

American Institute of Aeronautics and Astronautics (1981), Combustion Experiments in a Zero-gravity Laboratory. New York, NY

### Periodicals

Chandler, D., (1991), "Weightlessness and Microgravity," Physics Teacher, v29n5, pp.312-313.

Cornia, R., (1991), "The Science of Flames," The Science Teacher, v58n8, pp. 43-45.

Frazer, L., (1991), "Can People Survive in Space?," Ad Astra, v3n8, pp.14- 18

Howard, B., (1991), "The Light Stuff," Omni, v14n2, pp. 50-54.

Noland, D., (1990), "Zero-G Blues," Discover. v11n5, pp. 7480.

Pool, R., (1989), "Zero Gravity Produces Weighty Improvements," Science, v246n4930, p.580.

Space World, (1988), "Mastering Microgravity," v7n295, p. 4.

Science News. (1989), "Chemistry: Making Bigger, Better Crystals," v136n22, p.349.

Science News. (1989), "Making Plastics in Galileo's Shadow," v136n 18, p.286.

USRA Quarterly. (1992), "Can You Carry Your Coffee Into Orbit?," Winter-Spring.





# MICROGRAVITY—A Teacher's Guide with Activities in Science, Mathematics, and Technology TEACHER REPLY CARD

To achieve America's goals in Educational Excellence, it is NASA's mission to develop supplementary instructional materials and curricula in science, mathematics, and technology. NASA seeks to involve the educational community in the development and improvement of these materials. Your evaluation and suggestions are vital to continually improving NASA educational materials.

Please take a moment to respond to the statements and questions below. You can submit your response through the Internet or by mail. Send your reply to the following Internet address:

[http://ednet.gsfc.nasa.gov/edcats/teacher\\_guide](http://ednet.gsfc.nasa.gov/edcats/teacher_guide)

You will then be asked to enter your data at the appropriate prompt.

Otherwise, please return the reply card by mail. Thank you.

1. With what grades did you use the teacher's guide?

Number of Teachers/Faculty:

\_\_\_\_ K-4 \_\_\_\_\_ Community College

\_\_\_\_ 5-8 \_\_\_\_\_ College/University - Undergraduate

\_\_\_\_ 9-12 \_\_\_\_\_ College/University - Graduate

Number of Students:

\_\_\_\_ K-4 \_\_\_\_\_ Community College

\_\_\_\_ 5-8 \_\_\_\_\_ College/University - Undergraduate

\_\_\_\_ 9-12 \_\_\_\_\_ College/University - Graduate

Number of Others:

\_\_\_\_ Administrators/Staff \_\_\_\_\_ Professional Groups

\_\_\_\_ Parents \_\_\_\_\_ Civic Groups

\_\_\_\_ General Public \_\_\_\_\_ Other \_\_\_\_\_

2. What is your home 5- or 9-digit zip code? \_\_\_\_\_

3. How was the quality of this teacher's guide?

Excellent  Good  Average  Poor  Very Poor

Fold along line and tape closed.

4. How did you use this teacher's guide?

- |  |   |
|--|---|
| <input type="checkbox"/> Background Information              | <input type="checkbox"/> Critical Thinking Tasks    |
| <input type="checkbox"/> Demonstrate NASA Materials          | <input type="checkbox"/> Demonstration              |
| <input type="checkbox"/> Group Discussions                   | <input type="checkbox"/> Hands-On Activities        |
| <input type="checkbox"/> Integration Into Existing Curricula | <input type="checkbox"/> Interdisciplinary Activity |
| <input type="checkbox"/> Lecture                             | <input type="checkbox"/> Science and Mathematics    |
| <input type="checkbox"/> Team Activities                     | <input type="checkbox"/> Standards Integration      |
| <input type="checkbox"/> Other: Please specify: _____        |   |

5. Where did you learn about this teacher's guide?

- NASA Educator Resource Center  
 NASA Central Operation of Resources for Educators (CORE)  
 Institution/School System  
 Fellow Educator  
 Workshop/Conference  
 Other: Please specify: \_\_\_\_\_

6. What features of this teacher's guide did you find particularly helpful?

\_\_\_\_\_  
\_\_\_\_\_  
\_\_\_\_\_

7. How can we make this teacher's guide more effective for you?

\_\_\_\_\_  
\_\_\_\_\_  
\_\_\_\_\_

8. Additional comments:

\_\_\_\_\_  
\_\_\_\_\_  
\_\_\_\_\_

Today's Date: \_\_\_\_\_

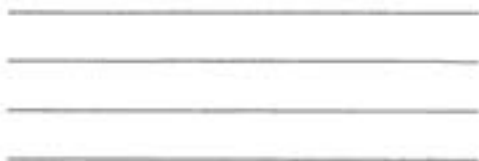

Please Place  
Stamp Here  
Post Office  
Will Not Deliver  
Without Proper  
Postage

**NATIONAL AERONAUTICS AND SPACE ADMINISTRATION  
EDUCATION DIVISION  
MAIL CODE FE  
WASHINGTON DC 20546-0001**



---

Fold along line and tape closed.