

EUROPA

EXPLORATION OF UNDER-ICE REGIONS WITH OCEAN PROFILING AGENTS

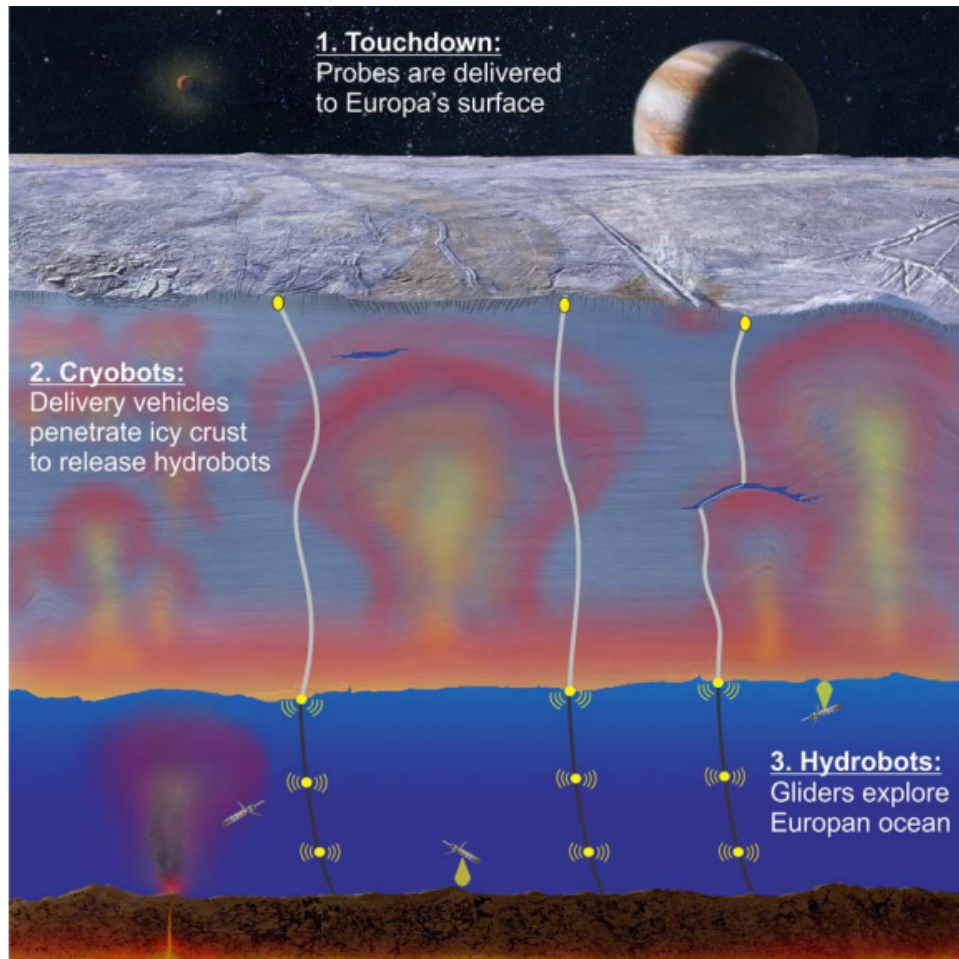

David W Allen, Matthew Jones, Leigh McCue, Craig Woolsey, and William B Moore
Technical Report Number: VaCAS-2013-01

July 6, 2013

Contents

List of Figures	vii
List of Tables	x
List of Abbreviations	xii
Executive Summary	xiii
1 Introduction	1
1.1 Objectives	1
1.1.1 Science Objectives	1
1.1.2 Mission Objectives	4
1.1.3 Planetary Protection	5
2 Europa	6
3 Mission Overview	9
3.1 Mission Phases	9
3.1.1 Launch from Earth	9
3.1.2 Transit to Europa	9
3.1.3 Surface Operations	11
3.1.4 Penetration of the Ice	12
3.1.5 Exploration of the Ocean	12
3.2 Previous and Upcoming Missions	12
3.2.1 Previous Missions	12
3.2.2 Juno	14
3.2.3 Europa “Clipper”	14

4	Fundamental Science	15
4.1	Biology	15
4.2	Ocean Mechanics	16
4.3	Ocean/Ice Interaction	17
4.4	Ice Mechanics	17
4.5	Ocean Floor Mechanics	18
4.6	Chemistry	19
4.7	Surface Geology	19
4.8	Science Traceability Matrix	20
5	Value System Design	23
5.1	The Analytical Hierarchy Process	23
5.1.1	Example of AHP to a Basic System	23
5.2	System Description	25
5.3	Design Criteria	26
5.3.1	Hydrobot Performance	30
5.3.2	Hydrobot Science	31
5.3.3	Hydrobot Communication	31
5.3.4	Cryobot Performance	31
5.3.5	Cryobot Science	32
5.3.6	Cryobot Communication	32
5.3.7	Surface Unit Performance	32
5.3.8	Surface Unit Science	33
5.3.9	Surface Unit Communication	33
5.3.10	Landing System Performance	33
5.4	Complete Value System	34
6	Current State-of-the-Art Technologies and Development	37
6.1	Underwater Gliders	37
6.1.1	Principles of Operation	37
6.1.2	Examples	39

6.1.3	Sensors	41
6.1.4	Power Systems	42
6.1.5	Performance Attributes	42
6.1.6	Performance Limitations	43
6.1.7	New Horizons	45
6.2	Melt Probes	50
6.2.1	Principles of Operation	50
6.2.2	Examples	51
6.2.3	Performance	52
6.3	Spacecraft Power Sources	56
6.3.1	Nuclear Power Sources	56
6.3.2	Batteries	59
6.3.3	Fuel Cells	64
6.4	Hydrobot Sensor Packages	64
6.4.1	Package 3	66
6.4.2	Package 2	67
6.4.3	Package 1	67
6.4.4	Science Traceability Matrix of Sensor Packages	68
6.4.5	Data Rate	68
6.4.6	Sonar	69
7	Design Alternatives	70
7.1	Transit and Landing	70
7.1.1	Launch Vehicles	71
7.1.2	Landing Systems	72
7.2	Surface Operation	72
7.2.1	Importance of RPS in Lander	73
7.2.2	Technology Needs for Lander	73
7.2.3	Communication	74
7.2.4	Science	74

7.3	Ice Operation	74
7.3.1	Payload Capacity	75
7.3.2	Power Source	75
7.3.3	Descent Time	76
7.3.4	Communication	78
7.3.5	Science	79
7.4	Ocean Operation	79
7.4.1	Hydrobot Design	79
7.4.2	Communication	83
7.4.3	Science	84
7.5	Evaluation of Design Alternatives	84
7.5.1	Transit and Landing	84
7.5.2	Surface Unit	86
7.5.3	Cryobot	88
7.5.4	Hydrobot	93
7.5.5	Communication Menu	96
8	Mission Architectures	98
8.1	Proposed Mission Architectures	98
8.2	Evaluation of Mission Architectures	100
9	Roadmap, Timeline, Notional Vehicle Design, and Proposed Concept of Operations	102
9.1	Roadmap and Timeline	102
9.2	Notional Design	103
9.2.1	Surface Unit with Landing System	103
9.2.2	Cryobot	103
9.2.3	Hydrobot	106
9.3	Proposed Concept of Operations	107
10	Conclusions	112
11	Acknowledgements	114

A Other Ice-Covered Worlds	115
B Explanation of Science Traceability Matrix	117
B.1 Biology	117
B.2 Ocean Mechanics	118
B.3 Ocean/Ice Interface	119
B.4 Ice Mechanics	119
B.5 Ocean Floor	120
B.6 Chemistry	121
B.7 Surface Geology	121
C Explanation of the Value System	123
C.1 Notation	123
C.2 Explanation of System Description	123
C.3 Design Criteria	128
C.3.1 Hydrobot Performance	128
C.3.2 Hydrobot Science	130
C.3.3 Hydrobot Communication	132
C.3.4 Cryobot Performance	133
C.3.5 Cryobot Science	135
C.3.6 Cryobot Communication	137
C.3.7 Surface Unit Performance	138
C.3.8 Surface Unit Science	140
C.3.9 Surface Unit Communication	142
C.3.10 Landing System Performance	143
Bibliography	154

List of Figures

0.1	The exploration of Europa’s ocean by biologically inspired hydrobots. Background image http://www.nasa.gov/images/content/206105main_pia10131.jpg	xiii
2.1	Europa’s interior structure (left) consisting of a metallic core, rock mantle, and water/ice shell [1]. The equilibrium temperature structure of the ice shell is shown on the right, for three different shell thicknesses: 20 km (black), 40 km (red), and 60 km (blue).	7
2.2	An illustration of possible structures in the ice shell (after [2]). Warm upwellings and cold downwellings with scales of about 10 km result in lateral temperature variations of about 10 degrees C. Near the surface, re-freezing of impact- or friction-generated melts may leave lenses or sheets of precipitated salts. In warmer regions these may remain liquid as hyper-saline brines.	8
3.1	The configuration of the SLS. Image from NASA, available at http://www.nasa.gov/pdf/623766main_8143_Singer-AD_industry_day-021312_FINAL3.pdf	10
3.2	Costs and masses of past and upcoming missions to the outer planets.	13
3.3	Powers and masses of missions to outer planets.	14
5.1	Legend for design criteria trees shown in Figures 5.2, 5.3, 5.4, and 5.5.	27
5.2	Design criteria tree for the hydrobot. The legend is shown in Figure 5.1.	27
5.3	Design criteria tree for the cryobot. The legend is shown in Figure 5.1.	28
5.4	Design criteria tree for the surface unit. The legend is shown in Figure 5.1.	29
5.5	Design criteria tree for the landing system. The legend is shown in Figure 5.1.	30
6.1	Free body diagram for wings-level gliding flight [3].	38
6.2	Annotated schematic of the Virginia Tech underwater glider [4].	41

6.3	Neutral displacement of a cylindrical hull in water versus length. (Fineness ratio: $l/d = 7$)	44
6.4	Drag polar for a model of the <i>Slocum</i> glider [3].	45
6.5	Example of vehicle path optimization in a steady, uniform flow [5].	46
6.6	Comparison of the relation of tail fin span and area with the body length of various marine mammals (primarily dolphins). The corresponding values for Deepglider [6], Spray Glider [7], and SLOCUM [8] are included. Original figure from <i>Review of Dolphin Hydrodynamics and Swimming Performance</i> by Frank E Fish [9].	48
6.7	Relationship between sweep angle and aspect ratio of the tail fin of marine mammals. The corresponding values for Seaglider*[10] and SLOCUM [8] are included. Original figure from <i>Review of Dolphin Hydrodynamics and Swimming Performance</i> by Frank E Fish [9]. * <i>Estimated from photograph.</i>	48
6.8	The specific energies and operating frequencies of several smart materials [11]. The diagonal lines indicate specific powers, which are the product of the specific energy and frequency. The region corresponding to dolphin-like specific power is indicated by the orange line. These specific powers are based on the total mass of the animal, so is likely less than the propulsive specific power[9].	49
6.9	A diagram of the structure of the Philberth probe. From <i>Heat Transfer and Performance Analysis of a Thermal Probe for Glaciers</i> by Haldor W.C. Aamot.[12]	52
6.10	Descent rate for various sizes of cylindrical probes with various powers, represented by the color contours. This used equation (6.8) with the following parameters: $c_p=2.2$ kJ/kg K, $t_F=273$ K, $t=175$ K, $\rho_i=920$ kg/m ³ , $L_v=330$ kJ/kg. This assumes constant properties.	53
6.11	Relationship between performance number and efficiency and non-dimensional temperature. From <i>Theory of Performance of Isothermal Solid-Nose Hotpoints Boring in Temperate Ice</i> by R.L. Shreve (1962) [13].	54
6.12	Specific Power of RTGs over time with an exponential fit. Historical data per [14]; ASRG data per [15].	58
6.13	This figure shows the practical specific energies of primary, reserve, and secondary batteries. Data per [16].	60
6.14	This figure shows the practical energy densities of primary, reserve, and secondary batteries. Data per [16].	61
6.15	This figure shows the theoretical specific energies of primary, reserve, and secondary batteries. Data per [16].	62
6.16	Specific energies of fuel cell fuels [17].	65
7.1	From 2006 mission architecture study [18]. Radioisotope power is preferable to battery power for a European lander.	73

7.2	The mass and thermal power cylinders of varying diameter and different heights made of GPHS modules. Note that GPHS modules are parallelepipeds, so this is approximated as a cylinder with mass and power densities equivalent to GPHS modules.	75
7.3	Descent time and temperature profile for a linear profile in 10 km thick ice. The ice has constant properties listed in Table 7.1.	77
7.4	Descent time and temperature profile for a two-step linear profile in 10 km thick ice. The ice has constant properties listed in Table 7.1.	78
7.5	Comparison of the propulsive efficiency of marine mammals and a notional propeller reproduced from <i>Passive and Active Flow Control By Swimming Fishes and Mammals</i> by Frank E. Fish and George V. Lauder [19].	81
9.1	Graphical representation of technology roadmap. Images culled from [20, 21, 22, 23, 24, 25, 26, 27, 28, 29, 30, 31].	104
9.2	Notional design of surface unit with cryobot in its stored configuration.	105
9.3	Annotated notional design of the cryobot. Transparent and opaque views are given to show the structure and distribution of interior components.	105
9.4	Annotated notional design of the hydrobot shown in both swimming and gliding configurations.	106
9.5	Spacecraft controlled by landing thrusters. Background image is a photograph of Antarctica from http://polarfieldservice.files.wordpress.com/2009/10/helheim_front.jpg	108
9.6	Initial surface operation consists of establishing communication and raising the hydrobot to begin its descent. Background images are from http://breconbeacons.files.wordpress.com/2012/01/felicity-in-antarctica.jpg and http://spacetelescope.org/static/archives/images/wallpaper3/opo0138a.jpg	109
9.7	Cryobot and surface unit shortly after the descent of the cryobot begins. Background images from http://breconbeacons.files.wordpress.com/2012/01/felicity-in-antarctica.jpg and http://www.polarfield.com/blog/wp-content/uploads/2012/12/DSC00207.jpg	110
9.8	Cryobot descending in a pocket of its own melt water. Background images from http://www.jsg.utexas.edu/news/files/mag_cover_v02.jpg	111
9.9	The exploration of the ocean by hydrobots and cryobots. Background images from http://www.jsg.utexas.edu/news/files/mag_cover_v02.jpg and http://www.nasa.gov/images/content/206105main_pia10131.jpg	111

List of Tables

4.1	Description of scores used for evaluating the ability of a given mission architecture to complete an investigation.	20
4.2	Proposed mission architectures of a mission to explore Europa. The number of each subsystem is included. The subsystems are Surface Units (SU), Cryobots (C), and Hydrobots (H). A brief description of architecture is included. The contents of this table are discussed in further detail in Section 8.1	21
4.3	Science traceability matrix: the scores and corresponding coloring are defined in Table 4.1. Mission architectures are summarized in Figure 4.2.	22
5.1	Table used in AHP	24
5.2	Table used in AHP with arbitrary values	24
5.3	Normalized table used in AHP with arbitrary values	24
5.4	Weights produced from AHP	25
5.5	Normalized weights produced from AHP	25
5.6	Pairwise comparison of the design criteria categories. The vehicles are abbreviated as Hydrobot (H), Cryobot (C), Surface Unit (S), and Landing System (L) and categories are abbreviated as Performance (P), Science (S), and Communication (C), so, for example Surface Unit Science is SS and Hydrobot Performance is HP. . . .	26
5.7	Design criteria category weights	26
5.8	Complete value system design calculated using AHP. Continued in Table 5.9. . . .	35
5.9	Continuation of the complete value system design calculated using AHP. Continued from Table 5.8.	36
6.1	Present-day electric car battery characteristics. Data per [32].	63
6.2	Battery characteristics beyond year 2025. Data per [32].	63
6.3	Instrument package 3	66
6.4	Instrument package 2	67

6.5	Instrument package 1	68
6.6	The science traceability matrix based on sensor packages. The scores and corresponding coloring is explained in Table 4.1.	69
7.1	Properties of the ice used for calculation of the descent time [33]. These are assumed to be constant throughout the ice.	77
7.2	Results of the evaluation of the landing system technologies.	86
7.3	Results of the evaluation of communication design alternatives for the surface unit.	87
7.4	Results of the evaluation of cryobot performance design alternatives. The highest scoring design alternatives are bolded for clarity.	90
7.5	Results of the evaluation of cryobot communication design alternatives. The highest scoring design alternative is bolded for clarity.	93
7.6	Results of the evaluation of hydrobot performance design alternatives. The highest scoring design alternatives are bolded for clarity.	95
7.7	“Menu” for possible communication architectures	97
8.1	Proposed mission architectures of a mission to explore Europa. The number of each subsystem is included. The subsystems are Surface Units (SU), Cryobots (C), and Hydrobots (H). A brief description of architecture is included. For reader convenience, this table is repeated from Table 4.2	99
8.2	Evaluation of mission architectures.	101
C.1	Notation used to describe the relative importance of goals in AHP.	123
C.2	Hydrobot performance design criteria pairwise comparison.	147
C.3	Hydrobot science design criteria pairwise comparison.	147
C.4	Hydrobot communication design criteria pairwise comparison.	148
C.5	Cryobot performance design criteria pairwise comparison.	149
C.6	Cryobot science design criteria pairwise comparison.	150
C.7	Cryobot communication design criteria pairwise comparison.	150
C.8	Surface unit performance design criteria pairwise comparison.	151
C.9	Surface unit science design criteria pairwise comparison.	151
C.10	Surface unit communication design criteria pairwise comparison.	152
C.11	Landing system performance design criteria pairwise comparison.	153

List Of Abbreviations

AHP	Analytical Hierarchy Process
AOE	Aerospace and Ocean Engineering
AUV	Autonomous Underwater Vehicle
ASRG	Advance Stirling Radioisotope Generator
CONOPS	Concept of Operations
EUROPA	Exploration of Under-ice Regions with Ocean Profiling Agents
FR	Fineness Ratio
GPHS	General Purpose Heat Source
GPS	Global Positioning System
HOMER	Heatpipe-Oriented Mars Exploration Reactor
HPS	Heatpipe Power System
IESD	Internal Electro-Static Discharge
LBL	Long Base-Line
LCRD	Lunar Communications Relay Demonstration
LEO	Low Earth Orbit
MHW	Multi-Hundred Watt
NTE	Net Transport Economy
PALACE	Profiling Autonomous Lagrangian Circulation Explorer
RHU	Radioisotope Heating Unit
RPS	Radioisotope Power Source
RTG	Radioisotope Thermal Generators
SAFE	Safe, Affordable Fission Engine
SLAM	Simultaneous Localization and Mapping
SLS	Space Launch System
SNAP	Systems for Nuclear Auxiliary Power
SOLO-TREC	Sounding Oceanographic Lagrangian Observer Thermal RECharging
VSD	Value System Design

Executive Summary

Europa is an incredibly enticing target for exploration – the nearest reaches of what may be a vast new “habitable zone” of interior oceans warmed and stirred by tidal forces. Decades of NASA and National Academy studies including the most recent planetary science decadal survey [34] have affirmed the pre-eminence of Europa as a destination for astrobiology research. This report provides a comprehensive technology roadmap and an assessment of current state of the art and future technologies to enable an under-ice mission to Europa. In this study, the authors provide an overview of key mission objectives, a profile of Europa, and a mission overview. The authors then delve into a discussion of the key fundamental science objectives and design tradeoffs to arrive at a comprehensive science traceability matrix and value system for design of a multi-vehicle, under-ice mission to Europa. The current state of the art is assessed and design alternatives discussed. The report culminates in a concept of operations for the mission and a recommended mission architecture utilizing three surface units, each deploying a single cryobot, with each cryobot carrying three biologically inspired, gliding under-ice hydrobots equipped with sensor packages that will characterize the physical and chemical state of Europa’s ocean over its entire depth.

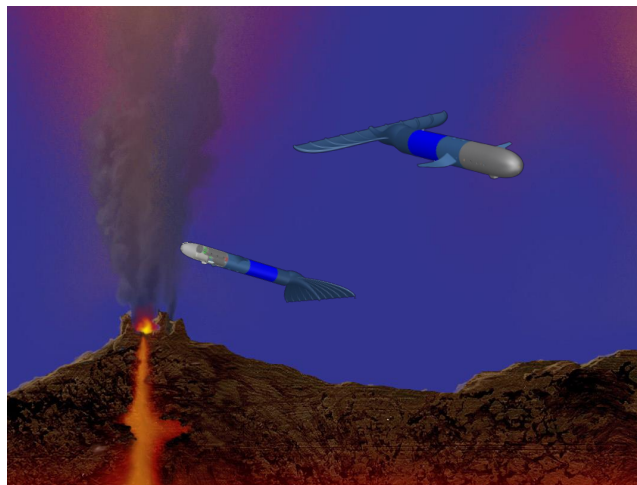

Figure 0.1: The exploration of Europa’s ocean by biologically inspired hydrobots. Background image http://www.nasa.gov/images/content/206105main_pia10131.jpg.

Chapter 1

Introduction

The purpose of this report is to determine the feasibility of a mission to Europa, an ice-covered moon of Jupiter roughly the size of Earth's moon. Europa is believed to have an ocean of liquid water beneath a shell of ice, an ocean potentially with more than twice the volume of water as all of the oceans on Earth [35]. This liquid ocean may support life, presenting a tempting target for exploration. However, the icy shell presents a significant obstacle to the exploration of the ocean. Once the ice is penetrated, exploring the ocean presents its own challenges. One of the major challenges of exploring its ocean is its massive size. Underwater gliders are very efficient vehicles capable of long term missions, crossing ocean-basins on Earth. Underwater gliders have a natural profiling motion, so they are excellent vehicles for exploring deep oceans. A timeline and roadmap is presented for this mission which describes what technologies need to be developed for this mission and estimates when this mission will be feasible.

1.1 Objectives

This section enumerates the objectives for a successful mission to Europa. The designs are evaluated in terms of these objectives. There are two main types of objectives: science objectives and mission objectives. The science objectives include measurements to take and experiments to perform. Since the goal of a mission to Europa would be scientific exploration, a mission that does not complete at least some of its scientific objectives would be a failure. The mission objectives relate to operations that support the mission but do not directly address scientific measurement. The specific science and mission objectives are described below. Note that some of these objectives may be completed in preliminary missions that do not involve penetrating the ice crust [36].

1.1.1 Science Objectives

The following fundamental science objectives are considered drivers for the mission and vehicle design.

1. Biology

- (a) Determine if European environment is conducive to life. This is the primary objective of the proposed Europa mission. Many of the remaining science and mission objectives support this primary objective.
- (b) Look for favorable distributions of elements. In particular, look for the presence of oxidants and reductants that would provide energy for life.
- (c) Characterize the nature of potential forms of life. This step involves a broad classification of potential mechanisms by which the environment may support life.
- (d) Characterize specific biological processes (e.g., chemosynthesis).
- (e) Locate organisms. The mission should seek to place appropriate sensors in locations deemed most likely to sustain life, e.g. a hydrothermal vents.

2. Ocean Mechanics

- (a) Water composition and basic properties. This is a general description of the composition of the ocean at various depths. Measurements include salinity, pH, and trace elements. It will be essential to take basic measurements of the physical properties of the water at various depths.
- (b) Acquire additional data regarding the amplitude and phase of the gravitational tides, induction response from the ocean, surface motion [36]. This objective is to describe how water moves within the ocean. This will help to understand how the ocean behaves on a global scale.
- (c) Investigate the influence of ocean currents on the angular momentum budget of Europa. Globally characterize the tidal response of the ocean and its coupling to the ice and interior [36].

3. Ocean/Ice Interface

- (a) Material Exchange Rate. This objective seeks to determine the mechanisms and fluxes of material exchange between the ocean and ice. This informs calculations of the age of the ice as well as the relevance of measurements taken in the ice and at the surface for ocean properties.
- (b) Describe transition region. To describe the transition region one must assess various factors in the transition from ice to ocean including how the crust goes from relatively solid ice to liquid, the size of the transition region, and characteristic properties of the transition region, such as temperature profile.

4. Ice

- (a) Composition. Any European explorer should seek to determine the salinity, trace element, pH, etc of the ice.
- (b) Mineralogy. This objective is to determine the mineralogy of the regolith. This will give a better understanding of where the regolith came from.

- (c) Convection. Some models indicate that the ice has a thin, brittle outer crust and a thick convecting sub-layer of ice. This objective is to describe the nature of this convecting sub-layer, including thickness and convection rate.
- (d) Porosity. This objective is to describe the porosity of the ice, which has a major impact on the drilling rate through the ice.
- (e) Temperature profile. This objective is to describe how the ice's temperature varies from a hypothesized 100K at the surface to about 273K at the top of the ocean [37].
- (f) Thickness. This objective is to determine the thickness of the ice. It is also to describe how the ice varies around the surface and attempt to describe why thickness variations occur.

5. Ocean Floor

- (a) Bathymetry. Mapping sections of the ocean floor will help formulate a framework of what geological processes are on-going on the floor of the European ocean.
- (b) Active processes. This objectives is to locate any on-going geological phenomena (e.g. hydrothermal vents) on the ocean floor. This will also inform the search for life.
- (c) Distribution of interesting features. This objective is to attempt to determine the distribution of interesting features on the ocean floor. This requires nearly global coverage.
- (d) Composition and mineralogy. This objective is to study the composition of the ocean floor and to determine the nature of any rocks. Such a study will improve man's understanding of Europa's geological processes.

6. Chemistry [36]

- (a) Characterize organic and inorganic chemistry on the surface, specifically looking for indications of a life conducive environment.
- (b) Investigate relation between composition and geological processes, particularly with communication with the interior.
- (c) Further investigate the effects of radiation on surface composition, sputtering, albedo, and redox chemistry. In particular, look for the production of oxidants that may be transported to the ocean.

7. Geology [36]

- (a) Study tectonic, magmatic, and impact features.
- (b) Search for areas that demonstrate recent or current geological activity.
- (c) Investigate heat flow on both local and global scales.
- (d) Assess relative surface ages.
- (e) Investigate the regolith, paying close attention to its physical properties and processes of deposition and erosion.

1.1.2 Mission Objectives

The following fundamental mission objectives are considered enablers for the science objectives and drivers for the vehicle design.

1. Transit from Earth to Europa

- (a) Maximize the payload capacity in order to carry the most scientific equipment possible.
- (b) Optimize fuel use with respect to time of flight. This objective has to do with choosing the optimal trajectory for the mission. It deals with the trade-off between high-energy and low-energy trajectories.
- (c) Minimize radiation exposure in order to protect instruments and electronics from ionizing radiation. This has to do with both choosing a trajectory and adding shielding.
- (d) Determine optimal landing site. Before initiating the landing procedure, the spacecraft should determine the optimal landing site on the surface. This may be completed by an earlier mission, such as the Europa Clipper Mission.

2. Landing

- (a) Land safely. It is essential that the vehicle(s) land on the surface without damage to mission critical systems.
- (b) Land near chosen landing site. As the European surface may pose various perils as well as present optimal locations to penetrate the ice, landing far from selected sites could endanger the mission.

3. Surface Operation

- (a) Maintain communication with Earth. It is the role of the surface unit to maintain a data link with Earth. This may be a persistent or intermittent link, but must be maintained for the duration of the mission. Communication can be through any number of relay satellites or directly to Earth.
- (b) Start tunneling process. The surface unit must prepare and deploy the ice-penetrating apparatus, and potentially start the melting process itself.

4. Melting

- (a) Avoid regolith that may jeopardize the melting process.
- (b) Maintain the optimal descent rate. This will ensure that the melt probe does not descend too quickly or slowly; either extremum may hinder the melting and descent process.
- (c) Maintain communication with the surface unit. This can be done by radio communication (through transceivers or directly), by tethers, or both.

5. Ice/Ocean Interface

- (a) Secure the cryobot in place. The cryobot must prepare and deploy the hydrobot, so it is necessary to stay in one place near the ice/ocean interface. It also must stay in place to complete the communication link to the surface.
- (b) Since the communication to the hydrobot will be at least partially through acoustic transmission, it is necessary to describe the acoustic environment in the ocean.
- (c) Before launch the cryobot must test the hydrobot(s) in order to ensure proper operation before launching.
- (d) Launch hydrobots and maintain communication

6. Ocean operation

- (a) Collect scientific data required
- (b) Relay the data back to the cryobot, which will require the hydrobot to return to the vicinity of the cryobot.

7. Planetary protection

- (a) Ensure cleanliness of all components reaching the surface of Europa.
- (b) Ensure long-term containment of all components left on or in Europa.

There are other objectives that would likely be included in this mission that are not directly related to Europa. For example, since the spacecraft will likely fly close to Callisto, it would take images of Callisto. These objectives are not included because they are not necessary for a successful Europa exploration mission and would vary based on other design choices.

1.1.3 Planetary Protection

Planetary protection is the overarching principle that cross-contamination of habitable regions of the solar system is to be avoided, and Europa is categorized as among the most sensitive environments [38] requiring the most stringent requirements for cleanliness. Preventing contamination of Europa's ocean or ice with terrestrial life is a primary mission concern, encompassing all phases of the mission (including proper disposal of any orbital assets). Planetary protection protocols continue to evolve [39], and it is difficult to predict what will be in place in the time horizon of this mission, but the recommended architecture has a number of features that are favorable for planetary protection.

First, the radiation environment at Europa's surface will sterilize components left there over periods of months to years. Second, the cryobot's nuclear power unit will gradually irradiate its components, and shielding could be dropped at the end of the mission in order to accelerate this process. Finally, the hydrobot design allows the interior to be hermetically sealed, preventing the release of any contaminating microbes. A more thorough treatment of planetary protection considerations for this mission will be deferred to later phases of this project.

Chapter 2

Europa

Europa is an enticing target for exploration due to its hypothesized interior oceans warmed and stirred by tidal forces. Decades of NASA and National Academy studies including the most recent planetary science decadal survey [34] have affirmed the pre-eminence of Europa as a destination for astrobiology research. There are three aspects of Europa that make it such an intriguing place: ocean, structure, and tides. In this section the authors summarize current knowledge of Europa and anticipated near-future results.

The presence of an ocean of liquid water within Europa was the domain of science fiction [40] until the *Galileo* spacecraft observed compelling evidence for magnetic fields induced in an electrically conductive layer within Europa [41, 42]. The conductivity of this layer is compatible with that of seawater [43], but precise constraints on its composition, depth, or thickness could not be obtained from these measurements [44, 45]. Combined with spectroscopic evidence for hydrated salts at the surface of Europa [46, 47, 48], the presence of a salty, liquid water ocean within a few tens of kilometers from the surface is all but confirmed.

The interior structure of Europa was also revealed by *Galileo* by Doppler tracking of its telemetry stream during close fly-bys of the moon [1, 49, 50]. Under the assumption that the non-ice part of Europa is similar to Io, the permanent tidal and rotational deformation of Europa reveals an internal structure with a water/ice layer 115 km thick lying above a rocky mantle that encircles a core of about 1/3 to 1/2 Europa's radius. This structure is shown on the left of Figure 2.1 including a 40 km thick ice shell. If the interior is less dense than Io (it is unlikely to be more dense), the water/ice layer could be thinner, perhaps as thin as 80 km [49]. These observations support the very interesting conclusion that Europa's ocean is in direct contact with its rocky mantle, since high-pressure phases of ice (Ice III, Ice V, etc.) are only stable at depths greater than 117 km within Europa [50]. This is important because the chemistry of life depends critically on two elements that are typically bound to rocks: sulfur and phosphorous. Rock-water chemistry (particularly at elevated temperature) liberates these elements and many others (halides, alkali metals, iron, magnesium) from the rocks and puts them in solution where life can access them [44, 51].

Maintaining a liquid ocean on a body the size of Europa against the loss of heat to space requires the presence of an internal heat source. In Europa's case, heat deposited within the ice shell by tidal friction is sufficient to maintain a liquid ocean indefinitely [37]. More importantly, tidal friction in

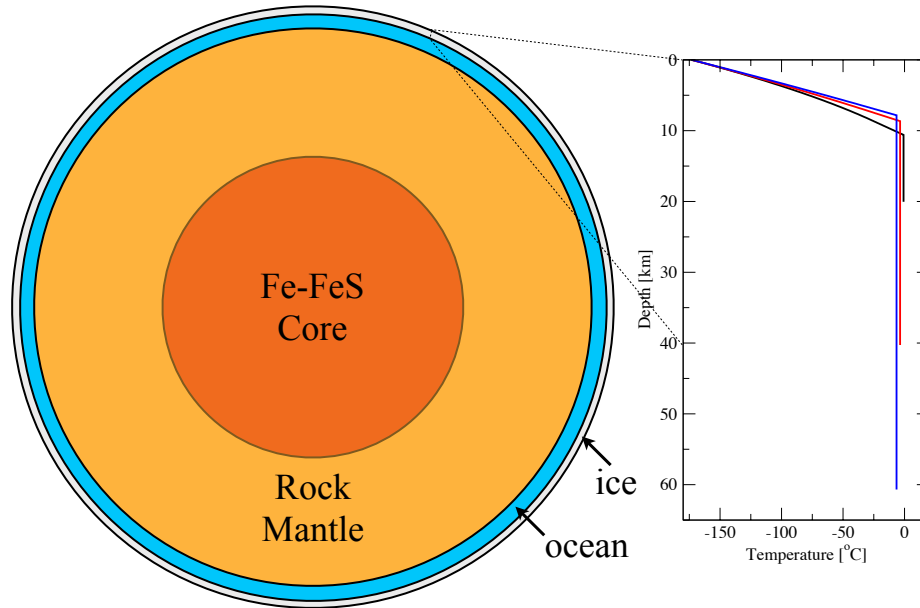

Figure 2.1: Europa’s interior structure (left) consisting of a metallic core, rock mantle, and water/ice shell [1]. The equilibrium temperature structure of the ice shell is shown on the right, for three different shell thicknesses: 20 km (black), 40 km (red), and 60 km (blue).

the silicate interior of Europa may drive volcanic activity at the water-rock interface [52], leading to the high-temperature water-rock interactions that provide both energy and nutrients to the ocean. Finally, tidal currents in the ocean can also dissipate energy and potentially stabilize an ocean against freezing [53]. These currents are estimated to be on the order of centimeters per second, but could be nearly a meter per second peak amplitude [53].

The thickness of the ice shell remains uncertain, but several lines of evidence [54, 55, 56, 37] indicate that it is more than 10 km thick on average. Sub-solidus convection is likely to control the thickness of the shell, resulting in a temperature profile that rises quickly as one descends through the conductive lid and then more gradually in the convecting interior [37] as shown on the right of Figure 2.1. Within the shell itself, the average temperature is within about 10 degrees of the melting point, and cold downwellings and warmer upwellings will result in lateral temperature variations of about 10 degrees C (Figure 2.2).

Within the cold ice near the surface, impurities may be trapped and potentially concentrated into lenses or sheets where impact- or friction-generated melts pool and freeze [2] as illustrated in Figure 2.2. Near the surface, these lenses may consist of tens of meters of precipitated salts covering hundreds of square kilometers. Re-heating of such deposits (by the arrival of a warm upwelling, for example) may result in brine production and mobilization of overlying material [57]. Since such mobilization may have happened in the past, the presence of disrupted surface material (e.g. chaos regions) is not necessarily indicative of warm ice underneath at present. Locating thinner, warmer regions of the shell may be possible with ice-penetrating radar investigations [2] such as that proposed for the Europa Flagship mission studied by the Decadal Survey [34] or being developed for ESA’s JUICE mission. Other possible future mission inputs include surface temperature

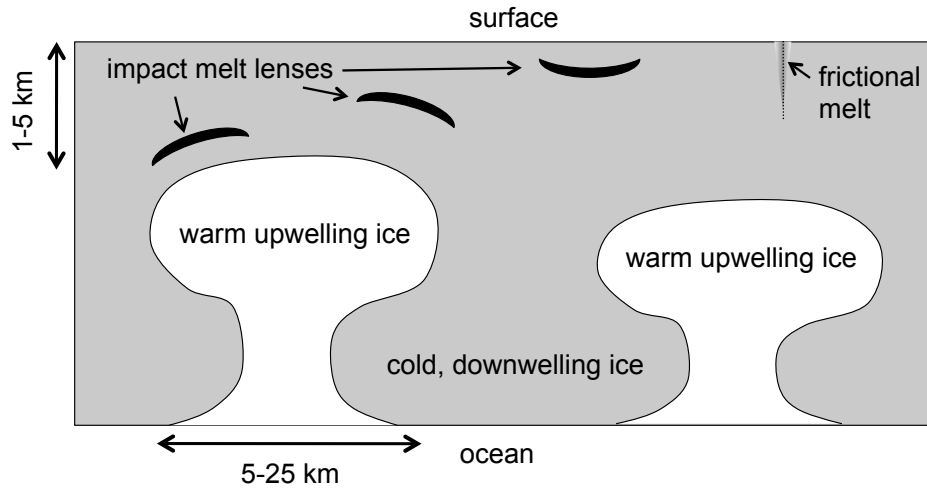

Figure 2.2: An illustration of possible structures in the ice shell (after [2]). Warm upwellings and cold downwellings with scales of about 10 km result in lateral temperature variations of about 10 degrees C. Near the surface, re-freezing of impact- or friction-generated melts may leave lenses or sheets of precipitated salts. In warmer regions these may remain liquid as hyper-saline brines.

or heat flow maps [58], surface tidal deformation, or seismic structure determination [59].

Chapter 3

Mission Overview

3.1 Mission Phases

3.1.1 Launch from Earth

It is anticipated that this mission would be planned as a launch from Earth using large, chemically-driven rockets. There are several technologies that may revolutionize space launch such as magnetic levitation and propulsion. The technology for these systems already exists, but there are many engineering challenges involved in their construction, including the size of the system and the transition from magnetic levitation to flight [60]. These systems still often involve chemical propulsion and therefore are only minor improvements over current technologies. Furthermore, the claimed launch cost improvements ignore the development costs, so the cost benefits are often inflated. Other paradigm changing space launch systems, such as space elevators, require several decades of development, and may not be possible for a few generations.

There are two current sources of space launch technologies: NASA and commercial companies. Commercial companies tend to develop launch systems that support the majority of launches, *e.g.* commercial satellites. As such, they are not developed to launch large vehicles to other planets, although present commercialization efforts may change that over the coming decades. To the knowledge of the authors, the largest launch vehicle presently in development is the NASA Space Launch System (SLS), shown in its various configurations in Figure 3.1.

The smallest configuration, Block 1, is capable of delivering over 10 metric tons to Europa [61]. The SLS also allows for direct trajectories to outer planets, eliminating the need for gravity assists and reducing the transit time over smaller launch vehicles.

3.1.2 Transit to Europa

There are two primary options for transiting between Earth and the Jupiter system: a direct transfer and using gravity assists. As the name implies, a direct transfer is a trajectory that goes from Earth

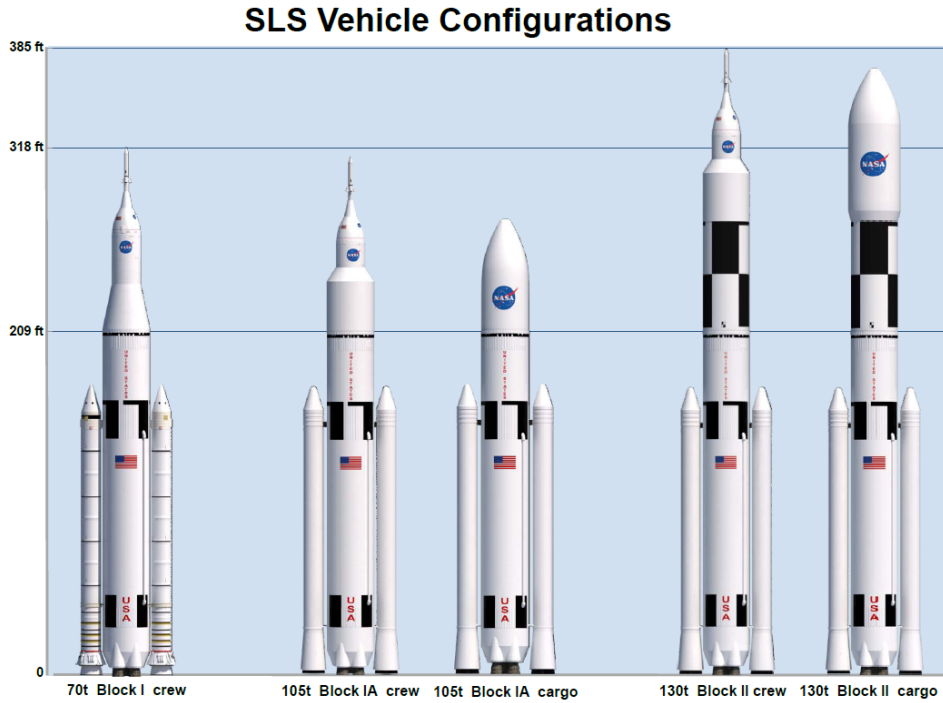

Figure 3.1: The configuration of the SLS. Image from NASA, available at http://www.nasa.gov/pdf/623766main_8143_Singer-AD_industry_day-021312_FINAL3.pdf

to Jupiter without encountering any other bodies. The alternative is to use other planets' gravity to assist in the transfer to Jupiter. Using gravitational assists allows for more mass to be transferred than for a direct trajectory, but requires significantly more time. Once the spacecraft reaches the Jupiter system, it must travel to Europa. Typically missions to outer planets utilize numerous moons' gravity to travel through the system. This is very efficient in that it requires fuel only for minor course corrections, but carries cost in time.

Radiation is a major concern for all space missions. Ionizing radiation can cause many issues for a spacecraft, particularly damage to electronic components. Further, the Jupiter system is known to have a particularly strong radiation environment, one that would destroy unprotected electronics quickly [20]. Use of a direct trajectory via the SLS would reduce time of flight and, thus, the radiation exposure during transit. Routes through the Jupiter system that avoid the inner regions also reduce the total radiation dose [20].

Near Earth and Interplanetary Radiation

Although radiation can cause issues in the near-Earth and interplanetary environments, it is not significant compared to the Jovian Radiation environment. Since the spacecraft must be designed to survive the Jovian radiation environment, there is not the requirement of adding additional shielding for the transit environment. Thus, all of the radiation considerations will be for the Jovian system, and the spacecraft must survive the Jupiter environment with a significant safety margin;

the extra shielding for the near-Earth and transit environments will be absorbed into this safety margin.

Radiation in the Jupiter System

The radiation in the Jupiter system is very hazardous for spacecraft. In particular, the inner regions (below the orbit of Europa) will expose a spacecraft to a very high radiation dose. For the purpose of limiting radiation exposure, a spacecraft should minimize time within the radiation belts. One such trajectory is the “Banzai Pipeline”. The pipeline utilizes out-of-plane orbits and gravity assists from Ganymede and Callisto to produce a trajectory that allows for transit to Europa with modest ΔV requirements and minimal radiation exposure [20].

Spacecraft Charging

Spacecraft charging is a common phenomenon for all spacecraft. Jupiter has a very strong charging environment, which can cause dangers to the spacecraft. Europa is inside the region around Jupiter where there is high risk of Internal Electro-Static Discharge (IESD). [62] This can pose serious risk to the electronics and other components on the spacecraft. Because the risk of IESD is low below the ice of Europa, this concern is primary during flight and on the surface. The transit portion of this mission would require controlled discharges and/or specific spacecraft coating designed to reduce charging risk [62].

3.1.3 Surface Operations

After landing on Europa, there are several tasks that must be performed. The first task is establishing a communication link to Earth that will allow the status of the mission to be monitored and controlled and to begin returning scientific data. In addition to this, the surface unit must begin the process of tunneling through the ice. Time is critical in this phase as the radiation on the surface of Europa presents a risk of damaging the spacecraft.

Radiation on Europa

Describing the radiation on Europa is really a task of describing the radiation at the surface. The radiation dose one meter below the surface is almost six orders of magnitude less than at the surface [63]. A component that could survive for hours or days on the surface could survive for years or decades a meter below the surface. While the entire lander cannot be buried below the ice because some components must remain on the surface (e.g. antennas), careful prioritization of which items must survive on the surface, which items must be buried, and which may be allowed to ‘die’ after landing will enable optimal use of radiation protection and weight.

The surface of Europa experiences a widely varying radiation dose, ranging from 2 to 30 krad/day [20]. This variation is mostly due to the motion of Europa and the geometry of the Jupiter system.

The minimum radiation exposure occurs at a latitude for 45° south of the equator, on the “trailing” side of Europa. Since Europa is rotating, the amount of radiation at this location varies, but is never significantly more than the global average (about 15 krad/day) [64]. The components that must be left on the surface must be able to withstand a 45 krad/day radiation dose for the duration of the mission. All other essential components shall be buried in the borehole created by the cryobot.

3.1.4 Penetration of the Ice

The ice presents one of the primary barriers to exploring the ocean on Europa. The vehicle responsible for tunneling through the ice is referred to as a “cryobot”. Transiting to Europa and landing are difficult, but reasonably well understood tasks. Tunneling through ten or more kilometers of ice on an alien moon, however, has never been attempted. The preferred method of tunneling is using heat to melt a tunnel through the ice. This eliminates the need for mechanical drills, improving reliability. The surface of Europa is a near-perfect vacuum, therefore, the ice will initially be sublimated rather than melted. Sublimation requires significantly more energy than melting, so it is important to plug the borehole, either intentionally or by allowing it to collapse in on itself. After the tunnel entrance is “plugged” pressure will build inside the tunnel, allowing the ice to melt. The cryobot may also need to navigate around regolith during descent.

3.1.5 Exploration of the Ocean

Ocean exploration is the principal aim of the EUROPA mission. The exploration will be conducted by one or more underwater gliders called “hydrobots”. Underwater gliders generate forward motion using variable buoyancy and fixed wings. Their operation results in a natural profiling motion where the glider rises and falls through the water column as it travels from point to point. The hydrobots will take advantage of this natural profiling motion to take samples throughout the water column. The main disadvantage of underwater gliders is their slow movement. Traditional underwater gliders may be unable to overcome even modest currents. If strong currents are indicated, the hydrobot will likely have to carry an alternative propulsion mechanism. Navigation on Europa also presents unique challenges. On Earth, gliders navigate by dead reckoning using estimates of speed and magnetic heading, with occasional GPS corrections (when surfaced). On Europa, GPS corrections will not be available, so alternative navigational techniques must be used to supplement dead reckoning.

3.2 Previous and Upcoming Missions

3.2.1 Previous Missions

There have been several missions to explore the outer planets. These missions started in the 1970’s and continue to this day. The first missions to the outer planets were Pioneer 10 and 11 [65], followed shortly after by the Voyager 1 and 2 probes [66]. It should be noted that, although these

missions studied Jupiter, they did not orbit the planet nor any of its moons. Additionally, the Ulysses [67], Cassini [68], and New Horizons [69] missions briefly studied Jupiter en route to their final targets. The only Jupiter orbiter to date is the Galileo spacecraft [70]. Despite the fact that most of these missions did not directly study Jupiter, they are comparable because they studied the outer planets.

One of the most common rules of thumb for designing spacecraft is $\text{Mass} \propto \text{Cost}$. The team examined this idea and found that it holds for the missions listed previously. It should be noticed that there are two masses of interest: wet mass and dry mass. The wet mass is the total mass of the spacecraft including expendable materials (e.g. fuel), and dry mass is the mass of only spacecraft systems. The Cost-Mass trends for both wet and dry mass are shown in Figure 3.2. A linear trend was found to adequately approximate the cost based on the mass. Similarly the

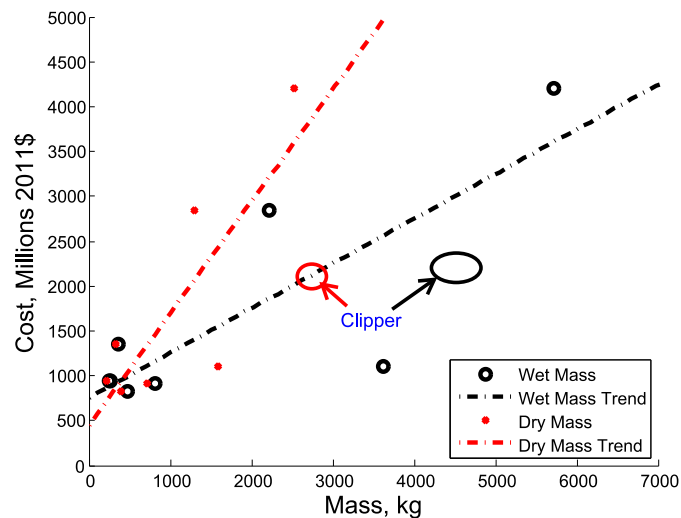
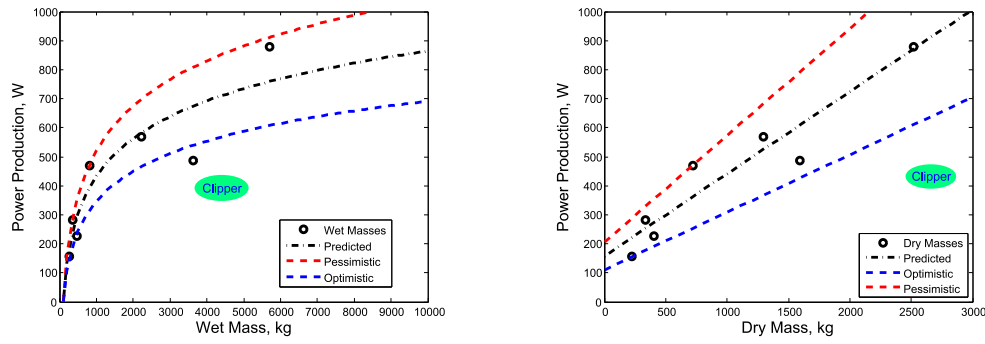

Figure 3.2: Costs and masses of past and upcoming missions to the outer planets.

power requirements of these missions was examined. That is, the amount of power required by the spacecraft was approximated based on the spacecraft’s mass. The trends for both the wet and dry masses are shown in Figure 3.3. These figures show that the mass of a spacecraft is a very good estimate of the spacecraft’s power requirements. In Figure 3.3(a) one notes that as wet mass increases, the amount of power increases, but at a decreasing rate. This is due to the fact that the more massive missions are orbiters (opposed to fly-bys) and have high Δv requirements necessitating a higher fuel load. If one does not consider the mass of the fuel by examining the dry mass of the spacecraft, the trend becomes linear, as shown in Figure 3.3(b). This means that the amount of power that a spacecraft uses is directly proportional to the dry mass of the spacecraft.

This information is used to provide a rough idea of the cost and power requirements of the under-ice mission. However, given the innovative nature of such a mission, implicit assumptions may break down. Note that the proposed Europa “Clipper” mission [71] is an outlier from the historical trends identified in Figures 3.2 and 3.3.



(a) Wet Mass

(b) Dry Mass

Figure 3.3: Powers and masses of missions to outer planets.

3.2.2 Juno

Juno is a spacecraft that, at the time of writing, is en route to Jupiter. Juno will enter a polar orbit around Jupiter. The primary goal of Juno is to study Jupiter, specifically Jupiter’s atmosphere, magnetic field, gravity field, and polar magnetosphere. Juno is expected to arrive at Jupiter in August of 2016 [72].

3.2.3 Europa “Clipper”

The “Clipper” mission is a currently proposed NASA mission to study Europa. This multi-flyby mission will not actually enter orbit of Europa, but will enter an orbit of Jupiter that carries it close to Europa many times [73]. This results in coverage similar to an orbit without the extra fuel required to enter orbit. “Clipper” will also spend more time further away from Jupiter, reducing radiation exposure compared to an orbiter. Of particular note with the Europa Clipper mission, is the proposed mission represents a paradigm shift in both cost and power requirements as seen in Figures 3.2 and 3.3. Compared to previous missions, comparing both wet and dry mass, Clipper functions with less power per pound and is less expensive, pound-for-pound, than previous missions. Data from Clipper will be useful in determining optimal landing sites for future Europa missions and will inform modern understanding of the thickness of the ice. Clipper may also help determine if Europa is conducive to life and from that, inform what hardware and sensor packages an under-ice mission should carry.

Chapter 4

Fundamental Science

Fundamental science conducted on this mission will focus upon improved understanding of biology, ocean mechanics, ocean/ice interaction, ice mechanics, ocean floor mechanics, chemistry, and surface geology on Europa. These research objectives represent an overall study of Europa and are listed in no particular order. It should be noted that these seven items correlate to the science objectives listed in Section 1.1.1. For each of these fundamental science objectives, specific investigations are described. This is for the purpose of then evaluating if a specific mission architecture, that is, a vehicle fleet, would be capable of accomplishing all scientific objectives. Therefore, this chapter is organized such that the science objectives and investigations are described first, followed by a science traceability matrix which summarizes the science objectives and assesses which vehicle combinations are best able to accomplish the objectives.

4.1 Biology

There are five investigations required to complete the biology objective. These are ordered in terms of complexity and difficulty, with the least complex and difficult first. In general, each investigation will be completed before subsequent investigations. It should be noted that the present team does not include a biologist; therefore presented here is only a general framework. A biologist would be needed for further refinement of this objective and identification of specific sensors to be used.

- *Biological Investigation 1*: The first biological investigation determines if Europa has an environment conducive to life as mankind knows it, that is: liquid water, chemical building blocks, and energy sources. This is a general overview of the European environment and does not attempt to determine if the environment is *likely* to harbor life, merely if the environment appears capable of supporting some form of life.
- *Biological Investigation 2*: The next investigation begins to evaluate the likelihood of existence of life on Europa by examining the chemical environment on Europa. This investigation looks for favorable distributions of the chemicals necessary for life. This also looks for the distributions of oxidants and reductants that will allow for the chemical disequilibrium

required for life. Other investigations will determine the sources and fluxes of these oxidants and reductants, if they are present.

- *Biological Investigation 3*: The previous two investigations seek to determine if Europa has the physical and chemical properties necessary for life. This investigation actively seeks signs of life. In particular, the first step is to look for chemical signs of biological processes (biosignatures) that might be widely distributed through the ocean.
- *Biological Investigation 4*: The next investigation seeks to specifically identify and localize any active biological processes. This may involve attempting to trace certain biosignatures back to their source.
- *Biological Investigation 5*: The final investigation is to locate organisms. This is the most difficult of the biological investigations because life, if it exists, may be a highly localized, elusive, or irregular phenomenon. Thus this requires a vehicle, most likely the hydrobot, to navigate near potential organisms (e.g. navigate toward hydrothermal vents), which may be far from the entry point to the ocean.

4.2 Ocean Mechanics

The ocean of Europa is both deeper and more voluminous than Earth's oceans, but has similar pressures. Europa's gravity is about one-tenth of Earth's and Europa's oceans are about ten times deeper; therefore, the pressure at the ocean floor of Europa is about the same as the pressure at the deepest regions of Earth's oceans.

- *Ocean Mechanics Investigation 1*: The first investigation is to determine the composition and basic properties of the ocean. This includes measuring salinity, pH, and the distributions of trace elements at various depths, along with properties such as temperature and density [74][75]. It is important to take these measurements over a large spatial area and measure over time in order to understand how these properties vary throughout the ocean and what measurements represent the steady-state nature of the ocean. This investigation will provide a better context for all other investigations conducted within the ocean.
- *Ocean Mechanics Investigation 2*: One of the most interesting features of Europa is its tidal interaction with Jupiter. Jupiter causes massive tidal flexing [76]. The heat generated by this flexing is one of the primary reasons that Europa is believed to have a liquid water ocean. Understanding the tidal dynamics is vitally important for understanding the ocean mechanics in general. It describes the large-scale motion of water through the ocean. This motion influences Jupiter's magnetic field near Europa, so understanding the tides helps better understand this investigation [73]. Additionally, the tides of the ocean effect the "geology" of the ice crust, so understand the tides will help to understand the origin of the geological features of the ice crust.
- *Ocean Mechanics Investigation 3*: In addition to investigating the tidal dynamics, it is important to understand the role of the ocean in influencing the rotation state of Europa. This

investigation is to determine the effect of tidal dynamics on the angular momentum budget of Europa, among other effects [77]. These effects may not be solely due to the ocean mechanics, and, as such, could be categorized under ocean/ice interaction, ice mechanics, or surface geology. This investigation will give a better context of the tidal mechanics of Europa because it will reveal the coupling between tides and rotation.

4.3 Ocean/Ice Interaction

The ice-ocean interface represents a “third surface” of Europa, along with the surface of the ice and the ocean floor. On Earth, such interfaces often harbor life. There are two proposed investigations for this mission focusing on the ice-ocean interface.

- *Ocean/Ice Interaction Investigation 1*: Material exchange, particularly the mechanisms and rates of exchange of materials between the ocean and the ice crust is to be studied. This material exchange is necessary to transport oxidants from the surface to the ocean and will enable the interpretation of surface and ice data. The rate also helps inform the age of the ice shell and its chemical evolution.
- *Ocean/Ice Interaction Investigation 2*: A survey of the interface region will be conducted including temperature and density profiles of the interface. Additionally, this investigation shall seek to explore the possible presence of gas pockets or clathrate deposits at the ocean/ice interface. This investigation will also describe how the ice transitions to ocean; whether the transition is abrupt or smooth.

4.4 Ice Mechanics

The ice crust of Europa is, at present, the primary source of information about the ocean. The ice covers the entire surface and shows evidence for active physical and chemical processing, such as the ubiquitous cracks and ridges and the broad patterns of non-ice material [47]. The ice mechanics are both the static and dynamic properties; what the ice is made of and how it moves.

- *Ice Mechanics Investigation 1*: The first investigation is the composition of the ice. These measurements include salinity, pH, and determining the presence of trace elements. This, along with similar measurements of the ocean, will help explain the material transport within the ice and how material is exchanged with the ocean.
- *Ice Mechanics Investigation 2*: The second, related investigation seeks to determine the mineralogy of the rocky regolith, if present. This regolith will likely be the product of impacts.
- *Ice Mechanics Investigation 3*: The third investigation seeks to provide an understanding of the mechanics of the ice. Specifically, the cryobot would locate and describe any convection

within the ice. This convection will likely be the primary driver of material transport within the ice. This will help carry oxidants from near the surface to the ocean. The important properties are the size of the convecting cells, the rate of convection, and the temperature profile within these cells [74].

- *Ice Mechanics Investigation 4*: The mission will seek to characterize the porosity of the ice. The porosity affects the density and strength of the ice and, therefore, plays a major role in the mechanics of the ice [78].
- *Ice Mechanics Investigation 5*: The mission will gather data on the temperature profile of the ice. Understanding the temperature profile will improve mankind's understanding of the ice mechanics, including ice density, through the ice crust.
- *Ice Mechanics Investigation 6*: The mission will quantify the thickness of the ice. The thickness may be determined by previous missions, such as "Clipper," but it is a vitally important measurement and this under-ice mission will provide a ground-truth measurement.

4.5 Ocean Floor Mechanics

The opportunity to study the ocean floor is one of the primary drivers for an under-ice mission to Europa. The ocean floor of Europa is possibly the most interesting region of Europa as it is hypothesized to have active geological features. These features may support life, or provide the reductants necessary for life.

- *Ocean Floor Mechanics Investigation 1*: The first investigation is the bathymetry of the ocean floor. This will look for features that indicate active and past geological activity.
- *Ocean Floor Mechanics Investigation 2*: With bathymetry data, the second scientific investigation under this objective is to locate any on-going geological processes. In this scientific investigation priority is placed upon detailed observation of a limited number of geological features [79].
- *Ocean Floor Mechanics Investigation 3*: While the prior investigation prioritized detailed study of a limited number of features, a highly related investigation is to study the distribution of important features. This is distinct from locating and studying important features because studying the distribution does not require close investigation. The distributions of important features will help to understand the processes in determining the prevalence and variation of particular phenomena [80].
- *Ocean Floor Mechanics Investigation 4*: In addition to mapping and locating features on the ocean floor, the composition and mineralogy of the ocean floor will be studied. This would involve sampling the soil/rock on the ocean floor and relaying mineralogical data to scientists on Earth [81].

4.6 Chemistry

The chemistry objective focuses upon the study of chemical reactions that are on-going on Europa, particularly looking for reduction-oxidation reactions.

- *Chemistry Investigation 1:* The anticipated organic and inorganic chemistry in the ocean is of interest. This investigation will greatly inform the search for life and thus may be completed in conjunction with the biological investigations.
- *Chemistry Investigation 2:* The second investigation is to examine the chemistry near the ocean floor [82]. In particular, this investigation should look for indications of communication with the interior of Europa. This communication is a potential source of the reductants required for life. Therefore, the primary goal of this investigation is to look for the interaction between the chemistry near the ocean floor and the geological processes on Europa [79].
- *Chemistry Investigation 3:* The final chemistry investigation is a classification of the surface chemistry. The effect of radiation on surface composition, sputtering, albedo, and reduction-oxidation chemistry should be investigated. The production of oxidants near the surface due to radiation is important because it helps to provide the chemical disequilibrium necessary for life [79]. This investigation would determine how the production of oxidants occurs, if they are produced at all.

4.7 Surface Geology

The surface of Europa exhibits many interesting features to be studied as follows.

- *Surface Geology Investigation 1:* The first investigation is to study tectonic, potential magmatic, and impact features on the surface. The surface appears to be made of plates that resemble the tectonic plates of Earth. Furthermore, there are numerous craters that can inform the understanding of the properties of the ice [83].
- *Surface Geology Investigation 2:* The related investigation is to search for areas of recent or current activity [78].
- *Surface Geology Investigation 3:* In addition to investigating the mechanics, origin, and age of surface features, understanding the heat flux near the surface is important for understanding the evolution of Europa. The heat flux through the ice will provide the first direct indications on whether there are active geological processes at the ocean floor [84]. This heat flux will be evaluated locally, to give a local context, and globally, to understand the general conditions on Europa.
- *Surface Geology Investigation 4:* Related to surface geology investigation 2, the surface unit shall assess the relative age of surface features. The age of surface features is related to the

age of the crust in general. Thus, the age of surface features informs man’s understanding of the rate of communication between the surface and ocean [73].

- *Surface Geology Investigation 5*: Lastly, the nature of regolith on the surface will be investigated [78]. In particular, the composition of the regolith and the mechanics of its deposition and erosion will be investigated.

4.8 Science Traceability Matrix

These scientific objectives and specific investigations are listed in a science traceability matrix. The purpose of the science traceability matrix is to show the overall goal of the mission, how it can be broken down into objectives, how these objectives are accomplished by specific investigations, and what vehicle(s) are capable of completing the investigation. Additionally, it shows how well a particular mission architecture will complete the investigation on a scale of zero to five. A score of zero indicates that a mission architecture cannot complete an investigation. A score of one indicates that a mission architecture touches on an investigation. A score of two indicates that a mission architecture *may* complete a partial investigation, while a score of three indicates a mission architecture *will definitely* complete a partial investigation. Similarly, a score of four indicates that a mission architecture *may* complete a full investigation, while a score of five indicates a mission architecture *will definitely* complete a full investigation. These scores, along with a color-coding system, are shown in Table 4.1.

Table 4.1: Description of scores used for evaluating the ability of a given mission architecture to complete an investigation.

Score	Description
0	Not Addressed
1	Touches on scientific investigation
2	May be addressed by partial investigation
3	Definitely addressed by partial investigation
4	May address full investigation
5	Definitely addressed in full investigation

The science traceability matrix was generated for 5 potential mission architectures. The five mission architectures are summarized in Table 4.2 and described in detail in Section 8.1. Applying scores per the legend provided in Table 4.1 to the scientific capabilities of the five mission architectures found in Table 4.2 yields the science traceability matrix shown in Table 4.3.

The key conclusion from the science traceability matrix is that the mission architectures best suited for accomplishing all science objectives require the use of multiple surface units, cryobots, and hydrobots, e.g. mission architectures 4 or 5. The details of this evaluation are found in Appendix B.

Table 4.2: Proposed mission architectures of a mission to explore Europa. The number of each subsystem is included. The subsystems are Surface Units (SU), Cryobots (C), and Hydrobots (H). A brief description of architecture is included. The contents of this table are discussed in further detail in Section 8.1

ID	No. of Subsystems			Description
	SU	C	H	
1	1	1	0	A single surface unit is left on the surface, it deploys a single cryobot that penetrates the ice. The cryobot embeds either itself or a tether in the bottom of the ice. The cryobot then starts taking measurements. It may deploy small probes that sink to the bottom and return measurements, but cannot control their descent. This architecture does not include a hydrobot
2	1	1	1	A single surface unit deploys a single cryobot. This cryobot penetrates the ice and deploys a single hydrobot into the ocean. This hydrobot uses the natural profiling motion of an underwater glider to profile the ocean.
3	1	1	3	A single surface unit deploys a single cryobot. This cryobot penetrates the ice and deploys three hydrobots. These hydrobots may have specialized sensor packages (e.g. for exploring the ocean floor). This architecture may utilize a tethered bottom station.
4	3	3	9	Three surface units deploy three cryobots. Each cryobot penetrates the ice and deploys three, possibly specialized, hydrobots. This architecture may utilize a tethered bottom station.
5	4	4	16	Four surface units land and each deploys a single cryobot, for a total of four. Each cryobot penetrates the ice and deploys 4, possibly specialize, hydrobots. This architecture may utilize a tethered bottom station.

Table 4.3: Science traceability matrix: the scores and corresponding coloring are defined in Table 4.1. Mission architectures are summarized in Figure 4.2.

Goal	Objective	Investigation	Primary Vehicle	Mission Architectures				
				1	2	3	4	5
Study the environment on Europa, looking for signs of life.	Biology	Determine if the European environment is conducive to life.	Surface Unit, Cryobot, Hydrobot	2	3	4	5	5
		Look for favorable distributions of carbon, hydrogen, oxygen, nitrogen, sulfur, and phosphates	Cryobot, Hydrobot	1	2	3	5	5
		Categorize the nature of life. This is a broad classification and essentially looks for how life, if it exists, gets the energy required to live	Cryobot, Hydrobot	1	2	3	5	5
		Determine the biological processes, this is a refinement of the previous objective. This looks at the details of the biological processes	Hydrobot	0	1	2	4	5
		Locate organisms. This objective, unlike the previous objectives, cannot be accomplished remotely.	Hydrobot	0	1	2	4	5
	Ocean Mechanics	Measure the water composition and basic properties at various depths. Measurements include salinity, pH, and trace elements.	Hydrobot	1	3	3	5	5
		Acquire additional data regarding tidal flexing of Europa, specifically investigate the amplitude and phase of gravitational tides, induction response from the ocean, surface motion.	Surface Unit, Cryobot, Hydrobot	1	3	3	5	5
		Further investigate the moon's dynamical rotation state	Surface Unit, Cryobot, Hydrobot	2	2	2	5	5
	Ocean/Ice Interface	Investigate the material exchange between the ocean and ice	Cryobot	3	3	3	5	5
		Describe the interface region. Important measurements include the temperature and density of the interface. Also will create a qualitative description of the interface.	Cryobot	3	3	3	5	5
	Ice	Measure the composition of the ice. Measurements include salinity, trace elements, and pH.	Surface Unit, Cryobot	3	3	3	4	5
		Determine the mineralogy of the regolith in the ice, if present	Surface Unit, Cryobot	3	3	3	4	5
		Observe the convection occurring in the ice. Describe the nature of the convecting sublayer, including rate and temperature profile	Cryobot	2	2	2	5	5
		Characterize the porosity of the ice, which has major effects on the drilling and the theoretical mechanics of the ice.	Surface Unit, Cryobot	3	3	3	5	5
		Determine the temperature profile of the ice	Cryobot	3	3	3	5	5
	Ocean Floor	Determine the thickness of the ice. This will look at both the local thickness and the thickness distribution.	Surface Unit, Cryobot	3	3	3	4	5
		Study bathymetry. Map sections of the ocean floor. This gives a general idea of the past and on-going geological processes	Hydrobot	0	1	2	4	5
		Locate specific on-going geological processes (e.g. hydrothermal vents). This will inform the search for life as organisms will likely be near these features.	Hydrobot	0	1	1	4	5
		Determine the distribution of features to give a better context of the on-going processes	Hydrobot	0	1	2	4	5
	Chemistry	Study the composition and mineralogy of the ocean floor	Hydrobot	0	1	2	5	5
		Characterize organic and inorganic chemistry in the ocean, specifically looking for indications of an environment conducive to life	Cryobot, Hydrobot	1	3	3	5	5
		Investigate the relationship between composition and geological processes, particularly looking for communication with the interior	Cryobot, Hydrobot	1	2	3	4	5
	Surface Geology	Further investigate the effects of radiation on the surface composition, sputtering, albedo, and redox chemistry. In particular, look for the production of oxidants that may be transported to the ocean	Surface Unit	3	3	3	4	5
		Study "tectonic", magmatic, and impact features	Surface Unit	2	2	2	5	5
		Search for areas of recent or current activity	Surface Unit	2	2	2	4	5
		Investigate heat flow on both a local and global scale	Surface Unit	2	2	2	4	5
Assess the relative age of surface features		Surface Unit	2	2	2	5	5	
Investigate regolith, looking for its compositing and processes of deposition and erosion		Surface Unit	2	2	2	4	5	

Chapter 5

Value System Design

In order to effectively evaluate the chosen design, the team needs to design a value system that can be used to objectively choose the best design. To accomplish this, the team utilized the Analytical Hierarchy Process (AHP) [85].

5.1 The Analytical Hierarchy Process

AHP takes in several competing design goals, and produces weighting factors for each of the goals. It is useful because it allows the use of pairwise comparisons to produce weights on multiple goals. In general, people have difficulty comparing more than two goals. AHP only requires comparing two goals at a time, and these pairwise comparisons are used to assemble weighting factors for the complete set of goals.

5.1.1 Example of AHP to a Basic System

When evaluating a design process, the goals are typically stated as design objectives. As a generalized example, one may begin with *Goal A*, *Goal B*, *Goal C*, and *Goal D*. The goals are assembled into a table, shown in Table 5.1. The importance of each goal is compared to each other goal individually. The relative importance is then given a score. A score greater than one indicates that a goal is more important than the one to which it is being compared, and a score less than 1 indicates it is less important. Table 5.1 uses the variable a_{ij} to represent this score, where i represents the row and j represents the column. a_{ij} is representative of how much more important the goal in row i is than the goal in column j . The scores are described in terms of relative importance. A score of 9 indicates that one goal is absolutely more important than the other, a score of 7 indicates that one goal is very strongly more important than the other, a score of 5 indicates that one goal is strongly more important than the other, and a score of 3 indicates that one goal is slightly more important than the other. Conversely, a score of $1/9$ indicates that one goal is absolutely less important than the other, a score of $1/7$ indicates that one goal is very strongly less important than the other, a score of $1/5$ indicates that one goal is strongly less important than the other, and a score

Table 5.1: Table used in AHP

	Goal A	Goal B	Goal C	Goal D
Goal A	a_{11}	a_{12}	a_{13}	a_{14}
Goal B	a_{21}	a_{22}	a_{23}	a_{24}
Goal C	a_{31}	a_{32}	a_{33}	a_{34}
Goal D	a_{41}	a_{42}	a_{43}	a_{44}

of 1/3 indicates that one goal is slightly less important than the other. A score of 1 denotes equal importance. These values are chosen because they are roughly equally divided, but only 3 and 9 (or 1/3 or 1/9) are multiples of each other. There are also only a few values, thus making it easier to make a distinction between two criteria. Table 5.2 shows a table made with arbitrary values. These values will be used to calculate weights for each of the goals.

Table 5.2: Table used in AHP with arbitrary values

	Goal A	Goal B	Goal C	Goal D
Goal A	1	1/3	5	1/9
Goal B	3	1	1/7	5
Goal C	1/5	7	1	1/5
Goal D	9	1/5	5	1

With scores assigned to the relative importance of each of the goals, one may generate weights for the goals. The typical next step is that one normalizes each column in the table such that the sum of each column is unity. This is done by dividing each element of Table 5.2 by the sum of the column it is in. This yields Table 5.3, which shows all of the values normalized (and rounded to two decimal points). The weight, that is, the importance of each of goals is then found by summing

Table 5.3: Normalized table used in AHP with arbitrary values

	Goal A	Goal B	Goal C	Goal D
Goal A	0.08	0.04	0.45	0.02
Goal B	0.23	0.12	0.01	0.79
Goal C	0.02	0.82	0.09	0.03
Goal D	0.68	0.02	0.45	0.16

each corresponding row. Weights for this example case are found in Table 5.4. It should be noted that the sum of these weights is the number of goals (4 in this case). Typically, the weights are then re-normalized so their sum is 10. This is shown in Table 5.5 An important caveat is that, when comparing disparate goals, it is important to non-dimensionalize the goals. Typically this is done by phrasing the goal in a form that can be evaluated on a score out of ten in order to compare goals with disparate numerical values (e.g. the range of an airplane in miles and its endurance in hours).

Table 5.4: Weights produced from AHP

Goal	Weight
A	0.58
B	1.15
C	0.96
D	1.31

Table 5.5: Normalized weights produced from AHP

Goal	Weight
A	1.45
B	2.87
C	2.39
D	3.28

5.2 System Description

In order to efficiently evaluate the relative importance of the design criteria, the performance of each of the subsystems is divided into subcategories. For example, the design criteria of the hydrobot is divided into performance, which deals with the movement and physical performance of the hydrobot, science, which concerns the quality and quantity of scientific measurements, and communication, the ability of the hydrobot to transmit its data back to Earth. These categories are also used for the cryobot and the surface Unit. Since the landing system does not have any science or communication objectives, only its performance is considered. By comparing these categories to each other, AHP is used to calculate their relative importance which will later be used to determine the importance of each individual design criteria.

It is now necessary to describe the relative importance of the objective categories. It should be noted that there are values of one along the diagonal of Table 5.6 because each objective is as important as itself. Additionally, the communication for each system only concerns the communication of a particular component to Earth. Thus, if a design is chosen that requires the hydrobot to use the cryobot and surface units as links in a communication chain, the hydrobot communication will include the communication between these links.

Each of these criteria were compared using AHP. Justifications of the relative scoring is provided in Appendix C. All of the information in Appendix C has been converted into a table, which is shown in Table 5.6. Using AHP, this information is converted into weights for the design criteria categories, which are presented in Table 5.7. From this table one can see that the most important objectives are the communication and science objectives, as well as the performance of the landing system. Interestingly, although the performance of the various components is important, these weights show that the science is more important. The next step is to compare the individual criteria for each vehicle.

Table 5.6: Pairwise comparison of the design criteria categories. The vehicles are abbreviated as Hydrobot (H), Cryobot (C), Surface Unit (S), and Landing System (L) and categories are abbreviated as Performance (P), Science (S), and Communication (C), so, for example Surface Unit Science is SS and Hydrobot Performance is HP.

	HP	HS	HC	CP	CS	CC	SP	SS	SC	LP
HP	1	1/5	1/5	5	1/3	1/5	5	5	1/3	1/5
HS	5	1	1/5	5	3	1/3	7	7	1/3	1
HC	5	5	1	7	3	3	7	7	5	3
CP	1/5	1/5	1/7	1	1/3	5	5	7	1/3	1/5
CS	3	1/3	1/3	3	1	1	7	5	3	1/3
CC	5	3	1/3	1/5	1	1	5	5	3	1
SP	1/5	1/7	1/7	1/5	1/7	1/5	1	5	1/3	1/7
SS	1/5	1/7	1/7	1/7	1/5	1/5	1/5	1	1/5	1/7
SC	3	3	1/5	3	1/3	1/3	3	5	1	1
LP	5	1	1/3	5	3	1	7	7	1	1

Table 5.7: Design criteria category weights

Category	Weight (Out of 10)
Hydrobot Performance	0.58
Hydrobot Science	1.18
Hydrobot Communication	2.59
Cryobot Performance	0.82
Cryobot Science	1.00
Cryobot Communication	1.20
Surface Unit Performance	0.25
Surface Unit Science	0.16
Surface Unit Communication	0.89
Landing System Performance	1.33

5.3 Design Criteria

Designing the value system is one of the most important elements of the design process. To develop the value system, one must first define the evaluation criteria for the mission. There are four subsystems considered in the design tree: the hydrobot, cryobot, surface unit, and landing system. For these subsystem one then considers design categories of performance, science, and communication. It should be noted that these divisions are not made to presuppose any solution. These divisions do not imply separate vehicles. For example, the landing system and surface units can be the same vehicle, despite the existence of separate sets of criteria. Similarly, a single vehicle may serve two distinct roles. If the design of the value system determines that it is better to not have a dedicated cryobot that embeds itself in the ice, it is not necessary to have one. These criteria are displayed in decision criteria trees. The criteria either have to be maximized or minimized, and this is denoted by the shape of the box surrounding each criteria per the legend is shown in Figure 5.1.

Decision trees show individual criteria and how they are organized into their categories. AHP is



Figure 5.1: Legend for design criteria trees shown in Figures 5.2, 5.3, 5.4, and 5.5.

then used to evaluate the individual design criteria with respect to the others within their respective categories. The design criteria of the Hydrobot are shown in Figure 5.2, the Cryobot's in Figure 5.3, the Surface Unit in Figure 5.4, and the Landing System in Figure 5.5.

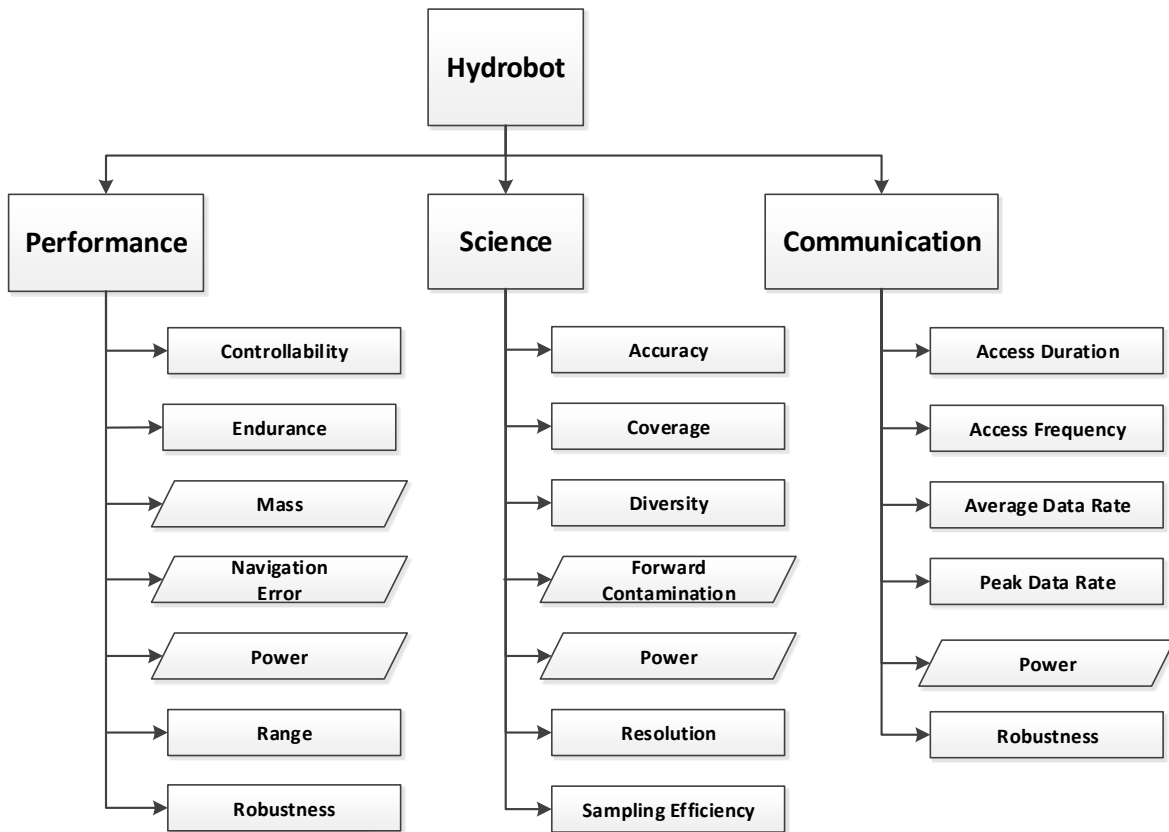

Figure 5.2: Design criteria tree for the hydrobot. The legend is shown in Figure 5.1.

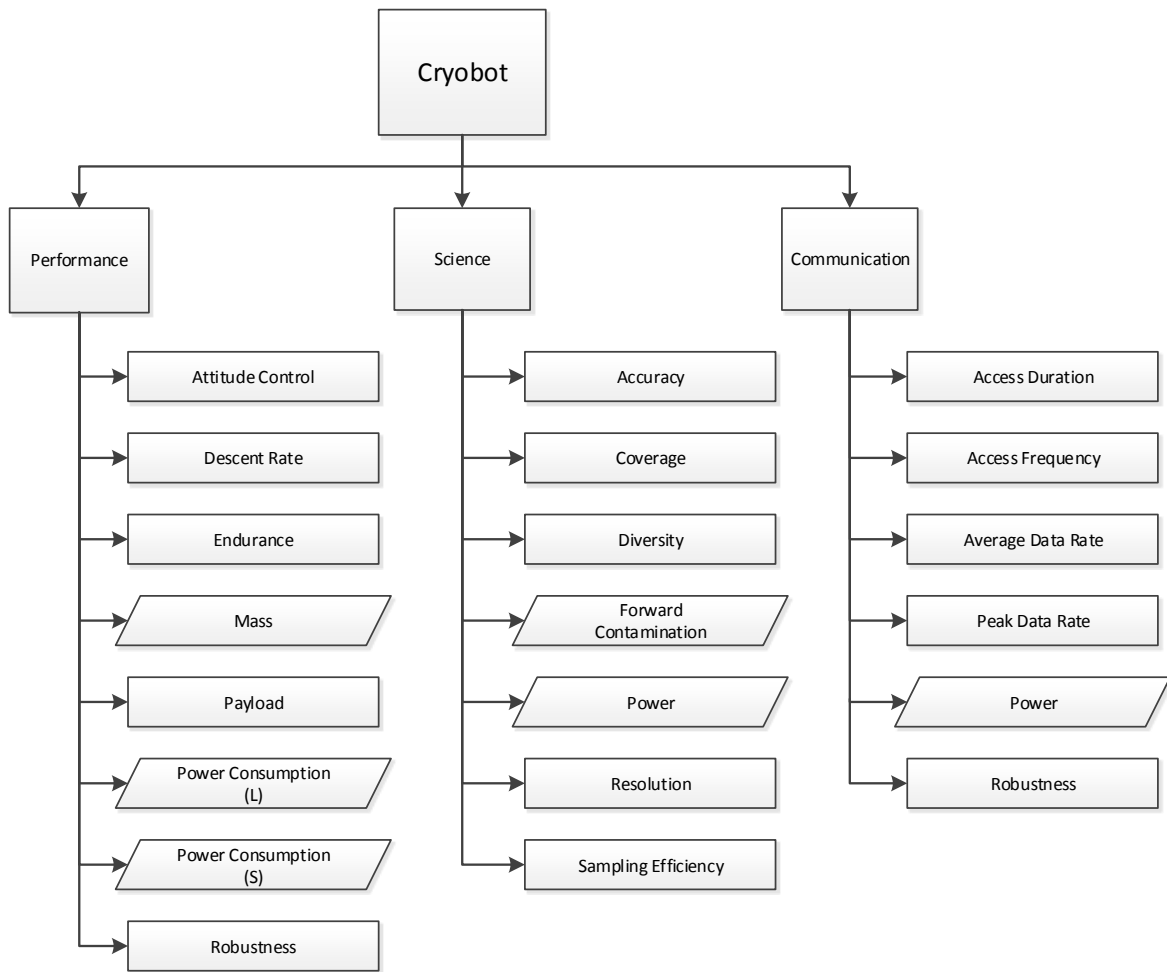

Figure 5.3: Design criteria tree for the cryobot. The legend is shown in Figure 5.1.

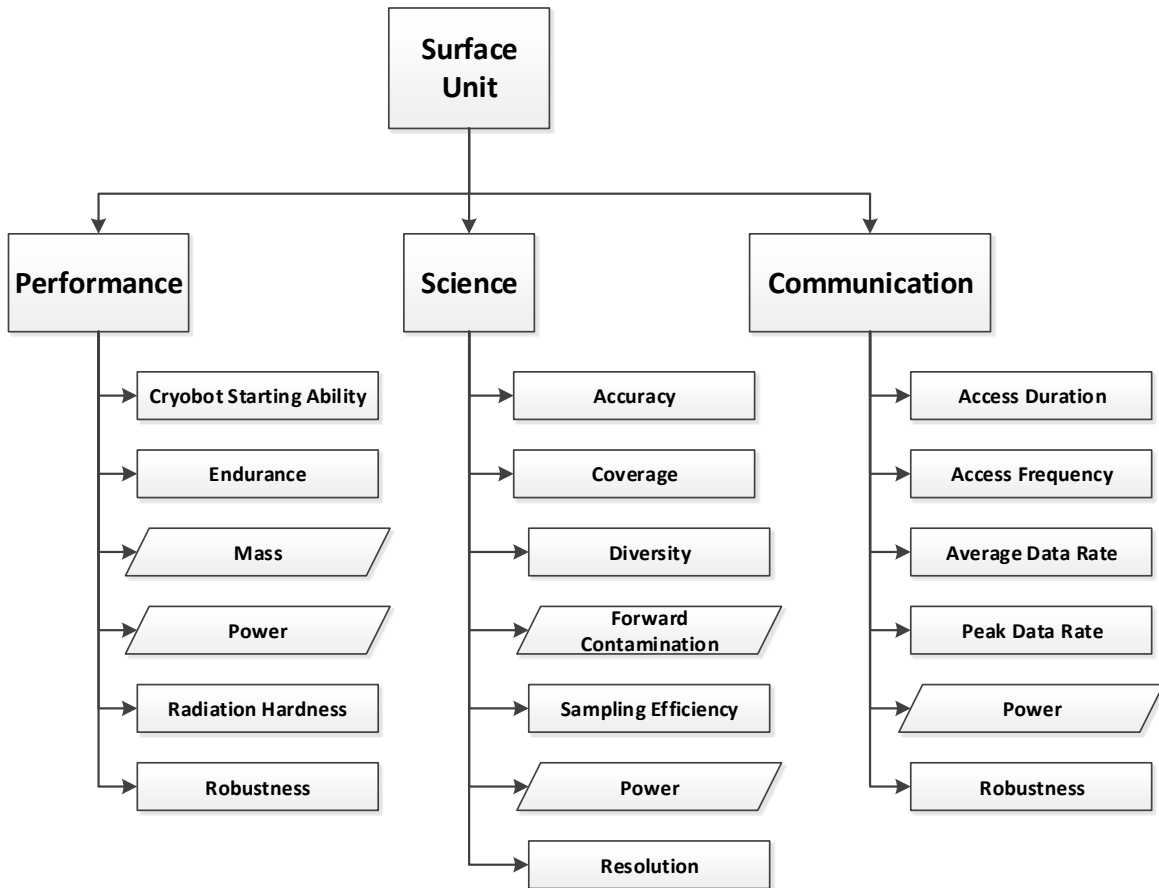

Figure 5.4: Design criteria tree for the surface unit. The legend is shown in Figure 5.1.

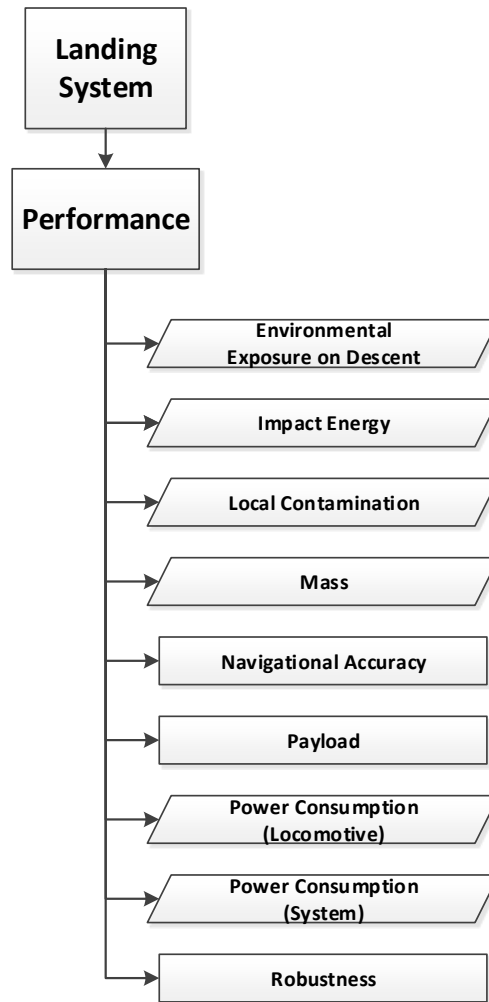

Figure 5.5: Design criteria tree for the landing system. The legend is shown in Figure 5.1.

5.3.1 Hydrobot Performance

There are seven design criteria grouped within Hydrobot Performance. These are controllability, endurance, mass, navigation error, power, range, and robustness. The ability of the hydrobot to travel a desired path in a controllable manner is referred to as controllability. The endurance, the time the hydrobot can travel is to be considered. Mass is the mass of the hydrobot. The accumulated error in the hydrobot's knowledge of its location is referred to as navigation error. Power is the power necessary for motion and other vehicle systems, excluding scientific instruments and communication equipment. Range, the distance the hydrobot can travel shall be considered. Lastly, the ability of the hydrobot to survive damage and system failures is robustness.

5.3.2 Hydrobot Science

The hydrobot science category has seven design criteria: accuracy, coverage, diversity, forward contamination, power, resolution, and sampling efficiency. The accuracy is how closely the measurements reflect reality. Coverage is defined to be the area in which scientific data is collected. In the case of the hydrobot, the underwater vehicle will have options to explore various depths as well as different lateral regions. In this case, coverage will be three dimensional regions. The diversity of data will look at the different types of measurements that are to be taken. The forward contamination criteria seeks to minimize contamination to the hydrobot's environment as a consequence of the exploration and measurement processes. Forward contamination to the environment may lead to invalid scientific readings and/or environmental disasters. If the hydrobot leaks a substance and later detects that substance, there will be no way to know if the substance was native to Europa. The hypothetical substance may also be deadly to any organisms the hydrobot finds. The next criteria is the reduction of power consumption of the scientific instruments. Temporal and spatial resolution will be considered. Lastly, the criteria of sampling efficiency is important for conserving resources.

5.3.3 Hydrobot Communication

The hydrobot communication system has six design criteria including access duration, access frequency, average data rate, peak data rate, power, and robustness. Note that a chain of communication between the different mission systems: hydrobot, cryobot, and surface unit, is not presumed. If direct communication between the hydrobot and Earth somehow works the best, then that method will be chosen. The access duration is a measure of how long periods of contact last. The access frequency is how often data can be transferred from the hydrobot to Earth. The average data rate is measured over a relatively long duration. The peak data rate is the maximum data transfer rate from the hydrobot to Earth in ideal conditions, measured instantaneously. For example, peak data rate could be measured in units of megabytes per second, while average data rate could be measured in units of gigabytes per day. Like all other systems, it is important to consider the amount of power required for the communication system and the robustness of the system.

5.3.4 Cryobot Performance

There are eight design criteria that define the cryobot's performance. These are attitude control, descent rate, endurance, mass, payload capacity, locomotive and system power consumption, and robustness. The attitude control is the ability of the cryobot maintain its orientation during its descent through the ice. Descent rate is a specific measure of the rate at which the cryobot penetrates the ice. The endurance is the length of time the cryobot can survive on Europa. Mass is the mass of the cryobot. The payload capacity of the cryobot is payload available for carrying equipment, primarily hydrobots. This criteria includes both volumetric and mass capacity. The melt power consumption for locomotion is the amount of power the cryobot uses to descend through the ice. The power consumption for the cryobot systems is the power requirements for all non-melt systems excluding scientific instruments and communication. The robustness of the cryobot is the

ability of the cryobot to complete its mission despite damage and failures.

5.3.5 Cryobot Science

There are seven design criteria concerning the cryobot science criteria: accuracy, coverage, diversity, forward contamination, power, resolution, and sampling efficiency. The accuracy is how closely the measurements reflect reality. Coverage is the area over which scientific data is collected. For the cryobot, it will have, by definition, full depth coverage of the ice. Thus the design consideration for coverage is the lateral coverage. Diversity of data refers to how many different types of measurements are to be taken. Forward contamination is the design consideration that concerns whether the cryobot will contaminate the environment creating false readings and potentially damaging the environment. For example, if the cryobot leaks a petroleum-based lubricant and then detects the presence of petroleum-like compounds, it will be unknown if this an important scientific discovery, or a case of interplanetary littering. The next criteria is to reduce the power consumption of the scientific instruments. Another important consideration is the resolution of the scientific measurements. This includes both temporal and spatial resolution. It is important to conserve resources, so the cryobot must collect scientific data efficiently.

5.3.6 Cryobot Communication

There are six design criteria for the cryobot communication system. These are very general criteria and can be applied to describe any communication system. That being said, there are specific design challenges for the cryobot. The six criteria are access duration, access frequency, average data rate, peak data rate, power, and robustness. Access duration refers to how long periods of contact last, whereas access frequency is how often data can be transferred from the cryobot to Earth. Average data rate is a long term measure of data transfer whereas peak data rate is the maximum rate of data transfer from the cryobot to Earth in ideal conditions. It is important to consider the amount of power required for the communication system. Lastly, it is important to consider how robust the communication chain from the cryobot to Earth is in the presence of off-nominal conditions and/or damage.

5.3.7 Surface Unit Performance

There are six performance criteria for the surface unit: cryobot starting ability, endurance, mass, power, radiation hardness, and robustness. Cryobot starting ability is a measure of the surface unit's ability to lift, and deploy the cryobot beginning its journey through the ice. Endurance is the length of time the surface unit can survive on Europa. Mass is the mass of the entire surface unit. Power is a measure of power required for the mission to be successfully completed, including that needed to lift the cryobot. Radiation hardness is the ability of the surface unit to function in the hazardous radiation environment in the Jovian system. This includes both the ability of the components to survive in a high-radiation environment and the shielding techniques employed. The robustness is the ability of the surface unit to sustain damage and still complete its mission.

5.3.8 Surface Unit Science

The science design criteria of the surface unit are the same as for both the cryobot and hydrobot, namely, access duration, access frequency, average data rate, peak data rate, power, and robustness. However, the importance of each criteria varies based on the specific nature of the subsystem; e.g. surface unit priorities differ from hydrobot priorities. It is important to note that the surface unit is highly limited in its range. While the science conducted by the surface unit is very important, much of the science overlaps with the capabilities of an orbiter or fly-by, so this mission focuses on the science conducted by the cryobots and hydrobots [86].

5.3.9 Surface Unit Communication

The surface unit communication criteria describe the data transfer between the surface unit and Earth. This may involve communicating to relay satellites in Europa or Jupiter orbit, or communicating directly with Earth. It should be noted that the surface unit may itself be a relay for the cryobot and hydrobot, but this fact is not considered when considering the surface unit's criteria; it is included in the hydrobot's and cryobot's criteria. The actual design criteria are the same as for cryobot and hydrobot communication, access duration, access frequency, average data rate, peak data rate, power, and robustness, but the relative importance of the criteria are different.

5.3.10 Landing System Performance

The landing system is unique from the previous systems in that it does necessarily require its own structure. For example, the landing system may consist of several thrusters attached to the surface unit and controlled by computers on-board the surface unit. In this case, the surface unit and landing system are inseparable. That being said the goals of the landing system and surface unit are not mutually inclusive; therefore, the performance criteria must be considered separately. There are nine landing system performance design criteria: environmental exposure on descent, impact energy, local contamination, mass, navigational accuracy, payload, power consumption (locomotive), power consumption (system), and robustness. Environmental exposure on descent is related to the effect that Europa and the Jovian system has on the spacecraft during descent. That is, it is the protection of surface unit, cryobot, and hydrobot(s) during descent from radiation, debris, and other hazards during descent. Impact energy is the measure of how hard the system impacts the surface of Europa. Since the fuel used for the descent might cause contamination of the surface which might interfere scientific measurements, one design consideration is limiting the local contamination. The term 'local contamination' is used here to differentiate from forward contamination and refers specifically to contamination due to propellant or fuels from the landing system being spread onto the surface of Europa. Mass refers to the total mass of the complete landing system. The navigational accuracy is how accurately the landing system can deliver its payload to its desired location. The payload is the maximum amount of equipment that the landing system can safely deliver to the European surface. The power consumption for locomotion is the electrical power required for the the slowing the descent. The power consumption of the system is the power required for all non-locomotive systems, e.g. radar range finders. Robustness is the

ability of the landing system to safely land components on the European surface despite damage, failures, or off-nominal conditions.

5.4 Complete Value System

All of the previous design criteria were compared using the methodology of the AHP. For brevity, this is included in Appendix C. The AHP is then used to calculate weights for the importance of each criteria. This is shown in Tables 5.8 and 5.9. These tables are color-coded by system to illustrate the important of each system. The hydrobot, cryobot, surface unit, and landing system are shown in yellow, blue, green, and red, respectively. Table 5.8, which represents the most important design criteria, is dominated by hydrobot science and communication categories. This is an expected result because collection of under-ice data is the goal of the mission, and collecting this data is not useful if it cannot be communicated Earth-ward. Similarly, for any scientific mission there are three main goals: getting to the destination safely, collecting data, and returning the data to Earth. For this VSD, these correspond to the categories of communication and science, as well as landing system performance. Thus, as expected, these categories make up approximately 80% of the categories in Table 5.8. Conversely, performance is less critical as time and patience can be used to enable collection of the scientific data which constitutes the primary goal. These results appear in Table 5.9. Most of the criteria in Table 5.9 are performance criteria. Thus, the performance of the systems are less important than actually collecting the data. Furthermore, most of the surface unit's criteria are contained in Table 5.9. This means that the surface unit, apart from communicating its data back to Earth and starting the descent of the cryobot, is less important than the other subsystems.

Table 5.8: Complete value system design calculated using AHP. Continued in Table 5.9.

Subsystem	Category	Category		Criteria	Criteria	
		Weight	Weight		Weight	Final Score
Hydrobot	Communication	2.59		Power	3.98	10.29
Hydrobot	Communication	2.59		Robustness	2.14	5.54
Hydrobot	Communication	2.59		Average Data Rate	1.64	4.25
Cryobot	Communication	1.20		Robustness	3.29	3.96
Landing System	Performance	1.33		Impact Energy	2.30	3.06
Hydrobot	Communication	2.59		Access Duration	1.15	2.98
Cryobot	Science	1.00		Sampling Efficiency	2.79	2.78
Surface Unit	Communication	0.89		Robustness	3.02	2.70
Cryobot	Communication	1.20		Power	2.16	2.61
Landing System	Performance	1.33		Local Contamination	1.96	2.60
Hydrobot	Science	1.18		Sampling Efficiency	2.19	2.59
Hydrobot	Science	1.18		Diversity	2.17	2.57
Cryobot	Performance	0.82		Power Consumption (L)	3.01	2.47
Cryobot	Science	1.00		Forward Contamination	2.39	2.38
Cryobot	Communication	1.20		Average Data Rate	1.97	2.37
Landing System	Performance	1.33		Payload	1.74	2.31
Landing System	Performance	1.33		Navigational Accuracy	1.65	2.20
Hydrobot	Performance	0.58		Navigation Error	3.69	2.12
Hydrobot	Science	1.18		Forward Contamination	1.67	1.97
Hydrobot	Communication	2.59		Access Frequency	0.75	1.94
Cryobot	Science	1.00		Resolution	1.95	1.94
Hydrobot	Science	1.18		Resolution	1.62	1.91
Cryobot	Communication	1.20		Access Duration	1.43	1.72
Surface Unit	Communication	0.89		Power	1.81	1.62
Surface Unit	Communication	0.89		Access Duration	1.67	1.49
Surface Unit	Communication	0.89		Average Data Rate	1.64	1.47
Cryobot	Performance	0.82		Power Consumption (S)	1.74	1.43
Cryobot	Performance	0.82		Robustness	1.72	1.42
Surface Unit	Communication	0.89		Access Frequency	1.47	1.31
Hydrobot	Science	1.18		Coverage	1.10	1.30
Cryobot	Science	1.00		Power	1.16	1.15
Hydrobot	Performance	0.58		Range	1.96	1.13
Cryobot	Science	1.00		Accuracy	1.05	1.05
Surface Unit	Performance	0.25		Cryobot Starting Ability	4.12	1.05
Landing System	Performance	1.33		Robustness	0.79	1.04

Table 5.9: Continuation of the complete value system design calculated using AHP. Continued from Table 5.8.

Subsystem	Category	Category	Criteria	Criteria	Final Score
		Weight		Weight	
Cryobot	Performance	0.82	Endurance	1.24	1.02
Hydrobot	Science	1.18	Power	0.80	0.94
Cryobot	Communication	1.20	Access Frequency	0.77	0.93
Landing System	Performance	1.33	Mass	0.68	0.90
Hydrobot	Communication	2.59	Peak Data Rate	0.34	0.89
Cryobot	Performance	0.82	Payload	1.05	0.87
Hydrobot	Performance	0.58	Endurance	1.13	0.65
Hydrobot	Performance	0.58	Robustness	1.06	0.61
Cryobot	Performance	0.82	Mass	0.74	0.61
Surface Unit	Science	0.16	Forward Contamination	3.78	0.59
Surface Unit	Performance	0.25	Radiation Hardness	2.25	0.57
Hydrobot	Performance	0.58	Power	0.95	0.55
Hydrobot	Science	1.18	Accuracy	0.46	0.54
Cryobot	Communication	1.20	Peak Data Rate	0.38	0.45
Surface Unit	Performance	0.25	Robustness	1.77	0.45
Hydrobot	Performance	0.58	Controllability	0.78	0.45
Landing System	Performance	1.33	Environmental Exposure on Descent	0.32	0.42
Landing System	Performance	1.33	Power Consumption (L)	0.32	0.42
Surface Unit	Communication	0.89	Peak Data Rate	0.39	0.35
Surface Unit	Science	0.16	Power	2.19	0.34
Cryobot	Science	1.00	Coverage	0.34	0.34
Landing System	Performance	1.33	Power Consumption (S)	0.25	0.33
Cryobot	Science	1.00	Diversity	0.32	0.32
Hydrobot	Performance	0.58	Mass	0.43	0.25
Cryobot	Performance	0.82	Attitude Control	0.28	0.23
Surface Unit	Science	0.16	Accuracy	1.40	0.22
Surface Unit	Performance	0.25	Power	0.86	0.22
Cryobot	Performance	0.82	Descent Rate	0.20	0.17
Surface Unit	Performance	0.25	Mass	0.64	0.16
Surface Unit	Science	0.16	Sampling Efficiency	1.01	0.16
Surface Unit	Science	0.16	Coverage	0.78	0.12
Surface Unit	Performance	0.25	Endurance	0.35	0.09
Surface Unit	Science	0.16	Diversity	0.53	0.08
Surface Unit	Science	0.16	Resolution	0.31	0.05

Chapter 6

Current State-of-the-Art Technologies and Development

6.1 Underwater Gliders

The exploration of Europa's interior ocean requires a highly advanced autonomous underwater vehicle (AUV) that can maximize the quantity and quality of useful scientific data. As a relatively new innovation, the underwater glider has enjoyed considerable attention recently due to its extreme range (ocean basin scales), extreme endurance (months to years, without recharging), and natural "depth profiling" motion within the water column. An underwater glider concept was selected as the mission's ocean profiling technology because of its demonstrated efficiency, robustness, and reliability.

6.1.1 Principles of Operation

The locomotion mechanism of an underwater glider is similar to that of a sailplane. As a conventional gliding aircraft descends under the force of gravity, the airflow over its fixed wing generates lift. Most of the lift vector acts in the vertical direction, counteracting the force of gravity, but a portion acts in the horizontal direction, sustaining forward flight; see Figure 6.1. An underwater glider works by the same principle, except that it can reverse the process and glide *upward* by increasing its buoyancy. A buoyancy engine modulates the glider's buoyancy within a narrow range, alternately causing the vehicle to sink or rise. The glider adjusts its pitch attitude as it rises or falls in order to sustain gliding flight, resulting in a saw-tooth motion through the water column. These saw-tooth profiles are especially useful to ocean scientists who study how oceanographic properties vary with depth.

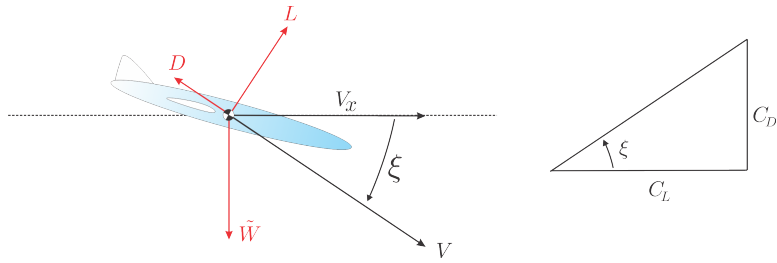

Figure 6.1: Free body diagram for wings-level gliding flight [3].

Variable Buoyancy

The role of glider’s buoyancy engine is to change the vehicle’s density relative to the surrounding fluid. When the vehicle is more dense than the surrounding fluid, it will sink; when it is less dense, it will rise. The typical approach involves pumping a working fluid, such as oil, between an internal reservoir and an external bladder, with check-valves to prevent back flow when the pump ceases. To descend, the external bladder is emptied, the vehicle’s displaced volume (and buoyant force) decreases, and the glider begins to sink. After adjusting its attitude appropriately, the vehicle will execute a slow descending glide before reinflating the bladder and ascending. For a deep water glider, the descent and ascent takes several hours and the glider travels several kilometers horizontally. The cost of propulsion relates to the cost of inflating the bladder against the ambient, hydrostatic pressure and the vehicle’s hydrodynamic efficiency [87].

Underwater gliders are an engineering adaptation of profiling floats, which also use buoyancy engines to modulate their depth but which drift with the ocean currents. Profiling floats are used in measuring depth profiles of certain ocean parameters such as temperature and conductivity. One example of a float used in oceanography is the Profiling Autonomous Lagrangian Circulation Explorer (PALACE) [88]. Buoyancy driven engines can also be designed to harness environmental energy. The Sounding Oceanographic Lagrangian Observer Thermal RECharging (SOLO-TREC) vehicle is a profiling float that harnesses energy from thermal gradients in the ocean [89]. The *Slocum* “thermal” underwater glider also uses this energy harvesting concept for enhanced efficiency in deep water applications.

Variable Center of Mass

Attitude control is required to convert vertical motion, caused by the buoyancy engine, into horizontal motion. An underwater glider’s attitude is controlled by using one or more internally housed moving masses to adjust the vehicle’s center of mass relative to the center of buoyancy. Pitch attitude is controlled by moving the center of mass fore and aft along the longitudinal axis of the glider. Roll attitude is controlled by moving the center of mass port and starboard. These adjustments alter the steady flight condition over a range of speeds, descent angles, and turn rates. Deep ocean gliders have no hinged control surfaces, and hence no rudder to control yaw; underwater gliders must bank to turn and can only do so while in flight.

Internal actuators offer unique advantages in terms of robustness and reliability, but they occupy

valuable payload volume. However, internal actuation systems can be designed to minimize the impact. For example, the movable ballast could be usable payload like batteries, as in the case of the *Seaglider* [90]. Virginia Tech's Underwater Glider was designed with a cylindrical moving mass actuation scheme that leaves interior room for other system components [4].

Performance, Stability, and Control

Although underwater gliders operate on the same principles as sailplanes, the hydrodynamic parameters (such as added mass and inertia) make modeling and analysis more difficult. Characterizing steady turning flight, for example, is a challenge. Approximate analytic conditions have been found, however, that relate a glider's steady motion (speed, descent angle, and turn rate) to its geometric and inertial configuration [91]. The analysis also suggested methods for planning and executing energy efficient underwater glider paths. These methods have since been extended to account for known and unknown currents [92, 93].

An ONR-sponsored underwater glider study in 2003 provided a broad overview of glider design principles and included efficiency comparisons of existing gliders with various biological gliders. The underwater glider performance and stability analysis described in [4] and in [3] provides additional insight and guidelines concerning vehicle design. In terms of performance, the analysis underscores the fact that glider speed scales with the *square root* of net displacement, placing a practical limit on a glider's attainable speed. A fifty kilogram glider with a "buoyant lung capacity" of $\pm 1\%$ will travel at speeds well below one meter per second. The average speed for current gliders is around 35 cm/s [94].

In terms of stability, the analysis in [3] shows that moving the glider wing aft along the body adds pitch damping, enhancing longitudinal stability. Similarly, the vertical stabilizer size and location affect lateral-directional stability; increasing the size and moment arm of the vertical stabilizer increases yaw stiffness and damping. Finally, because gliders bank to turn, "dihedral coupling" between the hydrodynamic roll moment and the sideslip angle is an important effect. It can be obtained by sweeping the wings aft.

6.1.2 Examples

There has been a recent proliferation of underwater gliders, but all are based closely on the original three vehicles: *Slocum*, *Seaglider*, and *Spray*. The first underwater glider, *Slocum*, comes in two variants: a battery powered version and a thermal energy harvesting version. A recent variant of the *Seaglider* called *Deepglider* was developed for operation to full ocean depth. Some notable design characteristics of each glider are included here to give a sense of the general features and capabilities.

Slocum Battery

The battery-powered version of *Slocum* was designed as a low-cost vehicle for use in shallow water, where maneuverability is more important [95]. Designed for coastal operations, the vehicle is rated to 2 MPa (or about 200 meters depth). The vehicle's hull is cylindrical with a diameter of 21 cm and a length of 150 cm. It has a hull mass of 52 kg and payload capacity of 5 kg. The glider can travel up to 45 cm/s and has a maximum mission range of 500 km and maximum mission duration of 20 days [94].

Slocum Thermal

The thermal energy-harvesting version of *Slocum* exploits the ocean's vertical temperature gradient to provide power for propulsion and payload, where possible [8]. Thermal energy harvesting is not feasible everywhere in Earth's oceans, and it may not be feasible on Europa. A preliminary orbiter mission to Europa, however, may provide the necessary information to understand temperature gradients in the under-ice ocean.

Spray

The underwater glider *Spray* is similar in design to battery-powered *Slocum*, but can dive deeper and endure longer missions. The cylindrical hull has a higher fineness ratio for lower drag [95]. The hull diameter is 20 cm and the length is 200 cm. The hull mass is 51 kg. Other notable design features include a maximum pressure of 15 MPa, a maximum speed of 45 cm/s, a range of 7000 km, and an endurance of 330 days.

Seaglider

Seaglider was designed for depth, range, and efficiency. Its rigid hull is enclosed in a fiberglass fairing designed to reduce form drag and to compress in a way that compensates for the slight compressibility of water, reducing energy losses during ascent. This latter feature reduces energy costs in proportion to the square of depth [95]. Geometric specifications for *Seaglider* include the following: a maximum diameter of 30 cm, length of 180 cm, mass of 52 kg, and payload capacity of 4 kg. The maximum pressure is 10 MPa and the maximum speed is 45 cm/s[94].

Deepglider

Deepglider is an extension of the *Seaglider* concept and shares common design characteristics, but with a dramatically greater depth capability [96]. *Deepglider* was conceived to support long duration, long range missions to full ocean depths (up to 6000 m), which would allow the glider to traverse 99% of Earth's ocean. To do so, the glider must withstand about 60 MPa. While the European ocean is believed to be much deeper than Earth's, the lower gravity suggests that the

hydrostatic pressure at full depth on Europa is commensurate with that at full depth on Earth, the pressure for which *Deepglider* was designed.

Virginia Tech Underwater Glider

Virginia Tech researchers have designed an underwater glider to test motion planning and control algorithms. Because maneuverability was the primary design consideration, the glider was designed to have a large, pneumatically powered buoyancy lung and a moving mass that provides a large, quickly attainable range of pitch and roll attitudes. The Virginia Tech underwater glider is designed for shallow water operations of up to 100 meters deep. Vehicle parameters include a body diameter of 23 cm, length of 190 cm, and a mass of 56 kg [4]. A design drawing of the Virginia Tech underwater glider is shown in Figure 6.2.

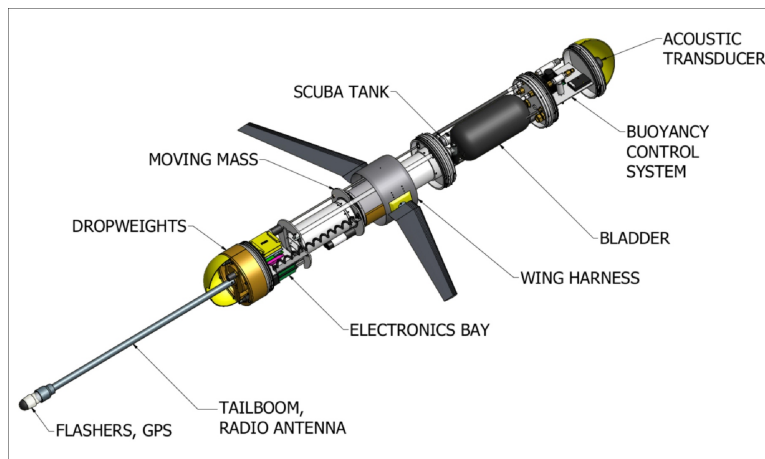

Figure 6.2: Annotated schematic of the Virginia Tech underwater glider [4].

6.1.3 Sensors

Sensors used in underwater gliders can be organized into seven categories. These are acoustic, passive magnetic, electric field, active electromagnetic, optical, chemical, and inertial. Acoustic sensors can be used to measure flow velocity (Doppler velocimetry) and as imaging devices (sonar). Passive magnetic sensors detect magnetic fields, often those associated with man-made objects such as ships or undersea mines. Underwater gliders can also use these sensors to characterize the geology underlying the seabed. Electric field sensors are not widely used by underwater gliders, but have been proposed as an alternative to acoustic sensors for detecting vessels. Active electromagnetic sensors can be used to detect metallic or conductive objects. Optical sensors are used for imaging and can be used for mapping, under the right conditions. The category of “chemical sensors” includes a wide variety of sensing devices that provide a range of scientific data. These sensors, which range from basic pH sensors to chromatographic spectrometers, would be essential when assessing whether an environment is conducive to life. Inertial sensors are essential for vehicle navigation.

6.1.4 Power Systems

Underwater gliders currently use one of types of two power supplies: batteries or thermal energy harvesting. Since underwater gliders are low-powered vehicles, batteries can provide sufficient power for long range, long endurance missions. On Earth, gliders are recovered when the power supply is depleted so that the batteries can be recharged or replaced. For a mission to Europa, a battery-powered vehicle would either have to complete its mission on a single charge or return to a docking station to recharge. Thermally powered gliders may be feasible on Europa; a future orbital mission may provide the needed information to determine whether that is the case.

6.1.5 Performance Attributes

Natural “Profiling” Motion

Underwater gliders are well-suited for exploring oceans. Since they move in a vertical, saw-tooth pattern, measurements are attained throughout the water column providing “depth profiles” that are valuable to oceanographers who build and validate mathematical models of ocean processes [88]. Depth profiles of the European ocean would be quite valuable to planetary scientists.

Efficiency

Underwater gliders are well-suited for long term missions due to their long range and endurance. Since propulsive power scales with the cube of velocity, the very low speeds at which gliders operate result in highly efficient operation. Locomotive efficiency can be considered using the concept of “net transport economy (*NTE*)” as in [87]. This dimensionless parameter measures the energy cost of travel per kilogram of net weight (or buoyancy). If P represents the power required for propulsion, \widetilde{W} represents the net weight or buoyant force, and u is the useful (horizontal) component of speed, then

$$NTE = \frac{P}{\widetilde{W}u} \quad (6.1)$$

The concept of net transport economy can be applied to man-made and natural fliers alike. According to [87], conventional underwater gliders have a higher *NTE* than transport aircraft and sailplanes, falling into the same efficiency regime as small birds and bats.

Robustness

Gliders are robust vehicles because of their low mechanical complexity. The system is completely closed, with an inflatable bladder and with internal actuators that operate in the hermetically sealed hull; no dynamic seals or exposed hinges are required, which improves resistance to corrosion and fouling.

Sterility

Although sterility is not a major concern for operation in Earth’s oceans, it is a major concern on Europa. While dynamic seals or hinges might require hydrocarbon lubricants, the ability to hermetically seal the vehicle reduces the likelihood of forward contamination on Europa. Underwater gliders leave a very small footprint wherever they explore.

Other Attributes

Underwater gliders may exploit the ambient environment through clever engineering. The *Slocum* thermal glider and the SOLO-TREC profiling floats use temperature gradients to harness environmental energy, for example. Also, if there is an ambient flow, it might be leveraged in motion planning and control to enhance transport efficiency. Alternatively, the failure to detect and properly account for an ambient flow could jeopardize the mission by carrying a vehicle beyond communication range.

6.1.6 Performance Limitations

Agility

While underwater gliders have a number of attributes to recommend them for a mission to Europa, there are several limitations, starting with agility. Underwater gliders must rise or sink to move forward and to turn; they cannot attain level (constant-depth) flight. So, while a glider may navigate precisely to a given location, it cannot maneuver effectively in a “hovering” state. Inspection tasks or docking to recharge and communicate may be essential features of an under-ice mission to Europa and would require adaptations to the glider concept.

Speed

Consider an underwater glider of net weight \widetilde{W} and wing planform area S , operating in a fluid of density ρ . If C_L and C_D represent the lift and drag coefficients, in the given flight condition, then the glider speed is

$$V = \sqrt{\frac{2\widetilde{W}}{\rho S} \frac{1}{[C_L^2 + C_D^2]^{1/4}}} \quad (6.2)$$

A larger vehicle, with a proportionately larger buoyancy lung, can travel faster than a smaller vehicle, but the speed only grows with the square root of the lung capacity.

To give a sense of glider mass and volume, Figure 6.3 shows the neutral displacement (in kilograms) of a cylindrical hull in water, given a length-to-diameter ratio of 7. A 1 meter glider would displace about 20 kg; a 2 meter glider would displace more than 100 kg.

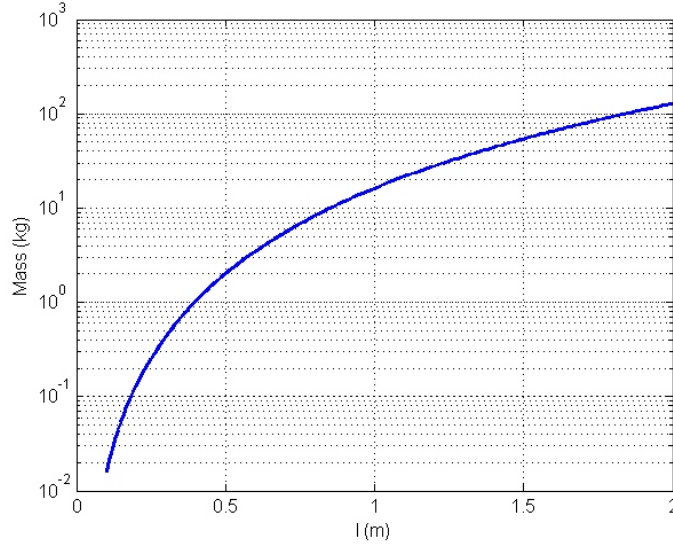

Figure 6.3: Neutral displacement of a cylindrical hull in water versus length. (Fineness ratio: $l/d = 7$)

The relationship between glider speed and geometry, as described in [3], is summarized here. Consider a cylindrical-hulled underwater glider of length l operating under a gravitational acceleration g . Let AR denote the aspect ratio of the wing and let κ denote the ratio of the wingspan to the hull diameter. (Given a hull diameter, these two parameters are in one-to-one correspondence with the wingspan and chord length.) Let $\bar{\eta}$ denote the net displacement from neutral buoyancy as a percentage of the neutrally buoyant displacement. Then

$$V = \frac{1}{\kappa} \sqrt{\frac{\pi g l}{2} AR \frac{\bar{\eta}}{1 + \bar{\eta}}} \sqrt{\frac{1}{C_D^2 + C_L^2}} \quad (6.3)$$

Speed scales inversely with the wingspan ratio; stubbier wings result in faster speeds. The dependence of speed on aspect ratio is more subtle, since aspect ratio affects the slope of the lift curve $C_{L\alpha}$ and also the drag coefficient $C_D = C_{D0} + KC_L^2$ through the induced drag parameter K .

Maximum efficiency is obtained by flying at the minimum descent angle, which corresponds to the “minimum drag” flight condition:

$$V = \frac{1}{\kappa} \sqrt{\frac{\pi g l}{2} AR \frac{\bar{\eta}}{1 + \bar{\eta}}} \sqrt{\frac{1}{\frac{C_{D0}}{K}(1 + 4KC_{D0})}} \quad (6.4)$$

Alternatively, the maximum horizontal speed can be obtained by choosing the flight condition to maximize the following:

$$V_x = \frac{\sqrt{2\bar{W}}}{\rho S} \frac{C_L}{[C_L^2 + C_D^2]^{3/4}} \quad (6.5)$$

Interestingly, this flight condition corresponds to a descent angle of about 35° for any flight vehicle, i.e., for any sufficiently small values of the parasite drag parameter C_{D_0} and the induced drag parameter K ; see [3].

Figure 6.4 shows the drag polar for a model of the *Slocum* glider, as presented in [3]. Each point on the curve corresponds to a distinct steady gliding flight condition, with the angle of attack decreasing as the curve approaches the C_D axis. Flight conditions of interest include the maximum horizontal speed condition and the minimum glide angle condition. (For angles of attack beyond this latter point, the glide angle begins increasing again until the vehicle stalls.)

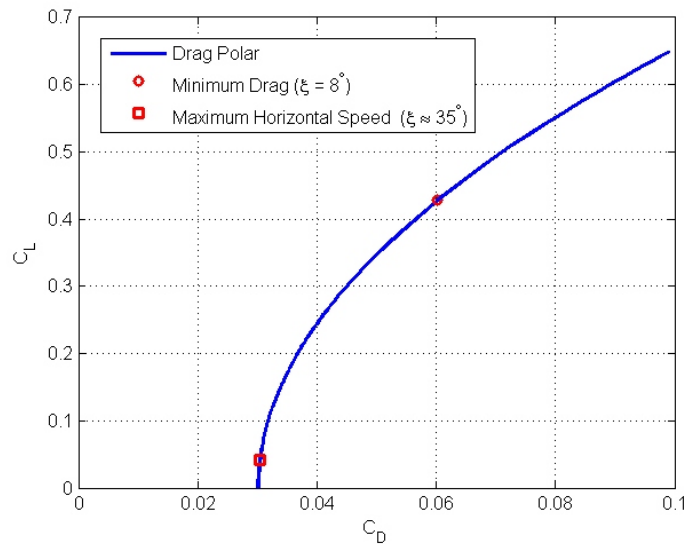

Figure 6.4: Drag polar for a model of the *Slocum* glider [3].

Other Limitations

Another limitation for gliders operating on Earth is eventual performance degradation due to bio-fouling or (remarkably) shark bites. Naturally, if these issues arise on Europa in a way that can be verified, the mission will have been a clear success.

6.1.7 New Horizons

Several emerging research directions promise to advance the feasibility of the proposed exploration concept. Three of them are discussed here: (1) advanced motion planning and control methods for vehicles operating in currents, (2) biomimetic propulsion, and (3) biomimetic control.

Motion Planning and Control in Currents

The analysis described in [91] found that an underwater glider can execute a steady turn while maintaining a fixed speed, angle of attack, and descent angle. This result suggested an approach for planning efficient local paths by concatenating steady motions that maximize the lift-to-drag ratio. The approach has been extended to account explicitly for known currents [5] and to minimize the impact of unknown currents [93]. Figure 6.5 shows an optimal path for a planar vehicle moving in a steady, uniform flow. The vehicle maintains a constant flow-relative speed and can turn left or right up to some maximum rate. Energy-optimal three-dimensional path planning for underwater gliders can be formulated in a similar way and solved using this same approach.

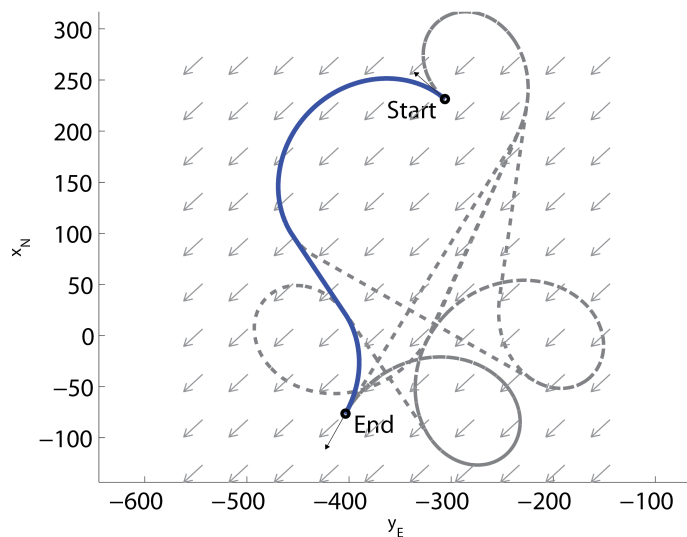

Figure 6.5: Example of vehicle path optimization in a steady, uniform flow [5].

Precise point-to-point path planning is unnecessary over large time and space scales, as when a glider is profiling the ocean. It becomes extremely important, however, in terminal guidance toward a point of interest, such as a docking station. It may also be important in this scenario to have an accurate model for nonuniform flow effects on the vehicle dynamics, as described in [97]; a higher fidelity model can enable more effective control and estimation.

Speed: Thunniform Propulsion

Marine mammals, including whales, dolphins, and pinnipeds, exhibit “gliding” behavior, presumably as an energy conservation strategy to increase the duration and depth of dives [98]. Based on energetics analysis, most marine mammals would only be capable of diving a few tens of meters for a few minutes, if they swim continuously. To perform longer and deeper dives, they swim until their rib cages begin to collapse under the ambient pressure and then they configure their fins for gliding. By adjusting their rib cage, they can manage their buoyancy and control their descent. For

shallow dives between 50 and 150 meters, marine mammals glide between 20% and 80% of distance traveled. For deep dives (as much as 400 meters), marine mammals glide for almost the entire time (between 75% and 100%) [98]. During ascent, these creatures exhibit a “stroke-and-glide” mode, repetitively using a few strokes to generate forward momentum and then “coasting.”

The gliding motion of marine mammals in descent is identical to that of underwater gliders, but these creatures also have the ability to actively swim. Swimming is energy intensive, compared to gliding, but it allows a creature to overcome currents and to perform more aggressive maneuvers.

The parallel between marine mammals and underwater gliders is most evident in dolphins and whales. Dolphins and whales tend to have large, wide tail-fins and smaller fore-fins. Pinnipeds (literally *fin-feet*) are also analogous, though they have larger fore-fins to enable walking [9]. Considering the performance objectives and the dimensional scale, dolphins emerge as an appropriate analogy when exploring design modifications that might improve glider speed.

The fineness ratio (FR) for dolphins and whales, the body length divided by the maximum diameter, is between about 3 and 7 [9]. It is straightforward to find the drag coefficient per unit volume for a spheroid of the same fineness ratio. This quantity represents the cost of transport, and has its minimum at a FR around 4.5. For FRs within the range 3 to 7, the drag coefficient is within 10% of this minimum value. Marine mammals seem to be shaped to minimize drag [9]. Underwater gliders designed to maximize payload and performance (e.g. DeepGlider [6]) fall into this same FR range, while gliders designed to other criteria do not (e.g. SLOCUM [8]).

The tail fins of dolphins and the wings of underwater gliders fulfill the same role during gliding. Two primary geometric characteristics of a wing are its span and its area. The span and area of several dolphins and other marine mammals are shown in Figure 6.6. Both the span and area of the tail fins (also called tail “flukes”) of marine mammals show a strong correlation with the body length. The trend appears linear on a logarithmic plot. Figure 6.6 also indicates where three underwater gliders fall in this trend: Deepglider [6], Spray [7], and SLOCUM [8]. For the gliders, the length of the vehicle excluding trailing antennas was used for body length and the wing’s dimensions were used in place of the tail fluke’s. (The trailing antenna, which is used for positioning and communication, adds considerable length to an underwater glider but very little mass or volume.)

In a similar vein, the sweep and aspect ratio of the tail fins of marine mammals are related. This relationship is shown in Figure 6.7. In general, as aspect ratio increases, sweep decreases. Data points for SLOCUM and Seaglider are also included.

To swim faster, marine mammals increase the frequency of their stroke and keep the amplitude of their stroke constant. Even while swimming at high speeds, marine mammals stroke at relatively low frequencies – a few cycles per second, at most [9]. Additionally, marine mammals vary the compliance of their tail fins depending on the frequency of their stroke [9]. The variable compliance of fins has been shown to improve the propulsive efficiency of flapping motion. The correspondence between stroke frequency and compliance is discussed in [99]. A similar performance improvement when compliance is varied has been observed in bird wings [100]. The variable compliance of dolphin tails (achieved through adjustable tension on the tendons) can be mimicked in an engineered system through the use of smart materials, such as piezoelectric materials.

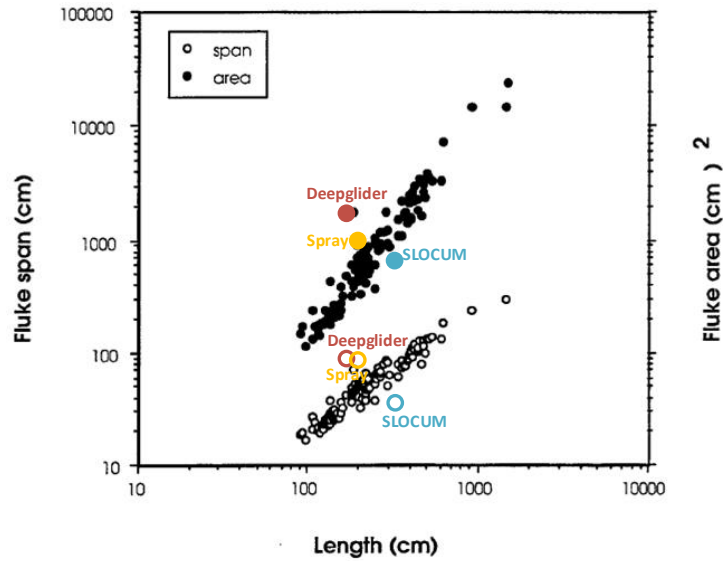

Figure 6.6: Comparison of the relation of tail fin span and area with the body length of various marine mammals (primarily dolphins). The corresponding values for Deepglider [6], Spray Glider [7], and SLOCUM [8] are included. Original figure from *Review of Dolphin Hydrodynamics and Swimming Performance* by Frank E Fish [9].

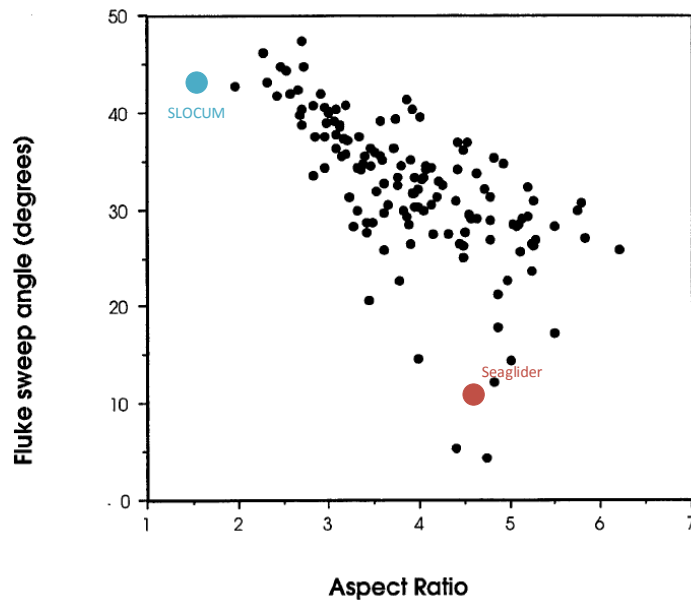

Figure 6.7: Relationship between sweep angle and aspect ratio of the tail fin of marine mammals. The corresponding values for Seaglider*[10] and SLOCUM [8] are included. Original figure from *Review of Dolphin Hydrodynamics and Swimming Performance* by Frank E Fish [9]. *Estimated from photograph.

Dolphins possess very powerful muscles. In fact, dolphins were once believed to have muscle strength eight times that of land mammals, but modern analysis has tempered this claim [9]. The most powerful dolphin produces about 86 W/kg, though most produce less than 30 W/kg. These specific powers represent the propulsive power per unit total mass; the propulsive specific power is likely about twice this amount. These specific powers are in-line with those of smart materials. The specific energies and operational frequencies of smart materials are shown in Figure 6.8 [11]. Many smart materials, such as piezoelectrics, are capable of operating at frequencies on the order

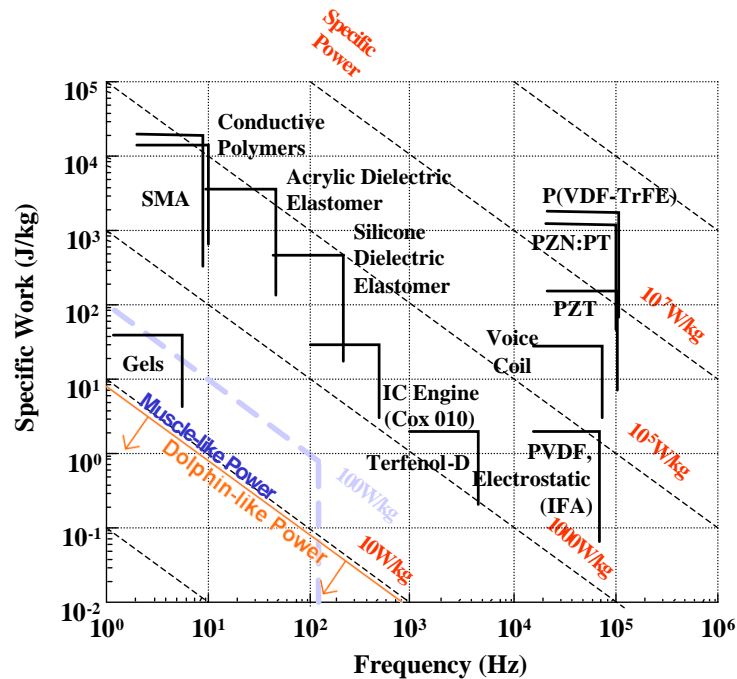

Figure 6.8: The specific energies and operating frequencies of several smart materials [11]. The diagonal lines indicate specific powers, which are the product of the specific energy and frequency. The region corresponding to dolphin-like specific power is indicated by the orange line. These specific powers are based on the total mass of the animal, so is likely less than the propulsive specific power[9].

of kHz, but perform poorly at low frequency. Dolphins move their tails at frequencies of only a few Hz, however. While cleverly designed piezoelectric smart structures might eventually enable high power, low frequency operation, there are other smart materials that already operate well at low frequencies. Silicon and acrylic dielectric elastomers appear to be the best match because of their combination of raw strength and maximum strain, as well as their operating frequency and energy density [11].

Agility: Pectoral Fins

Just as a biologically inspired movable tail can enhance an underwater glider's speed performance, biologically inspired pectoral fins could improve agility. With the addition of pectoral fins, similar to the fore-fins of a dolphin or the arms of a pinniped, a glider could perform demanding

maneuvers, such as hovering turns.

Currently, flapping fin underwater vehicles are being developed using traditional motors. An example using fins that are controllable about two axes is described in [101]. These vehicles are capable of using the fins to hover or swim or as more conventional control planes [102]. In hovering and swimming experiments, flapping frequencies have been reasonably low – less than one Hz [103].

Fish move their pectoral fins by actuating ribs embedded within the thin membrane of the fin. Opposing tendons connecting these ribs to muscle generate the flapping motion [104]. In an engineered system, this could be accomplished using smart materials. A fin made of smart materials capable of the complex motion of these fins is described in [105]. This fin has demonstrated similar motions to those required for hovering and swimming [103][106].

6.2 Melt Probes

Melt probes offer a straight forward means of tunneling through ice. They do not require any mechanical means of drilling, relying on heat and gravity to melt through ice. They are currently being used to study glaciers on Earth and can be extended to study ice sheets on other bodies [107]. The primary advantage of melt probes is their mechanical simplicity, compared to drills and related devices, and corresponding reliability; melt probes require no moving parts and thus can operate for extended periods without failure. Other devices, like drills, require complex moving parts and cutting tools that may wear out. There are variations of the basic design of melt probes that include mechanical devices such as vibrators [107] and water pumps [108], but these devices are still less complex and arguably more reliable than rotating cutting tools.

6.2.1 Principles of Operation

The principle of operation of melt probes is straightforward; the bottom, called the “hot point” is heated and placed in contact with the ice. Melting by the hot point creates a layer of melt water. The weight on the hot point displaces some of the melt water, causing the probe to sink deeper into the ice. Eventually, the probe operates in steady state, where the rate of melting of the ice is equal to the rate of water displaced. Through clever mechanical design, the melt probe can passively guide itself along the local direction of gravity.

Hot Point

The hot point is the primary component of a melt probe; it is responsible for melting the ice. Its sole function is to transfer thermal energy to the ice. Methods for heating the hot point include indirect methods (i.e., transducers such as electric heating elements) and direct methods (such as a Radioisotope Heating Unit, RHU). An RHU is essentially a mass of decaying radioisotope. As the radioisotope decays, it produces heat and other decay products. This heat can be transferred to the hot point directly (through a conducting medium) or indirectly (through heat exchange pipes).

Electric heating involves placing electrically powered heating elements throughout the hot point. This is a less complex design that requires less complex controllers than direct heating, but it suffers from greater thermodynamic losses than direct heating.

Water Pumps

Direct heat transfer from the melt probe to the ice has been found to be an inefficient means of melting through ice. Recirculating heated melt water can be a much more efficient means of heat transfer, but surface-based pumps have massive power requirements. If the pumps for recirculating melt water are located within the melt probe itself, however, the power requirements diminish sharply [108]. Water pumps can also improve ice penetration when debris is embedded in the ice. The pump can help dislodge debris and prevent it from pooling near the hot point.

Attitude Control

There are active and passive methods for ensuring that the melt probe descends vertically, passing through the ice as quickly as possible. Active methods involve controlling the heat distribution around the melt probe, which can be accomplished by differential heating of the hot point or by differential heating along the length of the probe. Differential heating affects the probe's attitude as it slips through the ice by changing the shape of the melt water pocket. This is a more complex method of controlling the attitude than passive methods, but it allows for directional control enabling the probe to avoid obstacles such as pockets of regolith.

Passive directional control does not require active input, like active control, but it does not allow for turning to avoid obstacles. One method, known as Mercury steering, uses a pool of Mercury in the hot point to redirect heat [109]. If the probe begins to "fall over," the Mercury pools at the bottom of the hot point, concentrating the heat transfer through that point. Another method is pendulum steering. This requires a heated, curved flange near the top of the melt probe. Essentially, the probe hangs vertically from the "ball joint" created by the ice and this curved flange as the probe descends [110]. The heating of this flange must be carefully tuned to ensure correct performance as the hot point continues to penetrate the ice. If the heating of the flange is too high, the ball joint will melt. If it is too low, the joint will bind the probe in place.

6.2.2 Examples

There are two primary examples of melt probes : the Philberth probe and the University of Washington (UW) Applied Physics Laboratory (APL) Ice Diver. The Philberth probe represents the early development of thermal melt probes, while the Ice Diver represents more recent developments. This probe utilized Mercury steering in order to control its descent. As it descended, it deployed two tethers; one tether for power and another for telemetry. As the probe descended, the borehole collapsed in on itself, freezing the tethers in place. The probes were designed to be expendable [12].

The Philberth Probe

The Philberth probe was developed in the 1960's by the Cold Regions Research and Engineering Laboratory, part of the US Army Material Command. The design was originally developed by Dr. Karl Philberth. A diagram of the probe is shown in Figure 6.9.

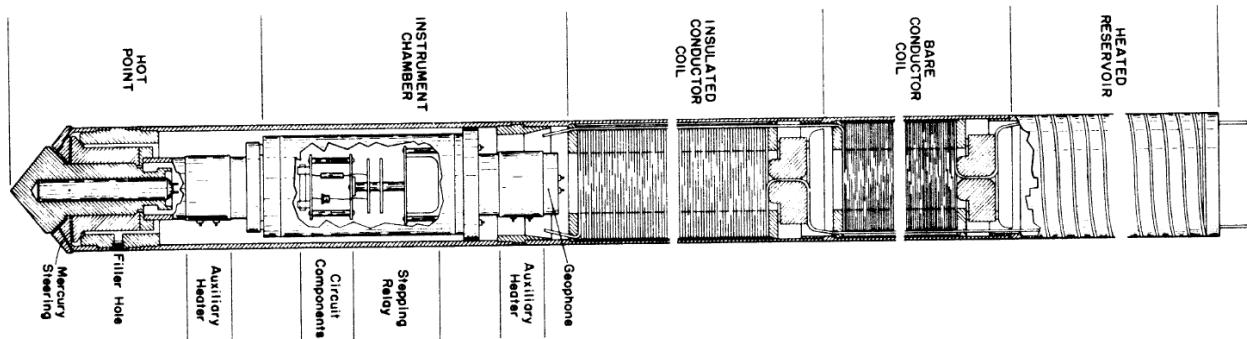

Figure 6.9: A diagram of the structure of the Philberth probe. From *Heat Transfer and Performance Analysis of a Thermal Probe for Glaciers* by Haldor W.C. Aamot.[12]

UW APL Ice Diver

The Ice Diver, being developed by UW APL, utilizes resistive heating of the hot point and a spherical flange for pendulum steering. The Ice Diver is powered by a generator on the surface. The power is transmitted through tethers deployed as the probe descends. Sub-scale tests have already been conducted and field tests are scheduled for July 2013 [111].

6.2.3 Performance

There are several design considerations in designing a melt probe. The first is the probe's shape. The descent rate of a cylindrical melt probe, when the ice is dense and transitions into water, is approximately

$$v = \frac{1}{\rho_{ice}} \left(\frac{Q}{Q_m} \right) \left(\frac{1}{\pi r^2} \right) \quad (6.6)$$

where ρ_{ice} is the density of the compact ice, Q_m is the melting heat of the ice, Q is the full heating power of the probe, and r is the radius of the probe [107]. Thus,

$$v \propto \frac{Q}{r^2} \quad (6.7)$$

so the design trade-off is between the heating power of the probe and the radius of the probe. Notice that the length of the probe has no effect on the descent rate; the probe should be "pencil-shaped" to maximize interior volume while minimizing cross-sectional area.

Descent Rate

An approximate equation to determine the decent rate is presented in equation (6.6). Biele, *et al.* [112] presents a more complex, but similar model. Specifically, the decent rate, v , is determined by

$$v = \frac{P}{A\rho_i(c_p(t_F - t) + L_\nu)} \quad (6.8)$$

where P is the melting power of the probe, A is the cross sectional area of the probe, ρ_i is the density of the ice, c_p is the specific heat capacity of ice, t_F is the melting temperature of the ice, t is the local ice temperature, and L_ν is the heat of fusion of the ice [112]. Note that, for a given set of conditions, $(c_p(t_F - t) + L_\nu)$ can be absorbed into a single term, which is equivalent to Q_m in equation (6.6). Similarly, if the cross section is circular $A = \pi r^2$. Thus, these equations are equivalent. It is now possible to generate a rough approximation of the descent rate. Assuming that the local ice temperate is 175 K, the descent rate for various heating powers is shown in Figure 6.10. At this point it should be noted that this is a very rough approximation that does not consider

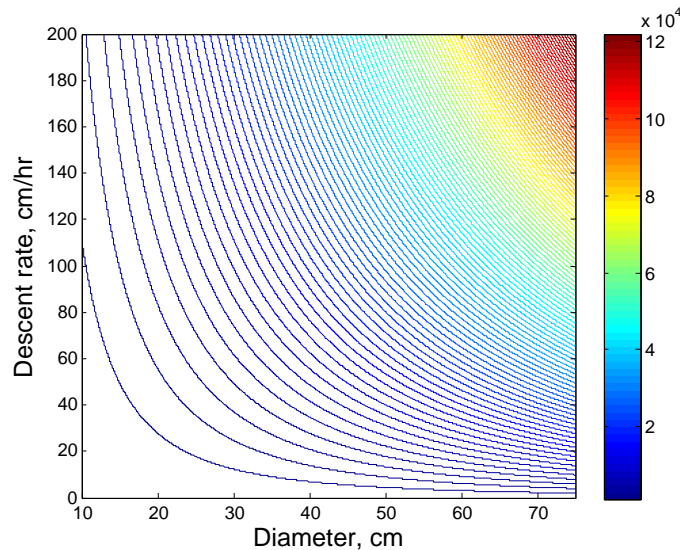

Figure 6.10: Descent rate for various sizes of cylindrical probes with various powers, represented by the color contours. This used equation (6.8) with the following parameters: $c_p=2.2$ kJ/kg K, $t_F=273$ K, $t=175$ K, $\rho_i=920$ kg/m³, $L_\nu=330$ kJ/kg. This assumes constant properties.

the actual shape of the cryobot or the method of penetration.

Effect of Tip Shape and Radial Heat Losses

The model predicted in Equation (6.8) does not account for the shape of the tip and the placement of heaters. These parameters have been shown to have a major effect on the descent rate of a probe [109]. Furthermore, the descent rate does not behave linearly with heating power, as predicted by Equation (6.8) [13].

In order to understand how the descent rate of a melt probe varies with heat input, there are two factors to consider: rate of heat transfer and shape of the hot point. A detailed derivation of melt probe performance is given in [13]. Shreve's work [13] assumes the melt probe operates at steady state (i.e. the thermal power of the hot point is equal to the rate of heat transferred to the ice and melt water), that the melt water flow is not turbulent, that the hot point is radially symmetric, and that the melt tip is isothermal. It was found that a turbulent flow of melt water actually improves performance [13].

The relationship between a performance number N and the efficiency E is shown in Figure 6.11. Performance number and efficiency are defined per [13].

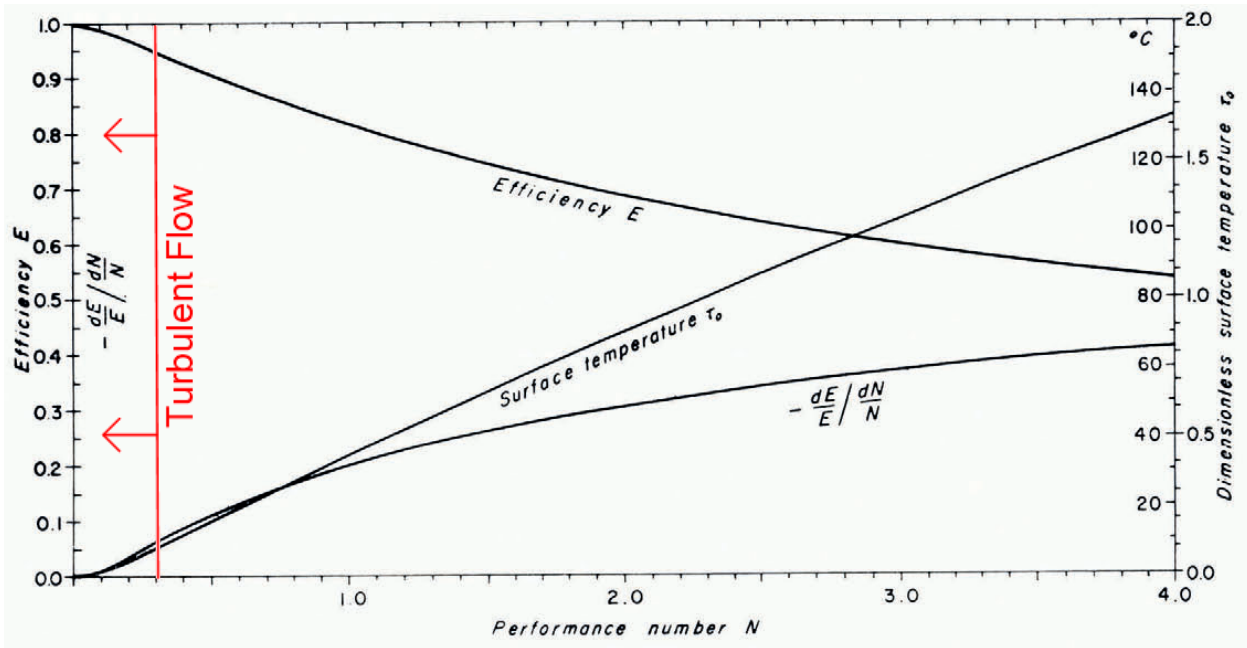

Figure 6.11: Relationship between performance number and efficiency and non-dimensional temperature. From *Theory of Performance of Isothermal Solid-Nose Hotpoints Boring in Temperate Ice* by R.L. Shreve (1962) [13].

The non-dimensional surface temperature is

$$\tau_0 = \frac{c_p \theta_0}{L_v} \quad (6.9)$$

where θ_0 is the actual surface temperature.

The other quantity plotted in Figure 6.11 is the proportional rate of change of efficiency per unit proportional change in performance number. This quantity expresses the change in descent rate with changes in heat input.

The percent increase in descent rate, V , is equal to the percent increase in total input power, Q . However, as the performance number increases (as it does when descent rate increases), the ratio of percent change in descent rate to percent change in melting power decreases [13]. If one increases the melting power by 10% the descent rate would increase by *less* than 10%. For example, if

$\mathcal{N} = 4$, a 10% increase in the melting power would result in about a 6% increase in descent rate. It should be noted that the performance number increases with increasing descent rate. This means that as descent rate increases the efficiency decreases and, therefore, the amount of heating power must increase at a proportionally greater rate than the descent rate.

If the melting power and efficiency are known, the descent rate is

$$V = \frac{QE}{a^2\pi\rho_i L\nu} \quad (6.10)$$

where a is the maximum radius of the hot point. This expression is similar to Equations (6.6) and (6.8). In fact, if $E \approx 1$, then Equation (6.10) is equivalent to Equation (6.8) (with respect to the thermodynamic effect of the melt water layer). Despite including the effect of radial heating and the shape of the melt probe in the more accurate expression, if the efficiency is kept close to one, the descent can be accurately modeled by Equation (6.8). While this would seem to imply that Equation (6.8) only holds for slow descent rates (and thus low performance numbers and high efficiencies), there are several other methods for improving efficiency besides descending faster. These include choosing an ideal shape (reducing the shape factor) and making the melt water flow turbulent. One method of making the melt water flow turbulent is by injecting jets of reclaimed melt water out of the hot point. For further detail, the interested reader is referred to [13].

Effect of Water Jets

The addition of water jets that spray re-heated melt water out the front of a melt probe has been shown to greatly improve the descent rate of melt probes [113]. This may be due to the fact that water jets will induce turbulence, effectively increasing the thermal conductivity of the melt water. This effect can reduce the performance number by as much as a factor of 30 [13]. The reduction in effective performance number is represented by the turbulent flow region indicated in Figure 6.11. The increase in efficiency corresponds to an increase in the descent rate for a given melting power. For example, if the flow was not turbulent, a performance number of 3 would imply an efficiency of about 60% so that 40% of the melting power is lost (e.g. by melting an unnecessarily wide borehole). Additionally, the ratio of the percent change in descent rate to percent change in melting power is about 0.65. If the flow is turbulent, the performance number effectively reduces to as low as 0.1, which corresponds to an efficiency of over 95%. Because of this greatly improved efficiency, the ratio of the percent change in descent rate to percent change in melting power is closer to one so that the descent rate can be more effectively increased with small increases in melting power. It should be noted that, for most melt probes, the performance number (for non-turbulent melt water flow) is less than 4. Thus, the effective performance number should be at most about 0.2 for melt water with partially developed turbulence. The descent rate can be modeled by Equation (6.8) within an accuracy of only a few percent.

Since jets directly heat reclaimed melt water, the melt probe would not rely entirely on the hot point to heat the melt water. The reduced heating load on the hot point protects against two possible sources of inefficiency: corrosion of the hot point and a non-isothermal hot point. Non-uniform corrosion of the hot point can lead to non-uniform heat flow which reduces efficiency [13]. A

non-isothermal hot point results in a wider borehole, reducing the percentage of melting power that goes directly toward penetrating the ice.

Other Considerations

In general, when discussing power requirements and efficiency, only electrical power is considered. For example, a standard RTG converts less than ten percent of heat generated into electrical power and more advanced RPSs convert only about thirty percent of heat into electrical power [114]. Radioisotope power sources generate a large amount of waste heat. When attempting to melt through the ice, this waste heat can be transferred to the melt water enveloping the cryobot. Done in a deliberate way, where water is used to reject RPS waste heat and pumped to the front (bottom) of the cryobot, more of the energy produced by the cryobot's RPS can be used to melt through the ice. It would not be unreasonable to apply half of the heat produced by the RPS to melting, effectively increasing the specific power of the RPS.

Refreezing of the borehole is a major concern for the cold ice near Europa's surface. It is possible for the melt water to refreeze around the probe, trapping the probe in place [115]. There are at least two options to prevent this: (i) designing the probe to descend fast enough to avoid the problem and (ii) incorporating additional heating elements. In the latter case, additional heating elements along the melt probe would keep the water warm until it has passed the end of the melt probe, thus preventing refreezing [115].

6.3 Spacecraft Power Sources

Since the cryobot and hydrobot will operate for extended periods under the ice of Europa, solar power is not feasible. Since the proposed mission would last on the scale of months or years, operating exclusively with batteries is also not practical. Nuclear power supplies, including nuclear fission reactors and radiothermal generators, are one of few classes of power sources that could offer the high density, long-term power required for planetary exploration in foreseeable future missions. Various subsystems might incorporate batteries for short-term storage and/or rapid discharge, but would need a separate (nuclear) power source for recharging.

6.3.1 Nuclear Power Sources

Fission Reactors

Nuclear reactors present an attractive potential power source for spacecraft. They can deliver large amounts of power, last for years, and in principle can be made compact. The Soviet Union launched over 30 spacecraft, mostly successful, powered by nuclear reactors [116]. The United States has maintained a development program of nuclear reactors for space-based applications since the 1960's. The US launched a nuclear reactor-powered satellite in 1965. This satellite failed due to an instrument failure, although the reactor appeared to function properly [116].

A current focus in the development of space-based reactors is the Heatpipe Power System (HPS). Two such reactors are the HOMER-15 (Heatpipe-Operated Mars Exploration Reactor) and the SAFE-400 (Safe, Affordable Fission Engine), which are capable of producing 15 and 400 kW of thermal power, respectively. HPSs utilize liquid metal (typically sodium) to conduct the heat produced by fission to a heat engine, such as a Stirling engine [117]. The larger of these reactors, the SAFE-400, is relatively small (a cylinder about 50 cm in diameter and 60 cm long) and has a mass of a few hundred kilograms [118]. This device produces an order of magnitude more power than a comparable non-fission-based nuclear power source. Reactors produce significantly more radiation than other power sources while in use, but they actually produce less radiation than common radiation sources on Earth. Moreover, in the long term after a mission has been completed, they produce less radiation than other radiative sources [118].

The most recent planned spacecraft design to utilize nuclear reactors was Project Prometheus, a continuation of the Jupiter Icy Moons Orbiter (JIMO). The goal of this project was to develop a preliminary design study for a spacecraft that would orbit several of Jupiter's moons, including Europa. The spacecraft was to utilize a nuclear reactor with a gaseous heat exchanger and a Brayton cycle heat engine. The complete reactor, including shielding and the Brayton engine, would have a mass of about 3400 kg and be capable of producing 300 kW of electricity. The development of this reactor was expected to take approximately a decade and was identified as being in the critical path for mission success [119].

Radio-Thermal Power Sources

An alternative radiative power source to a fission reactor is a radioisotope power source (RPS). RPSs are power sources that produce energy from radioactive decay. The most common type of RPS is the radioisotope thermoelectric generator (RTG). RTGs produce power by converting some of the heat produced by a decaying radioisotope, typically plutonium 238, into electricity. Note that, although RTGs can use fissile material, they do not produce energy via nuclear fission. These generators are highly suited for space travel because they can produce steady power over a period of decades without relying on external energy (e.g. sunlight).

RTG development began with dawn of the space age. The United States began its development of this technology with the Systems for Nuclear Auxiliary Power (SNAP) series of RTGs. These used telluride thermoelectric technologies to convert heat into electricity [14]. The first space-flown unit was the SNAP-3B, which was flown aboard the Transit 4A and 4B spacecraft in 1961. These only produced 2.7 W of electricity, but they weighed only 2.1 kg. The next flight-tested SNAP RTG was the SNAP-9A, which was flown aboard the Transit 5BN-1 and 5BN-2 satellites in 1963. These weighted 12.3 kg, producing 25 W of electricity. The next RTG deployed in the SNAP series was the SNAP-27, which powered scientific experiments on the lunar surface. It was carried aboard all of the Apollo moon landers, except for Apollo 11, starting in 1969. This RTG produced 70 W of electricity and had a mass of 19.6 kg. Although it was developed before the SNAP-27, the variants of the SNAP-19 were carried aboard the Pioneer 10 and 11, and the Viking 1 and 2 spacecraft, both launched in 1972. These produced about 41 W of electricity with a mass of 15.6 kg. The last of the SNAP series was the TRANSIT RTG, which powered the Transit TRIAD navigational satellites. This was launched in 1972, and produced 35 W of electricity with a mass of 13.6 kg [14]. These

later RTGs pushed the physical limits of telluride thermoelectric technology, so a new technology was developed.

The new technology utilized a Silicon-Germanium Thermoelectric process. The first was the Multi-Hundred Watt (MHW) RTG, which was first deployed in 1976. It was used aboard the LES 8 and 9 and the Voyager 1 and 2 spacecraft. These have a mass of about 40 kg, producing 155 W of electricity. The next RTG units that were developed utilized the General Purpose Heat Source-RTG (GPHS-RTG). RTGs based on this technology have a mass of 55.9 kg and produce over 300 W of electricity. These RTGs were launched on the Ulysses, Galileo, Cassini, and New Horizons missions. To improve the efficiency of RTGs using the GPHS-RTG, NASA replaced the thermoelectric elements with Stirling engines. This device is currently underdevelopment and is called the Advanced Stirling Radioisotope Generator (ASRG). Since the ASRG does not have thermoelectric elements, it defines a new class of RPS beyond RTGs. Currently, the ASRG is expected to produce 170 W, but with a mass of only 25 kg [15].

There is a trend of specific power (power divided by the mass) over time, as shown in Figure 6.12. The specific power, P_s (in W/kg) follows the following trend:

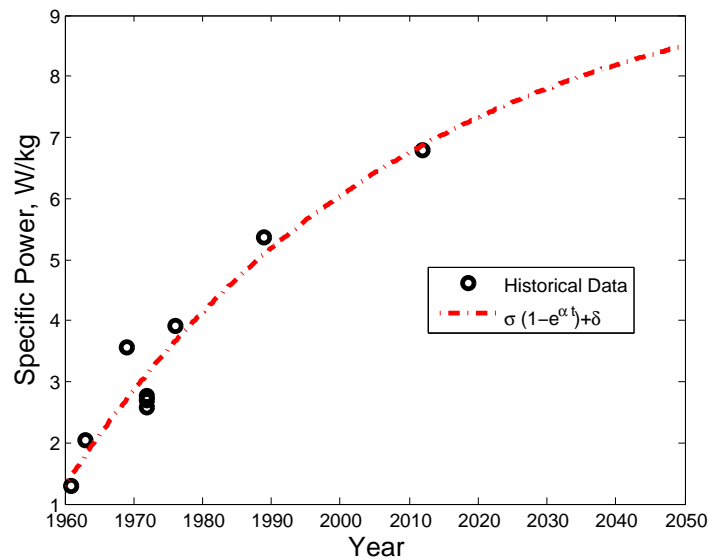

Figure 6.12: Specific Power of RTGs over time with an exponential fit. Historical data per [14]; ASRG data per [15].

$$P_s = \sigma (1 - e^{-\alpha t}) + \delta \quad (6.11)$$

where t is time in years since 1960, $\alpha = 0.020$, $\sigma = 8.64$ W/kg and $\delta = 1.291$ W. The fit is reasonably accurate. At $t = 0$ (the year 1960), RTGs existed and had a finite performance of value around δ . As research accelerated, the performance of RTGs rapidly increased. According to the fit, RTGs should eventually reach a maximum specific power around $\sigma + \delta \approx 10$ W/kg. This value agrees with the NASA report titled *Realistic Specific Power Expectations for Advanced Radioisotope Power Systems*, which concludes that “RPS specific power values greater than 10 W/kg appear unrealistic” [114].

The GPHS-RTG and ASRG both utilize several General Purpose Heat Source (GPHS) modules. The GPHS module is a radioisotope heating element, designed to be highly modular. It is rectangular in shape, with dimensions of 93.17 mm by 97.18 mm by 53.08 mm and has a mass of 1.43 kg. Each module is capable of producing 245 W of thermal power (Wt) at the time of launch [120]. This indicates a specific power of about 170 Wt/kg and a volumetric specific power of 510 kWt/m³. A cylinder 30 cm in diameter and 50 cm long would produce about 18 kW of thermal power with a mass of about 100 kg.

When a radioisotope heat source is being used primarily for its heat generation capability, it is called a Radioisotope Heating Unit (RHU). This is used to differentiate between RPSs, which are used primarily to generate electricity, and devices that are used primarily for their ability to generate heat. Despite this distinction, the heat of RPSs can be used to perform tasks (e.g. heating the spacecraft), and the excess heat of RHUs can be used to produce electricity. The distinction exists to identify the *primary* purpose of a radioisotope device, not its exclusive purpose.

6.3.2 Batteries

Even though radioisotope technology would likely be employed as the primary power source, batteries would likely be used as a secondary power source for short-term storage and rapid discharging of energy. Batteries may also be the best choice for the hydrobot power supply, depending on the mission architecture. It is therefore important to consider the various categories of batteries and their relative strengths and weaknesses.

Batteries can be divided into two main categories, primary and secondary batteries. Primary batteries are those that are a one-time use and non-rechargeable, while secondary batteries can be recharged and reused. A subcategory of primary batteries is reserve batteries which remain inert until activated. The advantage of primary over secondary batteries is higher energy capacity.

When comparing battery characteristics, energy is the main concern. Important parameters include specific energy, the average power provided per unit mass, and energy density, the average energy provided per unit volume. These two parameters are very similar. The former relates more directly to mission cost (which scales with mass) while the latter relates to payload volume. The specific energy ranges for various primary batteries are shown in Figure 6.13. Figure 6.14 shows the variation in practical energy density among primary batteries. Lithium batteries compare especially well among available chemistries [121].

For the various rechargeable batteries, Figures 6.13 and 6.14 show the practical specific energies and energy densities, respectively. These batteries might be employed in various mission subsystems to power necessary electronics and scientific instruments, being continuously recharged by an RTG, for example. The figures again show that lithium chemistries compare well in terms of both energy density and specific energy. Looking at Figure 6.15, the theoretical limits are also promising, as battery technology continues to evolve.

A 2010 analysis considered the future prospects of 4 different types of rechargeable batteries that are used in electric cars: Li-ion, ZEBRA, lithium sulfur, and two metal-air batteries: zinc-air and lithium air [32]. These batteries are a focus of current research and development. Lithium-ion

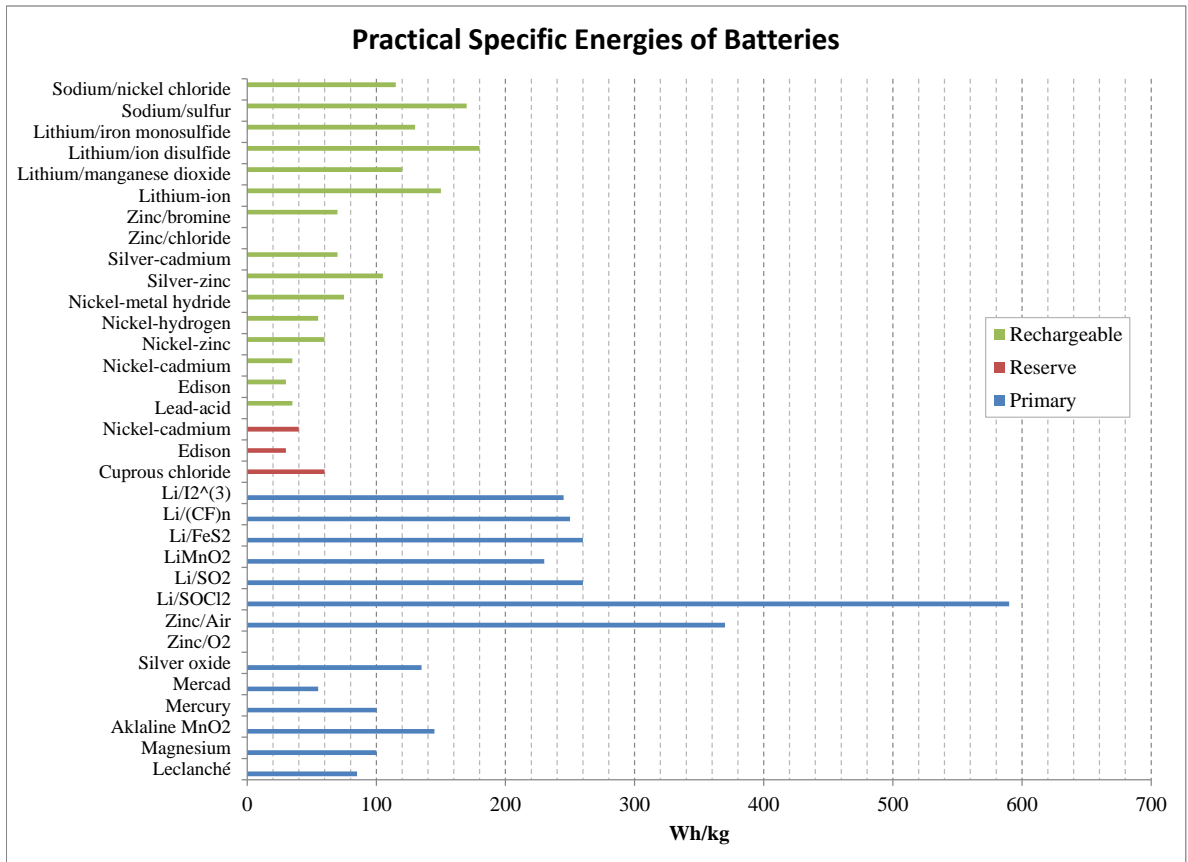

Figure 6.13: This figure shows the practical specific energies of primary, reserve, and secondary batteries. Data per [16].

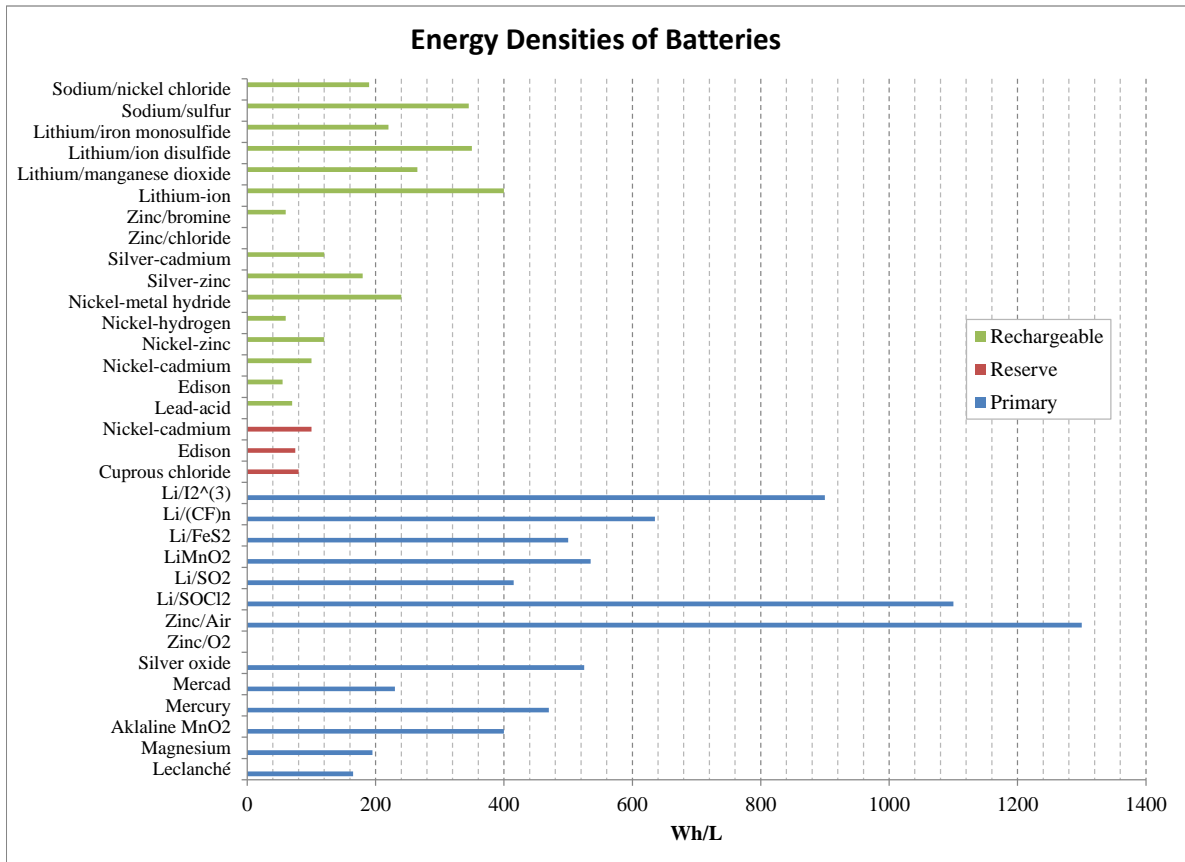

Figure 6.14: This figure shows the practical energy densities of primary, reserve, and secondary batteries. Data per [16].

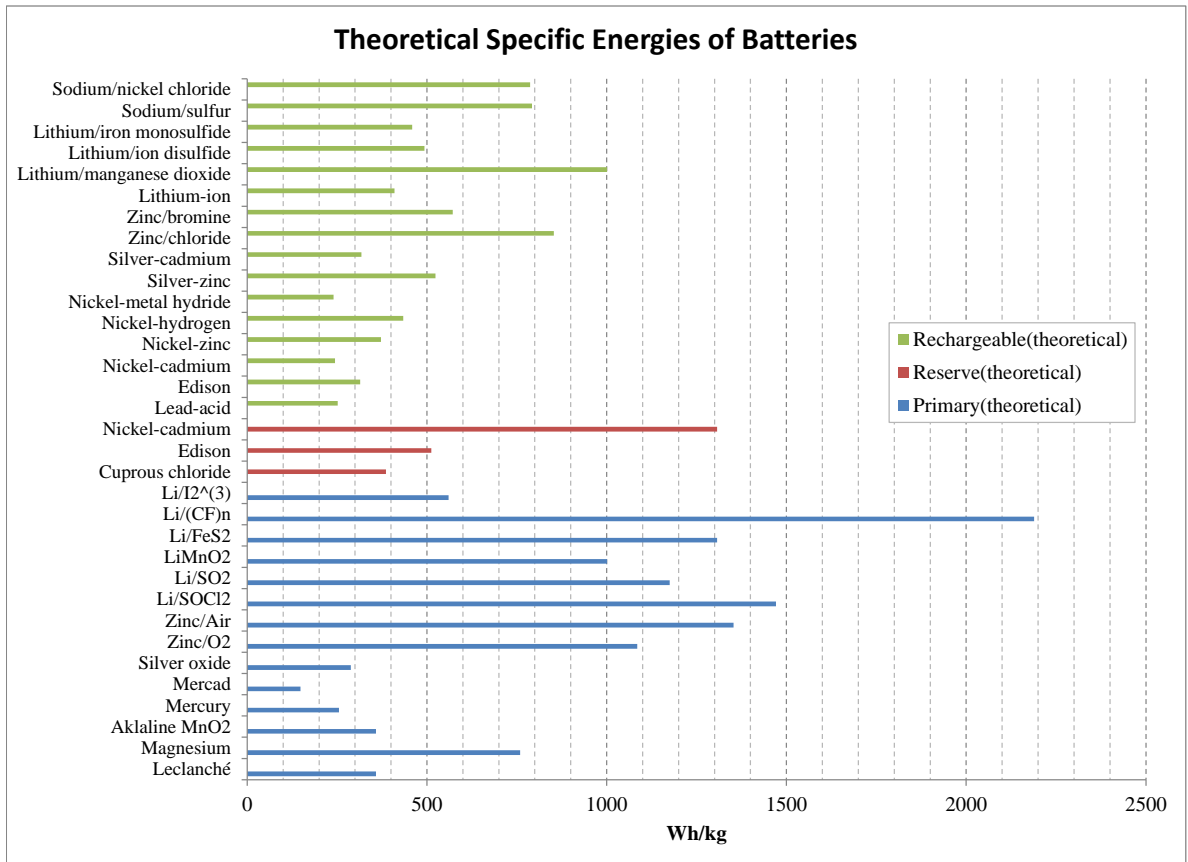

Figure 6.15: This figure shows the theoretical specific energies of primary, reserve, and secondary batteries. Data per [16].

batteries account for the largest share of rechargeable lithium batteries in commercial use. ZEBRA batteries are a sub-category of high temperature batteries that operate in temperatures of 300°C to 350°C. Their most common form is sodium nickel chloride (NaNiCl). Lithium sulfur batteries, not represented in the figures, are still in early development. They may ultimately provide high specific power and specific energy densities. Lithium-air batteries are still in the initial stages development, while zinc-air batteries are in a more advanced stage of development. The current state of these batteries is summarized in Table 6.1, according to the study [32].

Table 6.1: Present-day electric car battery characteristics. Data per [32].

	Li-ion	ZEBRA	Li-S	Zn-air	Li-air
Specific Energy, [Wh/kg]	140-170	unknown	350	unknown	up to 500

The results of the study concluded some noticeable changes for each of the battery types. The Li-ion batteries were projected to increase in specific energy at a rate of about 6% per year until 2020 but then reach a practical limit of about 250 Wh/kg in 2025. The specific power and cycle life was projected to remain nearly constant. Battery cost was projected to decrease. ZEBRA batteries were projected to reach a specific energy of 200 Wh/kg. Their operating temperature may be reduced to room temperature by 2020, and cost will likely be reduced. Lithium-sulfur batteries are projected to have a specific energy of 320 to 520 Wh/kg in 2020. Cycle life is a key issue for lithium-sulfur batteries, which may see an improvement to 1000 cycles by 2020. Low temperature performance will likely improve, as well. Zn-air batteries are projected to see specific energies of 150 to 400 Wh/kg beyond 2025, and their safety is predicted to be exceptional. Lithium-air batteries are predicted to reach 500 to 1000 Wh/kg beyond 2025, but with similar safety concerns as current lithium chemistries. Table 6.2 illustrates the long-term predictions for these batteries [32].

Table 6.2: Battery characteristics beyond year 2025. Data per [32].

	Li-ion	ZEBRA	Li-S	Zn-air	Li-air
Specific Energy, [Wh/kg]	250	200	500	200-400	500-1000
Specific Power, [W/kg]	50 or greater	400	300 or greater	unknown	unknown

Some other potentially high specific energy batteries are Zn-air, Li-air, Al-air, and Fe-air. Some innovative new battery technologies that may be of interest in the future include: conversion, organic lithium, ambient temperature Na-ion, Mg-ion, Ni-li, Li-Cu, and all-electron batteries. These technologies will need to be reevaluated as each technology continues to evolve [32].

Liquid Metal Battery

One exciting new technology is the liquid metal battery. Currently under research, this type of battery exhibits remarkable resilience. It is composed of three layers of varying density. In a gravitational field, the three liquid components stratify according to their respective densities [122]. Using this battery in space would require simulating the gravitational force, e.g., with a centrifuge. Because of the unique configuration, the battery is impervious to common causes of mechanical failure in conventional batteries. At present, the technology is too immature to compare with others in terms of energetics.

6.3.3 Fuel Cells

Having gained increasing attention as a portable power source, fuel cells should also be considered as a potential secondary power source. In theory, fuel cells can function in much the same way as batteries but with higher specific energies and energy densities. The major disadvantage is their higher cost [123]. Also, since specific energies of fuel cells are largely dependent on the fuel used, the specific energies of the particular fuels must be examined. Figure 6.3.3 shows five different fuel cell fuels. Hydrogen is the clear winner in terms of specific energy, at 32.67 kWh/kg [17].

Alkaline fuel cells (AFC) are a feasible technology for the proposed mission, having been used by NASA in earlier space missions. Being hydrogen powered, alkaline fuel cells are impractical for consumer use, but they are appropriate for extra-terrestrial exploration [124]. The cost is estimated around \$400-500 per kW. Researchers today are turning away from AFCs in favor of the Proton Exchange Membrane fuel cells (PEMFCs).

PEMFCs are theoretically outperformed by AFCs, but recent advances have increased interest in PEMFCs for space applications. Current PEMFCs at NASA are designed to output power in the range of about 1 to 10 kW. These systems have specific powers of 250 to 350 W/kg. Although there is no data on specific energy, the systems last for a long time, having a lifetime of approximately 10,000 hours, which is commensurate with the proposed EUROPA mission. NASA is currently trying to advance aerospace power systems using PEMFCs [125].

6.4 Hydrobot Sensor Packages

Three sensor packages were devised based on current underwater glider sensors. The packages increase in capability, power, and mass requirements in going from Package 1 to Package 3. Thus, these packages demonstrate a trade-off between scientific return and mass/power requirements. Each package is capable of taking essential physical oceanographic measurements, such as temperature, pressure, and conductivity. Additional instruments are included to investigate other characteristics of the European ocean. The sensor packages are presented in reverse order, starting with the most capable (Package 3) indicated by Table 6.3. Package 2 is summarized in Table 6.4 and Package 1 is summarized in Table 6.5. Note that sonar and navigation equipment are not included in these tables. Instrument power and mass were estimated based on nominal values given in [87]

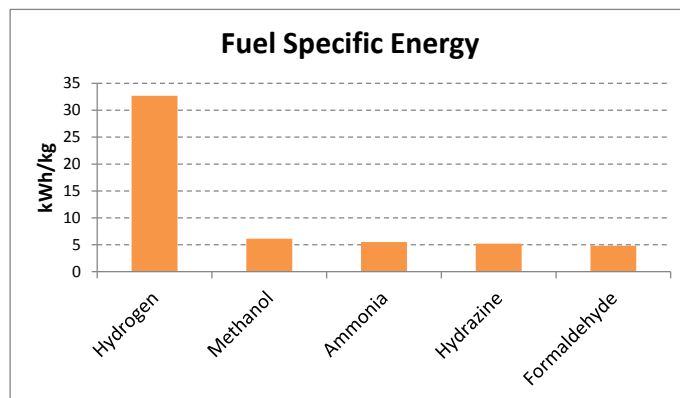

Figure 6.16: Specific energies of fuel cell fuels [17].

and in current commercial product literature [126].

6.4.1 Package 3

Table 6.3 lists the sensors chosen for Package 3, the most comprehensive package of the three. Three cameras were chosen, including a color camera, monochromatic camera, and microbolometer for infrared imaging. The bio-fluorescence sensor was chosen to detect bioluminescence, which might indicate the presence of life [127]. Two important parameters, water temperature and conductivity, are measured with a thermistor and a sea water electrode, respectively. The remaining instruments were chosen because they provide additional scientific data at relatively low energy and mass costs. This package would be suitable if the hydrobots are designed with capable power sources. Of the three packages, Package 3 has the highest scores in the sensor science traceability matrix shown in Table 6.6.

Table 6.3: Instrument package 3

Instrument	Measurement
3-CCD color camera	Optical
Backscattering type sensor	Turbidity
Bio-fluorescence sensor	Bioluminescence
Electrode	Oxidation reduction potential
Gas chromatography	Composition
Glass electrode	pH
Ion selective electrode	Activity of free ions
IR Microbolometer	Infrared optical
Magnetoresistive vector magnetometer	Magnetic field
Monochromatic CCD camera	Optical
Phosphorescence type sensor	Dissolved oxygen
Photodiode	Quantum
Polarography	Analyte oxidation
Practical salinity type sensor	Salinity
Sea water electrode	Conductivity
Semiconductor pressure sensor	Depth
Spectrophotometry	Reflection properties
Thermistor	Temperature
Transmissometer	Extinction coefficient
Estimated mass (kg):	18.47
Estimated power requirement (W):	37.37

6.4.2 Package 2

Table 6.4 lists the sensors of Package 2. This package is the same as Package 3 except some of the heavier sensors are excluded, such as the spectrophotography instrument and the gas chromatography instrument. In removing these instruments, the mass and power requirements are greatly reduced. Package 2 would be a reasonable payload for a modern day underwater glider. Thus, for the Europa mission, it could be included on hydrobots commensurate with modern day gliders. Due to the reduction in sensors in this package, it compares less favorably with Package 3 in Table 6.6.

Table 6.4: Instrument package 2

Instrument	Measurement
3-CCD color camera	Optical
Backscattering type sensor	Turbidity
Bio-fluorescence sensor	Bioluminescence
Electrode	Oxidation reduction potential
Glass electrode	pH
Ion selective electrode	Activity of free ions
IR Microbolometer	Infrared optical
Magnetoresistive vector magnetometer	Magnetic field
Monochromatic CCD camera	Optical
Phosphorescence type sensor	Dissolved oxygen
Photodiode	Quantum
Polarography	Analyte oxidation
Practical salinity type sensor	Salinity
Sea water electrode	Conductivity
Semiconductor pressure sensor	Depth
Thermistor	Temperature
Transmissometer	Extinction coefficient
Estimated mass (kg):	7.77
Estimated power requirement (W):	6.97

6.4.3 Package 1

Table 6.5 lists the sensors chosen for Package 1, the most basic sensor package. It contains many of the instruments from Package 2 except for the color camera, infrared microbolometer, and the transmissometer. These instruments are not essential for the basic mission and, of all such instruments in Package 2, they had relatively high mass requirements. Package 1 is suitable for small gliders because of the overall estimated mass and power requirements. Predictably, this package compares worst of the three in the science traceability matrix as indicated in Table 6.6.

Table 6.5: Instrument package 1

Instrument	Measurement
Backscattering type sensor	Turbidity
Bio-fluorescence sensor	Bioluminescence
Electrode	Oxidation reduction potential
Glass electrode	pH
Ion selective electrode	Activity of free ions
Magnetoresistive vector magnetometer	Magnetic field
Monochromatic CCD camera	Optical
Phosphorescence type sensor	Dissolved oxygen
Photodiode	Quantum
Polarography	Analyte oxidation
Practical salinity type sensor	Salinity
Sea water electrode	Conductivity
Semiconductor pressure sensor	Depth
Thermistor	Temperature
Estimated mass (kg):	3.44
Estimated power requirement (W):	1.47

6.4.4 Science Traceability Matrix of Sensor Packages

A science traceability matrix, analogous to that described for the complete mission in Chapter 4, was devised to compare the advantages of each package. The matrix is shown in Table 6.6. To summarize the instrument packages, Package 3 offers the most scientific return, but it also has the highest mass and power requirements. These requirements would be unreasonable for today's gliders. Package 2 has greater mass and power requirements than typical modern-day glider payloads, but not by much. It would likely be quite viable in the EUROPA mission. Package 1 would be a feasible package for a current glider, in terms of the mass and power requirements. It is a light package that still offers a considerable science return and could be incorporated into one or more small hydrobots.

6.4.5 Data Rate

Downlink is a predominant constraint on the use of the sensors. Since there is a limit on how much data can be sent back to Earth, the measurement frequency would need to be carefully considered for each instrument. Measurement frequency may need to be lowered for low-priority sensors or sensors that yield large amounts of data. Alternatively, advanced filtering algorithms and machine intelligence might be used to reduce high-volume data into essential scientific information.

Table 6.6: The science traceability matrix based on sensor packages. The scores and corresponding coloring is explained in Table 4.1.

Goal	Objective	Investigation	Instrument Packages		
			1	2	3
Study the environment on Europa, looking for signs of life.	Biology	Determine if the European environment is conducive to life.	3	4	5
		Look for favorable distributions of carbon, hydrogen, oxygen, nitrogen, sulfur, and phosphates	4	5	5
		Categorize the nature of life. This is a broad classification and essentially looks for how life, if it exists, gets the energy required to live	3	4	4
		Determine the biological processes, this is a refinement of the previous objective. This looks at the details of the biological processes	2	3	3
		Locate organisms. This objective, unlike the previous objectives, cannot be accomplished remotely.	3	4	5
	Ocean Mechanics	Water Composition at various depths. Measurements include salinity, pH, and trace elements	4	4	5
		Acquire additional data regarding the amplitude and phase of gravitational tides, induction response from the ocean, surface motion.	3	3	4
		Basic properties. This objective is to simply take basic measurements of the physical properties at various depths. It simply provides better context for other measurements.	3	4	5
		Ocean floor. Investigate the ocean floor, specifically how it affects the ocean.	2	3	4
	Ocean Floor	Further investigate the moon's dynamical rotation state	3	3	3
		Collecting information about the topology of the ocean can determine the general active geological processes. For example, volcanoes have a distinctive effect on the topology in a region larger than the neighborhood of the volcanoes	3	4	5
		Locate specific on-going geological processes (e.g. hydrothermal vents). This will inform the search for life as organisms will likely be near these features.	2	3	3
		Determine the distribution of features to give a better context of the on-going processes	2	4	5
		Study the specific composition and mineralogy of the ocean floor	2	3	5
	Chemistry	Characterize organic and inorganic chemistry in the ocean, specifically looking for indications of an environment conducive to life	3	4	4
		Investigate the relationship between composition and geological processes, particularly looking for communication with the interior	3	4	5
		Further investigate the effects of radiation on the surface chemistry	0	0	0

6.4.6 Sonar

Another important element of the mission is the use of acoustic sensing for mapping and navigation purposes. Prospective technologies run from a basic sonar ranging device, to a Doppler velocity log for water- and ground/ice-relative velocity, to sidescan sonar for imaging purposes. Besides using these devices for navigation, hydrobots carrying acoustic sensors could gather scientific information about the ocean floor and ice-ocean interface. Underwater gliders are already being used to examine the underside of icebergs by using basic sonar altimeters [29]. A critical concern on Europa would be the background acoustic field. Any acoustic sensing system would need detect and adapt appropriately to the ambient environment.

Chapter 7

Design Alternatives

In this chapter, the authors consider the various phases of a mission to penetrate Europa's ice and explore the underlying ocean. A discussion of current state-of-the-art technologies is provided followed by an evaluation of the design alternatives based upon knowledge of current technologies.

7.1 Transit and Landing

Getting to Europa may be the riskiest part of the mission, but launch vehicle failures and the like are unavoidable risks for any mission. Fortunately, the engineering requirements for the transit phase are well understood and there have been many successful planetary exploration missions. Space launch technology is improving, as highlighted by the development of the SLS launch vehicle by NASA and commercial systems such as the Falcon Heavy by SpaceX. Orbit transfer technology is also improving, with higher efficiency thrusters and advanced trajectory planning algorithms. The authors consider total system mass as a critical design parameter, but impose no upper bound on this parameter in considering the various architectures.

Beyond the well understood challenge of getting to Europa, there is the unprecedented challenge of landing on Europa. NASA and other space agencies have landed a wide variety of probes on moons and other planets. For thick atmospheres, these probes have generally used some form of aerobraking (e.g. parachutes) to slow the descent. Aerobraking is not feasible on Europa, however, as it has very little atmosphere. There are three categories of landing that are feasible for Europa: soft, hard, and impact. Impact involves the use of a high-velocity impactor to penetrate the surface (either partially or completely). Such an impactor would experience extreme deceleration during penetration, placing extremely restrictive structural requirements on any scientific equipment. Moreover, an impactor would be unlikely to penetrate more than a few meters into the ice [128, 129]. While there are scientific benefits, such as exposing buried elements within the resulting debris plume, only hard and soft landings have the potential to deliver a sophisticated exploratory probe. A hard landing involves a "free fall" descent from orbit with a cushioned impact. One such strategy is the "stop-and-drop" descent in which the lander enters a low orbit (periapsis at a few kilometers) and fires thrusters to reduce the orbital velocity to nearly zero. The spacecraft

falls to the planet where the impact is cushioned, for example, by inflatable air bags. An impact speed less than 100 m/s would result in an impact deceleration of less than 600 g [130], however this may also be too severe for the proposed Europa mission. A soft landing is the most complex, but offers the greatest likelihood of successfully delivering a sophisticated exploratory system. The Phoenix mission to Mars is a recent example of a soft landing. The lander used an aeroshell and parachutes during entry, but eventually fired thrusters for a controlled descent to the surface at a low rate. While aerobraking would be useless on Europa, thrusters would be an effective means of arresting descent. Another example of a soft landing that is directly applicable to the EUROPA mission was repeatedly demonstrated by the Apollo Lunar Module. The Lunar Module used an array of thrusters to hover over and softly land on the surface of the moon. Powered landings can produce an arbitrarily slow descent, allowing for the delivery and deployment of sensitive equipment. The thruster and fuel tanks can be sized to allow for a large landing mass. The recent Mars Science Laboratory mission, for example, landed a nearly 1 metric ton rover softly on the surface of Mars using a partially-powered descent [131]. The Apollo Lunar Modules landed over 16 metric tons on the lunar surface [132]. The soft powered landing is the preferred landing option for the proposed EUROPA mission.

The number of spacecraft and landers is an important mission parameter, as elaborated in Section 8.1. Increasing the number of transit spacecraft increases reliability without greatly increasing complexity, but this significantly increases mission cost. Building a second, identical mission system, for example, doubles the cost with minimal affect upon complexity. Conversely, a single spacecraft may be used to deploy multiple landers, increasing complexity, but with reduced impact on cost. Varying the number of spacecraft involves a tradeoff between robustness and cost.

7.1.1 Launch Vehicles

As mentioned earlier, there are two space launch options on the horizon for a large, monolithic interplanetary mission: commercial launch vehicles and the SLS. It is assumed here that such an asset would be available at the time of the EUROPA mission; this analysis is based upon publicly available performance estimates for these space launch technologies. The largest commercial rocket currently under development is the Falcon Heavy designed by Space Exploration Technologies, Corp. The first flight of the Falcon Heavy is expected to occur this year. The Falcon Heavy is capable of launching 53 metric tons of cargo to Low-Earth Orbit (LEO). This is approximately twice the payload capacity of the Space Shuttle [133]. The largest launch vehicle in development, the SLS, is planned to be developed in two stages. Initially, the SLS will have the capability of launching 70 metric tons to LEO, but will evolve the capability to launch as much as 130 metric tons to LEO [61]. The smaller SLS launcher would be capable of delivering over 10 metric tons to Europa [61]. The Prometheus project study [134] evaluated launch vehicles for the 16.4 metric ton (dry mass) Jupiter Icy Moons Orbiter spacecraft and concluded that the super-heavy lift (later SLS) capability was necessary for a single-launch scenario.

7.1.2 Landing Systems

For this mission, four landing system options are considered: the sky-crane, an airbag, a legged landing, and a stop-and-drop landing. The least complex of these is the stop-and-drop option, where the lander performs a de-orbit maneuver and falls ballistically to the surface of Europa. This fall may be cushioned using air-bags, crumple-zones, or other impact energy absorption devices, but it would undoubtedly involve a high impact speed with the potential to damage the payload.

The next option is an air-bag based soft landing system. This involves the spacecraft performing a controlled descent from orbit and coming nearly to rest about 10 meters above the surface [135]. At this point, large airbags inflate and the spacecraft falls to the surface. Bouncing may occur, which would affect landing precision, but this approach was successfully demonstrated by the Mars Pathfinder and Mars Exploration Rover (Spirit and Opportunity) missions [135].

The other landing systems (sky-crane and legged lander) are similar to each other. Legged landing systems involve the spacecraft controlling its descent from orbit and landing on the surface using shock-absorbing legs. In this approach, the landing surface should be nearly level. Since the arresting thrusters fire close to the surface, they may cause any loose debris fly up and pose a hazard to the lander. This problem can be mitigated by cutting off the thrusters prior to touchdown, but this increases the impact speed. There is also the risk of contaminating the environment with combustion products. Examples of spacecraft that utilize legged landing systems are the Apollo Lunar Modules [136] and the Viking [137] and Phoenix lander [138], which landed on Mars. Sky-cranes were created to improve on both legged and airbag landing systems. Sky-cranes descend similarly to legged landers, but hover a few tens of meters above the surface. The main lander is gently lowered to the surface by the hovering crane, which then flies away to impact the surface well away from the lander. Though it is mechanically complex, the sky-crane provides for a softer landing than other systems [135].

7.2 Surface Operation

Surface operation involves two primary tasks: initiating the descent of the cryobot and establishing a node in the communication chain from Europa to Earth. Since the surface unit remains on or near the surface, it can collect some scientific data that the cryobot and hydrobots may be unable to gather. For example, the surface unit would measure the radiation flux on the surface of Europa over the life of the mission. As stated in Section 3.1.3, the radiation dose falls by about six orders of magnitude within the first meter of ice, so only a device very near the surface could collect information about the radiation environment on Europa. There are also several measurements that should be taken from a stationary platform near the surface, like seismography. For this reason, it is helpful to have a robust system on the surface of Europa that can collect data.

For radiation protection, the surface unit could bury itself below the surface to eliminate the need for extra shielding, but this would require a mechanism for burrowing into the ice. This burrowing process would be executed during the initial descent of the cryobot. The surface would also serve as a node in the communication network that relays data between the robots and Earth. The surface

unit must also transmit any scientific data that it collects, such as radiation flux. Variations in the number of surface units are considered in Section 8.1.

7.2.1 Importance of RPS in Lander

A 2006 mission architecture study for a lander on Europa showed the value of using a radioisotope power source (RPS). Figure 7.1 compares RPS with battery power for a lander, illustrating the advantage of RPS for long term missions [18]. While batteries would be more effective for a mission of a few days, an RPS in the 1-3 W/kg range could power the system more effectively over longer periods. As detailed in Section 6.3.1, analysis suggests that RPSs are capable of specific powers in excess of 9 W/kg.

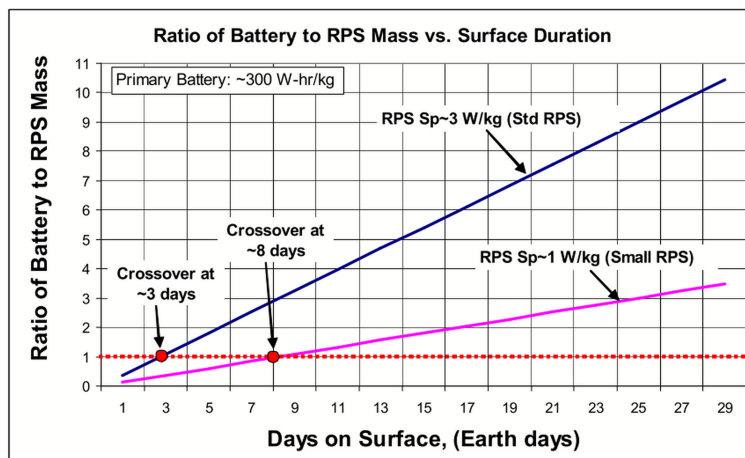

Figure 7.1: From 2006 mission architecture study [18]. Radioisotope power is preferable to battery power for a European lander.

7.2.2 Technology Needs for Lander

The 2003 Europa Lander concept study found the following technology needs for a lander system on Europa [139].

1. *Radiation-hardened equipment:* There is a need for space-ready, radiation-hardened electronics. Other non-electronic components must be designed to function in Europa's radiation environment.
2. *Surface sampling instruments:* Devices for sampling at or near the surface would provide valuable scientific data. According to the study [139], such devices should include a coring device to obtain samples within the top 1 meter below the surface, a mechanism for distributing samples to other analytical devices, a chamber for melting water, and a sample purification system.

3. *More efficient instrumentation:* Weight and power requirements of existing analytical hardware should be improved while preserving or improving capability.
4. *Robust landing system:* The surface of Europa is hazardous. The landing system must identify and avoid hazards while landing autonomously.
5. *Improvement in propulsion technologies:* Propulsion systems account for a significant portion of launch mass. Improvements will lower launch mass and/or enable additional scientific hardware. (In the study that was cited, propulsion systems accounted for more than 80% of launch mass.)

The concept study's main goal was similar to EUROPA's – to determine whether Europa's environment could support life. The Europa Lander would also investigate the under-ice ocean, so the analysis and conclusions in the 2003 study are quite relevant to the present study [139].

7.2.3 Communication

There are several well-understood means of transferring data from the surface of Europa to Earth. The first method is standard radio communication, either using a relay satellite(s) or transmitting directly to Earth (when feasible). A more modern method involves the use of lasers. Laser communication allows for higher data transfer rates than traditional radio-based communication systems, but the signals are highly directional. Regardless, NASA demonstrated this technology in transmitting an image of Leonardo da Vinci's *Mona Lisa* to a spacecraft orbiting the Moon [140]. Laser communication between the surface unit and a relay satellite may prove faster, and more efficient than radio frequency communication. In fact, laser communication has been demonstrated at interplanetary scales. During its journey to Mercury, the MESSENGER probe demonstrated two-way laser communication over a distance of 24 million km. It achieved this, not using a dedicated laser communication system, but using the laser altimeter already on-board MESSENGER [141].

7.2.4 Science

The surface unit is limited in the science that it can conduct. Because it would not penetrate deeply into the ice, scientific sampling would be confined to landing site. The surface unit could take measurements to improve mankind's understanding of the mechanics of the ice crust. It could also provide data about the ice chemistry, providing some context for the chemistry well below the surface.

7.3 Ice Operation

The system responsible for descending through and investigating the ice crust is the cryobot. Although the hydrobots are carried through the ice, they remain dormant during descent; the cryobot carries its own dedicated science payload. For simplicity, only cylindrical cryobots with circular

cross-sections are considered. It is assumed here that these cryobots use melt probes with recirculating meltwater jets. As described in Section 6.2, this approach is effective and exhibits higher mechanical reliability than alternative methods, such as drills.

7.3.1 Payload Capacity

The payload capacity of the cryobot depends on the cryobot volume. Thus, payload volume increases with the square of the cryobot diameter, but so does the descent time (see Section 7.3.3). The payload volume scales directly with vehicle length, and the cryobot’s length has only a marginal effect on its burrowing performance. Greatly increasing the length creates structural design challenges, however. Existing and proposed concepts have exhibited a length-to-diameter ratio as high as 10 [112].

7.3.2 Power Source

As discussed in Section 6.3.1, there are only two practical power sources for the cryobot: fission reactors and RHUs. Figure 7.2 shows the possible masses and thermal powers at launch of cylin-

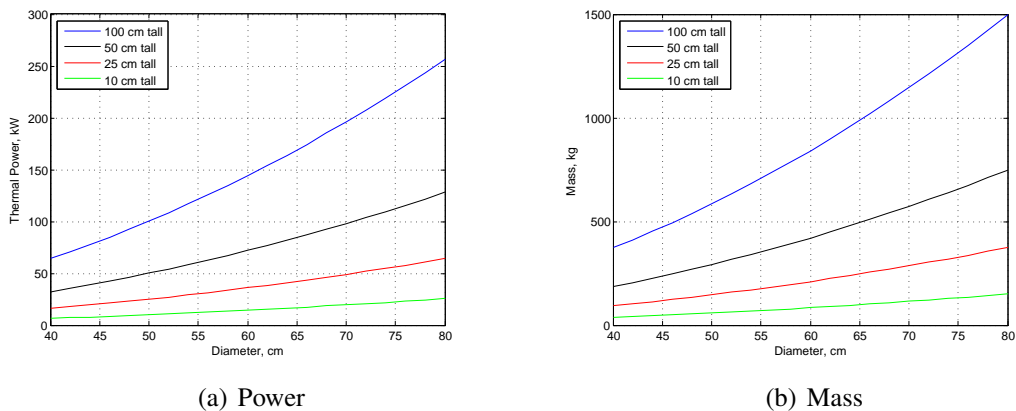

Figure 7.2: The mass and thermal power cylinders of varying diameter and different heights made of GPHS modules. Note that GPHS modules are parallelepipeds, so this is approximated as a cylinder with mass and power densities equivalent to GPHS modules.

ders made of the GPHS modules described in section 6.3.1. Note that the power will be less when the cryobot begins its descent due to the decay of the radioisotopes during transit. Even for a relatively small RHU (a cylinder 40 cm diameter and 50 cm tall), thermal powers in excess of 30 kW are possible. This cylinder would displace less than 200 kg of water. A larger cylinder (70 cm diameter and 100 cm tall) would have a thermal power of about 200 kW and a displaced mass of 1200 kg. The sizing ignores the fact that GPHS modules are parallelepipeds and that there will be additional structure and components (e.g. heat pipes). Both of these factors reduce the thermal power of the RHU, but effective design, such as reshaping the GPHS modules and incorporating heat pipes into the module casings, would minimize these losses. Other radioisotopes besides the

plutonium used in the GPHS may produce greater power, but the long transit phase of this mission requires a long-lived source.

Fission reactors, the other potential power source, produce far more thermal power for a given size and mass than RHUs. Comparing the SAFE-400 reactor (a cylinder 50 cm in diameter and 60 cm long), which produces 400 kW of thermal power, to a similarly-sized RHU, one finds the fission reactor produces more than five times the thermal power with comparable mass (a few hundred kilograms) [118]. The mass and power of this RHU can be inferred from Figure 7.2. Fission reactors are also safer before and during launch because their radioisotopes are relatively stable compared to those used by RHUs [117]. Fission reactors also can be “stored” during transit without losing capability, unlike RHUs which lose thermal power at a constant rate from the time they are fabricated. While fission reactors present an attractive alternative to RHUs, they are not as well-developed. There are no current plans to test nuclear reactors on spacecraft and their development for this specific mission would likely take a decade [119]. The RHU, in contrast, is essentially an “off-the-shelf” technology.

***In-situ* Power Resources**

Once the cryobot has penetrated the ice shell and entered the ocean, a new form of power becomes available. Anchored to the ice, the cryobot will experience the tidal flows that move across the ice-ocean interface [53] and could tap the energy of this flow to generate electricity. This would be a potentially very long-lived source of power, and a design that used a suspended portion of the cryobot itself to catch the tidal flow would require little extra equipment. The water pump could conceivably be reversed to act as a generator, and power from this system stored in batteries or capacitors.

7.3.3 Descent Time

The descent of melt probes is discussed in Section 6.2. Analysis of a melt probe’s “instantaneous” performance informs the design of the probe, but does not immediately determine how long the cryobot will take to penetrate the ice, the descent time. Aside from the physical properties of the ice and the size and melting power of the cryobot, a primary parameter affecting descent time is the temperature profile of the ice with depth.

In order to determine the descent time, one must integrate the descent rate which varies with depth. Since it has been shown that the introduction of recirculating water jets to induce a turbulent layer of melt water produces performance that is accurately modeled by Equation (6.8), Equation (6.8) is used to compute the instantaneous descent rate using Euler’s method. To simplify the calculation, the ice is assumed to have constant properties, listed in Table 7.1. These properties represent approximate values for nearly-pure ice; in reality, they will vary throughout the ice due to variations in other properties, such as pressure.

Two temperature profiles are considered for comparison: a linear profile and a multistage linear profile. Both of these profiles assume 10 km thick ice. This thickness is somewhat arbitrary, but is

Table 7.1: Properties of the ice used for calculation of the descent time [33]. These are assumed to be constant throughout the ice.

Property	Value	Units
Heat of Fusion	330	kJ/kg
Melting Temperature	273	K
Specific Heat Capacity	2.2	kJ/kg/K
Density of Ice	920	kg/m ³

physically realistic based on earlier analysis of Europa and provides a reasonable value for analysis. The descent time and linear temperature profile are shown in Figure 7.3 The temperature profile is

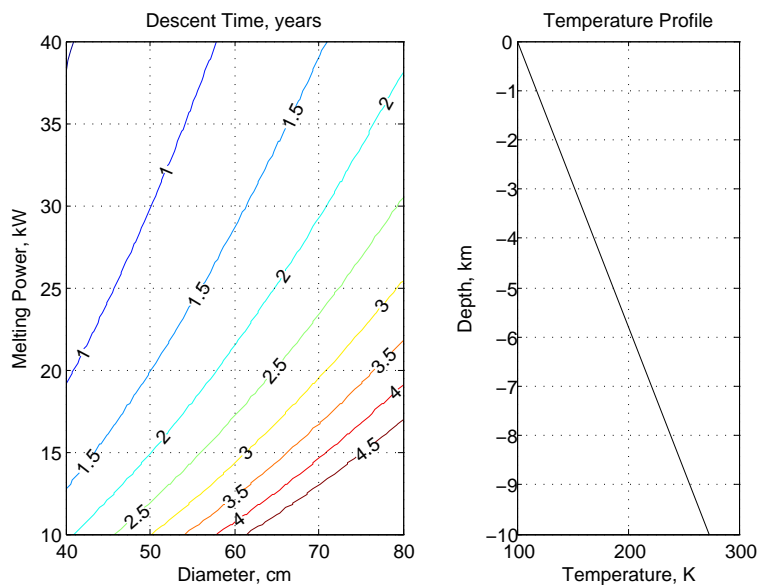

Figure 7.3: Descent time and temperature profile for a linear profile in 10 km thick ice. The ice has constant properties listed in Table 7.1.

a linear change from 100 K at the surface to 273 K (the melting point of water over a large range of ambient pressure) at the bottom of the 10 km thick ice sheet. The descent times shown in Figure 7.3 are calculated using the method previously described. The diameters listed represent practical sizes of the cryobot, with a 40 cm diameter representing a small cryobot, about the diameter of current underwater gliders, and an 80 cm diameter representing a very large cryobot. The smaller cryobot would be capable of carrying a single standard sized hydrobot or several smaller, less capable hydrobots, while the larger cryobot is capable of carrying multiple standard sized hydrobots. The powers are representative of the thermal power of RHUs based on the GPHS. If a fission reactor is used, the melting power could be an order of magnitude greater, meaning that even a large cryobot could penetrate the ice in a few months or less. Even without a fission power source, however, a large cryobot would be capable of penetrating the ice in less than two years. This temperature profile is conservative because the ice will likely get warmer faster near the surface, due to the presence of a convecting layer in the ice [142].

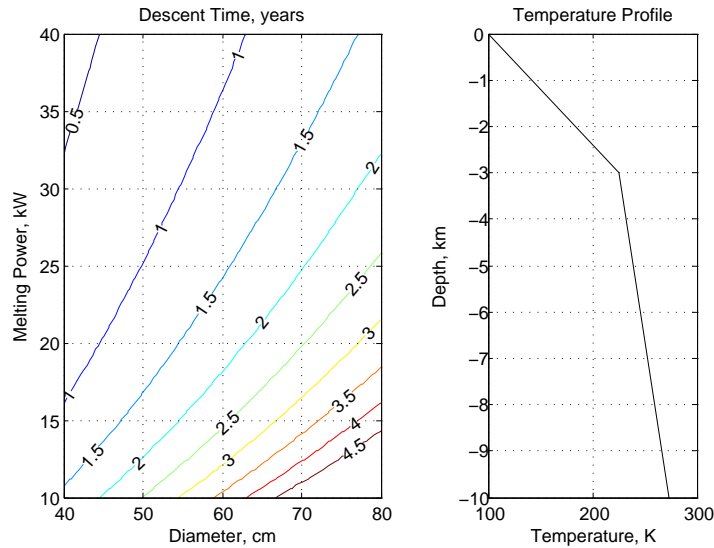

Figure 7.4: Descent time and temperature profile for a two-step linear profile in 10 km thick ice. The ice has constant properties listed in Table 7.1.

The effect of a convecting sublayer is shown in Figure 7.4, which incorporates a two-step linear profile. The ice has a temperature of 100 K at the surface and decreases at a constant rate to reach a temperature of 225 K at a depth of 3 km. The temperature then increases at a new constant rate until it reaches the melting temperature of water (273 K) at a depth of 10 km (the assumed ice thickness). It can be immediately seen that, for a given size and power, the descent time of the cryobot decreases with this multi-step profile compared to the linear profile shown in Figure 7.3. The cryobot penetrates the ice faster.

7.3.4 Communication

When considering communication with the cryobot, there is one primary design choice; whether or not to utilize the surface unit as a relay. If the cryobot does not utilize the surface unit as a relay, it must either communicate directly to Earth or to a relay satellite(s). Ice is permeable to a narrow band of radio frequencies, so it is feasible to communicate through ice [142].

If the surface unit is used as a relay, one may either communicate between the cryobot and surface unit directly or utilizing ice-embedded transceivers. If the cryobot communicates directly with the surface unit, there are three viable design choices: radio, acoustic, and tethered communication. As previously stated, ice is permeable to some radio frequencies (enabling radio communication) and can transmit sound (enabling acoustic communication). It is also possible to embed a data-tether in the ice during the descent of the cryobot, enabling very high-speed communication, similar that of current computer networks. This tether would have very low mass. One kilometer of tether can have a mass of less than half of one kilogram, so ten kilometers would have a mass of less than 5 kilograms [143]. These three modes of communication are also viable means of communicating between ice-embedded transceivers. It is also possible (and advisable) to provide more than one

mode of communication between the cryobot and the surface unit. For example, the cryobot could deploy ice-embedded transceivers as a backup for an unspooling data tether during descent. In the event that the tether is severed, the nearest ice-embedded sensors could bridge the gap via acoustic or radio communication.

Ice-embedded transceivers can be made compact and durable with current technologies. A basic transceiver would consist of transmitting and receiving radio systems, memory storage, a simple computer, and a radioisotope heater with a thermoelectric power converter. Additional capacitors could provide additional power for high-speed burst communication. This transceiver could fit within a small package (a cylinder 10 cm in diameter and less than 3 cm in height) with a mass less than a few kilograms [142]. Comparable existing devices are capable of maintaining a 10 kHz radio frequency data channel. The transceivers would be deployed at intervals as the cryobot descends, with spacing determined by measured attenuation. Conservatively, about three dozen would be needed to span a 10 km ice sheet; two dozen would more likely suffice [142]. Having a network of distributed communication nodes embedded throughout the ice presents an opportunity for a distributed sensor network. Each of these transceivers could be equipped with a few basic sensors (e.g. thermocouples, seismographs, and hydrophones) to log data about the conditions within the ice. These transceivers could communicate using either radio or acoustic communication.

An optical tether through the ice is extremely practical. The primary difficulty with deploying an optical tether is the tidal flexing of the ice, which may be as much as 30 m per day. Over the full depth of the ice, this flexure corresponds to about 0.3% strain [76]. Using an online calculator provided by Corning Optical Fiber[144], 0.3% strain corresponds to a stress of 31 ksi. In testing 386 km of optical fiber, Corning detected no failures at less than 66 ksi [145]. Thus, it is entirely plausible to have an optical tether that connects the surface unit to the bottom of the ice and such a cable would have a mass on the order of a few kilograms, depending on the thickness of the ice [143].

7.3.5 Science

The cryobot will be the first vehicle to sample the waters of Europa, in the form of melt water created during its descent. It will also be able to directly measure the properties of the ice, including structure and seismicity. The cryobot will also help to characterize the physical communication between the surface and the under-ice ocean, which has bearing on the potential for life to exist on Europa.

7.4 Ocean Operation

7.4.1 Hydrobot Design

The hydrobot, the primary vehicle for exploring the ocean, is an essential component of the EU-ROPA mission concept. While the surface unit and the cryobot will provide important scientific

observations, the direct investigation of the ocean beneath the European ice crust will be completed by the hydrobot.

Propulsion

There are many choices for the hydrobot propulsion system. One of the most common forms of propulsion for underwater vehicles on Earth is an electric thruster comprising a motor and propeller. Streamlined survey class underwater vehicles typically feature a single propeller for thrust, along with a collection of control planes for stability and control. Inspection class vehicles, such as the remotely operated vehicles used in the oil industry, feature an array of thrusters to provide control forces and moments in several directions. Marine thrusters are extremely mature, but they require dynamic seals and exposed moving parts that are susceptible to biofouling and other forms of failure.

Because the hydrobot will be tasked with exploring the full water column (or as much of it as possible), the vehicle will require a buoyancy control system to counter the small variation in density with depth. An increasingly popular ocean profiling agent for Earth's oceans is the underwater glider. As discussed in Section 6.1, underwater gliders have the advantage of being able to propel themselves forward without exposed moving parts. Propulsion is controlled by varying the vehicle's buoyancy in order to sink or rise, establishing lift over a fixed wing in a way that results in gliding flight. Attitude control is accomplished by internal moving masses, eliminating the need for external moving parts. Underwater gliders are extremely efficient, but tend to be slow and can only maneuver in flight. They cannot stop to examine a feature of interest and even mild currents pose a hazard.

Biomimetic propulsion utilizing smart materials and structures could complement underwater glider propulsion, providing a burst of power and agility when needed without compromising efficiency during gliding flight or robustness due to internal actuation. Biomimetic propulsion utilizes materials and structures that can actively change shape, mimicking the motion of fish, marine mammals, or other animals. The performance advantages of biomimetic propulsion is a current area of intense study. Figure 7.5 shows the propulsive efficiency of several families of marine mammals in comparison to a notional propeller. This figure shows that marine mammals operate at higher thrust coefficients. Additionally, the propulsive efficiency of marine mammals remains relatively constant over a range of thrust coefficients compared to propellers, which have a sharp, distinct peak in efficiency. Note that this analysis only considers propulsive efficiency. Overall system efficiency depends on the specific implementation, though there is good reason to expect that a biomimetic propulsion system is quite efficient.

There is an important similarity in the morphology of cetaceans, with their large flapping tail flukes, and the configuration of underwater gliders, whose wing is typically mounted aft to improve pitch damping. If a hydrobot equipped with a biomimetic tail fluke fixes this tail in position to generate gliding flight during descent or ascent, it functions as an underwater glider. Marine mammals do this naturally; they swim when they need to go fast or turn quickly (e.g. while hunting) and they glide to conserve energy during deep dives, changing their buoyancy to sustain the flight. A carefully designed hydrobot could similarly take advantage of the natural profiling motion and

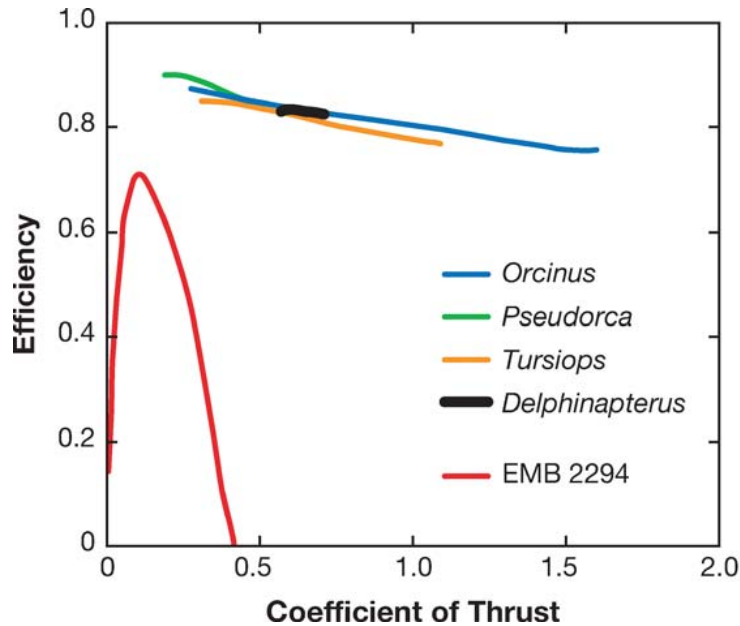

Figure 7.5: Comparison of the propulsive efficiency of marine mammals and a notional propeller reproduced from *Passive and Active Flow Control By Swimming Fishes and Mammals* by Frank E. Fish and George V. Lauder [19].

efficient transport of underwater gliders along with the agility and thrust of a biomimetic propulsion system.

Power Source

There are three options for powering the hydrobot: small RPSs, fuel cells, and batteries. The primary advantage of small RPSs is that they can provide consistent power over long periods. They are very inefficient, however. Most of the energy produced is in the form of heat and only a small fraction of this heat is converted to usable electricity (as much as 30%, but usually less than 10% [14]). While an RPS produces power over a long period of time, it may not produce a large amount of usable power at any given time. To store power for rapid discharge, batteries or capacitors can be used.

Alternatively, the hydrobot could be powered exclusively by batteries. Underwater gliders on Earth have traveled ocean basin scale distances over several months on battery power. However, it is likely that the sensor suite on a EUROPA hydrobot will consume more power than do the gliders designed for terrestrial physical oceanographic sampling. While batteries might only power the hydrobot for periods of a few weeks, they could be recharged if the hydrobot docks with an RPS-equipped cryobot. In fact, this can be done using inductive charging, an increasingly common consumer technology in devices from cellphones to toothbrushes. General Motors has posited a future vehicle/future city concept making use of inductive charging for green vehicles [146]. Inductive charging is currently used to recharge underwater vehicles responsible for monitoring a

cabled deep-ocean sensor network [147].

The final option for power is fuel cells. Fuel cells have higher energy density than batteries and can be refueled. The cryobot could carry devices that produce Hydrogen and Oxygen through electrolysis of water, powered by the RPS, and these gasses could then be used to refuel the hydrobot. Unlike batteries, fuel cells require a physical connection between the hydrobot and cryobot to transfer the fuel, as well as sophisticated plumbing.

***In-situ* Power Resources**

Hydrobots on Earth have been designed that capture thermal energy [8] for use in both power and propulsion, but this depends critically on the thermal structure of the ocean, which is highly uncertain at Europa. An alternative means of generating power is to use the tidal currents of Europa's ocean [53]. Although of uncertain magnitude and distribution, a hydrobot capable of temporarily anchoring itself to the ice or rock could harvest tidal energy by deploying fins or other means of catching the flow and driving a generator.

Navigation

The hydrobot must carry a variety of navigational devices to maintain awareness of its position relative to the cryobot base station. These devices work together to improve the measurements beyond what each system could achieve alone. The first navigation method is dead reckoning, which predicts the current location by integrating inertial measurements over time. This method results in a navigational error that accumulates with time, growing with distance traveled. Therefore, dead reckoning (without correction from some other navigational aid) is only effective over short distances.

On Earth, navigation has the benefit of utilizing GPS. While GPS is not available at depth in water, underwater vehicles often use a host of techniques to acquire GPS position, be it via a float or ascending to the surface. GPS allows for rapid and accurate localization. In the ocean of Europa this GPS luxury does not exist. It is possible to create a GPS-like system on Europa utilizing ELF radio. Unfortunately the size and power requirements of ELF transmitters preclude them from being practical for GPS-like navigation.

Acoustic positioning systems have been used for precision underwater positioning for decades. In a conventional long baseline (LBL) positioning system, a network of uniquely identifiable acoustic transponders is installed on the sea-floor at carefully surveyed positions. The transponders are acoustically interrogated ("pinged"), each in turn, by a device whose position is to be determined. With an assumed speed of sound profile (modeled or measured), the time between transmission of the interrogation signal and receipt of the response signal determines the distance to the transponder. Three-dimensional position is obtained by triangulation. To eliminate the need for surveyed, bottom-mounted transponders, the LBL concept has been adapted to make use of "gateway buoys" that continuously determine their position using GPS. More recently, this concept has been extended further using acoustic modems to provide both communication and positioning. An experimental implementation, and associated estimation algorithms, is discussed in [148].

The dual use of acoustic modems for communication and for LBL positioning has recently been demonstrated under arctic ice [149]. Data rates of 5-10 bits per second have been established over ranges between 70 and 90 kilometers.

One non-GPS method of navigating on Earth is simultaneous localization and mapping (SLAM) [150] or feature based navigation (FBN). Whenever a vehicle using SLAM receives map data (e.g., a new estimate of the vehicle-relative position of a previously mapped feature), that data is simultaneously used to update the map and the estimated position of the vehicle relative to the map. This is a computationally intensive process, but various techniques can be utilized so that it is practical for implementation on mobile robots [151]. SLAM is especially useful because it produces a map while improving navigation quality. Any vehicle that is already creating a map, e.g. a hydrobot that is exploring the topology of the ocean floor or the ice ceiling, can use SLAM for navigation. There are two primary techniques for SLAM, grid-based SLAM [152] and feature-based SLAM [151]. Feature-based SLAM creates a map of distinguishable features and uses these features to localize the vehicle [151]. As the mapped region expands, more features are added. The alternative to this is to create a complete map by generating a grid that represents the topology of the surface. This grid-based SLAM approach results in a more complete map but requires more computational power than feature-based SLAM [152]. The actual sensors are very similar for both grid- and feature-based SLAM, so the only major difference is the algorithms and the computing and storage requirements. Both grid-based and feature-based SLAM can be considered as useful tools for the EUROPA hydrobot.

7.4.2 Communication

The hydrobot has four potential modes of communication: radio, acoustic, optical, and docking. If radio is to be used to communicate through water, it will likely be ELF. ELF requires large amounts of power, massive antennas, and has an extremely low bit-rate, but transmits over great distances, potentially even relaying data back to Earth directly dependent on effectiveness through the ice-liquid interface and the ELF noise produced by Jupiter. Alternatively, the hydrobot could potentially couple with the ice, enabling more traditional radio communication to the ice embedded transceivers, the surface unit, a relay satellite, or Earth. The hydrobot might also communicate with ice-embedded transceivers or the surface unit acoustically, perhaps by mechanically coupling to the ice in order to reduce losses at the ice-ocean interface. The hydrobot is capable of using the cryobot as a relay using either radio (ELF), optical (laser), acoustic, or docking communication. As mentioned earlier, radio is not advisable because of the power and size requirements and the extremely low data rate. Optical communication has the disadvantage of being relatively short range and highly directional, but provides a high data transfer rate for video or images. Acoustic communication has a reasonable range (a few tens of km), but has a very low data transfer rate. If the hydrobot docks with the cryobot (e.g., to recharge or refuel), any common high speed wireless data transfer technique could be used to move data from the hydrobot to the cryobot, and that data could then be relayed through a physical cable through the ice to the surface.

7.4.3 Science

The hydrobot is responsible for many of the most important science tasks of the EUROPA mission and is the principle enabling technology for under-ice exploration. It will explore the ocean, collect information about the oceans, and potentially locate energy sources and life. An important part of the hydrobot's science mission is developing a map of the ocean floor and the ice-ocean interface, which would allow the hydrobot to localize any interesting features, such as a hydrothermal vent, relative to an established map, possibly shared among a collective of hydrobots. The hydrobot will also carry the equipment necessary to determine the chemical and physical properties of the ocean. Depending on the configuration, the hydrobot might also carry the equipment to collect and analyze samples from the ocean floor and the ice-ocean interface.

7.5 Evaluation of Design Alternatives

Based on the characteristics of the technologies presented in sections 7.1-7.4, design alternatives for each mission phase are considered with reference to the stated criteria shown in Figures 5.2-5.5. Each evaluation is made on a ten point scale, with ten being optimal, reflecting an assessment of the contribution each technology makes to the criterion under consideration.

7.5.1 Transit and Landing

The actual design of launch vehicles and trajectories is beyond the scope of this project. Therefore, only preliminary analysis was performed in order to determine what will be possible in the coming decades. The SLS is the best option for the launch vehicle, enabling the transport of over 10 metric tons to Europa using a direct transfer [61], a conclusion also reached by the Prometheus Project [134]. Trajectories in the Jupiter system that reduce total radiation dose, such as the "Banzai Pipeline" [20], are advantageous for this mission.

The landing system options were detailed in section 7.1.2. Lander criteria were presented in Figure 5.5. The different landing systems are compared here based upon performance criteria of environmental exposure on descent, impact energy, local contamination, mass, navigational accuracy, payload, power consumption (locomotive), power consumption (system), and robustness. Scores are assigned to each of these criteria on a 10 point scale, then multiplied by the criteria weight per the value system design given in Tables 5.8 and 5.9 to arrive at a total score.

One potential alternative is the stop-and-drop landing system. This consists of a de-orbit maneuver followed by a ballistic descent resulting in a high velocity landing. The high speed impact and lack of contact with the surface prior to the impact means that the spacecraft will have only minimal exposure to the environment during descent, earning a score of 10. The impact may be cushioned, but the spacecraft will encounter extreme deceleration, potentially causing damage. The main drawback of a stop-and-drop lander is the high impact energy, so the spacecraft earns only a score of 1. This high impact event also carries a risk of local contamination, thus resulting in an assigned score of 5. Since this is a very basic landing system, it has very low mass requirements earning a

score of 10. It is straight forward to model a ballistic trajectory from orbit to the surface accurately, so the spacecraft will be able to land very close to the desired landing site, although the spacecraft will not correct its trajectory during descent. Therefore it scores an 8 for navigational accuracy. Since all components have to be built to sustain impact, they will be made stronger, and therefore likely more massive which presents a limit on the payload mass. Therefore the payload capacity scores a 1. For a stop and drop lander, power requirements are minimal earning scores of 10 both locomotive and system power consumption. Even if impact absorbing devices are used, there is a high likelihood that the lander will sustain damage on impact, thus the robustness also scores a 1.

Airbag landing systems result in much softer landings than a stop-and-drop lander. The descent velocity of the spacecraft is brought almost zero above the surface, and the lander is left to fall a few tens of meters to the surface and its fall is cushioned by airbags. Since the lander will bounce several times on the surface, it will be significantly exposed to the environment, so environmental exposure earns a score of 5. This landing, while not particularly soft, is significantly softer than the stop-and-drop lander. Therefore it earns a score of 7 for impact energy. The rockets that slow the descent may deposit some contaminants on the surface, but they stop firing a few tens of meters above the surface which limits local contamination, earning a score of 7. The airbags are light compared to the fuel needed for a fully controlled descent, so the airbag lander earns a score of 7 for mass. While the descent is controlled, the lander may bounce for a long distance, limiting the navigational accuracy of the lander. Therefore airbag landers only earn a score of 3 for navigational accuracy. The airbags have a maximum payload mass of a few hundred kilograms, so the payload capacity only earns a score of 5. The power requirements of this system are modest, requiring flight computers and rocket motors, so it earns a score of 7 for power consumption for both locomotion and other systems. The lander bounces uncontrolled, which leads to the situation where the lander may become stuck on terrain or airbags may burst may cause the lander to fail. These are unavoidable single points of failure, so the robustness only earns a score of 6.

Legged landers use rockets, either variable thrust or pulsed thrusters with high duty cycles, so slow the lander's descent and land softly. Near the end of the descent, the thrusters will likely create a small cloud of debris from the surface, so the lander will be suspected to environmental exposure during its descent, earning it a score of 5. Despite the desire to land softly, the rockets are turned off close to the surface (less than a few meters) and the lander falls freely to the surface. This impact is absorbed by the lander's legs. Thus, the legged lander earns a score of 9 for impact energy. The thrusters will be operating near the surface, so they will likely contaminate the surface, thus the legged lander only earns a score of 5 for local contamination. Legged landers do need to carry large amounts of fuel and have shock-absorbing legs, so it earns a score of 6 for mass. The descent is controlled continuously except for the last few meters and the velocity over these last few meters is low, so the navigational accuracy earns a score of 10. The legged lander is capable of carrying very large payloads, so it earns a score of 10 for payload capacity. The power consumption for controlling the descent is fairly modest, but the avionics sensors may require significant power, earning the power consumption for locomotion a score of 5, while the other systems consume only nominal power, earning a score of 6. The lander can be designed to allow for multiple failures, so its robustness also earns a score of 10.

The final landing technology considered here is the sky-crane. A sky crane consists of a chassis that carries rockets. The rockets are used to slow the descent and hover a tens of meters above

the surface. The chassis then lowers the actual lander to the surface on cables. Only a slowly lowered lander approaches the surface, so there is minimal environmental exposure on descent, earning a score of 10. This results in a very soft landing, so the impact energy earns a score of 10. The rockets do not fire near the surface, so there is minimal contamination of the surface, earning a score of 8. The sky-crane is more massive than the legged lander because it must have two independent chassis (the lander and the chassis with the rockets) and the mechanisms for operating the sky-crane, so it earns a score of 4 for mass. The sky-crane is capable of very precise landings, so it earns a score of 10 for navigational accuracy. Despite being operating essentially the same as a legged lander, the sky-crane carries extra mass for the chassis that carries the rockets and crane mechanism. Therefore, the payload only scores a 7. The power consumption for locomotion for the sky-crane is the same as for the legged lander (a score of 5), but the sky-crane has an additional system (the crane), so it earns a score of 4 for power consumption of other systems. While the rockets and thrusters can be made redundant, the additional of the sky-crane introduces a singular point of failure, so the sky-crane only earns a score of 6 for robustness.

The results of this evaluation are shown in Table 7.2. Each criteria score is multiplied by the criteria weight to arrive at a total score. The stop-and-drop and airbag landers both score poorly, but the legged lander and sky-crane both score comparably well. The legged lander scores better primarily due to its better reliability, and is bolded. This assessment is a preliminary analysis; further study is warranted to justify these evaluations.

Table 7.2: Results of the evaluation of the landing system technologies.

	Environmental Exposure on Descent	Impact Energy	Local Contamination	Mass	Navigational Accuracy	Payload	Power Consumption (L)	Power Consumption (S)	Robustness	Total Score
<i>Criteria Weight</i>	<i>0.42</i>	<i>3.06</i>	<i>2.60</i>	<i>0.90</i>	<i>2.20</i>	<i>2.31</i>	<i>0.42</i>	<i>0.33</i>	<i>1.04</i>	
Stop and Drop	10	1	5	10	8	1	10	10	1	57.71
Airbags	5	7	7	7	3	5	7	7	6	77.66
Legged	5	9	5	6	10	10	5	6	10	107.62
Sky-Crane	10	10	8	4	10	7	5	4	6	107.03

7.5.2 Surface Unit

The design space of the surface unit is comparably limited. It must maintain a communication link with Earth, start the descent of the cryobot, and collect scientific data. The primary constraint is the lifetime of the surface unit. As a radiation mitigation strategy, a portion of the lander will be buried a few meters below the ice. The mechanism for starting the descent of the cryobot will require manually lifting the cryobot and placing the hot point against the surface of the ice. All components of the surface unit that are not required to be on the surface, e.g. computers, data storage, and seismometers, will be buried, while only components that must be left on the surface, e.g. star trackers, will be left on the surface. Given this collection of constraints, the greatest flexibility arises in communication structure.

Communication

The primary communication options are laser and radio. Lasers require precise directional control to communicate with Earth or relay satellites because of the narrow beam of the laser. Presuming that the communication infrastructure on Earth is comparable for radio or laser communication, that is, there are roughly the same number of transmitting/receiving stations (ground or space based) accessible for this mission for both radio and laser communication, access duration and frequency for laser and radio communication are very similar. The primary caveat is that laser communication may be blocked obstacles such as clouds above the laser receiver and transmitter on Earth. Therefore, while radio communication earns a 10 for both access frequency and duration, laser communication only earns a score of 8. Laser communication is capable of data transfer as much as 10 to 100 times faster than radio communication [153]. In 2016, NASA plans to demonstrate the capability of data transfer rates well in excess of 1 Gbit per second (GBps) [154]. Most modern wired internet connections have a maximum speed of 1 Gbps, with typical internet speeds more than 10 times lower. Therefore, laser communication earns a score of 5 for average data rate and a score of 10 for peak data rate, which may be power intensive [153] while radio communication, being 10 to 100 times slower, earns a score of 1 in both categories. As evidenced by current spacecraft spacecraft, LRO [154] and MESSENGER [141], being able to use on-board systems dedicated to other tasks to communicate with Earth, the power requirements are very modest for laser communications. NASA will attempt to demonstrate this with the Laser Communications Relay Demonstration (LCRD), scheduled for launch in 2016. LCRD is not designed to be an independent spacecraft, instead it is designed as a payload on a commercial satellite and NASA notes that the system uses less power than radio systems[153]. Therefore, the laser communication earns a score of 10 for power consumption, while radio communication only earns a 5. The mechanism to point a laser precisely is more complex than the mechanism to orient a radio antenna, but the actual mechanical robustness is comparable. Therefore, the radio communication earns a robustness score of 10, but laser communication earns a score of 8.

The value system is applied to these ratings, which is shown in Table 7.3. Laser communication earns a higher score primarily because of its increased data transfer rates and reduced power consumption compared to radio communication. Despite the fact that it is less robust, as it requires a more precise pointing system, the benefits of laser communication make it a superior design alternative to radio communication.

Table 7.3: Results of the evaluation of communication design alternatives for the surface unit.

	Access Duration	Access Frequency	Average Data Rate	Peak Data Rate	Power	Robustness	Total Score
<i>Criteria Weight</i>	1.49	1.31	1.47	0.35	1.62	2.70	
Laser	8	8	5	10	10	8	71.05
Radio	10	10	1	1	5	10	64.92

7.5.3 Cryobot

Attitude Control Devices

The performance of the cryobot will be considered before other design categories. The first design feature is the attitude control mechanism. As previously stated there are two primary methods of attitude control: active and passive mechanisms. Of the active mechanisms, there are three options: differential heating along the hot point, the body, or both. The passive mechanisms are pendulum and mercury steering. There is another option, no attitude control, which will be considered as a reference point. These will be evaluated in terms of the value system described in Section 5. The attitude control mechanism directly effects the robustness, the power consumption for locomotion, the mass, and the attitude control of the cryobot. It effects the robustness in that, if a passive mechanism is used, the cryobot may become stuck on impassible debris.

Having no attitude control device has benefits of having no mass and consuming no power (and therefore receiving scores of 10 for mass and power consumption), but is not robust nor can the cryobot control its attitude. That is, the cryobot can neither navigate around debris, nor correct its attitude if it begins to topple. It therefore scores a zero for both of these categories.

Pendulum steering involves a secondary heater near the rear of the cryobot called the flange. This is slightly larger than the rest of the cryobot and, therefore, the cryobot “hangs” from this heater. This improves robustness and attitude control, but the attitude cannot be actively controlled yielding only partial benefit for controlling pitch and avoiding debris, so both of these criteria earn scores of 5. This flange requires additional heating elements, thus considerably consuming more power. However, the flange eliminates the need for additional heating elements, slightly reducing the power consumption for locomotion. Thus the power consumption for locomotion earns a score of 7. Lastly, the flange is a large structure, so it earns a score of 7 for mass.

Mercury steering involves having a pool of mercury in the hot point. If the cryobot begins to tip, this pool directs heat towards the “low” end of the cryobot, correcting the attitude. This is functionally the same as pendulum steering, so it also earns scores of 5 for robustness and attitude control. This is a passive system that requires minimal additional power beyond the melting power of the cryobot, so it earns a score of 9 for power consumption. The addition of a pool of mercury, however, adds mass. Thus, mercury steering earns a 5 for mass.

The first active attitude control device considered is differential heating on the hot point alone. This would primarily utilize already built-in heating elements, thus would not contribute much additional mass, earning a score of 9 for mass. Additionally, it will not require much additional power beyond the normal hot point, it earns a power score of 8. This differential heating will allow for excellent attitude control, earning a score of 9, and the capability of avoiding obstacles, earning a robustness score of 7.

The other active control mechanism, differential heating along the body, is accomplished using heating elements distributed along the length of the cryobot. These will likely already be in place to prevent refreezing, but may need to be more powerful than required solely for prevention of refreezing, adding mass. Otherwise differential heating along the body is functionally the same as differential heating of the hot point. Thus, it earns a score of 8 for power consumption, 7 for

robustness, 9 for mass, and 9 for attitude control.

The final design alternative is differential heating both in the hot point and along the body of the cryobot. This has the same power consumption as both the differential heating of the hot point and along the body, earning a score of 8. This is more robust than both the differential heating of the hot point and along the body, so its robustness score is 8. This carries the same mass penalties as both differential heating of the hot point and differential heating along the body, so its mass score is 7. Having both the differential heating of the hot point and along the body provides increased attitude control, earning a score of 10.

Power Source

As discussed in sections 6.3.1 and 7.3.2, there are two options for the power source of the cryobot: a fission reactor and a RHU. These affect four performance criteria: descent rate, endurance, mass, and robustness. The choice of power source effects robustness for two reasons: mechanical complexity and design uncertainty. RHU are essentially solid-state devices that produce heat, while fission reactors require a cooling fluid constantly moving through the reactor core. Fission reactors are also not a proven technology, and there are no current plans to test them. Although the technology is not particularly revolutionary, the operation of a nuclear reactor represents a programmatic risk. Therefore the robustness, the probability of the power source causing a critical mission failure, of a fission reactor earns a score of 5, while the less complex, proven RHU earns a score of 9.

The endurance of the power source is how long the power source can operate. Fission reactors can operate for long periods and can be stored for long periods, while RHU lose power while in storage and in transit, as well as during operation. That being said, RHU have sufficiently long lifetimes for purposes of this mission, operating at anticipated power level needs for several years. Thus, RHUs have an endurance score of 7, while fission reactors have an endurance score of 10.

Fission reactors are capable of producing several times the heating power of RHUs. Therefore a cryobot with a fission reactor is capable of a much greater descent rate than one powered by a RHU. Therefore the descent rate of the cryobot with a fission reactor earns a score of 10, while the cryobot with a RHU earns a score of 5. Lastly, RHU and fission reactors have comparable mass, so they both earn scores of 7.

Size of the Cryobot

For simplicity, only two sizes of cryobot are considered, a small cryobot, less than 25 cm in diameter and 2.5 m long, and a large cryobot over 50 cm in diameter and 5 m long. The advantage of a large cryobot is the greatly increased payload capacity. Thus the large cryobot earns a payload score of 9, while the small hydrobot earns a score of 1. The large cryobot is also capable of carrying additional fuel and supplies, so it is capable of lasting longer than the small cryobot. Thus, the large cryobot earns an endurance score of 9, while the small cryobot earns a score of 3. The small cryobot has lower power requirements, particularly for locomotion. Thus, the small cryobot earns score of 7 and 6 for the power consumption for locomotion and system, respectively. The large

cryobot have considerably greater power requirements, thus earns scores of 3 and 4 for the power consumption for locomotion and system, respectively.

The preceding information is summarized in Table 7.4. Criteria weights are utilized from Tables 5.8 and 5.9.

Table 7.4: Results of the evaluation of cryobot performance design alternatives. The highest scoring design alternatives are bolded for clarity.

		Attitude Control	Descent Rate	Endurance	Mass	Payload	Power Consumption (L)	Power Consumption (S)	Robustness	Final Score
Attitude Control Devices	<i>Weight</i>	<i>0.23</i>	<i>0.17</i>	<i>1.02</i>	<i>0.61</i>	<i>0.87</i>	<i>2.47</i>	<i>1.43</i>	<i>1.42</i>	
	None	0			10		10		0	30.80
	Pendulum Steering	5			7		7		5	29.81
	Mercury Steering	5			5		9		5	33.53
	Differential Hot Point Heating	9			9		8		7	37.26
	Differential Heating Along Body	9			9		8		7	37.26
	Differential Heating on Hot Point and Along Body	10			7		8		8	37.69
Power Source	Fission Reactor		10	10	7				5	23.27
	Radioisotope Heating Unit		5	7	7				9	25.04
Cryobot Size	Small			3		1	7	6		29.80
	Large			9		9	3	4		30.14

The best attitude control design alternative is to have differential heating both on the hot point and along the body. This design alternative scores the highest primarily because of its improved robustness over the individual systems. Similarly, while fission reactors present a significant performance increase over RHUs, RHUs are a proven technology with low mechanical complexity, and are therefore more robust. The value system indicates that RHUs are a better option than fission reactors, although this may change in the future if significant research is performed to improve the technology and/or other new and novel energy sources are developed. The final performance design alternative for the cryobot performance is the size of the cryobot. The large design paradigm is determined to be the better design alternative due to its increased payload capacity.

Communication

There are six performance criteria for the cryobot’s communication: access duration, access frequency, average data rate, peak data rate, power, and robustness. The first possible means of communication for the cryobot is to communicate directly to Earth. This would require a very powerful antenna capable of transmitting directly through the ice. Although this is possible, it is power intensive [142]. Therefore, power is given a score of 1 for this alternative. Since there will likely only be a single antenna, there exists a single point of failure. The antenna, however, is not prone to mechanical failure, so the robustness score earns a 5. The potential rate of communication is limited only by the allowable frequencies. While radio communication can be fast, it is not nearly as fast as wired or fiber optic communication. Furthermore, the long range required will likely slow the possible data transfer rate. Thus, this design alternative earns a score of 5 for average data rate. Additionally, since this radio must broadcast the entire distance to Earth, a

high-speed burst may not be possible, so the peak data rate will be only marginally higher than the average data rate, so it also earns a score of 5. Due to the required range of this transmitter, the antenna will need to be highly directional, so the communication link will only be active so long as there is a direct line of sight from the cryobot to Earth through the ice. Therefore, the access from the cryobot to Earth is very limited, so both the access duration and frequency score a 1.

A related option to communicating directly to Earth is to communicate, using radio to a relay satellite. Since the technology utilized will be approximately the same as for the prior design alternative, the robustness, average data rate, and peak data rate also score a 5. The power requirements are considerably more modest, so it earns a score of 3. Since the relay satellite is much closer to the cryobot than Earth, the antenna does not need to be as directional. The relay satellite, however, does need to be roughly “above” the cryobot. Furthermore, it is less difficult for the satellite to communicate to Earth because the antenna of the satellite can be pointed Earthward either by gimbaling the antenna or turning the satellite. The satellite does need to maintain a line of sight to Earth. This results in frequent interruptions, so the access frequency and duration only score 3.

The next option is to communicate via the surface unit. The cryobot will likely have near constant communication with the surface unit in this arrangement, so the access frequency and duration are limited by the access frequency and duration of the surface unit. To be conservative, both access frequency and duration score 1 for both of these design criteria, regardless of the means of communication. The three methods of communicating between the cryobot and surface unit are radio, acoustic, and tethers. Acoustic communication requires significant power and has very low data transfer rate. The means that acoustic communication scores a 3 for power consumption, but only a 2 for peak data rate. The acoustic environment is of the ice is unknown and may cause interference with acoustic communication. This interference may be temporary or persistent. If it is temporary, it will serve to lower the average data rate (which earns a score of 1), but, if the interference is persistent, it represents a significant failure mode, thus resulting in a score of 3 for robustness. Radio communication between the cryobot and surface unit is another feasible mode of communication. This radio would not have the potential interference from the acoustic environment, so its robustness is comparable to the other radio communication techniques, earning a score of 5. The power requirements are more modest than communicating from the cryobot to a relay satellite, so it earns a score of 5. The average and peak data rates are comparable to communicating to a relay satellite, so these earn scores of 5. The final technique of communicating between the cryobot and surface unit is to communicate via a fiber optic tether. This is capable of nearly constant communication at very high data transfer rates. This means that both the peak and average data transfer rates earn score of 10. Tethers also require very little power, so tethers earn a score of 10 for power consumption. The flaw of tethers is that, if the tether is severed, no data can be transferred. This is not likely to occur in tension, but, if shearing is present, the tether will likely be severed. Therefore the robustness only scores a 2.

Instead of communicating directly to the surface unit, the cryobot may utilize a network of ice embedded transceivers. As before, the access duration and frequency are limited by the surface unit, so all of these design alternatives earn the conservative score of 1 for both access frequency and duration. The primary method for transmission with ice embedded transceivers uses radio. Since the nodes of the transceiver network are disconnected, the network can still function when one or more node(s) fails. Therefore, this is robust and earns a score of 7. Since the radio only needs

to transmit over relatively short distances, this is very power efficient, earning a power score of 8. The average and peak data rates for communicating by radio is limited primarily by the choice of frequency, which is restricted for communication through ice, so the scores for the peak and average data rate for radio based ice-embedded transceivers are the same as for communicating directly to the surface unit, earning scores of 5 for both peak and average data rates. Another option for communicating between transceivers is to use acoustic communication. The robustness of acoustic communication is comparable to that of radio communication between transceivers, earning a score of 7. The power required for acoustic communication is greater than that for radio communication, particularly if there is environmental noise. Therefore, the acoustic transceivers only earn a score of 5. The peak and average data transfer rates are improved compare to direct communication to the surface unit. Therefore, the average and peak data rates for acoustic transceivers earn score of 2 and 3, respectively. The final option utilizing transceivers is to use fiber optic tethers in regions where the ice is less transmissible and radio where the ice is more transmissible. This is still limited by the data transfer rate of radio communication, so the peak and average data transfer rate scores are both 5. Since power will not be wasted transmitting through less radio transmissible regions, incorporating a tether reduces the power consumption. Therefore, the power consumption earns a score of 9. The tether, however, introduces a significant risk of failure; the robustness scores a 4.

The final option for communication utilizes radio and tether simultaneously. Radio-based ice-embedded transceivers are robust, but have only a modest average and peak data transfer rates. A tether directly to the surface unit has a high average and peak data transfer rate with low power consumption, but is not very robust. By having both of these systems, the robustness is improved to a score 8. Both of the independent systems are power efficient, so the power consumption earns a score of 7. The peak data rate is the peak data rate of the tether, so it scores a 10. To account for the possibility of failure of the tether, the average data rate only score a 7. As before, this relies on the surface unit to relay information back to Earth, so its access frequency and duration are given the conservative scores of 1.

The results of this evaluation are included in Table 7.5. The second and third highest scoring communication alternatives are communicating through ice-embedded radio transceivers and a tether. The comparable scores of these technologies led to the inclusion the bolded design alternative which uses both systems. Using both systems increases robustness, but also increases power consumption. As it would be unfortunate to successfully arrive on Europa, penetrate the ice, and launch vehicles, only to find the communication network had failed, a redundant systems is prudent.

Science

Design of alternatives for the science mission of the cryobot is deferred until a later time as such needs will likely be informed by a precursor multi-flyby mission such as “Clipper.” At this stage, priority is given toward maximizing payload in the cryobot to allow for instrumentation options as the state of knowledge evolves.

Table 7.5: Results of the evaluation of cryobot communication design alternatives. The highest scoring design alternative is bolded for clarity.

Communication Route	Communication Method	Access Duration	Access Frequency	Average Data Rate	Peak Data Rate	Power	Robustness	Final Score	
		<i>Criteria Weight</i>	<i>1.72</i>	<i>0.93</i>	<i>2.37</i>	<i>0.45</i>	<i>2.61</i>	<i>3.96</i>	
Direct to Earth	Radio		1	1	5	5	1	5	39.16
To Relay Satellite	Radio		3	3	5	5	3	5	49.68
Direct to Surface Unit	Radio		1	1	5	5	5	5	49.6
	Acoustic		1	1	1	2	3	3	25.63
	Tether		1	1	10	10	10	2	64.87
To Surface Unit Through Transceivers	Radio		1	1	5	5	8	7	65.35
	Acoustic		1	1	2	3	5	7	49.51
	Partially Tethered		1	1	5	5	9	4	56.08
Multiple	Radio and Tether		1	1	7	10	7	8	73.69

7.5.4 Hydrobot

Propulsion

Propellers and biomimetic propulsion represent two very different technologies. Propellers utilize hydrodynamic surfaces that turn rapidly along a shaft to produce thrust, while biomimetic propulsion utilizes actively deformable surfaces that produce thrust like fish or marine mammals. Despite these differences, the actual systems produce similar performance. Therefore, the range, endurance, power, controllability, and mass of both biomimetic propulsion and propellers earn the same scores. Specifically, range, endurance, power and mass all earn scores of 5 due to the moderate performance of these propulsion techniques compared to underwater gliders. However, both biomimetic swimming and propellers earn scores of 10 for controllability. Propellers earn a score of 3 for robustness because propellers require dynamic seals, while biomimetic propulsion earns a score of 7 for robustness because, although it has no dynamic seals, it requires motion for propulsion, potentially leading to failure. While propellers have a longer history of use and reliability than biomimetic propulsion, the robustness evaluation here reflects anticipated near-term advances in biomimetic technology making its use more commonplace.

In contrast to these propulsion mechanisms, functioning as an underwater glider has many efficiency benefits. Underwater gliders require almost no power to propel themselves, so functioning as an underwater glider earns scores of 10 for range, endurance, and power. All underwater vehicles that explore the ocean must have a buoyancy control mechanism, so underwater gliders do not require additional mechanisms for propulsion, earning a score of 10 for mass. Since all of the control devices are internal, there is reduced risk of mechanical failure. Despite this, the underwater glider may not be able to fight the current to reach its destination, so it earns a score of 9 for robustness. Underwater gliders must be moving to turn and cannot turn sharply, nor fight strong

currents. Therefore, underwater gliders only earn a score of 1 for controllability.

The final option, biomimetic underwater gliders have the same range and endurance as underwater glider (e.g. a score of 10) because, when the tail is fixed, biomimetic underwater gliders function as traditional underwater gliders. Biomimetic underwater gliders consume more power than underwater gliders while swimming, so they earn a score of 7 for power. The weight requirements of a biomimetic underwater glider are largely the same as for a non-gliding vehicle using biomimetic propulsion, so it earns a score of 5 for mass, but, since it can function as a glider, biomimetic underwater gliders are more robust than biomimetic swimming vehicles. Additionally, biomimetic gliders are capable of fighting currents. Therefore biomimetic underwater gliders earn a score of 9 for robustness. Lastly, biomimetic underwater gliders are capable of swimming, earning a score of 10 for controllability.

The results of this analysis are included in Table 7.6. The key finding is that the biomimetic underwater glider is the best option according to the value system. Underwater gliders also score well because of their efficiency and robustness, but do not score as well biomimetic underwater gliders due to their lack of controllability and inability to fight strong currents.

Power Sources

There are three viable power sources for the hydrobot: RPSs, batteries, and fuel cells. RPSs are able to function over long periods of time, earning a score of 10 for range and endurance. Batteries and fuel cells can function for much shorter periods without being replenished (recharged or refueled), so they only earn scores of 5 for range, but since both fuel cells and batteries can be replenished, they still earn scores of 10 for endurance. Batteries are very robust and do not start to break down until thousands of charges, so they earn a score of 10 for robustness. RPSs also earn a score of 10 for robustness because it is essentially a solid state device. Fuel cells require complex valves and ports for refueling, which are prone to failure. Therefore fuel cells earn a score of 3 for robustness. Small RPSs are not able to produce a lot of power, so RPSs earn a score of 1 for power, while both batteries and fuel cells are able to produce large quantities of power. Fuel cells are more energy dense than batteries, so fuel cells earn a power score of 10, while batteries earn a score of 9. Lastly, batteries are very energy dense, so they earn a score of 10 for mass. Fuel cells are more energy dense, but they require strong storage tanks for the storage of Hydrogen and Oxygen, so this option earns a score of 8. RPSs are not very energy dense, resulting in a score of 1 for mass.

Table 7.6 shows the evaluation of these power sources. The best option is batteries. Batteries score high than fuel cells because they do not require complex valves for refueling. Batteries also score better than RPSs due to the low power output of RPSs.

Navigational Tools

The four options for navigation are ded reckoning, LBL positioning, GPS-like systems, and SLAM. Fortunately multiple navigational tools can be use simultaneously. Acknowledging the impracticality of devising a GPS system for Europa, and recognizing that hydrobots would not have line of

Table 7.6: Results of the evaluation of hydrobot performance design alternatives. The highest scoring design alternatives are bolded for clarity.

		Controllability	Endurance	Mass	Navigation Error	Power	Range	Robustness	Total Score
<i>Criteria Weight</i>		<i>0.45</i>	<i>0.65</i>	<i>0.25</i>	<i>2.12</i>	<i>0.55</i>	<i>1.13</i>	<i>0.61</i>	
Propulsion	Propellers	10	5	5		5	5	3	19.23
	Biomimetic Swimming	10	5	5		5	5	7	21.67
	Underwater Glider	1	10	10		10	10	9	31.74
	Biomimetic Glider	10	10	5		7	10	9	32.89
Power Source	RPS		10	1		1	10	10	24.70
	Battery		10	10		9	5	10	25.70
	Fuel Cell		10	8		10	5	3	21.48

site to satellites regardless, navigation would likely be a combination of ded reckoning, LBL positioning, and SLAM. Ded reckoning can be used to determine the position of the hydrobot between updates from LBL and SLAM. SLAM can be used to accurately determine the position near an interface and LBL can be used to determine the position of the hydrobot when it is too far from an interface to use SLAM.

Communication

While it is possible for the hydrobot to communicate to Earth, a relay satellite, or to the surface unit, this requires ELF radio transmitters or for the hydrobot to embed itself in the ice to transmit. These are not practical options because ELF transmitters are very large and have large power requirements, while embedding the hydrobot in the ice would require more mechanical intervention than desired. Furthermore, since a battery-powered hydrobot needs to dock to recharge batteries, the cryobot/refueling station can be used for communication. Therefore, the most practical options for the hydrobot’s communication are acoustic, optical, and docked communication. The best option will actually utilize all three forms of communication. Acoustic communication will be used for positioning by LBL positioning. This communication, while slow, can be used for basic status updates. Over short distances, optical communication can be used to coordinate the docking between the hydrobot and cryobot. Once the hydrobot is docked and recharging, data can be transferred between the hydrobot and cryobot using any number of wireless data communication methods.

Science

As before, the science objectives of the hydrobot will be evaluated in terms of specific goals informed by a precursor orbital or multi-flyby mission. Key decisions will include determining if each hydrobot within a cryobot should carry a specialized sensor package or if each hydrobot should be identically equipped. Recall, however, a preliminary sensor package assessment in-

cluding three variants, with a corresponding science traceability matrix, was presented in Section 6.4.

7.5.5 Communication Menu

Because the communication modes used by the various components are independent, the possible communication architectures are listed in the form of a “menu” in Table 7.7. Not shown in this table are embryonic communication technologies such as quantum entanglement, which would use a set of quantum entangled atoms on each component and on Earth to enable near-instantaneous, high data rate speed communication. Such technologies cannot currently be considered viable for the EUROPA mission.

Table 7.7: “Menu” for possible communication architectures

Hydrobot	Cryobot	Surface Unit
<ul style="list-style-type: none"> ● Communicate Directly to Earth (radio) ● Communicate to Relay Satellites (radio) ● Communicate to Surface Unit <ul style="list-style-type: none"> – radio through ice only – radio through ice and water – acoustic vibrations ● Communicate through ice-embedded transceivers <ul style="list-style-type: none"> – radio through ice only – radio through ice and water – acoustic vibration ● Communicate to cryobot <ul style="list-style-type: none"> – radio – optical – acoustic – docking 	<ul style="list-style-type: none"> ● Communicate directly to Earth (radio) ● Communicate to relay satellite (radio) ● Communicate to surface unit <ul style="list-style-type: none"> – Radio – Acoustic – Tether ● Communicate through ice-embedded transceivers <ul style="list-style-type: none"> – Radio – Acoustic – Tethers (Partial) 	<ul style="list-style-type: none"> ● Communicate Directly to Earth <ul style="list-style-type: none"> – Radio – Optical ● Communicate to Relay Satellites <ul style="list-style-type: none"> – Radio – Optical

Chapter 8

Mission Architectures

With a better understanding of the requirements and constraints imposed by the design alternatives discussed in Chapter 7, one may define various mission architectures that illustrate tradeoffs in cost and capability. The exploration system is defined by the number and nature of landers, surface units, cryobots, and hydrobots. In Section 8.1 the authors propose five different mission architectures. In Section 8.2, these architectures are comparatively evaluated based on their potential to meet the mission's science objectives.

8.1 Proposed Mission Architectures

Europa's ocean is truly vast, and just like the Earth's ocean, one expects there to be significant differences in the environment from place to place. Therefore, in this project mission architectures are explored that enable broad scientific surveys of this unknown sea. Multiple, independent hydrobots will allow for extended surveys as well as functional specialization in order to explore the different environments near the ice-ocean and rock-ocean interfaces.

In describing the mission architecture, the authors focus on four primary components: landers, surface units, cryobots, and hydrobots. While a lander might deposit multiple surface units at multiple locations on Europa's surface, here it is assumed that each lander is dedicated to a single surface unit. Similarly, while a single surface unit might deploy multiple cryobots, here it is assumed that each surface unit is dedicated to a single cryobot. These assumptions reflect the expectation that the cryobot and its hydrobots will be more sophisticated than the lander and the surface unit. Thus, deploying redundant systems to improve mission resilience and effectiveness might be best accomplished using independent landers and surface units. Several proposed mission architectures are listed in Table 8.1. The distinguishing characteristic of each architecture is the number of components. For example, Architecture 3 includes one cryobot and three hydrobots.

Table 8.1: Proposed mission architectures of a mission to explore Europa. The number of each subsystem is included. The subsystems are Surface Units (SU), Cryobots (C), and Hydrobots (H). A brief description of architecture is included. For reader convenience, this table is repeated from Table 4.2

ID	No. of Subsystems			Description
	SU	C	H	
1	1	1	0	A single surface unit is left on the surface, it deploys a single cryobot that penetrates the ice. The cryobot embeds either itself or a tether in the bottom of the ice. The cryobot then starts taking measurements. It may deploy small probes that sink to the bottom and return measurements, but cannot control their descent. This architecture does not include a hydrobot
2	1	1	1	A single surface unit deploys a single cryobot. This cryobot penetrates the ice and deploys a single hydrobot into the ocean. This hydrobot uses the natural profiling motion of an underwater glider to profile the ocean.
3	1	1	3	A single surface unit deploys a single cryobot. This cryobot penetrates the ice and deploys three hydrobots. These hydrobots may have specialized sensor packages (e.g. for exploring the ocean floor). This architecture may utilize a tethered bottom station.
4	3	3	9	Three surface units deploy three cryobots. Each cryobot penetrates the ice and deploys three, possibly specialized, hydrobots. This architecture may utilize a tethered bottom station.
5	4	4	16	Four surface units land and each deploys a single cryobot, for a total of four. Each cryobot penetrates the ice and deploys 4, possibly specialize, hydrobots. This architecture may utilize a tethered bottom station.

8.2 Evaluation of Mission Architectures

The five presented mission architectures represent notional mission architectures bounding potential design variants. This is not to say that increments within these bounds are not feasible. For example, there could be an architecture where a single lander deploys a single cryobot, which then deploys two hydrobots. This variant was not considered as it does not make the most efficient use of the volume of the cryobot. In general, the five variants selected were chosen for their efficient use of space and opportunity to discuss reasonably sized incremental variations in mission architecture.

Tables 5.8 and 5.9 shows the value system ranked by the most important design criteria. The design criteria impacted by mission architecture, in order of most to least important, are hydrobot diversity, cryobot resolution, hydrobot resolution, hydrobot coverage, cryobot coverage, cryobot diversity, surface unit coverage, surface unit diversity, and surface unit resolution. Based on the value system, cryobot coverage, cryobot diversity, surface unit coverage, surface unit diversity, and surface unit resolution are all at least four times *less* important than hydrobot diversity, cryobot resolution, hydrobot resolution, and hydrobot coverage. Therefore only hydrobot diversity, cryobot resolution, hydrobot resolution, and hydrobot coverage will be considered for evaluating the mission architectures. A ten point scale is used here to evaluate each criteria, with 10 being an ideal score.

Beginning with the cryobot, specifically, cryobot resolution, this is directly related to how many data points the cryobot can collect. Each cryobot will take nominally the same number of data points, so mission architecture 1, 2, and 3 have 1/3 the resolution of mission architecture 4 and 1/4 the resolution of mission architecture 5. Therefore, normalizing to a score out of 10 and rounding, mission architectures 1, 2, and 3 earn a score of 3, mission architecture 4 earns a score of 8, and mission architecture 5 earns a score of 10. Similarly, hydrobot resolution and coverage are a function of the number of hydrobots. Therefore, since mission architecture 1 has 0 hydrobots, mission architecture 2 has 1 hydrobot, mission architecture 3 has 3 hydrobots, mission architecture 4 has 9 hydrobots, and mission architecture 5 has 16 hydrobots, mission architectures 1, 2, 3, 4, and 5 earn scores of 0, 1, 2, 6, and 10, respectively. Mission architecture 2 only has a single hydrobot, therefore it must carry all of the essential instruments for the mission. Mission architectures 3, 4, and 5 have multiple hydrobots, so these can be specialized for specific missions. To improve robustness, this specialization will be applied to the hydrobots within a single cryobot, therefore increasing the number of hydrobots by having more cryobots does not increase diversity. Therefore, mission architecture 2 earns a score of 5 for hydrobot diversity, while architectures 3, 4 and 5 earn scores of 10.

The results of the evaluation of the mission architectures are included in Table 8.2. From this analysis, it is clear that increasing the number of hydrobots and cryobots improves the score. Despite this, mission architectures 4 and 5 score very close to each other. Based on past missions shown in Figure 3.2, the increased mass of adding an additional cryobot and 7 additional hydrobots will greatly increase the cost of the mission. Furthermore, as seen in Table 4.3, there is only a minor improvement in scientific measurements. Therefore, mission architecture 4 is preferred to mission architecture 5 due to its comparable scores in Tables 4.3 and 8.2 while costing significantly less, due to its reduced mass.

Table 8.2: Evaluation of mission architectures.

System	Design Criteria	Mission Architectures				
		1	2	3	4	5
Cryobot	Resolution	3	3	3	8	10
Hydrobot	Diversity	0	5	10	10	10
	Resolution	0	1	2	6	10
	Coverage	0	1	2	6	10
Total		6	22	38	60	77

Chapter 9

Roadmap, Timeline, Notional Vehicle Design, and Proposed Concept of Operations

9.1 Roadmap and Timeline

To develop the roadmap and timeline, technologies and techniques are divided into three categories:

- Extant Technologies
- Developing Technologies
- Future Technologies

Extant technologies are technologies that are mature. Minor improvements (e.g. making computers smaller) will be made to these technologies, but the technologies are not expected to greatly change over time. The next set of technologies are developing technologies. Developing technologies represent incremental improvements to existing technologies. Future technologies are technologies that do not exist yet and require significant research before implementation.

The key extant, developing, and future technologies required for this mission are displayed in Figure 9.1. The images in Figure 9.1 are from [20, 21, 22, 23, 24, 25, 26, 27, 28, 29, 30, 31]. These technologies present a roadmap for the mission. In general, extant technologies enable developing technologies, which in turn leads to creation of future technologies.

The anticipated development path is described using arrows in Figure 9.1. Several of the technologies stand alone. One of the most important developing technologies are underwater vehicles that can utilize both gliding and swimming for propulsion. This technology requires furthering the state of the art of both underwater gliders and biomimetic propulsion. One of the most important navigational tools for this mission requires the development of SLAM (Simultaneous Localization

And Mapping) for under-ice regions, particularly at scales appropriate to Europa's ocean. Lastly, the development of RHU-powered melt probes requires refinement of current RHU and RPS technology. Additionally, the development of melt probes must continue to guarantee that the cryobot will successfully penetrate several kilometers of ice. These melt probes will require the development of fiber optic tethers for high-speed data communication to the melt probe through great distances in ice.

9.2 Notional Design

9.2.1 Surface Unit with Landing System

The notional design of the surface unit is shown in Figure 9.2. This figure is shown with the cryobot for illustrative purposes. This vehicle carries redundant radioisotope generators, shown in Figure 9.2(a). The surface unit carries fuel tanks (shown in Figure 9.2(a)) to supply the thrusters shown in Figure 9.2(b). The laser transmitter and receiver are shown in Figure 9.2(a) attached to a gimballed pointing mechanism. The components that will be buried in the ice for radiation are circled in Figure 9.2(a) and are shown in green. The surface unit has a solid shield on its bottom, to protect the components from debris during descent. A hole is placed in the center of the surface, which is used to lower the cryobot to the ice. The boxes on the surface unit represent storage for instruments that can be left on the surface. These include instruments that are used for landing and cameras that will collect images of the surface. Additionally, sensors that characterize the surface chemistry and radiation environment must remain on the surface to take accurate measurements. Lastly, the surface unit will carry star trackers to measure the attitude of the surface unit. In addition to assisting with the landing, star trackers help the surface unit to characterize the motion of the ice.

9.2.2 Cryobot

The cryobot is shown in Figure 9.3. The hot point is shown in red on the left side of Figure 9.3. Immediately above the hot point is the water pump and RHU. The RHU also has an attached Stirling engine for producing electricity, thus making it an RPS. However, the primary purpose of the RHU is producing heat for melting. The RHU is connected to heat exchangers (not shown) that carry heat to the hot point and along the body. The water pump works to circulate melt water through the RHU to facilitate heating and pumps water at high pressure through the hot point, which improves melting efficiency and prevents debris from accumulating. The high-pressure pump also helps with breaking through some debris. Hardware is expected to be placed in the area labeled "Compartment for sensors and acoustic systems."

These schematics are representative of mission architecture 4; as such, this cryobot is shown carrying three hydrobots in its interior. The hydrobots are stored behind doors, shown in white. These doors protect the hydrobots during descent and also help embed the cryobot in the bottom of the ice. The hydrobot recharging mechanism is also contained in this area. Remote acoustic beacons for LBL positioning (not shown) would likely also be placed in this compartment. The hydrobots

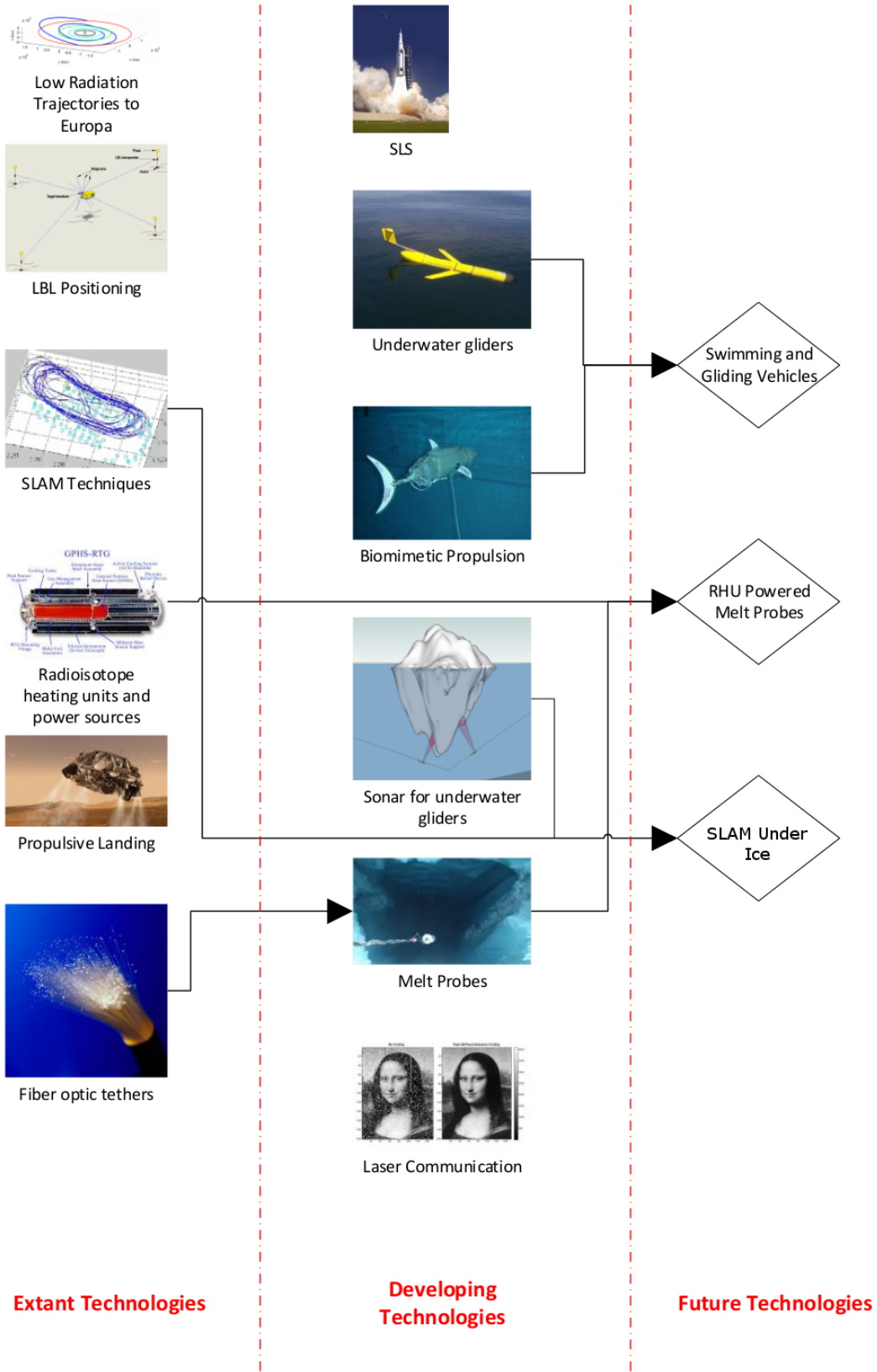

Figure 9.1: Graphical representation of technology roadmap. Images culled from [20, 21, 22, 23, 24, 25, 26, 27, 28, 29, 30, 31].

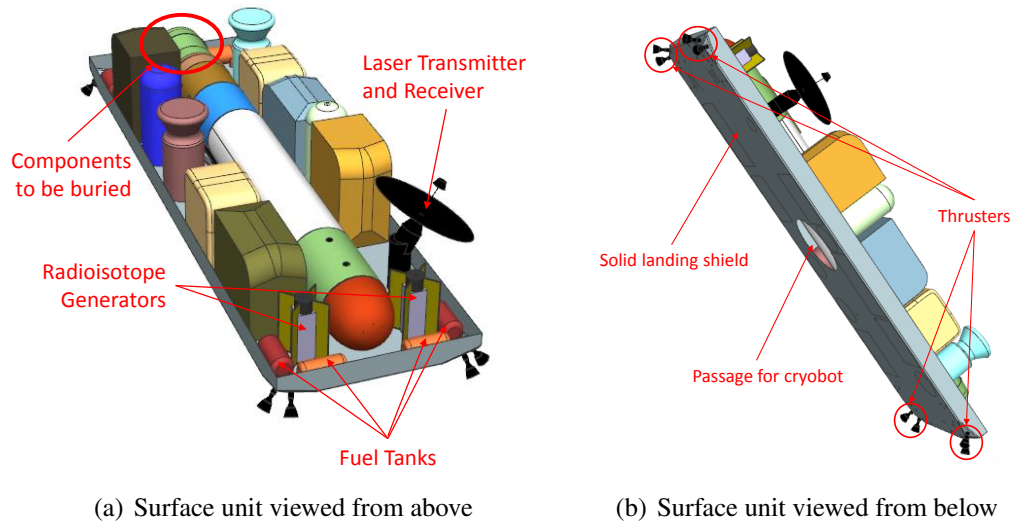

Figure 9.2: Notional design of surface unit with cryobot in its stored configuration.

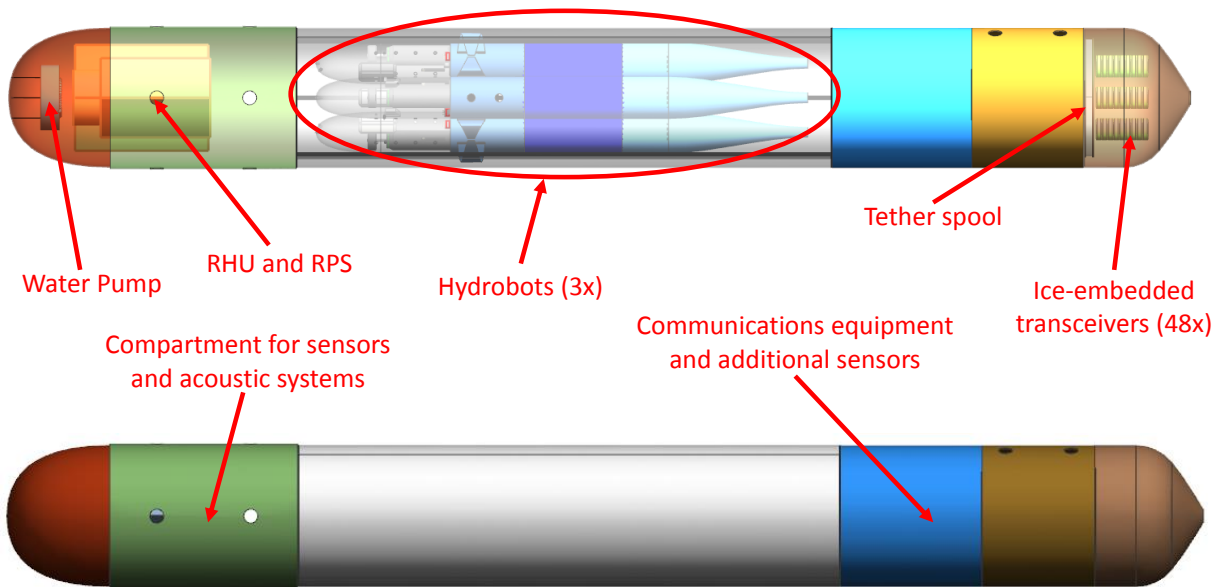
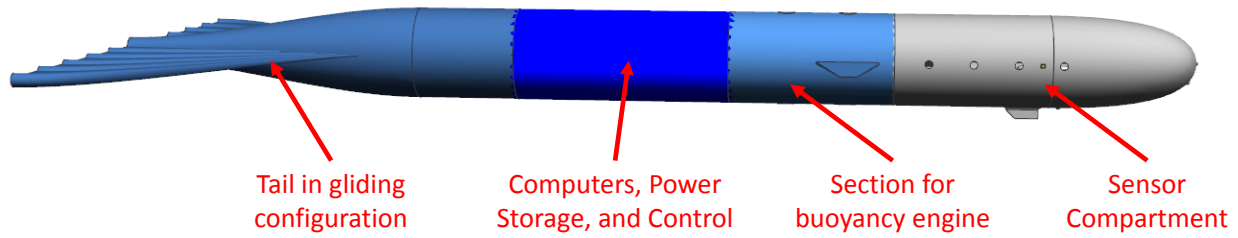
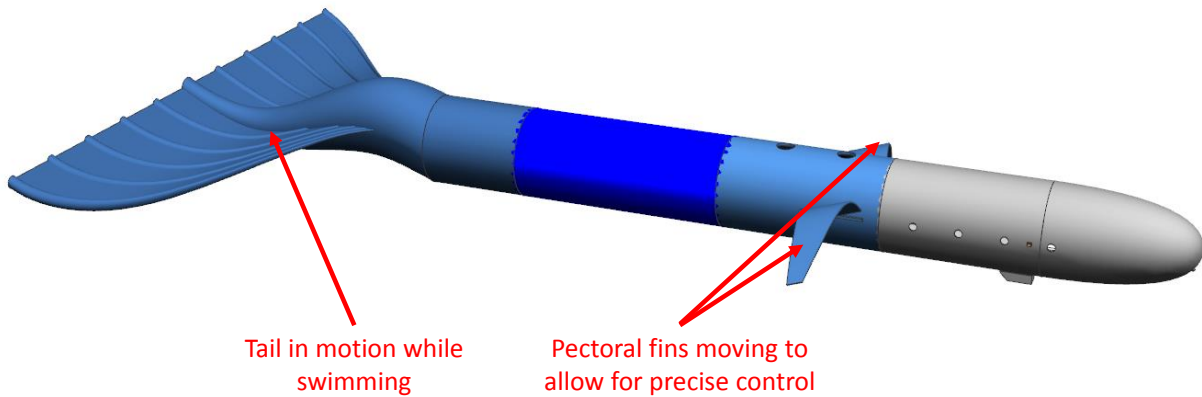

Figure 9.3: Annotated notional design of the cryobot. Transparent and opaque views are given to show the structure and distribution of interior components.

will carry these beacons a sufficient distance from the cryobot to establish a network for LBL positioning. The next region, shown in blue and gold, is storage for communications equipment and additional sensors. This section will have greater protection from the radiation of the RHU than the sensor compartment, and will remain mostly in the ice. This section also carries the computers and data storage devices of the cryobot. Above this section, the fiber optic tether and ice-embedded transceivers are stored. These are deployed during descent to maintain communication with the surface unit.



(a) Hydrobot in gliding configuration



(b) Hydrobot in swimming configuration

Figure 9.4: Annotated notional design of the hydrobot shown in both swimming and gliding configurations.

The ice-embedded transceivers are shown detached from the tether. It is also possible to have the transceivers attached to the tether. These transceivers could act as repeaters for the tether and use the tether to transmit collected data. If the tether fails, the transceivers can use radio communication to bridge the gaps in the cable. Attaching the transceivers means that the transceivers are at fixed intervals along the tether. Therefore, unlike detached transceivers, they cannot be distributed dynamically based on the radio attenuation of the ice.

9.2.3 Hydrobot

The hydrobot is shown in both its swimming and gliding configurations in Figure 9.4. The primary configuration of the hydrobot is the gliding configuration, shown in Figure 9.4(a). The tail of the glider is fixed in an approximately flat configuration. There is slight camber to increase lift, improving gliding performance, but it is not evident in the visualization. Figure 9.4(b), shows the tail in a swimming configuration, actuated by smart materials. These materials allow for biomimetic motion when swimming, while also requiring minimal power to maintain the gliding configuration. In front of the base of the tail, there is a compartment for the on-board computer, batteries, and control system. This compartment must be made sufficiently strong to survive the pressures present at the bottom of Europa's ocean. This is not as much of a concern for other, flooded compartments of the hydrobot. The section fore of the electronics compartment contains the bladder and buoy-

ancy engine. This section is responsible for controlling the ascent and descent of the hydrobot, which is the primary means of propulsion while gliding. This section is completely flooded, but carries pectoral fins on its circumference. These fins, labeled in 9.4(b), allow for attitude control of the hydrobot in both swimming and gliding configurations. These fins are made out of smart materials, therefore requiring minimal internal volume space for actuation. In front of the bladder compartment is the sensor compartment. This section holds sensors, including spectrometers, sonar instruments, and cameras. The sonar instruments shall double as transceivers for LBL positioning enabling the same package to be used for both SLAM and LBL positioning. The cameras are used both for taking pictures (small lights for illuminating surfaces are also in this section), optical guidance from the cryobot for docking, and to support SLAM navigation. The equipment for recharging and communication while docked is also contained in this compartment.

9.3 Proposed Concept of Operations

The proposed concept of operations (CONOPS) is based on mission architecture 4. This section describes the stages of the mission. Note, the backgrounds of several images shown here are photographs of ice-fields on Earth. These images show features caused by erosion from wind and other sources. These features will not be present on Europa, so the images are for illustrative purposes only. The mission begins from Earth, where it is launched by the SLS. The SLS allows for a direct transfer to Jupiter [134], eliminating the need for a complex trajectory involving gravity assists from other planets. Once in the Jupiter system, a trajectory that minimizes radiation exposure, such as the “Banzai Pipeline” [20], is used to get to orbit around Europa. Mission architecture 4 calls for three separate landers, so these landers separate once in orbit and perform maneuvers as necessary to reach their predetermined landing sites. One or more relay satellites are separated from the landers at this point and maneuvers to pre-determined orbits. It should be noted that the exact number of relay satellites will depend on the chosen landing sites; closely spaced landing sites only require a single relay satellite, while more sparsely located landing sites might need two or more relay satellites. The relay satellite acts as a “bent pipe” receiving transmissions from the surface units and transmitting this information back to Earth. Having the relay satellite is likely a mass savings for the mission. A high-powered laser and receiver is required for communication to Earth. If a relay satellite is not used, every surface unit must carry one of these lasers. If a relay satellite is used, the surface units can carry much smaller lasers, and only a single high-powered laser is necessary.

After the landers are in their nominal orbits, final descent occurs as initiated by firing of retro-rockets. These can be very propulsion stages that serve only to slow the lander and begin its descent to the surface. These rockets are released once depleted. Closer to the surface, another set of retro-rockets fire to further slow the descent. These rockets are also released once depleted. These two-stage retro-rockets serve to slow the lander significantly, after which point smaller, more accurate, thrusters begin the final controlled descent. This is shown in Figure 9.5. These thrusters perform two tasks: slowing the descent and correcting the trajectory to land at a desirable landing site. The exact location of the landing site is based on sensor measurements taken during descent including images and laser range-finder measurements generally informed by prior, multi-



Figure 9.5: Spacecraft controlled by landing thrusters. Background image is a photograph of Antarctica from http://polarfieldservice.files.wordpress.com/2009/10/helheim_front.jpg.

flyby (e.g. *Galileo*, *Clipper* or *JUICE*) mission data. It is important to select a landing site that is approximately level and free of debris. The precursor mission will locate landing sites that are free of these obstacles, but conditions on the surface may change and/or the precursor mission may miss fine details.

After landing, surface operation begins; this is illustrated in Figure 9.6. The surface unit attempts to initiate communication with the relay satellite and raises the cryobot to a vertical position. The cryobot is raised on a platform and slowly lowered such that its hot point touches the surface. A surface instrumentation package is also raised with the cryobot to be buried behind it. The cryobot is then lowered to begin its descent, as shown in Figure 9.7. At this point in the descent, the cryobot is sublimating the ice. This is due to the fact Europa does not have an atmosphere. To help promote melting, rather than sublimation, the portion of the surface unit that buries itself in the ice is lowered into the borehole created by the cryobot. Once it is far enough below the surface to protect itself from radiation, it expands flanges that secure it in place and plug the hole.

Eventually the borehole will collapse in on itself, leaving the cryobot in a pocket of its own melt

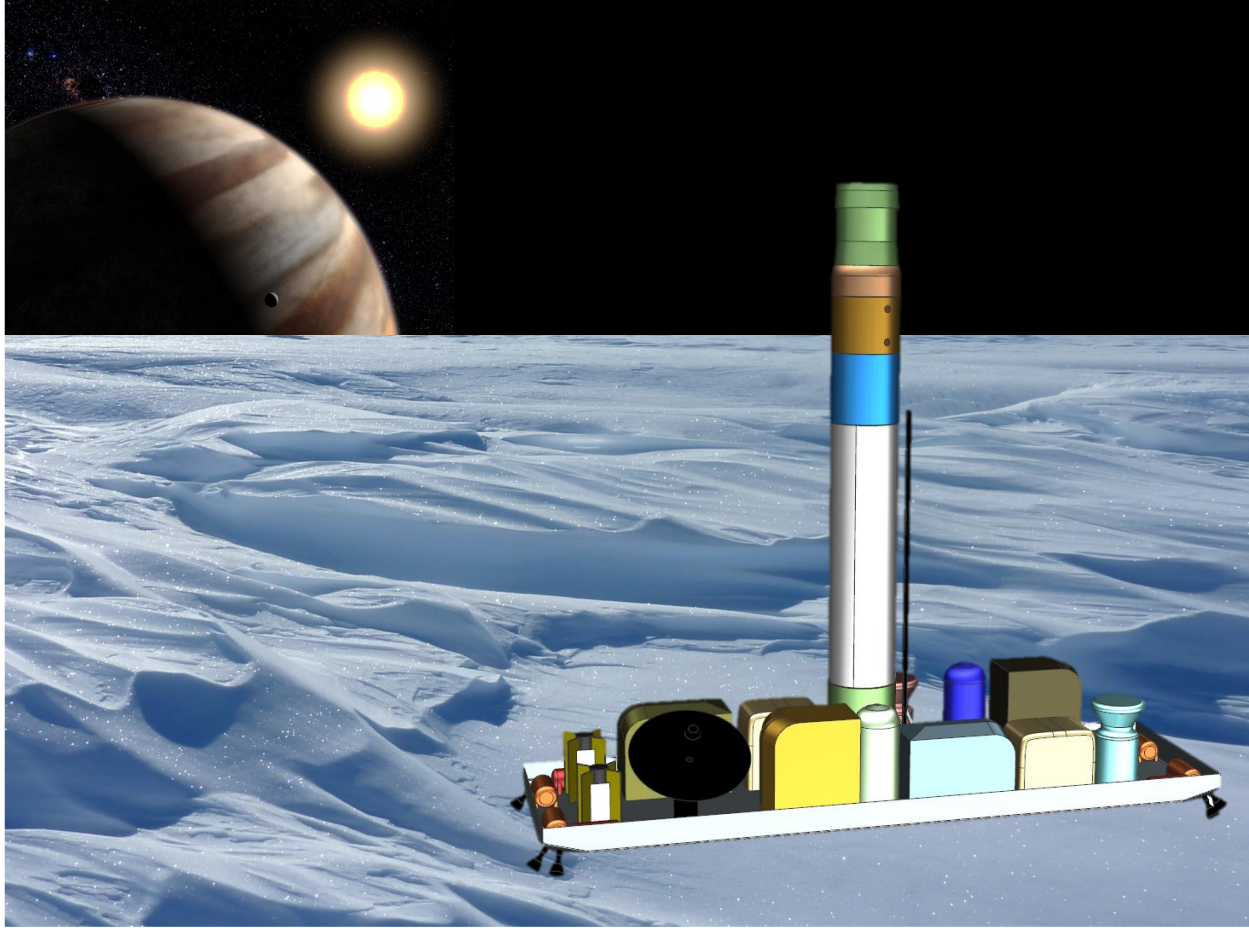

Figure 9.6: Initial surface operation consists of establishing communication and raising the hydrobot to begin its descent. Background images are from <http://breconbeacons.files.wordpress.com/2012/01/felicity-in-antarctica.jpg> and <http://spacetelescope.org/static/archives/images/wallpaper3/opo0138a.jpg>.

water, shown in Figure 9.8. This pocket of melt water is recirculated over the RHU to improve efficiency while continuing its descent. The fiber optic tether to the surface unit is shown embedded in the ice. An ice-embedded transceiver is also shown frozen in place. This transceiver would be released and buoyantly float to the top of the pocket of melt water. It will be frozen in place when the melt water around it cools and refreezes.

The final images, shown in Figure 9.9, show the exploration of the ocean. Figure 9.9(a) shows the hydrobots and cryobot shortly after reaching the ocean. The cryobot is embedded in the ice, so it can be used as a fixed point of reference and a recharging station for the hydrobots. The fiber optic tether is shown as well as an ice-embedded transceiver. The three hydrobots are shown gliding away from the cryobot. These hydrobots are mapping the area around the cryobot for use in SLAM. The hydrobots will also deploy small acoustic beacons for use in LBL positioning. These may be powered by batteries, RPSs, or tidal power. Deploying these beacons facilitates exploring the region too far away from the ice-ocean interface to use SLAM including dives to the ocean floor,



Figure 9.7: Cryobot and surface unit shortly after the descent of the cryobot begins. Background images from <http://breconbeacons.files.wordpress.com/2012/01/felicity-in-antarctica.jpg> and <http://www.polarfield.com/blog/wp-content/uploads/2012/12/DSC00207.jpg>.

and assists in re-localization with SLAM upon ascent to the ice-ocean interface. The exploration of the ocean floor is shown in Figure 9.9(b). This image shows two hydrobots exploring near a hydrothermal vent on the ocean floor. One is swimming away from the hydrothermal vent in order to attempt to locate organisms living in the vicinity of the vent, while the other is hovering near the vent, sampling to analyze the composition of water erupting from the vent. After collecting data near the ocean floor, the hydrobots use LBL positioning to ensure they are ascending near the cryobot. Once near the ice-ocean interface, the hydrobots use SLAM and optical signals from the cryobot to dock with the cryobot to recharge and report data back Earth via the cryobot link to the surface unit.

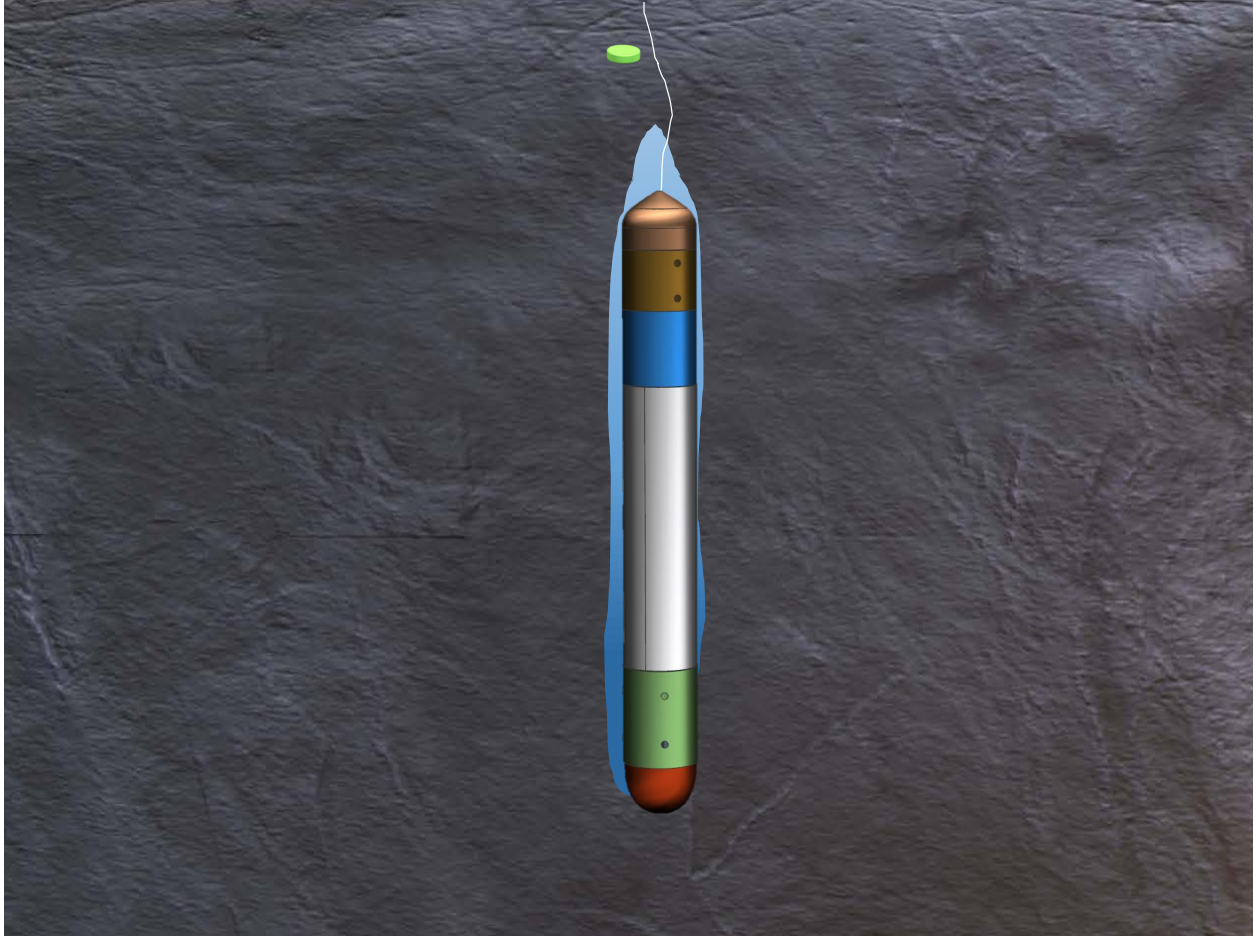
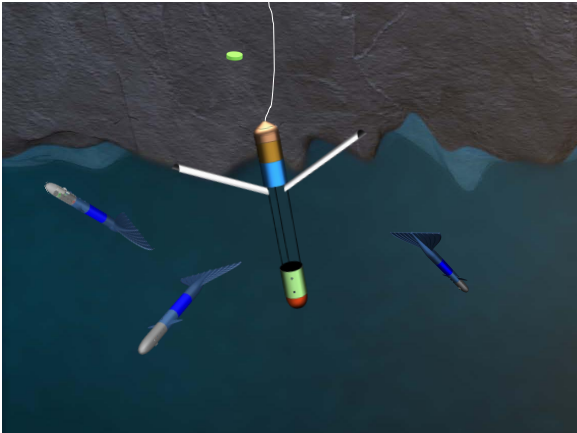
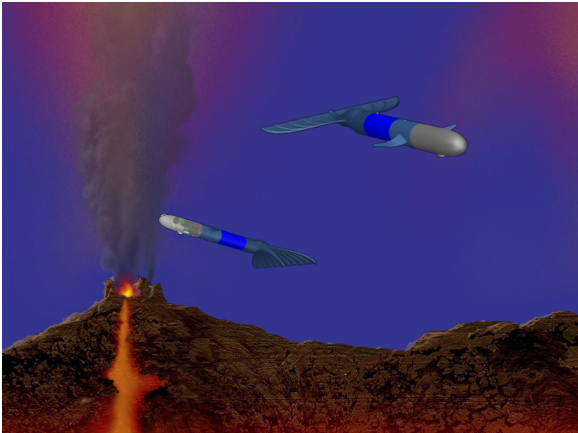

Figure 9.8: Cryobot descending in a pocket of its own melt water. Background images from http://www.jsg.utexas.edu/news/files/mag_cover_v02.jpg.



(a) Cryobot embedded in ice with deployed hydrobots



(b) Hydrobots exploring the ocean floor

Figure 9.9: The exploration of the ocean by hydrobots and cryobots. Background images from http://www.jsg.utexas.edu/news/files/mag_cover_v02.jpg and http://www.nasa.gov/images/content/206105main_pia10131.jpg.

Chapter 10

Conclusions

This report has identified the technology needs of a mission that will travel to Europa, penetrate its ice, and explore the ocean below. A plan for the mission including overviews of the required technologies and mission architectures was developed. This is based on an initial set of mission requirements that provides a list of everything that a mission to Europa should accomplish.

A brief description of the European environment was provided for context of the mission. The phases of the mission, including discussion of existing enabling technologies and challenges, were enumerated to provide an understanding of how this mission will be completed. Prior missions to the outer planets are examined, which provide context and historical data for this mission. The proposed Europa “Clipper” mission is discussed, as it will provide essential knowledge for the planning of later missions to Europa. The science objectives of this mission are discussed. These objectives map the goals of the mission to achieve the driving need for an in-situ study of the European environment in the pursuit of habitable environments and/or extraterrestrial life. A value system is designed which is used to evaluate the design alternatives and potential mission architectures. This value system utilizes an analytical hierarchy process to compare design objectives.

Current state-of-the-art technologies that will facilitate this mission are discussed. These technologies include underwater gliders, melt probes, and spacecraft power sources. The principals of operation and anticipated future developments for each of these technologies are outlined. Potential sensor packages for the hydrobot are discussed. Various design alternatives for the mission are outlined, and five potential mission architectures are carefully evaluated.

The analysis within this report led to the selection of a final notional design for four vehicles, a lander, surface unit, cryobot, and hydrobot. The recommended mission architecture consists of three surface units, each carrying a cryobot, each of which transports three hydrobots through the ice to the ocean. The landing system is integral to each surface unit. The surface unit initiates the descent of the cryobot and buries radiation sensitive components in the tunnel left by the cryobot. Laser communication is used to maintain a communications link between the surface unit and one or more relay satellites, which transmit information back to Earth. The cryobot penetrates the ice using a RHU and maintains communication with the surface unit using a fiber optic tether and separate ice-embedded transceivers. Once the cryobot reaches the ocean, it embeds itself in the ice and releases the hydrobots. The hydrobots utilize a biomimetic propulsion mechanism that

enables both swimming and gliding. Under-ice navigation techniques will utilize a combination of simultaneous localization and mapping and long base-line acoustic positioning supplementing ded reckoning. The hydrobots carry their sensors throughout the ocean, collecting valuable data about Europa and seeking markers of life or habitability. To communicate this data back to Earth, the hydrobots dock with the cryobot. While docked, the hydrobot recharges its battery energy storage system and, once recharged, returns to the ocean to make more discoveries.

Chapter 11

Acknowledgements

The EUROPA team would like to thank NASA Innovative Advanced Concepts for their generous support of this project under grant number NNX12AR07G. We would also like to thank Ray Crum and Dan Scharf of NASA JPL for arranging helpful and informative meetings. The team is grateful to Michael Philen of Virginia Tech for his input on usage of biomimetic propulsion and smart materials. We thank Dale Winebrenner of University of Washington Applied Physics Lab for discussing the current development of melt probes with the team. And lastly, we are grateful to Penelope Boston of New Mexico Tech for her insights on mechanisms to detect signs of life.

Appendix A

Other Ice-Covered Worlds

Europa is not the only known icy body with a subsurface ocean. Indeed, the case for Callisto's ocean was the first and strongest to be made [155, 41], despite Callisto's primitive, cratered surface and undifferentiated interior [156]. Ganymede and Titan [157] also likely contain subsurface oceans, and the geyser activity observed at Enceladus has been suggested to be due to a body of water [158, 159] at an unknown depth. In addition, large icy bodies such as Pluto, Charon, Triton, and possibly Ceres [160] all have the potential to host liquid oceans. Beyond Neptune, the Kuiper belt contains numerous icy bodies, some as large or larger than Pluto.

Most of these other oceans are “perched” between layers of high- and low-pressure ice (Enceladus and Ceres perhaps being exceptions), so the ocean environment is somewhat different from Europa, lacking contact with the silicate portion of the body. Other than that, however, the physical states of all of these oceans must be similar since they are constrained by the phase diagram of water. A layer of liquid between low-pressure ice I and higher pressure phases of ice must exist at pressures below about 210 MPa (equivalent to 20 km depth on Earth) and temperatures within 20 degrees of 0°C (although high ammonia concentrations can allow for oceans as cold as -100°C).

On all of these bodies, access to the ocean poses very similar problems to Europa. On each body (with two exceptions treated below), tens of kilometers of ice must be traversed after landing in a cold and airless environment. The ice on most of these bodies is less active than on Europa, perhaps making it possible to consider less robust descent tether designs. Due to the lower gravity on smaller bodies (Pluto, Charon, Ceres), the depth to the liquid-ice I-ice III triple point is much greater than on Europa, so both the ocean and the ice shell can be considerably thicker, either potentially exceeding 100 km.

Since water is the most abundant compound in the Solar system, it dominates the chemistry of oceans on icy worlds. The composition of these other oceans will therefore be governed by much of the same solution chemistry as Europa's and Earth's, perhaps with fewer of the rock-borne salts (halides, chlorides, sulfides) due to poor contact with the silicate interior. Further from the sun, more volatile compounds condense and become part of the solid bodies. Ices such as methane and ammonia make up more significant portions of the satellites as one moves from Saturn to Neptune and beyond. Ammonia is an effective anti-freeze, lowering the melting point by up to 100 degrees as noted above. This extreme melting point depression only occurs if most of the water has frozen,

concentrating the ammonia in the remaining liquid at molar fractions approaching the eutectic at 30%.

There are two exceptions to these observations that are detailed separately: Enceladus and Titan.

Enceladus is by far the smallest of the bodies listed with putative oceans and yet it is the most active, jetting large geysers into space from fissures (the so-called tiger stripes) near the south pole [161]. The chemistry of the plumes as measured by the Cassini spacecraft indicates a liquid water reservoir below the surface at an unknown depth [158]. Enceladus' activity must be sustained by the input of tidal energy, but the exact mechanism and duration of this process remain very much debated. It seems unlikely that the water reservoir at Enceladus is global, making it more of a subsurface sea than an ocean. The liquid water is potentially quite shallow, perhaps only a few kilometers, though no firm constraints exist. Ammonia is present, but the concentrations in the liquid phase remain unconstrained. The sea of Enceladus may represent a quite different body of water than the oceans discussed above, possibly short-lived, localized, and produced by re-melting of ice.

Titan stands out among the other icy bodies in the solar system due to its massive nitrogen-methane atmosphere. Photochemical processing of methane in the upper reaches of Titan's atmosphere generates an orange layer of hydrocarbons best described as smog. These compounds include ethane, acetylene, and nitrogen-bearing molecules which gradually settle to the surface where, due to the high pressure, ethane is stable as a liquid. This results in the only surface lakes and seas to be found anywhere other than Earth and a "hydrologic" cycle driven by ethane rain. The lakes appear to be seasonal, filling and draining (or evaporating) as Titan travels on its 30-year orbit around the Sun with its rotation axis tilted an Earth-like 27 degrees.

Titan's atmosphere has significant consequences for exploration. First, it is available for use as a decelerator, as demonstrated by the successful descent of the Huygens probe which operated for over an hour on the surface. This would allow soft precision landing of large payloads (e.g. Curiosity). Second, it stabilizes the surface ethane lakes and seas. These provide opportunities for subsurface profiling agents to explore the hydrology and chemistry of the ethane surface liquid. Third, the atmosphere prevents sublimation of the surface ice, allowing an easier start for melt probes and reducing some of the requirements discussed in the body of this report for ensuring a pressurized environment near the surface. Finally, it is unknown what geologic processes influenced by ethane hydrology will do to modify the physical structure of the ice itself. Possibilities include cave formation, porous vadose zones (ethanifers), hydrocarbon deposits, methane and ethane clathrates, and methane gas deposits. This lends a greater range of uncertainty to the properties of the ice, particularly near the surface.

Appendix B

Explanation of Science Traceability Matrix

This appendix largely follows the format of Chapter 4 and provides justification for the scores assigned within the science traceability matrix, Table 4.3.

B.1 Biology

- *Biological Investigation 1:* The first investigation determines if Europa has an environment conducive to life. All of the vehicles can complete this to some extent. Mission architecture 1 does not have a hydrobot, and thus has limited range in the ocean and may miss important details. For this reason it is assigned a score of two; it may complete a partial investigation. Mission architecture 2, with its single hydrobot, will examine a portion of the ocean, but cannot assure global coverage. Thus, this mission architecture has a score of 3; it will complete a partial investigation. Mission architecture 3 has three specialized hydrobots and thus completes an in-depth, but local investigation which may complete a full investigation for a score of four. Mission architectures 4 and 5, with their many hydrobots and wide coverage, will fully complete this investigation, earning a score of 5.
- *Biological Investigation 2:* The next investigation begins to evaluate the likelihood of existence of life on Europa by examining the chemical environment on Europa. This investigation looks for favorable distributions of the chemicals necessary for life, in particular Carbon, Hydrogen, Oxygen, Nitrogen, Phosphorus, and Sulfur. This may require a wide area; as such mission architecture 1 will only touch on this investigation, earning a score of one. Mission architecture 2, will explore a wider area, but not in significant detail, so it may partially address this investigation, earning a score of 2. Mission architecture 3 includes several hydrobots that can explore the region around the cryobot region in detail; however, the single cryobot limits the hydrobots global coverage. Thus, it will complete a partial investigation, earning a score of 3. As before, mission architectures 4 and 5 earn scores of 5 because they complete the investigations over a wide area, ideally a global scale.
- *Biological Investigation 3:* This investigation seeks to determine if life exists how it may sustain energy. This essentially looks for the precursors or by-products of energy production.

This investigation is looking for chemical distributions in the ocean, the sensors are very similar to the previous investigation, and the mission architectures have the same scores as for the previous investigation.

- *Biological Investigation 4*: The next investigation seeks to acquire necessary data for biologists to classify any active biological processes. Mission architecture 1 has little chance of accomplishing this, unless fortuitous circumstances arise (e.g. the cryobot reaches the ocean and finds a plankton bloom). Thus, mission architecture 1 has a score of zero. Mission architecture 2's hydrobot will have the opportunity to search of biological processes, earning a score of one. Mission architecture 3's multiple hydrobots complete a more thorough investigation, but are limited by deployment from a single cryobot and thus may miss important discoveries if it arrives in a biologically uninteresting region. Therefore, it may complete a partial investigation which corresponds to a score of two. Mission architecture 4 has nearly global coverage allowing for potential completion of a full investigation, earning a score of 4. Mission architecture 5's wide coverage (four cryobots) will almost certainly be able to complete the full investigation earning a score of 5.
- *Biological Investigation 5*: The final investigation is to locate organisms. This is the most difficult of the biological investigations because life, if it exists, may be a highly localized, elusive, or esoteric phenomenon. The hydrobot must be close to organisms and thus global coverage and detailed investigation are priorities. Therefore, the scores for this investigation are the same as the previous investigation.

B.2 Ocean Mechanics

- *Ocean Mechanics Investigation 1*: The first investigation is to determine the composition and basic properties of the ocean. Mission architecture 1 scores a one because, although it does not include a hydrobot, it may drop small sensors to give a limited depth profile. Mission architectures 2 and 3 earn a score of three because with only a single hydrobot, the investigation will be geographically limited. Mission architectures 4 and 5 would complete the same investigation as architectures 2 and 3, but they take measurements in a global context. Since both of these mission architectures have nearly global coverage and multiple hydrobots, both earn scores of 5.
- *Ocean Mechanics Investigation 2*: The investigation seeks to describe the amplitude and phase of the tides, the induction response of the ocean, and the surface motion due to the tides. This necessitates use of the surface unit, cryobot, and hydrobots. Mission architecture 1 will be able to touch on this investigation, but will not be able to examine deep-water tides, merely the tides near the surface and the effect of the tides on the ice shell. Thus, it earns a score of one. Mission architectures 2 and 3 will complete a partial (i.e. local) investigation, earning a score of 3. Mission architectures 4 and 5 will complete a full global investigation, earning a score of five.
- *Ocean Mechanics Investigation 3*: The final ocean mechanics investigation, further investigating the Europa's dynamical rotation state, requires widespread coverage of all vehicles,

but the addition of hydrobots does not have a large effect. Therefore, mission architectures 1, 2, and 3 earn the same score, a score of 2. Mission architectures 4 and 5 both have nearly global coverage, so they both earn score of 5.

B.3 Ocean/Ice Interface

- *Ocean/Ice Interaction Investigation 1*: Material exchange, particularly the rate at which material is exchanged between the ocean and the ice crust is to be studied. This investigation does not require particularly advanced sensors and only requires the cryobot, so the primary factor in determining the quality of the investigation is coverage. Thus, mission architectures 1, 2, and 3 all have single point coverage, which means they will complete a partial investigation, earning a score of 3. Mission architectures 4 and 5 both have multi-point coverage, as well as many hydrobots to assist in this investigation, so both mission architectures earn scores of 5.
- *Ocean/Ice Interaction Investigation 2*: The mission will gather data to provide a qualitative and quantitative description of the interface region. The same reasoning applied to Ocean/Ice Interaction Investigation 1 holds here resulting in scores of 3 for mission architectures 1, 2, and 3, and scores of 5 for mission architectures 4 and 5.

B.4 Ice Mechanics

- *Ice Mechanics Investigation 1*: The first investigation is the composition of the ice. Effectiveness of coverage for this investigation is directly correlated to the number of cryobots penetrating the ice. Mission architectures 1, 2, and 3, each with a single cryobot, will gather single point data, earning a score of 3. Mission architecture 4, with three cryobots, earns a score of 4. Mission architecture 5, with four cryobots and the most coverage, earns a score of 5.
- *Ice Mechanics Investigation 2*: The second investigation seeks to determine the mineralogy of the rocky regolith, if present. This investigation is largely dependent upon finding regolith, so multi-vehicle coverage increases probability of success. Mission architectures 1, 2, and 3, each with a single cryobot earn a score of 3. Mission architecture 4, with three cryobots, earns a score of 4. Mission architecture 5, with four cryobots and the most coverage, earns a score of 5.
- *Ice Mechanics Investigation 3*: The third investigation seeks to provide an understanding of the mechanics of the ice. Describing the convecting sublayer requires multi-point coverage to be comprehensive, but not necessarily global coverage. Mission architectures 1, 2, and 3 may complete a partial investigation for a score of two. Mission architectures 4 and 5 have the requisite multi-point coverage, so they earn scores of five.

- *Ice Mechanics Investigation 4*: The mission will seek to characterize the porosity of the ice. One can study the porosity of the ice with a single cryobot, thus mission architectures 1, 2, and 3 earn scores of three. Mission architectures 4 and 5 which enable multi-cryobot, multi-point data, earn scores of five.
- *Ice Mechanics Investigation 5*: The mission will gather data on the temperature profile of the ice. One can generate a temperature profile of the ice with a single cryobot, thus mission architectures 1, 2, and 3 earn scores of three. Mission architectures 4 and 5 which enable multi-cryobot, multi-point data, earn scores of five.
- *Ice Mechanics Investigation 6*: The mission will quantify the thickness of the ice. Coverage is very important in order to differentiate between local and global thickness variations, so mission architectures 1, 2, and 3 with single-point coverage earn scores of 3 for this investigation. Mission architecture has increased coverage, so it earns a score of 4, and mission architecture 5 has the most coverage, earning a score of 5.

B.5 Ocean Floor

All of the other investigations of the ocean floor require a hydrobot because the cryobot and surface unit can not get near the ocean floor to take direct measurements. Thus, mission architecture 1 will score a zero for every ocean floor investigation because it lacks a hydrobot. Similarly, mission architecture 2 will score a one for every ocean floor investigation because its one hydrobot is limited in time near the ocean floor.

- *Ocean Floor Mechanics Investigation 1*: The first investigation is the bathymetry of the ocean floor. Mission architecture 3 has a relatively small area of coverage because the hydrobots are deployed from a single cryobot, so it may miss important features. Thus, mission architecture 3 earns a score of two. Mission architecture 4 has improved coverage with three cryobots, so there is increased probability of the deployed hydrobots detecting important features, earning a score of four. Mission architecture 5 has improved coverage with more hydrobots per cryobot for exploring the ocean floor. Thus, it earns a score of five because it has the greatest probability of detecting interesting features.
- *Ocean Floor Mechanics Investigation 2*: The second scientific investigation under this objective is to locate any on-going geological processes. Coverage is critical for this investigation, therefore, without multiple cryobots from which to deploy the hydrobots, mission architecture 3 earns a score of one. Mission architectures 4 and 5 earn scores of four and five, respectively due to the increased coverage multiple cryobots and hydrobots provide.
- *Ocean Floor Mechanics Investigation 3*: This investigation seeks to study the distribution of important geological features. A single cryobot with multiple hydrobots per mission architecture 3 will potentially be able to complete a partial investigation, at the least studying the immediate vicinity of the cryobot for a score of 2. The increased coverage of the multiple cryobot/multiple hydrobot mission architectures 4 and 5 result in scores of 4 and 5 respectively.

- *Ocean Floor Mechanics Investigation 4*: The composition and mineralogy of the ocean floor will be studied. As before, an increased number of vehicles will improve coverage. The single-cryobot point of entry to the ocean provided by mission architecture 3 results in a score of 2. Mission architectures 4 and 5 will have multiple entry points and multiple hydrobots enabling a more global coverage, thus earning scores of 5.

B.6 Chemistry

- *Chemistry Investigation 1*: The anticipated organic and inorganic chemistry in the ocean is of interest. This investigation looks for chemistry conducive to life. Since mission architecture 1 does not have hydrobots, it will only touch on this investigation, earning a score of one. Mission architectures 2 and 3 both sample the water column on a local scale, so they will complete a partial investigation, which earns a score of three. Mission architectures 4 and 5 complete this investigation on a global scale, which fully completes this investigation, earning a score of five.
- *Chemistry Investigation 2*: The second investigation is to examine the chemistry near the ocean floor. This investigation involves locating features on the ocean floor (e.g. hydrothermal vents), and, as such, is best completed by hydrobots operating near the ocean floor. Thus, mission architecture 1 only touches on this investigation (earning a score of one) and mission architecture 2, whose single hydrobot only spends brief periods near the ocean floor, may complete a partial investigation, if it can locate important features, and thus earns a score of two. Mission architecture 3 has multiple hydrobots that can closely examine the ocean the floor and will complete a local investigation for a score of three. Mission architecture 4 also has multiple hydrobots to closely examine the floor, as well as nearly global coverage and may complete a full investigation, earning a score of four. Mission architecture 5 has the most hydrobots and best coverage. It will complete a full investigation for a score of five.
- *Chemistry Investigation 3*: The final chemistry investigation is a classification of the surface chemistry. This investigation requires the surface unit and coverage. Mission architectures 1, 2, and 3 all have a single surface unit and complete a partial investigation for a score of three. Mission architecture 4 has three surface units and may complete a global investigation for a score of four. Mission architecture 5 has four surface units for improved coverage, earning a score of five.

B.7 Surface Geology

Only the surface unit is required for taking these measurements, as it is the only system that remains on the surface. Thus, mission architectures 1, 2, and 3 share the same scores (they each have a single surface unit), and mission architectures 4 and 5 have their own, individual scores. There is one main criteria for how well a given mission architecture can complete these investigations: coverage.

- *Surface Geology Investigation 1:* The first investigation is to study tectonic, potential magmatic, and impact features on the surface. The single point data presented by mission architectures 1, 2, and 3, each with a single surface unit earns scores of 2 due to a lack of global coverage. The three and four surface unit designs of mission architectures 4 and 5 will both yield effective coverage for this investigation resulting in scores of five.
- *Surface Geology Investigation 2:* The related investigation is to search for areas of recent or current activity. The single point data presented by mission architectures 1, 2, and 3, each with a single surface unit earns scores of 2 due to a lack of global coverage. Mission architecture 4, with three surface units will yield multi-point data and may address the full investigation for a score of 4. Mission architecture 5, with four surface units is mostly likely find an area of recent or current activity, particularly if landing sites can be pre-determined from a multi-flyby precursor mission such as that described in [73] and is assigned a score of 5.
- *Surface Geology Investigation 3:* Understanding the heat flux near the surface is important for understanding the evolution of Europa. The single point data presented by mission architectures 1, 2, and 3, each with a single surface unit earns scores of 2 due to a lack of global coverage. Mission architecture 4, with three surface units will yield multi-point data and may address the full investigation for a score of 4. Mission architecture 5, with four surface units has the best global coverage and is assigned a score of 5.
- *Surface Geology Investigation 4:* The surface unit shall assess the relative age of surface features. The single point data presented by mission architectures 1, 2, and 3, each with a single surface unit earns scores of 2 due to a lack of global coverage. The three and four surface unit designs of mission architectures 4 and 5 will both yield effective coverage for this investigation resulting in scores of five.
- *Surface Geology Investigation 5:* Lastly, the nature of regolith on the surface will be investigated. The single point data presented by mission architectures 1, 2, and 3, each with a single surface unit earns scores of 2 due to a lack of global coverage. Mission architecture 4, with three surface units will yield multi-point data and may address the full investigation for a score of 4. Mission architecture 5, with four surface units has the best global coverage and is assigned a score of 5.

Appendix C

Explanation of the Value System

This appendix provides detail supporting the value system decisions made in Chapter 5 that led to Tables 5.8 and 5.9.

C.1 Notation

As a means of shorthand, when comparing the relative importance of each objective, the notation in Table C.1 is used.

Table C.1: Notation used to describe the relative importance of goals in AHP.

Symbol	Meaning	Score
»»»	“is absolutely more important than”	9
»»	“is very strongly more important than”	7
>	“is strongly more important than”	5
≥	“is weakly more important than”	3
=	“is equally as important as”	1

C.2 Explanation of System Description

In order to efficiently evaluate the relative importance of the design criteria, the performance of each of the subsystems is divided into categories. Referring to Figures 5.2, 5.3, 5.4, and 5.5 for the hydrobot, cryobot, surface unit, and lander respectively, the header rows indicate the design categories with criteria within each category. For example, the hydrobot is evaluated via categories of performance, which deals with the movement and physical performance of the hydrobot, science, which concerns the quality and quantity of scientific measurements, and communication, the ability of the hydrobot to transmit its data back to Earth. These are the same categories as the

cryobot and the surface unit. Since the landing system does not have any science or communication objectives, only its performance is considered. By comparing these categories to each other, AHP is used to calculate their relative importance which will later be used to determine the importance of individual design criteria. Criteria, for example, would be items such as controllability, endurance, mass, navigation error, power, range, and robustness, within the design category of hydrobot performance.

The first step in the AHP is to describe the relative importance of the categories of design criteria. The results of this assessment are contained in Table 5.6. It should be noted that the values along the diagonal of Table 5.6 are one because each objective is as important as itself. Additionally, communication for a given system only concerns the communication of that particular component to Earth. Thus, if a design is chosen that requires the hydrobot to use the cryobot and surface units as links in a communication chain, the hydrobot communication will include the communication between these links.

The first category considered here is hydrobot performance. The performance design criteria focus on the actual hydrobot vehicle, not the tasks the hydrobot will complete. The data collection and communications systems are evaluated separately. First, hydrobot science is *strongly more* important than hydrobot performance reflecting a priority upon quality scientific data. Similarly, unless the hydrobot is capable of communicating the data back to Earth, its performance is not particularly important. Thus, hydrobot communication is *strongly more* important than the hydrobot performance. The cryobot performance is *strongly less* important than the hydrobot performance. This is due to the fact that the overarching goal of this mission is under-ice exploration. As long as the cryobot penetrates the ice delivering the hydrobots, the hydrobot performance is *strongly more* important than the cryobot performance. That being said, the cryobot is capable of taking useful scientific measurements that can lead to a better understanding of Europa, so the cryobot science is *weakly more* important than the hydrobot's performance. Similarly, it is important to relay all of the information collected by the cryobot back to Earth, so the cryobot communication is *strongly more* important than the hydrobot performance. Because the EUROPA mission seeks under-ice data, rather than surface data which potentially can be acquired from an orbital or multiple-flyby mission, the hydrobot's performance is considered *strongly more* important than both the surface unit's performance and science. As before, however, it is important to communicate all data back to Earth, thus the surface unit communication is *weakly more* important than the hydrobot performance. Lastly, the landing system performance is very important for the mission because a poor performing landing system may damage key components or vehicles. Landing system performance is *strongly more* important than the hydrobot performance. To summarize:

- Hydrobot Science > Hydrobot Performance
- Hydrobot Communication > Hydrobot Performance
- Hydrobot Performance > Cryobot Performance
- Cryobot Science \geq Hydrobot Performance
- Cryobot Communication > Hydrobot Performance
- Hydrobot Performance > Surface Unit Performance

- Hydrobot Performance $>$ Surface Unit Science
- Surface Unit Communication \geq Hydrobot Performance
- Landing System Performance $>$ Hydrobot Performance

As previously stated, hydrobot science is strongly more important than hydrobot performance. Also, collecting data is useless without transferring the data back to Earth, so hydrobot communication is *strongly more* important than hydrobot science. The cryobot performance is *strongly less* important than the hydrobot science because, although it is useful to have a high performance cryobot, the data collection of the hydrobot is most vital to the mission. The scientific data that the cryobot can collect is useful, but not as important as the data the hydrobot can collect. Cryobot communication is *weakly more* important than the hydrobot science. The performance and scientific data that can be collected by the surface unit are *very strongly less* important than hydrobot science. That being said, guaranteeing successful relay of scientific data collected by the surface unit is vital, therefore, surface unit communication is *weakly more* important than hydrobot science. The performance of the landing system is very important, but not significantly more (or less) important than hydrobot science.

- Hydrobot Communication $>$ Hydrobot Science
- Hydrobot Science $>$ Cryobot Performance
- Hydrobot Science \geq Cryobot Science
- Cryobot Communication \geq Hydrobot Science
- Hydrobot Science \gg Surface Unit Performance
- Hydrobot Science \gg Surface Unit Science
- Surface Unit Communication \geq Hydrobot Science
- Landing System Performance = Hydrobot Science

The next set of criteria is the hydrobot communication. As previously stated, the hydrobot communication is *strongly more* important than the performance and science of the hydrobot. Similarly, the hydrobot communication is *very strongly more* important than the cryobot performance and *weakly more* important than cryobot science and communication. Performance and science of the cryobot are useful, but priority is placed upon getting the scientific data from the hydrobot back to Earth. The same logic is applied to the surface unit, though with even more emphasis placed on the value of relaying hydrobot data versus gathering data on the surface. Therefore, hydrobot communication is *very strongly more* important than surface unit performance and science, and *strongly more* important than the surface unit communication. The landing system performance is critical in that it safely delivers the cryobot and hydrobot, but the overarching goal of the mission is to communicate the data from the hydrobot back to Earth. Hydrobot communication is deemed *weakly more* important than the landing system performance.

- Hydrobot Communication \gg Cryobot Performance
- Hydrobot Communication \geq Cryobot Science
- Hydrobot Communication \geq Cryobot Communication
- Hydrobot Communication \gg Surface Unit Performance
- Hydrobot Communication \gg Surface Unit Science
- Hydrobot Communication $>$ Surface Unit Communication
- Hydrobot Communication \geq Landing System Performance

The performance of the cryobot deals largely with the ability of the cryobot to effectively penetrate the ice safely delivering hydrobots. This is *weakly less* important than the scientific data that the cryobot will collect. Since it is necessary to deliver the hydrobot to the ocean for the mission to be successful, the cryobot performance is *strongly more* important than the cryobot communication. The cryobot performance is *strongly more* important than the surface unit's performance, so long as the surface unit succeeds in deploying the cryobot. Cryobot performance is *very strongly more* important than the surface unit science, much of which may be feasible without a lander. Communicating the scientific data collected by the surface unit back to Earth is important, so the surface unit communication is *weakly more* important than the cryobot performance. Lastly, it is very important to safely deliver the system to the surface of Europa, thus the landing system performance is *strongly more* important than the cryobot performance.

- Cryobot Science \geq Cryobot Performance
- Cryobot Performance $>$ Cryobot Communication
- Cryobot Performance $>$ Surface Unit Performance
- Cryobot Performance \gg Surface Unit Science
- Surface Unit Communication \geq Cryobot Performance
- Landing System Performance $>$ Cryobot Performance

It is equally important to collect the scientific data as to communicate it back to Earth. The scientific data that cryobot collects is very important, so the performance of the surface unit is *very strongly less* important than the cryobot science. The data collected by the cryobot is *strongly more* important than the data collected by the surface unit. Cryobot science is only *weakly more* important than the surface unit communication, as cryobot data is more important than surface unit data, but data relay is highly valued. As previously stated, it is very useful to have a very good landing system, but it is also important for the cryobot to collect scientific data. Thus, the landing system performance is *weakly more* important than cryobot science.

- Cryobot Science = Cryobot Communication

- Cryobot Science \gg Surface Unit Performance
- Cryobot Science $>$ Surface Unit Science
- Cryobot Science \geq Surface Unit Communication
- Landing System Performance \geq Cryobot Science

Cryobot communication is necessary to relay the scientific data that the cryobot collects back to Earth. Thus, it is *strongly more* important than the surface unit performance and science, while it is only *weakly more* important than surface unit communication. The cryobot communication is equally important as the landing system performance.

- Cryobot Communication $>$ Surface Unit Performance
- Cryobot Communication $>$ Surface Unit Science
- Cryobot Communication \geq Surface Unit Communication
- Cryobot Communication = Landing System Performance

Since the scientific data collected by the surface unit may also be acquirable with orbital or multi-flyby missions, the surface unit performance is *strongly more* important than the surface unit science. It is necessary to communicate the data collected by the surface unit back to Earth, so the surface unit performance is *weakly less* important than the surface unit communication. Since the landing system performance is very important, it is *very strongly more* important than the surface unit performance.

- Surface Unit Performance $>$ Surface Unit Science
- Surface Unit Communication \geq Surface Unit Performance
- Landing System Performance \gg Surface Unit Performance

As previously stated, although much of the information collected by the surface unit may be acquirable by a predecessor orbital or multi-flyby mission, it is still important to communicate surface unit gathered information back to Earth. Thus, the surface unit communication is *strongly more* important than the surface unit science. The landing system performance is *very strongly more* important than the surface unit science. Lastly, since it is important to both communicate the surface unit's data back to Earth as well as to land gently, the surface unit communication and the landing system performance are equally important.

- Surface Unit Communication $>$ Surface Unit Science
- Landing System Performance \gg Surface Unit Science
- Surface Unit Communication = Landing System Performance

C.3 Design Criteria

C.3.1 Hydrobot Performance

Controllability, the ability for the cryobot to get to where it wants, is *strongly less* important than improving navigational error because it is not useful to be able to get to specific locations if the hydrobot does not know where it is. Similarly, reducing navigational error is *strongly* more important than conserving power because it is not useful to have a power efficient hydrobot that cannot figure out where it is. It is equally important to improve controllability and conserve power since these are likely a direct trade off. In summary:

- Navigation Error $>$ Controllability
- Navigation Error $>$ Power
- Power = Controllability

Endurance is important because the longer the hydrobot lasts, the more data it can potentially collect. That said, range is critical along with endurance in order to survey the vast ocean. Therefore, range is *weakly* more important than endurance. Since many of the measurements will not require the hydrobot to reach a precise location, endurance is *weakly* more important than controllability. Because it does not matter how long the hydrobot can last if it is lost, minimizing navigational error is *strongly* more important than endurance. Endurance is *weakly* more important than conserving power because, although it is useful to save power, it is better to last a long time to improve the overall mission performance. In summary:

- Range \geq Endurance
- Endurance \geq Controllability
- Navigation Error $>$ Endurance
- Endurance \geq Power

Although minimizing mass is important, it is conceivable that in the time between now and this mission, a yet larger rocket will exist to transport the additional mass. It is therefore determined that endurance is weakly more important than reducing mass. Similarly, since it is very important to find possibly wide-spread features, the range of the hydrobot is strongly more important than reducing its mass. Controllability and mass are directly related and equally important. It is not helpful to reduce the mass of the hydrobot if it gets lost, so navigational error is strongly more important than minimizing the mass of the hydrobot. Power and mass are likely a direct trade-off, and power will be limited on the hydrobot. It is determined that power is weakly more important than mass. In summary:

- Endurance \geq Mass

- Range > Mass
- Controllability = Mass
- Navigation Error > Mass
- Power \geq Mass

Range, the distance the hydrobot can travel, is *strongly* more important than controllability because covering more ground is more important than getting to a precise location (with the exception of docking). The navigational error is *weakly* more important than range because it is not useful to cover a wide range if you get lost. Improving range is *weakly* more important than conserving power because increasing range increases the science potential of the mission, a result worthy of using power. In summary:

- Range > Controllability
- Navigation Error \geq Range
- Range \geq Power

Robustness is *weakly* more important than mass because, although it is not beneficial to add mass to the hydrobot, it is possible to build a larger rocket, but it is not possible to repair a damaged hydrobot on Europa. Similarly, robustness is *weakly* more important than endurance; while it is important to operate for a long duration, such operation is irrelevant if critical systems are non-functional. Range and robustness are *equally* important due to the coupled need to cover vast distances without system failure. The hydrobot's controllability is *weakly* more important than robustness because it is not beneficial to have a functional hydrobot if it cannot position as needed. Similarly, minimizing navigational error is *strongly* more important than robustness because it is not useful to have a functioning, but lost, hydrobot. Lastly, since power on the hydrobot will be limited, minimizing power consumption is *weakly* more important than robustness. In summary:

- Robustness \geq Mass
- Robustness \geq Endurance
- Robustness = Range
- Controllability \geq Robustness
- Navigation Error > Robustness
- Power \geq Robustness

These criteria are listed in Table C.2.

C.3.2 Hydrobot Science

Accuracy is an important design objective for post-mission data analysis, however, it should not be prioritized such that it would jeopardize the mission. Thus, forward contamination is *weakly* more important than accuracy. Sampling efficiency is *strongly* more important than accuracy since it is not useful to take accurate but inefficient measurements. It is not useful to use excess power to improve accuracy, nor is it useful to improve power efficiency at the cost of accuracy. Therefore, power is *equally* important to accuracy. Since it is better to take a more detailed profile than fewer more accurate measurements, resolution is *weakly* more important than accuracy. Along the same lines, better diversity will lead to discovering more important features so diversity is *weakly* more important than accuracy. In summary:

- Forward Contamination \geq Accuracy
- Sampling Efficiency $>$ Accuracy
- Power = Accuracy
- Resolution \geq Accuracy
- Diversity \geq Accuracy

Because it is far more important to find interesting phenomenon in the first place than to have slightly better measurements, coverage of the hydrobot is *strongly* more important than the accuracy. Minimizing forward contamination is *strongly* more important than increasing coverage since the hydrobot will be in regions with potentially sensitive biology and forward contamination could destroy all fundamental science goals of this study and/or have catastrophic impact upon Europa. Coverage is *equally* important to sampling efficiency since expanding coverage is useless without efficient data schemes. Power is *weakly* more important than coverage since power is limited. Because data locations can be chosen intelligently, resolution is *equally* important to coverage. Diversity is *weakly* more important than coverage to avoid missing small features while gathering data. In summary:

- Coverage $>$ Accuracy
- Forward Contamination $>$ Coverage
- Coverage = Sampling Efficiency
- Power \geq Coverage
- Resolution = Coverage
- Diversity \geq Coverage

Avoiding forward contamination is crucial from a scientific and ethical standpoint. The decision tree for this criteria is based upon the assumption that all available techniques for mitigating forward contamination shall be used, and that decisions presented here would represent extenuating measures above and beyond the state of the art. Forward contamination presents the issue of polluting the European environment. While eliminating man-made influences on the moon is ideal, for the purpose of the hydrobot's mission, it is better to gather data intelligently than to reduce forward contamination caused by the science equipment. Therefore, sampling efficiency is *strongly* more important than forward contamination. Since there is limit on power, power reduction is *equally* important to avoiding forward contamination. As for resolution, it is more important to limit forward contamination than to improve resolution so resolution is *weakly less* important. Lastly, diversity is *weakly* more important than forward contamination, since collecting a variety of data outweighs the risks of any contamination caused by the hydrobot's instruments. In summary:

- Sampling Efficiency $>$ Forward Contamination
- Power = Forward Contamination
- Forward Contamination \geq Resolution
- Diversity \geq Forward Contamination

Sampling efficiency for the hydrobot is either equally or more important than the other criteria. It is *weakly* more important than power because efficient data collection will help manage power limitations. Sampling efficiency is *equally* important to resolution and diversity; these three criteria depend equally upon each other. In summary:

- Sampling Efficiency \geq Power
- Sampling Efficiency = Resolution
- Sampling Efficiency = Diversity

Power is *strongly less* important than resolution and diversity since the quantity and quality of data gathered is more important than the power efficiency of the vehicle. Finally, resolution is equally important to diversity since, as mentioned earlier, the criteria are dependent upon each other. In summary:

- Resolution $>$ Power
- Diversity $>$ Power
- Resolution = Diversity

These criteria are listed in Table C.3.

C.3.3 Hydrobot Communication

When considering access frequency, access duration is *weakly* more important since it is better to be in communication for a long period of time than very frequently. These greater lengths of time ensure that individual chunks of data will be transmitted without interruption. Power is *strongly* more important than average access frequency since it makes a larger impact in mission success of the hydrobot. Compared to access duration, power is likewise *strongly* more important. Robustness is *strongly* more important than the access frequency since it is essential that the system will work throughout the entirety of the mission. Robustness, however, is *equally* important to access duration since both are essential in the communications architecture. In summary:

- Access Duration \geq Access Frequency
- Power $>$ Access Frequency
- Power $>$ Access Duration
- Robustness $>$ Access Frequency
- Robustness = Access Duration

One goal is to maximize the quantity of data returned from the hydrobot over the entire mission duration. As such, average data rate is *weakly* more important than both access frequency and access duration. Still, the power requirement of the communications system will be a greater mission constraint than the average data rate, so power is *weakly* more important. Robustness is *weakly* more important than average data rate since a broken communications system will be useless. In summary:

- Average Data Rate \geq Access Frequency
- Average Data Rate \geq Access Duration
- Power \geq Average Data Rate
- Robustness \geq Average Data Rate

Because the hydrobot will be gathering vast amounts of data in the under-ice ocean, peak data rate is generally less important than the other communication criteria. Since it is better to send a larger amount of data over the mission duration than small bursts of data at specific points in time, average data rate and access frequency are *strongly* more important than peak data rate. By similar reasoning, access duration is *weakly* more important than peak data rate. Power is *very strongly* more important than peak data rate since power plays a much larger role in constraining mission design. In communications, particularly, power requirements will have entirely different scales depending on the method of communication. Robustness is *strongly* more important than peak data rate since the peak data rate is useless if the communications equipment fails. Finally, power is *weakly* more important than robustness because of its substantial impact upon hydrobot communication. In summary:

- Average Data Rate $>$ Peak Data Rate
- Access Frequency $>$ Peak Data Rate
- Access Duration \geq Peak Data Rate
- Power \gg Peak Data Rate
- Robustness $>$ Peak Data Rate
- Power \geq Robustness

These criteria are listed in Table C.4.

C.3.4 Cryobot Performance

Attitude control is *weakly* more important than descent rate because increasing the descent rate can lead to the need for additional attitude control [162]. Increasing the payload capacity is *strongly* more important than attitude control because improving the attitude control does not improve the mission capabilities of the cryobot. Power consumption for locomotion and other systems is vital for the mission. Since active attitude control requires power, improving the attitude control likely increases the power consumption. Thus, attitude control is *very strongly less* important than both the power consumption for locomotion and other systems. In summary:

- Attitude Control \geq Descent Rate
- Payload $>$ Attitude Control
- Power (Locomotion) \gg Attitude Control
- Power (System) \gg Attitude Control

The descent rate, so long as it is sufficiently high, does not jeopardize the mission. It can then be assumed that the payload capacity and power consumption for both locomotion and other systems are *very strongly* more important than the descent rate. In summary:

- Payload \gg Descent Rate
- Power (Locomotion) \gg Descent Rate
- Power (System) \gg Descent Rate

Endurance is vital for this mission. As such, since the attitude control and descent rate can be comparably less precise without jeopardizing the mission, endurance is *very strongly* more important than attitude control and descent rate. Carrying extra payload will benefit the mission approximately the same as improving endurance; endurance and payload capacity are *equally* important. Since reducing power consumption will likely increase the endurance of the cryobot, endurance is *weakly less* important than reducing the power consumption for both locomotion and other systems. In summary:

- Endurance \gg Attitude Control
- Endurance \gg Descent Rate
- Payload = Endurance
- Power (Locomotion) \geq Endurance
- Power (System) \geq Endurance

The mass of the cryobot is *weakly less* important than its endurance because, although it is possible to launch more mass, it is important for the cryobot to survive for a long enough period of time to collect data and perform other mission operations. As long as the cryobot doesn't "topple over" or become entrenched in regolith, the attitude control is *very strongly less* critical for the success of the mission than the mass of the cryobot. The descent rate, as long as it is sufficiently high, is not absolutely necessary for the success of the mission. Thus, the mass is *very strongly* more important than the descent rate. Since the payload capacity and mass present a direct trade-off (reducing mass allows more payload to be carried), these are *equally* important. Reducing the power consumption for locomotion and other systems is *strongly* more important than reducing mass because power is a very limited resource. In summary:

- Endurance \geq Mass
- Mass \gg Attitude Control
- Mass $>$ Descent Rate
- Mass = Payload
- Power (Locomotion) $>$ Mass
- Power (System) $>$ Mass

The payload capacity concerns both mass and volume. Since increasing the volume capacity typically means increasing the size of the cryobot, improving the payload capacity requires more power output. Thus, it is *weakly* more important to improve the power consumption for locomotion than to improve the payload capacity. Since this trade-off does not exist for the power consumption of the other systems, the system power consumption criteria is *equally* important as the payload capacity criteria. Lastly, since the locomotive power consumption will likely be substantially greater than the power consumption of the other systems, the locomotive power consumption is *weakly* more important. In summary:

- Power (Locomotion) \geq Payload
- Power (System) = Payload
- Power (Locomotion) \geq Power System

Robustness is *strongly* more important than reducing mass. This is because, although it is possible to seek progressively more capable launch vehicles to carry more mass to Europa, it is not possible to repair a damaged cryobot on Europa. The ability of the cryobot to operate for a long period is *equally* as important as its robustness primarily because they are interrelated. A robust cryobot will like have a long endurance, and vice versa. The robustness is *very strongly* more important the the ability of the cryobot to control its attitude and its descent rate. The cryobot must be kept in a near vertical position in order to avoid “tipping” [162] and must be capable of navigating around regolith. This can be accomplished by several straightforward means [108], so priority is given toward improving robustness. Increasing the descent rate only serves to reduce the mission duration. As such, as long as a slower descent rate does not jeopardize the mission (e.g. cryobot refreezing), there is little advantage to reducing the robustness for the sake of improving the descent rate. Since the payload (primarily the hydrobots) is vital to the overall success of the mission, it is important to be maximized. However, it is not advantageous to carry a larger payload if it reduces system robustness, so the robustness is *weakly* more important than the payload capacity. The locomotive power consumption is *weakly* more important than robustness primarily because the locomotive power consumption will likely be very high, on the order of kilowatts, and can increase rapidly if an inefficient design is chosen [162]. The relatively lower power consumption of the other systems is less of a concern than the power consumption for locomotion. As such, it is *equally* important as robustness. In summary:

- Robustness > Mass
- Robustness = Endurance
- Robustness ≫ Attitude Control
- Robustness ≫ Descent Rate
- Robustness ≥ Payload
- Power (Locomotion) ≥ Robustness
- Power (System) = Robustness

These criteria are listed in Table C.5.

C.3.5 Cryobot Science

The diversity of the cryobot’s data is very limited. The cryobot will only be able to take measurements from within its melt-hole of the ice. Thus, since the cryobot cannot easily improve the diversity of the data, diversity is *strongly less* important than accuracy, power consumption, and sampling efficiency. The primary scientific measurements for the mission will be taken by the hydrobot, so the accuracy of the cryobot’s measurements are slightly deemphasized. That being said, it is still important to have good measurements. Thus, the accuracy of the cryobot data is *weakly less* important than the forward contamination, sampling efficiency, and resolution. Since power is

not as limited on the cryobot by comparison to the hydrobot, the accuracy and power consumption are *equally* important.

To summarize:

- Accuracy > Diversity
- Power > Diversity
- Sampling Efficiency > Diversity
- Forward Contamination \geq Accuracy
- Sampling Efficiency \geq Accuracy
- Resolution \geq Accuracy
- Power = Accuracy

The cryobot will have full depth coverage because it penetrates the ice from the moon's surface to the top of the ocean. Further, the cryobot has very restricted horizontal motion capabilities, so it is not easy to greatly improve coverage. Thus, coverage is *strongly less* important than accuracy, forward contamination, sampling efficiency, and resolution. Since the scientific instruments on the cryobot will not require significant amounts of power, conserving power is only *weakly* more important than coverage. Lastly, the diversity of the data is limited in a similar manner to coverage. Thus, it is *equally* as important. To summarize:

- Accuracy > Coverage
- Forward Contamination > Coverage
- Sampling Efficiency > Coverage
- Resolution > Coverage
- Power \geq Coverage
- Diversity = Coverage

Since forward contamination can jeopardize this and future missions, it is among the most important objectives. Data diversity and power consumption are *strongly less* important than limiting forward contamination, and resolution is *weakly less* important than forward contamination. Since there are few measurements the cryobot can take, sampling efficiency is very important. So much so that it is acceptable to some extent to increase risk of forward contamination if it leads to improved sampling efficiency. Thus, sampling efficiency is *weakly* more important than forward contamination. To summarize:

- Forward Contamination > Diversity

- Forward Contamination $>$ Power
- Forward Contamination \geq Resolution
- Sampling Efficiency \geq Forward Contamination

Improving sampling efficiency is a way of saving power; power consumption and sampling efficiency are a direct trade-off and are thus *equally* important. Since it is more important to intelligently take measurements than take a huge quantity, sampling efficiency is *weakly* more important than resolution. Power will not be as limited on the cryobot (versus the hydrobot), it can be sacrificed to improve resolution. Thus resolution is *strongly* more important than power consumption. The diversity of the data cannot be improved; the only way to improve the content of the data is to improve the resolution. Resolution is *very strongly* more important than the diversity of the data. To summarize:

- Sampling Efficiency = Power
- Sampling Efficiency \geq Resolution
- Resolution $>$ Power
- Resolution \gg Diversity

These criteria are listed in Table C.6.

C.3.6 Cryobot Communication

The access duration is directly related to how much data can be transferred. Thus, it is *equally* important as the robustness of the communication. Since reducing power consumption would likely require greater access duration, power consumption is *weakly* more important than access duration. To summarize:

- Robustness = Access Duration
- Power \geq Access Duration

Access frequency, how often the cryobot is in contact with Earth, is *weakly less* important than access duration as this represents a tradeoff between local data storage versus duration of transmission opportunities. Both robustness and power consumption are *strongly* more important than access frequency because there is little advantage to increasing the access frequency if it makes the link more likely to fail or requires more power, provided sufficient local storage is available. To summarize:

- Access Duration \geq Access Frequency

- Power $>$ Access Frequency
- Robustness $>$ Access Frequency

The average data rate is the primary measure of how much data can be transferred from the cryobot to Earth. Thus it is *weakly* more important than the access frequency and duration since rapid data rates can reduce burden on access frequency and duration. A direct trade-off exists between the power consumption and the average data rate, therefore they are *equally* important. It is vital to return scientific data, even if improving robustness sacrifices the amount of data that can be returned. Thus, robustness is *weakly* more important than the average data rate. To summarize:

- Average Data Rate \geq Access Frequency
- Average Data Rate \geq Access Duration
- Average Data Rate = Power
- Robustness \geq Average Data Rate

The average data rate, access frequency, power consumption, and robustness are *strongly* more important than the peak data rate reflecting a priority on bulk data transfer over short burst speed. Access duration is *weakly* more important than the peak data rate reflecting a tradeoff between duration of access and transfer speed. Lastly, since it is not useful to have an efficient system that is prone to failure, robustness is *weakly* more important than power consumption. To summarize:

- Average Data Rate $>$ Peak Data Rate
- Access Frequency $>$ Peak Data Rate
- Power $>$ Peak Data Rate
- Robustness $>$ Peak Data Rate
- Access Duration \geq Peak Data Rate
- Robustness \geq Power

These criteria are listed in Table C.7.

C.3.7 Surface Unit Performance

The mass of the surface unit is not a major design consideration, presuming a sufficiently sized launch vehicle exists. That is, if it will improve the surface unit's abilities, it is possible to launch more mass to Europa without greatly affecting other design objectives. That being said, it is never ideal to needlessly increase launch costs. Thus, improving radiation hardness and reducing power consumption are *weakly* more important than reducing the mass of the surface unit. For that matter,

reducing radiation protection required will reduce mass. Similarly, improving power efficiency will reduce mass. Since the primary mission role of the surface unit is to start the descent of the cryobot, this ability is *strongly* more important than reducing the mass of the surface unit. Since there is limited utility for improving the endurance, endurance is *weakly less* important than the mass of the surface unit. To summarize:

- Radiation Hardness \geq Mass
- Power \geq Mass
- Cryobot Starting Ability $>$ Mass
- Mass \geq Endurance

Since an operational surface unit is imperative for mission success, robustness is a highly important design criteria. The primary penalty of increasing the mass of the surface unit is to increase the launch costs of the mission, which, although not ideal, are not physical limits, presuming a sufficient launch vehicle exists. Thus, reducing the mass of the surface unit is *strongly less* important than improving robustness. After the surface unit starts the cryobot, its mission is largely complete. Thus, so long as a failure does not cause a break in the communication link (which is not considered in this criteria), the endurance of the surface unit can be deprioritized. Thus, robustness is *strongly* more important than endurance. Inadequate radiation hardness can lead to damage to the cryobot and hydrobot in addition to the surface unit, thus it is *weakly* more important than the robustness of the surface unit. The primary role of the surface unit is to start the cryobot's descent, thus the surface unit's ability to start the cryobot is *strongly* more important than the robustness of the surface unit. The surface unit does not suffer the same size constraints as the hydrobot or cryobot in terms of power source, therefore, for the surface unit, robustness is *strongly* more important than reducing power consumption. To summarize:

- Robustness $>$ Mass
- Robustness $>$ Endurance
- Radiation Hardness \geq Robustness
- Cryobot Starting Ability $>$ Robustness
- Robustness $>$ Power

The endurance of the surface unit's systems, exempting its communication ability, is not of the highest importance once it has successfully initiated the cryobot's descent. The surface unit's ability to start the descent of the cryobot is *very strongly* more important than the endurance of the surface unit. Radiation hardness, being necessary for the protection of the surface unit, cryobot, and hydrobot, is *strongly* more important than endurance. Power consumption is not one of the major concerns for the surface unit, it is only *weakly* more important than endurance. Similarly, power consumption is *strongly less* important than both the radiation hardness and the cryobot

starting ability because both radiation hardness and the cryobot starting ability are critical to mission success. Lastly, since the primary role of the surface unit is to start the Cryobot's descent, its ability to do so is *weakly* more important than its ability to protect itself, as well as the cryobot and hydrobot(s), from radiation. To summarize:

- Cryobot Starting Ability \gg Endurance
- Radiation Hardness $>$ Endurance
- Power \geq Endurance
- Radiation Hardness $>$ Power
- Cryobot Starting Ability $>$ Power
- Cryobot Starting Ability \geq Radiation Hardness

These criteria are listed in Table C.8.

C.3.8 Surface Unit Science

The accuracy of the scientific measurements is important such that the data collected yields high-confidence results. That said, forward contamination can jeopardize this and future missions and reduce accuracy, therefore, protection against forward contamination is *strongly* more important than accuracy. Efficient sampling is *weakly* more important than accuracy. Although power will be less constrained for the surface unit than the hydrobot or cryobot, it will be needed for data collection. Minimizing power consumption is *weakly* more important than accuracy. Since there is little capability for improving the resolution for the relatively immobile surface unit, the accuracy is *very strongly* more important than resolution. To summarize:

- Forward Contamination $>$ Accuracy
- Sampling Efficiency \geq Accuracy
- Power \geq Accuracy
- Accuracy \gg Resolution

The surface unit likely will not move over any great distance making it difficult to improve coverage. Therefore, taking accurate measurements is *strongly* more important than coverage. Since there is no atmosphere and low gravity relative to Earth at Europa's surface, any contamination can spread easily. Thus, limiting forward contamination is *very strongly* more important than improving coverage. There are limited measurements the surface unit can take leading to the conclusion that sampling efficiency is *weakly* more important than coverage. Since improving coverage will likely require additional power expenditure, reducing power consumption is *weakly* more important than improving coverage. Cost associated with improving resolution leads to the conclusion that improving resolution is *weakly less* important than coverage. To summarize:

- Accuracy > Coverage
- Forward Contamination \gg Coverage
- Sampling Efficiency \geq Coverage
- Power \geq Coverage
- Coverage \geq Resolution

There are only a few measurements that can be taken from the surface and these measurements are not anticipated to vary dramatically over the surface. Diversity of the data is therefore *strongly less* important than coverage, accuracy, prevention against forward contamination, and reduced power consumption. Much like data diversity, for the surface unit sampling efficiency can only be improved to a limited extent due to the relative immobility of the unit. Diversity and sampling efficiency are treated as *equally* important. Improving data diversity is *weakly* more important than resolution. To summarize:

- Coverage > Diversity
- Accuracy > Diversity
- Forward Contamination > Diversity
- Power > Diversity
- Diversity = Sampling Efficiency
- Diversity \geq Resolution

Mitigation of forward contamination, with its potential to jeopardize this and future missions, is among the most important criteria. There is little benefit to collecting data efficiently if it contaminates the surface, so limiting forward contamination is *very strongly* more important than sampling efficiency. Limiting forward contamination is *weakly* more important than reducing power consumption, recognizing that power sources are one of the most likely potential sources of inadvertent forward contamination. Limiting forward contamination is *strongly* more important than improving data resolution. To summarize:

- Forward Contamination \gg Sampling Efficiency
- Forward Contamination \geq Power
- Forward Contamination > Resolution

Reducing power consumption is *strongly* more important than sampling efficiency, though these are correlated as sampling efficiently will reduce power consumption. Since there is limited ability to improve resolution, it is better to smartly collect the data. Thus, sampling efficiency is *weakly* more important than resolution. Reducing power consumption is *very strongly* more important than improving resolution for the surface unit due to the inherent resolution constraints of the surface unit. To summarize:

- Power $>$ Sampling Efficiency
- Sampling Efficiency \geq Resolution
- Power \gg Resolution

These criteria are listed in Table C.9.

C.3.9 Surface Unit Communication

Like the science design objectives, the communication design objectives do not differ between the hydrobot, cryobot, and surface unit. Criteria score differences arise from the different mission roles. That said, the communication requirements for the cryobot and surface unit are similar. The following criteria are the same:

- Average Data Rate $>$ Peak Data Rate
- Access Duration \geq Peak Data Rate
- Robustness $>$ Peak Data Rate
- Robustness \geq Average Data Rate
- Access Duration \geq Access Frequency
- Robustness $>$ Access Frequency
- Power \geq Access Duration
- Robustness = Access Duration
- Robustness \geq Power

The primary difference comes from the fact that the surface unit will likely have more excess power than than the cryobot. Thus, the peak data rate, average data rate, and access frequency are more important with respect to power consumption on the surface unit. Specifically, reducing power consumption is *weakly* more important than peak data rate and access frequency and *weakly less* important than average data rate. To summarize:

- Power \geq Peak Data Rate
- Power \geq Access Frequency
- Average Data Rate \geq Power

Since the surface unit will act as a relay for data traveling from Europa to Earth, access duration for the surface unit is more important with respect to the actual amount of data for the surface unit than the same comparison for the cryobot. Thus, access duration and average data rate are *equally* important. Lastly, since the surface unit will act as a relay, it is important to be in frequent communication. Access frequency is *very strongly* more important than peak data rate, and *weakly* more important than average data rate. To summarize:

- Access Duration = Average Data Rate
- Access Frequency \gg Peak Data Rate
- Access Frequency \geq Average Data Rate

These criteria are listed in Table C.10.

C.3.10 Landing System Performance

Since some environmental exposure during descent can be tolerated, it is *strongly less* important than both navigational accuracy and local contamination. Limiting the impact energy protects the surface unit, cryobot, and hydrobot(s) from damage during descent. Thus reducing impact energy is *strongly* more important than reducing both the power consumption for locomotion and other systems. Since it is not helpful to carry a larger payload if it increases impact energy, payload capacity is *strongly less* important than reducing impact energy. Both navigational accuracy and protecting the cargo from environmental exposure during descent are critical for mission success, these design objectives are only *weakly less* important than reducing the impact energy. Since local contamination can jeopardize this mission similar to impacting the surface too hard, preventing local contamination is *equally* as important as reducing the impact energy. To summarize:

- Navigational Accuracy $>$ Environmental Exposure
- Local Contamination $>$ Environmental Exposure
- Impact Energy $>$ Power (Locomotion)
- Impact Energy $>$ Power (System)
- Impact Energy $>$ Payload
- Impact Energy \geq Navigational Accuracy
- Impact Energy \geq Environmental Exposure
- Impact Energy = Local Contamination

Mitigation of local contamination is of the utmost importance, even *weakly* more important than navigational accuracy and *very strongly* more important than reducing the mass of the landing system. Limiting the mass of the landing system is important because it reduces the launch costs, but is not necessarily critical for mission success. Whereas, reducing the impact energy is among the most important objectives; it is *very strongly* more important than reducing the mass of the landing system. Since landing near the desired location may be critical for mission success, it is *strongly* more important reducing the mass. Similarly, increasing the payload capacity is *strongly* more important than reducing the mass because increasing the payload allows for increasing the mission capabilities overall. For the landing system, reducing the mass is more important than reducing power consumption. Power consumption for locomotion is expected to be relatively low (igniting a thruster), so there is little advantage to improving it. Thus, power consumption for locomotion is *strongly less* important than reducing the mass. The power consumption for other systems may be much greater than for locomotion for the landing system; power consumption for non-locomotive systems is *weakly less* important than reducing the mass. The surface unit, cryobot, and hydrobot shall be designed to tolerate some minimal amount of environmental exposure; therefore, reducing the mass of the landing system is *strongly* more important than reducing environmental exposure during descent. To summarize:

- Local Contamination \geq Navigational Accuracy
- Local Contamination \gg Mass
- Impact Energy \gg Mass
- Navigational Accuracy $>$ Mass
- Payload $>$ Mass
- Mass $>$ Power (Locomotion)
- Mass \geq Power (System)
- Mass $>$ Environmental Exposure

Increasing the payload capacity of the landing system allows for the delivery of more scientific equipment. Locomotive power consumption will likely be less than that required for other systems; power consumption for locomotion is *strongly less* important than improving payload capacity, while the reducing the power consumption of the other systems is *weakly less* important than payload capacity. As it is not useful to deposit the lander carried vehicles in an unsafe or impenetrable location, navigational accuracy is *strongly* more important than payload capacity. If the landing system is not capable of delivering the payload to the surface, concerns about local contamination will be irrelevant. Therefore, payload capacity is *strongly* more important than local contamination. Since the payload can sustain minor exposure during descent, payload capacity is *weakly* more important than environmental exposure during descent. To summarize:

- Payload $>$ Power (Locomotion)

- Payload \geq Power (System)
- Navigational Accuracy $>$ Payload
- Payload $>$ Local Contamination
- Payload \geq Environment Exposure

Power consumption for locomotion can be kept relatively low; therefore, it is *weakly* more important than power consumption for other systems. Since navigational accuracy is vital to mission success, it is *very strongly* more important than power consumption for locomotion. Local contamination may jeopardize the mission and is of great ethical concern, so limiting contamination is *strongly* more important than power consumption for locomotion. Since the landing system can tolerate environmental exposure on descent, so power consumption for locomotion is *equally* important as limiting environmental exposure on descent. In much the same way, power consumption for other systems is *very strongly less* important than navigational accuracy, *strongly less* important than local contamination, and *equally* important as environmental exposure during descent. To summarize:

- Power (Locomotion) \geq Power (System)
- Navigational Accuracy \gg Power (Locomotion)
- Local Contamination $>$ Power (Locomotion)
- Environmental Exposure = Power (Locomotion)
- Navigational Accuracy \gg Power (System)
- Local Contamination $>$ Power (System)
- Environmental Exposure = Power (System)

The robustness of the landing system is of high important because, if the landing system cannot tolerate off-nominal conditions, the entire mission may be lost from an otherwise minor failure. Yet, because the landing system serves no purpose after landing, it is also important to minimize its mass. So the reducing the mass and improving the robustness of the landing system are *equally* important. Despite the fact that robustness is important, the exploration vehicles (cryobot, hydrobot, surface unit) are more important. This leads to the conclusion that impact energy and payload are *strongly* more important than robustness. Conversely, due to the comparative ease of providing power to the landing system, robustness is *strongly* more important than power consumption for both locomotion and other systems. Since it may be important for the mission to land near the desired target, navigational accuracy is *equally* important as robustness. Limiting local contamination is *strongly* more important than robustness. Lastly, because the various components can be designed to withstand some amount of damage during descent, but not a high-velocity impact, the robustness of the landing system is *weakly* more important than limiting the environmental exposure during descent. To summarize:

- Robustness = Mass
- Impact Energy > Robustness
- Payload > Robustness
- Robustness > Power (Locomotion)
- Robustness > Power (System)
- Navigational Accuracy = Robustness
- Local Contamination > Robustness
- Robustness \geq Environmental Exposure

These criteria are listed in Table C.11.

Table C.2: Hydrobot performance design criteria pairwise comparison.

	Controllability	Endurance	Mass	Navigation Error	Power	Range	Robustness
Controllability	1	1/3	1	1/5	1	1/5	3
Endurance	3	1	3	1/5	3	1/3	1/3
Mass	1	1/3	1	1/5	1/3	1/5	1/3
Navigation Error	5	5	5	1	5	3	5
Power	1	1/3	3	1/5	1	1/3	3
Range	5	3	5	1/3	3	1	1
Robustness	1/3	3	3	1/5	1/3	1	1

Table C.3: Hydrobot science design criteria pairwise comparison.

	Accuracy	Coverage	Diversity	Forward Contamination	Power	Resolution	Sampling Efficiency
Accuracy	1	1/5	1/3	1/3	1	1/3	1/5
Coverage	5	1	1/3	1/5	1/3	1	1
Diversity	3	3	1	3	5	1	1
Forward Contamination	3	5	1/3	1	1	3	1/5
Power	1	3	1/5	1	1	1/5	1/3
Resolution	3	1	1	1/3	5	1	1
Sampling Efficiency	5	1	1	5	3	1	1

Table C.4: Hydrobot communication design criteria pairwise comparison.

	Access Duration	Access Frequency	Average Data Rate	Peak Data Rate	Power	Robustness
Access Duration	1	3	1/3	3	1/5	1
Access Frequency	1/3	1	1/3	5	1/5	1/5
Average Data Rate	3	3	1	5	1/3	1/3
Peak Data Rate	1/3	1/5	1/5	1	1/7	1/5
Power	5	5	3	7	1	3
Robustness	1	5	3	5	1/3	1

Table C.5: Cryobot performance design criteria pairwise comparison.

	Attitude Control	Descent Rate	Endurance	Mass	Payload	Power Consumption (L)	Power Consumption (S)	Robustness
Attitude Control	1	3	1/7	1/7	1/5	1/7	1/7	1/7
Descent Rate	1/3	1	1/7	1/5	1/7	1/7	1/7	1/7
Endurance	7	7	1	3	1	1/3	1/3	1
Mass	7	5	1/3	1	1	1/5	1/5	1/5
Payload	5	7	1	1	1	1/3	1	1/3
Power Consumption (L)	7	7	3	5	3	1	3	3
Power Consumption (S)	7	7	3	5	1	1/3	1	1
Robustness	7	7	1	5	3	1/3	1	1

Table C.6: Cryobot science design criteria pairwise comparison.

	Accuracy	Coverage	Diversity	Forward Con- tamination	Power	Resolution	Sampling Efficiency
Accuracy	1	5	5	1/3	1	1/3	1/3
Coverage	1/5	1	1	1/5	1/3	1/5	1/5
Diversity	1/5	1	1	1/5	1/5	1/7	1/5
Forward Contamina- tion	3	5	5	1	5	3	1/3
Power	1	3	5	1/5	1	1/5	1
Resolution	3	5	7	1/3	5	1	1/3
Sampling Efficiency	3	5	5	3	1	3	1

Table C.7: Cryobot communication design criteria pairwise comparison.

	Access Duration	Access Frequency	Average Data Rate	Peak Data Rate	Power	Robustness
Access Duration	1	3	1/3	3	1/3	1
Access Frequency	1/3	1	1/3	5	1/5	1/5
Average Data Rate	3	3	1	5	1	1/3
Peak Data Rate	1/3	1/5	1/5	1	1/5	1/5
Power	3	5	1	5	1	1/3
Robustness	1	5	3	5	3	1

Table C.8: Surface unit performance design criteria pairwise comparison.

	Cryobot Starting Ability	Endurance	Mass	Power	Radiation Hardness	Robustness
Cryobot Starting Ability	1	7	5	5	3	5
Endurance	1/7	1	1/3	1/3	1/5	1/5
Mass	1/5	3	1	1/3	1/3	1/5
Power	1/5	3	3	1	1/5	1/5
Radiation Hardness	1/3	5	3	5	1	3
Robustness	1/5	5	5	5	1/3	1

Table C.9: Surface unit science design criteria pairwise comparison.

	Accuracy	Coverage	Diversity	Forward Contamination	Power	Resolution	Sampling Efficiency
Accuracy	1	5	5	1/5	1/3	7	1/3
Coverage	1/5	1	5	1/7	1/3	3	1/3
Diversity	1/5	1/5	1	1/5	1/5	3	1
Forward Contamination	5	7	5	1	3	5	7
Power	3	3	5	1/3	1	7	5
Resolution	1/7	1/3	1/3	1/5	1/7	1	1/3
Sampling Efficiency	3	3	1	1/7	1/5	3	1

Table C.10: Surface unit communication design criteria pairwise comparison.

	Access Duration	Access Frequency	Average Data Rate	Peak Data Rate	Power	Robustness
Access Duration	1	3	1	3	1/3	1
Access Frequency	1/3	1	3	7	1/3	1/5
Average Data Rate	1	1/3	1	5	3	1/3
Peak Data Rate	1/3	1/7	1/5	1	1/3	1/5
Power	3	3	1/3	3	1	1/3
Robustness	1	5	3	5	3	1

Table C.11: Landing system performance design criteria pairwise comparison.

	Environmental Exposure on Descent	Impact Energy	Local Contamination	Mass	Navigational Accuracy	Payload	Power Consumption (L)	Power Consumption (S)	Robustness
Environmental Exposure on Descent	1	1/3	1/5	1/5	1/5	1/3	1	1	1/3
Impact Energy	3	1	1	7	3	5	5	5	5
Local Contamination	5	1	1	7	3	1/5	5	5	5
Mass	5	1/7	1/7	1	1/5	1/5	5	3	1
Navigational Accuracy	5	1/3	1/3	5	1	5	7	7	1
Payload	3	1/5	5	5	1/5	1	5	3	5
Power Consumption (L)	1	1/5	1/5	1/5	1/7	1/5	1	3	1/5
Power Consumption (S)	1	1/5	1/5	1/3	1/7	1/3	1/3	1	1/5
Robustness	3	1/5	1/5	1	1	1/5	5	5	1

Bibliography

- [1] J. D. Anderson, E. L. Lau, W. L. Sjogren, G. Schubert, and W. B. Moore, “Europa’s differentiated internal structure: Inferences from two Galileo encounters,” *Science*, vol. 276, pp. 1236–1239, 1997.
- [2] D. D. Blankenship, D. A. Young, W. B. Moore, and J. C. Moore, “Radar sounding of Europa’s subsurface properties and processes: The view from Earth,” in *Europa* (R. T. Pappalardo, W. B. McKinnon, and K. Khurana, eds.), pp. 631–654, Tucson, AZ: University of Arizona Press, 2009.
- [3] S. Fan, A. Wolek, and C. A. Woolsey, “Stability and Performance of Underwater Gliders,” in *OCEANS*, pp. 1–10, IEEE, 2012.
- [4] A. Wolek, J. Burns, C. Woolsey, J. Quenzer, L. Techy, and K. Morgansen, “A Maneuverable, Pneumatic Underwater Glider,” in *OCEANS*, pp. 1–7, IEEE, 2012.
- [5] L. Techy and C. A. Woolsey, “Minimum-time path planning for unmanned aerial vehicles in steady uniform winds,” *Journal of Guidance, Control, and Dynamics*, vol. 32, pp. 1736–1746, NovemberDecember 2009.
- [6] T. J. Osse and C. C. Eriksen, “The Deepglider: A Full Ocean Depth Glider for Oceanographic Research,” in *Oceans 2007*, (Vancouver, BC, Canada), pp. 1–12, IEEE, 2007. <http://ieeexplore.ieee.org/lpdocs/epic03/wrapper.htm?arnumber=4449125>.
- [7] J. Sherman, R. Davis, W. Owens, and J. Valdes, “The autonomous underwater glider ”Spray”,” *IEEE Journal of Oceanic Engineering*, vol. 26, no. 4, pp. 437–446, 2001. <http://ieeexplore.ieee.org/lpdocs/epic03/wrapper.htm?arnumber=972076>.
- [8] D. Webb, P. Simonetti, and C. Jones, “SLOCUM: an underwater glider propelled by environmental energy,” *IEEE Journal of Oceanic Engineering*, vol. 26, no. 4, pp. 447–452, 2001. <http://ieeexplore.ieee.org/lpdocs/epic03/wrapper.htm?arnumber=972077>.
- [9] F. E. Fish and J. J. Rohr, “Review of Dolphin Hydrodynamics and Swimming Performance,” tech. rep., SPAWAR Systems Center, San Diego, CA, USA, 1999.

- [10] C. Eriksen, T. Osse, and R. Light, “Seaglider: A long-range autonomous underwater vehicle for oceanographic research,” *Oceanic Engineering ...*, vol. 26, no. 4, pp. 424–436, 2001. <http://ieeexplore.ieee.org/lpdocs/epic03/wrapper.htm?arnumber=972073>.
- [11] Y. Bar-Cohen, “WorldWide Electroactive Polymer Actuators Webhub,” 2011. <http://ndaaa.jpl.nasa.gov/nasa-nde/lommas/eap/>, downloaded June 2013.
- [12] H. W. C. Aamot, “Heat Transfer and Performance Analysis of a Thermal Probe for Glaciers,” *CRREL Technical Report*, vol. 194, 1967.
- [13] R. Shreve, “Theory of performance of isothermal solid-nose hotpoints boring in temperate ice,” *Journal of Glaciology*, vol. 4, no. 32, pp. 151–160, 1962. http://www.igsoc.org:8080/journal/4/32/igs_journal_vol104_issue032_pg151-160.pdf.
- [14] G. Bennett and E. Skrabek, “Power performance of US space radioisotope thermoelectric generators,” in *International Conference on Thermoelectrics*, no. 1 996, pp. 357–372, IEEE, 1996. http://ieeexplore.ieee.org/xpls/abs_all.jsp?arnumber=553506.
- [15] R. Bechtel, “Advanced Stirling Radioisotope Generator,” 2010.
- [16] D. Linden and T. B. Reddy, *Handbook of Batteries*. McGraw-Hill, 2002.
- [17] B. Viswanathan, Scibio, and M. Alulice, *Fuel Cells Principles and Applications*. Hyderabad: Universities Press, 2007.
- [18] J. Shirley, T. Spilker, D. Ph, M. Evans, and W. Zimmerman, “Mission Architecture Options for a Near Term Small Europa Lander,” 2006.
- [19] F. Fish and G. Lauder, “Passive and Active Flow Control By Swimming Fishes and Mammals,” *Annual Review of Fluid Mechanics*, vol. 38, pp. 193–224, Jan. 2006. <http://www.annualreviews.org/doi/abs/10.1146/annurev.fluid.38.050304.092201>.
- [20] T. P. Mcelrath, S. Campagnola, and N. J. Strange, “Riding the Banzai Pipeline at Jupiter: Balancing Low ΔV and Low Radiation to Reach Europa,” in *AIAA/AAS Astrodynamics Specialist Conference and Exhibit*, no. August, (Minneapolis, MN), pp. 1–13, AIAA, 2012. <http://arc.aiaa.org/doi/pdf/10.2514/6.2012-4809>.
- [21] A. Oceanographic, “Xchange your old ideas,” 2013. <http://www.amloceanographic.com>, downloaded June 2013.
- [22] J. Kim, “Aslam.png,” 2013. <http://users.cecs.anu.edu.au/~Jonghyuk.Kim/images/ASLAM.png>, downloaded June 2013.
- [23] National Aeronautics and Space Administration, “Radioisotope thermoelectric generator (rtg),” 2013. <http://solarsystem.nasa.gov/rps/rtg.cfm>, downloaded June 2013.

- [24] Anon., “Inventions,” 2013. americaninventors.blogspot.com, downloaded June 2013.
- [25] Anon., 2012. <http://htekidsnews.com/wp-content/uploads/2012/08/Mars-Curiosity.jpg>, downloaded June 2013.
- [26] National Aeronautics and Space Administration, “NASA announces design for new deep space exploration system,” 2011. <http://www.nasa.gov/exploration/systems/sls/sls1.html>, downloaded June 2013.
- [27] Rutgers, “glider-surface.jpg,” 2013. <http://marine.rutgers.edu/cool/glider/webpage/glider-surface.jpg>, downloaded June 2013.
- [28] plasticpals, “Naro (nautical robot) the robotic tuna fish,” 2010. <http://www.plasticpals.com/?p=23404>, downloaded June 2013.
- [29] R. Bachmayer, B. D. Young, and D. Holland, “Working Towards Ice Profiling Using Underwater Gliders: Operational Experience In Western Greenland,” in *Symposium on Unmanned Untethered Submersible Technology*, (Durham, NH), 2007. http://efdl.cims.nyu.edu/publications/unrefereed/uust_glider_07.pdf.
- [30] A. Revkin, “In greenland, ice and instability,” 2008. http://www.nytimes.com/2008/01/08/science/earth/08gree.html?_r=0, photo by Behar, A. of JPL/NASA, downloaded June 2013.
- [31] X. Sun, “NASA beams Mona Lisa to Moon with laser,” 2013. <http://news.yahoo.com/photos/nasa-beams-mona-lisa-moon-laser-photo-104109303.html>, downloaded June 2013.
- [32] S. Gondelach, “Current and future developments of batteries for electric cars - an analysis,” no. November, 2010.
- [33] D. R. Lide, *CRC Handbook of Chemistry and Physics, 88th Edition (CRC Handbook of Chemistry & Physics)*. CRC Press, 88 ed., June 2007.
- [34] National Research Council, *Vision and Voyages for Planetary Science in the Decade 2013-2022*. Washington, DC: National Academies Press, 2011.
- [35] K. Hand, J. Cook, and H. Perlman, “Astronomy picture of the day: All the water on europa.” <http://apod.nasa.gov/apod/ap120524.html> downloaded June 24, 2013.
- [36] K. Clark, R. Greeley, R. Pappalardo, and C. Jones, “2007 Europa Explorer Mission Study: Final Report,” Tech. Rep. JPL D-41283, NASA, APL, JPL, 2007.
- [37] W. B. Moore, “Thermal equilibrium in Europa’s ice shell,” *Icarus*, vol. 180, no. 1, pp. 141–146, 2006.
- [38] *Preventing the Forward Contamination of Europa*. The National Academies Press, 2000.

- [39] C. on Planetary Protection Standards for Icy Bodies in the Outer Solar System; Space Studies Board; Division on Engineering and P. S. N. R. Council, *Assessment of Planetary Protection Requirements for Spacecraft Missions to Icy Solar System Bodies*. The National Academies Press, 2012.
- [40] A. Clarke, *2010 : Odyssey two*. New York: Ballantine Books, 1982.
- [41] K. K. Khurana, M. G. Kivelson, D. J. Stevenson, G. Schubert, C. T. Russell, R. J. Walker, and C. Polansky, “Induced magnetic fields as evidence for subsurface oceans in Europa and Callisto,” *Nature*, vol. 395, pp. 777–780, Oct. 1998. <http://adsabs.harvard.edu/abs/1998Natur.395..777K> Provided by the SAO/NASA Astrophysics Data System.
- [42] M. G. Kivelson, K. K. Khurana, C. T. Russell, M. Volwerk, R. J. Walker, and C. Zimmer, “Galileo Magnetometer Measurements: A Stronger Case for a Subsurface Ocean at Europa,” *Science*, vol. 289, pp. 1340–1343, Aug. 2000. <http://adsabs.harvard.edu/abs/2000Sci...289.1340K> Provided by the SAO/NASA Astrophysics Data System.
- [43] C. Zimmer, K. K. Khurana, and M. G. Kivelson, “Subsurface oceans on Europa and Callisto: Constraints from Galileo magnetometer observations,” *Icarus*, vol. 147, pp. 329–347, 2000.
- [44] K. P. Hand and C. F. Chyba, “Empirical constraints on the salinity of the european ocean and implications for a thin ice shell,” *Icarus*, vol. 189, pp. 424–438, Aug. 2007. <http://adsabs.harvard.edu/abs/2007Icar..189..424H> Provided by the SAO/NASA Astrophysics Data System.
- [45] K. Khurana, M. G. Kivelson, K. P. Hand, and C. T. Russell, “Electromagnetic induction from Europa’s ocean and deep interior,” in *Europa* (R. T. Pappalardo, W. B. McKinnon, and K. Khurana, eds.), pp. 571–588, Tucson, AZ: University of Arizona Press, 2009.
- [46] T. B. McCord, G. B. Hansen, D. L. Matson, T. V. Jonhson, J. K. Crowley, F. P. Fanale, R. W. Carlson, W. D. Smythe, P. D. Martin, C. A. Hibbitts, J. C. Granahan, and A. Ocampo, “Hydrated salt minerals on Europa’s surface from the Galileo near-infrared mapping spectrometer (NIMS) investigation,” *J. Geophys. Res.*, vol. 104, pp. 11827–11852, May 1999. <http://adsabs.harvard.edu/abs/1999JGR...10411827M> Provided by the SAO/NASA Astrophysics Data System.
- [47] R. W. Carlson, W. M. Calvin, J. B. Dalton, G. B. Hansen, R. L. Hudson, R. E. Johnson, T. B. McCord, and M. H. Moore, “Europa’s surface composition,” in *Europa* (R. T. Pappalardo, W. B. McKinnon, and K. Khurana, eds.), pp. 283–327, Tucson, AZ: University of Arizona Press, 2009.
- [48] M. E. Brown and K. P. Hand, “Salts and Radiation Products on the Surface of Europa,” *Astron. J.*, vol. 145, p. 110, Apr. 2013. <http://adsabs.harvard.edu/abs/2013AJ...145..110B> Provided by the SAO/NASA Astrophysics Data System.
- [49] J. D. Anderson, G. Schubert, R. A. Jacobsen, E. L. Lau, and W. B. Moore, “Europa’s differentiated internal structure: Inferences from four Galileo encounters,” *Science*, vol. 281, pp. 2019–2022, 1998.

- [50] G. Schubert, F. Sohl, and H. Hussmann, “Interior of Europa,” in *Europa* (R. T. Pappalardo, W. B. McKinnon, and K. Khurana, eds.), pp. 353–368, Tucson, AZ: University of Arizona Press, 2009.
- [51] M. Y. Zolotov and J. S. Kargel, “On the chemical composition of Europa’s icy shell, ocean, and underlying rocks,” in *Europa* (R. T. Pappalardo, W. B. McKinnon, and K. Khurana, eds.), pp. 431–457, Tucson, AZ: University of Arizona Press, 2009.
- [52] W. B. Moore and H. Hussmann, “Thermal evolution of Europa’s silicate interior,” in *Europa* (R. T. Pappalardo, W. B. McKinnon, and K. Khurana, eds.), pp. 369–380, Tucson, AZ: University of Arizona Press, 2009.
- [53] R. H. Tyler, “Strong ocean tidal flow and heating on moons of the outer planets,” *Nature*, vol. 456, pp. 770–772, Dec. 2008.
- [54] E. P. Turtle and E. Pierazzo, “Thickness of a European Ice Shell from Impact Crater Simulations,” *Science*, vol. 294, pp. 1326–1328, Nov. 2001. <http://adsabs.harvard.edu/abs/2001Sci...294.1326T> Provided by the SAO/NASA Astrophysics Data System.
- [55] P. M. Schenk, “Thickness constraints on the icy shells of the galilean satellites from a comparison of crater shapes,” *Nature*, vol. 417, pp. 419–421, May 2002. <http://adsabs.harvard.edu/abs/2002Natur.417..419S> Provided by the SAO/NASA Astrophysics Data System.
- [56] F. Nimmo, B. Giese, and R. T. Pappalardo, “Estimates of Europa’s ice shell thickness from elastically-supported topography,” *Geophys. Res. Lett.*, vol. 30, p. 1233, Mar. 2003. <http://adsabs.harvard.edu/abs/2003GeoRL..30.1233N> Provided by the SAO/NASA Astrophysics Data System.
- [57] B. E. Schmidt, D. D. Blankenship, G. W. Patterson, and P. M. Schenk, “Active formation of ‘chaos terrain’ over shallow subsurface water on Europa,” *Nature*, vol. 479, pp. 502–505, Nov. 2011. <http://adsabs.harvard.edu/abs/2011Natur.479..502S> Provided by the SAO/NASA Astrophysics Data System.
- [58] D. A. Paige, P. O. Hayne, K. A. Bennett, and B. T. Greenhagen, “Heat Flow Signatures on Europa: Thermal Model Results,” in *AAS/Division for Planetary Sciences Meeting Abstracts #42*, vol. 42 of *Bulletin of the American Astronomical Society*, p. 1013, Oct. 2010. <http://adsabs.harvard.edu/abs/2010DPS....42.3208P> Provided by the SAO/NASA Astrophysics Data System.
- [59] S. Lee, M. Zanolin, A. M. Thode, R. T. Pappalardo, and N. C. Makris, “Probing Europa’s interior with natural sound sources,” *Icarus*, vol. 165, pp. 144–167, Sept. 2003. <http://adsabs.harvard.edu/abs/2003Icar..165..144L> Provided by the SAO/NASA Astrophysics Data System.
- [60] W. Jacobs, “Magnetic launch assist-NASA’s vision for the future,” *IEEE Transactions on Magnetics*, vol. 37, no. 1, pp. 55–57, 2001. <http://ieeexplore.ieee.org/lpdocs/epic03/wrapper.htm?arnumber=911790>.

- [61] S. D. Creech, “Game Changing: NASAs Space Launch System and Science Mission Design,” in *IEEE Aerospace Conference*, 2013. http://ntrs.nasa.gov/archive/nasa/casi.ntrs.nasa.gov/20130013067_2013012827.pdf.
- [62] H. B. Garrett, “Spacecraft charging effects,” Tech. Rep. 3, Jet Propulsion Laboratory, Pasadena, CA, USA, Mar. 2010.
- [63] C. Paranicas and B. Mauk, “The ion environment near Europa and its role in surface energetics,” *Geophysical Research Letters*, vol. 29, no. 5, pp. 10–13, 2002. <http://people.virginia.edu/~rej/papers03/paranicas02grl.pdf>.
- [64] C. Paranicas, B. H. Mauk, K. Khurana, I. Jun, H. Garrett, N. Krupp, and E. Roussos, “Europa’s near-surface radiation environment,” *Geophysical Research Letters*, vol. 34, pp. 1–5, Aug. 2007. <http://www.agu.org/pubs/crossref/2007/2007GL030834.shtml>.
- [65] R. O. Fimmel, W. Swindell, and E. Burgess, *SP-349/396 Pioneer Odyssey*. NASA Ames Research Center, 1974.
- [66] C. Peat, “Spacecraft Escaping the Solar System,” *Heavens Above*, Sept. 2012.
- [67] A. Angrum and D. Sedlacko, “Ulysses: Mission Data Sheet,” 2013.
- [68] A. Wessen, K. Munsell, E. Piazza, and A. Yu, “Cassini-Huygens: Quick Facts,” 2013.
- [69] K. Beisser, “New Horizons,” 2013.
- [70] K. Erickson, J. Green, A. Wessen, P. Davis, S. Harvey, A. Burdick, G. Baerg, and D. Martin, “Galileo Legacy Site,” 2010.
- [71] Europa Study Team, “Europa Study 2012 Report: Europa Orbiter Mission,” Tech. Rep. JPL D-71990, Jet Propulsion Laboratory, Pasadena, CA, USA, 2012. <http://solarsystem.nasa.gov/europa/docs/ES%202012%20Report%20B%20Orbiter%20-%20Final%20-%2020120501.pdf>.
- [72] JPL, “Juno Mission to Jupiter,” 2013.
- [73] Europa Study Team, “Europa Study 2012 Report,” Tech. Rep. JPL D-71990, Jet Propulsion Laboratory, Pasadena, CA, USA, 2012. <http://solarsystem.nasa.gov/europa/docs/ES%202012%20Report%20-%20Final%20-%2020120501.pdf>.
- [74] B. Travis, J. Palguta, and G. Schubert, “A whole-moon thermal history model of Europa: Impact of hydrothermal circulation and salt transport,” *Icarus*, vol. 218, pp. 1006–1019, Apr. 2012. <http://linkinghub.elsevier.com/retrieve/pii/S0019103512000474>.
- [75] J. Kargel, “Europa’s Crust and Ocean: Origin, Composition, and the Prospects for Life,” *Icarus*, vol. 148, pp. 226–265, Nov. 2000. <http://linkinghub.elsevier.com/retrieve/doi/10.1006/icar.2000.6471>.

- [76] W. B. Moore and G. Schubert, “The tidal response of Europa,” *Icarus*, vol. 147, pp. 317–319, 2000.
- [77] A. R. Rhoden, B. Militzer, E. M. Huff, T. a. Hurford, M. Manga, and M. a. Richards, “Constraints on Europas rotational dynamics from modeling of tidally-driven fractures,” *Icarus*, vol. 210, pp. 770–784, Dec. 2010. <http://linkinghub.elsevier.com/retrieve/pii/S0019103510002903>.
- [78] R. T. Pappalardo, M. J. S. Belton, H. H. Breneman, M. H. Carr, C. R. Chapman, G. C. Collins, T. Denk, S. Fagents, P. E. Geissler, B. Giese, R. Greeley, R. Greenberg, J. W. Head, P. Helfenstein, G. Hoppa, S. D. Kadel, K. P. Klaasen, J. E. Klemaszewski, K. Magee, A. S. McEwen, J. M. Moore, W. B. Moore, G. Neukum, C. B. Phillips, L. M. Prockter, G. Schubert, D. A. Senske, R. J. Sullivan, B. R. Tufts, E. P. Turtle, R. Wagner, and K. K. Williams, “Does Europa have a subsurface ocean? Evaluation of the geological evidence,” *Journal of Geophysical Research*, vol. 104, no. E10, pp. 15–24, 1999. <http://dx.doi.org/10.1029/1998JE000628>.
- [79] K. Clark, R. Greeley, R. Pappalardo, and C. Jones, “2007 Europa Explorer Mission Study: Final Report,” tech. rep., NASA Jet Propulsion Laboratory, 2007.
- [80] D. Desbruy, A. Almeida, M. Biscoito, T. Comtet, A. Khripounoff, N. Le Bris, P. M. Sarradin, and M. Segonzac, “A review of the distribution of hydrothermal vent communities along the northern Mid-Atlantic Ridge : dispersal vs . environmental controls,” *Hydrobiologia*, vol. 440, pp. 201–216, 2000.
- [81] A. Bowen, D. Yoerger, and C. Taylor, “The Nereus hybrid underwater robotic vehicle for global ocean science operations to 11,000 m depth,” in *OCEANS*, (Quebec City, QC, Canada), pp. 1–10, 2008. http://ieeexplore.ieee.org/xpls/abs_all.jsp?arnumber=5151993.
- [82] R. P. Trocine and J. H. Trefry, “Distribution and chemistry of suspended particles from an active hydrothermal vent site on the Mid-Atlantic Ridge at 26N,” *Earth and Planetary Science Letters*, vol. 88, pp. 1–15, Apr. 1988.
- [83] P. M. Schenk, “Thickness constraints on the icy shells of the galilean satellites from a comparison of crater shapes.,” *Nature*, vol. 417, pp. 419–21, May 2002. <http://www.ncbi.nlm.nih.gov/pubmed/12024207>.
- [84] J. C. Goodman and E. Lenferink, “Numerical simulations of marine hydrothermal plumes for Europa and other icy worlds,” *Icarus*, vol. 221, pp. 970–983, Nov. 2012. <http://linkinghub.elsevier.com/retrieve/pii/S0019103512003466>.
- [85] T. L. Saaty, “How to make a decision: The analytic hierarchy process,” *European Journal of Operational Research*, vol. 48, pp. 9–26, Sept. 1990. <http://linkinghub.elsevier.com/retrieve/pii/037722179090057I>.
- [86] L. M. Prockter, “Orbiter , Flyby and Lander Mission Concepts for Investigating Europa’s Habitability,” *Geophysical Research Abstracts*, vol. 14, p. 67959, 2012.

- [87] S. A. Jenkins, D. E. Humphreys, J. Sherman, J. Osse, C. Jones, L. Naomi, J. Grave, R. Bachmayer, T. Clem, P. Carroll, P. Davis, J. Berry, P. Worley, and J. Wasyl, “Underwater Glider System Study,” *Science (New York, N.Y.)*, vol. 84, p. 83, July 2003. <http://www.ncbi.nlm.nih.gov/pubmed/11619936>.
- [88] Southampton Oceanography Centre and United Kingdom, “The Evaluation of Salinity Measurements from PALACE Floats,” pp. 1258–1266, 2001.
- [89] A. Buis, “NASA demonstrates novel ocean-powered underwater vehicle,” April 5 2010. <http://www.jpl.nasa.gov/news/news.php?release=2010-111>, Retrieved April 27, 2013.
- [90] C. C. Eriksen, T. J. Osse, R. D. Light, T. Wen, T. W. Lehman, P. L. Sabin, J. W. Ballard, and A. M. Chiodi, “Seaglider: A long-range autonomous underwater vehicle for oceanographic research,” *Journal of Oceanic Engineering*, vol. 26, no. 4, pp. 424–436, 2001. Special Issue on Autonomous Ocean-Sampling Networks.
- [91] N. Mahmoudian, J. Geisbert, and C. Woolsey, “Approximate analytical turning conditions for underwater gliders and implications for path planning,” *IEEE Journal of Oceanic Engineering*, vol. 35, pp. 131–143, January 2010.
- [92] L. Techy, C. A. Woolsey, and K. Morgansen, “Planar path planning for flight vehicles in wind with turn rate and acceleration bounds,” in *International Conference on Robotics and Automation*, (Anchorage, AK), May 2010.
- [93] A. Wolek and C. A. Woolsey, “Disturbance rejection in Dubins path planning,” in *International Conference on Robotics and Automation*, (Montreal, Canada), pp. 4873–4878, June 2012.
- [94] D. L. Rudnick, R. E. Davis, C. C. Eriksen, D. M. Fratantoni, and M. J. Perry, “Underwater Gliders for Ocean Research,” *Marine Technology Society Journal*, vol. 38, pp. 73–84, June 2004. <http://openurl.ingenta.com/content/xref?genre=article&issn=0025-3324&volume=38&issue=2&spage=73>.
- [95] R. E. Davis, C. C. Eriksen, and C. P. Jones, “Autonomous Buoyancy-Driven Underwater Gliders,” in *Technology and Applications of Autonomous Underwater Vehicles, Vo. 2*, ch. 3, Routledge Publishing (Taylor and Francis), 2002.
- [96] T. J. Osse and C. C. Eriksen, “The deepglider: A full ocean depth glider for oceanographic research,” in *IEEE/MTS OCEANS*, (Vancouver, Canada), September 2007.
- [97] P. G. Thomasson and C. A. Woolsey, “Vehicle motion in currents,” *Journal of Oceanic Engineering*, vol. 38, no. 2, pp. 226–242, 2013.
- [98] T. M. Williams, R. W. Davis, L. a. Fuiman, J. Francis, B. J. Le Boeuf, M. Horning, J. Calambokidis, and D. a. Croll, “Sink or swim: strategies for cost-efficient diving by marine mammals,” *Science (New York, N.Y.)*, vol. 288, pp. 133–6, Apr. 2000. <http://www.ncbi.nlm.nih.gov/pubmed/10753116>.

- [99] A. K. Kancharala, M. K. Philen, and M. J. Patil, “The Role of Compliant Joint and Flexibility on the Propulsive Performance of a Self Propelled Caudal Fin,” in *ASME 2012 Conference on Smart Materials, Adaptive Structures and Intelligent Systems*, 2012.
- [100] D.-K. Kim and J.-H. Han, “Smart flapping wing using Macro-Fiber Composite actuators,” in *Smart Structures and Materials 2006: Smart Structures and Integrated Systems* (Y. Matsuzaki, ed.), vol. 6173, pp. 61730F–61730F–9, Mar. 2006. <http://proceedings.spiedigitallibrary.org/proceeding.aspx?articleid=1282007>.
- [101] S. Licht, V. Polidoro, M. Flores, F. Hover, and M. Triantafyllou, “Design and Projected Performance of a Flapping Foil AUV,” *IEEE Journal of Oceanic Engineering*, vol. 29, pp. 786–794, July 2004. <http://ieeexplore.ieee.org/lpdocs/epic03/wrapper.htm?arnumber=1353431>.
- [102] D. N. Beal, H. A. Leinhos, A. R. Fredette, and R. Berube, “Unified Scaling for Flapping Fins,” *IEEE Journal of Oceanic Engineering*, vol. 38, pp. 1–11, Jan. 2013. <http://ieeexplore.ieee.org/lpdocs/epic03/wrapper.htm?arnumber=6331567>.
- [103] A. Menozzi, H. Leinhos, D. Beal, and P. Bandyopadhyay, “Open-Loop Control of a Multifin Biorobotic Rigid Underwater Vehicle,” *IEEE Journal of Oceanic Engineering*, vol. 33, pp. 59–68, Apr. 2008. <http://ieeexplore.ieee.org/lpdocs/epic03/wrapper.htm?arnumber=4623835>.
- [104] G. V. Lauder, P. G. a. Madden, J. L. Tangorra, E. Anderson, and T. V. Baker, “Bioinspiration from fish for smart material design and function,” *Smart Materials and Structures*, vol. 20, p. 094014, Sept. 2011. <http://stacks.iop.org/0964-1726/20/i=9/a=094014?key=crossref.e2982ec3524c79705024fcc06d97b370>.
- [105] Z. Chen, S. Shatara, and X. Tan, “Modeling of Biomimetic Robotic Fish Propelled by An Ionic PolymerMetal Composite Caudal Fin,” *IEEE/ASME Transactions on Mechatronics*, vol. 15, pp. 448–459, June 2010. <http://ieeexplore.ieee.org/lpdocs/epic03/wrapper.htm?arnumber=5208342>.
- [106] Z. Chen and X. Tan, “Monolithic fabrication of ionic polymermetal composite actuators capable of complex deformation,” *Sensors and Actuators A: Physical*, vol. 157, pp. 246–257, Feb. 2010. <http://linkinghub.elsevier.com/retrieve/pii/S0924424709005111>.
- [107] N. Kömle, G. Kargl, and M. Steller, “Melting probes as a means to explore planetary glaciers and ice caps,” in *Exo-Astrobiology*, (Graz, Austria), pp. 305–308, ESA, 2002. <http://adsabs.harvard.edu/full/2002ESASP.518..305K>.
- [108] W. Zimmerman, J. Feldman, and R. Bonitz, “Cryobot: An Ice Penetrating Robotic Vehicle,” *IEEE Aerospace Conference*, 2001.
- [109] E. Kaufmann, G. Kargl, N. I. Kömle, M. Steller, J. Hasiba, F. Tatschl, S. Ulamec, J. Biele, M. Engelhardt, and J. Romstedt, “Melting and Sublimation of Planetary Ices Under Low

- Pressure Conditions: Laboratory Experiments with a Melting Probe Prototype,” *Earth, Moon, and Planets*, vol. 105, pp. 11–29, Mar. 2009. <http://www.springerlink.com/index/10.1007/s11038-009-9296-9>.
- [110] H. W. C. Aamot, “Instruments and Methods: Pendulum Steering for Thermal Probes in Glaciers,” *Journal of Glaciology*, vol. 6, no. 48, pp. 935–938, 1967. http://www.igsoc.org/journal.old/6/48/igs_journal_vol106_issue048_pg935-938.pdf.
- [111] D. P. Winebrenner, W. Elam, V. Miller, and M. Carpenter, “A Thermal Ice-Melt Probe for Exploration of Earth-Analogs to Mars, Europa and Enceladus,” in *Lunar and Planetary Science Conference*, p. 2986, 2013.
- [112] J. Biele, S. Ulamec, J. Garry, S. Sheridan, A. Morse, S. Barber, I. Wright, H. Tug, and T. Mock, “Melting probes at Lake Vostok and Europa,” in *Exo-Astrobiology*, (Graz, Austria), pp. 253–260, ESA, 2002. <http://articles.adsabs.harvard.edu/full/2002ESASP.518..253B/0000253.000.html>.
- [113] T. Thorsteinsson, S. O. Elefsen, E. Gaidos, B. Lanoil, T. Jóhannesson, V. Kjartansson, V. . Marteinsson, A. Stefánsson, and T. Thorsteinsson, “A hot water drill with built-in sterilization: Design, testing and performance,” *Jökull*, vol. 1990, no. 57, pp. 71–82, 2007. <http://www.soest.hawaii.edu/GG/FACULTY/GAIDOS/jokull108.pdf>.
- [114] L. S. Mason, “Realistic Specific Power Expectations for Advanced Radioisotope Power Systems,” *Journal of Propulsion and Power*, vol. 23, pp. 1075–1079, Sept. 2007.
- [115] S. Ulamec, J. Biele, O. Funke, and M. Engelhardt, “Access to glacial and subglacial environments in the Solar System by melting probe technology,” *Reviews in Environmental Science and Bio/Technology*, vol. 6, pp. 71–94, Oct. 2006. <http://www.springerlink.com/index/10.1007/s11157-006-9108-x>.
- [116] A. Stanculescu, “The Role of Nuclear Power and Nuclear Propulsion in the Peaceful Exploration of Space,” tech. rep., IAEA, Vienna, Austria, 2005.
- [117] D. I. Poston, “Nuclear safety calculations for heatpipe power system reactors,” in *Space Technology and Applications International Forum* (M. S. El-Genk, ed.), vol. 608, pp. 748–758, AIP, 2002. <http://link.aip.org/link/APCPCS/v608/i1/p748/s1&Agg=doi>.
- [118] D. I. Poston, R. J. Kapernick, and R. M. Guffee, “Design and analysis of the SAFE-400 space fission reactor,” in *Space Technology and Applications International Forum* (M. S. El-Genk, ed.), vol. 608, pp. 578–588, AIP, 2002. <http://link.aip.org/link/APCPCS/v608/i1/p578/s1&Agg=doi>.
- [119] R. Taylor, “Prometheus Project: Final Report,” Tech. Rep. 982-R120461, Jet Propulsion Laboratory, 2005. <http://trs-new.jpl.nasa.gov/dspace/bitstream/2014/38185/1/05-3441.pdf>.

- [120] G. L. Bennett, R. J. Hemler, and A. Schock, "Development and use of the Galileo and Ulysses power sources," in *Congress of the International Astronautical Federation*, (Jerusalem, Israel), 1994. http://www.osti.gov/bridge/product.biblio.jsp?osti_id=1033366.
- [121] B. J. Bragg, J. E. Casey, and J. B. Trout, *Primary Battery Design Guidelines Handbook and Safety Guidelines Handbook*. No. December 1994, Linthicum Heights: NASA Reference, 1994.
- [122] D. J. Bradwell, H. Kim, A. H. C. Sirk, and D. R. Sadoway, "Magnesium-antimony liquid metal battery for stationary energy storage.," *Journal of the American Chemical Society*, vol. 134, pp. 1895–7, Mar. 2012. <http://www.ncbi.nlm.nih.gov/pubmed/22224420>.
- [123] S. Narayan and T. I. Valdez, "High-Energy Portable Fuel Cell Power Sources," *The Electrochemical Society Interface*, 2008.
- [124] K. Kordesch, V. Hacker, J. Gsellmann, M. Cifrain, G. Faleschini, P. Enzinger, R. Fankhauser, M. Ortner, M. Muhr, and R. R. Aronson, "Alkaline fuel cells applications," *Journal of Power Sources*, vol. 86, pp. 162–165, Mar. 2000. <http://linkinghub.elsevier.com/retrieve/pii/S0378775399004292>.
- [125] K. Zona, "Summary: Space Applications of Hydrogen and Fuel Cells," 2010. http://www.nasa.gov/topics/technology/hydrogen/hydrogen_2009.html.
- [126] JFE Advantech Co., Ltd, "Ocean and river instruments." <http://www.jfe-advantech.co.jp/eng/ocean/index.html>, downloaded June, 2013.
- [127] O. Ryan, R. Greaney, S. Gerard Jennings, and C. D. ODowd, "Description of a biofluorescence optical particle counter," *Journal of Quantitative Spectroscopy and Radiative Transfer*, vol. 110, pp. 1750–1754, Sept. 2009. <http://linkinghub.elsevier.com/retrieve/pii/S0022407309000363>.
- [128] Editors, "Hitting Europa Hard," *Astrobiology Magazine*, 2006. <http://www.astrobio.net/interview/1944/hitting-europa-hard>.
- [129] P. Weiss, K. Yung, N. Kömle, S. Ko, E. Kaufmann, and G. Kargl, "Thermal drill sampling system onboard high-velocity impactors for exploring the subsurface of Europa," *Advances in Space Research*, vol. 48, pp. 743–754, Aug. 2011. <http://linkinghub.elsevier.com/retrieve/pii/S0273117710000505>.
- [130] R. Abelson and J. Shirley, "Exploring Europa with a surface lander powered by a small radioisotope power system (RPS).," *Space Technology*, 2005. <http://trs-new.jpl.nasa.gov/dspace/handle/2014/41029>.
- [131] D. W. Way, "Preliminary assessment of the mars science laboratory entry, descent, and landing simulation," Technical Report 20130011617, National Aeronautics and Space Administration, 2013.

- [132] E. M. Cortright, *Apollo Expeditions to the Moon*. Washington, DC: NASA, 1975.
- [133] “Falcon Heavy Overview,” 2013. https://spacex.com/falcon_heavy.php downloaded 15 May 2013.
- [134] R. Taylor, “Prometheus Project Final Report,” Technical Report 982-R120461, National Aeronautics and Space Administration, 2005.
- [135] T. Rivellini, “The Challenges of Landing on Mars,” *The Bridge*, vol. 34, no. 4, pp. 13–17, 2013. <http://www.engineeringchallenges.org/cms/7126/7622.aspx>.
- [136] Y. Smith and B. Dunbar, “Apollo,” 2012.
- [137] J. Wilson and B. Dunbar, “Viking,” 2012.
- [138] T. Greicius and B. Dunbar, “Phoenix Mars Lander,” 2012.
- [139] R. Gershman, E. Nilsen, and R. Oberto, “Europa Lander,” *Acta Astronautica*, vol. 52, pp. 253–258, Jan. 2003. <http://linkinghub.elsevier.com/retrieve/pii/S0094576502001649>.
- [140] E. Zubristky and N. Neal-Jones, “NASA Beams Mona Lisa to Lunar Reconnaissance Orbiter at the Moon,” *NASA Goddard Release No. 13-003*, Jan. 2013. http://www.nasa.gov/mission_pages/LRO/news/mona-lisa.html.
- [141] BBC, “Space Probe Breaks Laser Record,” *BBC News*, Jan. 2006. <http://news.bbc.co.uk/2/hi/science/nature/4587580.stm>.
- [142] S. Bryant, “Ice-embedded transceivers for Europa cryobot communications,” *Proceedings, IEEE Aerospace Conference*, vol. 1, pp. 1–356, 2002. <http://ieeexplore.ieee.org/lpdocs/epic03/wrapper.htm?arnumber=1036854>.
- [143] S. E. Webster and A. D. Bowen, “Fiber Optic Microcable Link to the Surface,” in *OCEANS*, (San Diego, CA, USA), pp. 2469–2474, 2003.
- [144] C. O. Fiber, “Fiber mechanical reliability calculator,” 2013. http://www.corning.com/opticalfiber/library/fiber_mechanical_reliability/calculators.aspx, downloaded June 2013.
- [145] G. Glaesemann and D. Walter, “Method for Obtaining Long-Length Strength Distributions for Reliability Prediction,” *Optical Engineering*, vol. 30, no. 6, pp. 746–748, 1991.
- [146] J. Arinez, “Strategy and innovation at GM manufacturing research,” in *2013 NIAC Spring Symposium*, (Chicago, IL), 2013.
- [147] T. McGinnis, C. P. Henze, and K. Conroy, “Inductive Power System for Autonomous Underwater Vehicles,” in *Oceans 2007*, pp. 1–5, IEEE, 2007. <http://ieeexplore.ieee.org/lpdocs/epic03/wrapper.htm?arnumber=4449219>.

- [148] L. Techy, K. Morgansen, and C. A. Woolsey, “Long-baseline acoustic localization of the Seaglider underwater glider,” in *American Control Conference*, (San Francisco, CA), July 2011.
- [149] L. Freitag, P. Koski, A. Morozov, S. Singh, and J. Partan, “Acoustic communications and navigation under arctic ice,” in *IEEE/MTS OCEANS*, (Hampton Roads, VA), October 2012.
- [150] T. Bailey and H. Durrant-whyte, “Simultaneous Localization and Mapping (SLAM): Part II,” *IEEE Robotics and Automation Magazine*, no. September, pp. 108–117, 2006.
- [151] H. Durrant-Whyte and T. Bailey, “Simultaneous localization and mapping: part I,” *IEEE Robotics & Automation Magazine*, vol. 13, pp. 99–110, June 2006. <http://ieeexplore.ieee.org/lpdocs/epic03/wrapper.htm?arnumber=1638022>.
- [152] G. Grisettiyz, C. Stachniss, and W. Burgard, “Improving Grid-based SLAM with Rao-Blackwellized Particle Filters by Adaptive Proposals and Selective Resampling,” in *Proceedings of the 2005 IEEE International Conference on Robotics and Automation*, no. April, pp. 2432–2437, IEEE, 2005. <http://ieeexplore.ieee.org/lpdocs/epic03/wrapper.htm?arnumber=1570477>.
- [153] NASA, “Laser Communications Relay Demonstration (LCRD),” 2013. http://www.nasa.gov/mission_pages/tdm/lcrd/lcrd_overview.html downloaded 8 June 2013.
- [154] X. Sun, D. R. Skillman, E. D. Hoffman, D. Mao, J. F. McGarry, L. McIntire, R. S. Zellar, F. M. Davidson, W. H. Fong, M. A. Krainak, G. A. Neumann, M. T. Zuber, and D. E. Smith, “Free space laser communication experiments from Earth to the Lunar Reconnaissance Orbiter in lunar orbit,” *Optics Express*, vol. 21, p. 1865, Jan. 2013. <http://www.opticsinfobase.org/abstract.cfm?URI=oe-21-2-1865>.
- [155] K. K. Khurana, M. G. Kivelson, C. T. Russell, R. J. Walker, and D. J. Southwood, “Absence of an internal magnetic field at Callisto,” *Nature*, vol. 387, pp. 262–264, 1997.
- [156] J. D. Anderson, E. L. Lau, W. L. Sjogren, G. Schubert, and W. B. Moore, “Gravitational evidence for an undifferentiated Callisto,” *Nature*, vol. 387, pp. 264–266, 1997.
- [157] R. D. Lorenz, B. W. Stiles, R. L. Kirk, M. D. Allison, P. Persi del Marmo, L. Iess, J. I. Lunine, S. J. Ostro, and S. Hensley, “Titan’s Rotation Reveals an Internal Ocean and Changing Zonal Winds,” *Science*, vol. 319, pp. 1649–, Mar. 2008. <http://adsabs.harvard.edu/abs/2008Sci...319.1649L> Provided by the SAO/NASA Astrophysics Data System.
- [158] J. H. Waite, Jr., W. S. Lewis, B. A. Magee, J. I. Lunine, W. B. McKinnon, C. R. Glein, O. Mousis, D. T. Young, T. Brockwell, J. Westlake, M.-J. Nguyen, B. D. Teolis, H. B. Niemann, R. L. McNutt, M. Perry, and W.-H. Ip, “Liquid water on Enceladus from observations of ammonia and ^{40}Ar in the plume,” *Nature*, vol. 460, pp. 487–490, July 2009. <http://adsabs.harvard.edu/abs/2009Natur.460..487W> Provided by the SAO/NASA Astrophysics Data System.

- [159] F. Postberg, S. Kempf, J. Schmidt, N. Brilliantov, A. Beinsen, B. Abel, U. Buck, and R. Srama, “Sodium salts in E-ring ice grains from an ocean below the surface of Enceladus,” *Nature*, vol. 459, pp. 1098–1101, June 2009. <http://adsabs.harvard.edu/abs/2009Natur.459.1098P> Provided by the SAO/NASA Astrophysics Data System.
- [160] T. B. McCord, J. Castillo-Rogez, and A. Rivkin, “Ceres: Its Origin, Evolution and Structure and Dawn’s Potential Contribution,” *Space Sci. Rev.*, vol. 163, pp. 63–76, Dec. 2011. <http://adsabs.harvard.edu/abs/2011SSRv..163...63M> Provided by the SAO/NASA Astrophysics Data System.
- [161] C. C. Porco, P. Helfenstein, P. C. Thomas, A. P. Ingersoll, J. Wisdom, R. West, G. Neukum, T. Denk, R. Wagner, T. Roatsch, S. Kieffer, E. Turtle, A. McEwen, T. V. Johnson, J. Rathbun, J. Veverka, D. Wilson, J. Perry, J. Spitale, A. Brahic, J. A. Burns, A. D. Del Genio, L. Dones, C. D. Murray, and S. Squyres, “Cassini Observes the Active South Pole of Enceladus,” *Science*, vol. 311, pp. 1393–1401, Mar. 2006. <http://adsabs.harvard.edu/abs/2006Sci...311.1393P> Provided by the SAO/NASA Astrophysics Data System.
- [162] J. Biele, S. Ulamec, M. Hilchenbach, and N. Kömle, “In situ analysis of Europa ices by short-range melting probes,” *Advances in Space Research*, vol. 48, pp. 755–763, Aug. 2011. <http://linkinghub.elsevier.com/retrieve/pii/S027311771000147X>.