



# **“Mining” Water Ice on Mars**

## **An Assessment of ISRU Options in Support of Future Human Missions**

Stephen Hoffman, Alida Andrews, Kevin Watts  
July 2016



- **Introduction**
- **What kind of water ice are we talking about**
- **Options for accessing the water ice**
- **Drilling Options**
- **“Mining” Options**
- **EMC scenario and requirements**
- **Recommendations and future work**

# Acknowledgement



- **The authors of this report learned much during the process of researching the technologies and operations associated with drilling into icy deposits and extract water from those deposits. We would like to acknowledge the support and advice provided by the following individuals and their organizations:**
  - Brian Glass, PhD, NASA Ames Research Center
  - Robert Haehnel, PhD, U.S. Army Corps of Engineers/Cold Regions Research and Engineering Laboratory
  - Patrick Haggerty, National Science Foundation/Geosciences/Polar Programs
  - Jennifer Mercer, PhD, National Science Foundation/Geosciences/Polar Programs
  - Frank Rack, PhD, University of Nebraska-Lincoln
  - Jason Weale, U.S. Army Corps of Engineers/Cold Regions Research and Engineering Laboratory



Mining Water Ice on Mars

# INTRODUCTION



- **Addendum to M-WIP study, addressing one of the areas not fully covered in this report: accessing and mining water ice if it is present in certain glacier-like forms**

- The M-WIP report is available at <http://mepag.nasa.gov/reports.cfm>

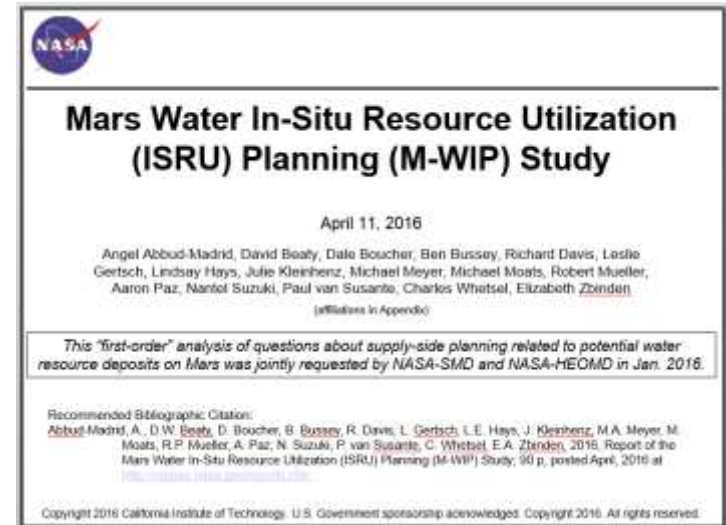

- **The First Landing Site/Exploration Zone Workshop for Human Missions to Mars (October 2015) set the target quantity of water to be produced for these missions used in M-WIP**
  - Identify EZs with sufficient feedstock material to produce 100 metric tons (mT) of water that will be used by five crews
  - The 20 mT/crew estimate was based on sufficient water to make propellant for each crew's ascent vehicle plus a nominal amount that is typically consumed in EVA cooling and other miscellaneous ECLSS losses

# Notional Mars Descent Module Compared to 100 mT of Water



Notional Mars Descent Module

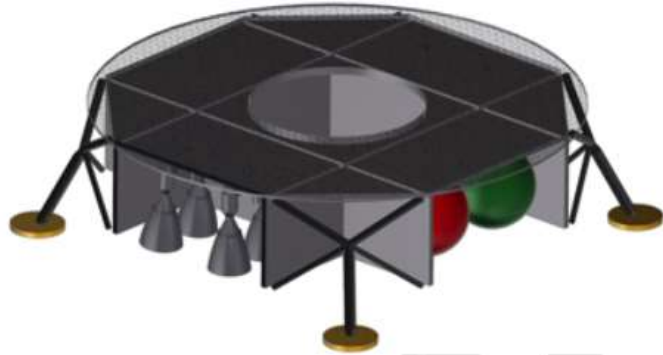

100 mT of Water (100 m<sup>3</sup>)

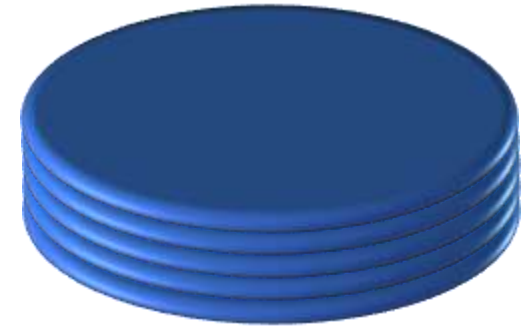

Conceptual Water Storage  
One bladder per crew @ 20 mT each

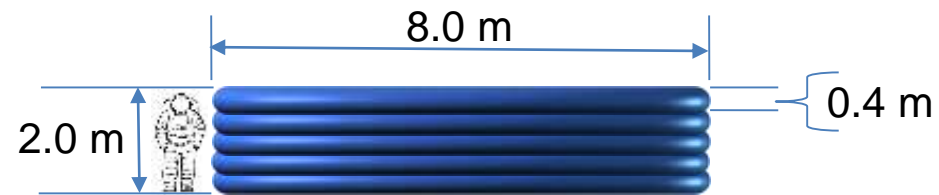
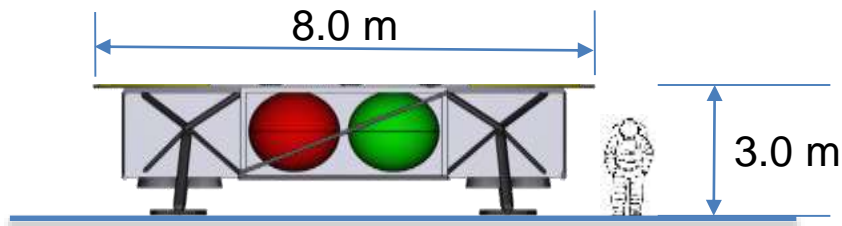

# Summary of potential water sources on Mars



- **Atmospheric Water Vapor**

- 100 percent relative humidity has been observed on Mars but the atmosphere is very thin so available water is very small

- **Ground Water**

- Defined as liquid water in subsurface deposits (e.g., aquifers)
- For this discussion, this category includes gullies and recurring slope lineae (RSLs)

- **Adsorbed Water**

- Thin film of water coating individual grains of regolith/soil

- **Hydrated Minerals**

- Water either chemically bound or incorporated in the crystalline structure of minerals

- **Ice**

- Polar caps
- Subsurface layers – “cryosphere” (e.g., permafrost, ice lens, pingos, etc.)
- Glacier-like forms in mid-latitudes and a few equatorial areas

# Summary of M-WIP assessment results



- **Atmospheric Water Vapor**

- “The mass, power, volume, and mechanical complexity of the system needed for this approach are far outside of what is practical for deployment to Mars.”

- **Ground Water**

- Analysis of radar data (SHARAD and MARSIS) indicate no detection of modern bodies of subsurface water at depths down to ~200-300 m below the surface.
- Potential signs of minute amounts of present-day brine water (e.g., RSL).
  - *“Would need means of collecting and concentrating thin films of watery brines whose water content may be no greater than that of the atmospheric vapor.”*

- **Adsorbed Water**

- Several options identified and assessed in M-WIP
  - See M-WIP Report (April 2016) for details

- **Hydrated Minerals**

- Several options identified and assessed in M-WIP
  - See M-WIP Report (April 2016) for details

- **Ice**

- Discussed on following pages



# Filling the missing Ice Gap in the M-WIP Study



- **The M-WIP study concluded that “...buried glacial ice deposits may represent the most concentrated source of water...” of the options considered**
- **Candidate strategies for deeper ice (>1m) considered by M-WIP included:**
  - Surface mining of ice: Remove overburden, extract solid ice [Preliminary Analysis documented in the M-WIP report] or
  - In Situ Recovery: Drill through overburden, melt/dissolve ice at depth and recover/separate at surface [Not analyzed in the M-WIP study]
    - “...work during this study was hampered by the relatively low amount of recent engineering research conducted in this area”
- **The rather large body of research and practical application of ice drilling and water extraction from terrestrial glaciers and ice sheets was investigated to fill the missing portion of the initial M-WIP study**
- **The remainder of this addendum will document a preliminary assessment of applying terrestrial experience to Mars scenarios**



Mining Water Ice on Mars

# WHAT KIND OF WATER ICE ARE WE TALKING ABOUT

# Contemporary Ice on Mars: What Types and Where is it Found

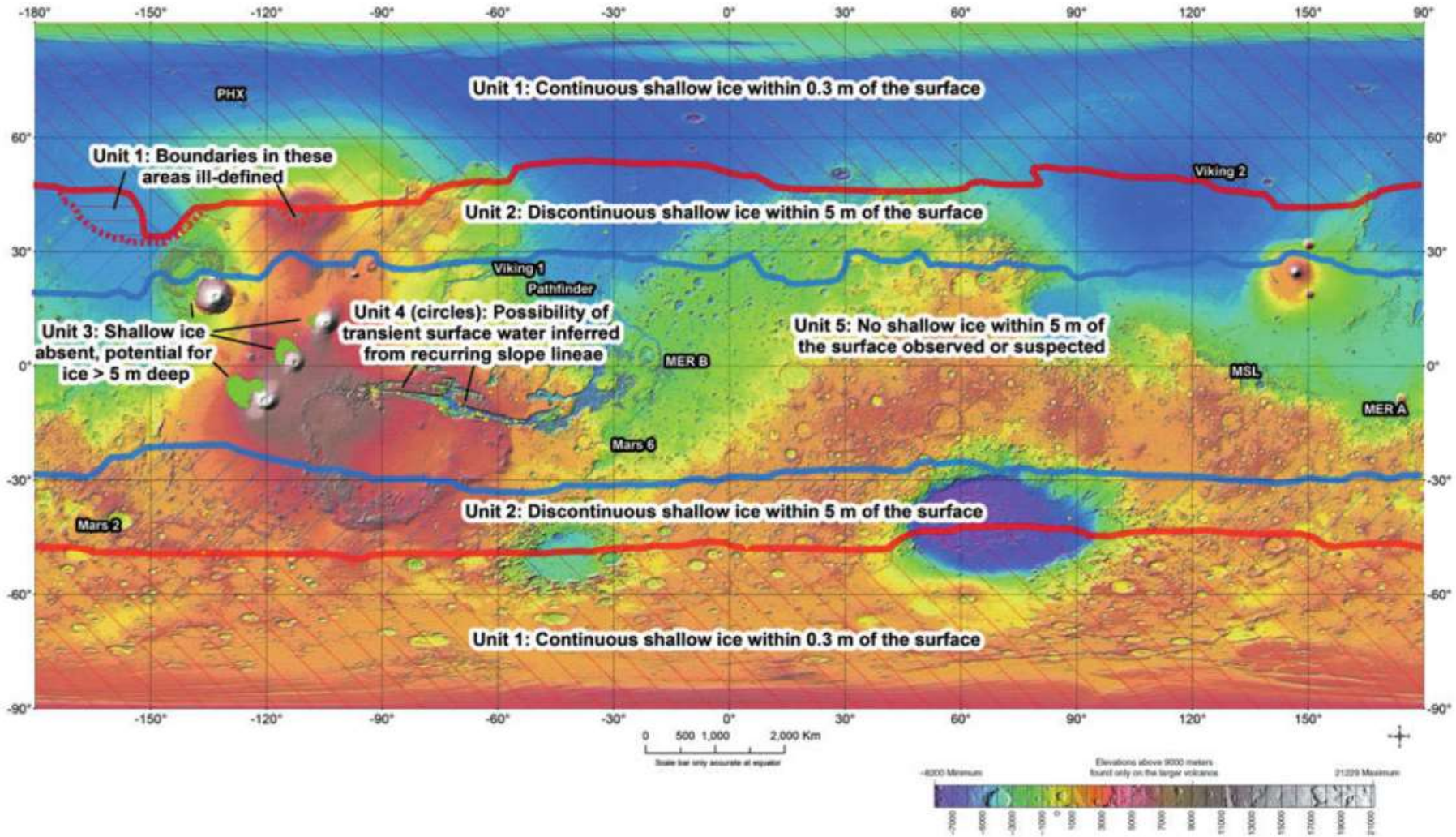

# Exploration Zones, Regions of Interest, and Limits



- **Exploration Zone**

- A collection of Regions of Interest (ROIs) that are located within approximately 100 kilometers of a centralized landing site

- **Region of Interest**

- Areas that are relevant for scientific investigation and/or development/maturation of capabilities and resources necessary for a sustainable human presence

- **Latitude and Elevation limits**

- Landing and ascent technology options place boundaries on surface locations leading to a preference for mid- to low- latitudes and mid- to low- elevations
- Accessing water ice for science and ISRU purposes is attractive, *leading to a preference for higher latitudes if water ice is the desired feedstock*
- Preliminary latitude boundaries set at +/- 50 degrees
  - *Derived in part by being at a high enough latitude to access known bodies of ice not so high as to significantly impact the MAV*
  - *In addition, higher latitudes will experience limited daylight during winter months (Mars' axis is tilted at 25.2 deg) which will have ISRU and non-ISRU operational implications*
- Preliminary elevation boundary set at no higher than +2 km (MOLA reference)

# MAV sensitivity to latitude

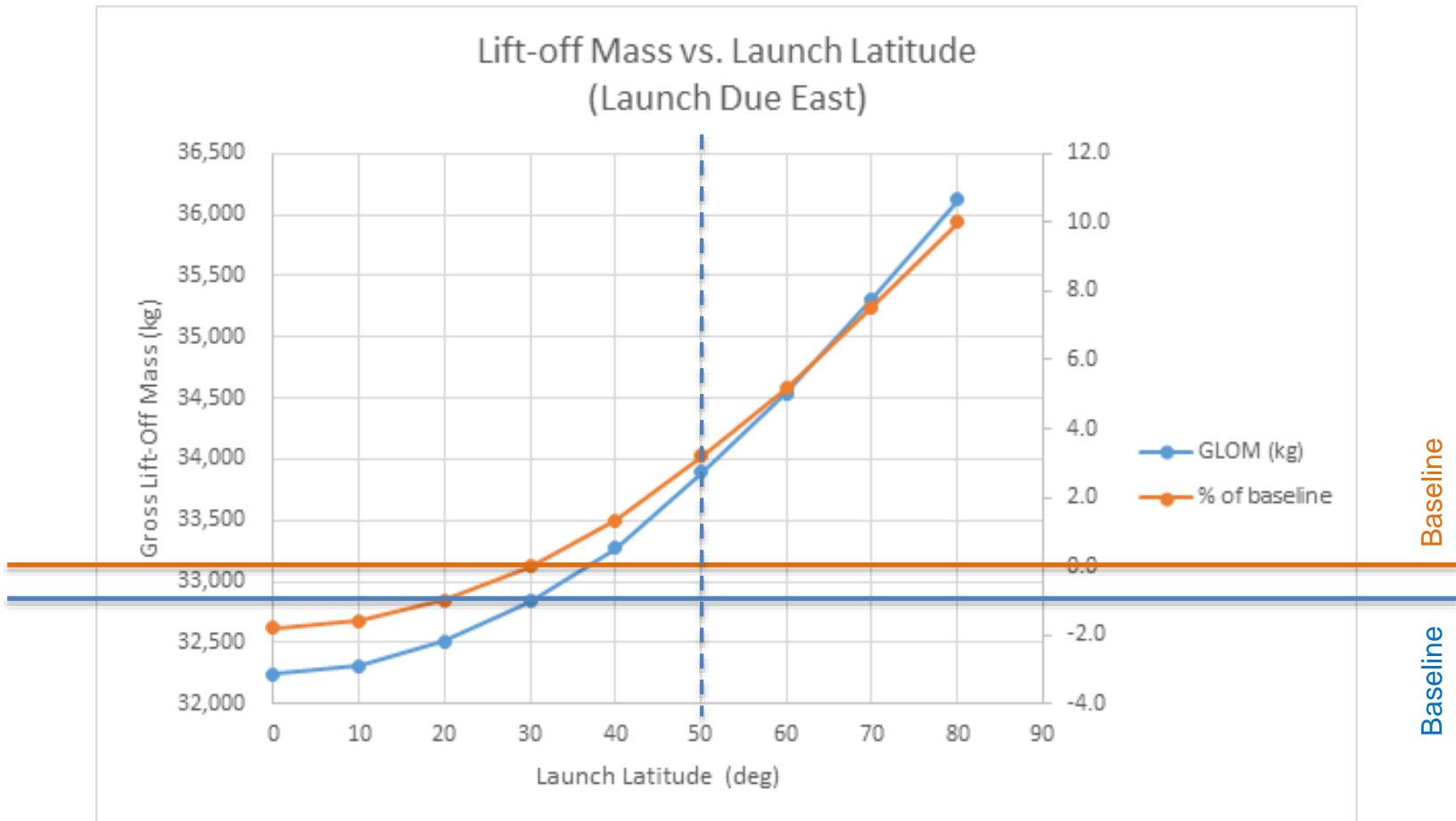

Representative example using data developed during the MAV "Deep Dive" of Fall 2015 (baseline: due east launch from 30°N)

# Preliminary Mars Surface Location Constraints for EZs



**Elevation Limit = +2 km    Latitude Limits = +/- 50°**

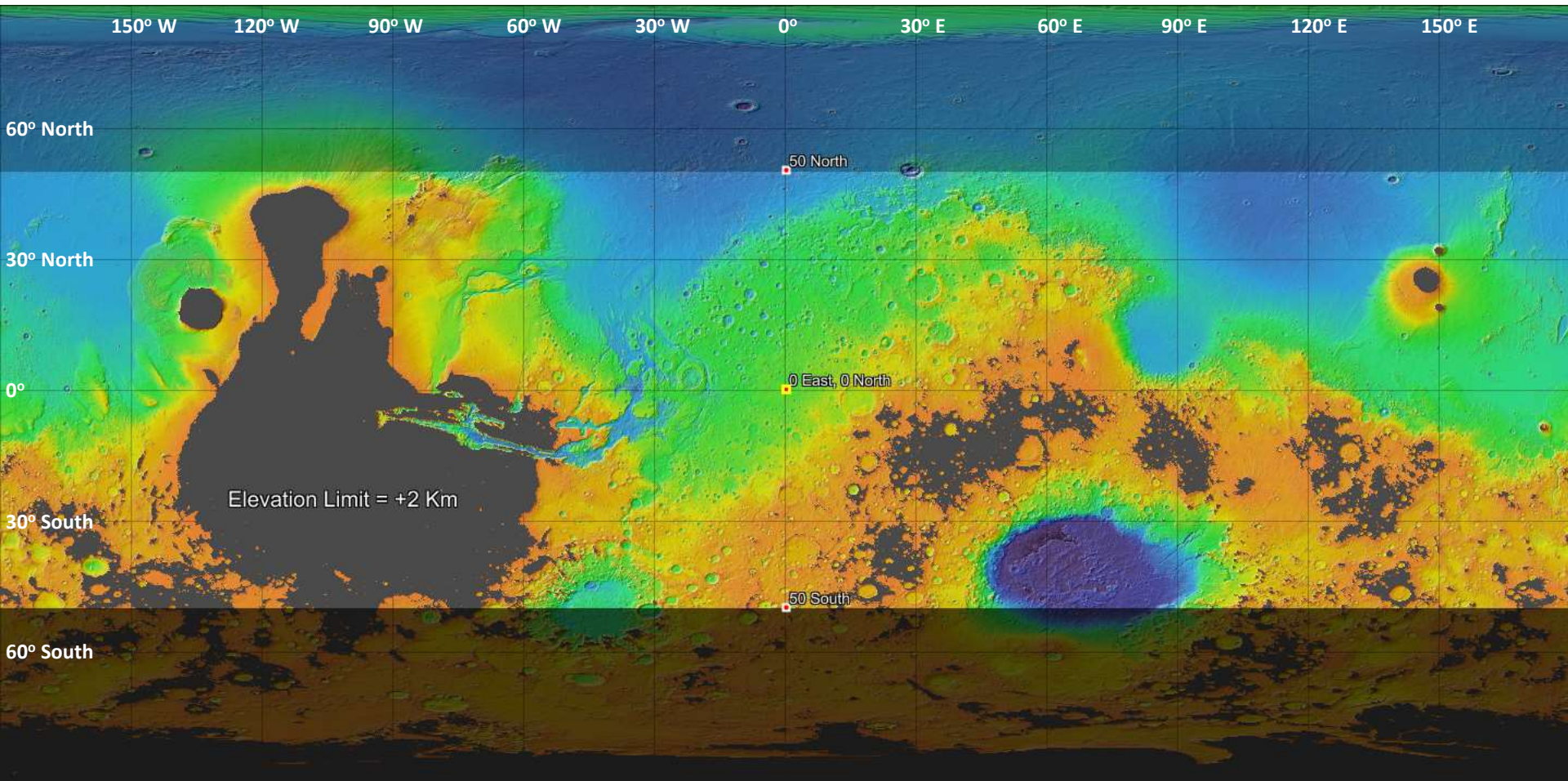

MOLA Color Legend

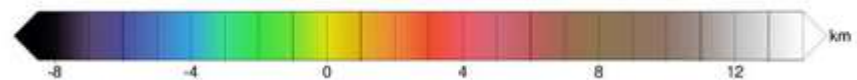
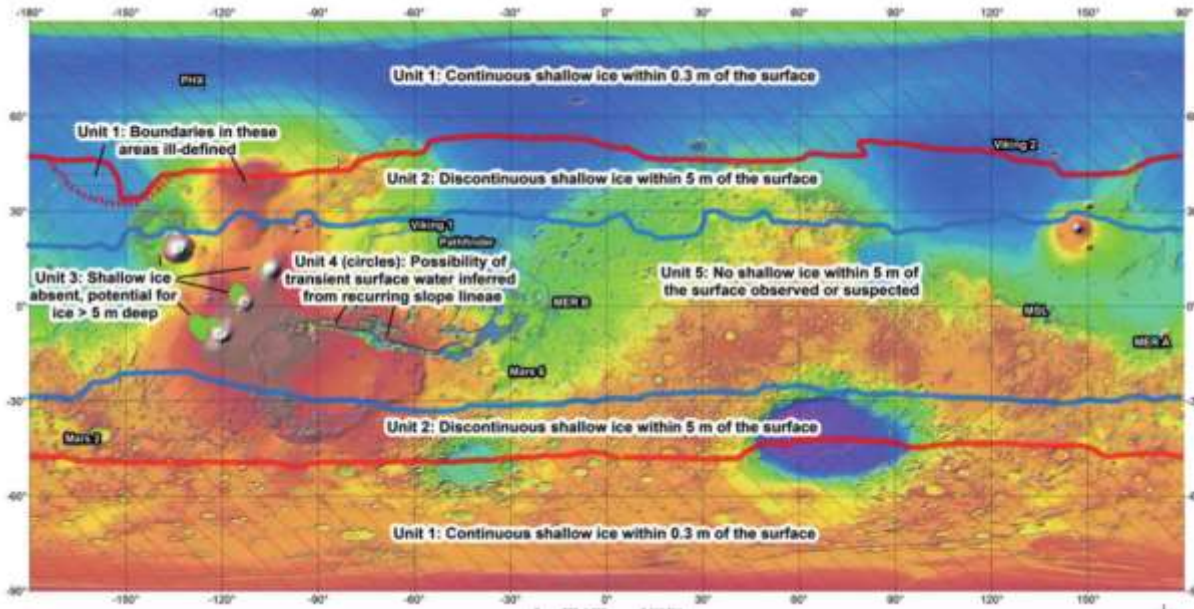

Image created by the authors using the JMARS application  
<https://jmars.asu.edu/>

# Comparing Ice on Mars with EZ Search Area



- For the current assumptions of less than +2 km elevation and less than 50 deg latitude (north or south)

- No polar ice cap sites
- Most of “Unit 1” (shallow ice) falls outside EZ zone
- “Tropical glaciers” (i.e., “Unit 3”) elevation is too high
- Most of “Unit 2” is inside EZ zone

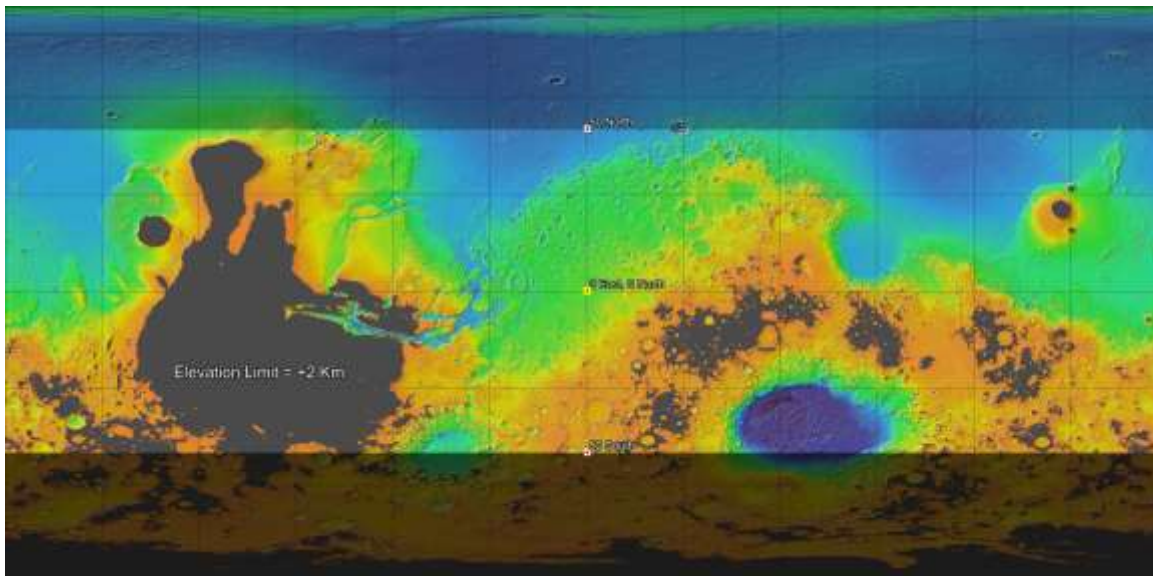

# Ground Ice: Directly Observed



- New small impact craters expose bright materials in crater interiors and ejecta.
- Bright materials disappear within a few months-years → are exposed pure water ice.
- Extent of the northern icy impact craters is close to expected ground ice.
- Also verified by Phoenix (68°N, 235°E).
- Ground ice is in very near-subsurface (cm's deep?), above 60°.

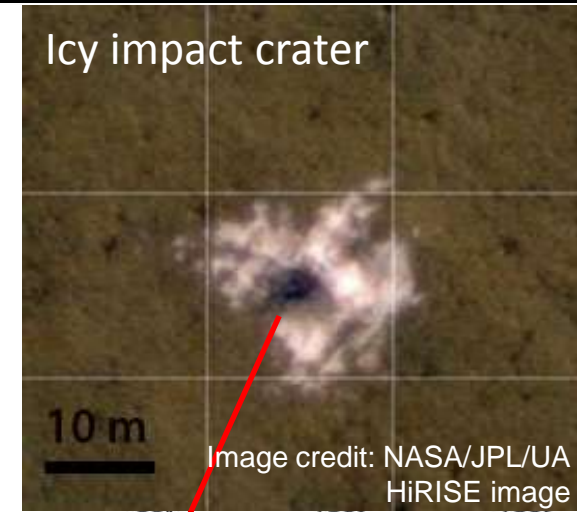

Ice just under surface, exposed by Phoenix scoop



Image credit: NASA/JPL

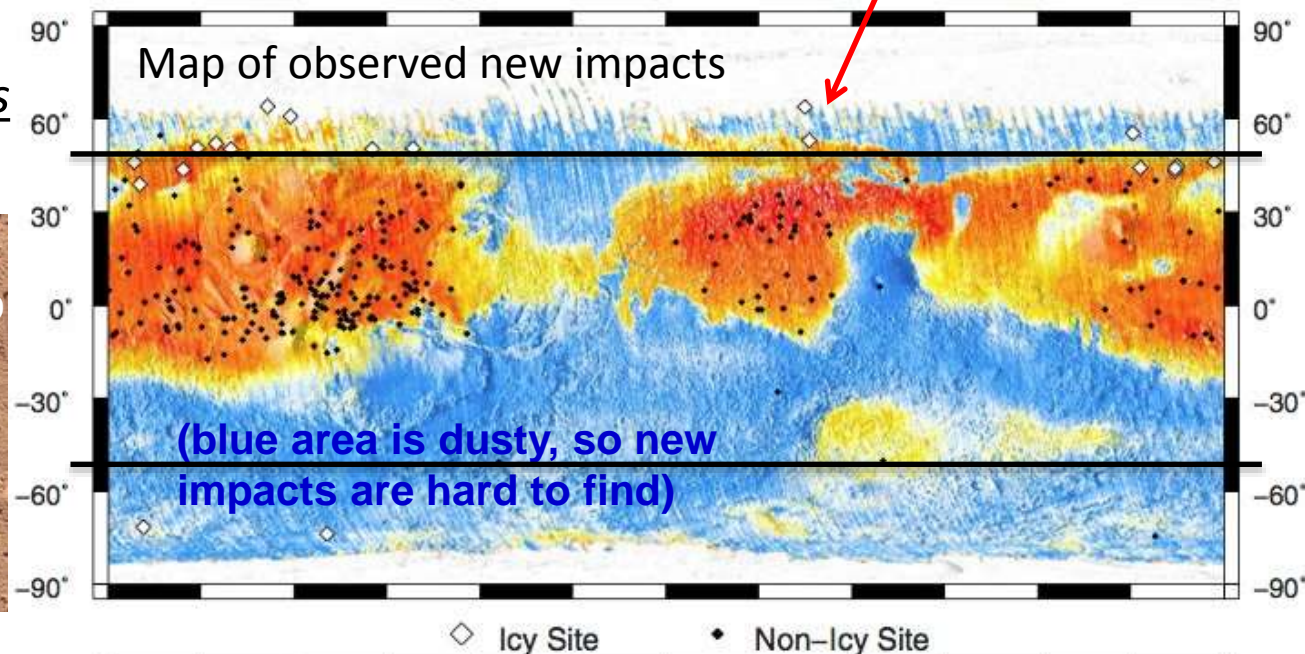

Map is from Dundas et al. 2014. Background of top map is TES dust cover (warmer colors = higher dust content).



# Water Ice Revealed by Fresh Impact Cratering



Ice layer is very near the surface at very high latitudes (i.e., near the polar caps) but is found at progressively increasing depths at lower latitudes

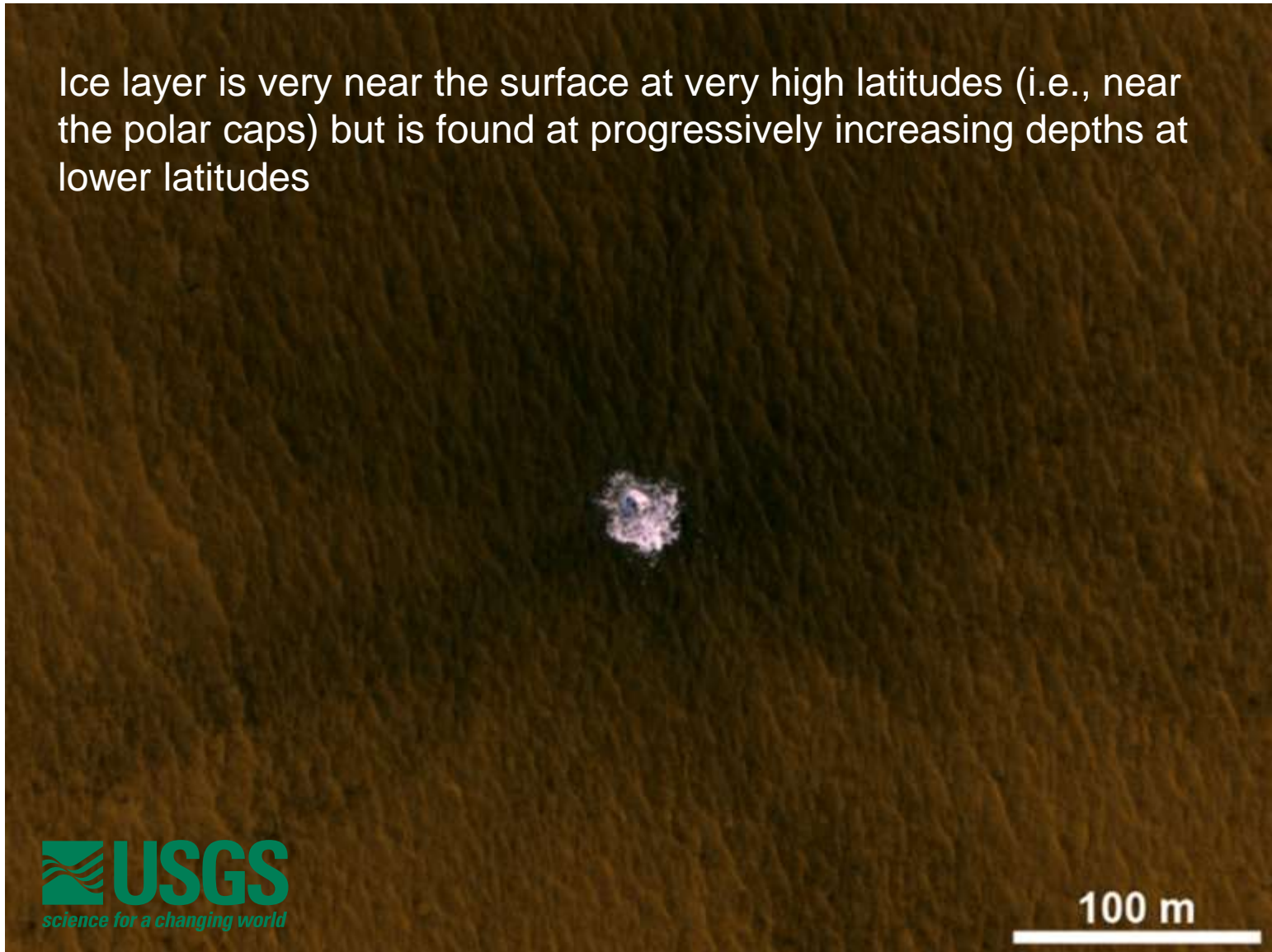

# Map of Mars Glacial Features

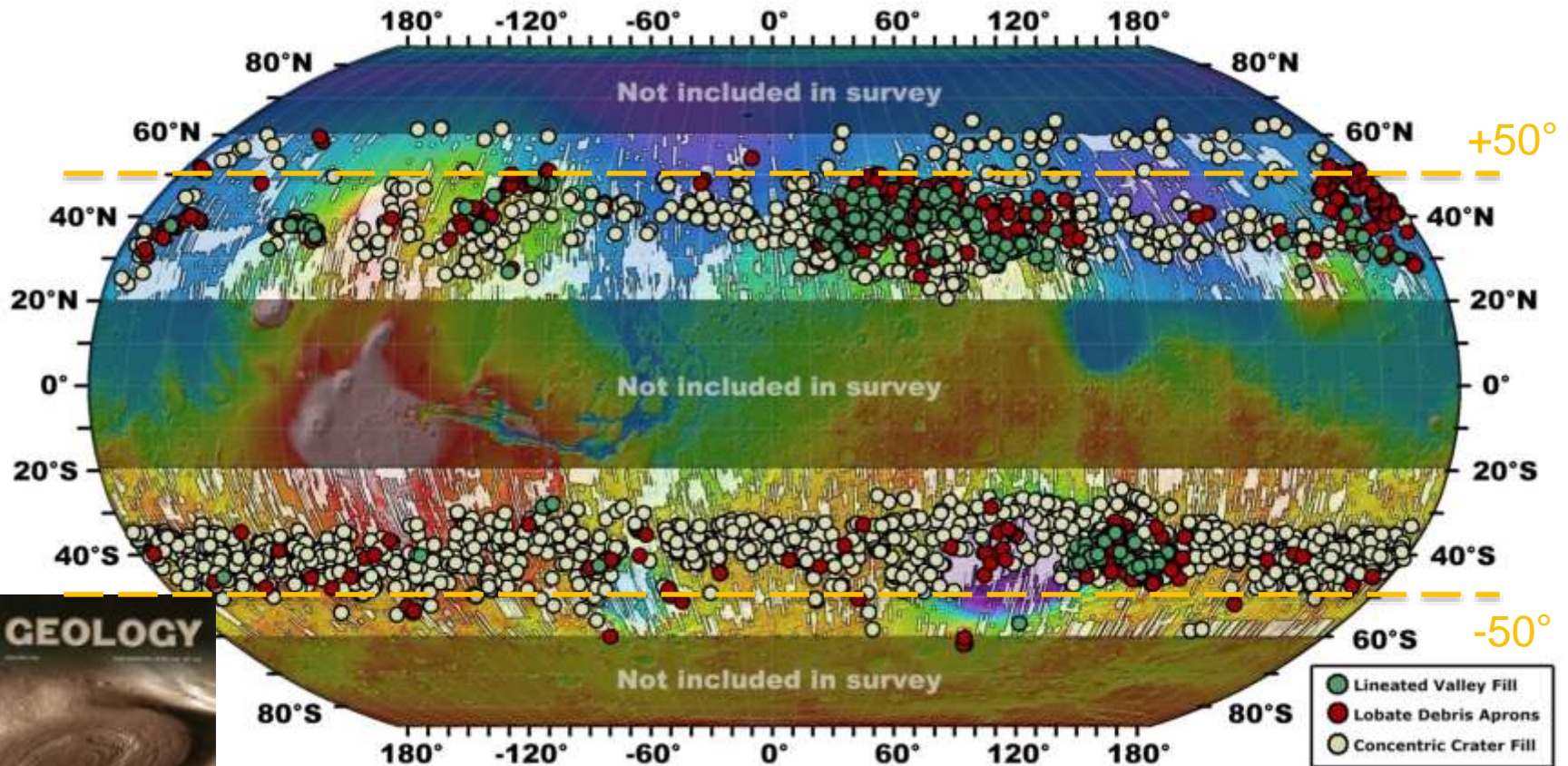

- *With many features, no information about whether residual ice remains, or at what depth is available.*
- *Some lobate debris aprons are confirmed to contain ice.*

*From Dickson et al., 2012; discussion with Jim Head acknowledged*

# Radar Detection of Non-Polar Ice

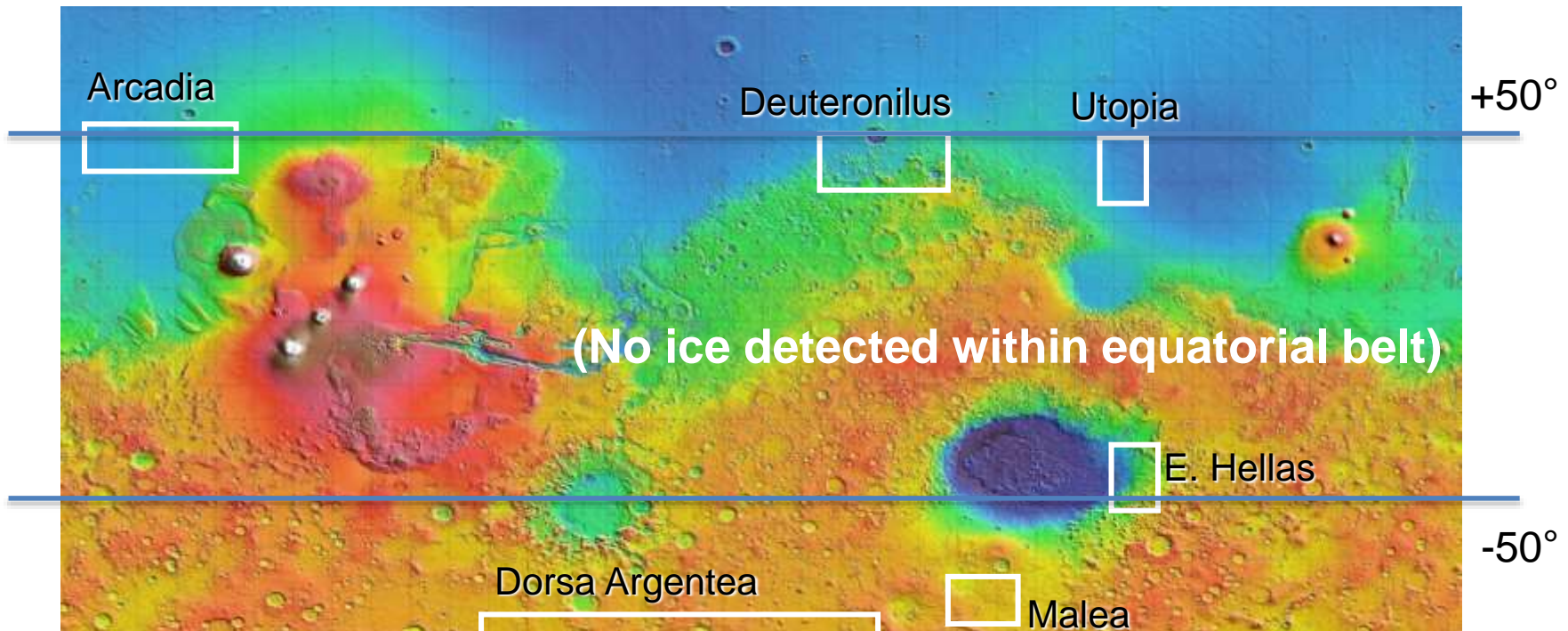

Summary map outlining areas of subsurface ice detections based on data from the MARSIS and SHARAD instruments. *Source: Special Regions SAG2, Rummel & Beaty et al., 2014.*

- Ice 100s of meters in thickness has been detected by the SHARAD radar instrument in several regions away from the poles (Plaut et al., 2009).
- Modeling estimates that these may contain  $1.6 \times 10^5 \text{ km}^3$  or  $\sim 10\times$  North Am. Great Lakes (Karlsson et al., 2015)

# Glacial Deposits on Mars: More Detail



## Mars: Lineated Valley Fill

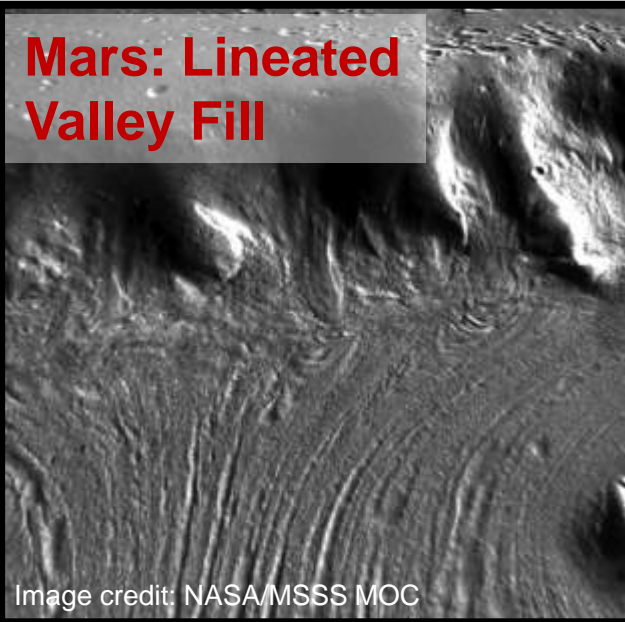
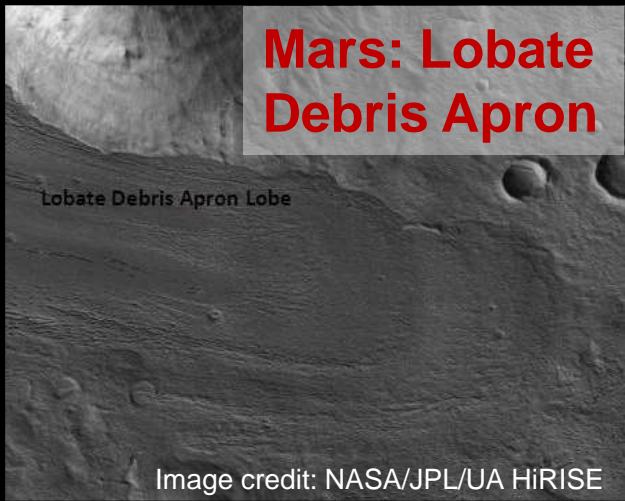

Image credit: NASA/MSSS MOC

## Mars: Lobate Debris Apron



Lobate Debris Apron Lobe

Image credit: NASA/JPL/UA HiRISE

- Mars glaciers are covered with a combination of sublimation till (the residue left as a result of ice sublimation) and rubble from nearby exposed outcrops.
- SHARAD data show a single, discrete surface echo over glaciers, implying that the thickness of the protective debris/dust cover is on order of the SHARAD vertical resolution (~10m) or less.
  - Could be between 1-10 m thick
- Glacial ice is 100s of meters thick.

## Deuteronilus

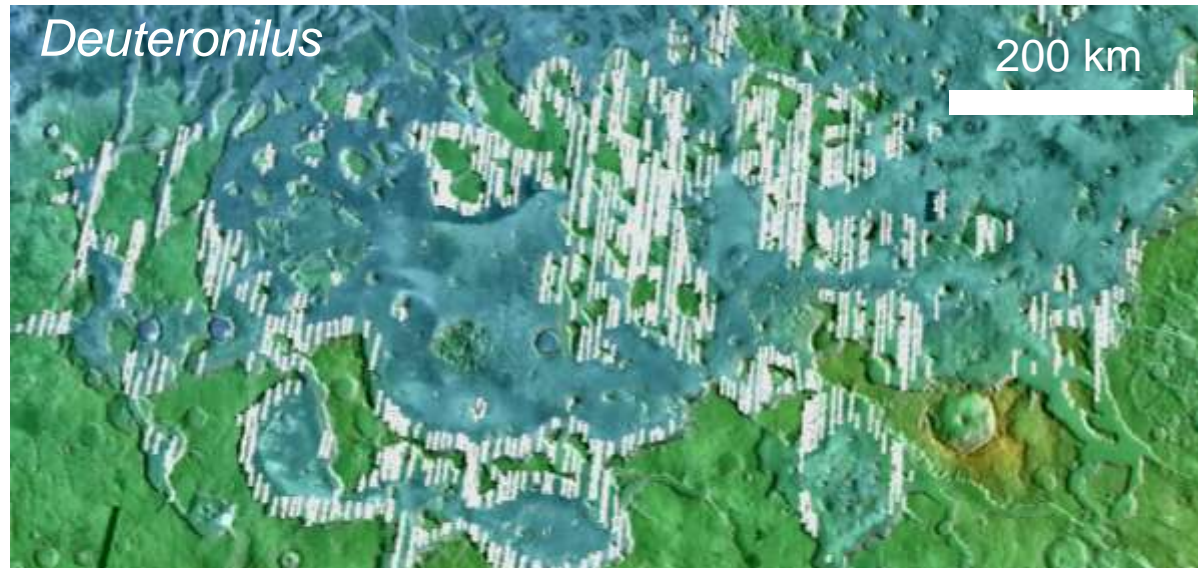

*SHARAD data showing the discontinuous nature of thick subsurface ice in the middle latitudes. White line segments indicate where ice is detected.*

*Rummel et al. (2014) and Plaut (2016, Pers. Comm.)*

# Example Radar Data for Glacier-Like Form Cross-Section



SHARAD Data on  
Lobate Debris Aprons / Lineated Valley Fill  
Show Presence of  
Nearly Pure Ice Buried Beneath  
Debris-Rich Sublimation Residue Layer.

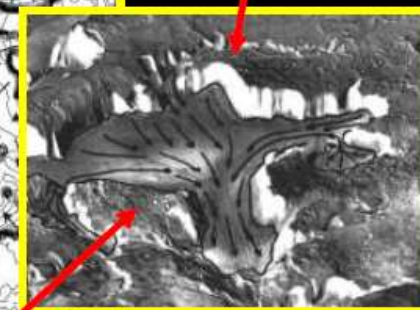
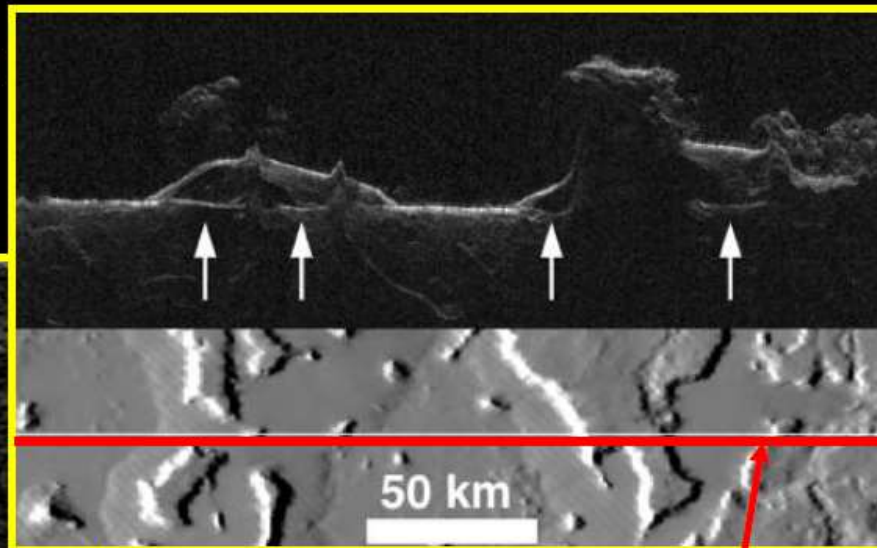
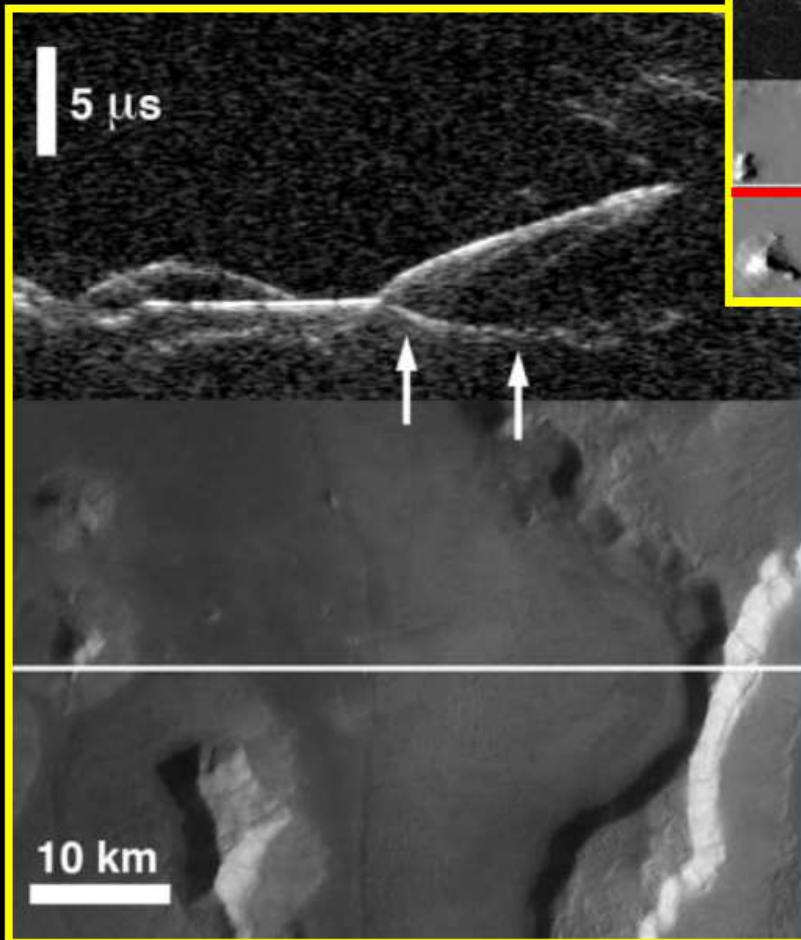

(Plaut et al., 2008)  
(Holt et al., 2007)  
(Head and Marchant, 2006)

# Possible Vertical Profile Through Glacier-Like Forms

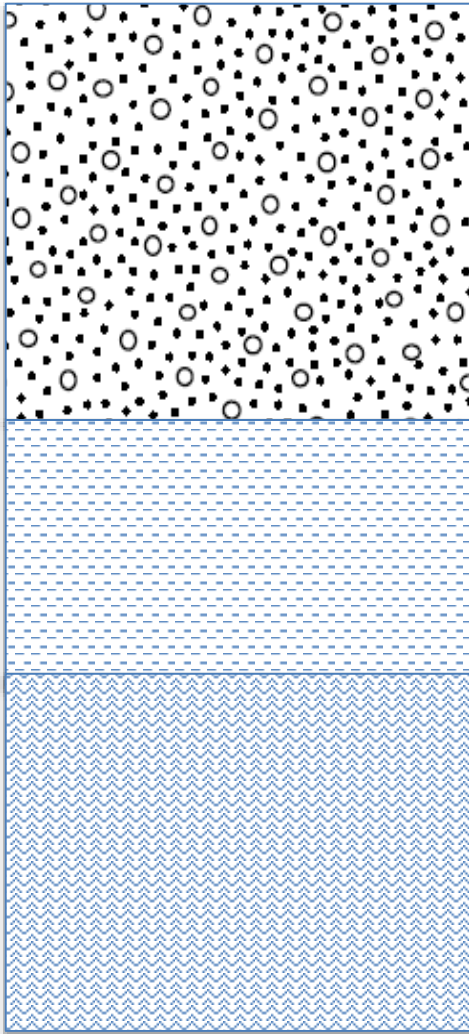

Debris/Sublimation Till Layer. Likely to resemble terrestrial glacial till - an unsorted collection of rocks, cobbles, sand, and fine sedimentary material. From Plaut et al\*, this debris layer on Mars "... can be constrained as greater than 0.5 meters, based on the lack of a strong hydrogen signature in gamma ray and neutron data, and less than ~10 meters, based on the lack of a detection of a shallow soil-ice interface in SHARAD data."



Firn Layer. Typically found on terrestrial glaciers and ice sheets - a layer of granulated snow and ice crystals that is gradually being compressed into solid ice. Because of the granular/porous nature of this layer, any liquid water will move to lower levels until a solid interface is encountered. Due to the lack of snowfall and the overlying debris layer it is thought that any firn on Mars will have been compressed into solid ice long ago (i.e., the firn layer has zero thickness).

Ice Layer. Solid layer of water ice; likely to contain debris gathered as the body of ice was formed as well as fractures of varying sizes due to a variety of causes. Depending on the size of the fracture, these could be "self healing" in the presence of liquid water. This layer could be 100's to 1000's of meters thick.

\*Plaut et al, "Radar evidence for ice in lobate debris aprons in the mid-northern latitudes of Mars," Geophysical Research Letters, Vol. 36, L02203.



Mining Water Ice on Mars

# OPTIONS FOR EXTRACTING WATER FROM ICE

# Accessing and Extracting Water from Ice



- **The previous section described the most likely forms and locations for ice currently found on Mars.**
- **Choices made to accommodate future human missions limit the options available to ice layers covered by a debris layer:**
  - Features or deposits located below 50 deg latitude
    - An ice layer of TBD thickness found at various depths and uncertain aerial extent in the northern lowlands
    - Glacier-like forms found near +50 deg latitude and on the eastern rim of the Hellas basin
- **M-WIP assessed the concept of removing an overburden layer and then collecting ice directly from the exposed layer**
  - Problematic issues identified with this approach
- **M-WIP identified a concept for drilling through the overburden layer and then extracting the subsurface ice by some TBD process**
  - No assessment made of any approach of this type
- **Technologies and operations used in terrestrial polar regions were examined for drilling into and extracting water from substantial bodies of ice**



# M-WIP Observations for mining ice (M-WIP Case A)



- **Although Case A (buried glacial ice deposits) may represent the most concentrated source of water, work during this study was hampered by the relatively low amount of recent engineering research conducted in this area.**
  - Recent emphasis has been on near-surface approaches more applicable on Moon or in northern permafrost regions on Mars ( $>50^\circ$  from equator)
- **Candidate Strategies for deeper ice ( $>1\text{m}$ ) include:**
  - Surface mining of ice: Remove overburden, extract solid ice [Preliminary Analysis Conducted herein] or
  - In Situ Recovery: Drill through overburden, melt/dissolve ice at depth and recover/separate at surface [Not analyzed in this study– **See Slide #82**]

Near-Surface  
“Mobile In Situ  
Water  
Extraction  
(MISWE)”

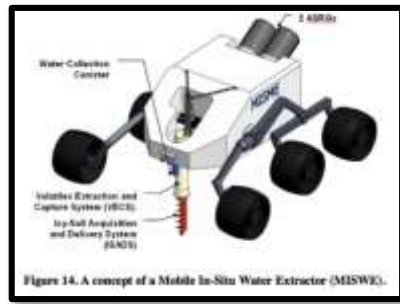

*Credit: K. Zacny, Honeybee Robotics*

“Cryobot” for  
Science  
Exploration  
(earlier  
concept)

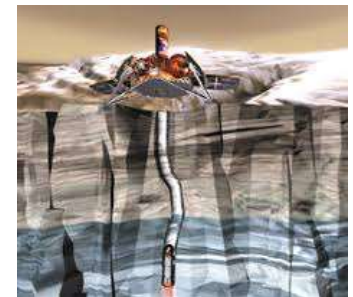

*Credit: NASAJPL (1999)*

# M-WIP: Overburden removal for an Open Pit Over Ice

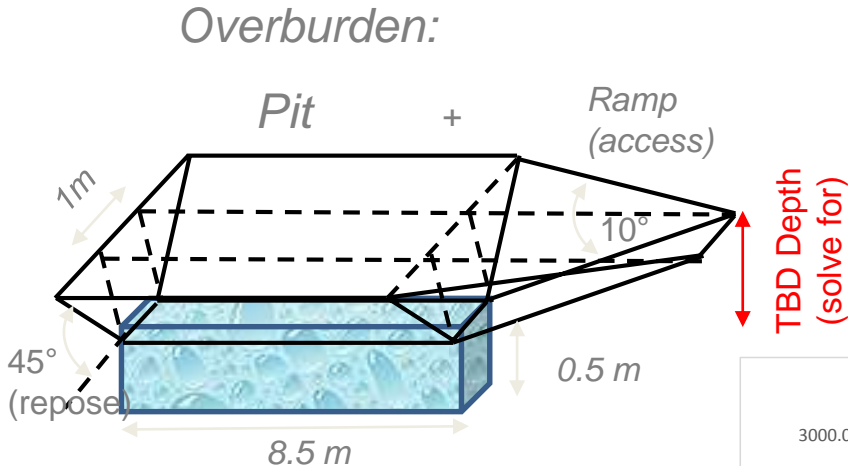

## Subsurface Ice:

4.3m<sup>3</sup> required for 16t water  
 = 8.5m(l) X 1m (w) x 0.5m (d)  
 (width based on notional excavator geometry)

### Notes/Caveats:

- Does not take into account the potentially more difficult excavation of ice-regolith mixtures.
- Overburden removal disturbs the thermal equilibrium which may lead to ice subliming away over time.

- Analysis conducted to compare mass/volume of overburden to be removed for subsurface ice (to enable surface mining of ice)
- Q: At what ice depth does overburden mass/volume exceed mass/volume required for other granular cases (B-C-D)?

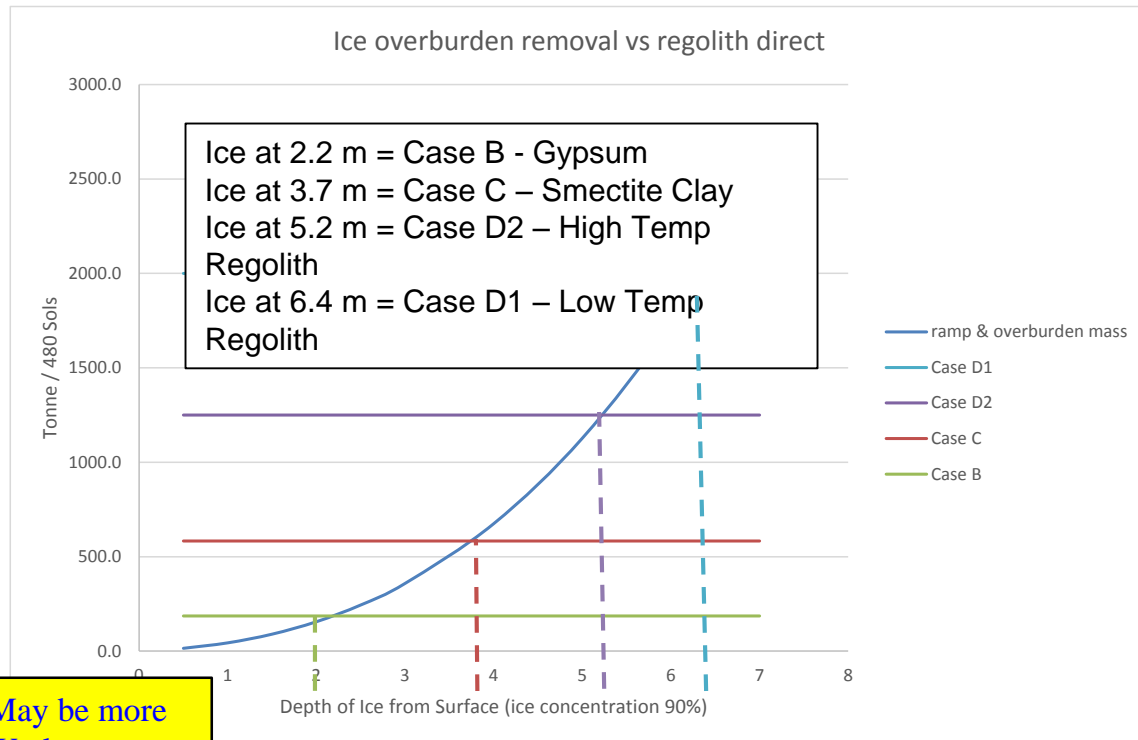

Drilling + Melting not examined for this study: May be more promising than this approach -> Future Work

# M-WIP: Subsurface Ice – A 2<sup>nd</sup> Possible Concept of Operations



- A) Initial landed assets arrive (MAV, ISRU Plant, Power Source) including rover carrying drilling + cryobot equipment (Mobile Drilling/Transport Rig = MDTR)
- B) MDTR traverses to the buried ice deposit
- C) MDTR drills through the overburden (may or may not need to “case the hole” while drilling)
  - “Cryobot” heat probe may either be part of drilling operation, or lowered down the shaft after ice is reached
- D) Once ice layer is reached, cryobot is heated, ice melts/sublimes – cold-trapped in “hood” over “hopper” onboard rover at surface
- E) Once MDTR hopper is filled with ice, rover returns to MAV/Fuel plant. Hopper full of ice is re-melted & processed.
- F) MDTR returns to buried ice deposits for as many round trips as necessary.

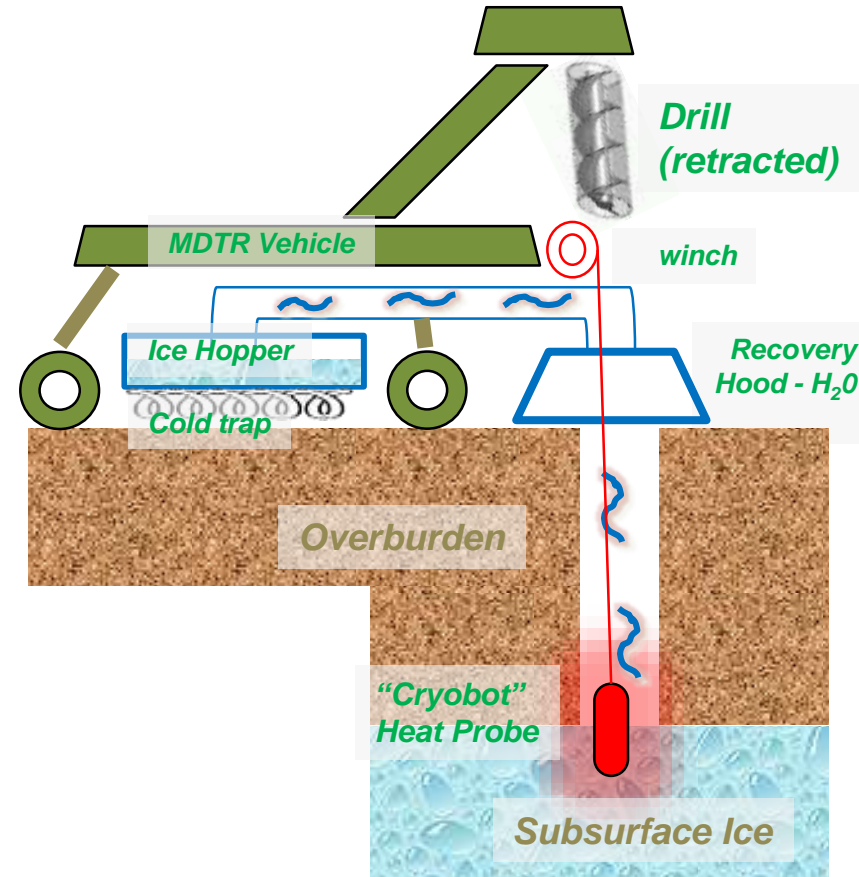

# M-WIP: Subsurface Ice Deposits: Engineering Summary



1. Accessing subsurface ice deposits using a small open pit would require significant removal of overburden. The mass to be moved would go up geometrically with depth to ice, and the break-even point appears to be not more than a depth of burial of 2-3 m.
2. The mechanical acquisition of hard ice could be difficult, especially if there are entrained rocks/sand. Higher excavation energy may be required than for granular materials.
3. Once exposed, the ice deposit would be unstable. The rate of this process has not been modeled, so we don't know yet if this has a practical significance.
4. Methods to collect volatiles in-situ (e.g. down-hole processing) are potentially attractive, but are low TRL and may have complications due to the creation of an underground void.
5. Because the raw material would have a higher concentration of water than any of the mineral-based possibilities, the mass to be transported would be lower, and thus transportation distances could be larger. In addition, the processing could probably be operated with higher yield, lower power, fewer batches/cycles.

**FINDING #4.** Significant engineering challenges may be associated with mining buried glacial ice. If these challenges could be resolved, the subsurface ice cases (A1 & A2) would involve less mass and energy for transportation and processing compared to any of the mineral cases (B-C-D).

# Contemporary Terrestrial “Mining” of Snow and Ice



- **Two approaches typically used in terrestrial polar regions to “mine” snow and ice for potable and utility water**
  - “Harvesting” surface snow/ice and using snow melters (typically using waste heat from diesel power generators) to make water
  - Drilling into ice layers to create in-situ water reservoirs
- **Harvesting ice on Mars**
  - Surface ice not accessible at latitudes included in the EZ zone
  - M-WIP assessment indicates accessing buried ice become increasingly unattractive as overburden depth increases (e.g., at lower latitudes)
- **In situ water reservoirs were first designed and built by the U.S. Army Cold Regions Research and Engineering Laboratory (USA CRREL) in the early 1960s for several U.S. Army camps located in Greenland (Schmitt and Rodriguez 1960; Russell 1965).**
  - commonly referred to as Rodriguez wells or Rodwells
  - *Rodwell-like concept identified but not assessed in M-WIP*

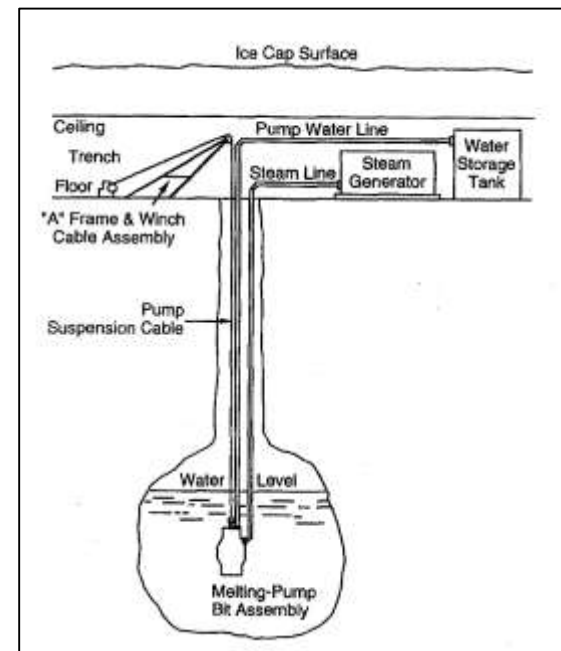

# Concept for Assessment



- **Based on the previous discussion, a Rodwell approach appears to provide a viable means of extracting water that should be assessed**
- **This approach will require drilling through the overburden layer and far enough into the ice layer so that the resulting cavity will not collapse due to the weigh of the overburden**
- **A cased hole through at least the overburden and possibly the upper ice layer will be required so that the cavity can be sealed and pressurized to some TBD level to minimize water sublimation**
- **To assess this option, the following elements must be identified and characterized:**
  - A drill that can penetrate the overburden layer and emplace a casing
  - A drill that can penetrate the ice layer (may or may not be the same as the overburden drill)
  - A concept to melt and recirculate water within the Rodwell “melt pool”

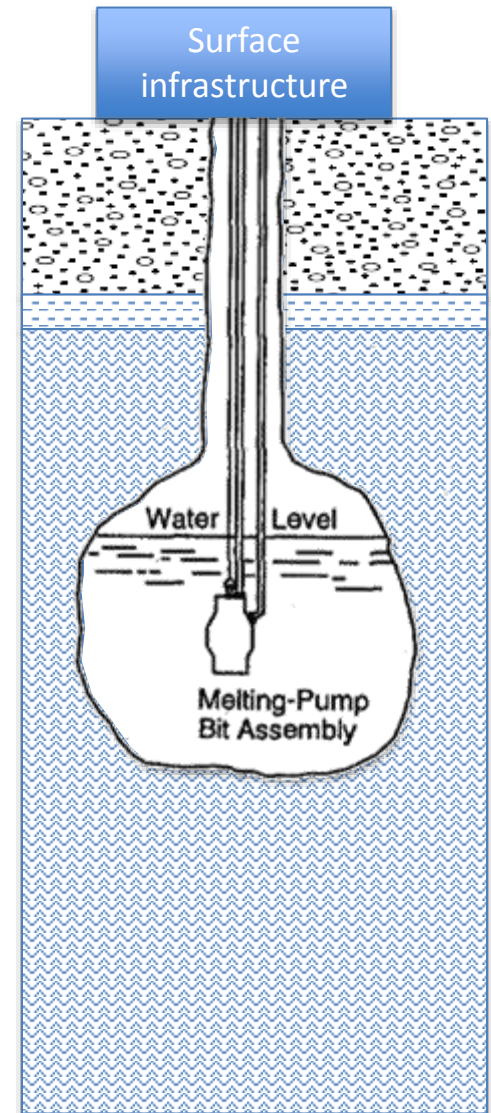



Mining Water Ice on Mars

# DRILLING OPTIONS

# Drilling Options Identified



- **Mechanical drills**
  - Must be used for overburden; can be used for ice
  - Many design put forward for both coring and drilling on robotic missions
- **Electrothermal drills**
  - Can only be used for ice
  - Many design exist for both coring and drilling
- **Hot water drills**
  - Can only be used for ice
  - Many design exist for both coring and drilling
  - This technology is easily scalable to create larger diameter and/or deeper holes.





- **A study of available mechanical drill options for future human missions was completed in 2013**
  - Results documented in “Drilling System Study; Mars Design Reference Architecture 5.0,” JSC 66635, September 30, 2013
  - This study captured results from a drilling workshop for robotic mission, also completed in 2013
    - Planetary Drilling and Sample Acquisition (PDSA) held at the NASA Goddard Space Flight Center in May, 2013
- **An example drill representative of the type likely to be suitable for this application is the “Icebreaker” drill**
  - Under development at the NASA Ames Research Center
  - Tested in a representative analog environment: University Valley – a debris covered glacier in the Dry Valleys region of Antarctica\*
    - Drill string diameter 2.54 cm
    - Depth to ice varied 20-50 cm.
    - Penetration rates of about 40-50 cm/hour, with <100N downward force
    - Typical power draw of 50-80W (not counting avionics, communications, etc).
    - Max depth was about 1.4 m, limited by drill string length.

\* Dr. Brian Glass, Icebreaker PI, personal communication 28 April 2016

# “Icebreaker” drill test in the Antarctic



Photos courtesy of Brian Glass

# Electrothermal Drills



- **Electrothermal drills are used to create bore holes or to cut ice cores**
- **Electrothermal drills represent a relatively simple technology and hardware designs are easily scalable to appropriate diameters**
- **Liquid water created during the drilling process must be pumped out or periodically lifted out (e.g., in a container) before it refreezes**
- **Electrothermal drills are particularly useful in ice close to the pressure melting point (e.g., ice approximately above  $-10^{\circ}$  C), where mechanical drills are at risk from melting and refreezing of the surrounding ice**
- **Under conditions well below freezing, such as the interiors of terrestrial polar ice sheets, mechanical drills are typically used.**

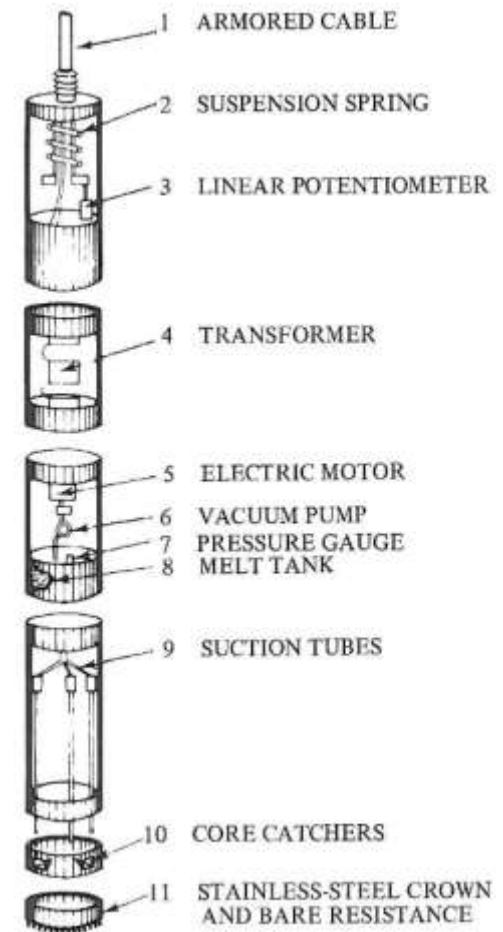

# Example Electrothermal Drill for Ice (mid-1960s design)



## A NEW ELECTROTHERMAL DRILL FOR CORING IN ICE

F. Gillet, D. Donnou, and G. Ricou  
 Laboratoire de Glaciologie CNRS  
 Grenoble, France

### ABSTRACT

*The use of a drill tip made of a bare resistance wire fed at low voltage has allowed us to attain drilling speeds of 6 m/hr in temperate ice. The diameters of the hole and the core sample are 140 mm and 102 mm, respectively. In a cold glacier, a vacuum pump eliminates the meltwater. Using an armored electric cable, 500 m long, and a variable speed winch the equipment weighs a total of 1880 kg. The core barrel with the transformer and the unit for removing the meltwater weighs 170 kg and is 8.20 m long. The cores obtained are 2.8 m long.*

A new model thermal corer developed at our laboratory was tested for the first time in 1968 on the Saint-Sorlin Glacier, France. It differs from the CRREL model (Ueda and Garfield, 1969) in that it works with a bare resistance wire in direct contact with the ice. This makes it possible to apply a strong power density to the drill tip. A corer making a hole of approximately 14 cm gives a 10.2-cm core, and reaches a speed of 6 m/hr in temperate ice, with 6 kW of heating power. In cold ice, the speed is slightly reduced, and depends on the temperature of ice. The special shape of the heating element has also proved to be very effective for drilling in debris-filled ice, which is often found near bedrock.

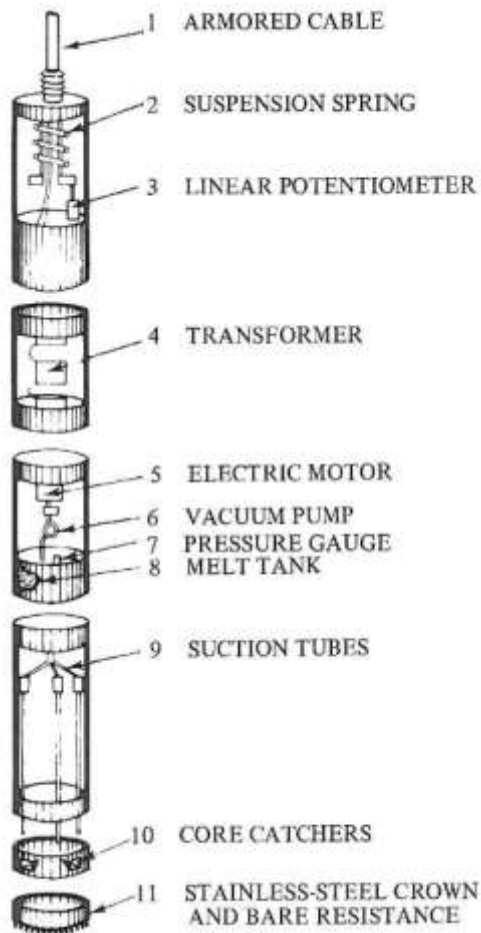

### (6) Weight of the whole drilling unit (without crating):

generator	220 kg
corer	170
cable	400
winch, chassis and mast	330
drive platform of the winch drum	180
housing for speed control of winch and brake resistance	290
housing for controls and measurements	190
accessories (compressor, tools)	<u>100</u>
<b>Total</b>	<b>1880 kg</b>

# Example Electrothermal Drill for Ice (contemporary design)



A thermal drill head showing the absence of cutters. Thermal drills use a heating element to melt an annulus around the ice to be cored. —Credit: Tony Wendricks, Univ. Wisconsin

- **NSF Ice Drilling Development Office (IDDO) developed electrothermal drill.**
  - Transportable by light aircraft and helicopter
  - Mass data of pictured system is listed below
- **Primary use is for ice cores; particularly effective at coring through warmer ice (e.g., ice approximately above  $-10^{\circ}$  C) .**

Type:	Coring
Number in Inventory:	1
Core diameter	86 mm (3.38 in)
Max. Depth Possible:	200 m (656 ft)
Shipping Weight:	550 kg (1200 lbs) includes generator and 100 meter winch sled
Comments:	Assembled for operation w/o fuel: 360 kg (800 lbs)

Copied from: <http://icecores.org/icecores/drilling.shtml>

See also: <http://icedrill.org/equipment/electrothermal.shtml> for more details

# Hot Water Drill



- **Uses a jet of “hot” water to create a hole in snow, firn, or ice.**

- Some amount of “seed water” is needed to start the process but then melt water is used to drill to depth

- **Scalable to meet application need**

- Small devices are used to create holes approximately 2-4 cm in diameter and to depths of 20-40 meters; frequently used for explosive “shots” used in seismic work
- Large devices are used to create holes as large as approximately 60 cm diameter and to depths of several thousand meters (current deepest bore hole is 3000 m)

- **A “clean hot water drilling” capability has been developed to meet scientific needs when drilling into sub-glacial lakes or other regions where life forms may exist.**

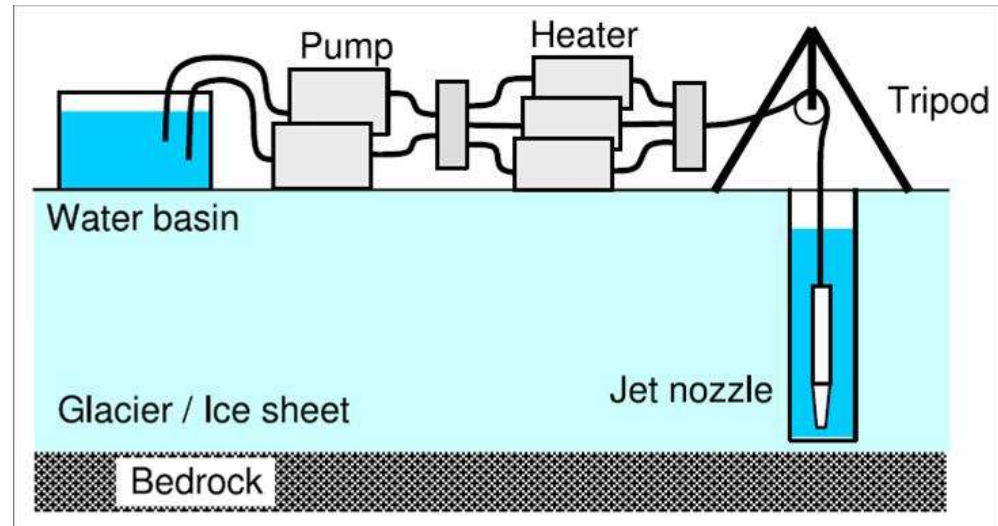

Basic Hot Water Drill schematic diagram.  
(<http://www.ice.lowtem.hokudai.ac.jp/~sugishin/research/hokudai2/langhovde/drilling/drilling.html>).

# Small (i.e., EMC-scale) Hot Water Drill Example



NSF Ice Drilling Development Office (IDDO) portable hot water drill. Image from: <http://icedrill.org/equipment/portable-hot-water-drills.shtml>

- **NSF Ice Drilling Development Office (IDDO) developed a “portable” hot water drill.**
  - Transportable by light aircraft and helicopter
  - Mass data of pictured system is listed below
- **Primary use is for shot holes for seismic work, but they have been used also for access holes through a thin ice shelf.**
- **Can be rapid to operate.**
  - During one 3-month Antarctic season, drilled nearly 170 shot holes and completed four seismic transects

Type:	Non-coring
Number in Inventory:	2
Max. Depth Possible:	Reliable and efficient to a depth of 25-30 m
Shipping Weight:	1590 kg (3500 lbs)
Comments:	Assembled for operation w/o fuel: 1000 kg (2200 lbs)

# Hot Water Drill Example (continued)



- Depth of hole created by a hot water drill is limited primarily by the amount of hose available
- Several designs exist that efficiently pay out, recover, and store (for ease of transport between locations) relatively long sections of hot water hose
- Pictured system developed by the Univ. of Wisconsin Physical Science Laboratory



Posted at: <http://www.psl.wisc.edu/projects/large/agr>



# “Hybrid” Hot Water/Thermal Drill



- **Closed loop system circulating a hot fluid (typically water or glycol) to melt bore holes**
- **Example shown was used for IceCube Neutrino Observatory project and typically used to melt through firn**
- **Concept also applicable in ice**



Upper photo: <https://icecube.wisc.edu/science/stats>

Lower photo: <http://www.psl.wisc.edu/observer/spring09/ifd.html>

# Other Uses for (Benefits of) Hot Water Drills



An unusual luxury for a British Antarctic Survey glaciological party in the 'deep field', several weeks into a field season, is a hot bath, improvised from a hot-water drilling system (photo courtesy of David Vaughan; posted at <http://www.swisseduc.ch/glaciers/glossary/hot-water-drilling-en.html>).

# “Clean Hot Water Drilling” already implemented in terrestrial applications – addressing planetary protection considerations



- **The Scientific Committee on Antarctic Research (SCAR) has issued a formal Code of Conduct on the exploration of subglacial aquatic environments**
  - Adopted at the XXXIV Antarctic Treaty Consultative Meeting (Buenos Aires, 2011)
- **This Code of Conduct is comparable to Planetary Protection policies likely to be adopted for Mars subsurface access**
- **Terrestrial experience likely to provide guidance for Mars**

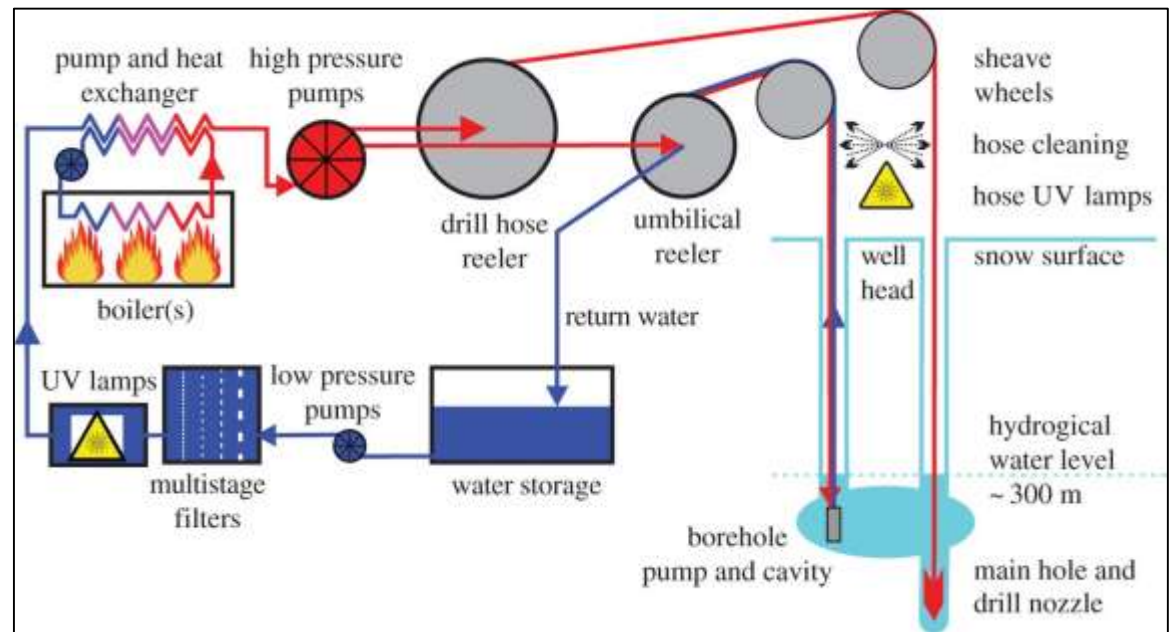

Schematic of the optimized Clean Hot-Water Drill (CHWD) water circulation system\*

## \*Clean subglacial access: prospects for future deep hot-water drilling

Keith Makinson, David Pearce, Dominic A. Hodgson, Michael J. Bentley, Andrew M. Smith, Martyn Tranter, Mike Rose, Neil Ross, Matt Mowlem, John Parnell, Martin J. Siegart

Phil. Trans. R. Soc. A 2016 374 20140304; DOI: 10.1098/rsta.2014.0304. Published 14 December 2015

# Drilling Options Summary and Findings



- **Three classes of drills – mechanical, electrothermal, and hot water – are in common use for drilling into terrestrial snow and ice**
  - All of these options have specific implementations that have been (easily) scaled to meet a variety of drilling needs
- **For applications at Mars:**
  - A mechanical drill is the only option able to drill through the overburden layer
  - If the firn layer is relatively thin (or non-existent) the mechanical drill could continue drilling into the ice to a sufficient depth where Rodwell operations can begin
  - If a thick firn layer or a highly fractured ice layer is encountered under the overburden, a hot water drill can be used to reach depths in the ice where Rodwell operations can begin
  - Both of these last two statements indicate that a preliminary survey of the candidate drilling site using ground penetrating radar or test bore holes may be necessary
  - Electrothermal drills are unlikely to be useful given the anticipated ice temperatures
- **Terrestrial ice drilling operations have already started to address concerns that are likely to be raised for planetary protection reasons on Mars**



Mining Water Ice on Mars

# MINING OPTIONS

# Terrestrial Polar Operations: The Rodriguez Well\*



- In situ water reservoirs were first designed and built by the U.S. Army Cold Regions Research and Engineering Laboratory (USACRREL) in the early 1960s for several U.S. Army camps located in Greenland (Schmitt and Rodriguez 1960; Russell 1965).
  - commonly referred to as Rodriguez Wells or Rodwells
- Snow or ice is melted and stored in place at some depth below the surface of the ice cap, eliminating the need for mechanical handling of snow and for fabricated storage tanks
- Water wells or Rodwells have been used at:
  - Camp Fistclench (Greenland, 1957)
  - Camp Century (Greenland, 1959 and 1960)
  - Camp Tuto (Greenland, 1960)
  - South Pole Station (Antarctica, 1972-73 and 1995-present; currently using third Rodwell)
  - IceCube drilling operation (2004 – 2011; seasonal only)

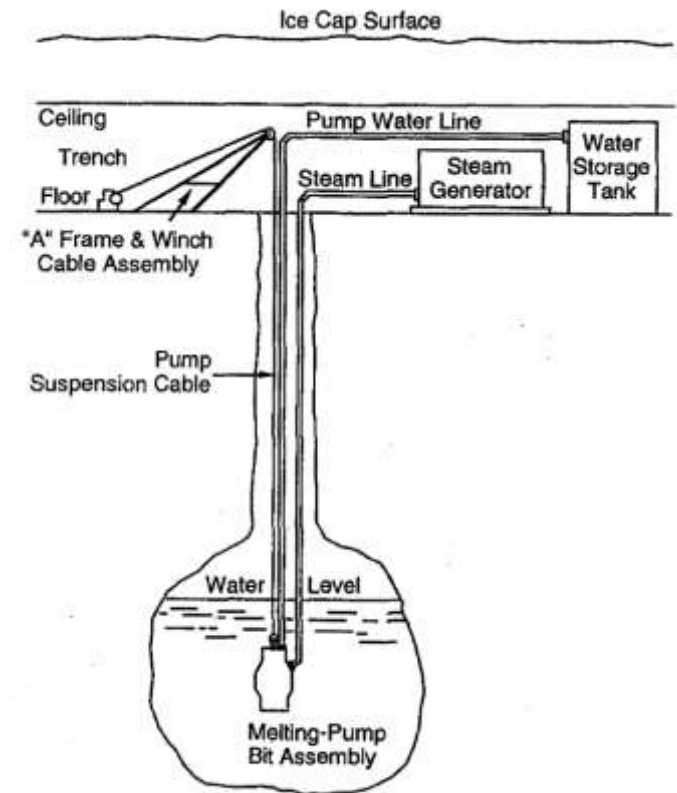

Figure 1. Camp Century water well equipment (from Clark 1965).

\*Lunardini, V.J. and J. Rand (1995). Thermal Design of an Antarctic Water Well. CRREL Special Report 95-10.

# Developing a Rodriguez Well\*



- **A hole is driven/drilled down into the snow or ice until impermeable strata are intercepted or until refreezing melt water forms its own impermeable barrier (this is necessary because melt water will not pond in the firn layer)**
- **The melt water then ponds and, after sufficient reserve capacity has been established in the well, pumping can begin to supply potable water to the surface.**
- **The size and shape of the ponding cavity depends on the relative rates of melting and water removal by pumping and upon the rate of heat application to the pool:**
  - With a large heat supply and small pumping rate the cavity can grow laterally rapidly
  - If the pool is overpumped, the cavity tends to develop rapidly downward (rather than laterally) due to the high temperature of the reservoir water.
  - The well will “collapse” (i.e., stop producing liquid water) if the rate of water extraction exceeds the rate of heat input necessary to maintain the liquid pool
- **CRREL software available to compare a variety of operational parameters**

\*Lunardini, V.J. and J. Rand (1995). Thermal Design of an Antarctic Water Well. *CRREL Special Report 95-10*.

# Example Case: Old South Pole Station Rodwell\*

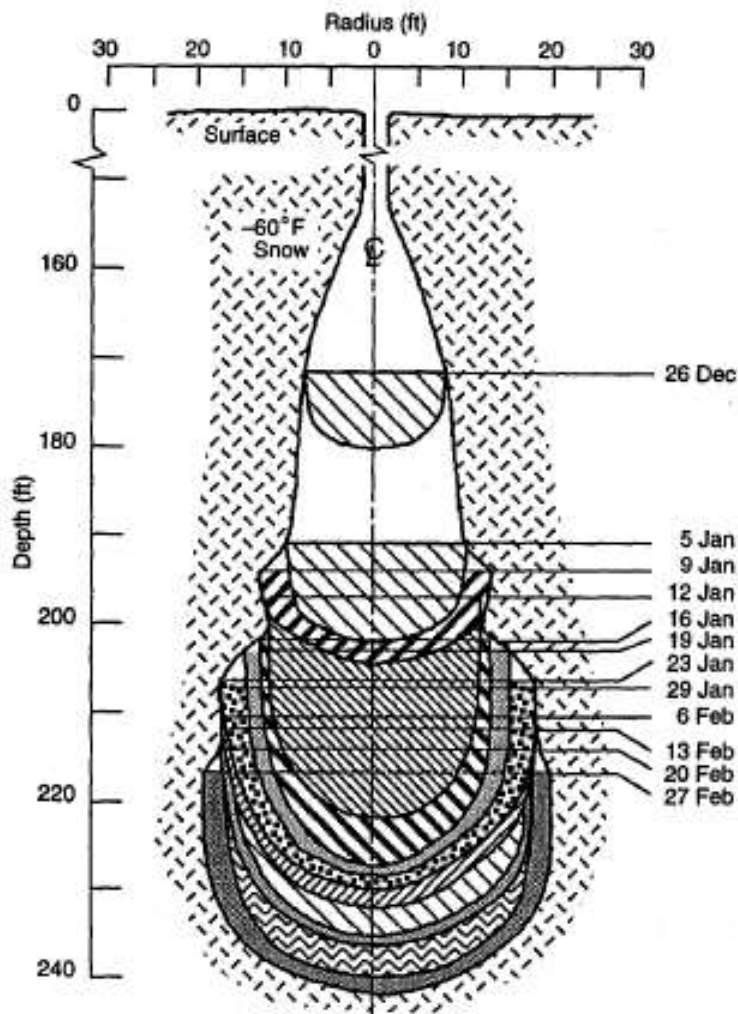

Date (1972-73)	Cum Water Withdrawn	
	(gal)	(MT)
16-Dec	0	0
26-Dec	4100	15
5-Jan	9495	36
9-Jan	11495	43
12-Jan	15181	57
16-Jan	18786	71
19-Jan	19536	74
23-Jan	21786	82
29-Jan	26286	99
6-Feb	27786	105
13-Feb	30486	115
20-Feb	33336	126
27-Feb	37836	143

Figure 6. 1972 development well at Old South Pole Station (see Appendix A).

\*Lunardini, V.J. and J. Rand (1995). Thermal Design of an Antarctic Water Well. *CRREL Special Report 95-10*.



# Mining Options Summary and Findings



- **M-WIP assessment indicated that opening a pit to mine ice has several problems associated with it. No further assessment performed in this study**
- **The Rodriguez Well is a technique that appears to provide Mars missions with a means to create large quantities of water from subsurface ice and store that water in place until used**
  - Rodwells have been used operationally since the late 1950s
  - The total quantities made and withdrawal rate used both typically exceed what is likely to be needed for Mars operations
    - Operating a Rodwell at these low quantities and rates must be investigated further
- **Rodwells are a balance between heat input and water withdrawal rates**
  - Analytical tools exist to find the appropriate balance for a given scenario
  - Operational Rodwells must be monitored to prevent the well from “collapsing” (ceasing to produce) or overproducing water



Mining Water Ice on Mars

# POWER/THERMAL OPTIONS

# Powering the Rodwell



- **Once initiated, a Rodwell requires an uninterrupted source of heat to prevent the water reservoir from refreezing**
  - Typical Rodwell operations constantly circulate hot water through the subsurface water reservoir
- **From EMC studies, two options exist**
  - Use an electrically powered heater
  - Use a heat exchanger to capture waste heat from a power generating system
- **Electric power could come from solar or nuclear sources**
  - Solar power will require power storage in addition to solar arrays to provide the “uninterrupted” power during night time and possibly dust storms
    - For a representative example of how this option could be implemented for a human mission, see Rucker, M.A., Integrated Surface Power Strategy for Mars, Paper 5074, Nuclear and Emerging Technologies for Space (NETS) 2015, Albuquerque, 2015.
  - Nuclear sources would be unaffected by night operations and dust storms
    - For a representative example of how this option could be implemented for a human mission, see Rucker, M.A., et al., Solar Versus Fission Surface Power for Mars, AIAA 2016-5452, AIAA SPACE 2016, Pasadena, 2016.
- **Waste heat could be captured from nuclear sources**
  - RTGs generate roughly 20 times as many thermal Watts as electric Watts
    - The *Curiosity* MMRTG generates 110 We and 2000 Wt
    - *Curiosity* uses heat transfer from the MMRTG “waste heat” as part of its overall thermal management approach
  - “Kilopower” type fission power devices are estimated to generate roughly 4 times as many thermal Watts as electric Watts (see Rucker, M.A. 2016, describe above).



Mining Water Ice on Mars

# **EMC SCENARIO AND REQUIREMENTS**

# EMC Studies: Quantities of Water Needs



- **The First Landing Site/Exploration Zone Workshop for Human Missions to Mars (October 2015) set the target quantity of water to be produced for these missions used in M-WIP**
  - Identify EZs with sufficient feedstock material to produce 100 metric tons (mT) of water that will be used by five crews
    - Five crews was an arbitrary number of crews but considered sufficiently large to realize a payback in the yet-to-be-quantified surface ISRU investment
  - The 20 mT/crew estimate was based on sufficient water to make LOX and CH<sub>4</sub> propellant for each crew's ascent vehicle plus a nominal amount that is typically consumed in EVA cooling and other miscellaneous ECLSS losses
- **A subsequent EMC study of “plentiful water” implications identified quantities of water needed for three usage cases**
  1. MAV propellants plus EVA usage plus closed loop ECLSS make-up (i.e., the same as that put forward at the EZ workshop)
  2. MAV propellants plus EVA usage plus an open loop ECLSS
  3. MAV propellants plus EVA usage plus open loop ECLSS plus laundry usage

# Consumables Requirements per Mission



500-Day Surface Mission, 4-Crew

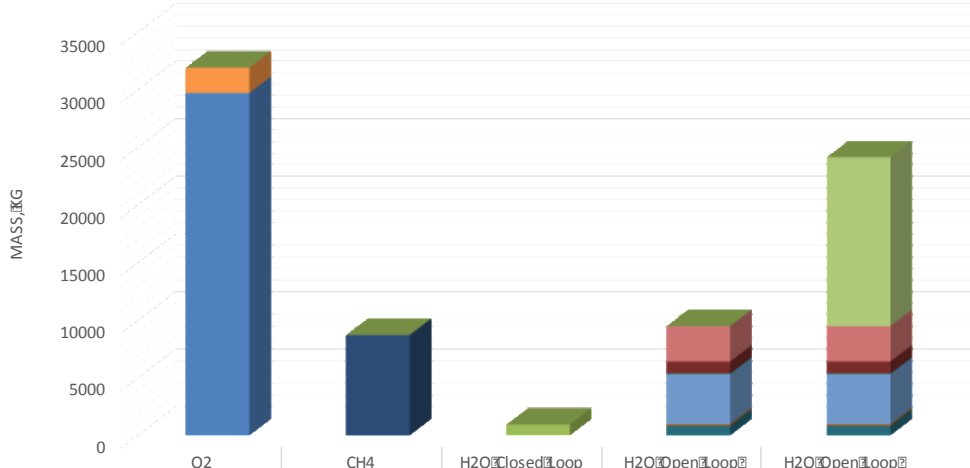

Consumable	O2	CH4	H2O Closed Loop	H2O Open Loop w/o laundry	H2O Open Loop w/laundry
H2O Closed-Loop Makeup			970	0	0
Laundry				0	14660
H2O, EVA				3072	3072
Food/Rehyd				1070	1070
Medical				107	107
Drink				4280	4280
Flush				134	134
Hygiene				856	856
SPR Fuel/Cell Reactant		0			
MAV Fuel		8748			
ECLSS O2	2,200				
SPR Fuel/Cell Reactant	0				
MAV Oxidizer	29758				

Case 1    Case 2    Case 3

H2O Open-Loop w/o Laundry

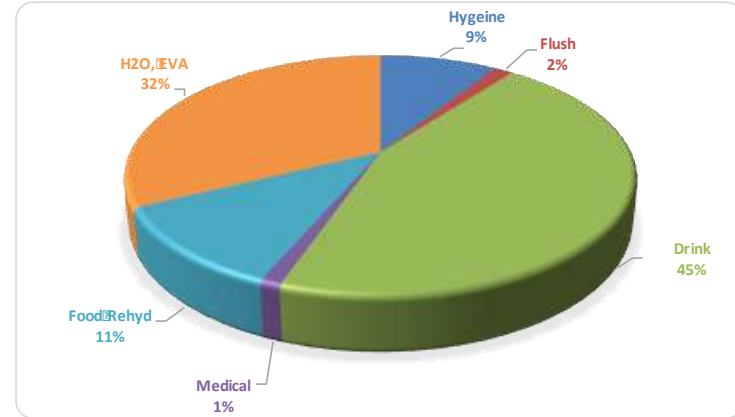

H2O Open-Loop with Laundry

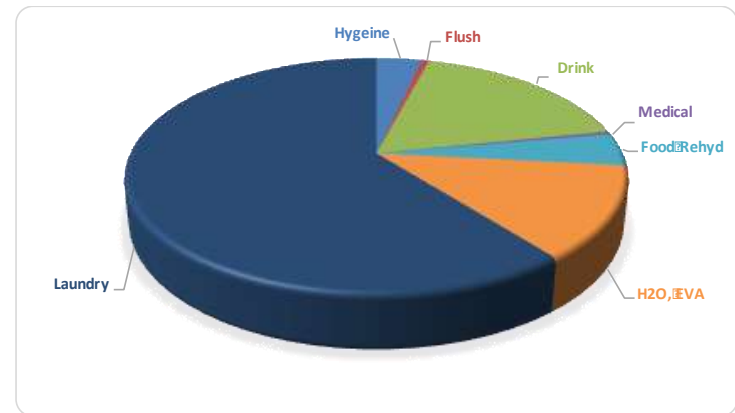

# Water Requirements to Satisfy Usage of Five Crews



Date	Years	O2	CH4	H2O <sub>ICL</sub>	H2O <sub>DL(w/o Laundry)</sub>	H2O <sub>DL(w Laundry)</sub>	Assumes All Prop and O2 from H2O			
							H2O <sub>Prop+O2</sub>	Total H2O <sub>ICL</sub>	Total H2O <sub>DL</sub>	Total H2O <sub>DL(w Laundry)</sub>
9/14/40	0	32	8.748	0.970	9.519	24.179	19.683	20.653	29.202	43.862
9/2/44	4	64	17.496	1.940	19.038	48.358	39.366	41.306	58.404	87.724
10/23/48	8	96	26.244	2.909	28.556	72.536	59.049	61.958	87.605	131.585
1/30/53	12	128	34.992	3.879	38.075	96.715	78.732	82.611	116.807	175.447
5/9/57	17	160	43.74	4.849	47.594	120.894	98.415	103.264	146.009	219.309
Rate:		7.673	2.100	0.233	2.285	5.805	4.726	4.959	7.011	10.531

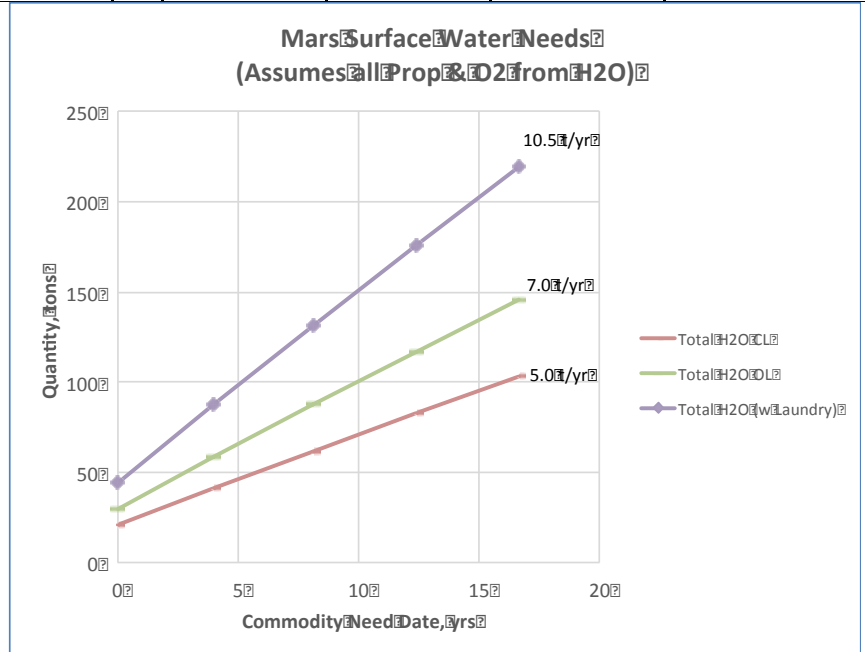
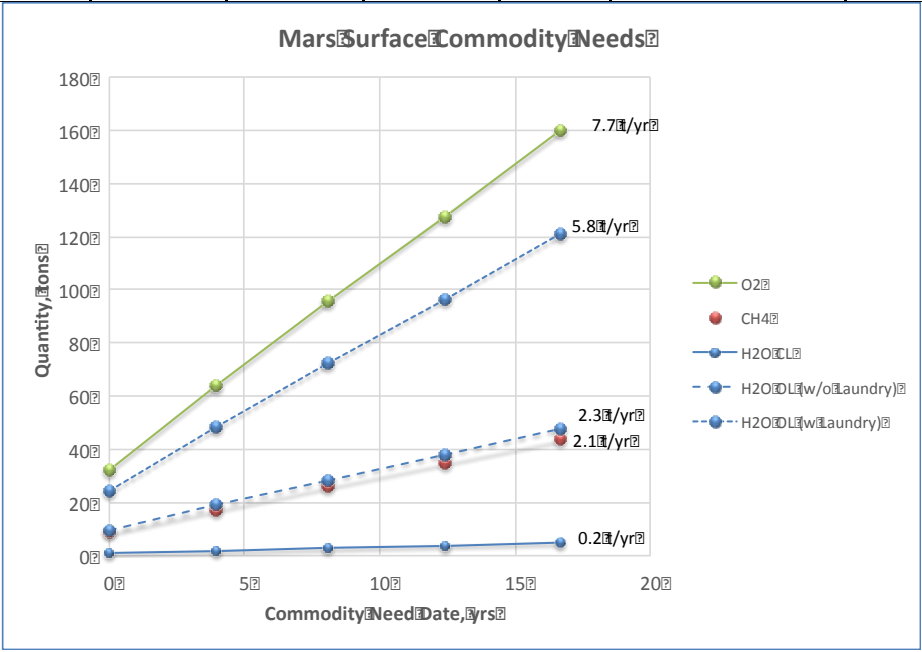

## ISRU-Derived H<sub>2</sub>O

Case 1	20.7 t/mission	4.96 t/yr
Case 2	29.2 t/mission	7.01 t/yr
Case 3	43.9 t/mission	10.5 t/yr

# Energy Required to withdraw water from a Rodwell



- **Energy required for several reasons in order to “mine” water ice**

- Change ice to liquid water (adding sensible heat and latent heat; see graph at right)
- Once melted, keep water liquid until desired quantity is pumped out (i.e., feed heat lost to surrounding ice and atmosphere in cavity)
- Pump liquid to the surface from a liquid water pool that is gradually sinking as water is withdrawn (recall Old South Pole Station Rodwell example)

- **CRREL simulation combines the effects of the first two; pump energy must be determined separately**

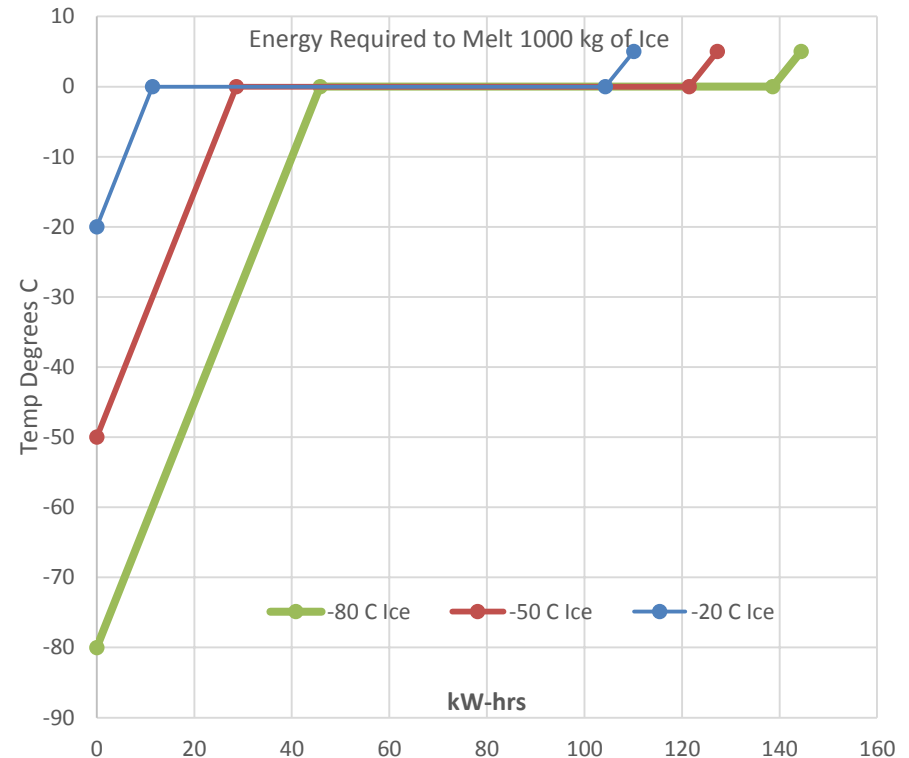

Calculated Energy Required to raise temperature and for solid to liquid phase change





# Theoretical Time Needed to Melt (and Withdraw) Water for Cases 1-3

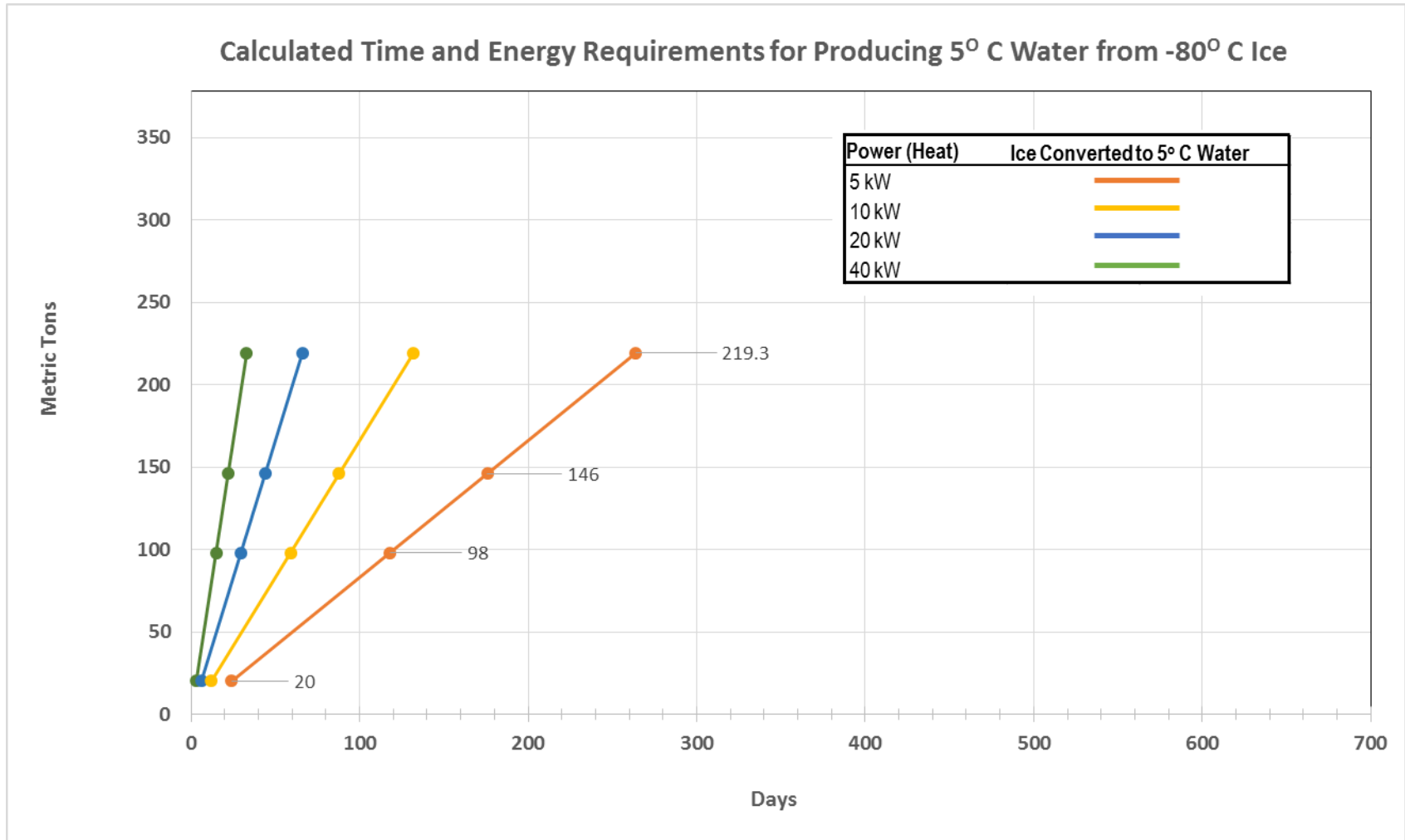

\*EMC studies of Mars surface operations have included up to 40 kW of power that has been used for ISRU operations when the crew is not present

# Strategies for Water Withdrawal



- **For all cases, a cased hole must be drilled into the ice sheet**
  - Prevent debris layer from collapsing into access hole
  - Allow well to be pressurized (with atmospheric CO<sub>2</sub>?) to some TBD level to minimize sublimation
- **Option 1: Withdraw all water ever needed (e.g., for 5 crews, totaling ~100 mT) without stopping; store all water above ground until needed**
  - A trade study of power versus desired withdrawal rate/total time will be needed
  - Sufficient above ground storage will be required (recall diagram at beginning of this discussion)
    - Reuse descent stage propellant tankage?
    - Potential issues with long term storage: leaching from tank walls; UV degradation of tank material
  - Stored water is likely to be allowed to freeze and then re-melt as needed
    - Recall previous diagram (page xx) describing energy required to melt various quantities of ice
    - Consider storing water in multiple “small” containers to avoid re-melting too much ice at any one time
- **Option 2: Withdraw only enough water for immediate needs (e.g., for 1 crew, totaling ~20 mT); “store” water for future needs by leaving it below ground**
  - When sufficient water for immediate needs has been withdrawn, raise down hole equipment and allow the water pool to refreeze
  - TBD power and time will be required to restart the well; probably comparable to initial starting of well
  - Above ground water storage limited to that need for immediate use (or possibly less if the water is used to make propellant, consumed in another process, etc.)

# Example Water Usage Rates



- **“Typical” U.S. family of four:**  
**100 gallons/person/day (379 kg/person/day)**
  - This is both indoor and outdoor usage; 70% indoor and 30% outdoor
  - Source: U.S. EPA; <https://www3.epa.gov/watersense/pubs/indoor.html>
- **“Typical” U.K. family of four:**  
**30 gallons/person/day (112 kg/person/day)**
  - Source: <http://www.ccwater.org.uk/savewaterandmoney/averagewateruse>
- **Summit Station, Greenland (winter):**  
**~18 gallons/person/day (68 kg/person/day)**
  - Based on an average population of four people
  - Source: Haehnel and Knuth “Potable water supply feasibility study for Summit Station, Greenland”
- **Summit Station, Greenland (summer):**  
**~9.4 gallons/person/day (36 kg/person/day)**
  - Based on an average population of 30 people
  - Source: Haehnel and Knuth “Potable water supply feasibility study for Summit Station, Greenland”
- **Mars Surface Crew (with laundry):**  
**~3.5 gallons/person/day (13.3 kg/person/day)**
  - Based on a population of four crew
- **Mars Surface Crew (without laundry):**  
**~1.6 gallons/person/day (6.0 kg/person/day)**
  - Based on a population of four crew

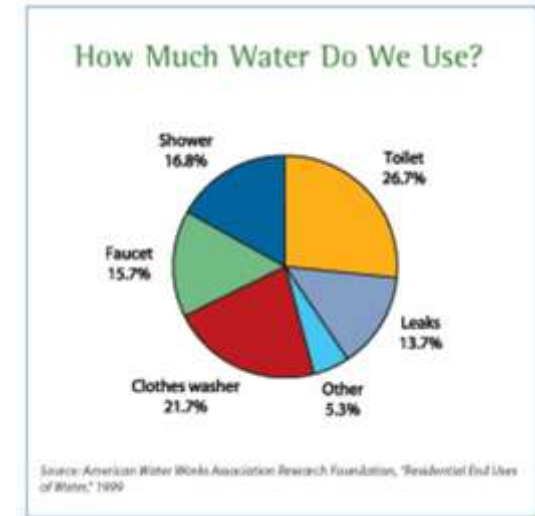

U.S. Family Water Usage

# Predicted Actual Time Needed to Withdraw Water for Cases 1-3 at a 100 gal/day Rate



Water Withdrawn + Water Retained in the Bulb over Time at Various Heat Rates

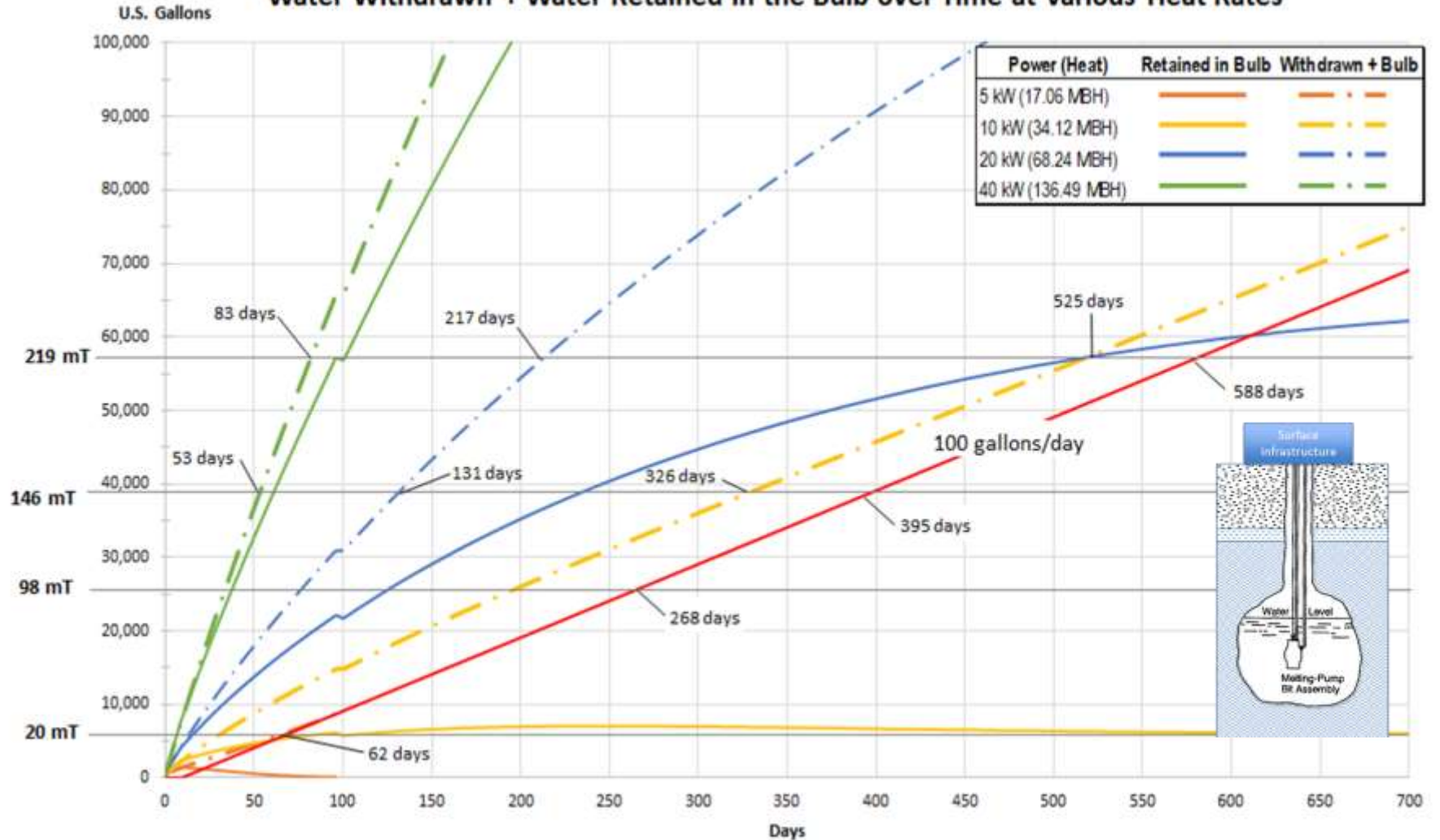

Note: assumes -80° C ice

# Predicted Actual Time Needed to Withdraw Water for Cases 1-3: Close-up View of the Low Time Portion of the 100 gal/day Case

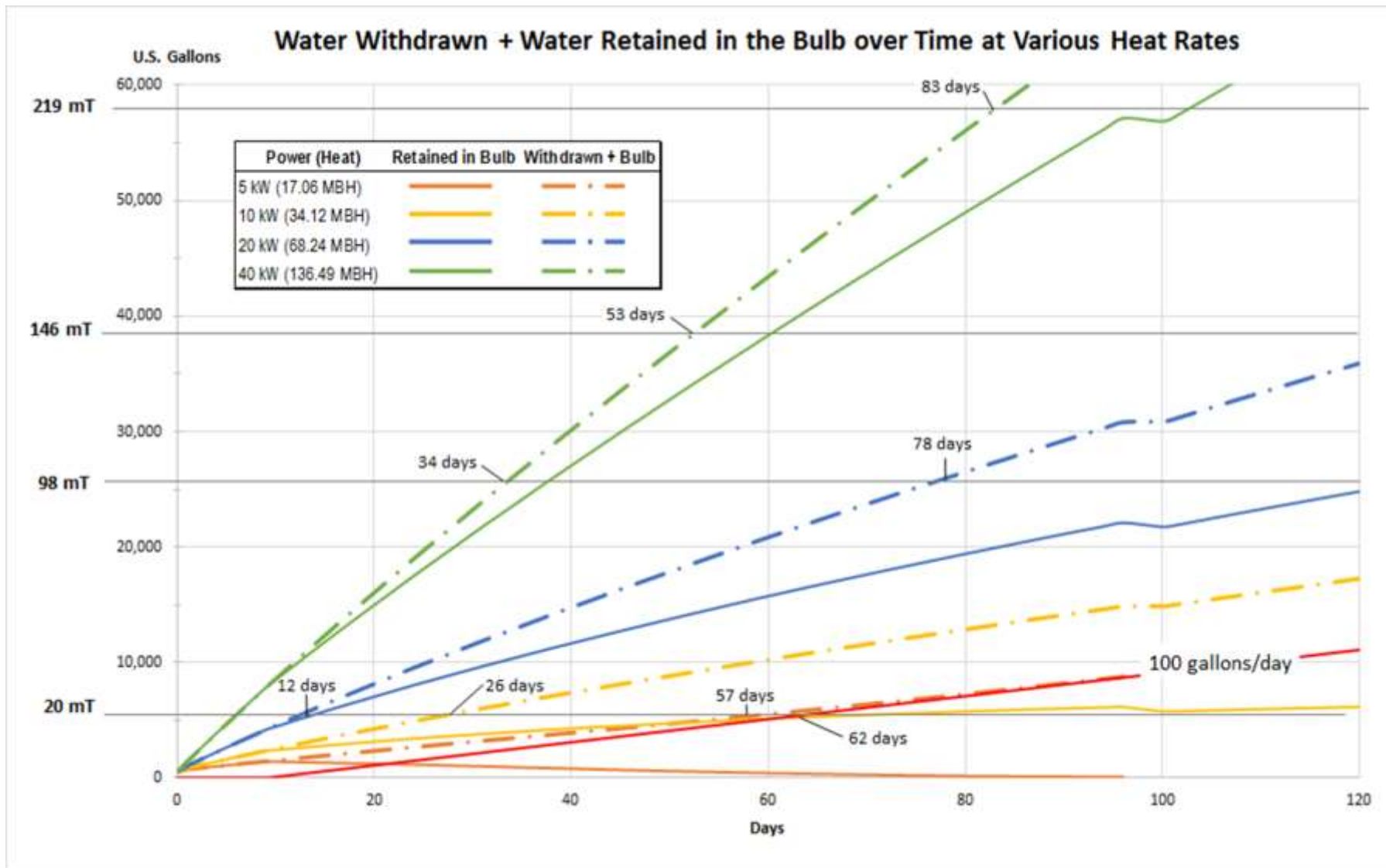

Note: assumes -80° C ice

# Observations from the 100 gal/day Withdrawal Case



- **The power values on the previous two charts are ONLY for melting ice and maintaining a liquid pool of water in the subsurface cavity; *additional power will be needed to pump water out of this cavity and to run other surface infrastructure elements.***
- **The withdrawal rate and input power are highly coupled**
  - A different withdrawal rate will result in a different shape to these results
- **For this 100 gal/day withdrawal rate**
  - For power levels above approximately 10 kW, liquid water is being created at a much faster rate than it is being withdrawn, resulting in very large subsurface water pools that will not be used
  - A power level of approximately 10 kW generates liquid water at about the rate at which it is being withdrawn
    - The water pool remains at approximately a constant volume
    - The water pool will gradually sink to lower levels, which will drive the amount of power needed to pump water from these deeper levels
  - For power levels below approximately 10 kW, water is being withdrawn faster than it is being melted and the well eventually “collapses”
    - At a power level of approximately 5 kW, the 20 mT projected need for a single crew could be withdrawn before the well “collapses” but little additional water would be made

# Impact of Power Input for a 100 gal/day Withdrawal Rate

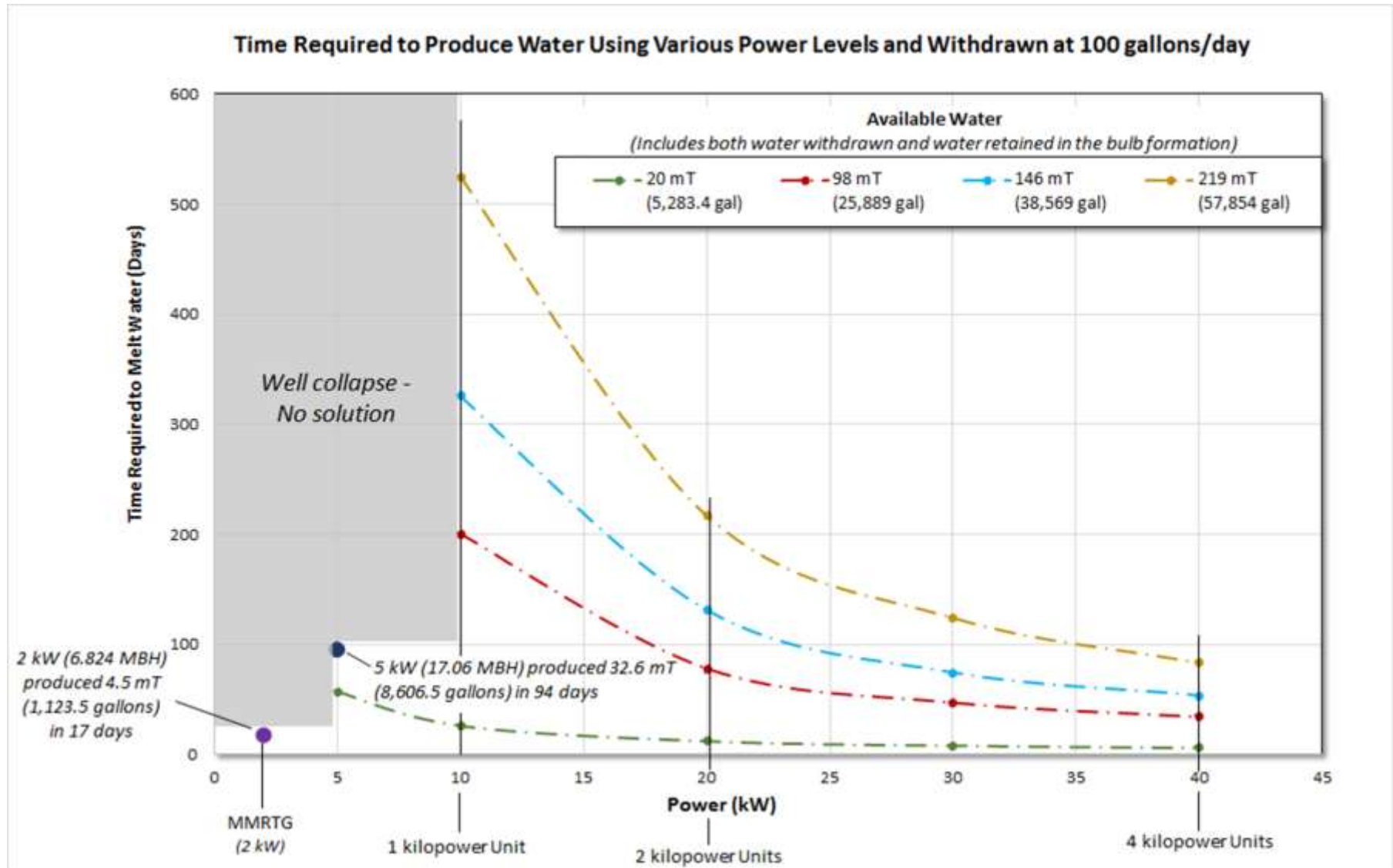

Note: assumes -80° C ice

# Impact of Power Input for a 500 gal/day Withdrawal Rate

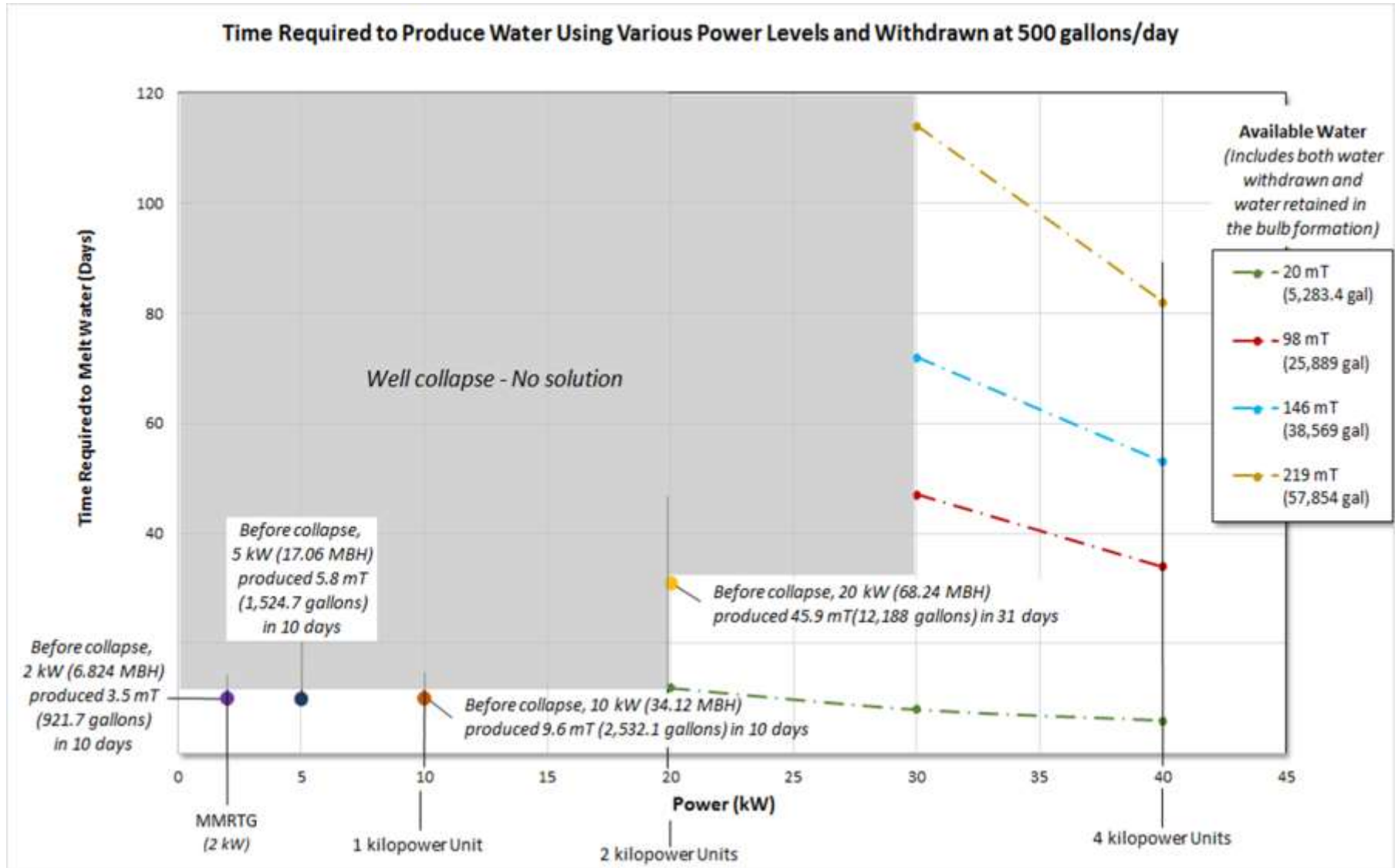

Note: assumes -80° C ice



# Impact of Power Input for a 50 gal/day Withdrawal Rate

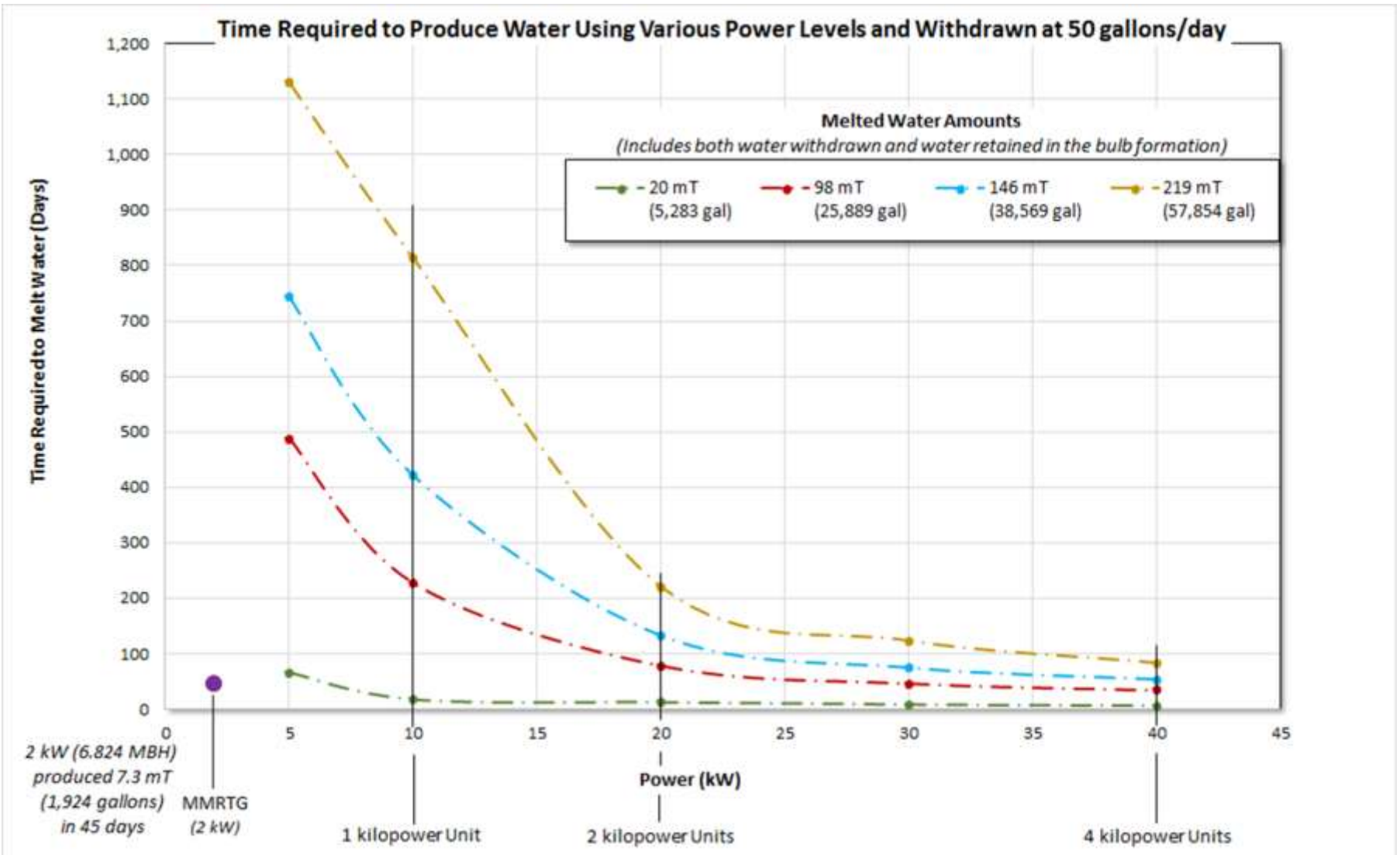

Note: assumes -80° C ice

# Impact of Power Input for a 15 gal/day Withdrawal Rate

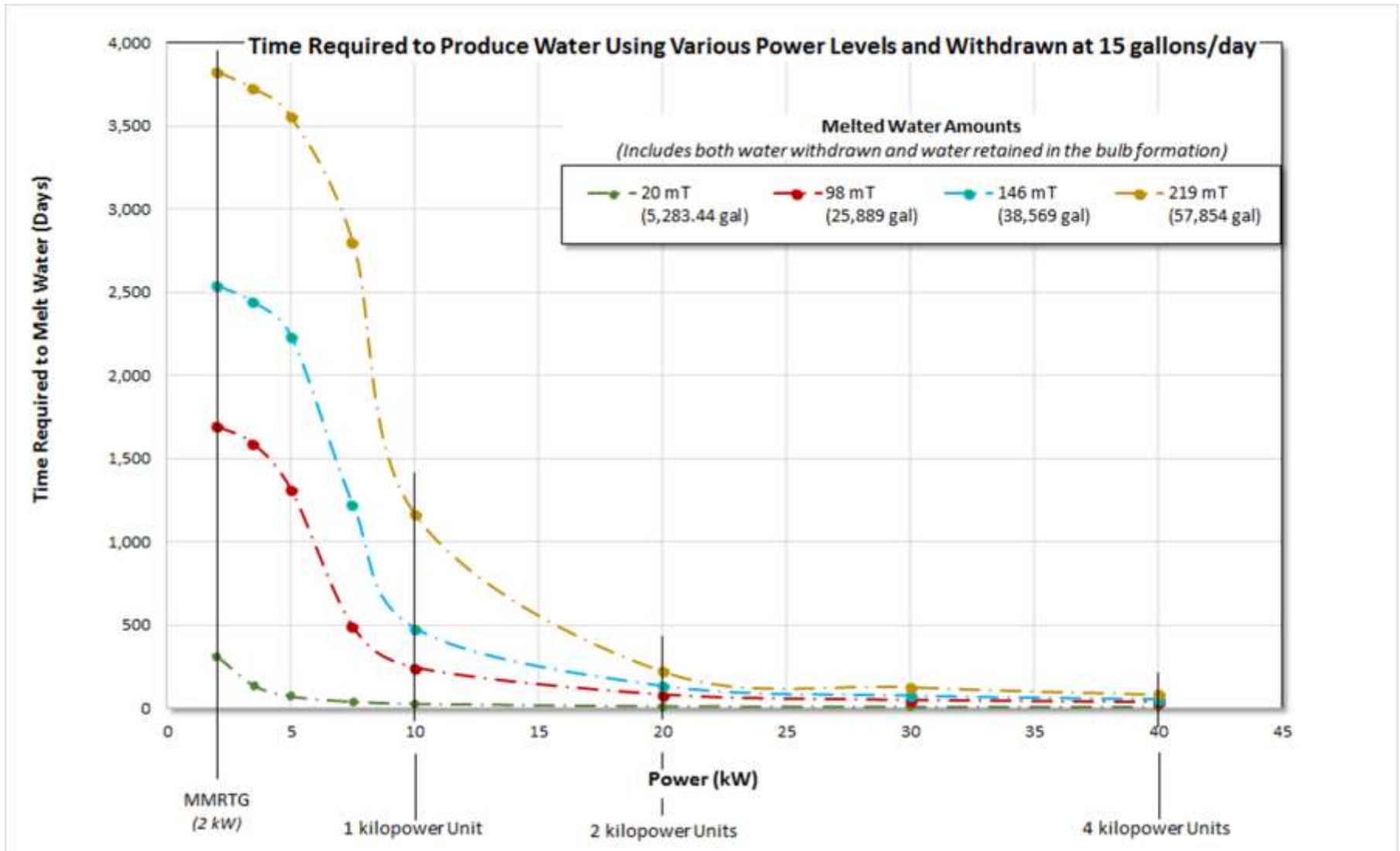

Note: assumes -80° C ice



Mining Water Ice on Mars

# CONCLUSIONS AND OBSERVATIONS

# Summary of Key Observations from this Assessment



- **Ice sources**
  - Broad subsurface layers
  - Localized remnant deposits
- **Technique to extract ice**
  - Remove debris layer and then remove ice (e.g., open pit mine)
  - Drill through debris layer and create a subsurface reservoir of liquid water
- **Multiple existing technologies identified to drill through debris and ice layers**
  - Mechanical drills for debris layer and ice
    - Small devices under development for robotic space missions
    - Wide variety of terrestrial devices in use (operational experience)
    - Device characteristics documented in several locations
  - Several technologies for drilling ice
    - Electro-thermal
    - Hot water
    - Hybrid
  - Terrestrial examples of these technologies are mature and commonly used in analogous polar operations
- **At least one existing technique – the Rodriguez Well – identified to melt and store water in large bodies of ice**
- **These technologies and techniques were used to assess an approach to address a gap in the initial M-WIP study to access and extract water from buried ice deposits**



- **There are still many unknowns regarding the quantity and distribution of ice sources at high latitudes**
- **This assessment focused on bodies of ice that would be typical of the Lobate Debris Apron (LDA) and Lineated Valley Fill (LVF) categories of glacier-like forms**
- **A better understanding of glacier-like forms on Mars is needed**
  - A general understanding of these Martian formations and how closely they compare to similar formations on Earth
  - Better resolution and characterization of the vertical profile of these formations
    - Thickness and particle size distribution of debris layer – this drives how much casing and drill string is needed
    - Vertical profile of the ice layer
      - Is there a firn layer?
      - Are there cracks, crevasses, or voids?
      - Temperature profile
  - Surveying capabilities (e.g., ground penetrating radar) to select the “best” site(s) to establish this type of water well

# Known unknowns (continued)



- **Where and how to store water above ground – long term storage still a problem on ISS; e.g., chemicals leaching out of containers over time**
- **Casing diameter – to pump water out of well (flow rate) or physical size of (down hole) pump**
- **TBD other**

# Conceptual System and Notional Conops



- **Conduct a local site survey to identify the specific location for the Rodwell**
  - Identify the thinnest debris depth
  - Determine the firn layer depth (if any) and identify cracks, voids, etc.
- **Drill through the debris layer**
  - Use mechanical drill
  - Case the hole to prevent debris from collapsing into the hole and to allow some TBD pressurization of the reservoir
- **Drill into ice layer**
  - Drill down to a depth sufficient for ice to support the overlying debris layer and bypass any firn, cracks, voids, etc.
  - Several technology options exist for this step; further evaluation/tests are needed to select “best” option
    - Mechanical, electro-thermal, hot water, hybrid
- **Melt ice and store water in subsurface reservoir**
  - Power needed to melt ice and water extraction rate are coupled and both are tied to the specific use scenario
- **Options exist to cease operations between crews or to keep Rodwell in continuous operation**
  - Dependent on surface mission scenario and overall campaign – future work required
- **Option to store water above ground or use the Rodwell reservoir for storage**
  - Future work required



Mining Water Ice on Mars

# RECOMMENDATIONS AND FUTURE WORK



# Recommendations for Future Work



- **Is a Rodwell the best approach to extracting water for a periodic, but extended duration, Mars surface mission? What are the alternatives? What factors tip the “best” approach to one solution or another? Include minimizing surface infrastructure as one of these factors.**
- **What combination of mechanical, thermal, and hot water drilling is (most likely) needed to establish the access shaft for a Rodwell or other water melting/extraction approach given the likely vertical profile associated with glacier-like features on Mars?**
- **Can a thermal input as low as 2 kW be used to establish a Rodwell? If a 2 kW heat source is all the thermal energy available, what is the best approach to melt and extract subsurface water (power for pumping water is separate)? Ditto for a 10 kW heat source.**
- **What thickness of ice is needed to support an overlying layer of debris that could be somewhere between 0.5 m and 10 m thick. Include reduced “weight” due to lower Mars gravity. Assume a roughly spherical dome shape to the cavity below the ice-supported debris layer.**

# Recommendations for Future Work (continued)



- **What testing could/should be done to verify any of the analytical results associated with this concept? For -80C ice? For a debris-covered ice sheet?**
- **What remote sensed data is most useful or needed for site selection? What on-site data is needed for site selection?**
- **The location for extracting water is unlikely to be co-located with the habitat and/or MAV. So what are the options for moving the extracted water (e.g., keep it liquid? Let it freeze before moving?) and general logistics associated with this aspect of “mining” water.**
- **This analysis indicates that use of terrestrial ice drilling and Rodriguez Well techniques to generate a source of liquid water from presumptive Martian glaciers has promise for an operational system at Mars. However, the heat input available and water withdrawal rates for a representative Mars surface mission are small compared to most terrestrial experience. Tests using a functional prototype of such an operational system could provide useful data to validate or refute the analytical results.**



Mining Water Ice on Mars

# REFERENCES

# References listed in alphabetical order



- Dickson, J. L., J. W. Head, and C. I. Fassett (2012) Patterns of accumulation and flow of ice in the mid-latitudes of Mars during the Amazonian, *Icarus* 219: 723–732, 2012.
- Dundas, C. M., S. Byrne, A. S. McEwen, M. T. Mellon, M. R. Kennedy, I. J. Daubar, and L. Saper (2014), HiRISE observations of new impact craters exposing Martian ground ice, *J. Geophys. Res. Planets*, 119, 109–127, doi:10.1002/2013JE004482.
- Haehnel, R. B., and M. A. Knuth (2010) “Potable water supply feasibility study for Summit Station, Greenland,” unpublished CRREL report, August 2010.
- Head, J. and D. Marchant (2006) Evidence for global-scale northern mid-latitude glaciation in the Amazonian period of Mars: Debris-covered glacial and valley glacial deposits in the 30 - 50 N latitude band, *Lunar. Planet. Sci.* 37. Abstract 1127.
- Holt et al, (2007) – see Holt, J., A. Safaeinili, J. Plaut, J. Head, R. Phillips, R. Seu, S. Kempf, P. Choudhary, D. Young, N. Putzig, D. Biccari, Y. Gim (2008) Radar sounding evidence for buried glaciers in the southern mid-latitudes of Mars. *Science* 322. doi:10.1126/science.1164246.
- Karlsson, N. B., L. S. Schmit, and C. S. Hvidberg (2015) Volume of Martian midlatitude glaciers from radar observations and ice flow modeling, *Geophysical Research Letters*, Volume 42, Issue 8, 28 April 2015, pages 2627–2633
- Lunardini, V. J. and J. Rand (1995), Thermal Design of an Antarctic Water Well, CRREL Special Report 95-10.

# References listed in alphabetical order (continued)



- **Makinson, K., D. Pearce, D. A. Hodgson, M. J. Bentley, A. M. Smith, M. Tranter, M. Rose, N. Ross, M. Mowlem, J. Parnell, M. J. Siegert (2015) “Clean subglacial access: prospects for future deep hot-water drilling”, Phil. Trans. R. Soc. A 2016 374 20140304; doi: 10.1098/rsta.2014.0304. Published 14 December 2015.**
- **Rucker, M.A., Integrated Surface Power Strategy for Mars, Paper 5074, Nuclear and Emerging Technologies for Space (NETS) 2015, Albuquerque, 2015.**
  - Proceedings of NETS 2015 (page 214-223) <http://anstd.ans.org/wp-content/uploads/2015/07/Proceedings-of-NETS-2015.pdf>
  - NASA reports server: <https://ntrs.nasa.gov/search.jsp?R=20150000526>
- **Rucker, M.A., et al., Solar Versus Fission Surface Power for Mars, AIAA 2016-5452, AIAA SPACE 2016, Pasadena, 2016**
  - AIAA website: <http://arc.aiaa.org/doi/abs/10.2514/6.2016-5452>
  - NASA reports server: <https://ntrs.nasa.gov/search.jsp?R=20160002628>
- **Plaut, J., A. Safaeinili,, J. Holt, R. Phillips, J. Head, J., R. Seu, N. Putzig, A. Frigeri (2008) Radar Evidence for Ice in Lobate Debris Aprons in the Mid-Northern Latitudes of Mars. Lunar and Planetary Science XXXIX. 2290.pdf.**
- **Plaut, J., A. Safaeinili,, J. Holt, R. Phillips, J. Head, J., R. Seu, N. Putzig, A. Frigeri (2009) “Radar evidence for ice in lobate debris aprons in the mid-northern latitudes of Mars,” Geophysical Research Letters, Vol. 36, L02203, doi:10.1029/2008GL036379.**

# References listed in alphabetical order (concluded)



- Rummel, J.D., D.W. Beaty, M.A. Jones, C. Bakermans, N.G. Barlow, P.J. Boston, V.F. Chevrier, B.C. Clark, J.P.P. de Vera, R.V. Gough, J.E. Hallsworth, J.W. Head, V. J. Hipkin, T.L. Kieft, A.S. McEwen, M.T. Mellon, J.A. Mikucki, W.L. Nicholson, C.R. Omelon, R. Peterson, E.E. Roden, B. Sherwood Lollar, K.L. Tanaka, D. Viola, and J.J. Wray (2014) A New Analysis of Mars “Special Regions”: Findings of the Second MEPAG Special Regions Science Analysis Group (SR-SAG2), *Astrobiology*, 14 (11): 887-968, 2014.



Mining Water Ice on Mars

# APPENDIX

# Other Options Considered and Ruled Out: Extraction of Water from the Atmosphere



## Some general facts and calculations:

1. At Mars surface pressure = ~6 mbar; atm density averages ~0.020 kg/m<sup>3</sup>, water ~210 ppm = 0.0042 g(water)/m<sup>3</sup>
2. 1 kg water is contained in 250,000 m<sup>3</sup> of atmosphere
3. To produce 5 mt water per yr, 0.57 kg would have to be produced per hour, which means 2400 m<sup>3</sup> (~1 Olympic sized swimming pool) of atmosphere would have to be handled per minute, assuming 100% recovery. This is equivalent to 84,000 CFM.
4. Martian atmosphere is at 1% of the pressure of the inlet pressure for compressors on Earth, thus an additional compression factor of 10<sup>2</sup> would have to be applied to get the same throughput.

- We have not seen a credible method proposed for separating the water from an airstream of this scale, so we cannot estimate recovery efficiency.
- The air-handling system implied by these calculations would be on the same order of magnitude as the largest air compressors known on Earth: ~600,000 CFM, requiring 65 megawatts to run, and roughly 5x5x10m in size.

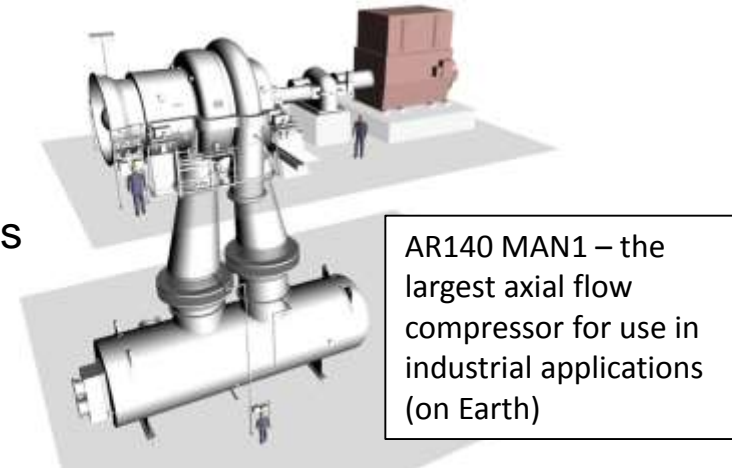

**CONCLUSION:** The mass, power, volume, and mechanical complexity of the system needed for this approach are far outside of what is practical for deployment to Mars.



# Possibility of Near-surface water



## 1) RSL (observed features):

- Recurring slope lineae (RSL) are narrow (0.5-5 m), abundant (>10), recurring dark markings on steep slopes (>25°).
- Concentrated in 30-50°S, favoring equator (sun)-facing slopes. Also found in Valles Marineris on sun-facing slopes.
- Form and incrementally grow in late spring to summer, then fade or disappear in fall.
- Recur at ~same locations.
- RSL active in seasons when peak surface temperatures may get above freezing of brine solutions.
- *We don't know yet how RSL form. May involve brines.*

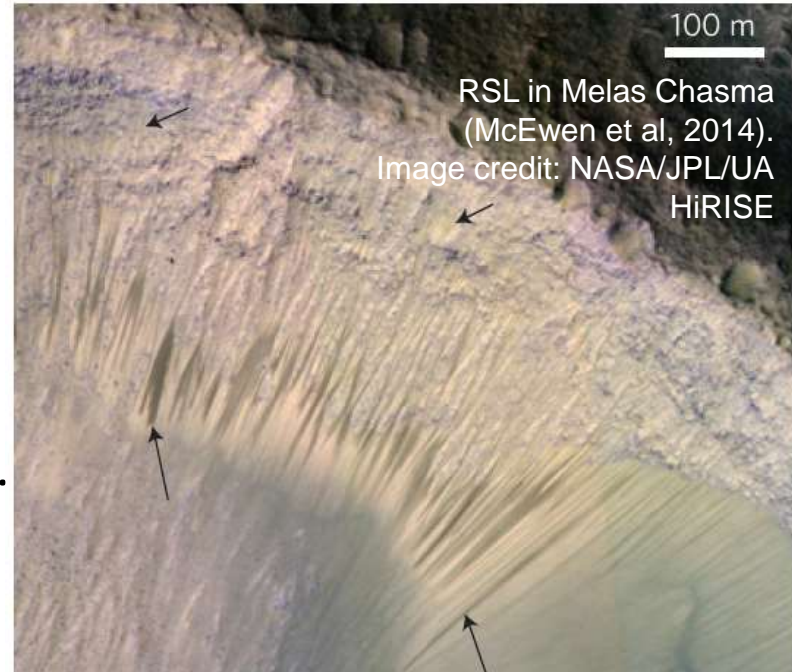

## 2) Possible water-stable environment near equator:

- Conditions in Gale could allow transient, *very small* amounts of *very briny* water at night.
- Not yet connected to any observable features. (Martín-Torres et al., 2015)

# Deep Groundwater – Outflow Channels



- **Their presence implies that Mars' deep crust contains water.**
- Direct detection has not been possible (next slides).
- The depth of this water source remains an open question.
  
- Outflow channels on Mars have occurred throughout its geologic history (up to ~2 Ma).
- The triggering mechanism for outflows is unknown.



Athabasca Valles streamlined islands, as seen by HiRISE. (9.4 N, 156.3 E). Image credit: NASA/JPL/UA.

# Groundwater – Attempts to Detect



- MARSIS and SHARAD (radars) would be able to detect Mars groundwater (liquid water or brine in Mars bedrock).
- No such groundwater has been detected (to the depths cited).

	MARSIS	SHARAD
Coverage	~80%	~40%
Spatial res.	~10 km	~3 km
Depth res.	~100 m	~10 m
Max depth	~1 km	~ 300 m

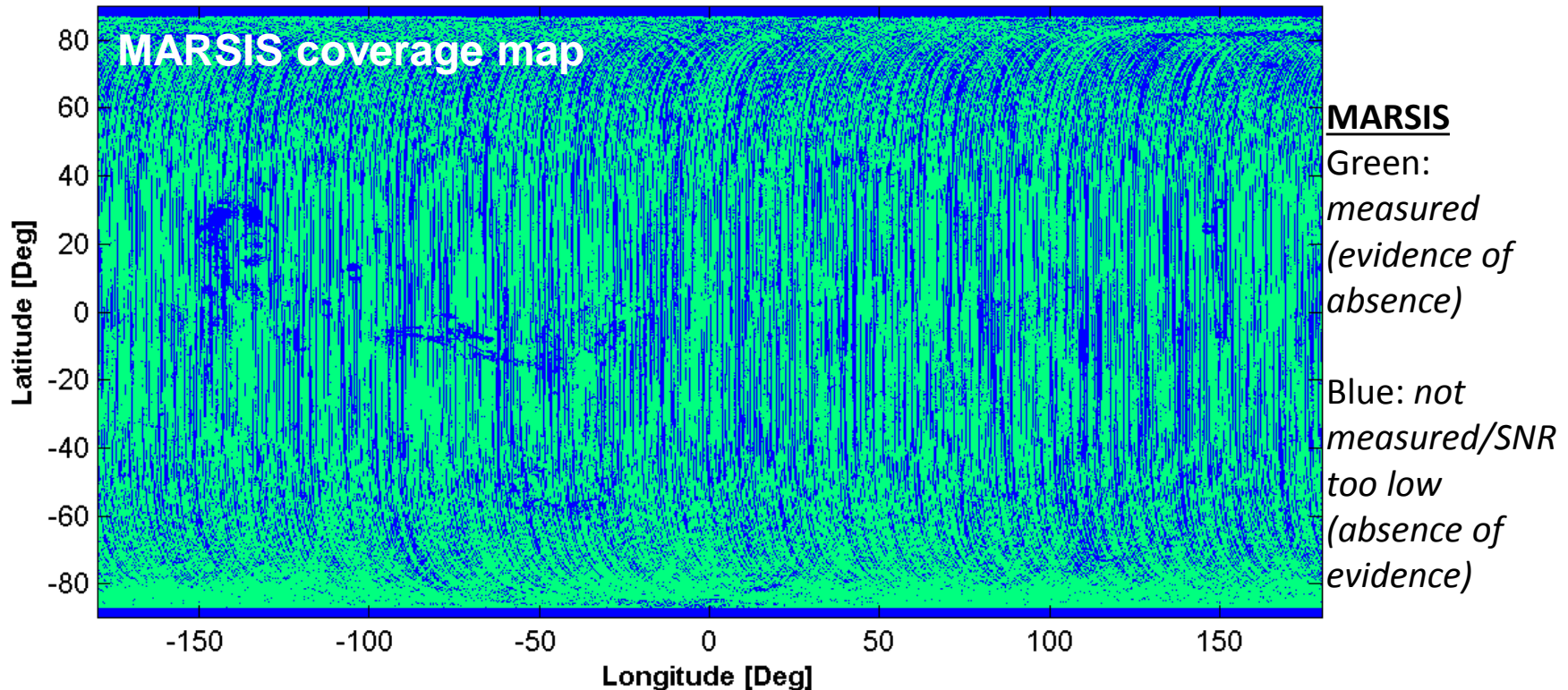

# No Near-surface Groundwater



- So far NO signs of groundwater has been detected with these instruments  
→ unlikely that there is groundwater at a depth shallower than ~200-300 m anywhere on the planet.

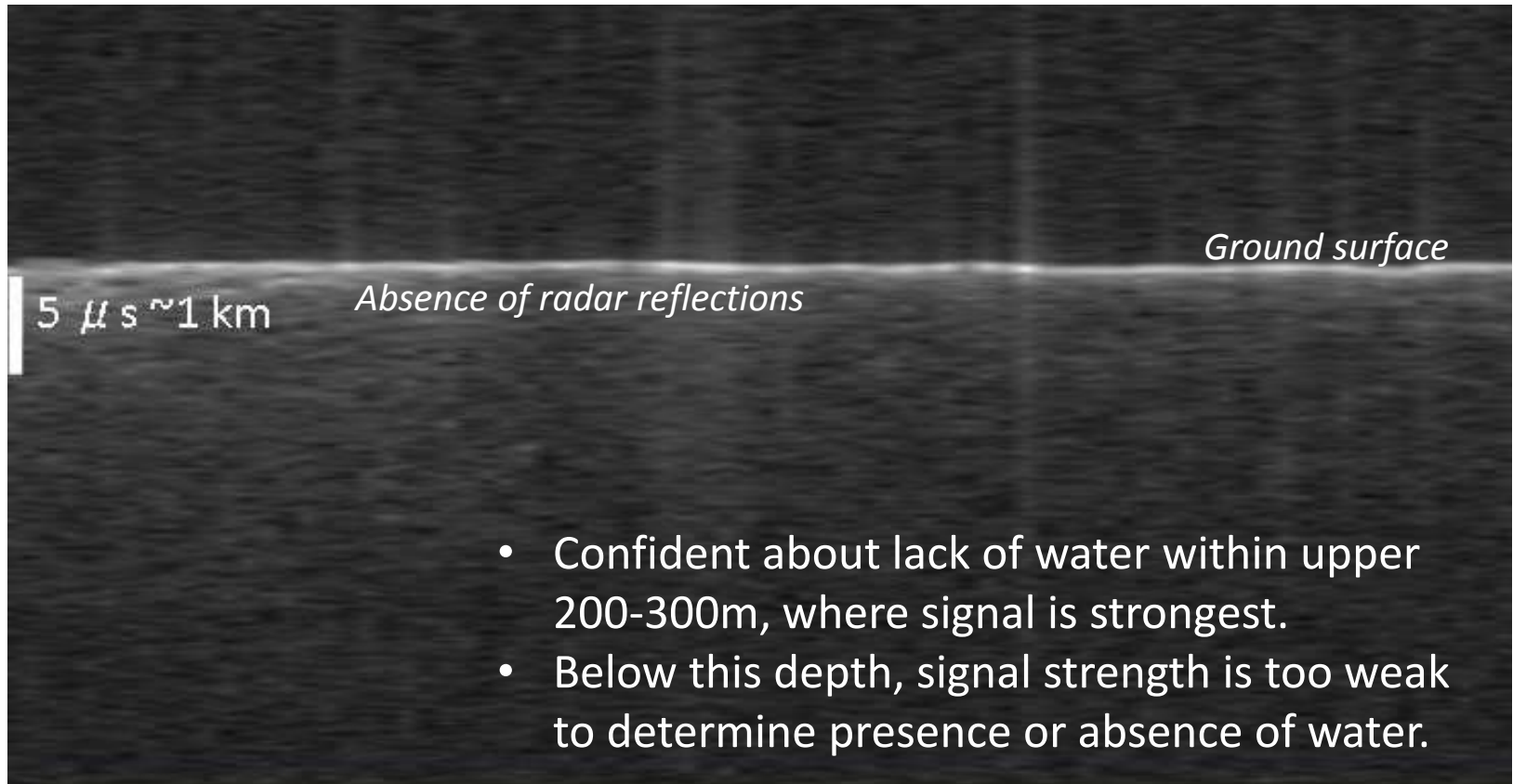

- Confident about lack of water within upper 200-300m, where signal is strongest.
- Below this depth, signal strength is too weak to determine presence or absence of water.

MARSIS 5-MHz, Radargram of Athabasca (4-7N, 149E). Image credit: ASI/NASA

# Measurements of the Depth to Tropical and Mid-Latitude Ice Deposits



- Based on the transition-size of the shapes of craters:
  - Larger, distinctive “Ring-Mold Craters”, which owe their shape to penetration through the sublimation lag into buried ice
  - Versus small, bowl-shaped craters that penetrate only into the overlying sublimation lag.
- Depth to the ice is >5m.
- **Where subsurface ice is detected in areas with Ring-Mold Craters**, the lower boundary of the sublimation lag is not detected by SHARAD radar instruments.
- Where there is ice, depth to the top of an icy layer is <15m.

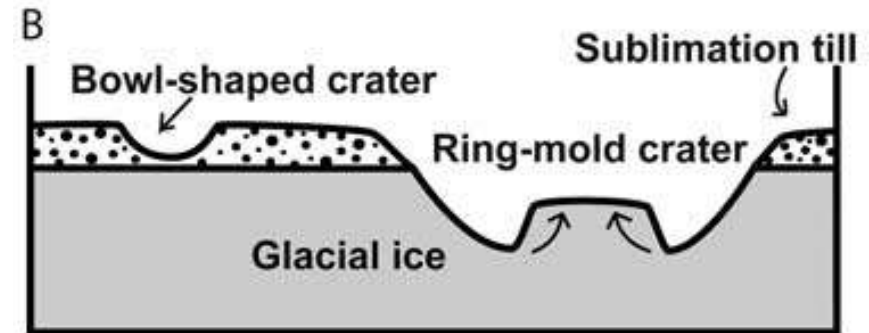
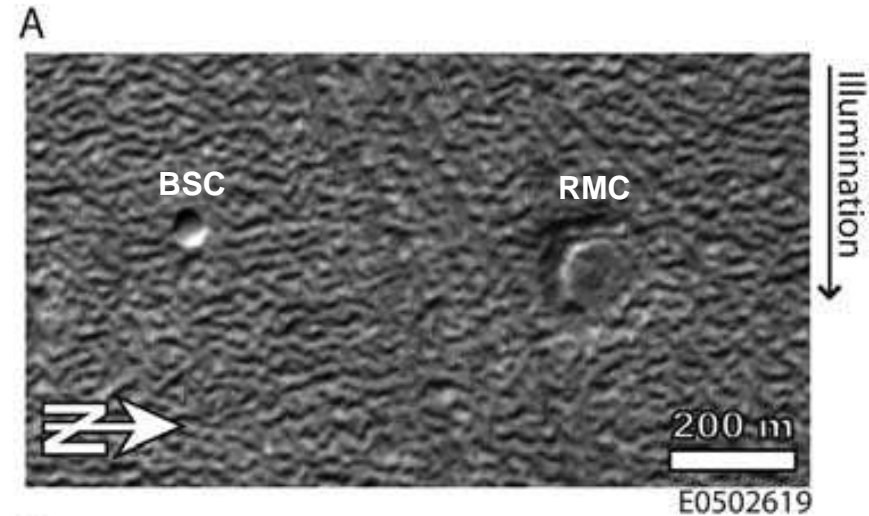

Detecting Buried Ice:

(A) Bowl-Shaped Crater (BSC) and Ring-Mold Crater (RMC);  
(B) Cross-section showing interpreted relations to buried ice

Image from (Kress and Head, 2008)

# Data

Withdrawal Rate: 15 gal/day								
Time Required to Melt Water (Days)								
Power (kW) (Heat)		2 (6.824 MBH)	3.5 (11.942497 MBH)	5 (17.060 MBH)	7.5 (25.591065 MBH)	10 (34.121 MBH)	20 (68.24284 MBH)	40 (136.486 MBH)
Water Produced (Water withdrawn + water stored in bulb)	20 mT (5,283.44 gal)	312	135	70	39	27	12	6
	98 mT (25,889 gal)	1,695	1,586	1,312	486	243	79	34
	103.3 mT (27,289 gal)	1,789	1,680	1,417	556	269	84	36
	146 mT (38,569 gal)	2,541	2,439	2,237	1,221	480	133	53
	219 mT (57,854 gal)	3,828	3,725	3,556	2,800	1,165	221	83
Withdrawal Rate: 50 gal/day								
Water Produced (Water withdrawn + water stored in bulb)	7.3 mT (1,924 gal)	45						
	20 mT (5,283 gal)			65		17	12	6
	98 mT (25,889 gal)			487		227	78	34
	103.3 mT (27,289 gal)			518		245	84	36
	146 mT (38,569 gal)			743		421	132	53
	219 mT (57,854 gal)			1,130		813	220	83
Withdrawal Rate: 100 gal/day								
Water Produced (Water withdrawn + water stored in bulb)	4.5 mT (1,123.5 gal)	17						
	20 mT (5,283.4 gal)			57		26	12	6
	32.6 mT (8,606.5 gal)			94				
	98 mT (25,889 gal)					200	78	34
	103.3 mT (27,289 gal)					212	83	36
	146 mT (38,569 gal)					326	131	53
	219 mT (57,854 gal)					525	217	83