



Human Exploration and Operations Mission Directorate

Budget Status for NASA Advisory Council Human Exploration and Operations Committee

Toni Mumford
Director, HEO Resources Management Office

March 3, 2016



Human Exploration and Operations

Agenda

- FY 2017 Budget Overview
- Journey to Mars – Sustainable Exploration Strategy
- Program
 - International Space Station
 - Space Transportation
 - Crew and Cargo Program
 - Commercial Crew Program
 - Exploration Systems Development
 - Exploration Research and Development
 - Human Research Program
 - Advanced Exploration Systems
 - Asteroid Redirect Mission
 - Space Flight Support
 - Space Communications and Navigation
 - Rocket Propulsion Test
 - Launch Services Program
 - Human Space Flight Operations
 - 21st Century Space Launch Complex



Human Exploration and Operations

Budget Overview

- FY 2017 budget submit provides \$8.4 billion (\$8.2 billion discretionary and \$0.2 billion mandatory) for Human Exploration and Operations (HEO) to pursue NASA goals, consistent with NASA Authorization Act of 2010
 - Sustain the capability for long duration presence in low Earth orbit (LEO)
 - Expand permanent human presence beyond LEO
 - Enable missions to deep space destinations such as cis-lunar space, near-Earth asteroids and Mars
 - Provide critical communication, navigation, launch, propulsion test, and other services to NASA, HEO missions, and other external customers
- Develops next generation launch vehicle, crew vehicle, and associated ground systems necessary to extend human presence beyond LEO (Orion, Space Launch System (SLS) and Exploration Ground Systems (EGS))
- Advances capabilities required to conduct a sustainable campaign of more complex exploration missions in cis-lunar space on the Journey to Mars
 - Research human health and performance so crew can travel safely beyond LEO
 - Develop and test technological capabilities needed for long duration missions (i.e. habitat system concepts)
 - Continues formulation of the Asteroid Redirect Robotic Mission (ARRM)



Human Exploration and Operations

Budget Overview (continued)

- Establishes a new theme in Space Operations, Space Transportation, which includes Crew and Cargo and Commercial Crew Programs
- Purchases reliable cargo resupply services from U.S. private sector companies
- Develops U.S. commercial crew capability to ISS by the end of 2017, ending sole reliance on Russia for U.S. crew access to space
- Utilizes International Space Station (ISS) as a research and technology test platform through at least 2024
 - Provide advanced human systems research and technology to enable safe, reliable, and productive human exploration beyond LEO required for Journey to Mars
 - Enable National Laboratory for commercial research and other government agencies
- Provides mission-critical enabling capabilities for HEO, other NASA, and other U.S. Government missions
 - Deliver space communications and navigation services necessary for success of NASA science and human missions and U.S. Government and commercial customer missions
 - Provide affordable and reliable launch access to space for NASA and civil sector missions
 - Continue crew training and operations, crew health and safety, and propulsion test activities required for successful U.S. crewed space missions



Human Exploration and Operations

Program Financial Plan

<i>Budget Authority (\$ in Millions)</i>	Actual	Enacted	Request	Notional			
	FY 2015	FY 2016	FY 2017	FY 2018	FY 2019	FY 2020	FY 2021
Human Exploration and Operations	8,168	9,059	8,413	8,443	8,611	8,784	8,959
Exploration	3,543	4,030	3,337	3,530	4,082	4,244	4,262
Exploration Systems Development	3,212	3,680	2,860	2,923	3,062	3,092	3,142
Orion	1,190	1,270	1,120	1,120	1,124	1,135	1,153
Space Launch System	1,679	2,000	1,310	1,361	1,485	1,500	1,524
Exploration Ground Systems	343	410	429	441	453	458	465
Exploration Research and Development	331	350	477	607	1,020	1,151	1,119
Human Research Program	142	-	153	178	178	180	183
Advanced Exploration Systems	189	-	324	429	842	971	937
Space Operations	4,626	5,029	5,076	4,913	4,530	4,540	4,698
Space Shuttle Program	8	-	-	-	-	-	-
Space Shuttle Program	8	-	-	-	-	-	-
International Space Station	1,525	-	1,431	1,555	1,537	1,539	1,585
ISS Systems Operations and Maintenance	1,113	-	1,109	1,246	1,196	1,193	1,233
ISS Research	412	-	322	309	340	347	353
Space Transportation	2,254	-	2,758	2,475	2,119	2,144	2,214
Commercial Crew	805	-	1,185	732	173	36	36
Crew and Cargo	1,449	-	1,573	1,743	1,946	2,109	2,178
Space and Flight Support	839	-	887	883	874	856	899
21st Century Space Launch Complex	35	-	12	-	-	-	-
Space Communications and Navigation	579	-	612	616	598	576	615
Human Space Flight Operations	100	-	128	130	140	142	144
Launch Services	81	-	87	89	89	90	91
Rocket Propulsion Test	44	-	48	48	48	48	49
Construction and Environmental Compliance	87	36	37	-	-	-	-
Exploration	68	10	9	-	-	-	-
Space Launch System	21	5	6	-	-	-	-
Exploration Ground Systems	47	5	3	-	-	-	-
Space Operations	19	26	29	-	-	-	-
International Space Station	-	6	-	-	-	-	-
21st Century Space Launch Complex	5	3	3	-	-	-	-
Space Communications and Navigation	14	18	24	-	-	-	-
Launch Services	1	-	1	-	-	-	-

FY 2015 reflects funding amounts specified in the September 2015 Operating Plan per Public Law 113-235.

FY 2016 reflects only funding amounts specified in Public Law 114-113, Consolidated Appropriations Act, 2016. FY 2016 funding levels are subject to change pending finalization of the FY 2016 Operating Plan.

FY 2017 includes \$173 million in mandatory funding (Orion \$66.4, SLS \$80.4 and EGS \$26.2).

Totals may not add due to rounding.



Human Exploration and Operations

International Space Station



Human Exploration and Operations

International Space Station:

FY 2016 – FY 2020 Operations and Maintenance Plans

- 24/7 mission operations, including spares purchases
- Examples of other activities planned for FY 2016 – FY 2020
 - Procure next generation laptops and peripheral hardware to support all necessary ISS Program Requirements for on-orbit and ground development
 - Complete Project 21's (Mission Control Center/Training Systems) Modernization which will lower lifecycle costs
 - Replace vehicle hardware (e.g., Environmental Control and Life Support System (ECLSS), regenerative ECLSS spares, Nitrogen/Oxygen Recharge System tank, etc.) lost on Orb-3 and SpX-7
 - Developed Li-Ion Batteries to replace current Nickel Hydrogen batteries which are near end of life; launch batteries on next four H-II Transfer Vehicles (HTV)
 - Developed and launched Nitrogen/Oxygen Recharge System to bring nitrogen and/or oxygen to the ISS, and certify Recharge Tank Assembly use for multiple flights
 - Continuing Extravehicular Activity (EVA) suit anomaly resolution and upgrade plans
 - Conduct trade study for development of External Pump Control and Valve Package to allow bypassing failed internal Pump Control and Valve Package components, without a pump module repair and replace; build four Pump Control and Valve Package controllers
 - Develop Multi-Platform Air Monitor
 - Increase Ku-band data throughput
 - Develop deployable carrier for external hardware and payloads



Human Exploration and Operations

International Space Station Research-BPS/CASIS/MUSS: FY 2016 Plans

Biological and Physical Sciences (BPS) Plans and Examples of NASA BPS Research on ISS

- Initiate first open science community-based experiments using Science Definition Teams
- Deliver Fruit Fly Lab 2 to study multiple generations of fruit flies to generate further insight into immune system research
- Established collaboration with Russians on rodent research experiments utilizing samples from ISS enabling use of Russian crew time to increase Space Life and Physical Sciences life science on orbit
- Conduct Packed Bed Reactor fluid physics research to examine and improve microgravity water recovery systems
- Launch Zero Boil-Off Tank experiment to further understand microgravity cryogenic storage and handling
- Complete design and deliver first NASA-produced sample cartridge assemblies hardware to enable Phase One of MaterialsLab
- Released first NASA Research Announcement for MaterialsLab and first Request for Information for GeneLab
- Continue Veggie cultivation and sampling on orbit
- Issue a joint solicitation with the National Science Foundation on Dusty Plasma, utilizing Plasma Krystal-4, an existing European Space Agency (ESA)/Roscosmos payload operating on ISS

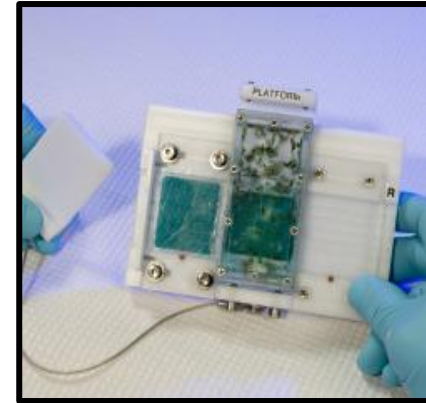

The fruit fly cassette that will house fruit flies and the food change-out platform

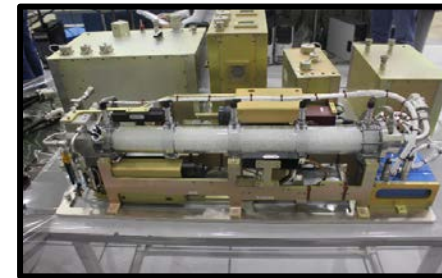

Packed Bed Reactor Flight System



Zinnias grown on Veggie



Human Exploration and Operations

International Space Station Research: BPS/CASIS/MUSS: FY 2016 Plans (continued)

National Laboratory (CASIS) Research Capabilities on ISS

- Space Automated Bioproduct Lab modular locker facility developed by BioServe provides automated, ground controlled environmental chamber (temperature, atmosphere, airflow) to conduct life sciences research onboard ISS
- Crystal Hotel, a NanoRacks facility in an Expedite the Processing of Experiments to Space Station (ExPRESS) locker, provides thermal controlled environment for protein crystallization investigations

Examples of CASIS commercial investigations

- *Milliken and Co.* - Combustion experiment for improving fire-resistant materials
- *Stanford; the Mayo Clinic* - Cardiac disease research using stem cells
- *Eli Lilly and Co.* - Multiple experiments across physical and biological sciences, all with human therapeutic relevance
- *UCLA* - Rodent research testing a drug that treats osteoporosis via multiple mechanisms (building bone as well as preventing bone loss)



Space Automated Bioproduct Lab is an incubator used to conduct cell culture and other biological experiments

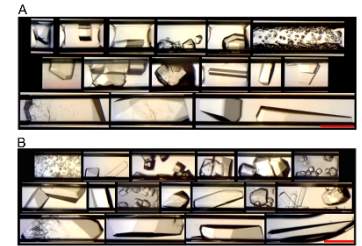

Protein crystals grown in microfluidics cards used in the Crystal Hotel



MUSES platform is designed to benefit the Earth sensing community



Human Exploration and Operations

International Space Station Research-BPS/CASIS/MUSS: FY 2016 Plans (continued)

National Laboratory (CASIS) Goals and Progress

- Continue to improve strategic direction – Increase awareness of the ISS NL value to potential users and the public; continue to maximize utilization
- Launch R&D for Earth benefit – Projects manifested include stem cell research, rodent models, materials science (for NREP), and enabling technologies to provide new ISS NL capabilities
- Approve additional subject-matter-expert reviewed projects – Diversification within key R&D areas to meet national needs: life and physical sciences, remote sensing, tech development
- Build reach in education – Create STEM programs, partnerships, and outreach initiatives using NL content, with goal to reach 180,000 U.S. students and educators in FY 2016
- Expand Sponsored Programs and cost sharing – Leverage external funding and increase commercial engagement with repeatable, customer-focused model
 - \$1.8M National Science Foundation solicitation issued in Q1 FY 2016 (*currently open*)
 - CASIS awards contributed 19% in seed funding toward total projected costs for FY 2015 newly selected projects (*for Q1 FY 2016, CASIS contribution = 22%*)
- Strongly align with NASA and other government agencies – Collaboration for R&D awards and opportunities
- Demonstrate meaningful results – Expect 12+ peer-reviewed publications across disciplines
- Orchestrate multi-institutional subject matter expert workshops – Collect input from thought leaders (*three completed in Q1 FY 2016*)



Human Exploration and Operations

International Space Station Research-BPS/CASIS/MUSS: FY 2016 Plans (continued)

Examples of NASA Earth Science Research on ISS

- Stratospheric Aerosol and Gas Experiment facility (SAGE-III) on ExPRESS Logistics Carrier (ELC)—record properties of Earth's ozone layer to better quantify long-term changes and impacts (SpX-10)

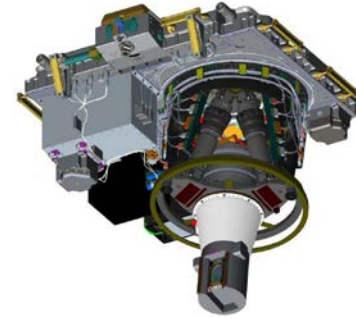

SAGE-III

Examples of NASA Astrophysics Research on ISS

- Alpha Magnetic Spectrometer (AMS) science operations continue, further investigating excess high-energy positron antimatter found among the cosmic-ray particles passing through the AMS and the potential implications for the existence of cosmic dark matter and/or other exotic astrophysical phenomenon such as nearby supernova remnant neutron stars

AMS on ISS

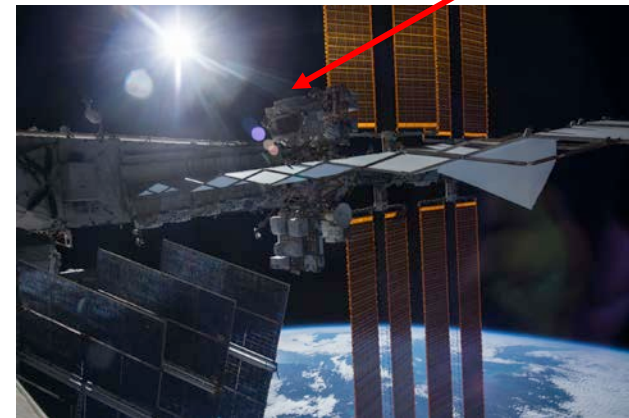



Human Exploration and Operations

International Space Station Research- BPS/CASIS/MUSS: FY 2016 Plans (continued)

New Technology Demonstration Capabilities on ISS

- Demonstrate inflatable module technologies with Bigelow Expandable Activity Module (BEAM)
- Monitor microbial, reactive silica and organics on-board ISS through Water Monitoring Suite
- Implement alternate urine pretreat formula to increase urine processing water recovery rate
- Evaluate life support sorbent capacity in Long Duration Sorbent Testbed
- Test wearable personal CO2 monitor
- Test flammability of different materials and behavior of large fires in low gravity on the Saffire Spacecraft Fire Safety Demonstration (SAFFIRE I, II, III in FY 2017)
- Fly water mist portable fire extinguisher for ISS, Orion and future vehicles
- Demonstrate Miniature Exercise Device
- Raven – Autonomous Rendezvous



BEAM

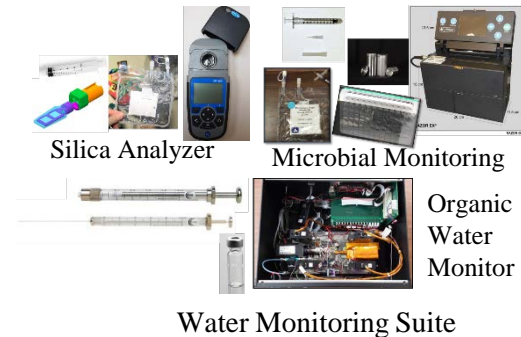



Human Exploration and Operations

International Space Station Research- BPS/CASIS/MUSS: FY 2017 Plans

BPS Plans and Examples of NASA BPS Research on ISS

- Enhance existing open science pipeline to study gravity as a continuum by utilizing ground based and on-orbit ISS research
- Initiate phase three of GeneLab which will allow research on multiple model organisms, such as worms, fruit flies and rodents
- Launch Rodent Research cooperative experiments with CASIS
- Complete Cold Atom Lab experiment hardware and launch to ISS in 2017
- Launch Advanced Plant Habitat – largest enclosed, environmentally controlled chamber designed to support commercial and fundamental plant research onboard ISS

Examples of NASA Space Science Research on ISS

- Neutron star Interior Composition ExploreR (NICER) on ELC (SpX-11)
- Cosmic Radiation Effects and Activation Monitor (CREAM) on JEM-EF: Measure energy spectra from 1012 to >1015 eV over the elemental range from protons to iron to understand cosmic ray origin (SpX-12)

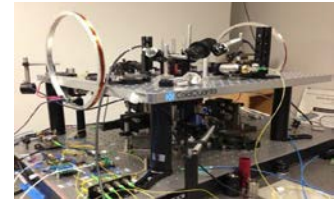

Cold Atom Laboratory

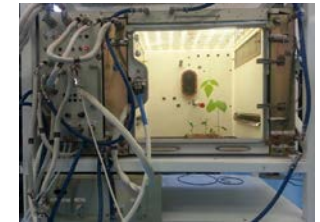

Advanced Plant Habitat

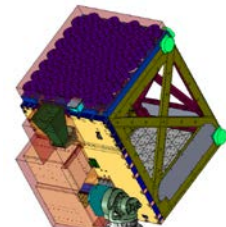

NICER

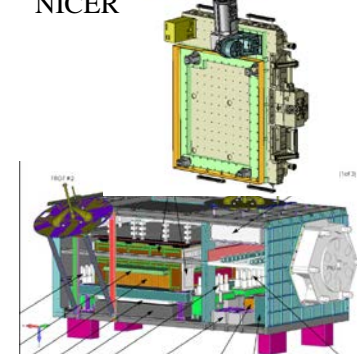

CREAM



Human Exploration and Operations

International Space Station Research- BPS/CASIS/MUSS: FY 2017 Plans (continued)

National Laboratory (CASIS) Research Capabilities

- Multi-User System for Earth Sensing (MUSES)
 - External precision pointing platform developed by Teledyne Brown Engineering; accommodates up to four plug-and-play hosted instruments at a time
- Materials for ISS Experiment (MISSE)
 - Facility is being developed by Alpha Space Test and Research Alliance, will be a permanent external platform on ISS that is robotically serviceable, enabling passive and active materials investigations
- BioChip Spacelab
 - Developed by Nanopoint, will be a modular locker facility that provides an ultra-portable, remote-controlled, automated microfluidics platform for general biological investigations and planned stem cell research

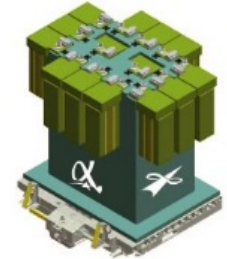

The MISSE platform will enable materials testing and data collection



BioChip will provide real-time imaging of biological investigations

Examples of CASIS commercial investigations

- FY 2017 research portfolio for National Lab investigators is still under development



Human Exploration and Operations

International Space Station Research-BPS/CASIS/MUSS: FY 2017 Plans (continued)

New Technology Demonstration Capabilities

- Space Debris Sensor - direct measure of orbital debris
- Phase Change Material Heat Exchanger for Orion and future exploration vehicles
- RFID Logistics Awareness - Autonomous logistics management
- RED-Data2 - measurement system to characterize the entry environment for Orion
- Roll-Out Solar Array - demonstrate an advanced, lightweight, solar array technology
- Life Support demonstration of water recovery from urine brine - additional water loop closure



Phase Change Heat exchanger

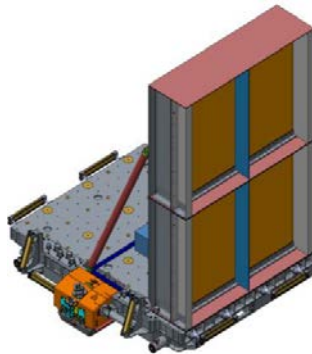

Space Debris Sensor

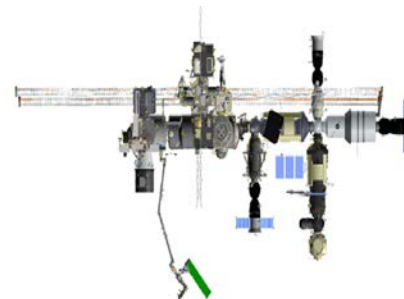

Roll out solar Array Demo

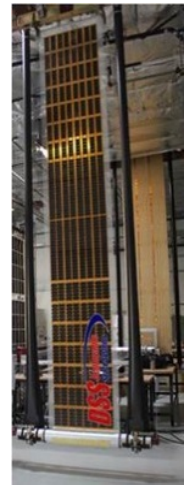



Human Exploration and Operations

Space Transportation Theme

Crew and Cargo Program
Commercial Crew Program



Human Exploration and Operations

Crew and Cargo Program: FY 2016 – FY 2017 Plans

- FY 2016 Plans

- Awarded three CRS-2 contracts in January 2016
 - Orbital ATK, Sierra Nevada, and SpaceX with minimum of six flights per provider with flights beginning in 2019
- Launch six CRS missions: SpX-8 through SpX-10 and OA-4 through OA-6
- Rebuild lost International Docking Adapter (IDA)-1 and IDA-1 control panel
- Install IDA-2 docking ports for commercial crew vehicles
- Crew transportation for six astronauts via Soyuz

- FY 2017 Plans

- Launch five CRS missions: SpX-11 through SpX-13 and OA-7 through OA-8
- Complete rebuild of lost IDA-1 (now known as IDA-3) and launch to ISS in FY 2018
- Crew transportation for six astronauts via Soyuz



Human Exploration and Operations

Commercial Crew Program: FY 2016 and FY 2017 Plans

- Partners will continue to mature capabilities toward securing U.S. crew transportation capability to LEO, including ISS by end of 2017
- Work with partners to complete FY 2016 milestones
 - Boeing plans to complete eight development milestones; provided ATP on second Boeing PCM (funded by Crew and Cargo Program)
 - Completed Structural Test Article Readiness Review (Part 1); Qualification Test Vehicle Integrated Readiness Review; and Flight Software Demonstration Nominal Launch, Docking and De-Orbit milestones
 - SpaceX plans to complete twelve development milestones
 - Completed Initial Propulsion Module Testing Complete; Critical Design Review (CDR); Delta CDR; Docking System Qualification Complete; Propulsive Descent Test Complete; and Launch Site Operational Readiness Review milestones
- Work with Partners to complete FY 2017 milestones, including three key certification milestones: ISS Design Certification Review, Flight Test Readiness Review, and Operations Readiness Review
- Additional Post Certification Missions are expected to be authorized, at a nominal pace of two per year funded by ISS



Human Exploration and Operations

Exploration Systems Development

Orion
Space Launch System
Exploration Ground Systems



Human Exploration and Operations

Exploration System Development: ABC vs. PBR

<u>R/Y \$ in M (R&D and CoF)</u>	President's	ABC
	Budget	
	<u>FY 2017</u>	<u>FY 2017</u>
Orion (EM-1/EM-2)	1,109.3	1,109.3
Space Launch System (EM-1)	1,268.6	1,268.6
<u>Exploration Ground Systems (EM-1)</u>	<u>417.1</u>	<u>417.1</u>
Total Development	2,795.0	2,795.0
Program Integration and Support	73.3	
Total Exploration Systems Development	2,868.3	

- FY 2017 President's Budget includes both discretionary and mandatory funding to meet Agency Baseline Commitment (ABC) for all three programs
 - Allows SLS and EGS to meet EM-1 ABC date of November 2018
 - Allows Orion to continue work toward meeting EM-2 ABC date of April 2023
- SLS and EGS launch readiness dates for EM-2 will be included in response to appropriation reporting requirement
- Does not provide funding for Exploration Upper Stage (EUS) development



Human Exploration and Operations

Orion: FY 2016 Plans

- Completed Orion CDR, 1st Qtr
- Completed EM-1 crew module (CM) pressure vessel welding operations, 2nd Qtr
- Completed parachute development phase, 2nd Qtr
- Readied ESA portion of European structural test article for test, 2nd Qtr
- Shipped EM-1 CM pressure vessel to KSC, 2nd Qtr
- Conduct next round of ground test article water impact testing at Langley Research Center (LaRC), 2nd through 4th Qtr
- EM-1 orbital maneuvering system engine on dock at ESA, 3rd Qtr
- Complete ESA CDR, 3rd Qtr
- Complete EM-1 CM proof pressure test, 3rd Qtr
- Begin parachute qualification testing, 3rd and 4th Qtr
- Complete EM-1 CM propulsion proof and leak test, 4th Qtr



Human Exploration and Operations

Orion: FY 2017 Plans

- Continue parachute qualification testing (TBR)
- Deliver EM-1 ESM to KSC, 2nd Qtr
- Begin structural test article mate and testing, 2nd Qtr
- Install EM-1 heat shield, 3rd Qtr
- Mate EM-1 CM and ESM, 3rd Qtr
- Start EM-2 manufacturing of CM pressure vessel 3rd Qtr
- Deliver EM-1 LAS to KSC, 4th Qtr
- Deliver EM-1 flight article to Plum Brook for integrated testing, 4th Qtr
- Complete EM-2 Delta CDR, 4th Qtr



Human Exploration and Operations

Space Launch System: FY 2016 Plans

Core Stage	Complete fabrication of LH ₂ and LOX tank structural test articles
Core Stage	Completed turn over of Vertical (weld) Assembly Center tool for production welds on Qualification and Flight Hardware
Engines	Awarded RS-25 Production Restart Contract
Engines	Continue testing RS-25 engines
Booster	Conduct SLS 2 nd and final Qualification Motor-2 test at Orbital ATK
Booster	Began casting of EM-1 flight article motor segments
Adapters	Begin Orion Stage Adapter flight article weld
Adapters	Complete Launch Vehicle/Stage Adapter (LVSA) structural test article fabrication
ICPS	Delivered Interim Cryogenic Propulsion Stage (ICPS) structural test article
SEI	Provide flight software release 12; software integration test facility – qualification facility operational
Program	Closeout actions from critical design review



Vertical Assembly Center



Booster QM-2 Test Prep



RS-25 Engine Test



ICPS STA



Human Exploration and Operations

Space Launch System: FY 2017 Plans

Core Stage	Complete construction of Core Stage LOX and LH ₂ tank structural test stands and activate B2 test stand at SSC
Core Stage	Complete manufacturing of EM-1 Core Stage Flight Unit
Upper Stage	Conduct EUS Preliminary Design Review
Engines	Complete qualification testing of RS-25 Core Stage Engine controller design
Engines	Deliver EM-1 RS-25 Core Stage Engine Flight Controllers
Engines	Deliver four RS-25 Core Stage Engines to Michoud Assembly Facility (MAF) for integration into EM-1 flight article core stage
Boosters	Complete propellant casting of EM-1 Flight Motor segments
Boosters	Complete production of avionics line replacement units, linear shaped charge, and cables batteries, and aft-skirt for EM-1 flight article boosters
Boosters	Begin propellant casting of EM-2 Flight Motor segments
SPIE (Adapters)	Complete production of EM-1 LVSA and MSA
SE&I	Provide flight software releases 13 and 14 in support of core stage green run testing at SSC and EM-1 Flight



STA Test Stands at MSFC



B-2 Core Stage Test Stand



Booster Casting



Human Exploration and Operations

Exploration Ground Systems: Plans

2016

2017

2018

Out Years

CDR completed

EM-1 Launch and Recovery Operations

EM-2 Launch and Recovery Operations 2023

Program Progress



Completion of Pad 39B Flame Trench & Flame Deflector Construction



Completion of VAB Platforms and VAB/ML Integrated Verification & Validation



Completion of VAB/Pad/ML Integrated Verification & Validation



Science Mission Support



Multi Payload Processing Facility Operational Readiness



Pad B Catacomb Roof Reinforcement and LH2 In Line Liquid Gas Separator Contract award



Start of Integrated Vehicle



Start of Offline Operations



EES Notional Pad Slide Wire System



Human Exploration and Operations

Exploration Ground Systems: FY 2016 Plans

- Completed CDR Board to evaluate ground systems design integrity and ability to meet mission requirements
- Conclude ground support equipment installation for Mobile Launcher
- Conduct launch equipment test facility umbilical testing
- Complete crawler-transporter Jacking, Equalizing, and Leveling cylinder installation
- Complete adjustable high bay platform construction in Vehicle Assembly Building (VAB) to support SLS stacking and integration for EM-1
- Complete flame trench/flame deflector as well as modifications for infrastructure and propellant and gas systems in preparation for launch at Launch Complex 39B
- Begin integrated testing from Firing Room 1 of software applications and displays for Orion ground processing in the Multi-Purpose Processing Facility
- Awarded all major support contracts for software development

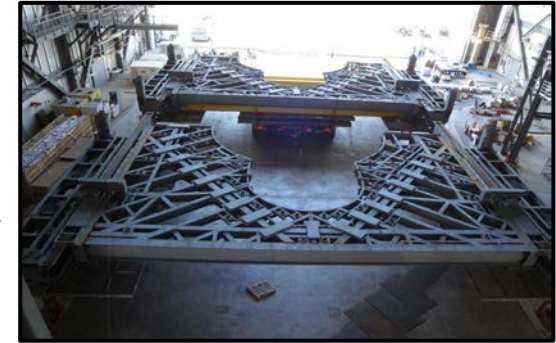

The K work platforms will provide access to the SLS core stage and solid rocket boosters during processing and stacking operations on the mobile launcher. A 325-ton crane will lift the platform up so it can be installed about 86 feet above the floor



Human Exploration and Operations

Exploration Ground Systems: FY 2017 Plans

- Complete detailed design, production, testing and verification and validation of ground processing facilities
- Complete systems software that supports hazardous operations for all ground processing operations of the SLS and Orion flight elements in the KSC facilities
- Complete development for the software applications and displays to support ground operations testing of the sub-systems in the VAB, Mobil Launcher and Launch Pad
- Complete Mobile Launcher Ground System Equipment (GSE) installation and umbilical installation contract
- Conduct three underway water recovery tests planned
- Validate that VAB and Pad B are ready for Mobile Launcher and flight hardware



Human Exploration and Operations

Exploration Research and Development

Human Research Program
Advanced Exploration Systems
Asteroid Redirect Mission



Human Exploration and Operations

Human Research Program: FY 2016 – FY 2017 Plans

- HRP will experience impacts to FY 2016 activities due to lower-than-planned appropriation. Potential impacts include
 - Delay or cancel collaborative research projects with Germany on astronaut visual impairment research and Russia on behavioral health/space human factors research
 - Delay transitioning new biomedical monitoring tools and countermeasures to operational use aboard ISS and/or Orion
 - Reduce research selections in critical areas such as space radiation and behavioral health
- Conclude joint One Year U.S./Russian and Twins Studies
 - Obtain unprecedented long-duration data on ocular health, immune and cardiovascular systems, cognitive performance testing, and countermeasure effectiveness against bone and muscle loss
 - Advance understanding of impacts on human body via identical twin study; may provide new “omics” data to understand effects of spaceflight on genetic makeup, and leverage this with non-human models via GeneLab project



American Astronaut Scott Kelly and Russian Cosmonaut Mikhail Kornienko; identical twin astronauts Scott and Mark Kelly



Studying blood and urine samples from crew members to learn how exposure to microgravity impacts the body



Human Exploration and Operations

Human Research Program: FY 2016 – FY 2017 Plans (continued)

- Collaborate with Crew Health and Safety on studies related to visual impairment, CO₂, exercise systems, cognitive function measures, and astronaut occupational surveillance
- Implement integrated ISS research and analog studies with international partners including hardware, data, and subject sharing to maximize research throughput
- Conduct required assessments with Orion, including E-Procedure Validation (electronic communication to be tested on EM-2), food mass reduction, exercise hardware and human testing using Orion seat and suit prototypes
- Initiate joint HRP/National Science Foundation Antarctic analog studies to support Behavioral Health and Performance
- Commence Human Translational Research Institute cooperative agreement to translate cutting edge emerging terrestrial biomedical research and technology development into applied space flight human risk mitigation strategies for exploration missions



Cosmonaut Gennady Padalka images the interior surface of his eye, with assistance from astronaut Terry Virts

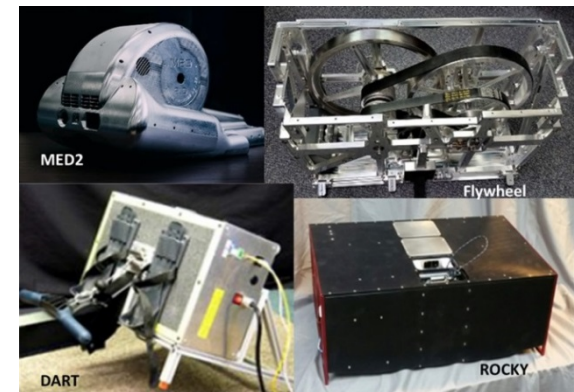

HRP is evaluating four exercise device concepts for EM-2



Human Exploration and Operations

Advanced Exploration Systems: Habitat Initiative

- Objectives
 - Use public-private partnerships to develop concepts, technologies, and systems for a cis-lunar habitation capability that leads to a long-duration habitat for Mars missions
 - Conduct flight demonstrations of key habitation systems on ISS to reduce risk
 - Use public-private partnerships to leverage commercial investments and stimulate the development of commercial habitats in LEO

- Strategy
 - Award NextSTEP Phase 2 public-private partnerships in 2016 to continue development of cis-lunar habitat concepts
 - Develop and test key habitation systems in-house such as environmental control and life support, radiation protection, and logistics reduction
 - Integrate functional systems into a prototype habitat for ground testing in 2018



Human Exploration and Operations

Advanced Exploration Systems: FY 2016 – FY 2017 Plans

- Deliver Bigelow Expandable Activity Module (BEAM) for launch on SpaceX-8 mission and deploy on ISS
- Complete industry-led system concept studies for cis-lunar habitats and high-power electric propulsion subsystems for thruster testing in Phase 1 of the Next Space Technology Exploration Partnerships (NextSTEP)
- Launch Saffire-I fire safety experiment on OA-6 (March 10), Saffire-II in June, and Saffire-III in October
- Complete Crew Module Systems Ascent Abort-2 Flight Test Systems Requirements and Preliminary Design Reviews in FY 2016 and CDR in FY 2017
- Develop and test highly-reliable life support systems to deploy on ISS and Orion, including brine processor, high pressure oxygen supply, and Spacecraft Atmosphere Monitor
- Complete joint study with Taiwan on lunar lander design concepts for Resource Prospector
- Complete design reviews for five deep space CubeSats to be launched on EM-1 (BioSentinel, Lunar Flashlight, NEA Scout, SkyFire, Lunar IceCube)



BEAM flight hardware being installed in SpaceX Dragon capsule's trunk

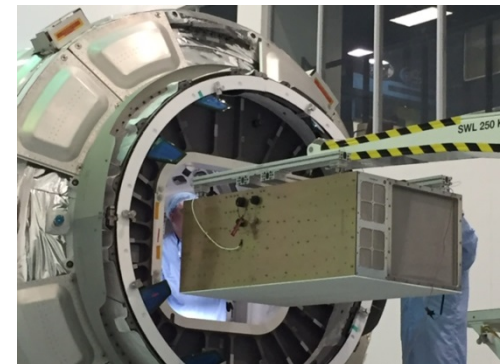

Installing Saffire-I in to the Orbital ATK Cygnus Pressurized Cargo Module in the Space Station Processing Facility at KSC

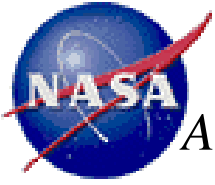

Human Exploration and Operations

Advanced Exploration Systems: FY 2016 – FY 2017 Plans (continued)

- Complete Mars Oxygen In-Situ Resource Utilization Experiment CDR for Mars 2020 mission
- Award NextSTEP Phase 2 partnerships in 2016 to continue development of cis-lunar habitat concepts
- Demonstrate prototype systems and sub-systems for a cis-lunar habitat on ISS including BEAM, environmental control and life support, spacecraft fire safety, and logistics reduction
- Continue development of other cis-lunar habitation systems such as a habitat docking hatch, radiation sensors, software for autonomous mission operations, avionics, and power systems
- Complete flight-ready commercial lunar lander developed under Lunar Cargo Transportation and Landing by Soft Touchdown (Lunar CATALYST) partnership
- Complete Universal Waste Management System CDR for testing on ISS and use on Orion

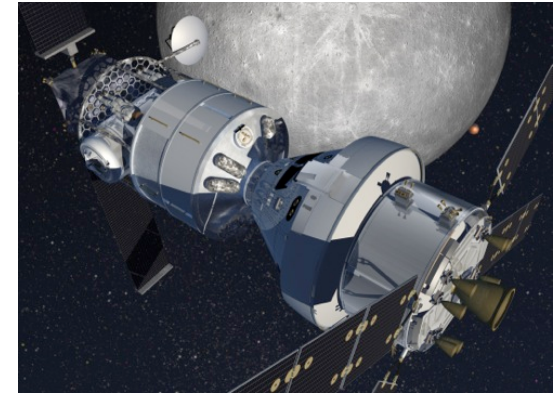

Artist's rendering of Cis-lunar habitat concept



Prototype of a universal waste management system



Human Exploration and Operations

Asteroid Redirect Mission: FY 2016 - FY 2017 Plans

- Continue leveraging essential activities that can be utilized on ARM
 - Continue asteroid observations (SMD)
 - Long lead component technology procurements for SEP technology demonstration mission (STMD)
 - Robotic systems and controls for interaction with non-cooperative bodies (STMD)
 - Advanced AES technology maturation for Portable Life Support Systems (HEO/AES)
- Complete robotic mission Key Decision Point – B (KDP-B) that will include an independent NASA technical and cost assessment
- Complete development of Mission Preliminary Design for the Robotic Mission
- Complete competitively solicited early design phase study contracts for robotic spacecraft (consistent with future human exploration needs for deep space transportation)
- Solicit spacecraft bus development contract
- Continue industry and international partnerships development



Human Exploration and Operations

Asteroid Redirect Mission: Budget Profile

- ARRM KDP-B is currently planned for this Spring; NASA will continue formulation in FY 2017 leading to refinement of cost and schedule estimates, launch date, and spacecraft bus development start

<i>Budget Authority (in \$ millions)</i>	Actual*	Enacted**	Request	Notional			
	FY 2015	FY 2016	FY 2017	FY 2018	FY 2019	FY 2020	FY 2021
Total ARM Budget	50	68	140	209	417	504	425
ARM (HEOMD)***	14	38	73	141	400	500	425
SEP (STMD)	36	30	67	68	17	4	0
Leveraging:							
RESTORE-L (STMD)	23	27	32	17	8	0	0

***ARM (HEOMD) funding includes ARRM (with Launch Vehicle) and ARM Integration & Crewed Mission.

*FY 2015 reflects funding amounts specified in the September 2015 Operating Plan per Public Law 113-235.

**FY 2016 reflects only funding amounts specified in Public Law 114-113, Consolidated Appropriations Act, 2016. FY 2016 funding levels are subject to change pending finalization of the FY 2016 Operating Plan.



Human Exploration and Operations

Space Flight Support

Space Communications and Navigation

Rocket Propulsion Testing Program

Launch Services Program

Human Space Flight Operations

21st Century Space Launch Complex



Human Exploration and Operations

Space Communications and Navigation: FY 2016 and FY 2017 Plans



DSS-36 (34 meter Beam Wave Guide) under construction in Canberra, Australia



DSS-43 (70 meter) DSN antenna in Canberra, Australia actively receiving New Horizons science data from Pluto. The science data will continue to be received through FY 2016

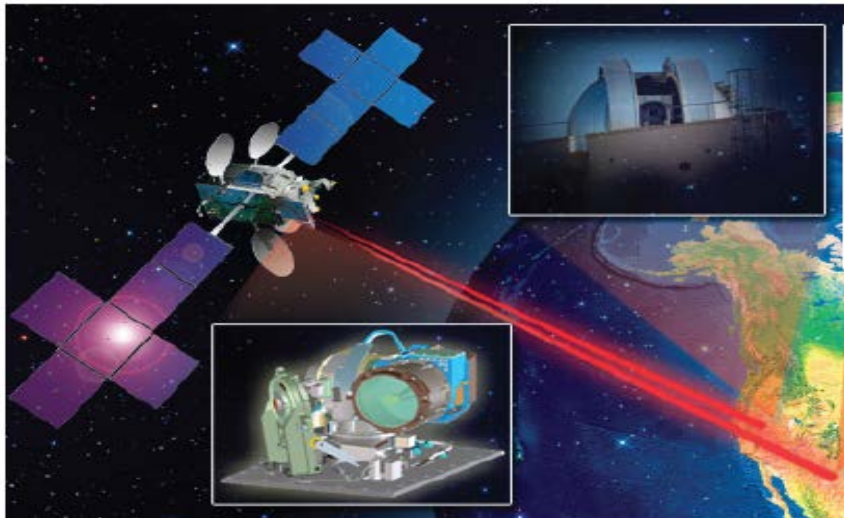

LCRD will demonstrate bi-directional high data rate optical communications from geosynchronous orbit and Earth



Human Exploration and Operations

Space Communications and Navigation: FY 2016 and FY 2017 Plans (continue)

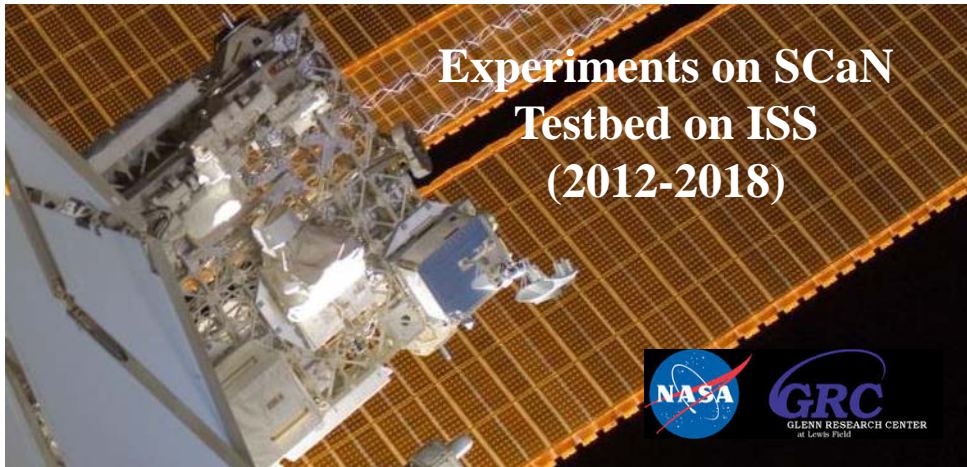

**Experiments on SCaN
Testbed on ISS
(2012-2018)**

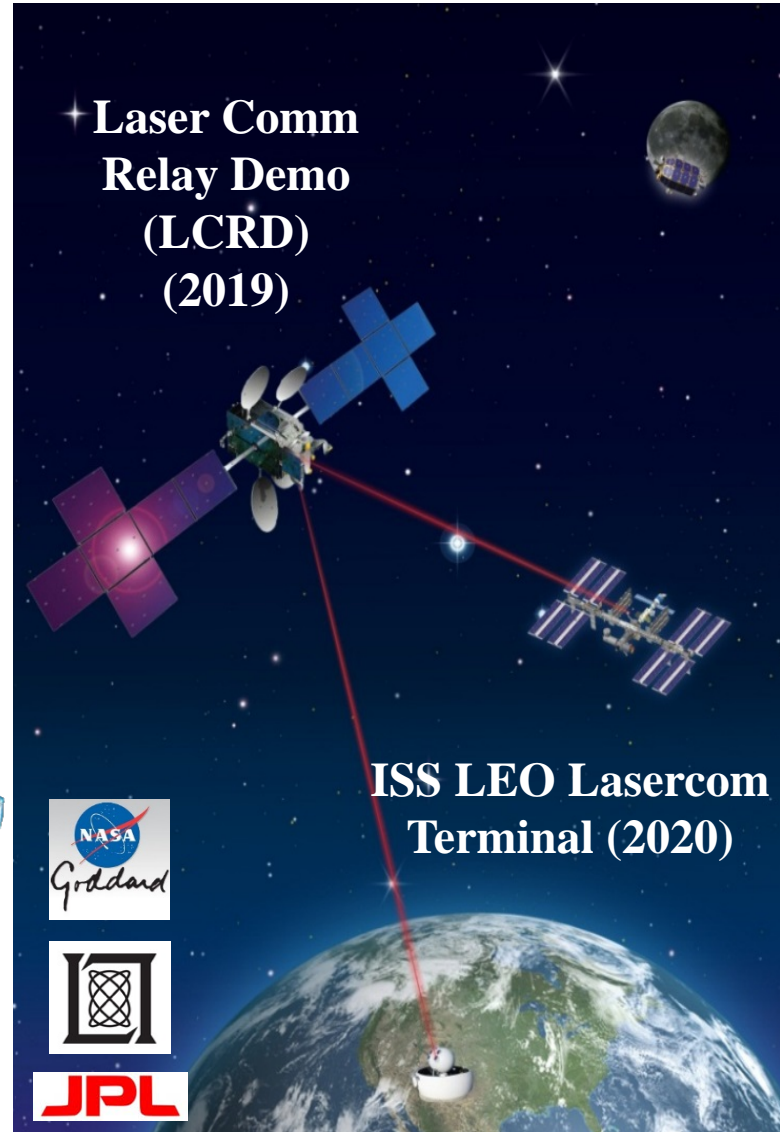

**Laser Comm
Relay Demo
(LCRD)
(2019)**

**ISS LEO Lasercom
Terminal (2020)**

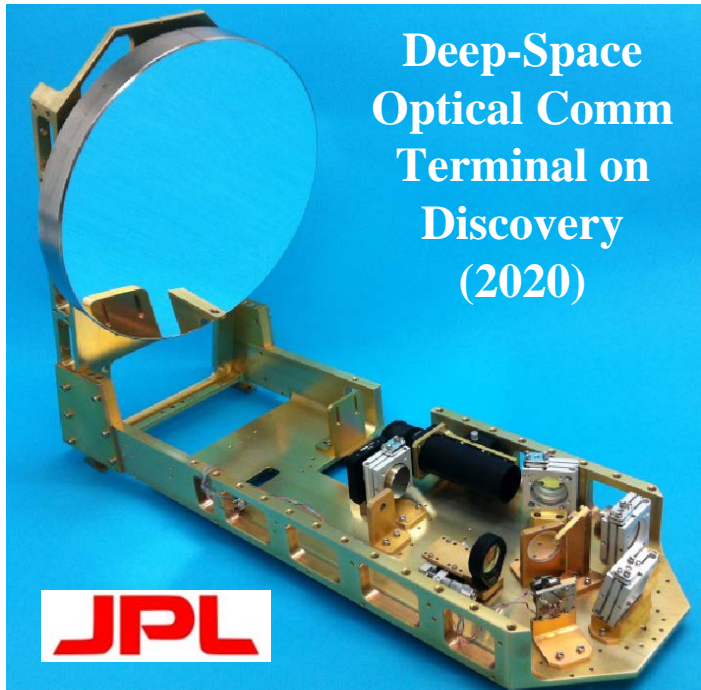

**Deep-Space
Optical Comm
Terminal on
Discovery
(2020)**

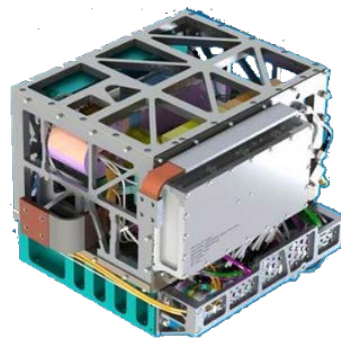

**Deep-Space
Atomic Clock
(2016)**



Human Exploration and Operations

Space Communications and Navigation: FY 2016 and FY 2017 Plans (continue)

- FY 2016 plans
 - LCRD KDP-C November 2015
 - Continue software coding, hardware integration, and testing for SGSS
 - Continuing “cognitive” radio and network experiments on SCaN Test Bed on ISS
 - “Software-defined” payload -- Function and performance can be reconfigured and upgraded by uploading new software which can allow the radio to learn and adapt to its environment
 - For example, by sensing interference and adapting its frequency accordingly
- FY 2017 plans
 - Remove TDRS-M from storage and prepare for launch in 2017
 - Commence repairs to DSS-63 (70 meter) antenna at Madrid, Spain DSN complex
 - Partnering with STMD in developing the Deep Space Atomic Clock, or DSAC
 - 100 times more stable than the current atomic clocks used in the GPS system
 - Enable “one-way” navigation for deep space missions such as Europa; Less time on large DSN antennas
 - Flying as a hosted payload later this year
 - Continue progress toward DSN Aperture Enhancement project
 - DSS-36 (34 meter) antenna enters operations at Canberra, Australia October 2016
 - Begin site work and pedestal/foundation fabrication for DSS-56 and 53 (34 meter) at Madrid, Spain



Human Exploration and Operations

Rocket Propulsion Testing: FY 2016 Plans

- Stennis Space Center

- Perform five tests of RS-25D engine to support SLS
 - One flight engine and four development engines
- Continue developmental and flight certification testing of commercial engine systems on reimbursable basis
 - Aerojet Rocketdyne AR-1 sub-scale and full-scale component testing supporting the replacement of the RD-180 engine
 - SpaceX Raptor testing
- Perform U.S. Air Force LOX/RP development testing supporting the Air Force Hydrocarbon Boost program
- Complete refurbishment of B-2 test stand to prepare for SLS core stage testing
 - Refurbishment of the stand includes work on special test equipment and preparation work on the test article continuing into 2017
- Complete replacement of E Test Complex data acquisition system to support test of sub-scale and component assemblies and engines



January 2015 hot fire of an RS-25 engine - one flight engine certification test and four engine development tests are planned for 2016

- Glenn Research Center

- Perform facility repairs and refurbishment of the vacuum systems enabling lower vacuum pressures, electric propulsion testing utilizing cryogenic cooling panels, and cryogenic engine hot fire testing utilizing the unique B-2 Plum Brook Station facility



Human Exploration and Operations

Rocket Propulsion Testing: FY 2016 Plans (continued)

- White Sands Test Facility
 - Complete the refurbishment and construction activities to support testing the Boeing Commercial Crew Service Module (on a reimbursable basis) and European Space Agency Orion Service Module
 - Test stand 301 is being modified for testing in late FY 2016 and into FY 2017 to accommodate both test articles
 - Perform testing for DoD, Missile Defense Agency, U.S. Air Force, and U.S. Navy
 - Complete the refurbishment activities for the Large Altitude Simulation System which supports space environment testing for Boeing commercial crew vehicle, Missile Defense Agency and US Air Force test articles
 - Continue testing the Aerojet Rocketdyne Reaction Control System thrusters being used on the Boeing CST-100 crew module
- Marshall Space Flight Center
 - Continue testing of rocket engine components manufactured using select laser melting and other additive manufacturing processes
 - F-1 GG Injector
 - Copper Thrust Chamber



Human Exploration and Operations

Rocket Propulsion Testing: FY 2017 Plans

- Stennis Space Center
 - Complete development of the special test equipment required to support the SLS Core Stage
 - Activate B-2 test stand for SLS Core Stage testing
 - Activation also includes receiving and installing the "fit test" article to make sure all connections and attach points match
 - Begin testing SLS Core Stage on the newly refurbished B-2 test stand
 - Perform engine testing for Aerojet Rocketdyne RS-68 engine, Aerojet Rocketdyne AR-1 engine, SpaceX and other commercial engine developers
 - Perform component testing for the U.S. Air Force LOX/RP test program
 - Perform facility modifications to the A-1 test stand necessary to support future SLS RS-25E engine development



June 2015 hot fire of an RS-25D engine (modified version of the Space Shuttle Main Engine) on the A-1 Test Stand at the SSC. Four RS-25 engines will power SLS's core stage



Human Exploration and Operations

Rocket Propulsion Testing: FY 2017 Plans (continued)

- White Sands Test Facility
 - Complete test programs for the Orion ESA Service Module on Test Stand 301
 - Complete test programs for the Boeing CST-100 Crew Module supporting CCP
 - Continue testing advanced rocket propulsion design and manufacturing techniques for government and commercial propulsion system developers
 - Perform engine testing for U.S. Air Force and commercial engine developers that support future ISS resupply requirements
 - Continue propulsion system development and certification testing for the DoD, Missile Defense Agency, U.S. Air Force, and U.S. Navy



Human Exploration and Operations

Launch Services Program FY 2016 Plans

- Provide end to end launch services management and support to over 40 missions in various stages of development
- Jason-3 successfully launched from Vandenberg Air Force Base, California aboard a Falcon 9 v1.1 rocket on January 17, 2016
- Origins-Spectral Interpretation Resources Identification-Security-Regolith Explorer (OSIRIS-REx) scheduled for launch from Cape Canaveral Air Force Station, Florida aboard an Atlas V in September 2016
- Begin vehicle certification efforts for the Falcon 9 Full Thrust configuration in preparation for the first use under the NASA Launch Services II contract





Human Exploration and Operations

Launch Services Program FY 2017 Plans

- Provide end to end launch services management and support to over 40 missions in various stages of development
- Cyclone Global Navigation Satellite System (CYGNSS) scheduled for launch from Cape Canaveral Air Force Station, Florida aboard a Pegasus XL in October 2016
- Geostationary Operational Environmental Satellite (GOES) R scheduled for launch from Cape Canaveral Air Force Station, Florida aboard an Atlas V in October 2016
- Joint Polar Satellite System (JPSS)-1 scheduled for launch from Vandenberg Air Force Base, California aboard a Delta II in January 2017
- GOES-S launch date is TBD, planned for launch from Cape Canaveral Air Force Station, Florida aboard an Atlas V
- Ionospheric Connection Explorer (ICON) scheduled for launch from Kwajalein aboard a Pegasus XL in June 2017
- Transiting Exoplanet Survey Satellite (TESS) scheduled for launch from Cape Canaveral Air Force Station, Florida aboard a Falcon 9 in August 2017





Human Exploration and Operations

Space Flight Crew Operations: Overview and Plans

- Manage NASA human space flight efforts, including directing and managing flight crew activities, astronaut selection, training astronaut candidates, and deployment and return of flight crews from Russia
- NASA currently has 47 active astronauts in the corps, including two in on-orbit, one in post-flight, and ten training for missions in 2016-2018
 - The remainder (34) are involved in several other activities such as technical integration with ISS, Orion/SLS and Commercial Crew vehicles and/or serving as Astronaut Office Managers
- FY 2016 plans
 - Begin training astronauts to support first human commercial space vehicles to ISS with crew assignments to Commercial Crew demo/test missions later this year
 - Partner with ISS Program in the Revolutionize ISS for Science and Exploration
 - Begin selection of a new astronaut candidate class for FY2017 (6,100 applicants to-date)
- FY 2017 plans
 - Provide trained astronauts for crewed test flight of first commercial crew vehicle
 - Interview and select new astronaut candidate class, targeted to be between 8 - 14 new astronauts



Scott Kelly inside a Soyuz simulator at Gagarin Cosmonaut Training Center, Star City, Russia, preparing for his one year mission and twin study which started in March 2015



Human Exploration and Operations

Crew Health and Safety: FY 2016 - FY 2017 Plans

- **FY 2016 Plans**
 - Provide clinical certification and mission support for active astronauts and physical, behavioral, and reconditioning health support for returning ISS Expeditions
 - Standardize astronaut occupational space suit exposure tracking during operations and training
 - Support ISS 12-month crew
 - Provide real time on orbit health monitoring and management, exercise regimen management, behavioral health support and post landing health evaluations, reconditioning and monitoring
 - Provide support to Chief Health and Medical Officer on long-term improvement in crew member occupational health and maintenance
 - Deploy data visualization and analytical tools to support operational, clinical and risk management decision making for Lifetime Surveillance of Astronaut Health
- **FY 2017 Plans**
 - Provide physical, behavioral, return, and reconditioning health support for returning ISS Expeditions
 - Provide crew health support for astronauts training to fly on commercial crew vehicles
 - Update Astronaut Radiation Exposure and Analysis Database to incorporate multiple exposure data structures
 - Analyze SpaceX and Boeing CST-100 crew capsule test flight radiation environment data for compliance with standards
 - Manage medical and psychological assessments of candidates for 2017 Astronaut Selection Class



Human Exploration and Operations

21st Century Space Launch Complex: FY 2016 Plans

- Kennedy Space Center
 - Complete replacement of old, deteriorating cable ducts that provide critical communications connection between KSC and Eastern Range
 - Begin facility design for eventual replacement/upgrade of converter compressor facility, which supplies gaseous nitrogen and helium to processing and launch sites across Florida Range
 - Complete Eastern Range Lightning System upgrade
 - Complete range telemetry upgrades and advanced ground system maintenance
 - Complete air handler installation in the booster fabrication facility
 - Complete upgrades to the multiple-object-tracking radar
- Wallops Flight Facility
 - Complete the RCC upgrades that will improve the capabilities in the control center used to support Orbital ATK CRS launches
 - Complete Bermuda tracking station modernization work
 - Completion of all performance testing on Pad OA allowing Orbital ATK to launch CRS missions out of Wallops



Human Exploration and Operations

21st Century Space Launch Complex: FY 2017 Plans

- Kennedy Space Center
 - Operations and Maintenance of weather infrastructure, SMEs, and data archival required across the Eastern Range
 - Completion of the Automated Radio Frequency Monitoring System project
 - Completion of Verification and Validation for Universal Propellant Servicing System
 - Banana River dredging which is required to support barge access to the Turn Basin Wharf



Human Exploration and Operations

In Summary, the FY 2017 PBR...

- Continues the great progress underway on the initial vehicles for exploration in cis-lunar space -- SLS, Orion, and associated ground systems
- Supports development of commercial crew transportation for low Earth orbit market
- Advances research, technology, and capability for long-duration missions beyond LEO
 - Rendezvous, grappling, proximity operations, and SEP to be demonstrated on ARM
 - Developing long-duration, high-reliability, closed-loop habitat systems
- Provides research and technology testing aboard ISS to enable future exploration of space and practical benefits on Earth
 - National Laboratory for enabling commercial research ultimately creating commercial demand
 - Increase knowledge and test systems needed for healthy and productive crew
 - Gain operational experience and procedures for extended missions
 - Maintains U.S. leadership of human spaceflight through ISS
- Facilitates commercial industry in LEO with reliable cargo resupply services
- Continues enabling capabilities critical to operations and exploration in and beyond low Earth orbit: space communications, launch services, propulsion test capability, crew training, safety, and operations



Human Exploration and Operations

Acronym List

- 21st CSLC 21st Century Space Launch Complex
- AA-2 Ascent Abort Test-2
- ABC Agency Baseline Commitment
- AES Advanced Exploration Systems
- AIB Accident Investigation Board
- AMS Alpha Magnetic Spectrometer
- ARM Asteroid Redirect Mission
- ARRM Asteroid Redirect Robotic Mission
- ATP Authority to Proceed
- BAA Broad Area Announcement
- BEAM Bigelow Expandable Activity Module
- BEO Beyond Earth Orbit
- BPS Biological and Physical Sciences
- CASIS Center for the Advancement of Science in Space
- CCP Commercial Crew Program
- CCtCap Commercial Crew transportation Capability
- CDR Critical Design Review
- CM Crew Module
- CREAM Cosmic-Ray Energetics and Mass
- CRS Commercial Resupply Services
- DDT&E Design Development Test and Evaluation
- DSN Deep Space Network
- DSS Deep Space Station
- DTN Disruption Tolerant Networking for Space Operations
- ECLSS Environmental Control and Life Support System
- EFT Exploration Flight Test
- EGS Exploration Ground Systems
- ELC Express Logistic Carrier
- EM Exploration Mission
- ESA European Space Agency
- ESD Exploration Systems Development
- ESM European Service Module
- EUS Exploration Upper Stage
- EVA Extravehicular Activity
- ExPRESS Expedite the Processing of Experiments to Space
- FTE Full Time Equivalent
- GSDO Ground Systems Development and Operations
- GSE Ground System Equipment
- HEOMD Human Exploration and Operations Mission Directorate
- HEO Human Exploration and Operations Mission Directorate
- HRP Human Research Program
- HTV H-II Transfer Vehicle
- ICPS Interim Cryogenic Propulsion Stage
- IDA International Docking Adapter
- IDIQ indefinite-delivery, indefinite-quantity
- InSight Interior Exploration using Seismic Investigations, Geodesy and Heat Transport
- ISRS In-Space Robotic Servicing
- ISS International Space Station



Human Exploration and Operations

Acronym List

- JAXA Japanese Aerospace Exploration Agency
- KDP Key Decision Point
- KSC Kennedy Space Center
- LaRC Langley Research Center
- LAS Launch Abort System
- LCRD Laser Communication Relay Demonstration
- LEO low Earth orbit
- LH₂ Liquid Hydrogen
- LOX Liquid Oxygen
- LVSA Launch Vehicle Stage Adapter
- MAF Michoud Assembly Facility
- MISSE Materials for ISS Experiment
- MPCV Multi-Purpose Crew Vehicle
- MSFC Marshall Space Flight Center
- MUSES Multi-User System for Earth Sensing
- MUSS Multi User Systems and Support
- NASA National Aeronautics and Space
- NICER Neutron star Interior Composition Explorer
- NL National Laboratory
- NRPTA National Rocket Propulsion Test Alliance
- Orbital, Orbital ATK
- PBR President's Budget Request
- PCM Pressurized Cargo Module
- PDR Preliminary Design Review
- Saffire Spacecraft Fire Experiment
- SAGE III Stratospheric Aerosol and Gas Experiment III
- SCaN Space Communication and Navigation
- SCCS Spaceport Command and Control System
- SEP Solar Electric Propulsion
- SFS Space and Flight Support
- SGSS Space Network Ground Segment Sustainment
- SLS Space Launch System
- SMD Science Mission Directorate
- SpaceX Space Explorations Technologies Corporation
- SRB Standing Review Board
- STMD Space Technology Mission Directorate
- TBR To Be Revised
- TDRS Tracking and Data Relay Satellite
- TLI Trans-Lunar Injection
- VAB Vehicle Assembly Building
- Veggie The Vegetable Production System
- VIIP Visual Impairment Intracranial Pressure
- WFF Wallops Flight Facility
- ZBOT Zero Boil Off Tank