

# PAPER BAG MASK

## Objective

The students will:  
Construct a device that demonstrates Bernoulli's principle.  
Understand the effect of air flowing over a curved surface.

---

## Standards and skills

### Science

Science as Inquiry  
Unifying Concepts and Processes

### Science Process Skills

Measuring  
Inferring  
Predicting  
Science as Inquiry

### Mathematics

Geometry and Measurement  
Problem Solving

---

## Background

A change in the speed at which air is flowing will cause a change in air pressure. Daniel Bernoulli, a Swiss scientist in the 18th century, discovered what is now called *Bernoulli's principle*: the pressure in a fluid (gas and liquids) decreases as the speed of the fluid increases.



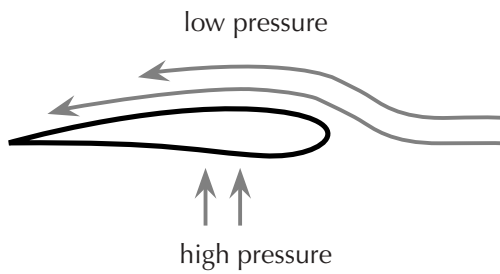

The wing of an airplane is a device that creates changes in the speed of air flow, thus creating a change in air pressure. Air moving over the curved top portion of a wing will travel at higher speed and produce lower pressure than the bottom, creating *lift*. Lift is a force caused by the equalization of pressures. Equalization always occurs from areas of high pressure to low pressure. An inflated balloon has higher air pressure inside than outside. The balloon will pop when the pressure difference becomes too great for the material.

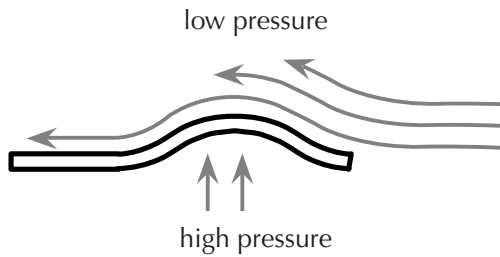

Another example of Bernoulli's principle can be seen using the paper bag mask. When the student blows through the hole in the paper bag mask and over the curved surface of the "tongue," unequal air pressure will lift the tongue.

**The low pressure of the airflow over the top of the "tongue" creates lift in the same way that a wing produces lift.**

---

## Materials

Large paper grocery bags  
Scissors  
Crayons or markers  
Notebook or copier paper  
Tape or glue  
Metric ruler

---

## Preparation

Have each student bring a large paper grocery bag from home.

## Activity

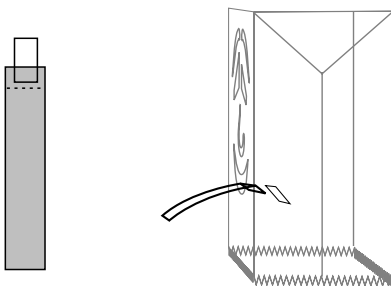
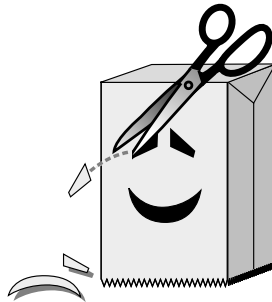
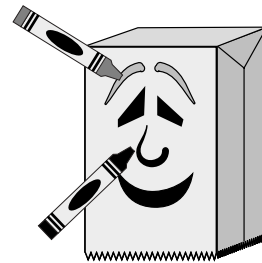
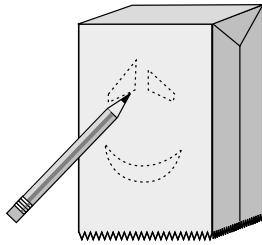

1. Place a bag over the head of one student and have a second student carefully draw small dots where the eyes, nose, and mouth are located.
2. Remove the bag from the head and draw a face around the marks made in step 1.
3. Cut out two holes (approximately 2 cm diameter) for the eyes.
4. Cut a hole (approximately 4 cm diameter) for the mouth.
5. To make the tongue, cut a strip of paper, approximately 3 cm wide and 20 cm long.
6. Tape or glue one end of the tongue inside the bag at the bottom of the mask's mouth. Allow the tongue to droop through the mouth on the outside of the bag.
7. Place the bag over the head and blow through the mouth hole. Observe the movement of the tongue.

---

## Discussion

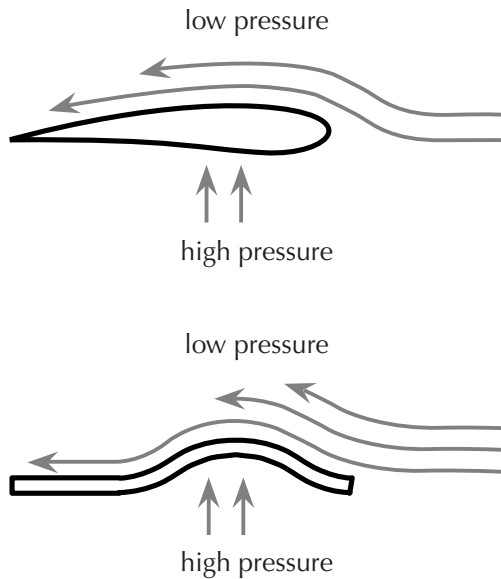

1. Why does the tongue move when you blow gently through the mouth? What happens when you blow harder? The *curved surface of the tongue creates unequal air pressure and a lifting action. Blowing harder will cause the tongue to move up and down faster.*
2. Attach a lightweight streamer to a fan or air conditioning vent. Ask the students to observe and describe what happens. How do the streamers relate to this activity? *The same force moves the tongue and streamers. Lift is caused by air moving over a curved surface.*
3. What are some other common examples of Bernoulli's principle? *Flags waving, sails, an umbrella that becomes impossible to hold in a strong wind.*

---

## Assessment

1. Have a classmate observe the paper tongue and record what happens. Switch roles.
2. Write a paragraph or draw a picture to describe what happens to the paper tongue.
3. Write a paragraph or draw a picture to tell how airplane wings are similar to the paper tongue.

---

## Extensions

1. Experiment with different tongue lengths.
2. Encourage the students to be creative with the designs on the bags – faces that say something about who they are, or who they want to be, maybe the face of a friend, relative, or classmate. The designs may also be abstract, or not human; consider holiday themes.



# Paper Bag Mask

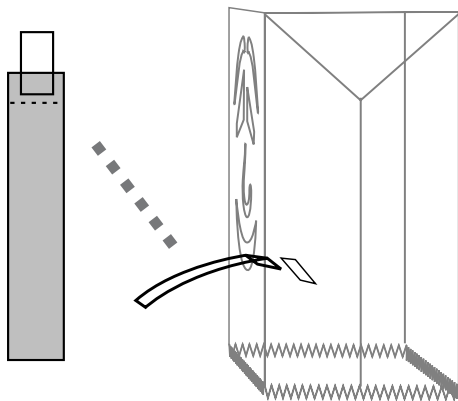
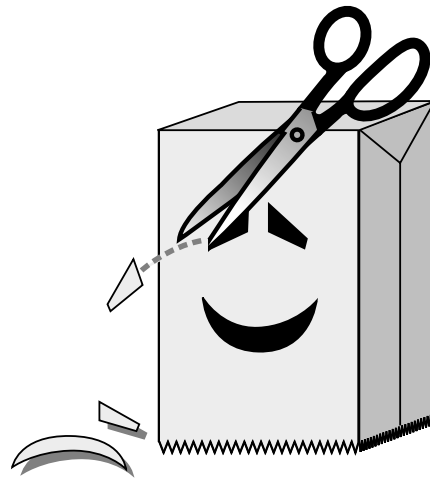
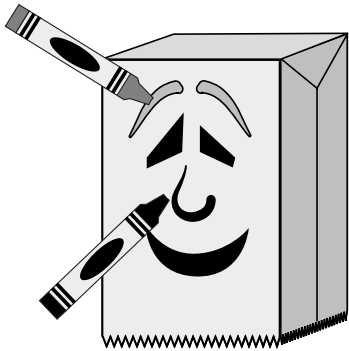
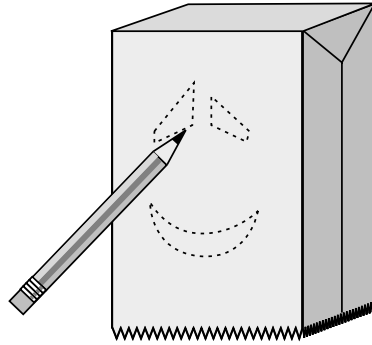
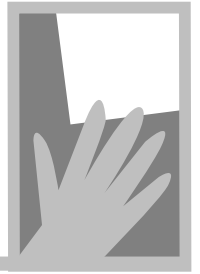



# Paper Bag Mask

