Minimum Time and Fuel Flight Profiles for an F-15 Airplane With a Highly Integrated Digital Electronic Control System

Edward A. Haering, Jr., and Frank W. Burcham, Jr.

June 1984

Minimum Time and Fuel Flight Profiles for an F-15 Airplane With a Highly Integrated Digital Electronic Control System

Edward A. Haering, Jr., and Frank W. Burcham, Jr.
Ames Research Center, Dryden Flight Research Facility, Edwards, California 93523

1984



National Aeronautics and
Space Administration
Ames Research Center
Dryden Flight Research Facility
Edwards, California 93523

INTRODUCTION

As part of the NASA Highly Integrated Digital Electronic Control (HIDEC) program, the performance improvements due to the integration of the propulsion and flight control systems on an F-15 airplane are being evaluated. Results of the previously conducted Integrated Research AirCRAFT Technology (INTERACT) program (ref. 1) has shown the benefits of integration of the propulsion and flight control systems. Two of the control modes investigated in the INTERACT studies were optimum flight path trajectories and adaptive engine stall margin. These modes have been incorporated in the HIDEC program. The adaptive engine stall margin mode, or uptrim, allows engine stall margin to be traded for increased thrust. However, during unusual maneuvers or transients, the full stall margin (no uptrim) is required. The optimum flight path modes allow the airplane to be more efficiently flown from one flight condition to another. For this report, the optimum trajectories for minimum time and minimum fuel are determined, and the effects of the the adaptive stall margin (uptrim) are evaluated. Comparisons are made to a pilot's estimate of the optimum flight paths. The data used in this study is limited to standard day conditions at maximum thrust for the clean configuration of the F-15.

SYMBOLS AND ABBREVIATIONS

Units are given in the International System of Units (SI) and parenthetically in U.S. Customary Units. Most of the calculations were made in Customary Units and converted to SI Units.

| | |
|----------|-------------------------------------------------------------------|
| Alpha | angle of attack, deg |
| CD | drag coefficient |
| CL | lift coefficient |
| DEEC | digital electronic engine control |
| EMD | engine model derivative |
| Es | specific energy, m/kg (ft/lb) |
| INTERACT | Integrated research aircraft technology |
| M | Mach number |
| H | altitude, m (ft) |
| HIDEC | highly integrated digital electronic control |
| Ps | specific excess power, m/sec (ft/sec) |
| PsOWDT | Ps divided by fuel flow, m/kg (ft/lb) |
| PTINF | free stream total pressure, kN/m^2 (lb/in^2) |
| PT2 | engine inlet total pressure, kN/m^2 (lb/in^2) |

DESCRIPTION OF AIRPLANE

The simulation used for this optimization and comparison study was of an F-15 supersonic fighter powered by two F100 Engine Model Derivative (EMD) engines. The F-15 is an all-weather air superiority fighter with excellent transonic maneuverability and Mach number capability to 2.5. A three-view drawing of the F-15 is shown in figure 1. The takeoff gross weight for this study was 173.5 kN (39,000 lb).

Aerodynamics

Aerodynamic characteristics of the airplane were represented in terms of lift and drag coefficients and angle of attack as a function of Mach number. These data were obtained from F-15 flight tests (ref. 2). Figure 2 shows the drag coefficient, C_D , as a function of Mach number and lift coefficient, C_L . The angle of attack, α , is shown in figure 3 as a function of C_L and M .

Inlet

The inlet characteristics, in terms of total pressure recovery, PT_2/PT_{INF} , of the F-15, were determined for the maximum power airflow values of the F100 EMD engine over the Mach number range as shown in figure 4. These values were used as inputs to the EMD engine thrust deck.

Engine

The engines used in this evaluation were the F100 EMD engines, shown in figure 5. These engines were built by Pratt And Whitney Aircraft and have a company designation of PW 1128. The engine is a low bypass after-burning turbofan which is an upgraded version of the F100-PW-100 engine which powers the production F-15 airplanes. Figure 5 shows the features of the F100 EMD engine and the differences from the F100-PW-100 engine. It has a sea-level-static thrust rating of approximately 122.33 kN (27,500 lb). The F100 EMD engine is equipped with a digital electronic engine control (DEEC). Because of its ability to accept airplane inputs, the DEEC makes it practical to vary the engine stall margin as a function of appropriate airplane inputs. For this study, the uptrim capability determined from the INTERACT study (ref. 1) was used.

Thrust and Fuel Flow

The values of thrust and fuel flow for the F100 EMD were generated through the use of the Pratt and Whitney F100 EMD status deck, PWA CCD 1194.2 (ref. 3). Figures 6 and 7 show the thrust and fuel flow data respectively as a function of Mach number and altitude. These data were generated for standard day conditions only. Typical horsepower extraction (48,470 W (65 hp)) and customer bleed (0.32 kg/sec (0.7 lb/sec)) values were assumed, and the inlet recovery of figure 4 was used.

Uptrim

Figure 8 shows the engine uptrim that may be expected for an engine with an adaptive stall margin capability, as determined from the INTERACT studies. The uptrim factors as a function of Mach number and altitude are applied to thrust and

fuel flow for the maximum afterburning power setting. This produces a thrust increase without any change in specific fuel consumption.

OPTIMIZATION TECHNIQUE

The optimization technique of Rutowski (ref. 4) has been used in this study to determine minimum time and minimum fuel consumed trajectories.

To generate the minimum time profile, the specific energy and specific excess power must be known. For this study, specific energy, E_s , is defined as the sum of the potential and kinetic energy per unit weight, and is a function only of altitude and velocity and is independent of airplane configuration. Specific excess power, P_s , is defined as the time derivative of E_s , that is, dE_s/dt . P_s is a function of the airplane thrust and drag, and thus must be determined for each flight condition and power setting. The P_s contours and the lines of constant specific energy are superimposed upon each other and the points of tangency define the minimum time path for a given configuration, as indicated schematically in figure 9. The minimum fuel profile requires the same type of manipulation, but the two variables are E_s and $PsOWDT$, specific excess power divided by fuel flow, or energy gain per kilogram (pound) of fuel burned. A minimum fuel profile is shown schematically in figure 10.

The flight paths were optimized for the F100 EMD without and with uptrim. Once the optimum flight path for each engine control mode was determined, the corresponding differences between the two modes were compared.

TRAJECTORY PROGRAM

A computer program was used to generate time histories of airplane trajectories and provide calculated values of velocity, range, fuel consumed, P_s , $PsOWDT$ and numerous other parameters. The three dimensional trajectory analysis program uses a point mass representation of the airplane and integrates the equations of motion while following a given flight profile.

The program was used for two different purposes. The first purpose is to generate the data for the P_s and $PsOWDT$ contours by computing level accelerations at various altitudes. The second purpose is to evaluate the optimum flight paths generated by the Rutowski technique. The trajectories were input to the program as Mach number--altitude flight profiles.

PROCEDURE

The data for the P_s and $PsOWDT$ contours was obtained by computing level accelerations at altitude increments of 1,524 m (5,000 ft) from sea level to 16,764 m (55,000 ft) with the three dimensional trajectory program. Beginning weight for each acceleration was 173.5 kN (39,000 lb) and weight decreased as fuel was burned.

All the optimum flight path profiles started at Mach 0.15 and 1,524 m (5000 ft). In some cases, simplifications to optimum profiles were made to facilitate implementation in the trajectory program. The ending conditions were Mach 2.0 at 13,716 m (45,000 ft). All of the trajectories started with a level acceleration to an optimum climbing Mach number. The flight paths were input to the trajectory program in short straight line segments as determined by the Ps and PsOWDT contours.

The optimum flight profiles were compared to a pilot's estimated optimum profile, which was calculated without uptrim. The pilot's estimate was based upon the information in the F-15 flight manual (ref. 5) and from previous flight experience in the F-15.

RESULTS AND DISCUSSION

Minimum Time Profiles

Figure 11 shows the Ps contours for the F-15 with the F100 EMD engines without uptrim, for 1 g flight. Maximum Ps values occur at low altitudes around Mach 0.9. At higher altitudes and at supersonic speeds, Ps values are lower. The minimum time to climb path is also shown. It consists of a level acceleration at 1,524 m (5000 ft) to Mach 0.98, a climb with a slight acceleration to 8,077 m (26,500 ft), an acceleration with a slight climb to Mach 2.0, and a constant Mach climb to 13,716 m (45,000 ft). The final constant Mach climb is used in place of the optimal flight path which would include an acceleration to a slightly higher Mach number followed by a climbing deceleration along a constant energy line.

The Ps contours for the F-15 with uptrim are shown in figure 12. The Ps values for a given Mach number and altitude are greater than those of Figure 11 without uptrim, although the shape of the two sets of contours are similar. The profile for minimum time is also shown, and is similar to the optimum profile without uptrim.

The two minimum time profiles are compared in figure 13. Also shown is the pilot's estimate of the minimum time profile, based on information in the F-15 flight manual. The figure shows that for transonic and higher Mach numbers, the optimum profiles are flown at lower altitudes than the pilot's estimate.

The times required to reach Mach 2.0, at an altitude of 13,716 m (45,000 ft) are compared in Table 1. The pilot's estimate took 2.97 min, while the optimum profile without uptrim took 2.54 min, or 15 percent less. The optimum profile with uptrim took 2.28 min, or 23 percent less than the pilot's estimate. The profile with uptrim is 10 percent faster than the profile without uptrim. The optimum time profiles used more fuel than the pilot's estimate.

Minimum Fuel Profiles

The contours of PsOWDT for the F-15 without uptrim are shown in figure 14. Maximum values of PsOWDT lie in the Mach 0.8 to 1.0 range. The minimum fuel to climb flight path without uptrim is also shown. It consists of a level acceleration at 1,524 m (5,000 ft), followed by a constant Mach climb at Mach 0.98 to an altitude of 13,716 m (45,000 ft). The remainder of the profile is an acceleration with altitudes slightly lower than 13,716 m (45,000 ft).

Figure 15 shows the PsOWDT contours with uptrim and the corresponding minimum fuel path. The contours and the profile for minimum fuel are very similar to those without uptrim (fig. 14).

The two minimum fuel profiles and the pilot's estimate are shown in figure 16. The pilot's estimate of the minimum fuel profile was derived from the pilot's manual and the pilot's previous experience. In this case, the pilot's estimate was very close to the optimum profiles.

Results of the three profiles are compared in Table 2. The pilot's estimate took 1,755 kg (3,870 lb) of fuel, while the minimum fuel profile without uptrim took 1,735 kg (3,826 lb), a savings of 1 percent. The time required was 15 percent less even though the fuel saving was small. The minimum fuel profile with uptrim took 1,659 kg (3,658 lb) of fuel, a saving of 5 percent compared to the pilot's estimate, and the time required was 20 percent less. The profile with uptrim used 4 percent less fuel than the profile without uptrim. In this case, the very good pilot's estimate minimized the benefit of the optimization technique in fuel savings, but the optimization did show reduced times.

CONCLUSIONS

A computer study was performed on an F-15 fighter with two Pratt and Whitney F100 EMD engines installed. This study was conducted to determine optimum time and fuel trajectories for the F100 EMD engines without and with uptrim. These trajectories were then compared. The following conclusions were reached:

1. Ps and PsOWDT contours with uptrim are similar in shape and greater in value than the corresponding contours without uptrim.
2. The minimum time trajectory without uptrim was 15 percent faster and used 8 percent more fuel than the pilot's estimate for minimum time.
3. The minimum time trajectory with uptrim was 23 percent faster and used 5 percent more fuel than the pilot's estimate for minimum time.
4. The minimum fuel trajectory without uptrim used 1 percent less fuel and was 15 percent faster than the pilot's estimate for minimum fuel.
5. The uptrimmed minimum fuel trajectory used 5 percent less fuel and was 20 percent faster than the pilot's estimate for minimum fuel.
6. For transonic speeds and above, all optimum trajectories are lower in altitude than the pilot's estimate.

Ames Research Center
Dryden Flight Research Facility
National Aeronautics and Space Administration
Edwards, California 93523, April 3, 1984

REFERENCES

1. Burcham, Frank W., Jr., and Stewart, James F.: The Development Process for Integrated Propulsion-Flight Controls. NASA CP-2162, 1980.
2. Zaloga, Thomas: F-15A Performance Air Force Development Test and Evaluation (AFDT & E). AFFTC-TR-77-7, July 1977.
3. F100 EMDP Prototype Engine Flight Demonstration Performance Model, User's Manual for Deck CCD 1194.2. Pratt and Whitney Aircraft Report FR-16212, Mar. 31, 1983.
4. Porter, Capt. Milton B. Jr.: RUTOP--Rutowski Optimization Computer Program. AFFTC-TR-68-14, Jan. 1969.
5. F-15 Flight Manual, USAF TO-1F-15A-1, Nov. 1978.

TABLE 1. - TIME AND FUEL FOR MINIMUM TIME PATHS

| Minimum time paths | Time | | Fuel | |
|--------------------|------|--------------------|-------------|--------------------|
| | Min. | Percent difference | kg (lb) | Percent difference |
| Pilot's estimate | 2.97 | ----- | 1789 (3944) | ----- |
| Without uptrim | 2.54 | -15 | 1949 (4297) | +8 |
| With uptrim | 2.28 | -23 | 1881 (4146) | +5 |

TABLE 2. - TIME AND FUEL FOR MINIMUM FUEL PATHS

| Minimum fuel paths | Time | | Fuel | |
|--------------------|------|--------------------|-------------|--------------------|
| | Min. | Percent difference | kg (lb) | Percent difference |
| Pilot's estimate | 4.15 | ----- | 1755 (3870) | ----- |
| Without uptrim | 3.54 | -15 | 1735 (3826) | -1 |
| With uptrim | 3.32 | -20 | 1659 (3658) | -5 |

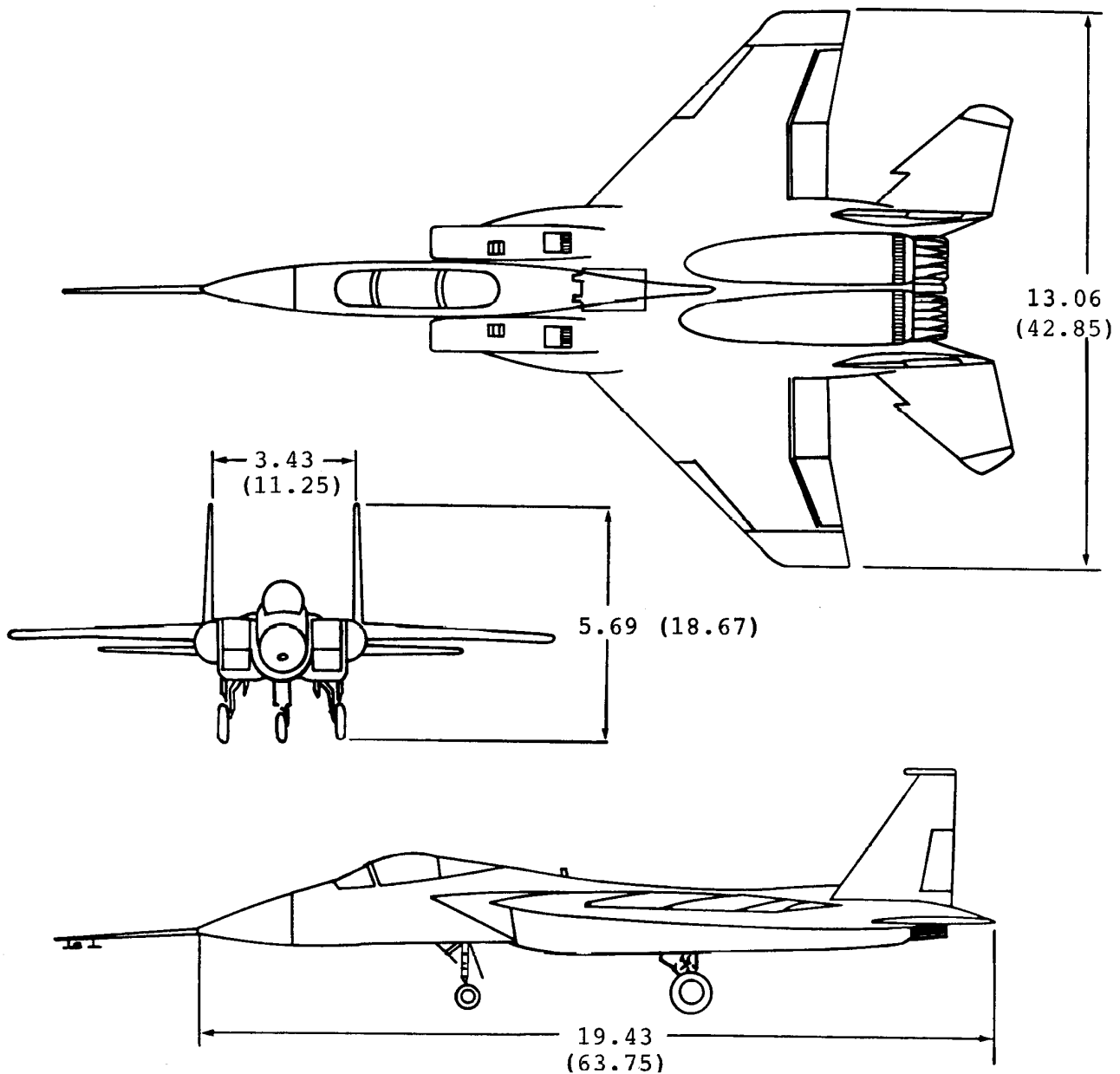

Figure 1. Three-view drawing of F-15 airplane.
Dimensions in meters (ft).

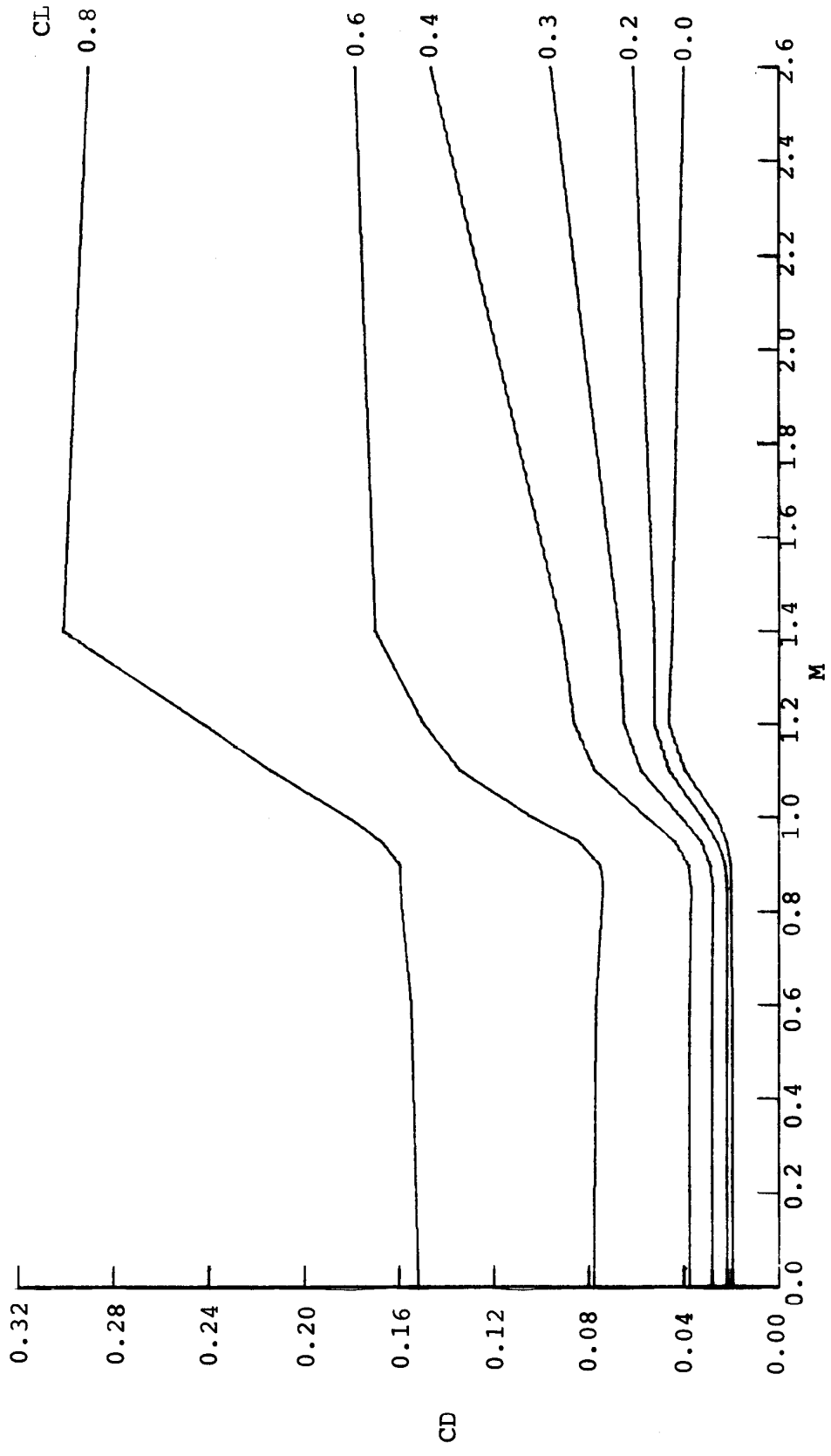

Figure 2. CD as a function of Mach and CL for the F-15 HIDEC

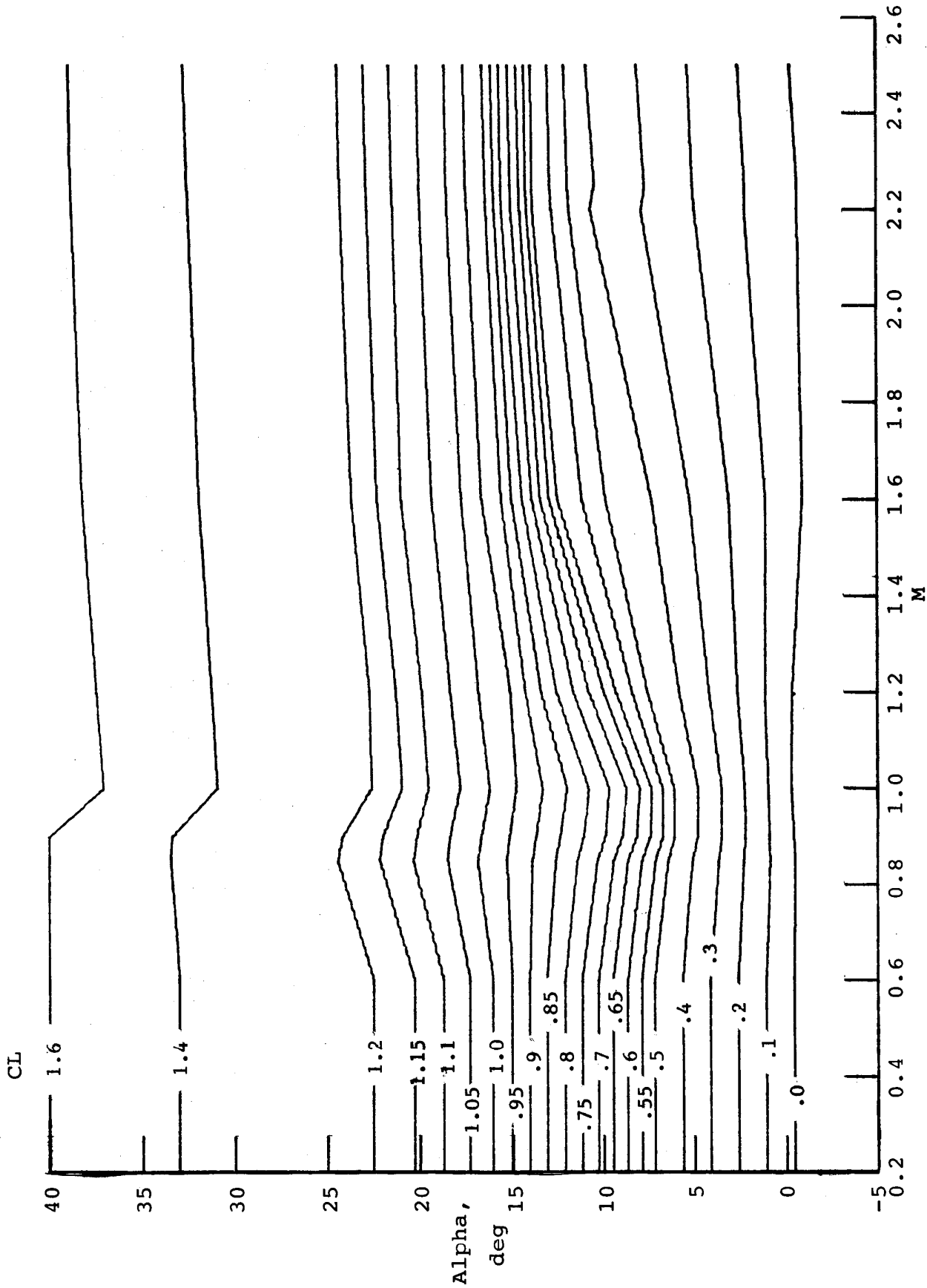

Figure 3. Alpha as a function of Mach number and CL for the F-15 HIDE

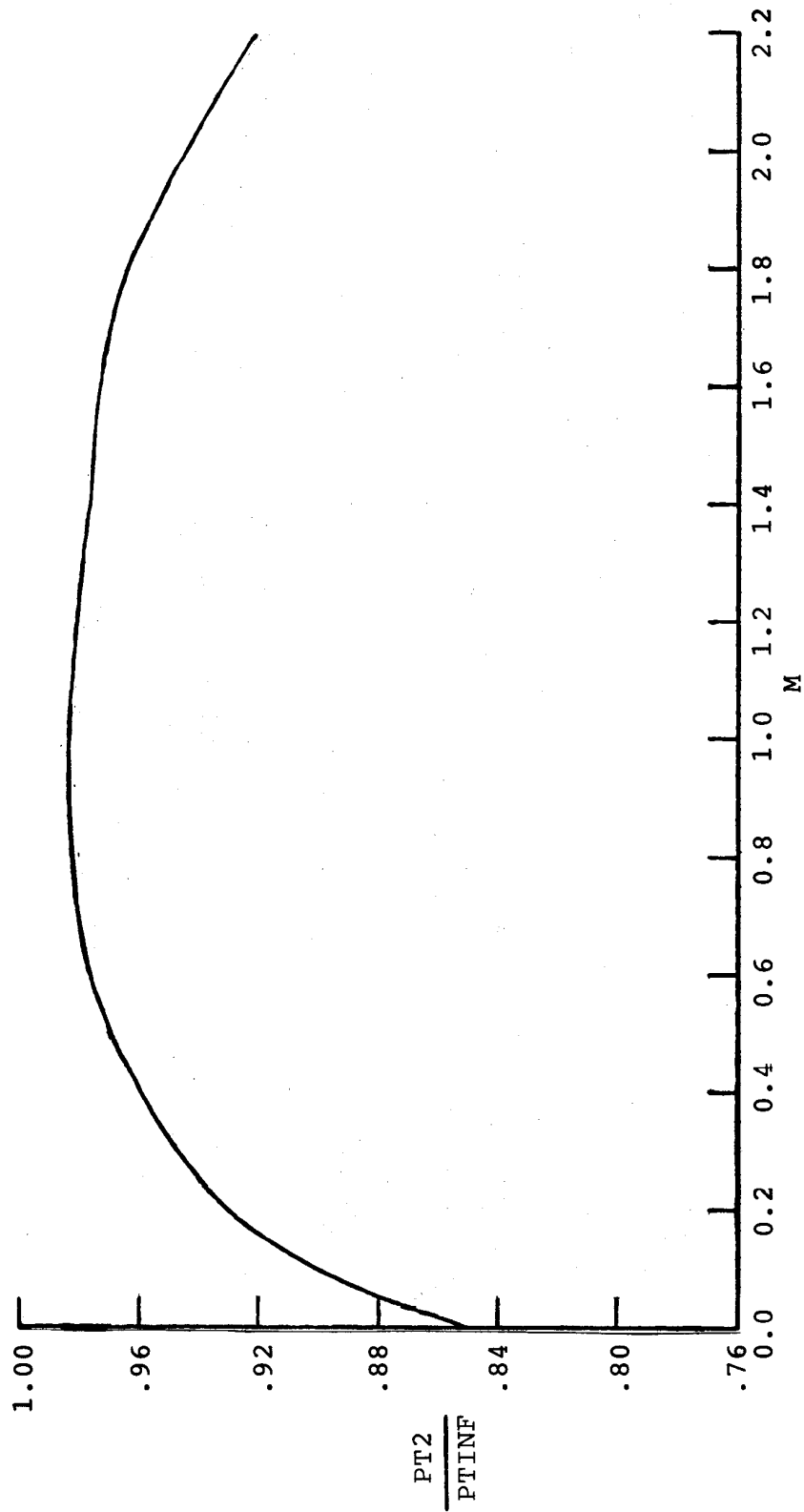

Figure 4. Inlet Total Pressure Recovery used for F100 EMD Thrust and Fuel Flow

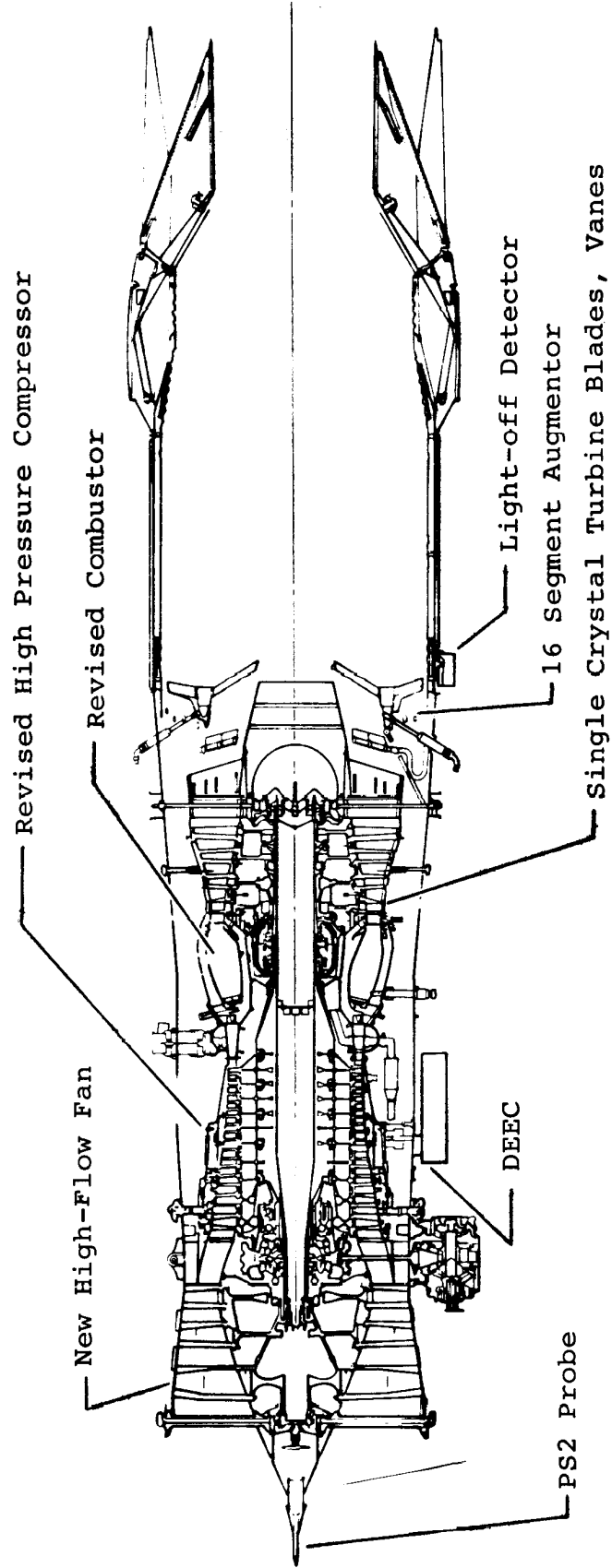

Figure 5. - F100 EMD engine showing differences between the EMD and the F100-PW-100 engine.

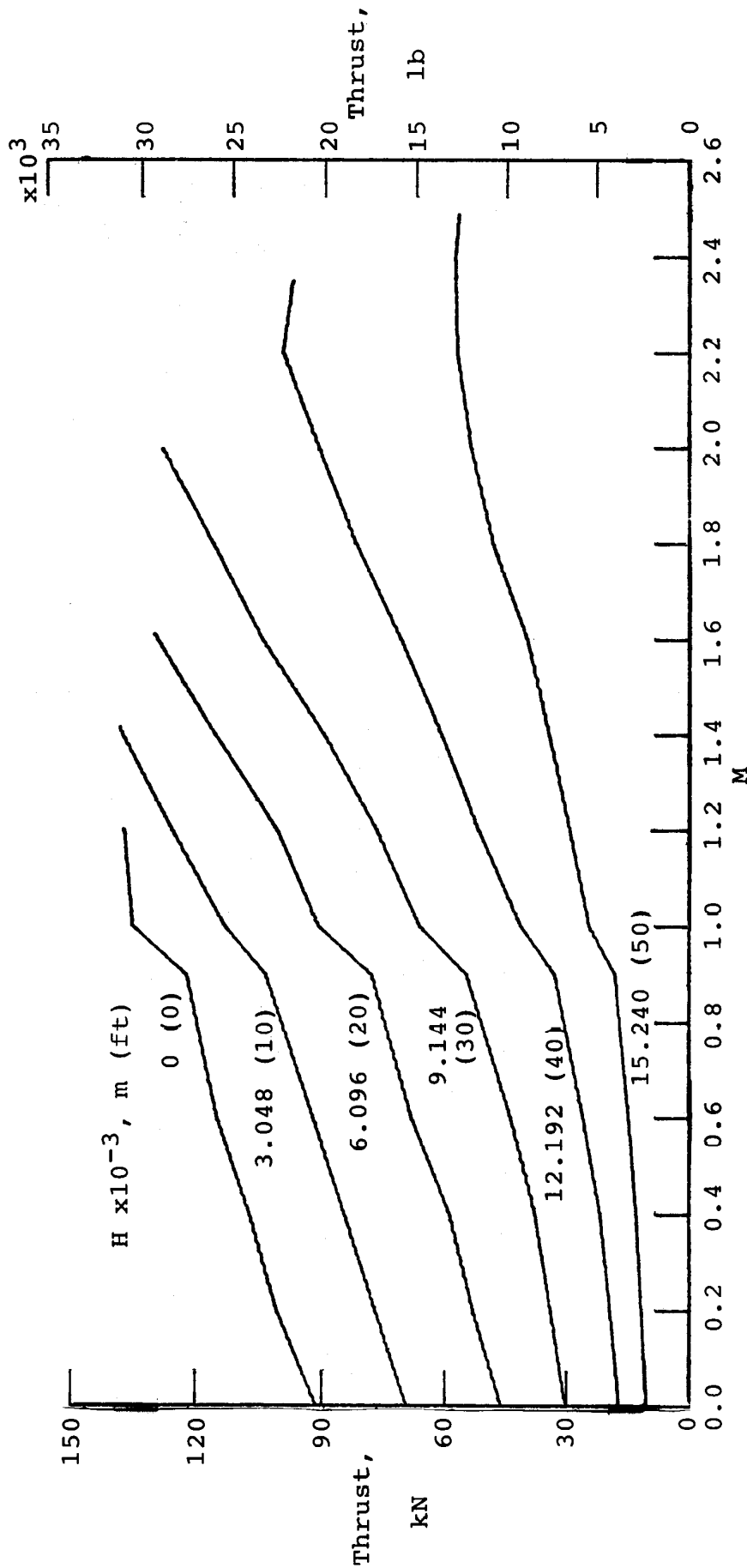

Figure 6. Net Thrust at maximum power for the F100 EMD engines in the F-15 HIDEC

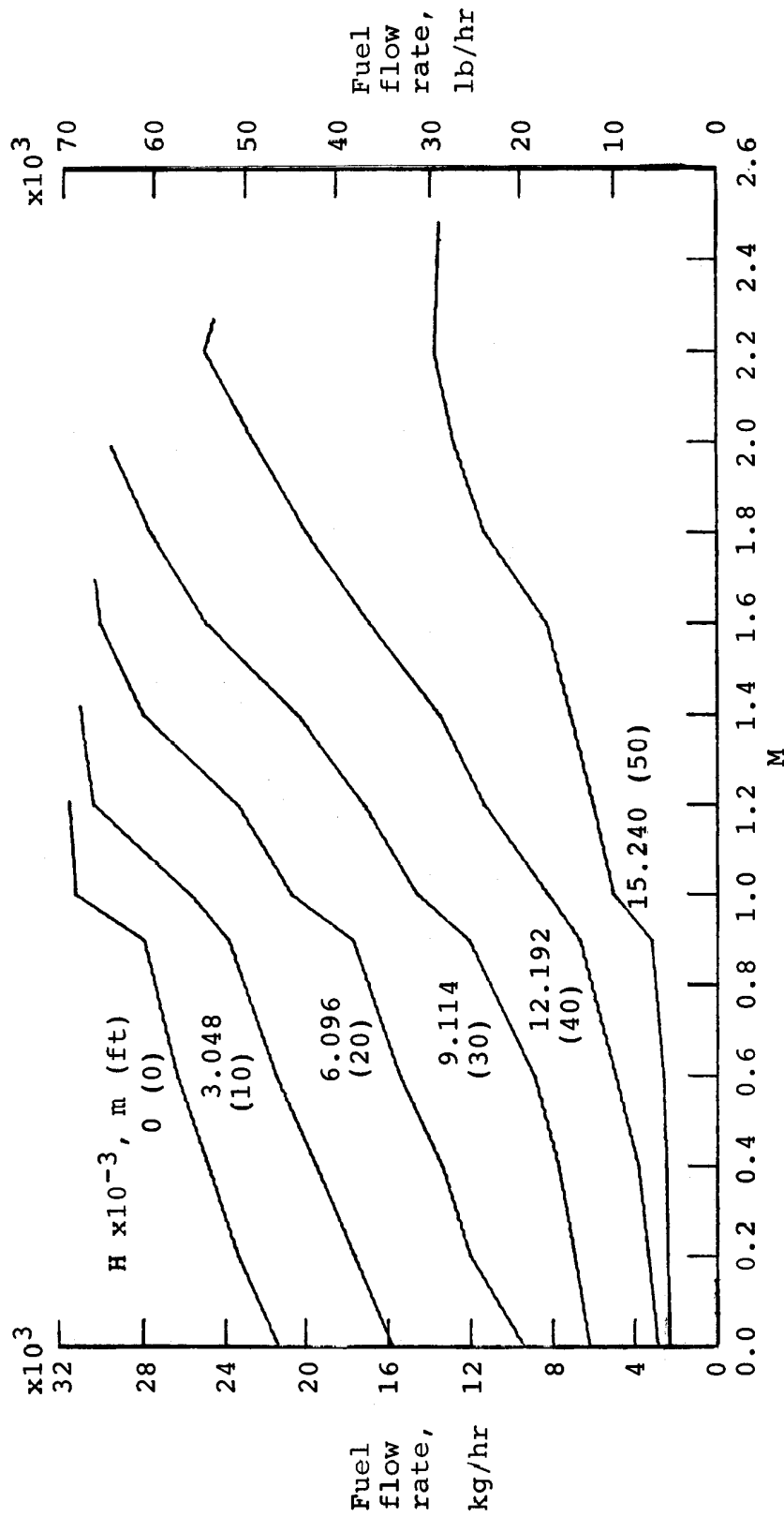

Figure 7. Total Fuel Flow Rate at maximum power for the F100 EMD engines in the F-15 HIDE C

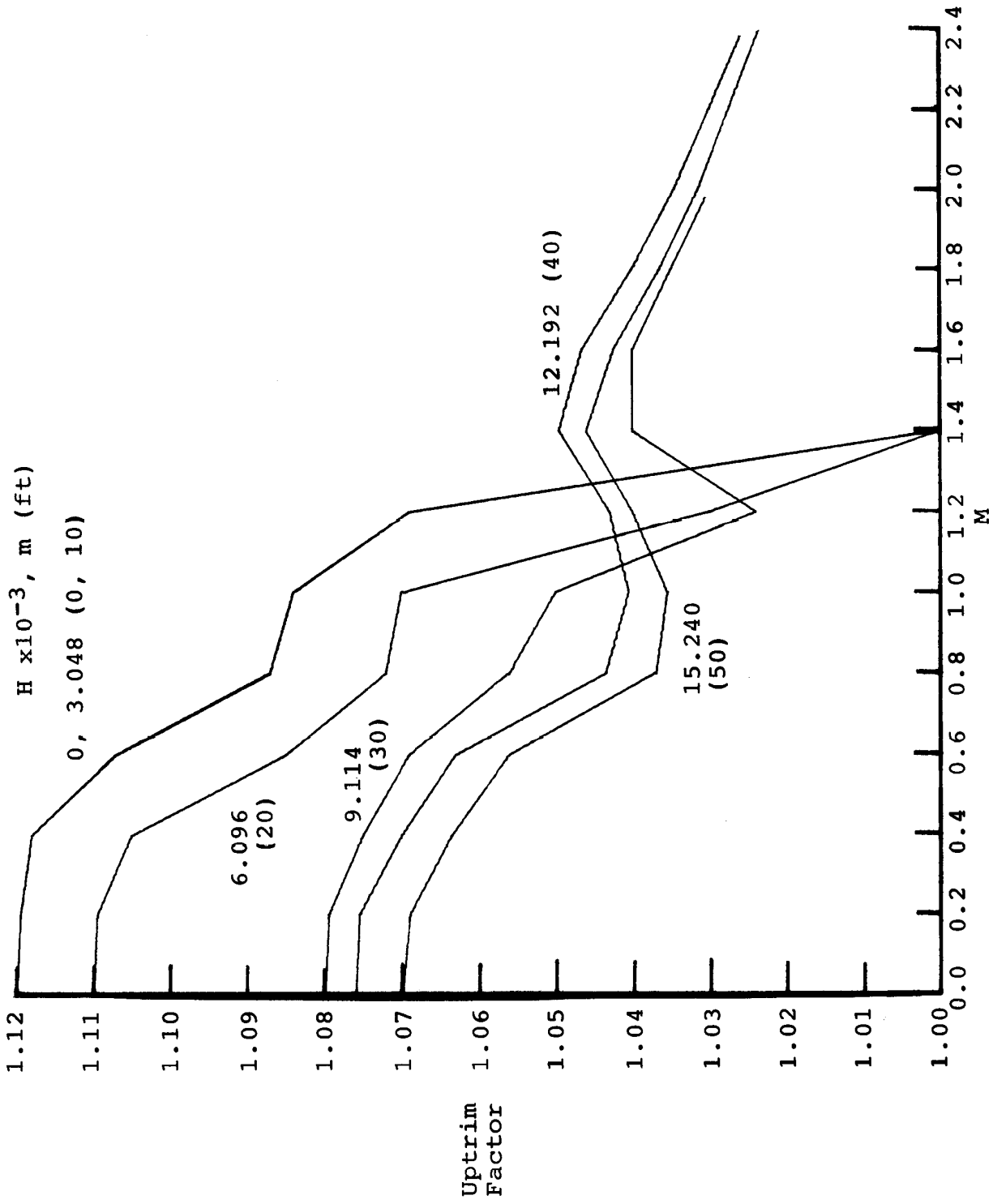

Figure 8. Uptrim adjustment factor for the F100 EMD engine

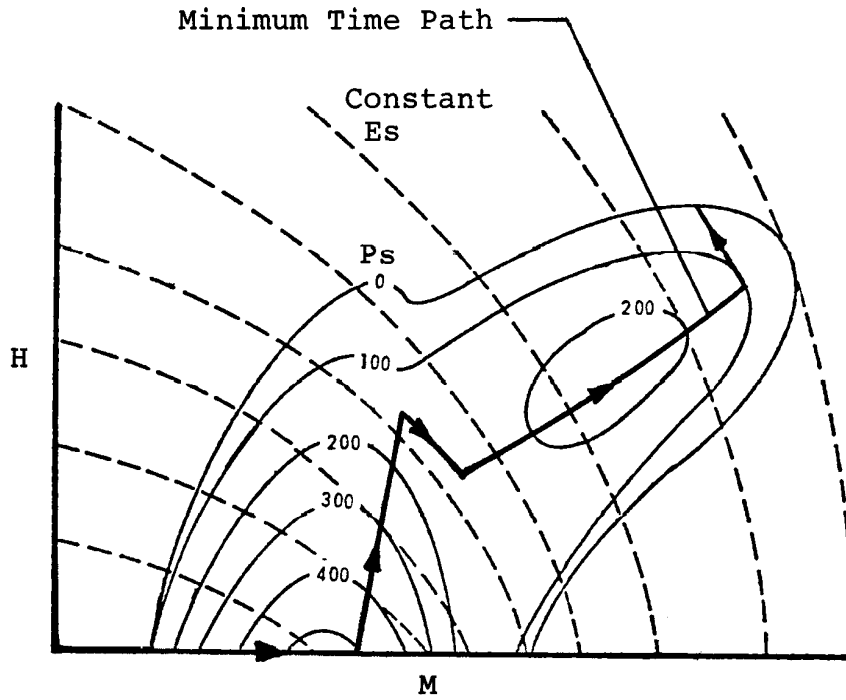

Figure 9. Minimum time path on plot of Ps and constant energy

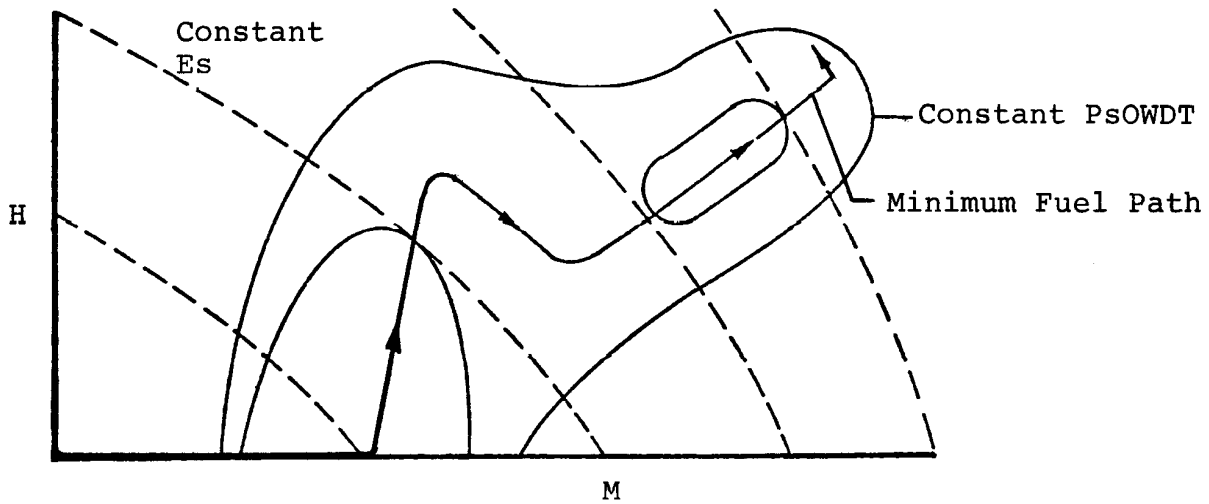

Figure 10. Minimum fuel path on plot of PsOWDT and constant energy

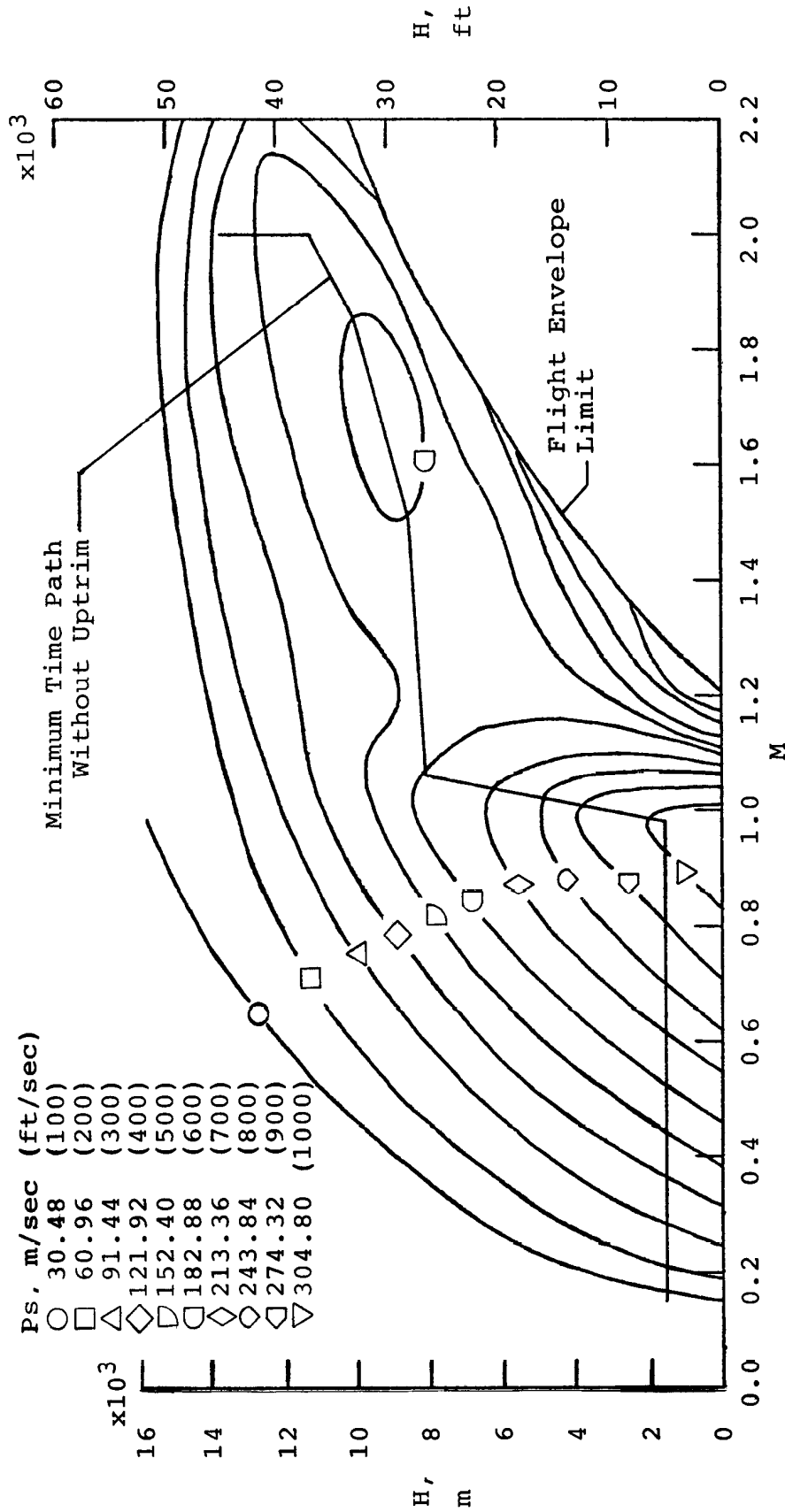

Figure 11. Ps contours for the F100 EMD powered F-15, maximum power, 1 g, standard day, without uptrim, with minimum time path

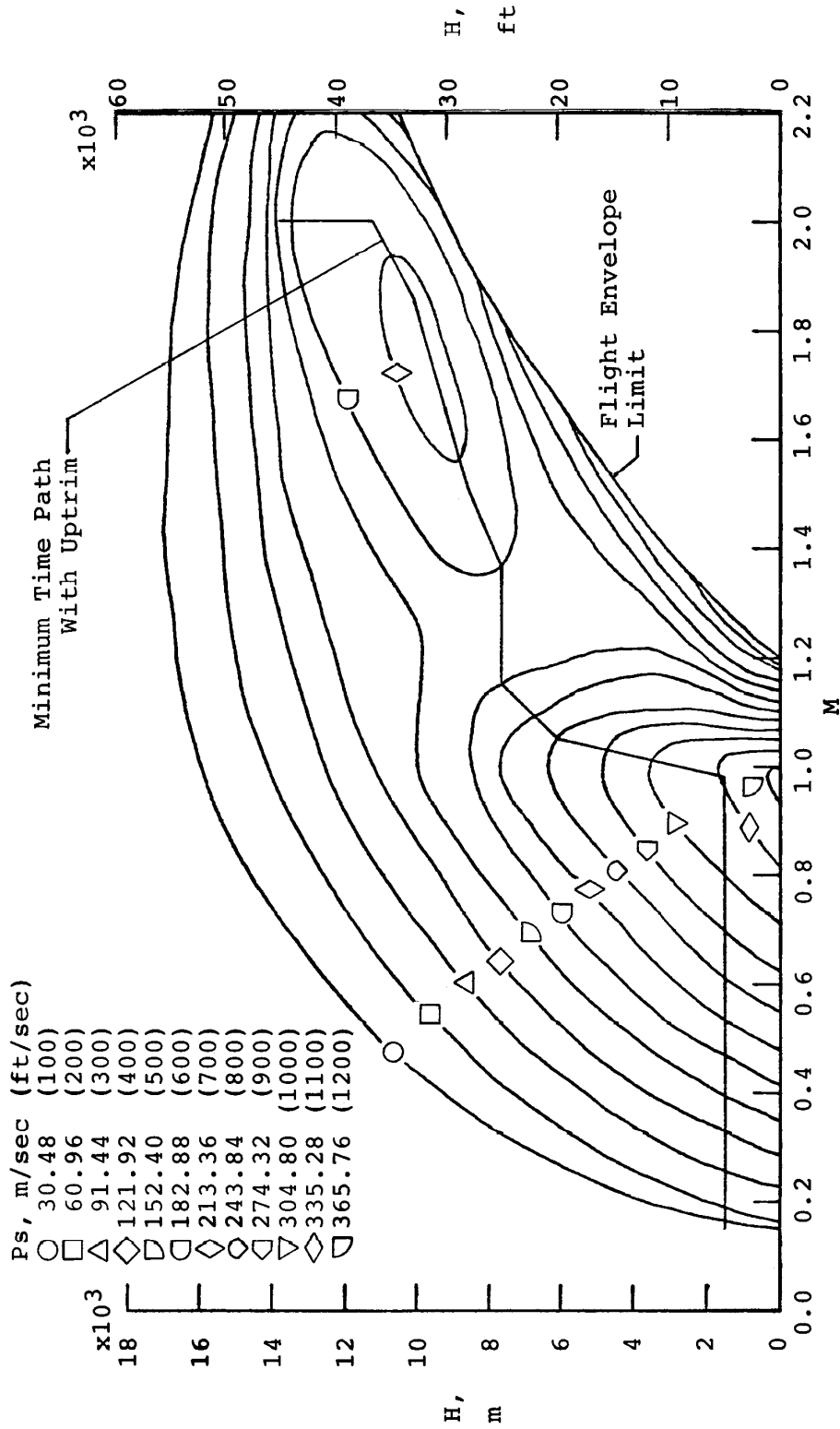

Figure 12. Ps contours for the F100 EMD powered F-15, maximum power with uptrim, 1 g, standard day, with minimum time path

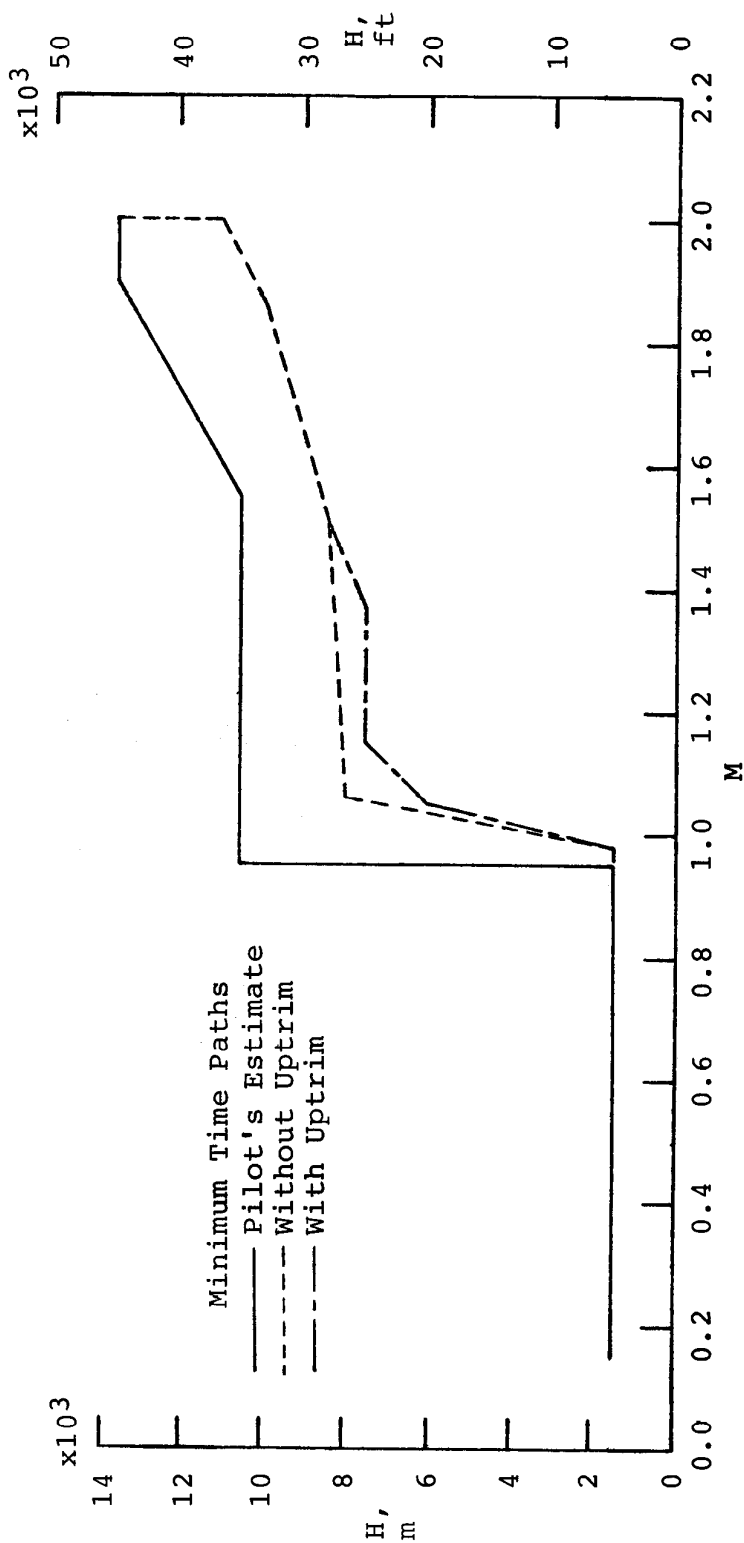

Figure 13. Comparison of HIDEc minimum time paths to the pilot's estimate

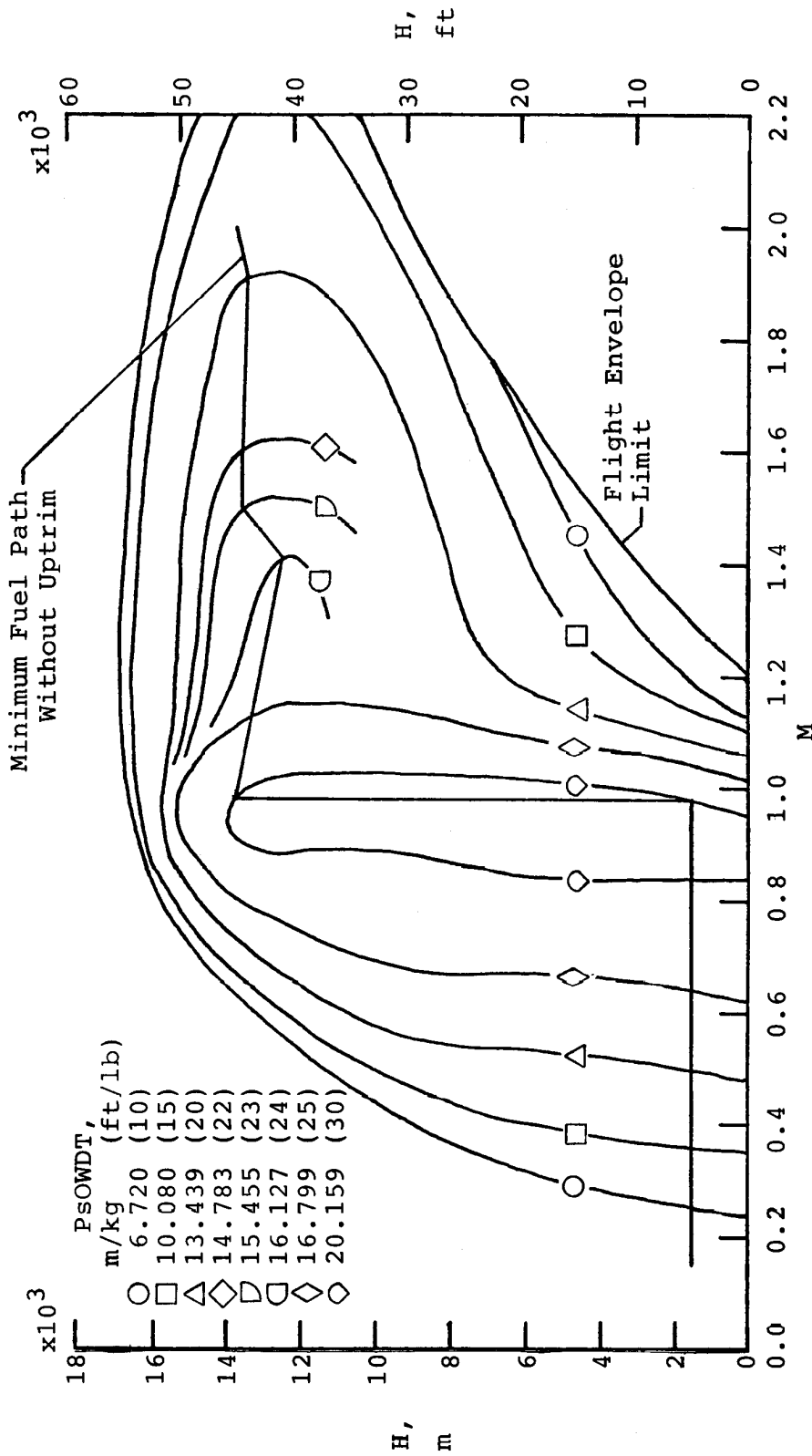

Figure 14. PsOWDT contours for the F100 EMD powered F-15 without uptrim, maximum power, standard day, 1 g, and minimum fuel path

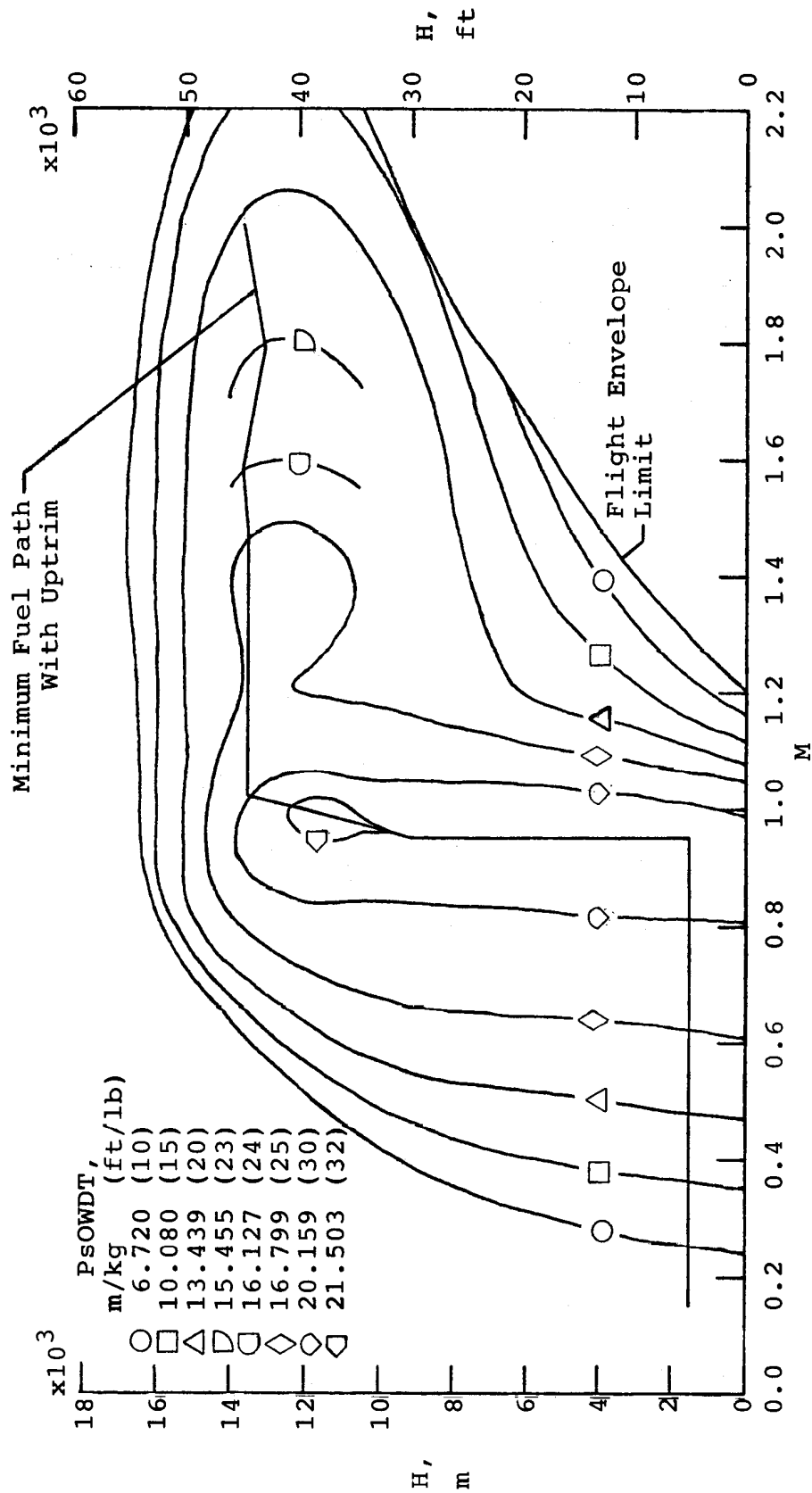

Figure 15. PsOWDT contours for the F100 EMD powered F-15 with uptrim, maximum power, standard day, 1 g, and minimum fuel path

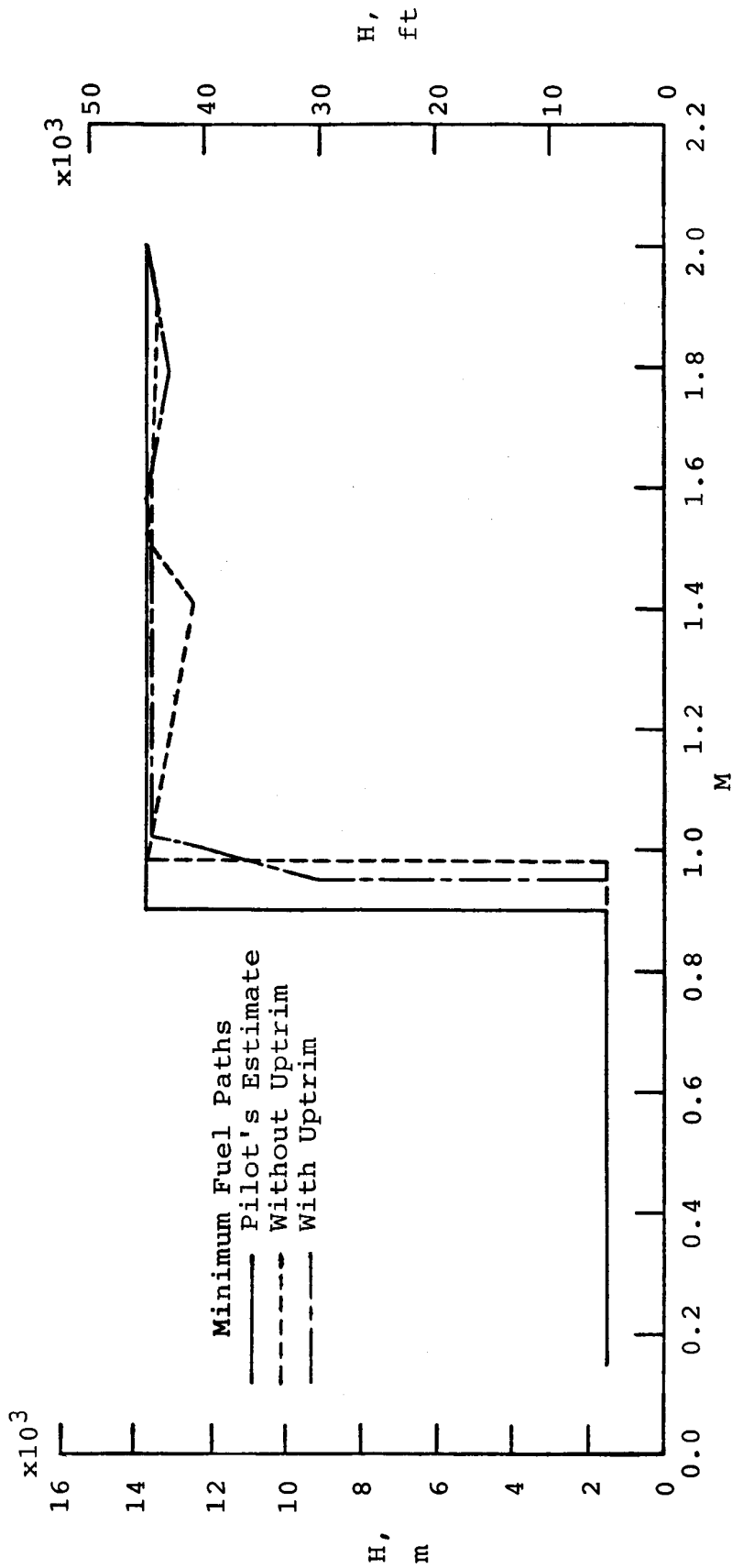

Figure 16. Comparison of HIDE minimum fuel paths with and without uptrim to the pilot's estimate

| | | | | | |
|--------------------------------------------------------------------------------------------------------------------------------------------------------------------------------------------------------------------------------------------------------------------------------------------------------------------------------------------------------------------------------------------------------------------------------------------------------------------------------------------------------------------------------------------------------------------------------------------------------------------------------------------------------------------------------------------------------------------------------------------------------------------------------------------------------------------------------------------------------------------------------------------------------------------------------------------------------------------------------------------------------------------------------------------------------------------------------------------------------------|--|------------------------------------------------------|--------------------------------------------------------------------------------------------------------------------------------------------------------------------------------------------------------------------------|-------------------------------------------------------------------|------------------|
| 1. Report No. NASA TM-86042 | | 2. Government Accession No. | | 3. Recipient's Catalog No. | |
| 4. Title and Subtitle Minimum Time and Fuel Flight Profiles for an F-15 Airplane With a Highly Integrated Digital Electronic Control (HIDEC) System | | | | 5. Report Date June 1984 | |
| | | | | 6. Performing Organization Code | |
| 7. Author(s) Edward A. Haering, Jr., and Frank W. Burcham, Jr. | | | | 8. Performing Organization Report No. H-1242 H-1243 | |
| 9. Performing Organization Name and Address NASA Ames Research Center Dryden Flight Research Facility P.O. Box 273 Edwards, California 93523 | | | | 10. Work Unit No. | |
| | | | | 11. Contract or Grant No. | |
| 12. Sponsoring Agency Name and Address National Aeronautics and Space Administration Washington, D.C. 20546 | | | | 13. Type of Report and Period Covered Technical Memorandum | |
| | | | | 14. Sponsoring Agency Code RTOP 533-02-21 | |
| 15. Supplementary Notes | | | | | |
| 16. Abstract A simulation study was conducted to optimize minimum time and fuel consumption paths for an F-15 airplane powered by two F100 Engine Model Derivative (EMD) engines. The benefits of using variable stall margin (uptrim) to increase performance were also determined. This study supports the NASA Highly Integrated Digital Electronic Control (HIDEC) program. The basis for this comparison was minimum time and fuel used to reach Mach 2 at 13,716 m (45,000 ft) from the initial conditions of Mach 0.15 at 1524 m (5000 ft). Results were also compared to a pilot's estimated minimum time and fuel trajectory determined from the F-15 flight manual and previous experience. The minimum time trajectory took 15 percent less time than the pilot's estimate for the standard EMD engines, while the minimum fuel trajectory used 1 percent less fuel than the pilot's estimate for the minimum fuel trajectory. The F-15 airplane with EMD engines and uptrim, was 23 percent faster than the pilot's estimate. The minimum fuel used was 5 percent less than the estimate. | | | | | |
| 17. Key Words (Suggested by Author(s)) Optimum trajectories F-15 airplane HIDEC F100 EMD engine | | | 18. Distribution Statement Unclassified-Limited All requests should be referred to NASA Ames Research Center, Dryden Flight Research Facility, P.O. Box 273, Mail Stop OFA, Edwards, California 93523 | | |
| 19. Security Classif. (of this report) Unclassified | | 20. Security Classif. (of this page) Unclassified | | 21. No. of Pages 22 | 22. Price A02 |

*For sale by the National Technical Information Service, Springfield, Virginia 22161.

TABLE 1. - TIME AND FUEL FOR MINIMUM TIME PATHS

| Minimum time paths | Time | | Fuel | |
|--------------------|------|--------------------|-------------|--------------------|
| | Min. | Percent difference | kg (lb) | Percent difference |
| Pilot's estimate | 2.97 | ----- | 1789 (3944) | ----- |
| Without uptrim | 2.54 | -15 | 1949 (4297) | +8 |
| With uptrim | 2.28 | -23 | 1881 (4146) | +5 |

TABLE 2. - TIME AND FUEL FOR MINIMUM FUEL PATHS

| Minimum fuel paths | Time | | Fuel | |
|--------------------|------|--------------------|-------------|--------------------|
| | Min. | Percent difference | kg (lb) | Percent difference |
| Pilot's estimate | 4.15 | ----- | 1755 (3870) | ----- |
| Without uptrim | 3.54 | -15 | 1735 (3826) | -1 |
| With uptrim | 3.32 | -20 | 1659 (3658) | -5 |

SUMMARY

A simulation study was conducted to optimize minimum time and fuel consumption paths for an F-15 airplane powered by two F100 Engine Model Derivative (EMD) engines. The benefits of using variable stall margin (uptrim) to increase performance were also determined. This study supports the NASA Highly Integrated Digital Electronic Control (HIDEC) program. The basis for this comparison was minimum time and fuel used to reach Mach 2 at 13,716 m (45,000 ft) from the initial conditions of Mach .15 at 1,524 m (5,000 ft). Results were also compared to a pilot's estimated minimum time and fuel trajectory determined from the F-15 flight manual and previous experience. The minimum time trajectory took 15 percent less time than the pilot's estimate for the standard EMD engines, while the minimum fuel trajectory used 1 percent less fuel than the pilot's estimate for the minimum fuel trajectory. The F-15 with EMD engines with uptrim was 23 percent faster than the pilot's estimate and its minimum fuel used 5 percent less fuel than the estimate.