X-29 Flight-Research Program

Terrill W. Putnam

January 1984

NASA Technical Memorandum 86025

X-29 Flight-Research Program

Terrill W. Putnam

NASA Ames Research Center, Dryden Flight Research Facility, Edwards, California 93523

1984

NASA

National Aeronautics and
Space Administration

Ames Research Center

Dryden Flight Research Facility
Edwards, California 93523

X-29 FLIGHT-RESEARCH PROGRAM

Terrill W. Putnam*
NASA Ames Research Center, Dryden Flight Research Facility
Edwards, California

Abstract

The X-29A aircraft is the first manned, experimental high-performance aircraft to be fabricated and flown in many years. The approach for expanding the X-29 flight envelope and collecting research data is described including the methods for monitoring wing divergence, flutter, and aero-servoelastic coupling of the aerodynamic forces with the structure and the flight-control system. Examples of the type of flight data to be acquired are presented along with types of aircraft maneuvers that will be flown. A brief description of the program management structure is also presented and the program schedule is discussed.

Introduction

The X-29A aircraft is the first manned, experimental high-performance aircraft to be fabricated and flown in many years. As such, it provides a rare opportunity to validate the entire aircraft design process by careful correlation and comparison of flight-test results with wind-tunnel results and design predictions. An audit trail, linking the analysis, design, and fabrication with the ground and flight testing, is being developed as an overall element of the X-29 program. NASA and DOD have developed and are implementing a series of analytical efforts, wind-tunnel tests, and the flight-research program to more fully exploit this opportunity.

The X-29A (Fig. 1) is a radical design and incorporates several emerging and unproven technologies. Thick composite wing covers on a thin supercritical swept-forward wing utilizing aeroelastic tailoring are used as a means of controlling divergence. The aircraft also has a closely coupled canard placed immediately ahead of the wing. The wing leading edge is fixed, and double-hinged, trailing-edge flaperons provide high lift during takeoff and landing, lateral control, and variable camber to maximize lift/drag ratio over the flight envelope. The final portion of the aft-body strake also is variable and thus provides the aircraft with three-surface longitudinal control. The X-29A is 35% statically unstable longitudinally and is controllable only through the use of an advanced, digital fly-by-wire flight control system (FCS). The predicted aerodynamic advantages of the X-29A configuration are what make the risk of developing and flying a new airplane worthwhile. It is, therefore, imperative that the wing aerodynamic characteristics be accurately determined. The flying qualities of this highly augmented, highly unstable aircraft, coupled with the canard/wing aerodynamic characteristics, are likely to be significantly different from those of more conventional fighter aircraft.

Analytical predictions and projections of wind-tunnel test results indicate that the various advanced technologies incorporated in the X-29A

*Chief, Aeronautics Branch.

This paper is declared a work of the U.S. Government and therefore is in the public domain.

will provide substantial improvements. These advancements are significant when considered individually; however, their collective effect is expected to be even greater when they are combined in the X-29A flight vehicle. This combination of technologies will also result in a special challenge to the X-29 researchers to develop methods of extracting the individual technological benefits in order that they may be properly assessed.

Technical Background

Extensive analyses and studies of the forward-swept wing design were conducted under the direction of the Air Force Flight Dynamics Laboratory by Rockwell, General Dynamics, and Grumman.¹⁻⁴ Trade-off studies were conducted between forward- and aft-swept wing designs for selected mission requirements, wind-tunnel tests were run, and final designs were developed. These studies showed that a number of potential benefits could be derived from a forward-swept wing design. The benefits predicted are:

- 1) improved lateral control at high angles of attack because of inboard spanwise flow and subsequent delayed tip stall;
- 2) a reduction in wing-profile drag for the forward-swept wing relative to an aft-swept wing with the same shock-sweep angle, which results in a 13% reduction in total drag;
- 3) a decrease in wing structural box weight or an increase in aerodynamic efficiency because of the geometrical differences in forward- and aft-swept wing designs with the same shock-sweep angle;
- 4) increased fuselage design freedom with aft placement of the wing box which permits more efficient fuselage contours to minimize wave drag;
- 5) reduced trim drag owing to less wing twist required for a forward-swept design; less wing twist also reduces manufacturing complexity and cost; and
- 6) forward-swept wings exhibit a higher flutter speed than divergence speed and, therefore, offer the potential for stores carriage without incurring flutter-speed restriction.

These and other results have been summarized and generalized into the following advantages:

- 1) gross weight reductions of 5% to 30% depending on design and mission requirements;
- 2) significantly improved low-speed STOL and high-angle-of-attack control capabilities;
- 3) improved internal packaging;
- 4) substantially reduced drag and improved maneuver characteristics at transonic maneuvering flight conditions; and

5) increased design freedom for the aircraft designer.

All of the projected benefits of forward-swept wing technology are not expected to accrue to the X-29A because of the compromises that were made to keep the cost within program limits. The specific technologies that were designed into the X-29A and the projected payoffs are

- 1) a forward-swept wing, designed and fabricated with advanced graphite composite covers, for which aeroelastic tailoring is used to control structural divergence;
- 2) a thin supercritical airfoil that provides reduced transonic cruise and maneuver drag;
- 3) trailing-edge, double-hinged flaperons which provide camber control efficiency approaching that of smooth variable camber;
- 4) a statically unstable configuration with an all movable, close-coupled canard in conjunction with high-authority strake flaps and trailing-edge flaperons for minimization of trim drag across the flight envelope;
- 5) a triplex, digital flight-control system that provides for vehicle control and redundancy to explore safely the relaxed static stability configuration; and
- 6) approach and landing flight-control mode to exploit the projected STOL capabilities.

The X-29A was designed and fabricated primarily on the basis of aerodynamic and structural computer design codes, with a minimal amount of wind-tunnel testing and configuration development. Thus, the success of the X-29A design relies heavily on the analytical design codes and methods.

Aircraft Description

The X-29A is a single-seat fighter-type aircraft that is powered by a single F404-GE-400 engine. The wingspan is 27 ft, the length is 48 ft, and the weight is 16,000 lb; the aircraft is designed to fly at moderate supersonic speeds. The X-29A was designed to use parts from many existing aircraft in an effort to minimize the cost. An F-5A forward fuselage module, F-16 main landing gear, and F-16 flight control actuators are among the major elements incorporated into the X-29A.

Research Objectives

The broad program objective is to demonstrate, through flight, the feasibility of the forward-swept wing design, and to develop confidence in the design and in the related advanced technologies so that they may be considered as design options for future military air vehicles. The X-29A aircraft is an experimental test-bed that is extensively instrumented and that provides an opportunity to evaluate the advanced structural, aerodynamic and flight-control concepts incorporated in the aircraft. Significant effort is being expended to acquire flight data that will provide the final link in the audit trail connecting the analysis, design, fabrication, ground tests, and final flight-test results.

The broad overall research objective is to improve the analysis, design, and test methods used in the aircraft design process by extensive measurement of the aircraft characteristics and careful comparison and correlation of the flight measurements with the analyses, design, and ground-test results. The specific flight-research objectives are as follows:

- 1) Compare and correlate concurrent wing-load and deflection measurements with divergence analyses, design criteria, and ground-test results.
- 2) Compare and correlate flutter accelerometer and flight-control system measurements with flutter, buzz, and aeroservoelastic analyses, design criteria, and ground-test results.
- 3) Compare and correlate structural load and deflection measurements, for symmetric maneuvers up to 80% of design limit load, with analytical structural model predictions and proof-load test results.
- 4) Measure the total aircraft lift and drag for comparison with wind-tunnel results. Comparison of the lift, drag, and sustained-g capability at the maneuver design points - 0.9 M, 30,000 ft and 1.2 M, 30,000 ft - with predictions.
- 5) Establish the wing aerodynamic characteristics through the careful measurement of surface pressure and structural deflections for correlation with computational aerodynamic codes and wind-tunnel results.
- 6) Establish aerodynamic stability and control characteristics by careful measurement of control-system performance and aircraft dynamic response for comparison with the design criteria and simulation results.
- 7) Establish the flying qualities for both open-loop and closed-loop tasks for comparison with existing criteria.
- 8) Evaluate and document approach and landing performance and characteristics for correlation with design goals.

Technical Approach

The approach to be used to develop confidence in the forward-swept wing and related technologies is to validate the design, analyses, and test method by correlating and comparing them with the flight-research results. A conceptual diagram of this process is shown in Fig. 2. Careful analysis of the instrumentation requirements, flight-test points, and maneuvers were conducted to ensure that data of sufficient quality and quantity will be acquired to validate the design, fabrication, and test process.

The flight-research data will be obtained in incremental steps of the critical variables. Each flight-test point will have been thoroughly investigated and practiced on the Dryden simulator to ensure the highest quality of data. Analytical models and wind-tunnel data will be used to predict results at the planned test points. The analytical models and simulations will be updated with actual flight results as necessary to improve predictive accuracy and the ability to fly the test points.

For example, the NASTRAN structural model will probably be updated with actual wing deflections, and the piloted simulator aerodynamics will be updated with flight-determined stability derivatives.

The approach to the flight-research program will also require that one test point on a given flight repeat or overlap a test point from the preceding flight to ensure the integrity of the data system and test method. The test program will also be structured so that alternative test objectives can be addressed on a particular flight if the primary test objectives cannot be met because of operational considerations or data system failures. An integrated series of maneuvers will be performed at each test condition to maximize the efficiency of the data acquisition. This will allow multiple objectives to be addressed on a flight; however, all test objectives will not be addressed on each flight.

The types of maneuvers that will be used to assess flight worthiness and evaluate X-29A technologies are as follows:

- 1) Stick raps, natural turbulence, and the flap-tab excitation system at steady-state test points to assess flutter, buzz, and aeroservoelasticity characteristics.
- 2) Wind-up turns to assess divergence, buffet, loads, and performance.
- 3) Pushover/pullups to acquire data for aircraft performance determination.
- 4) Level accels and decels to gather performance data and for airspeed calibrations.
- 5) Stability and control pulses in all areas for extracting aerodynamic derivatives and determining aircraft flying qualities and control-system performance.
- 6) Flying in formation and in trail, simulating refuelings, and tracking a target during a wind-up turn will be used to evaluate closed-loop handling qualities.

The exact determination of maneuvers, aircraft configuration, and test conditions for each flight will depend on the analysis and ground tests conducted before the flight-test program begins and will depend on the results and analyses of data from previous flights. However, it is expected that the flight-test program will proceed as discussed below and as presented in the schedule.

The flight program consists of three distinct elements. The first element concentrates on expanding the flight envelope in terms of Mach number, dynamic pressure, load factor, flutter, and divergence. Research data will be acquired as a secondary objective where possible, but the emphasis will be on envelope expansion.

The second and third elements of the flight program are dedicated to acquiring flight-research data within the cleared aircraft flight envelope. Those instrumentation parameters that were not activated during the first flight phase will be operational to support the research data acquisition activity. A more detailed description of the phasing of these elements is contained in the Schedule section of this document.

The approach to meeting the flight-research objectives is detailed in the following paragraphs.

Objectives 1 and 3. Shown in Fig. 3 are the general locations of the strain-gage instrumentation available for shear, bending, and torque measurements. Shown in Fig. 4 are the locations of the optical deflection measurement system and the pressure-survey orifices that can be integrated to obtain the aerodynamic loads on the wing and canard. Flight-measured loads will be used to correlate with the pressure-distribution data, with predicted loads at the maneuver design points, and with the deflection data at the maneuver design conditions. Strain gages located in the wings, canards, fuselage, etc. will be calibrated using an extensive set of ground-test load cells in distributed-loads ground tests. Structural influence coefficients will be developed so that loads and deflections may be calculated for correlation with the analytical structural model of the airplane. The modified Southwell method⁵ and direct deflection measurements will be used to assess the divergence tendencies of the wing and for correlation with predictions. Representative examples of the types of divergence and loads correlations that will be accomplished are shown in Figs. 5 and 6, respectively. Shown in Fig. 7 is the type of comparison to be accomplished between predicted and measured streamwise twist of the wing as a function of wing span. Direct measures of the wing twist at a variety of flight conditions will be made using the optical deflection measurement system.

Objective 2. The location of the accelerometer installations is shown in Fig. 8. The structural response as measured by the accelerometers will be correlated with the results of the ground vibration survey and with the limit cycle tests. The flight-measured structural response of the wing, canards, and vertical tail will be compared with the flutter predictions for those surfaces. The response of all the control surfaces will be analyzed for the effects of dynamic coupling between the structure, unsteady aerodynamic flow, and control-system dynamics. Any such aeroservoelastic effects discovered will be compared and correlated with design criteria and with analytical models. The dynamic characteristics of the double-hinged, trailing-edge flaps are of particular interest because of the lack of substantiated analyses and models of these types of structure. Of particular interest will be the comparison of the in-flight response with the criteria for both buzz and flutter. It has been predicted, on the basis of very limited analyses, that coupling between the wing first bending mode and the short period of the airplane can occur at high dynamic pressure. Shown in Fig. 9 is an example of the types of dynamic data that will be extracted during the flight program for correlation with the predictions and with the transonic dynamics tunnel (TDT) test results.

Objective 4. The improvement in the transonic maneuver performance of the X-29A aircraft is one of the major claims made for forward-swept wing technology. A thorough investigation and documentation of the total airplane performance in terms of lift and drag will be performed. An example of the type of performance cross-plots to be made are shown in Fig. 10. Comparisons of flight-measured total lift and drag will be made where wind-tunnel results⁶ are available. It should be realized that the objective of the limited wind-tunnel testing accomplished during the program was to establish structural loads

and stability and control characteristics, not aircraft performance. Therefore, the amount and quality of wind-tunnel performance data are limited. The flight-derived lift and drag will be developed using Dryden's performance analysis program (PAP). The PAP will be used in conjunction with a GE thrust deck to calculate absolute values of thrust and drag. Determining the lift-drag characteristics of the X-29A will require obtaining flight data over the entire Mach-number/altitude flight envelope so that development of the lift-drag model will adequately represent the test airplane. The lift-drag model will have three independent variables, for a fixed flap/strake position, and can be represented as follows:

$$C_D = F(C_L, M, \bar{q})$$

Dynamic test techniques will be used to produce the largest ranges of C_L and data possible for the least expenditure of fuel and flight time. An installed ground-thrust calibration of the airplane and propulsion system will be required to "calibrate" the thrust deck. Other performance characteristics of the X-29A will also be measured and compared with analyses, wind-tunnel results, and simulations. These include such factors as turn rate, turn radius, and excess energy. Shown in Fig. 11 are conceptual examples.

Objective 5. The interactive effects of the close-coupled wing and canard and the characteristics of the advanced, thin supercritical airfoil will be assessed by measuring pressure distributions and lifting-surface deflections. These pressure distributions, derived wing lift, drag characteristics, and wing deflections will be correlated with wind-tunnel data taken in the wind tunnels at Ames Research Center and with the data that will be acquired in the National Transonic Facility (NTF) at full-scale Reynolds number. Conceptual examples of the pressure-distribution comparisons are shown in Fig. 12 along with correlations of the span-load distribution between wind tunnel and flight. Detailed pressure distributions are needed in order to understand differences in overall vehicle performance that may be observed in the performance testing. Leading-edge pressure peak, local pressure gradients, shock-wave locations, and areas of separated flow over the wing and canard upper surfaces will be identified using the pressure distributions. One hundred fifty-six pressure orifices are located on the left wing and strake at positions identical to those on the wind-tunnel models. An additional 17 pressure orifices are located on the left-hand canard. Figure 4 shows the location of each row of orifices. Because of the flexibility of the X-29A aircraft, interpretation of the pressure data requires knowledge of the local angle of incidence of the wing section at each of the chords along which pressure data are taken. The optical deflection measurement system discussed earlier will provide the measure of bending and twisting that the wing undergoes at each flight condition.

Objective 6. Trim data; aerodynamic coefficients, using the modified maximum likelihood estimator (MMLE) computer program;⁷ longitudinal stability and control characteristics for $\alpha < 20^\circ$; and lateral directional stability and control characteristics will be determined from flight data. The effects of aeroelasticity will be evaluated by determining the aerodynamic coefficients at a given Mach number over a range of dynamic pressures. An

attempt will be made to determine the rigid aerodynamics from the extrapolation of the trend with decreasing dynamic pressure. Control-system pulses will be used to excite vehicle responses for later processing using the MMLE program. In general, maneuvers will be performed in 1-g flights over a range of altitudes to produce a broad angle-of-attack variation. Also, maneuvers will be performed at elevated load factors to ensure that aerodynamic coefficients are obtained with the proper deformed wing shape. These flight data will be compared with wind-tunnel and various analytical predictions, including those obtained from FLEXTAB.⁸ Buffet data will also be acquired at elevated load factors from the various aircraft-mounted accelerometers for correlation with criteria and prediction methods that have been developed for aft-swept wing configurations. Buffet-onset and buffet-intensity characteristics will be compared with those of existing modern fighter aircraft. Conceptual examples of the comparison of the buffet characteristics and the stability and control characteristics are illustrated in Figs. 13 and 14, respectively.

Measurements of the control-system performance will also be acquired from the control-system computers. Gain and phase margins, control-law stability, transient response during flight-control mode changes, and aircraft dynamic response will be compared with design criteria and the various simulation results. Flight-control tasks will also include the evaluation of the control laws using the full-authority, high-rate canard to provide vehicle stability. The benefits and drawbacks of the three-surface control design will also be assessed. In addition, the different control modes will be evaluated and compared with the simulations; these modes include normal, digital reversion, analog reversion, and power approach control.

Objective 7. The flying qualities of the X-29A will be evaluated using a variety of tasks. These tasks include formation flying, flying in trail, simulated refueling, simulated short takeoff and landing (STOL) approaches, takeoff and landing, and tracking of a target airplane. A selected combination of flight-control modes and tasks will be selected for evaluation by several pilots. The effects of the high-authority, rapid-rate canard and of the strake flaps will be evaluated. Comparisons of the flight handling qualities with the flying qualities predicted by the various simulations will be made. The various flying-qualities simulations include the total in-flight simulator (TIFS) in-flight simulation, the contractors moving base simulation, the USAF's Lamars simulation, and the NASA Ames Flight Simulator for Advanced Aircraft (FSAA). Comparisons of the X-29A flying qualities with the MIL STD 8785C will also be made with an assessment of the applicability of the standard to a highly relaxed static stability airplane like the X-29A. Shown in Fig. 15 is a typical example of the handling-qualities assessment that will be accomplished.

Objective 8. The standard approach and landing characteristics of the X-29A aircraft will be documented in terms of approach speeds, attitudes, sink rates, and glide-slope angles. Because tail-strike angles and visibility restrictions preclude testing of actual approaches followed by landing, the predicted STOL benefits will be assessed in simulated approaches at altitude. Therefore, approach speeds, attitudes, sink rates, etc., and flying qualities will be evaluated at altitude. Actual

standard approach and landing characteristics will be acquired and compared with those predicted analytically and with the TIFS.⁹

Instrumentation

A block diagram of the core of the X-29A instrumentation system is shown in Fig. 16. The locations of many of the sensors that tie into this system have been previously illustrated. It should be noted that the system includes five pulse-code-modulation (PCM) systems, the outputs of which are merged by the digital interleaver for subsequent transmission to the ground station. It should also be observed that because of volume constraints, there is no on-board recording capability.

The measurands on the airplane have been divided into six different groups. These groups and the measurands included in each group are shown in Fig. 17. The numbers in parentheses are the number of measurements of each type being made.

Test Requirements

In support of the flight-research objectives that have been established herein, additional testing is required in order that the objectives can be achieved. These tests are primarily ground tests with the exception of the air-data calibrations, which are flight tests. A list of the required tests follows:

- 1) Weight and balance: weight and center-of-gravity position are required as a function of fuel state.
- 2) Inertias: X-29A moments and products of inertia must be measured; fuel effects on the inertias have to be estimated.
- 3) Ground vibration tests: these tests are required to determine the structural modes of the vehicle.
- 4) Limit cycle tests: these tests are required to determine the tendency for control-system/structural-limit cycles. This is a closed-loop phenomenon resulting from interactions between the hydraulic system, flight-control sensors, and the structure.
- 5) Distributed-loads tests: these distributed-load structural tests are required to validate the NASTRAN model.
- 6) Systems evaluation tests: in these tests, the flight-control computers are tied into a simulation of the aerodynamics. All control laws are exercised as they would be in flight.
- 7) Strain-gage calibration tests: strain gages were installed on the canard, wing, vertical tail, and fuselage. The output of these sensors must be calibrated to permit a correlation of measured strains with wing loads and aeroelastic deflections.
- 8) Dryden ground simulation: the Dryden fixed-base six-degree-of-freedom simulation will be used

for control-law validation, flight planning and pilot proficiency.

9) Verification wind-tunnel tests: these tests were conducted in the Unitary Plan 11- by 11-foot Transonic and the 9- by 7-foot Supersonic wind tunnels at Ames Research Center. These tests provided basic stability and control data from which most of the predicted aerodynamics were computed. Additional tests will be conducted in the National Transonic Facility.

10) Inlet wind-tunnel tests: a scale model of the X-29A inlet and forward fuselage was tested at Ames Research Center to determine the performance of the inlet and any modifications that might be required for engine/inlet compatibility.

11) Airspeed tests: an accurate airspeed calibration is essential for research measurements. A Mach number accuracy of ± 0.005 over most of the flight envelope will be attempted by calibrating the Mach sensors using ground-based radar during constant-altitude accel-decels and using a pacer aircraft during trimmed-flight conditions.

Management

The X-29 flight program is managed within the structure illustrated in Fig. 18. A memorandum of understanding (MOU) between the Defense Advanced Research Projects Agency (DARPA) and NASA establishes the responsibilities and authority of the respective organizations with regard to the X-29 flight program. The day-to-day management responsibility has been delegated to the X-29 Project Office at Dryden.

The X-29 project manager will manage the program utilizing the matrix management setup shown in Fig. 19. Lead engineers are identified in each of the disciplines indicated to provide technical leadership on the program while remaining functionally attached and responsible to their disciplinary supervisors. Additional support in each of the disciplinary areas will be drawn from the Dryden functional organization, the Air Force Flight Test Center (AFFTC), Naval Air Test Center (NATC), Air Force Flight Dynamics Laboratory (AFFDL), the contractor, and others as appropriate.

Reporting

The timely and efficient communication of the results of the flight-test program to the U.S. aerospace community and to all the military branches is required to ensure that beneficial X-29A technologies are candidates for inclusion in the next generation of fighter aircraft. The following reporting mechanism will be used on the X-29 program:

- 1) Written flight reports after each flight to summarize test points, configuration, and significant observations.
- 2) Monthly letter reports summarizing the flight activity and indicating preliminary results.
- 3) Government/industry workshops where results are presented at the vugraph level.

4) Informal briefings by test team members, at Dryden and at other locations, of the preliminary results and conclusions.

5) A formal symposium will be held within 1 year after completion of the flight program to document the significant flight-research program results.

6) NASA contractor reports, technical reports, technical memoranda, Air Force reports, and Navy reports will be formally published documenting the final program results.

Schedule

The flight program has been divided into three elements, phase A, phase B, and phase C, as shown in the schedule (Figs. 20 and 21). The phase A objective is to do a limited envelope expansion, which includes the two design points (0.9 M, 30,000 ft; 1.2 M, 30,000 ft). A very limited performance and flying-qualities assessment will be accomplished within the "cleared" envelope followed by a Navy evaluation of the airplane as indicated. The objective of phase B is to complete the envelope expansion to the maximum Mach number, altitude, and 80% of design symmetric load factor. The data required for a complete characterization of the airplane will be gathered during phase C and will be the primary flight data base for correlation with ground-test and analytical results.

Concluding Remarks

The X-29 flight-research program provides a unique and timely opportunity to close the loop on the aircraft analysis, design, fabrication, and ground-and flight-test process. The flight-research program will provide the data necessary to validate and improve the entire aircraft design, fabrication, and test process for future aircraft. The advanced technologies incorporated in the X-29 are integrated in such a way that the total benefit is greater than the sum of the benefits of the individual technologies. The flight-research team is going to have a major challenge in measuring and quantifying the benefits attributable to individual technologies.

Government and industry have made a large commitment to meeting the objectives of the X-29 program, and they expect the results of the program to significantly expand the fighter technology data base. The X-29 flight-research team also has a special commitment to report and disseminate the results of the X-29 flight-research program in a timely manner. This will permit effective transition of the technology to cognizant government agencies and to the aerospace industry.

References

¹Krone, N. J. Jr., Forward Swept Wing Demonstrator. AIAA Paper 80-1882, August 1980.

²Robinson, M. R.; Robinson, D. A., Forward Swept Wing (FSW) Designs: A High Payoff Through Technology Integration. AIAA Paper 80-1884, August 1980.

³Spacht, G., The Forward Swept Wing: A Unique Design Challenge. AIAA Paper 80-1885, August 1980.

⁴Miller, B. D.; Hadley, S. K., Application of Forward Swept Wings to an Air Combat Fighter. AIAA Paper 83-1833, July 1983.

⁵Ricketts, Rodney, H.; Doggett, Robert V. Jr., Wind Tunnel Experiments on Divergence of Forward-Swept Wings. NASA TP-1685, August 1980.

⁶Budd, Gerald, Locally Linearized Longitudinal and Lateral-Directional Aerodynamic Stability and Control Derivatives for the X-29A Aircraft. NASA TM-84919, 1983.

⁷Iloff, Kenneth W. and Maine, Richard E., Practical Aspects of Using a Maximum Likelihood Estimation Method to Extract Stability and Control Derivatives from Flight Data. NASA TN D-7831, 1975.

⁸Tinoco, E. N. and Mercer, J. E., FLEXTAB - A Summary of the Functions and Capabilities of the NASA Flexible Airplane Analysis Computer System. NASA CR-2564, 1974.

⁹Reynolds, P. A., et al., Capability of the Total In-Flight Simulator. AFFDL-TR-72-39 and Calspan Report TB-3020-F-4, July 1972.

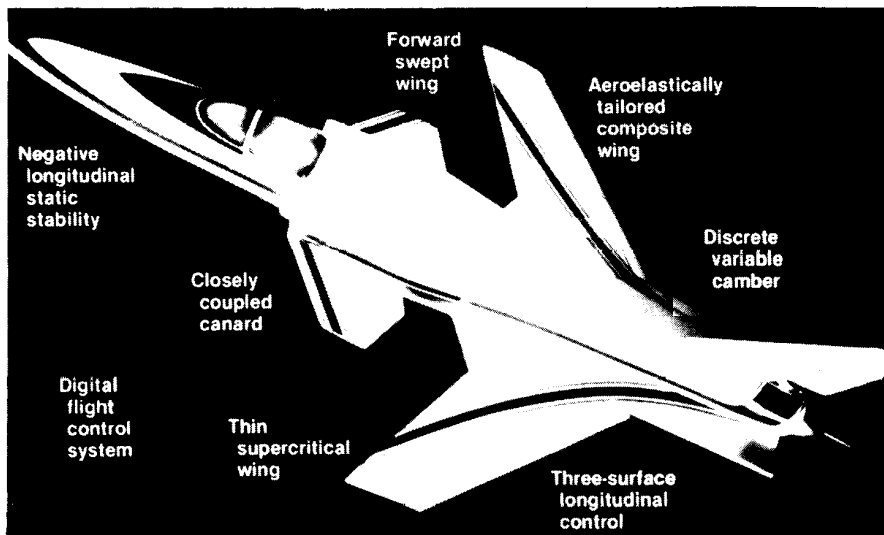

DFRF 83-410

Fig. 1 X-29A aircraft with advanced technologies.

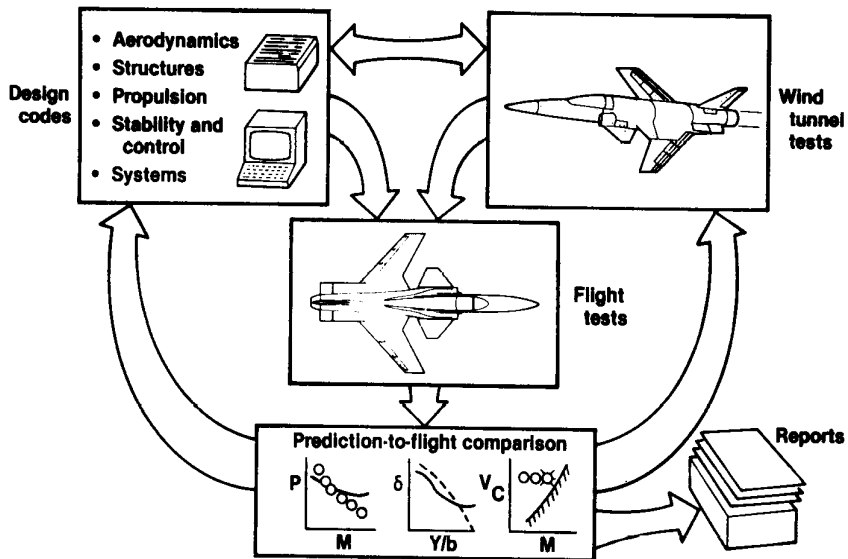

Fig. 2 Design method validation process.

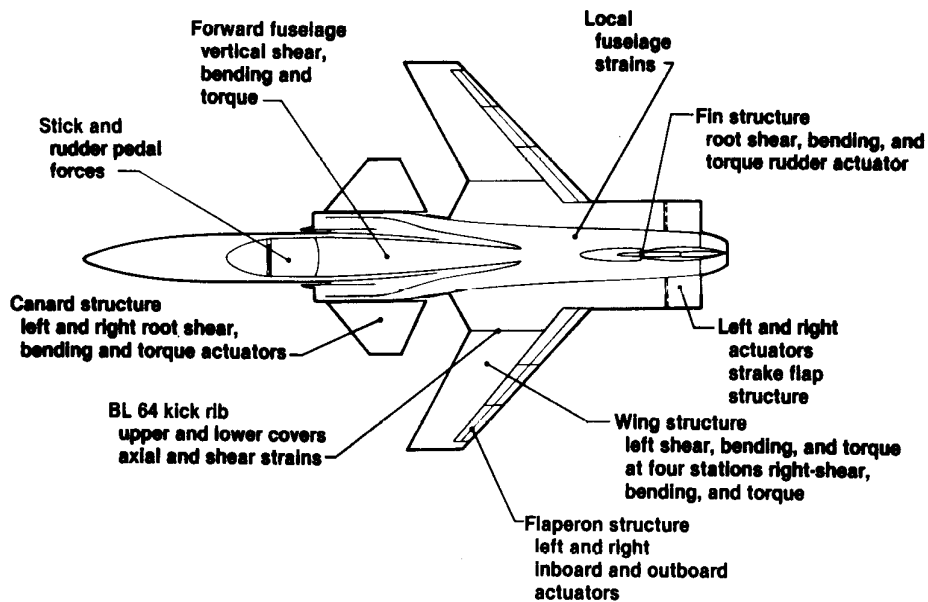

Fig. 3 Structural measurements and locations.

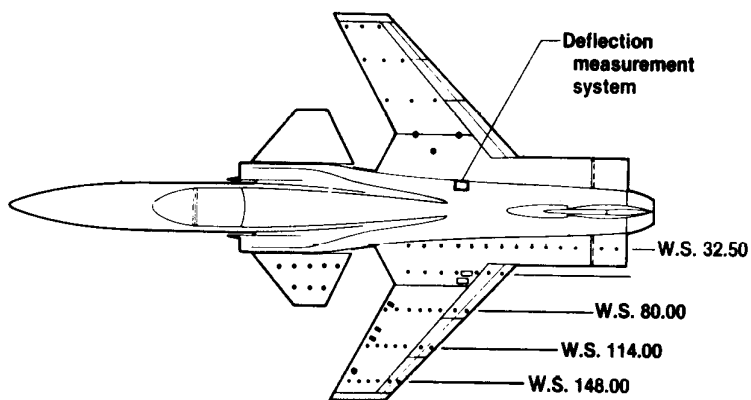

Fig. 4 Location of pressure instrumentation and optical deflection measurement system.

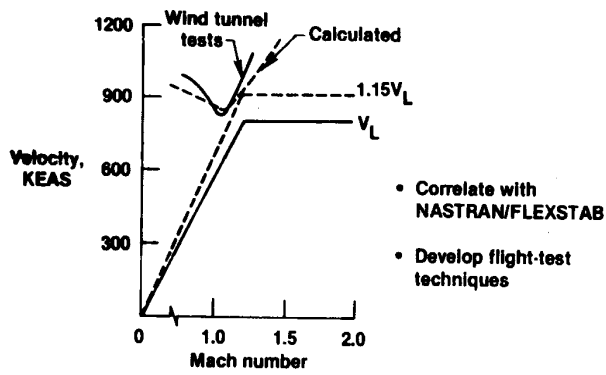

Fig. 5 Divergence analysis.

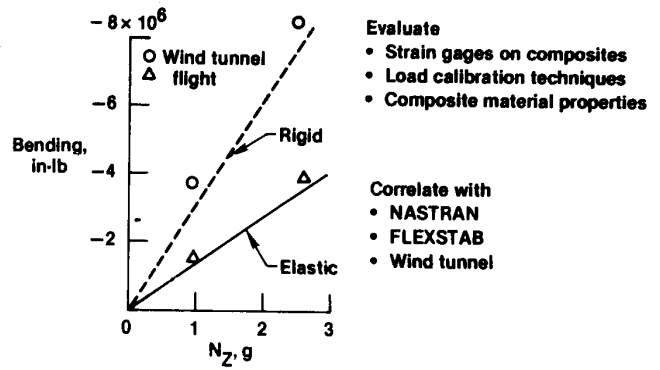

Fig. 6 Loads analysis.

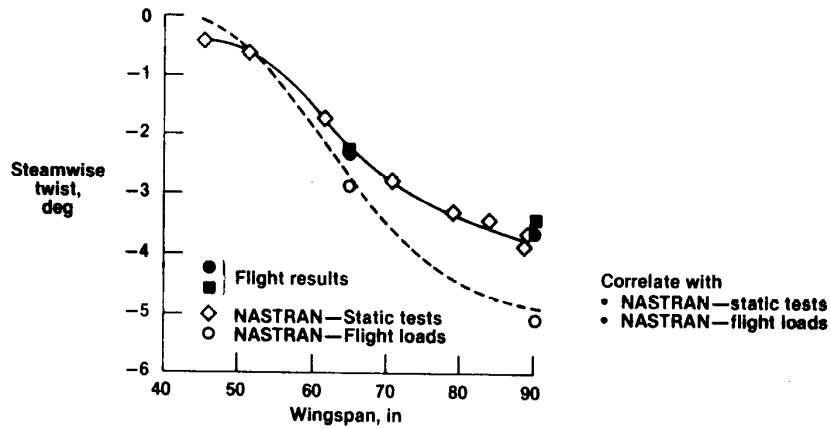

Fig. 7 Aeroelasticity correlations.

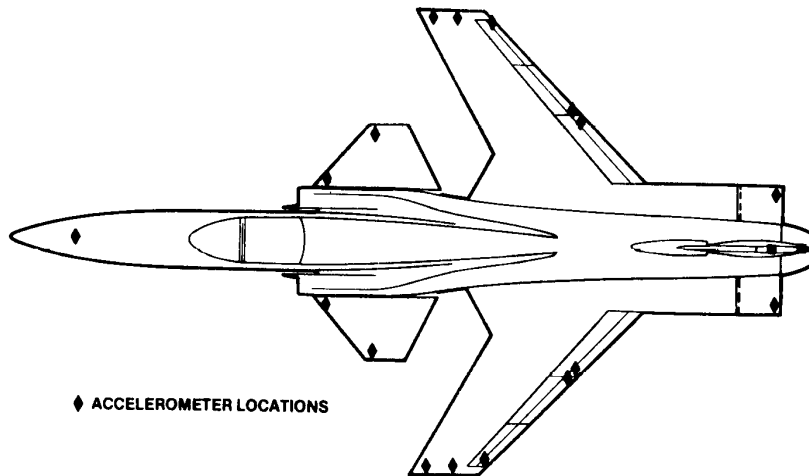

Fig. 8 Instrumentation accelerometer locations.

- Correlate with
- TDT test results
 - Analyses

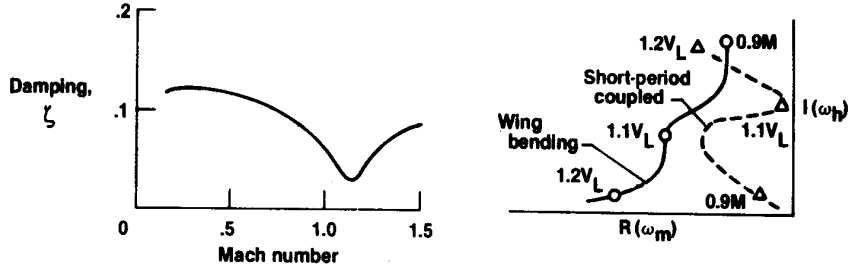

Fig. 9 Structural dynamics analyses.

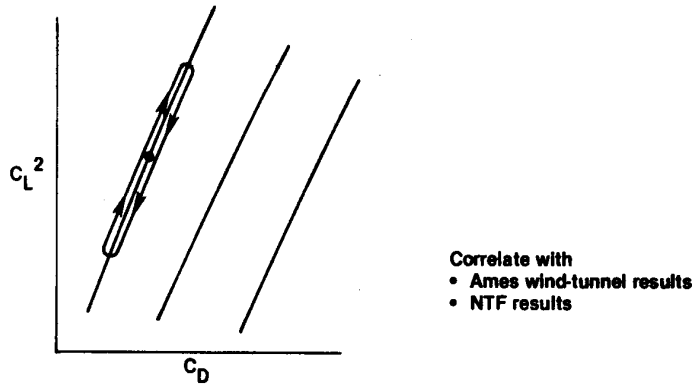

Fig. 10 Performance measurements.

- Correlate with
- Wind tunnel
 - Simulations

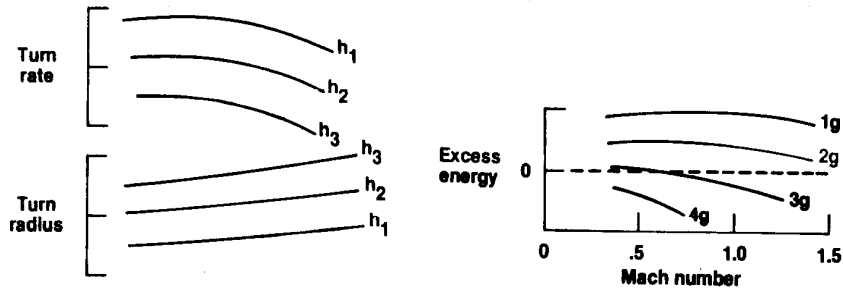

Fig. 11 Performance analyses.

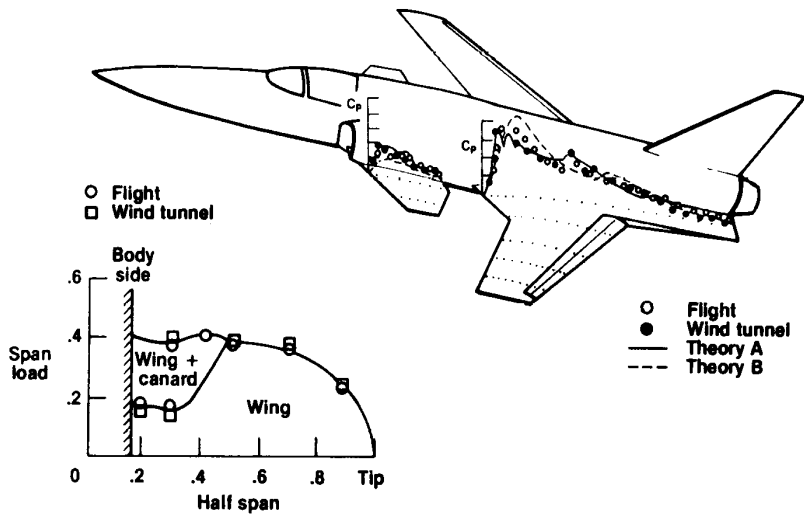

Fig. 12 Pressure distributions and analysis.

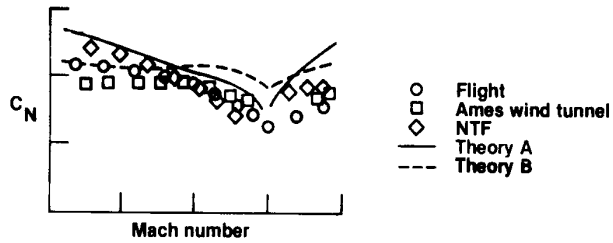

Fig. 13 Buffet analysis at buffet onset.

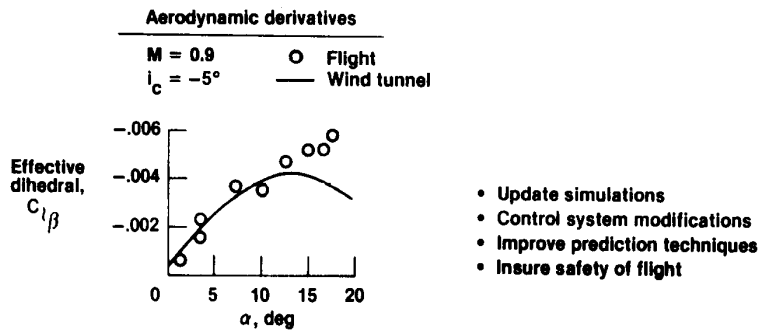
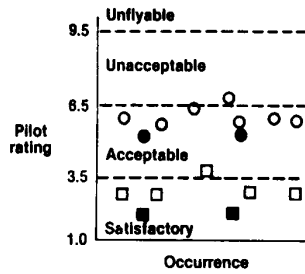

Fig. 14 Stability and control analyses.

○ Initial control laws
 □ Revised control laws
 Solid symbols denote simulation



- Evaluate effect of
 - High-authority, rapid-rate canard
 - High-gain closed-loop task
- Compare to MIL 8785C
- Study establishment of new criteria

Fig. 15 Flying-qualities assessments.

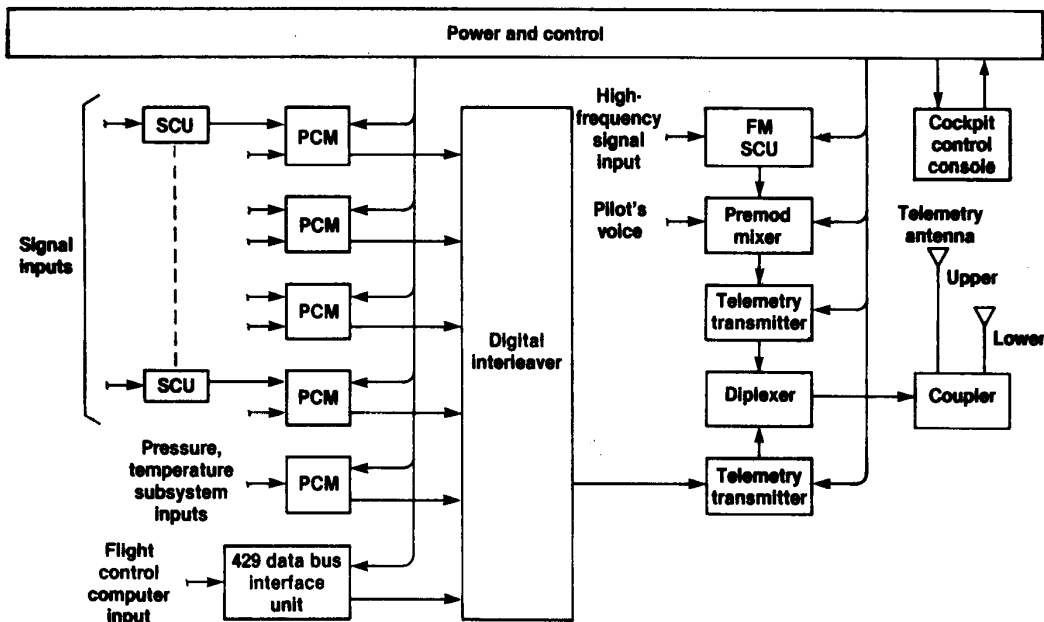

Fig. 16 Instrumentation system elements.

Basic parameters

- Air data (9)
- Angles of attack and sideslip (4)
- Pitch, roll, and yaw attitudes, rates, and accelerations (10)
- c.g. accelerations (8)
- Engine speed, temperature, pressure and nozzle positions (21)
- Surface positions (9)

Flight-control system

- Computer parameters (429 bus) (64)
- Stick, rudder pedal position and forces (6)
- Cockpit accelerations (2)

Flutter and buffet

- Accelerometers (23)
- Velocities (4)
- Flap tab shaker (3)

Structures

- Strain gages (112)
- Optical deflection measurement system (12)

Aerodynamic

- Wing/strake static pressure (152)
- Canard static pressures (29)

Miscellaneous

- Hydraulic (9)
- ECS (9)
- Electrical (10)
- Temperature (46)
- EPU (10)
- AMAD (3)
- Vibration (8)

Fig. 17 X-29A measurands.

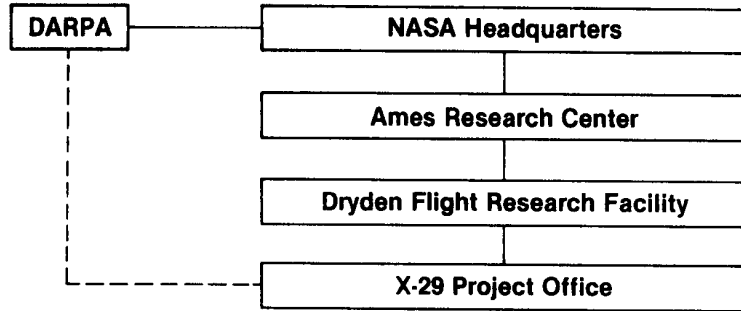

Fig. 18 Management structure.

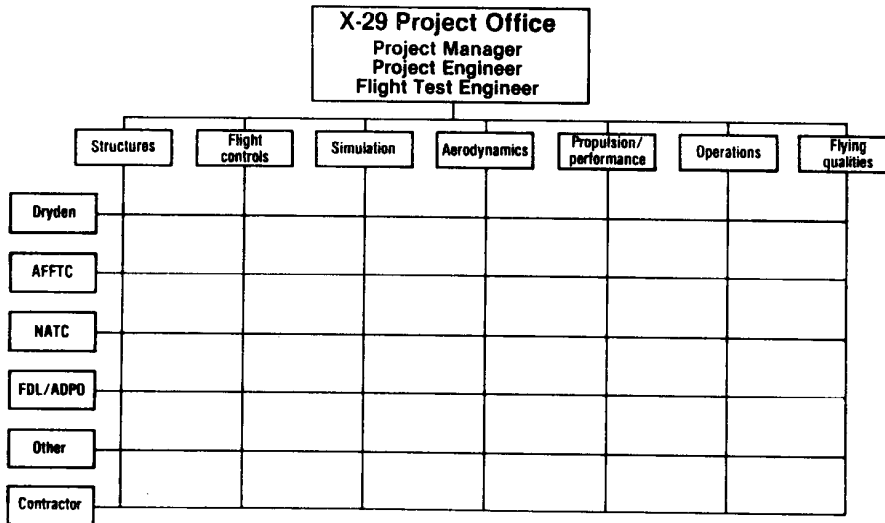

Fig. 19 Matrix management setup.

Test	Test conditions		Objectives	Number of flights	Months after aircraft received														
	Altitude, ft	Max M			Flights per month														
					1	2	3	4	5	6	7	8	9						
Phase A	20,000	0.60	FCF, stability and control, checkout, α/β calibration, and airspeed calibration	2	3	4	4	6	8	8	8	8	8						
	30,000	0.60	FCF as above	2		4	4												
	40,000	0.60	Flight control expansion, FCF, stability and control	1			4												
	40,000	0.95	Stability and control, loads, flutter, divergence	3				6											
	30,000	0.95	Stability and control, loads, flutter, divergence	3					8										
	40,000	0.95	Airspeed calibration	1						8									
	40,000	1.20	Stability and control, loads, flutter, divergence	2							8								
	30,000	1.20	Stability and control, loads, flutter, divergence	2								8							
	30,000	1.20	Airspeed calibration	1									8						
	30,000	1.20	Performance	4										8					
	30,000	0.95	Flying qualities	3											8				
	20,000	0.95	Stability and control, loads, flutter, divergence	3												8			
	10,000	0.80	Stability and control, loads, flutter, divergence	2													8		
	10,000	0.80	Performance/flying quality	3														8	
	30,000/40,000	1.20	Flying qualities	4															8
			Subtotal	36															
Navy evaluation	Within above			4														8	
Phase B	40,000	Max	Stability and control, loads, flutter, divergence	4														8	
	30,000	Max	Stability and control, loads, flutter, divergence	4														8	
	20,000	Max	Stability and control, loads, flutter, divergence	4														8	
	10,000	Max	Stability and control, loads, flutter, divergence	3														8	
	50,000	Max	Flying qualities	2														8	
		Total flights	57																

Fig. 20 X-29 envelope expansion: phase A and B.

Test conditions		Objectives	Number of flights	Months after completion of phases A and B															
Altitude, ft	Max M			Flights per month															
				1	2	3	4	5	6	7	8	9	10						
—	—	Instrumentation downtime	—	0	0	0	8	8	8	8	8	8	8	2					
40,000	Up to 0.95	Pressure distributions	3																
30,000	Up to 0.95	Pressure distributions	3																
40,000	Up to 0.95	Performance	3																
30,000	Up to 0.95	Performance	3																
20,000	Up to 0.95	Performance	2																
10,000	Up to 0.95	Performance	2																
50,000	Up to max	Flying qualities stability and control	12																
40,000	Up to max	Pressure distribution	3																
30,000	Up to max	Pressure distribution	3																
20,000	Up to max	Pressure distribution	3																
50,000	Up to max	Performance	2																
40,000	Up to max	Performance	3																
30,000	Up to max	Performance	3																
20,000	Up to max	Performance	3																
10,000	Up to max	Performance	2																
			50																

Fig. 21 X-29 research phase C.

1. Report No. NASA TM-86025	2. Government Accession No.	3. Recipient's Catalog No.	
4. Title and Subtitle X-29 FLIGHT-RESEARCH PROGRAM		5. Report Date January 1984	
		6. Performing Organization Code	
7. Author(s) Terrill W. Putnam		8. Performing Organization Report No. H-1199	
9. Performing Organization Name and Address NASA Ames Research Center Dryden Flight Research Facility P.O. Box 273 Edwards, CA 93523		10. Work Unit No.	
		11. Contract or Grant No.	
12. Sponsoring Agency Name and Address National Aeronautics and Space Administration Washington, D.C. 20546		13. Type of Report and Period Covered Technical Memorandum	
		14. Sponsoring Agency Code RTOP 533-02-81	
15. Supplementary Notes This paper was presented at the AIAA 2nd Flight Test Conference, Las Vegas, Nevada, November 16-18, 1983.			
16. Abstract The X 29A aircraft is the first manned, experimental high-performance aircraft to be fabricated and flown in many years. The approach for expanding the X-29 flight envelope and collecting research data is described including the methods for monitoring wing divergence, flutter, and aeroservo-elastic coupling of the aerodynamic forces with the structure and the flight-control system. Examples of the type of flight data to be acquired are presented along with types of aircraft maneuvers that will be flown. A brief description of the program management structure is also presented and the program schedule is discussed.			
17. Key Words (Suggested by Author(s)) Experimental aircraft Advanced technology Flight research		18. Distribution Statement Unclassified-Unlimited STAR category 05	
19. Security Classif. (of this report) Unclassified	20. Security Classif. (of this page) Unclassified	21. No. of Pages 13	22. Price* A02

*For sale by the National Technical Information Service, Springfield, Virginia 22161.